

Low-Cost Technology Options for Sanitation

A State-of-the-Art Review and Annotated Bibliography

Witold Rybczynski, Chongrak Polprasert, and Michael McGarry

0 2 2

7 8 L O

022-5812

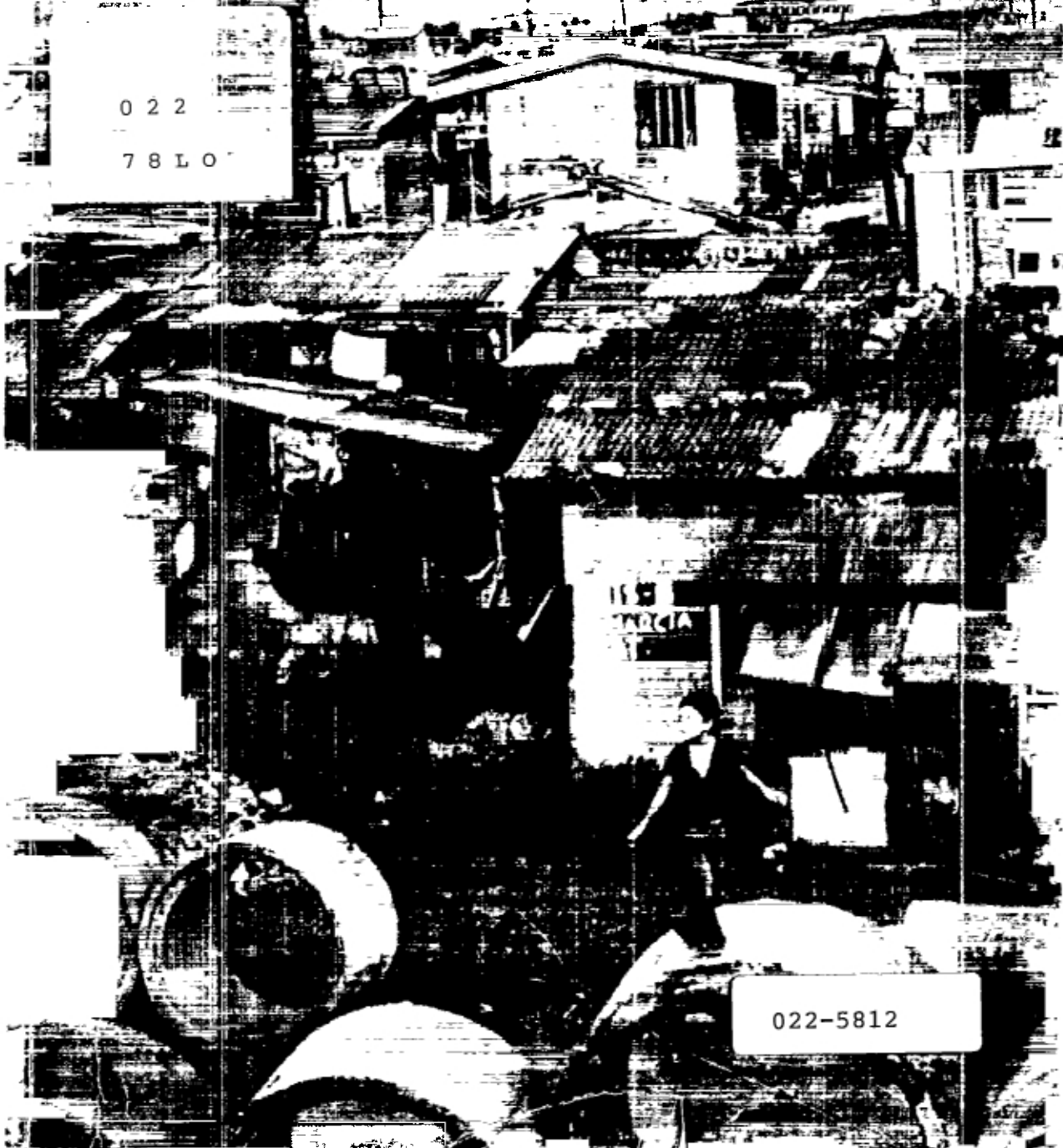

The International Development Research Centre is a public corporation created by the Parliament of Canada in 1970 to support research designed to adapt science and technology to the needs of developing countries. The Centre's activity is concentrated in five sectors: agriculture, food and nutrition sciences; health sciences; information sciences; publications; and social sciences. IDRC is financed solely by the Government of Canada; its policies, however, are set by an international Board of Governors. The Centre's headquarters are in Ottawa, Canada. Regional offices are located in Africa, Asia, Latin America, and the Middle East.

©1978 International Development Research Centre
Postal Address: Box 8500, Ottawa, Canada K1G 3H9
Head Office: 60 Queen Street, Ottawa

Rybczynski, W.
Polprasert, C.
McGarry, M.

IDRC, Ottawa, Ont. CA

IDRC-102e

Low-cost technology options for sanitation: a state-of-the-art review and annotated bibliography. Ottawa, Ont., IDRC, 1978. 184p.

/ IDRC publication / . Review and annotated / bibliography / on the / technical aspect / s of / sanitation / , / water treatment / and reuse, and / waste disposal / in / developing country / s.

UDC: 016:628

ISBN: 0-88936-155-X

Microfiche edition available

ISBN 5812 424

IDRC-102e

022
78 LO

Low-Cost Technology Options for Sanitation

**A state-of-the-art review
and annotated bibliography**

Witold Rybczynski, Chongrak Polprasert, and Michael McGarry

LIBRARY IRC
PO Box 93190, 2509 AD THE HAGUE
Tel.: +31 70 30 689 80
Fax: +31 70 35 899 64
BARCODE: 5812
LO: 022 78 LO

LIBRARY
International Reference Centre
for Community Water Supply

*This publication is the result of a joint effort by the International Development
Research Centre and the World Bank.*

Contents

Foreword	3
Preface	5
Part I	
Choosing Waste-Disposal Technologies	7
Options for Excreta Disposal in Hot Climates	12
Techniques for Reusing Human Wastes	23
Waste Disposal / Reuse Options for Cities and Towns	31
Part II	
State of the Literature	40
Part III	
Subject Scope and Contents of Bibliography	47
Bibliography	48
1. Deposition devices	48
2. On-site collection and treatment	51
2.1 Pit latrine	51
2.2 Composting privy	62
2.3 Septic tank and aqua-privy	71
3. Collection and off-site treatment	83
3.1 Cartage	90
3.2 Waterborne	95
3.3 Ponds	103
3.4 Composting	113
3.5 Aquatic weeds	118
4. Reuse	121
4.1 Irrigation	121
4.2 Aquaculture	133
4.3 Algae	139
4.4 Fertilization	143
4.5 Biogas	146
5. Greywater	153
6. Water saving	157
Keyword Index	164
Author Index	173
Authors' Corporate Affiliation Index	179
Glossary	183

Foreword

Foul water may well rate as the greatest single source of human disease and misery. It is, therefore, encouraging to see it moving towards the head of the world's priority list of basic needs. Habitat, the United Nation's Conference on Human Settlements, proposed that all nations should seek to extend clean water and sanitation to their people by 1990. The United Nations Conference on Water endorsed this proposal. The U.N. General Assembly has officially espoused this policy and the 1980s have become the International Drinking Water and Sanitation decade.

However, the emphasis on "clean water" carries with it a risk. It can allow policymakers to neglect the equally urgent need for sanitation. Supplying water to villages or squatter settlements can have more direct political appeal. It is also usually cheaper and easier to install and maintain. But, without basic sanitation (and the kind of health care that instructs the community in personal hygiene), the full benefit of "clean water" will not be achieved. The investment will have been made, the money spent. But disease will continue. Moreover, conventional "Western" methods of waterborne sewerage are simply beyond the reach of most communities. They are far too expensive. And they often demand a level of water use that local water resources cannot supply. If Western standards were made the norm, some \$200 billion alone would have to be invested in sewerage to achieve the target of basic sanitation for all. Resources on this scale are simply not in sight.

So, do we face a painful dilemma — the desperate need for "clean water," the impossibility of getting a needed base for it in sanitation? Happily, there exists a wide range of effective alternatives between the unhygienic pit privy and the Western waterborne sewerage system. These systems are generally far cheaper. Most of them do not demand a heavy use of water. And many make creative use of the nutrients in human waste to fertilize fields and fish ponds or to contribute to biogas production — and they can do this without serious risk of returning pathogens to human food or drinking water. The chief problem is that these alternatives are not widely known to the policymakers and engineers in charge of sewage and sanitation programs. To begin to break down this wall of ignorance, the World Bank in 1976 launched a worldwide search to identify the various immediate technologies between the most primitive and Western sewerage systems. The IDRC collaborated in this search and has compiled a short, concise, and very informative technology review for policymakers to which it has added a very extensive bibliography. This is another step in IDRC's much expanded program in the area of water and sanitation and for countless millions of suffering human beings, it may also prove a first step to better health.

Barbara Ward
President
International Institute for
Environment and Development

Preface

This comprehensive technology review and bibliography describes alternative approaches to collection, treatment, reuse, and disposal of human wastes.¹ It is designed to describe to the policymaker, the administrator, and the engineer the broad range of approaches to human wastes management available today. This document forms part of an informal series of publications resulting from research and demonstration activities supported through the International Development Research Centre's and the World Bank's research funding programs in water supply and sanitation.

This study was based upon an extensive search of the published and unpublished literature. Relevant documents were undoubtedly missed, and because of printing schedules late acquisitions could not be included in the publication. Over 20 000 references were considered and approximately 1200 documents reviewed. As a result, 531 documents were selected for abstracting and were used to produce the bibliography. Emphasis has been placed on technological issues, but institutional, behavioural, and health-related aspects of excreta disposal were also considered.

This review and bibliography can stand alone but its usefulness is limited if the documents and the knowledge upon which it is based are not made easily accessible. In response to the ever-increasing demand for information in this field, the Asian Institute of Technology (AIT) in Bangkok, Thailand, is in the process of creating an International Rural Sanitation Information Centre to become operational in late 1978. Relevant material collected for this study will form the initial information base for the new information centre; documents appearing in this publication will therefore be available from AIT on request in early 1979. It is also likely that regional focal points for the collection and dissemination of relevant information materials in the field of environmental sanitation will be established, thus forming the basis for the continued exchange of information between regions.

Special thanks are due to Marcel Mercier, Senior Program Officer, Information Sciences Division, IDRC, who monitored the literature search and the preparation of the bibliography; to John Kalbarmatten, Water and Wastes Advisor for the World Bank; and to Charles Gunnerson, Consultant to the World Bank. We would also like to thank the many people and institutions who have contributed to the preparation of this review, in particular the following: Eric Carlsson, Royal Institute of Technology, Stockholm; Balfour Hepher of the Agricultural Research Institute, Israel; Duncan Mara, The University, Dundee, Scotland; Alexander Morse, Washington, D.C.; M. B. Pescod, University of Newcastle-upon-Tyne, U.K.; John Pickford, University

¹A companion volume to this bibliography, entitled *Health Aspects of Excreta and Sullage Management* by R. G. Feachem, D. J. Bradley, H. Garelick, and D. D. Mara is available from the Energy, Water and Telecommunications Department of the World Bank, 1818 'H' Street, N.W., Washington, D.C. 20433, USA.

of Technology, Loughborough, U.K.; David Donaldson, Pan American Health Organization, Washington; Hemda Garelick, Ross Institute of Tropical Hygiene, London; Edwin Lee, World Health Organization, Manila; H. F. Ludwig; B. F. Ormieres, Bureau central d'études pour les équipements d'outre mer, Paris; Somnuek Unakul, World Health Organization, New Delhi; and Victor Wehman of U.S. AID, Washington.

Helpful suggestions were made by Richard Feachem of the Ross Institute of Tropical Hygiene, who is preparing a parallel bibliography on health aspects of wastes disposal. We owe special gratitude to the many people who spent valuable time reviewing and making comments on the draft manuscript and to Vikram Bhatt for incorporating their comments into the final version. The literature search could not have been completed without the support of the staff of the IDRC Library, particularly that of Margaret Carroll; and thanks are also due to Dolores Rees of the NOAA Library in Washington and Rafael Rodriguez of the World Bank.

Witold Rybczynski
Chongrak Polprasert
and
Michael McGarry

Part I

Choosing Waste-Disposal Technologies

“There are some sections of the city where rural sanitation conditions obtain, as, for instance, the areas not reached by sewers. The lack of sewers may be due to any of several reasons, as scarcity of money for sewer extensions, inability to extend sewers due to adverse conditions of nature, or legal limitations, as where a community is contiguous to, but just outside of the city limits. In these sections there is a complication of problems, but the essential requirement remains the same. It is necessary to dispose of the dangerous wastes in a sanitary manner.

Few of these homes are reached by water mains, or have their own water supplies under pressure. Fewer still are financially able to install plumbing fixtures and build a plant to care for the sewage resulting from the installation. For the great majority the privy will be the method of sewage disposal.” (Hardenbergh 2112)

This could very well be a description of the situation that exists in many of the developing countries of the world, but in fact it was written by an American sanitary engineer in 1924, and describes conditions in the United States at that time. If the United States, which introduced sewerage 75 years before, was still having difficulties with conventional sewerage in 1924 it is not surprising that many countries that are now beginning the process of development should be faced with similar problems. But such comparisons can be misleading. They imply that similar problems require similar solutions. They ignore the fact that, as Gunnar Myrdal has pointed out, the developing countries begin their modern development with significantly different resources and under different conditions than did the now-developed countries when they began their modern development in the mid-19th century. Developing countries today cannot simply repeat the development process of the developed countries, and nowhere is this more clear than in technological development.

The recognition that the developing countries may follow a different route leads one, in the consideration of waste disposal, to pose three questions. What were the options available in the mid-19th century to these countries then beginning their modern development? To what extent is the situation of a developing country today similar? Is the option that was adopted *then* by the developed countries still the optimal solution for the countries beginning their development today?

The European and American countries in the mid-19th century found themselves with rapidly growing cities and traditional sanitation systems (cesspools, bucket systems, pit latrines, and open ditches) that were rapidly becoming inadequate to the new scale and density of population. The first evidence of difficulties appeared in the water supply, which in most cities at that time was provided by individual wells. As the density of the urban areas

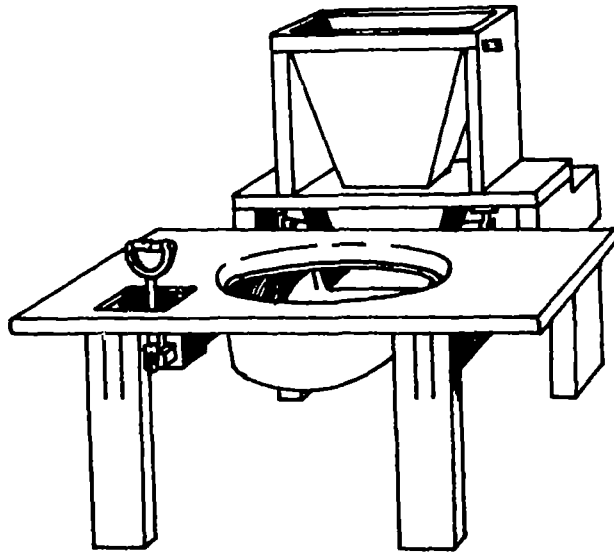

Moule's earth closet, 1860.

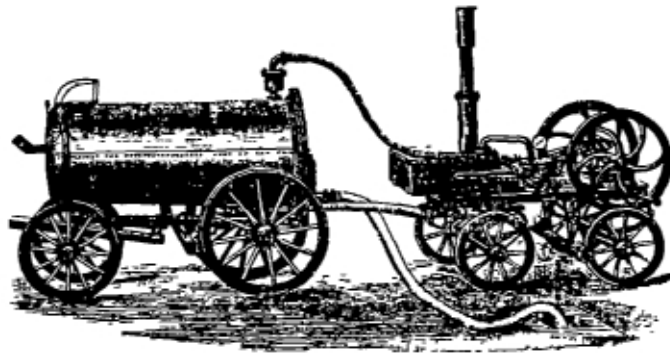

Vacuum truck, 1880.

increased, local water supplies became contaminated and depleted, and virtually all the major cities were forced to build aqueducts to supply the city with clean water from the unpolluted hinterland. This supply of piped water resulted in greater consumption and required disposal of greater amounts of wastewater. At the same time the availability of pressurized water in the home encouraged the widespread adoption of a recent invention — the water closet, the forerunner of today's flush toilet. This self-cleansing water-sealed device was seen as the ideal solution for isolating the odiferous cesspool, and permitted hygienic indoor toilets for the first time. However, the result of this massive input of wastewater into primitive infiltration systems was to be the straw that broke the camel's back (Stanbridge 1012; Tarr 3240). It rapidly became clear that the traditional systems could not deal with such quantities of water, and recurring outbreaks of cholera required that an alternative solution be found.

One option that was considered was the transport of wastewater away from the cesspool by the use of horse-drawn tank trucks. The sewage was pumped into the tank manually. This approach, the predecessor of the vacuum truck, was tried in a number of American cities. Its reported failure was due to the inability of the municipal governments of that time to organize and operate such a service effectively. Nevertheless certain better organized European cities, such as Stockholm and Copenhagen, did use bucket removal systems well into the 20th century.

The option of total or partial biological on-site treatment of wastewater was not really available in the mid-19th century when the commitment to sewers was made. The septic tank was not invented until 1897, by a British engineer Donald Cameron. A simplified version called the "septic closet" was developed by Drs Lumsden, Roberts, and Stiles in the United States in 1918 and was widely used in the rural South. It was later adapted and adopted in Africa and Asia, where it is known as the "aqua-privy."

There had been investigations in the early 19th century of dry excreta-disposal systems. Moule in England and Waring in the United States were both proponents of the "earth closet." One of the limitations on the success of these systems was the limited understanding of scientific composting at the time. Composting was brought to the West from China in 1909 by King of the United States Department of Agriculture, and the work of the pioneer Sir Albert Howard at Indore was not completed until the 1930s (Gray et al. 3407). These developments were too late to influence the course of events, as the widespread adoption of the water closet had effectively cancelled the dry-disposal option. The solution that was finally adopted, as is well known, was the removal of combined greywater and human excreta by underground sewers.

The problem of waste disposal, as it was then understood, was essentially one of transporting the wastewater out of the urban area and underground sewers did this successfully, albeit at a high price. This choice represented the most easily implementable solution, and by translating a sociomedical problem into an engineering task it followed the characteristic philosophy of that optimistic age. Once this decision was made it set the direction for technological development for a century to come. The problems of biological oxygen demand (BOD) reduction, contaminant removal, tertiary treatment, and sludge disposal all follow, though unpredicted, the first choice.

It is possible for a developing country to take into account at least some of the implications of the waterborne waste-disposal option that were not

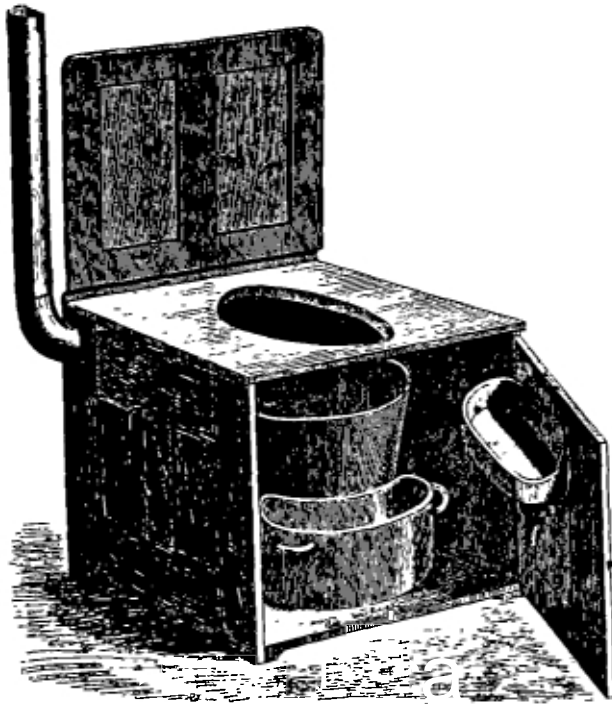

The Marino Toilet, 1858, Copenhagen.

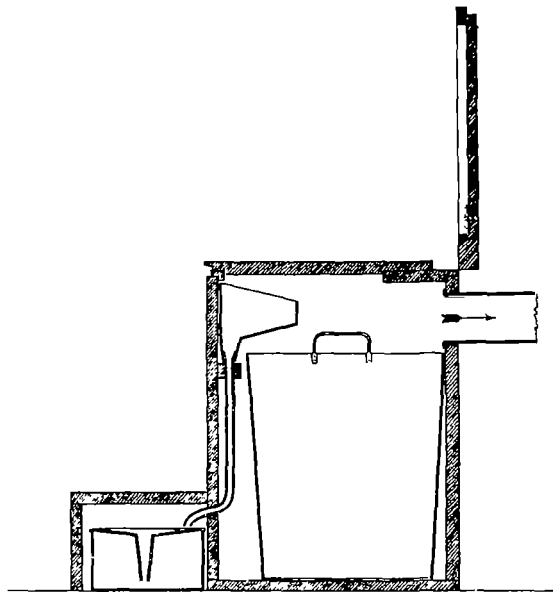

Chamber pot version of Marino's toilet.

discerned in the mid-19th century. The associated environmental hazards and increased water consumption are two phenomena that are now well documented. In this sense being a latecomer has its advantages. However, a general consideration of the conditions within which the developing countries face the problem of waste disposal will show that the situation is extremely severe, and differs vastly from that faced by the Western countries in the 1850s.

The population explosion is a formidable obstacle to development for a number of developing countries. This is evidenced by the overall man / land ratio, which is much higher than in Europe at the time of its industrial revolution, and in the extremely rapid growth of the urban areas. At the time that the decision was made to adopt underground sewers, London had slightly over 2 million people. All the other cities that initiated sewer construction (Hamburg, Paris, and New York) had less than 1 million inhabitants. Even by 1900 there were only 11 cities in the world (nine of these in America and Europe) with populations of over 1 million. Today that is considered a small city indeed. Most of the primary cities in Asia surpass 5 million inhabitants. Clearly the scale of the waste-disposal problem faced by a developing country is of unprecedented proportions, and no parallel is possible between their situation and that of the developed countries 100 years ago.

In all but a few exceptional cases the developing countries are less well endowed with natural resources than were the presently developed countries when they started development. For a number of developing countries one particularly scarce resource is "clean" water. Water is plentiful in the temperate zones, where sewers were first constructed, and it is not surprising to find it used as the transportation medium for human wastes. Many developing countries, being in the tropical and subtropical regions, find themselves with periodic, or permanent, shortages of water, both for agricultural and domestic uses. This is a most severe constraint for the adoption of any waterborne system.

Climate is another important difference in the conditions under which many developing countries are developing. The number and variety of fecally transmitted diseases is greater in the tropical and subtropical regions. Heat and humidity create ideal conditions for pathogen survival. Furthermore, the malnutrition that is endemic with much of the population is a major factor in the high rate of infection. The result is that poor sanitation becomes one of the chief causes for spread of hookworm, diarrhea, enteritis, cholera, and typhoid. The destruction of these pathogens is the first priority of any tropical waste-disposal system. Most systems originating in the temperate regions emphasize achieving BOD reduction and are less concerned with pathogen destruction.

Before the adoption of sewers in the West, night soil was collected from the cities, either by bucket systems or by pumping out cesspools, and was used by farmers as fertilizer (Stanbridge 1012). Once the water closet came into use, the transportation and handling of liquid sewage proved difficult, and the amounts of water mixed with the waste proved to be too much for farming use. This, as well as the development of manufactured fertilizers, discouraged the practice of reusing wastes. In most of the less developed countries agriculture plays a very important role in the development process. The limited availability and high cost of chemical fertilizers mean that compost, manure, and human waste have retained their value as fertilizing materials. The problem of waste

disposal, for a developing country, cannot be separated from the problem of waste reuse.

The adoption of waterborne waste-disposal sewers in the cities and septic tanks in the rural areas has taken the developed countries quite a long time. Indoor sanitation for almost all rural Canadian housing was achieved only 10 years ago. The pressures of population and the requirements for improved health in a developing country will require a much more rapid implementation of effective waste disposal than took place in the developed countries and on a much larger scale. It is unlikely that the systems that were appropriate to the rather small populations of the resource-wealthy industrialized countries of northern Europe in the 19th century will be successful in solving the formidable problems of a much poorer, and much more populous, developing country. A World Health Organization survey published in 1976 (3220) indicates that whereas in 1970, 27% of the urban population in developing countries had sewerage connections, in 1975 this figure had actually *declined* to 25%. Even more serious is the fact that another 25% has no access to any sanitary facility at all. It would not be an exaggeration to say that for many of the developing countries a crisis in terms of lack of adequate sanitation has been reached.

The question remains, what are the options currently available to a developing country with regard to waste disposal?

The systematic study of waste disposal is recent, and it would be premature to present it as a science. There are branches in which much pragmatic engineering knowledge exists, such as the design of sewer networks and treatment plants. Recently much scientific study has taken place on the reclamation of sewage effluents for irrigation and agriculture. On the other hand, the most widely used method of disposal, the pit latrine, has been studied very little, and, particularly in the rural areas, is based on a combination of rules-of-thumb and folk tradition. A technology review of waste disposal finds itself dealing alternatively with craft, engineering, and science, and a scientific classification of this material would be misleading.

This study is based on an exhaustive examination of technical literature from developing and developed countries. This literature is presented in abstracted form in the bibliography that follows. However, it was felt that this review should go further than a mere summary or checklist and should address itself to three key questions that permeate any discussion of appropriate waste disposal for developing regions.

- (1) What are the options for excreta disposal in hot climates?
- (2) What are the techniques for reusing human waste?
- (3) In view of the above, what are the waste-disposal / reuse options for cities and towns?

Options for Excreta Disposal in Hot Climates

It has already been pointed out that one of the major differences between conditions in a developing country today and those in the industrial countries

in the mid-19th century is the fact that, whereas sewers were a solution to a wastewater problem, only 13% of the population of the developing countries actually has piped water in-house connections (3220). This means that, for the moment at least, the main problem of the majority of the population, which is not served by piped water, is not wastewater disposal, but excreta disposal.

The distinction between sewage (or wastewater) and excreta is critical. Too often the emphasis has been put on “sewage treatment for developing countries,” in spite of the fact that only 6.5% of the population of developing countries are connected to sewers. A search for appropriate options must recognize that most of the population produce very small quantities of wastewater, unlike their counterparts in the industrial countries. The technological options differ accordingly.

Pit Latrine

The *pit latrine* remains to date one of the most widely used technologies for excreta disposal in the tropics, though in many developing countries it still takes second place to indiscriminate defecation in the fields. It represents the first rung of the sanitation ladder, but in spite of its apparent simplicity, the adoption of this technology has met with mixed success. A Tanzanian study (Muhondwa 1009) points out that although the peasant’s reluctance to build and use pit latrines is often assumed to be the result of lack of education and restrictive tradition, there are also technical reasons for the failure of many rural latrine programs. Pit latrines were often built, following official direction, in poor soil, with resulting cave-ins. Consequently many people, particularly children, were discouraged from using the latrine, which largely obviated its usefulness. On the whole, there was little reluctance to building the pit latrine in the first place, but in many cases, latrines were abandoned following the departure of the program officials from the village. This had much to do with the smell, flies, and uncleanness associated with pit latrines. The fact is that open-pit latrines, private as well as communal, are often unpleasant and unhealthy places (Shelat and Mansuri 2122).

It should not be concluded from this that pit latrines are an inappropriate technique that is doomed to failure. There is no doubt that the pit latrine remains one of the few technologies affordable by the rural population. However, much work needs to be done to improve the functioning of this “simple” device. A project in Botswana had considerable success with urban pit latrines as a result of improvements such as sturdier construction and reinforcement of the pit, larger pits, and most importantly, ventilation pipes and hole covers (Blackmore et al. 2207). However, the *borehole latrine*, which has a small diameter and can be drilled by a hand auger, has had widespread use because of its adaptability to economic and large-scale implementation. However, it can be an unsatisfactory solution in those cases where the rather deep pit would intercept the water table (Wagner and Lanoix 2125).

Very real health and esthetic problems of many pit latrines are a result of the open nature of the pit, which allows free access to flies and mosquitoes, which in turn can transmit disease over a fairly wide area, and which permits odours to enter the privy enclosure. As the only barrier between the user and the decomposing material, the design of and choice of materials for the squatting plate require close attention.

A simple device from the developing countries that will improve considerably the environmental and hygienic conditions of the pit privy is the *pour-flush latrine*, or *water-seal squatting plate* (1004). A pan at the lower portion of the chute maintains a water seal, and a small quantity of water, usually about 1 litre, is required to "flush" the contents into the pit. The water seal arrests the passage of both flies and odours. It is widely used in Southeast Asia, where it is known as the Chiengmai squatting plate (Wagner and Lanoix 2125). It has been reported that the Chiengmai can become obnoxious, not only as a result of blockage, but also because the simple requirement of manual flushing can so easily be neglected, resulting in a buildup of fecal matter exposed to the air (Morgan 1008).

A recent improvement of the pour-flush water seal has been developed in Rhodesia (Morgan 1008). It consists of a chute and a pan, similar to the Chiengmai, except that the pan is hinged and counterweighted. The weight of the excreta tilts the contents of the pan into the pit, and a simple valve refills the pan with water from a nearby storage tank. The reported water consumption is about 1 litre per visit, and the advantage of the system is the resistance to blockage and the automatic operation, although lack of maintenance of the valve would cause problems.

The form of the Asian pour-flush latrine is the squatting plate, based on the indigenous defecating position. However, there are examples of seat-type pour-flush latrines in other cultures. A Colombian model is specifically designed to improve pit latrines and is hand flushed with 3 litres of water.

One latrine design that attempts to overcome some of the operational drawbacks of the pit latrine, while maintaining a low cost advantage, is the Reid's Odourless Earth Closet (ROEC), developed in South Africa in the 1940s (2101). It consists of an extremely large pit (1 X 2 X 3 metres deep) covered by a concrete slab. The squatting plate, instead of being in the slab, is located to one side and connected to the pit by a sloping chute. A vent pipe is located in the slab, and placed so that air is drawn down the toilet chute and up the pipe. It is important that construction of the pit be airtight. It is reported that not only is the ROEC odourless, but also free from flies, because the darker environment of the pit discourages breeding (Blackmore et al. 2207).

One of the factors that may explain the success of the ROEC is the large volume of the pit, which gives greater surface area for infiltration and extends the life of the pit (reportedly up to 20 years). Experiments are now being carried out in Tanzania with watertight lined pits, in effect, composting toilets, which would have to be emptied at long intervals (Eyelaar 2210; Winblad 2232).

The "dry" pit privy, which receives only feces and urine, can become "wet" through the addition of water used for (1) anal cleansing or from squatter plate washings entering the pit, or (2) by the pit being dug below the groundwater table. The two major disadvantages of wet pits are the increase in fly and mosquito breeding caused by excessive water in the pit and the possibility of infiltration of contaminated water into the surrounding soil. Early research on pit latrines in the U.S. (Caldwell 2108) showed that the presence of water significantly increased the distance that coliform organisms traveled, up to 10 m from the pit. In contrast, coliforms from a dry pit in sandy soil contaminated a distance around the pit of only 30 cm. On the other hand, increased moisture in the wet pit enhances decomposition of the excreta. Digestion of solids is more rapid and more complete in wet pits, which

increases the life of the pit privy by a factor of almost two (Wagner and Lanoix 2125).

When designing the pit privy, consideration must be taken of such factors as water-use practices, subsoil characteristics, population densities, and location of the nearest dug-well water supply. Trade-offs between reduced storage volume of the wet pit have to be made against its potential for contaminating the groundwater supplied. Water supply pipes can also be contaminated by polluted groundwater near pit privies where water pressures fall below zero, as is common in most developing countries. However, the work of Baars (2107) confirmed the earlier observations of Caldwell (2108) that as the soil around the pit becomes saturated with fine fecal particles and aggregates of colloids and organisms, the flow is retarded through this “filter” and the death rate of fecal organisms increases. This led Wagner and Lanoix (2125) to write that “in homogeneous soils the chance of groundwater pollution is virtually nil if the bottom of the latrine is more than 1.5 metres above the groundwater table.”

Vaults

One method for preventing soil pollution and groundwater contamination is to line the pit with a watertight material, that is, to turn the pit into a vault. At this point there are two alternatives that hinge, once again, on the question of wet versus dry. If no water is added to the vault, or only enough to make the water seal function, the contents may be removed and disposed of elsewhere. When dry the contents are removed by dipper and bucket, when fluid by vacuum truck. These methods are described in the section on Night-Soil Collection (see p.19), and referred to variously as *pail or bucket system*, *conservancy system*, or *vacuum truck and vault*. They clearly qualify as dry excreta-disposal options.

Septic Tanks

The septic tank, which has found very wide application particularly in the United States, consists of a compartmentalized vault within which settlement and some liquefaction of the solids will take place, and a subterranean tile or leaching field where most of the biological treatment of the septic tank effluent occurs. All of the household wastewater goes into the tank in addition to the excreta and flushing water. The costs of septic tank installation, as well as periodic desludging, make them completely inappropriate for the rural population of a developing country. The extensive area required for the infiltration field severely limits their application to urban areas. There are indications that in urban areas septic tanks will often cost more on a per household basis than conventional waterborne sewerage (McGarry 3114).

Aqua-Privies

The aqua-privy is a modified septic tank and was first built by Griffin and Williams in Darjeeling in 1917, an adaptation of the early American cylindrical septic tank (Williams 4407). A vertical drop pipe extends from the toilet bowl or squatting hole to just below the water surface within the tank. The tank is charged with water at the outset, and then water is added in sufficient

quantities to maintain this water seal. Household wastewater (greywater) is not usually disposed of in the aqua-privy. Solids sink to the bottom, and the effluent is carried to a leaching field or soakaway for infiltration into the soil. The tank must be desludged periodically. If not enough water is added to the aqua-privy, the water seal ceases to function and flies and odours enter the house (Wagner and Lanoix 2125). Success with the aqua-privy has been varied. There are positive reports from Nigeria (Oluwande 2331) and the British West Indies (Sebastian and Buchanan 2339), but on the other hand Botswana recently issued a ban on aqua-privies, so odorous had they become (2301). The system has many of the same limitations as the pit latrine with respect to density of implementation and to the requirement for separate disposal of household wastewaters, although at a much higher cost.

Composting Privies

Composting has been defined as “a biological process for converting organic solid wastes into a stable, humus-like product whose chief use is as a soil-conditioner” (Golueke 3416). Composting has long been a traditional method for the recycling of farm wastes, and more recently it has been used for the treatment of night soil and sewage sludge (see Night-Soil Treatment, p. 20). The term “composting privies” refers to household composting systems, which may be either aerobic or anaerobic, and are sometimes referred to as “mouldering toilets,” particularly in the Scandinavian literature. Composting is essentially a dry process and composting privies represent one form of dry vault.

One of the first examples of the dry vault, the *double compartment concrete vault*, originated in the United States in military camps in 1917 (Hardenbergh 2112). It consisted of two watertight compartments large enough to provide storage for the wastes of the average family for 6 months. When one compartment was full it was closed, and the other put into use. It was thought that following the 6-month period a dry, odourless substance free from pathogenic bacteria would result. Unfortunately the principles of composting were elaborated only a decade later. Efficient composting requires an appropriate balance between carbon and nitrogen (C/N). Human excreta does not initially have a favourable C/N ratio and contains excess amounts of nitrogen. To regain the balance, either carbon must be added or nitrogen reduced. The former implies adding cellulose materials such as leaves or grass, the latter implies reducing the urine input. As neither of these things was done in the case of the double compartment concrete vault, the excreta turned septic and liquefied, resulting in strong odours and difficulty in removing the contents. The system was not a success.

The *double-vault latrine* described by Wagner and Lanoix (2125) and also referred to as a compost privy, is similar in appearance to the earlier American version, but its operation differs, being an adaptation of the Bangalore process invented by Howard in the 1930s (Gray et al. 3407). The compartments are larger, and grass clippings, food scraps, leaves, and animal wastes are added to the human excreta. It is claimed that this mixture initially undergoes aerobic composting for a short while followed by anaerobic decomposition for some months.

Although the compost privy is described in a number of the standard monographs on rural sanitation (Wagner and Lanoix 2125) there are no reports of its application on a wide scale until 1956. At this time the

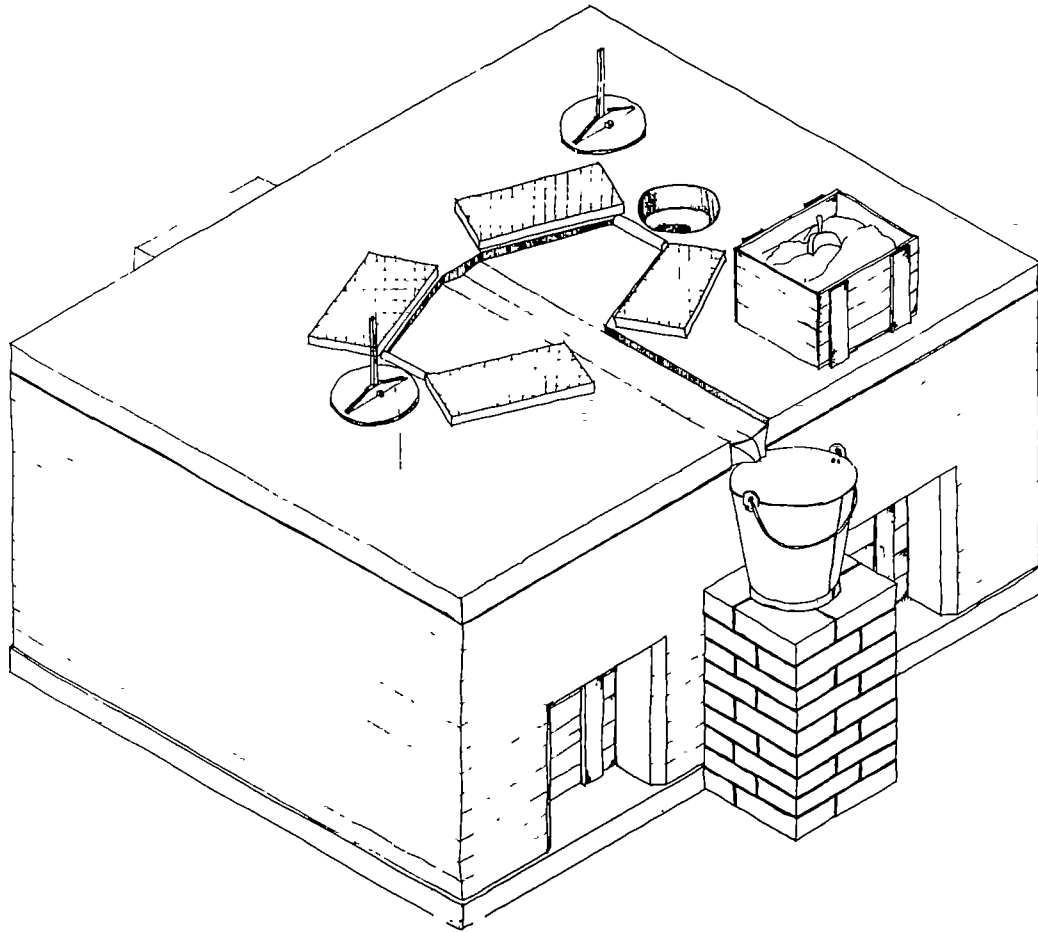

The Vietnamese double vault.

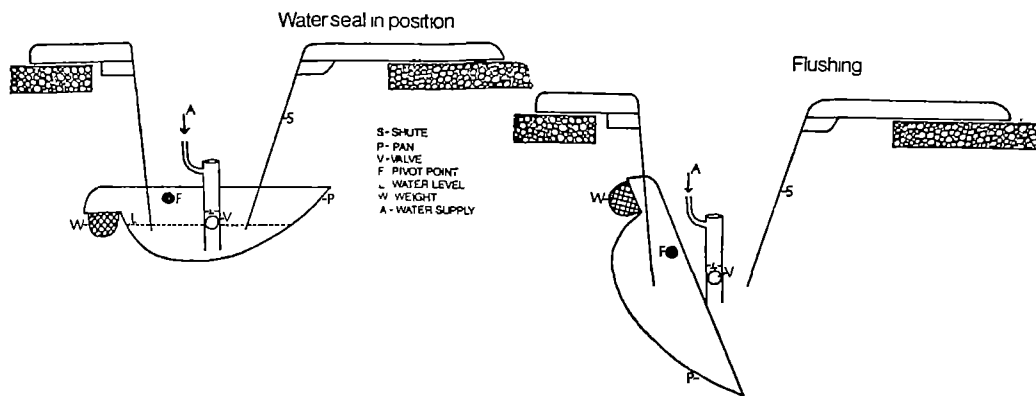

The Watergate flushing pan (from 1008).

Democratic Republic of Vietnam initiated a Five Year Plan of rural hygiene, during which time a very large number of anaerobic composting privies were built.

The *Vietnamese double vault* provides on-the-spot composting of excreta. It has two watertight tanks serving by turns as receptacles for defecation and composting. A hole is made on the face of each, together with a groove to channel urine into a separate vessel, while apertures are made in the back wall for the collection of the waste after composting. The tanks, often paved, are constructed above ground so as not to be submerged by rainwater. Before a tank is used, its bottom must be covered with a layer of powdered earth. After use the feces are covered with kitchen ashes, which absorb moisture and deodorize them. Then the hole is covered with a lid, which is usually fitted with a long handle. When the tank is two-thirds filled its contents are leveled with a stick before it is filled to the brim with dried powdered earth. Then all openings are tightly closed to create an anaerobic space. Anaerobic composting has been practiced for some years in place of the aerobic process (McMichael 2216).

The Vietnamese double vault originated in the 1950s when peasants who were using human excreta as manure found that composting reduced the smell and improved its fertilizer value. This became the key component of a rural sanitation program for disease prevention and increased food production begun in North Vietnam in 1956. After much experimentation it was found that the addition of kitchen ashes effectively neutralized the bad odours normally associated with anaerobic composting, and also effected the destruction of intestinal worm ova — after a 2-month composting period 85% of the ova were found to be destroyed (2202). The anaerobic composting also played an important role in converting organic nitrogen to inorganic forms more readily available to plants.

There are also reports (McMichael 2216) that at present in the Socialist Republic of Vietnam there is one double vault for each 1.4 rural households. The Socialist Republic of Vietnam's experience illustrates that the success of rural sanitation lies in the adoption of waste-reuse systems with obvious benefits to the villager.

Whether the double vault has implications for urban sanitation remains to be seen, although there are reports that it is used in peripheral areas of Hanoi (2202). The advantages of anaerobic composting are: a C/N ratio of 20 to 30:1 is maintained by eliminating the urine (which is used in diluted form for fertilization), and no other organic material need be added to the excreta, hence the vault is quite small — 1.7 m X 1.2 m X 0.7 m high, for 5-10 persons. The essentially dry condition within means that a variety of indigenous materials can be used to build the toilet, which is usually above ground to prevent flooding. Earth, lime mortar, clay, raw bricks, bamboo, concrete or brick are used (2202) as local conditions dictate.

A system has been proposed that is similar to the Vietnamese double vault, but that accepts urine as well (Nimpuno 2219). The C/N ratio is maintained by the addition of organic wastes and the vault is kept dry by providing a perforated bottom. A top layer of coarse sand, underlain by charcoal, crushed limestone, ashes, and leaves, and a bottom layer of coarse sand is placed, which acts as a filter, neutralizing the acidity of the urine, which passes into a soakage pit filled with gravel, below the vaults. Smell is reduced by providing a ventilation pipe. The anaerobic decomposition is allowed to take several months, during which time the adjoining vault is used. No field

data are reported on this system.

The main feature of aerobic, as opposed to anaerobic, composting is that the introduction of oxygen promotes rapid decomposition and generates sufficiently high temperatures of over 50 °C for a long enough time to destroy the pathogens. The most common method of introducing air when composting vegetable or animal wastes is to manually or mechanically turn the pile. As this would expose excreta to the air, it was not considered a suitable method for composting human wastes, and it is for this reason that the early mouldering privies were anaerobic.

The original aerobic household composting system, often referred to as the "*multrum*," was invented by a Swedish engineer (Lindstrom 2213) and put into commercial production in 1964. The multrum consists of a watertight container with a sloping bottom. Human excreta (no flushing water) is introduced at the upper end of the container, and mixes with organic kitchen and garden wastes, which are introduced lower down. Air ducts and a vent pipe are provided to promote aeration, and the decomposed material moves toward the low end, from whence it is periodically removed. The decomposition period is long, up to 4 years, and the container quite large (3 m X 1 m X 1 m high). The main innovations of the multrum are the system of ducts and pipes that evaporate much of the humidity and, like the ROEC, eliminate odours, and the sloping bottom, which permits continuous use of a single container by separating the fresh and the decomposed material.

There are a variety of composting privies on the commercial market, mainly in Sweden (2205) and more recently in Canada and the United States. The possibility of adapting this technology, which had been designed for use by an affluent society in temperate regions, to the needs of the poor in the developing countries, particularly in the urban areas, was first proposed by Danish architects (Winblad 2232) in 1970, and later elaborated by Winblad (2231) and Rybczynski and Ortega (2222). Though as yet untried on a large scale, these types offer enough tangible advantages to merit serious study. The toilet accepts all urine and, being watertight, can be built where there is both a high water table and dense population. Operation is fairly simple as a single container is used, and the fresh excreta is not handled. Rural and urban experiments with multrums in Tanzania have indicated that with adequate education "the majority of users seem to adapt easily to the simple, but essential, special requirements, such as: sparing use of water when cleaning; adding sweepings and grass for the composting process; adding ashes to neutralize acidity" (Eygelaar 2210). Another experiment is reported from Manila (Rybczynski 2224) where a number of multrums were built in a dense urban area to establish costs and ease of construction.

Night-Soil Collection

The collection and removal of night soil has been practiced for centuries, particularly in those areas where it is reused in agriculture (Clemesha 2312). The most primitive version of this practice is referred to as the *bucket latrine*. The excreta (which may or may not include urine) is deposited directly into a container that is periodically removed for disposal. This system is widely practiced in many African and Asian cities (3104, 3107) and has the great advantage of minimal capital outlay on the part of the user and the municipality. However, as usually practiced in the developing countries, it is an unhygienic and offensive procedure that is detrimental both to environmental and health conditions. With more sophisticated technology,

specially designed buckets and trucks, the system can be relatively inoffensive and hygienic, as is evidenced by its current use in Sydney, Australia and Oslo, Norway. However, these improvements significantly increase the operating cost, and there are indications that at that point other systems, such as the vacuum truck and vault, may be cheaper (McGarry 3114).

The limitations to the bucket latrine include the frequent collection visits required to empty the small container of night soil, as well as the difficulty of restricting the passage of flies and odours from the bucket. These have been overcome in the *vault and vacuum truck system* by the use of large watertight household vaults in which the excreta is collected. The contents of the vault are pumped out every 2-4 weeks or longer by a vacuum truck. Smaller version vacuum carts have also been proposed using hand-operated pumps (McGarry 4140). The vacuum truck and vault system is widely used in Japan (3101) and Taiwan (Thomas 3120), and in Tokyo, Taipei, and Tainan it accounts for the majority of the waste-disposal services to the population. There is, however, much room for upgrading these systems, which have grown up spontaneously over a long period of time, and do not always have water-seal toilets or vaults properly constructed to be insect- and rodent-proof.

The truck collection of human wastes has many advantages: the capital outlay is low (about a third that for sewers), the collection system always operates at or near capacity, it is labour-intensive, and when properly operated, has been shown to provide a high level of service. Studies have been made of the long-term economic implications of truck collection based on an existing situation (McGarry 3113). A cost comparison has been made between night-soil removal and the use of waterborne sewerage provided with secondary wastewater treatment. The municipality of Tainan, Taiwan estimates its night-soil collection costs to be \$NT 70* per capita computed on an annual basis, and taking into account pasteurization costs as well as a market value for the treated night soil. The cost of waterborne sewerage, computed on an annual basis (8% interest and a minimum 15-year repayment period) and including operation and sewage treatment by oxidation ponds, would be equivalent to \$NT 366* per capita.

Night-Soil Treatment

Whether night soil is collected by bucket, cart, or vacuum truck it must be disposed of hygienically. This usually implies some form of biological treatment. The most primitive and least satisfactory technique is burial in the ground, which is not only offensive but may expose the fresh excreta to flies and ground runoff (3104).

There are two alternatives practiced in Japan (Ikeda 3012), Korea, and Taiwan (3006) to the expensive activated sludge treatment of night soil that are more appropriate to most developing countries: the facultative stabilization pond and composting.

“Waste *stabilization ponds* are shallow rectangular lakes in which raw (or screened) sewage is treated by natural processes based on the activities of both algae and bacteria. They are without doubt the most important effective method of sewage treatment in hot climates — not only are they the least expensive but they are considerably more efficient in destroying pathogenic bacteria and the ova of intestinal parasites” (Mara 3325). The technology of

*\$NT 40 = U.S. \$1 (1972).

stabilization ponds is well understood (Gloyna 3313), and this method of sewage treatment has been widely used in the United States as well as in Latin America (Talboys 3348), Africa (Stander and Meiring 3347), and Asia (Haridass and Sundaresen 3314).

Though stabilization ponds have traditionally been used for the treatment of waterborne sewage there is no reason why they could not be used also for the treatment of night soil collected by vacuum truck. There is not a great deal of work reported in this area but Shaw (3343) reports the effective treatment of night soil in a stabilization pond using similar loading as a sewage pond, and adding sufficient water to maintain pond depth at 1.2 m.

Stabilization ponds for night-soil treatment could also treat sewage, or could be specially designed to treat night soil and sludges from cesspools and aqua-privies, with the possibility of future expansion or conversion to sewage treatment. The main drawback to stabilization ponds is the relatively large land area required, which, even when available in urban areas, implies high cost.

The *composting* of night soil in a systematic way was introduced to China in the 1930s (Scott 4411) and recent reports from the province of Shantung (3402) indicate that this practice is still an important component of rural health programs. Feces and urine are separated immediately at the squatting plate by means of a "urine drain" and collected separately, often in clay pots, whose contents are collected and transported to the composting site, a centralized location on the outskirts of the village. The separation of the feces and urine prevents the former from turning septic. Two kinds of composting are used: pit composting where air is channeled through trenches at the bottom of the pit, and pile composting where air is introduced into holes made by the removal of sticks. The ingredients of the compost are, equally by weight, human excrement, animal feces, the organic rubbish, and soil. Moisture content is reported to be between 30 and 50%, depending on the time of year. The pile is covered by an earth-mud mixture and left for 20-30 days. This cover not only overcomes problems of flies and odours, but also prevents loss of heat. The composted material is used in agriculture.

Anaerobic composting is practiced on a communal basis in India, where it is known as the "Bangalore process" (Gotaas 3406). City refuse is mixed with night soil and high levels of pathogen destruction are reported (Bhaskaran et al. 3403). Aerobic composting of city refuse mixed with night soil was pioneered by Howard in India and formed the basis for installations in South Africa (Van Vuren 4412) and China (Scott 4411).

Composting of both sewage sludge and raw sewage is reported in the United States (Wilson and Walker 3415). The methods used are either the windrow technique or the forced aeration method. The former requires turning the pile at specified intervals, usually done by specially designed machines. The forced aeration method relies on mechanically induced air movement through the pile, and bears some resemblance to the Chinese method. Dry material, organic waste, sawdust, and wood chips are usually added to the sewage to bulk the material and prevent clogging during the aeration process.

A third less common technique for treating night soil, which has been reported from China (2303; Obeng 2309), consists of anaerobic digestion of night soil with small quantities of water. A household-size plant, called a "two-partition three-tank" system, is a variation of the septic tank, except that biological treatment takes place inside the three tanks, which have a retention

period of 10, 10, and 30 days, respectively. About 2 litres of water per capita are added daily. Complete ascarid ova destruction is reported in the third tank. There is no tile or seepage field, and the liquid effluent is used as a fertilizer.

Greywater

Dry excreta-disposal systems, whether pit latrines, composting privies, or vacuum truck and vault, or even wet systems such as aqua-privies, do not dispose of household wastewater, usually referred to as *sullage* or *greywater*. In the rural areas greywater is simply disposed of around the house and allowed to soak into the ground. In the typical urban area greywater is disposed of in street drains or storm sewers. The common practice in Tokyo, where vaults are used, is to dispose of greywater into the storm drain (3101); in the Kampung in Jakarta, greywater is carried in paved surface drains, which are periodically cleaned by maintenance crews (2103). Similar methods are practiced for greywater disposal throughout the developing world.

It is clear that a trade-off must be made between the beneficial effects of improved excreta disposal for large numbers of people, and the adverse effects of using storm drains, surface or underground, to transport kitchen and washing water.

Studies of greywater in Sweden (Olsson et al. 5011) and in the United States (Siegrist et al. 5013) indicate that the share of total phosphorus in greywater is high, due mainly to automatic dishwashers and clothes washers. Though there is no comparable study of greywater characteristics in a developing country there are data on "hard" detergents, alkyl benzene sulfonate, found in municipal sewage. The alkyl benzene sulfonate level in Haifa sewage is reported to be as high as 17 mg per litre (Hepher and Schroeder 4210) whereas an Indian study reports a range of from 0.08 mg per litre for Calcutta to 1.64 mg per litre for Kanpur (Siddiqi 3233). A similar study (Bajaj et al. 4110) reports phosphorus levels in Indian sewage that are up to 10 times lower than those in the Swedish study (Olsson et al. 5011).

Another factor to be kept in mind is the quantity of greywater that is produced. Greywater production in Western countries varies from 60 litres (Olsson et al. 5011) to 120 litres (Siegrist et al. 5013) per person per day. It is estimated that domestic water consumption in a developing country is between 20 and 50 litres per person per day, depending on whether water is available from a standpipe or a house connection. Allowing for losses, this implies a greywater production of probably 15-40 litres per person per day.

There were indications in the Swedish and American studies that the presence of fecal coliforms in greywater, though much lower than that of sewage, was nevertheless sufficiently high to warrant further investigation. The major source of the coliform bacteria was found to be clothes washing (Siegrist et al. 5013). Neither study attempted to identify any specific viruses in the greywater.

The data on greywater is slim indeed. Nevertheless particular care should be taken when applying the results of research from an industrialized country to conditions in a developing one.

Techniques for Reusing Human Wastes

The World Health Organization Expert Committee on Environmental Sanitation, at its third session in 1954 stated that "the committee recognizes the widespread use, in many parts of the world, of human excreta as fertilizer ... With the growing world population and the limited extent of world resources, all efforts to utilize sanitary by-products and return them to the soil should be encouraged. The necessity of controlling these activities in such a way as to reduce to an absolute minimum their inherent public health hazards can not be too strongly emphasized."

Recycling, or reuse, of resources is widely practiced in the developing countries. This is not done for reasons of environmental control, as in the West, but out of dire necessity. The point has already been made that the developing country is in most cases less well-endowed with natural resources than were the presently developed countries when they started development. When one adds to this the pressures of a population explosion, the developing country faces a situation where meagre resources must be stretched a long way indeed. Nowhere is this more true than in agriculture, where land, which has in many cases been farmed for centuries, must produce an even higher output, and this in spite of adverse climatic extremes such as aridity or flooding.

The difference in practices in reusing human waste is particularly marked in Asia, where for a long time a large population has supported itself on rather small areas of arable land. Two examples show that human excreta is treated not only as a resource, but as a *valuable* resource.

It is reported that in China during the "Accumulate Fertilizer" campaign that took place in the midfifties, the ownership of night soil became a great point of controversy. "One commodity was central to the controversy and was of peculiarly private nature, this was nightsoil which was sometimes expropriated at abnormally low prices, payable at a future date by the collective organization. There was a tendency for farmers to withhold the nightsoil they produced for use on their own private plots. At the peak of the fertilizer campaign exhortation was so great as to give rise to the extreme example of houses being torn down to capture the fertilizer value of the earthen walls" (McGarry 4402). In any event, the "night-soil question" led to a relaxation of regulations and a decentralization of authority.

The area surrounding the city of Tainan in Taiwan is well known for its fish, which are farmed from over 6000 hectares of fish ponds. Night soil is used to fertilize the ponds, and the municipality of Tainan, which operates a conservancy system, sells the night soil to the fish farmers in the area, in some cases up to 40 kilometres away. Such is the demand for this commodity that in fact a black market for night soil is reported to exist. This is of some annoyance to the municipality, which counts on night soil sales to offset collection costs (McGarry 4140).

A program of night-soil reuse presupposes a market, and a demand, for the fertilizer. There are indications that changes in life-style have affected the night-soil market in Japan and Taiwan (Julius 4409), and a program of night-soil reclamation may require incentives and user education to be successful.

The question of human waste reuse is divided into the following sections: fertilization with treated and untreated night soil; irrigation with sewage and

stabilization pond effluents; fertilization of fish ponds with night soil and fish production in stabilization ponds; algae production in high rate ponds; treatment with aquatic weeds; and the production of biogas using anaerobic digestion.

Fertilization

It is often stated that human excreta is 90-95% water, but it is the balance left over that is of interest here. Night soil contains the three main plant nutrients, nitrogen (0.6%), phosphorus (0.2%), and potassium (0.3%) (McGarry 4402) and the most widespread reuse of human wastes, now as in the past, is direct fertilization of crops with untreated night soil (Williams 4407). This technique is practiced by farmers throughout Southeast Asia, but particularly in Korea, China, and Taiwan, and to a lesser extent in Japan, Thailand, the Philippines, Indonesia, and Malaysia. The use of night soil as pig feed, usually an unhygienic practice, is likewise traditional in a number of South Asian, African, and Central American countries.

It is recognized that the use of untreated night soil is undesirable from a health point of view. However, any "improvements" in the present situation must recognize the vital role that night-soil reuse plays in the rural economy of many developing countries.

There are some reports of treatment of night soil before reuse, notably in China. One practice, which has already been mentioned, is the composting of night soil mixed with animal manure, organic rubbish, and soil (3402). Another form of treatment is sedimentation and digestion in a modified septic tank, which is reported to achieve complete destruction of hookworm and *Schistosoma* ova (2303). Anaerobic composting is reported in India (Bhas-karan et al. 3403) and in the Socialist Republic of Vietnam (2202) and in the latter case seems to be practiced on a wide scale.

The humus value of night soil is as significant as the nutrient properties, so much so that in Korea and Japan, where chemical fertilizers have largely replaced night-soil fertilizer, quantities of the latter are still used to improve soil properties.

Irrigation

Any discussion of irrigation with wastewater in developing countries must be preceded by an important caveat. Though a great deal of literature exists on irrigation with sewage, treated sewage, or stabilization pond effluents, the fact still remains that *only 6.5% of the population of developing countries has access to a sewerage system* (3220), hence the reuse of sewage, though it may have important implications, inevitably skirts the main issue. The fact that so much scientific work has been done on wastewater irrigation in many of the developing countries is more a reflection of Western-influenced engineering education than of a real need.

Nevertheless, stabilization ponds can be used to treat night soil, and for centre city locations sewerage remains one of the few effective options. Because the sewerage option has been chosen already in a number of cities, a discussion of wastewater irrigation can still be useful.

The widest use of sewage for irrigation in a developing country is in India, where *untreated sewage* is used directly on the soil. It is reported that almost a third of the sewage produced by about 35 million people (7% of the total

population) is utilized for irrigation (Shende 4149). Studies have been made of wastewater characteristics (Bajaj et al. 4110), and results show that, in general, the BOD and solids concentration are higher than in Western sewage, due mainly to lower per capita water use (Siddiqi 3233). The nutrient value of wastewater, as of night soil, is considerable. Total nitrogen ranges from 25 to 70 milligrams per litre, phosphates from 7 to 20 milligrams per litre, and potash from 12 to 30 milligrams per litre; in addition, putrescible organic matter ranges from 300 to 1000 milligrams per litre and, on decomposition forms a valuable humus addition to the soil (Shende 4149). It is reported that untreated diluted sewage is used to irrigate forage and pasture grasses and sugarcane (Sivanappan 4153), but root vegetables or leafy low vegetables are not recommended to be grown with raw sewage (4102). Sewage farming, as it is known in India, is generally practiced under organized conditions and on a specific range of crops to reduce health hazards to workers as well as to consumers in the case of edible crops (Kotia 4133).

There are three hazards associated with using untreated sewage directly in irrigation: the danger of transmitting diseases into the food chain; the health hazards of handling untreated sewage in the irrigation process; and the possible damage to the soil through salinity and alkalinity development. Some preliminary work in Israel on drip irrigation with untreated sewage of leafy vegetables has yielded surprising results (Goldberg 4130), that indicate that more investigation needs to be done. In one case, cucumbers were grown in fumigated soil and protected from sewage by a plastic mulch, and in another case they were in direct contact with the untreated sewage effluent. The unexpected result was that there was no difference in bacteria and virus counts, which were relatively low. A second experiment introduced pathogens into the wastewater and in this case the cucumbers protected by plastic mulch yielded a safe crop. Once again, as with night-soil reuse for fertilization, research must be done on techniques and crop types that are appropriate for irrigation with untreated sewage.

The use of treated sewage, or effluent, in irrigation is well known in the West but much less practiced in the developing countries, because the considerable cost of sewerage must be added to the not inconsiderable cost of sewage treatment. For the purpose of this section it will be assumed that when treated sewage is used for irrigation in a developing country, it will be stabilization pond effluent.

Stabilization ponds are generally considered as the most appropriate method of waste treatment for tropical climates, and are well described by Gloyna (3313) and Mara (3325). The use of stabilization pond effluent has agricultural, sanitary, and environmental benefits, and considerable work has been done in many countries on this and on the general subject of irrigation with sewage effluent (Law 4139). One of the key questions that has been the subject of much research has been the survival of pathogens and viruses in sewage effluent and their effect on the crops being irrigated. It is now generally accepted that stabilization pond effluents contain reduced numbers but viable pathogens. Coliform counts may be reduced by chlorination (Shuval 4151; Kott 4135), although enteroviruses seem to be a more severe problem (Larkin et al. 4138) and heavy and long chlorination is required to achieve the same degree of disinfection for poliovirus as is required for coliforms (Shuval 4151). In a review of the subject, Shuval (4406) concludes that most conventional treatment processes, such as stabilization ponds,

cannot completely destroy pathogens, that there is evidence that pathogens may survive long enough in the fields to infect potential consumers of those vegetable crops eaten raw, and though total destruction is possible with advanced treatment, it is unlikely that most developing countries could technologically or economically afford these. However, "A balanced approach combining low-cost waste treatment methods capable of providing reasonable, although not complete, reductions in pathogen levels with restriction of crops to those presenting a low level of public health risk appears to be the most prudent policy to achieve the maximum social benefits from waste reuse." (Shuval 4406).

An interesting possibility for irrigation with stabilization pond effluents is the growing of nonfood crops, thus eliminating the health hazard altogether. There are reports of sugarcane, tobacco, cotton, and oil-bearing plants irrigated with effluent (Kotia 4133). Tree plantations have also been irrigated with sewage effluent in the United States (Sutherland et al. 4155) and Canada (Gagnon 4126), and irrigation of coconut trees with stabilization pond effluent is reported in Madras.

Practically all methods of irrigation with water can be adapted to use with treated or untreated wastewater irrigation. One of the most common in South Asia is the *furrow method* in which the wastewater is channeled along ditches beside the growing areas (Sivanappan 4153). *Wild flooding* of tracts of land is often practiced where large amounts of wastewater are to be disposed of, though studies in India have shown high levels of helminthic infection among farmers engaged in such practices (Sastry 4404). *Sprinkler irrigation* is much in favour in the United States, though there are indications that dispersion of aerosolized enteric bacteria may be considerable (Katzenelson and Teltch 4132; Shtarkas and Krasil'shchikov 4150). In any case the high capital cost makes this an inappropriate technique for most developing countries. Subirrigation, particularly by *drip irrigation*, has many advantages with regard to low water use, increased yield, direct application to the root system, and lower possibility of contamination (Romanenko 4145), though these would have to be balanced against higher capital cost and greater skills required.

Work has recently been done in the United States on the accumulation of heavy metals in soils and crops from extended wastewater irrigation (Sidle et al. 4152; Dowdy and Larson 4119; Giordano et al. 4129). Cadmium, copper, zinc, and lead are likely to be present in sewage coming from cities with industrial areas. Cadmium, nickel, and zinc are potentially the most harmful to crops (Trout et al. 4157). The heavy metal hazard is a particular factor when applying settled or digested sludges to land, though not enough work has been done to date on specific crops and soil types. The question of salinity buildup in the soil, particularly sodium and boron, depends heavily on soil type, crops, water table, and climate, and, like nitrogen buildup, can only be determined on a case-by-case basis. This applies to treated and untreated sewage.

Aquaculture

Cultured fish are a major source of animal protein in China, Japan, Taiwan, Indonesia, the Philippines, Hong Kong, and Malaysia, and fish culture is also practiced in India, Sri Lanka, Thailand, Bangladesh, and Pakistan. The most common method of fertilizing these fishponds is to use organic manures (Prowse 4217), which include human as well as animal wastes. There are basically two techniques for reusing human wastes in

aquaculture, either by fertilization of fishponds with fresh night soil or by rearing fish in waste stabilization ponds. Most scientific investigation has concerned itself with the latter and has largely ignored the popular practice of fishpond fertilization with night soil.

Throughout Southeast Asia, where night soil is added to fishponds, the accent is on fish production rather than waste treatment: 6000 hectares of fishponds are fertilized with night soil collected in the city of Tainan (McGarry 4140); in Calcutta, sewage is diverted into the fishponds (Prowse 4217); and in the many domestic installations, latrines are actually built out over the pond (Prowse 4217). It is estimated that there are about 425 000 hectares of ponds in the region (Tapiador 4222).

The night-soil fertilized fishpond demonstrates the reuse cycle. The consumer produces night soil, which is introduced to the fishpond and provides the main source of nutrients for bacterial growth. The by-products from this process are the primary nutrients for the algae, which in turn are the basic food form for the fish, which in turn are food for the consumer.

The second technique for combining human waste reuse and aquaculture is to introduce fish into the secondary ponds in a waste stabilization pond system. The accent here is on waste treatment. The presence of fish improves the functioning of the pond with regard to algal removal, reduction of suspended solids, as well as reduction of fecal coliform bacteria in the final effluent (Carpenter et al. 4207). This has led to research on integrating aquaculture with agriculture (Hepher and Schroeder 4210) by introducing fish into stabilization ponds and then using the effluent for irrigation. The integration of different activities, in this case waste treatment, fish farming, and irrigation, has important implications for overall economic feasibility and in fact duplicates on a large scale what many peasants in developing countries already practice.

It is important to point out that the productivity of fishponds using wastewater has been found to be higher than that of inorganically fertilized ponds (Allen and Hepher 4204). An oxidation pond stocked with carp in Madras is reported to have an annual productivity of 7700 kilograms per hectare (Muthuswamy et al. 4216).

The reduction in zooplankton and bacteria reduces the carbon dioxide levels, which in turn raises the pH in the fish-stocked stabilization ponds (Hepher and Schroeder 4210); this, together with high oxygen levels, results in surprisingly disease-free environmental conditions in the pond. Fish have been shown not to be susceptible to infections from enteric bacteria that cause diseases in humans and animals, and where human pathogens have been identified they have been isolated in the gut, which can be cleaned by depuration (Allen and Hepher 4204).

The possibility also exists of combining wastewater effluents with marine culture. Ryther (4219) describes an integrated project in the United States where secondary sewage effluent, mixed with seawater, is used as a source of nutrients to grow single-celled marine algae, which are in turn eaten by shellfish. The phytoplankton remove the nutrients from the sewage effluent, and the filter-feeding shellfish remove the phytoplankton from the water. Solid wastes produced by the shellfish serve as food for secondary commercial crops of marine animals such as lobster and flounder. There are possibilities for adapting such a system to coastal locations in tropical regions, where plentiful solar energy and high water temperatures would promote marine food production.

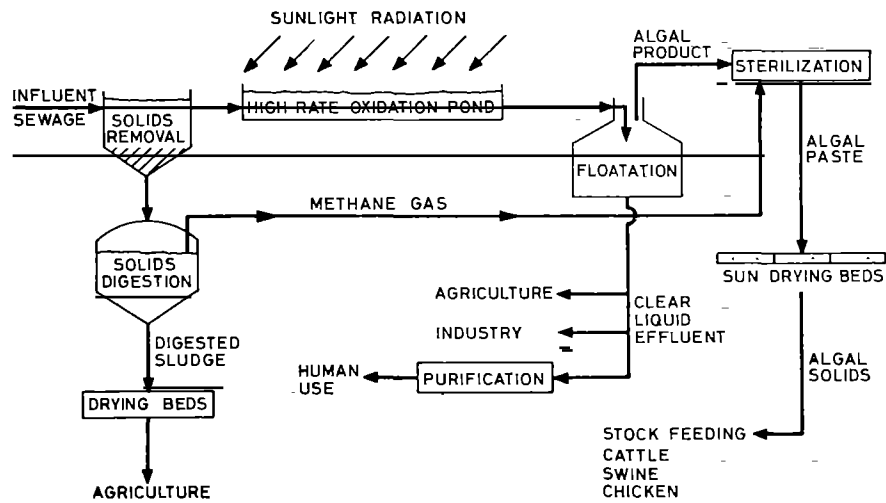

Mass algal culture and processing flow diagram (from 4312).

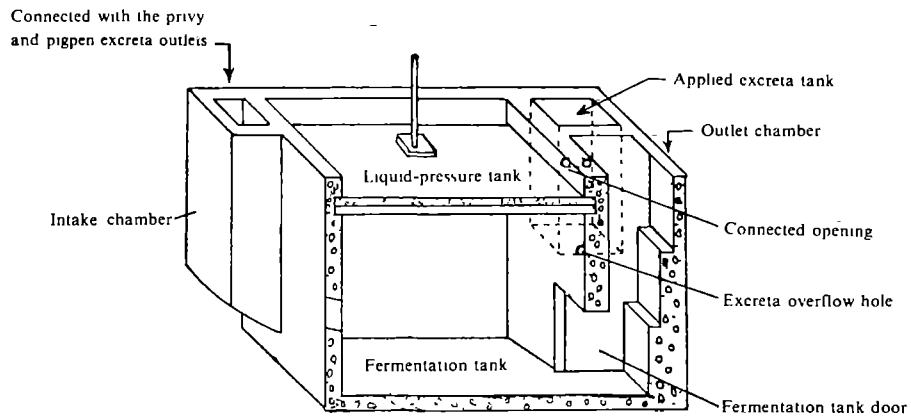

Enclosed three-stage biogas plant with applied excreta tank (from 4504).

Algae Production

Algae play an important role in the photosynthetic process of facultative stabilization ponds. These ponds can be designed specifically to maximize algae production by reducing the pond depth to 20-40 centimetres to improve sunlight availability throughout. The conversion of sewage nutrients to algae is extremely rapid under these conditions, taking 3-4 days, and the resulting pond is usually referred to as a *high-rate pond*, or sometimes as an *algae pond*. The functioning of high-rate ponds is described by Oswald (4315).

One of the main reasons for the interest in algae is the fact that they are usually about 50% protein, and annual yields of algae on a kilogram of protein per hectare basis are significantly higher than conventional crops such as rice, corn, or soybean; under operating conditions 150 kilograms per hectare per day of protein can be produced (McGarry 4310). The importance of algae as an animal feed substitute (thus liberating grains for human consumption) could be beneficial for poorer countries (Grisanti and Oswald 4307).

Algae need nutrients for growth. Most natural waters do not contain all the required nitrogen, phosphorus, or potassium. Human and animal wastes, on the other hand, contain all three, hence algae can be cultivated in sewage with no supplementary nutrients (Grisanti and Oswald 4307), and indeed high-rate ponds provide near optimal conditions for algae production. The nutritive value of algae as food has been extensively studied (4302). However, one of the problems encountered with algae as an animal feed has been the low digestibility of the nonprotein component — the cell walls (Hintz et al. 4308).

An interesting proposal to use algae as fish feed (Wachs et al. 4321) is based on the fact that algae constitute their natural food and their digestive system is assumed to be more adapted to algae. The production of algae in high-rate ponds and subsequent use as fish feed also offers the flexibility of using the algae for animal feed.

The quality of water discharged from high-rate ponds is considerably improved (Oswald 4315) and can play an important role in agriculture for irrigation (McGarry 4310). Interestingly for urban locations, many industrial wastewaters can also be used for algae production, though they would require in some cases the addition of specific nutrients (Grisanti and Oswald 4307).

High-rate ponds have been built only on a pilot scale so far. The main drawback has been the development of satisfactory harvesting technology (Golueke and Oswald 4305). The harvesting of algae requires three steps: initial concentration, dewatering, and final drying (Golueke and Oswald 4305). Two processes for initial concentration have been developed on a pilot scale: chemical flocculation and filtration. Conventional algae production is currently practiced on a pilot scale in Mexico, Japan, and Formosa. Algae production in high-rate ponds is being researched in Israel, West Germany, and Singapore (Grisanti and Oswald 4307).

Aquatic Weeds

Another form of aquaculture, in addition to fish and algae, is aquatic weeds. A process has been developed in Germany (Seidel 3508) whereby reeds and bulrushes are used to purify sewage. Dissolved organic and inorganic materials are absorbed by the reeds. Oxygen is passed through the root system and into the sludge at the bottom of the pond, which is thus aerated. A second pond with bulrushes further purifies the wastewater. An adaptation of this

system is reported to be functioning well in the Netherlands (DeJong 3505). Water hyacinths are reported to be used for sewage treatment in the United States (3501) where they are harvested for animal feed, and a recent proposal has suggested converting the water hyacinth into fuel using the biogas process (Wolverton et al. 3513). The interesting aspect of this proposal is the discovery that water hyacinths can be used to produce biogas *without* the addition of any extra materials. Aquatic weeds are grown in ponds to which animal waste and night soil are added, and the harvested weeds are used for animal feed in the Socialist Republic of Vietnam and throughout Southeast Asia (3501).

Aquatic weeds are normally grown in shallow ponds. The use of aquatic weeds for wastewater treatment is still experimental, and not all the health implications are understood yet (3501). As most of the scientific investigation of aquatic weeds has taken place in America and Europe, care should be taken in adapting this technology to tropical conditions. One aspect of aquatic weed ponds that has not been reported to be a problem in temperate climate locations is mosquito breeding. Since this is a problem associated with oxidation ponds in tropical climates, and is usually remedied by removing all grasses, particularly at the pond edge (Yau 3354), it would have to be taken into account with aquatic weed ponds.

Biogas

The anaerobic decomposition, or fermentation, of human excreta produces a combustible gas. This gas, referred to as *methane*, is also known as *swamp gas*, *gobar gas*, *dung gas*, or *biogas*. All anaerobic processes produce this gas (a mixture of about two-thirds methane and one-third carbon dioxide) but specific installations have been designed to optimize gas production; they are known as “methane digesters” or “biogas plants.” Biogas plants on a large rural scale have found application in a number of Asian countries since development began in India in 1938 (Subramanian 4526). It is reported that at the moment there are 80 000 plants in China (McGarry 3114), 36 000 in India, 27 000 in Korea (Subramanian 4526), 7000 in Taiwan (McGarry 3114), and smaller numbers in the Philippines, Thailand, Indonesia, and Japan. Most of these plants are fairly small (1-6 cubic metres) and owned by individual farmers, though larger community-scale (30 cubic metres) plants have been reported on plantations and associated with schools and cooperatives (Subramanian 4526). Various designs are described for biogas plants, ranging from batch digesters (Fry 4507) to continuous-type family and farm-size plants (Singh 4520). The most common uses for the gas are for domestic cooking and lighting (4504), though it can also be used to power combustion engines (Fry 4507). It has been estimated that to run a 1-horse power water pump 8 hours a day, about 3.5 cubic metres of gas would be required, which would need the contribution of six to seven medium-size cows (McGarry 3114). There is considerable variation in what is thought to be the minimum number of animals required, or gas used, by a single household, though reports indicate that in practice consumption may be as low as 0.2 cubic metres per capita for cooking, and digesters have been found to be operating on one cow and the family night soil (Subramanian 4526). It is important to point out that the addition of night soil, high in nitrogen, results in higher yields of gas, though the low volume of night soil inevitably requires supplementation with animal wastes for adequate gas production.

The slurry or effluent from the digester contains about 2% nitrogen on a dry basis and is very valuable for fertilization. The normal practice is to dry the slurry, and subsequently spread it on the land. In larger installations the slurry may be pumped out of the digester and spread on the land by tank truck immediately.

Studies have been reported in China on the effectiveness for destroying pathogens (4504). The results indicate that there was 93.6% destruction of hookworm, ascarid, and schistosome eggs. The schistosome eggs were completely destroyed, and very few hookworm eggs survived, but the survival of ascarid eggs was quite high. This is mainly due to the relatively short retention period within the digester, usually about 2 months. This implies either additional treatment of the slurry, or redesign of the digester to lengthen retention time and increase ascarid destruction.

There are areas for technical improvements in digester design and materials, particularly lengthening the life of the steel tank cover, and of course lowering costs (Pyle 4516). In this connection an important new development is reported in China (4504). This involves the use of a fixed gas storage chamber, unlike the movable covers normally utilized in India. Pressure is maintained by a layer of liquid slurry, which is displaced by the newly produced gas into a second displacement tank. This permits the construction to be entirely of concrete, a considerably cheaper material than steel. Previous experiences with concrete movable covers have not had great success because of eventual cracking and leaks (Subramanian 4526).

However, the main discussions of wider biogas utilization in developing countries seem to hinge on the economic and social benefits of this technology. The capital cost is higher than can be afforded by the poorer peasants (4505). The use of biogas in many Asian countries shows that it has a place in the rural economy. The diversity, both of designs and of perceived and real benefits, in the different applications makes it extremely difficult to reach a single conclusion on the subject (Subramanian 4526).

Most biogas applications have to date been in rural areas, where animal manure is available, fertilizer may be required, and electricity is usually lacking. Nevertheless Subramanian (4526) mentions several urban plants, and research biogas plants are operating in Manila. The possibility of growing aquatic weeds in urban treatment ponds and then using them for biogas plants (Wolverton et al. 3513) would seem to have particular application in urban areas where animal wastes may be in short supply. Although it is possible to generate biogas using human excreta alone (Subramanian 4526), most of the literature pertains to treatment of settled sewage sludge by anaerobic digestion in large-scale sewage treatment plants.

Waste Disposal / Reuse Options For Cities and Towns

The focus of this problem is clearly on the urban situation. This is not to imply that rural sanitation is less critical; in fact proper rural sanitation is a numerically greater issue as most of the population of developing countries is rural. The statement is often made that "rural sanitation is not a technical problem." Many of the studies identified by this technology review have raised

serious doubts as to the accuracy of this statement. It is clear that in this field, as in so many others, 19th century solutions are not always up to 20th century problems. Much of the colonial sanitation technology, which is still being applied, represents "top-down" improvements that often reflect foreign (to the peasant) values, and not surprisingly meet with rejection (Muhondwa 1009). In this light, the indigenous reuse technologies are particularly interesting, for though there is room for improvement, they seem more closely related to the resources, and needs, of the villagers.

The differences between the conditions facing a country that is beginning its development today, and those under which the now developed countries began their industrial development in the mid-18th century, have already been pointed out. The often meagre physical resources, fast-growing population, particular climatic conditions, and extensive poverty apply in both the urban and rural areas, but in the cities they reach unprecedented proportions. Thus urban sanitation is considered separately in this section, not because it is necessarily the most important problem, but because it appears the most difficult to solve.

A developing country attempting to solve its urban waste-disposal problems must choose a course of action. The purpose of this review is to suggest that there are a number of options that ought to be considered, and although waterborne sanitation remains the ultimate solution for many, it may not be immediately realizable. In that event, other technological options may offer the possibility of step-by-step improvement.

The options can be lumped into three main categories: waterborne options, cartage options, and on-site options. The inevitable question follows: for what reasons should one system be chosen over another? Although this question falls outside the scope of this review, a review of this kind would be incomplete if it did not deal, however briefly, with some of the implications of a shift in attitude from a conventional single option to a multiple-option approach. Thus, such a discussion forms the final part of this section.

The Waterborne Options

This study has failed to identify any options, other than sewerage, that could apply to high-density, high-rise housing and commercial areas. It seems that, for the moment at least, underground sewers are the only solution for the central business district or for those areas where housing is in the form of high-rise buildings. Although there have been proposals for high-rise alternatives (Nesbitt and Seldman 2217), these have been in an industrial country context and speculative in nature. The application of sewerage in the high-rise, high-density context might minimize two of the drawbacks usually associated with waterborne sanitation. First, the required piped water is usually available in high-rise housing, and second the concentration of population significantly reduces the unit cost of sewerage. In general, sewerage capital costs reduce in proportion to the density of population served.

However, with the notable exceptions of Hong Kong and Singapore, very few cities have popular housing contained in high-rise buildings. This is not only due to the economic costs of this form of construction, but also to the financial costs, as demonstrated in the failure of the superbloques in Venezuela in the 1950s. The bulk of housing in a developing country city is still likely to be contained in one- and two-storey buildings.

One of the technical problems reported with sewerage in low-density areas in tropical climates is a tendency to clogging because of insufficient water usage (2205). This is particularly true in arid conditions, or when only a small part of the population can afford to be connected to the sewerage system. A waterborne alternative, called the *aqua-privy / sewerage system*, has been proposed to overcome this drawback (Vincent et al. 3235). This system consists of conventional aqua-privies connected to sewer pipes. This vault acts as a settling tank for all the solids, and only liquid overflow passes into the sewerage system. It is claimed that smaller diameter pipes and lower gradients will reduce the cost of the sewerage network, and the smaller quantity of water will reduce treatment costs. There are reports that in Zambia, where the aqua-privy / sewerage system has been installed, clogging is frequent due to misuse of the system, and that difficulties have been encountered with desludging of the vault. The latter is reported to be the result of high-density construction, which obstructs access to the vacuum truck, and is more a result of poor planning than an inherent failing of the system. There is no question that the aqua-privy / sewerage system is cheaper than conventional sewerage (McGarry 3113) and in N'Djamena where sewers were deemed necessary, it at least assured easier operation (3204). However, the saving is marginal and the capital cost of pipes, trucks, and vaults is high indeed.

Where waterborne systems are already in use, or where they represent the only viable option, two points should be kept in mind: the reuse potential of the wastewater, and the quantity of water consumed.

The reuse potential of wastewater has already been pointed out. There exists the possibility to recoup at least some of the capital cost of the sewerage system by the development of algae production and fish ponds and secondary use of water for irrigation. One of the constraints on the proposed sewerage system in Yemen was that the water should be recharged to the aquifer, so important a resource was it considered (3003). Most urban sewerage projects eat up funds in underground pipes and inevitably approach disposal from a short-term "least cost" point of view. This leads to primary treatment and river disposal, as at Rangoon (Singh 3234), instead of taking advantage of the long-term benefits of reuse.

Water Saving

The quantity of water consumed rises sharply when it is available in pressurized house connections, and as a result wastewater becomes a major problem. Taken as a group, even if only one-quarter of the population is served by house connections it will consume more water than the rest of the urban population that is served by public standpipes or vendors. Thus, though it might appear that water saving is a side issue in countries where less than half of the urban population has access to piped water, an inequitable distribution of this often scarce resource demands that attention be paid not only to distribution, but to the quantities consumed.

The result of water-saving practices has several important implications. A reduction in use, particularly by that portion of the urban population served by piped water, will have an effect on water supply as well as treatment costs. In the case of those served by piped water, but lacking adequate greywater drainage, reduction in wastewater quantities could have significant health benefits (Morse 6022). A third benefit will affect those who buy water from street vendors, often at a higher price than paid for by those with house

connections. In water-short areas, devices that reduce consumption can provide health benefits by making more water available for hygiene-related activities such as hand and body washing.

There have been a number of studies in the United States dealing with methods for reducing domestic water consumption (Hershaft 6018; Fowell et al. 6013; Bailey et al. 6008). Not surprisingly, the *flush toilet* is found to be the main water consumer. A recent British study (6004) has identified simple modifications to toilet cisterns that could reduce water consumption by 40% and is developing a 4.5-litre flush toilet-pan. A simple variable-flush water cistern is reported as being used in Uruguay (Rybczynski and Ortega 6024) and dual-flush cisterns have shown reductions of 26% in water use (Sobolev and Lloyd 6030). Flow-limiting devices have successfully been employed in several South American countries. These include public hydrant taps with automatic shut-off valves and devices with restricting orifices located within water supply lines. Reductions in water use due to metering, particularly when combined with effective tariff structures, are well known.

Another water-saving technique is worth mentioning as it could have important implications in greywater reduction, especially for those people who do not have access to sewers to dispose of their household water. Atomization of water has been proposed as a technique for reducing the amount of water needed for washing and showering. A low-cost prototype has been tested that uses 2 litres of water for a 6-minute shower under manually induced pressure (Morse 6022). Atomization devices replacing conventional showering fixtures have shown water savings of 25% for total household water consumption in a typical British home (6004).

The Cartage Options

One of the principles of sewerage is the removal of human wastes to locations, usually outside the city, for treatment and(or) disposal. There are a series of options for removal of human wastes that accomplish this without the use of underground pipes, but by some form of cartage, either handcarts, trucks, or vacuum trucks, depending on the level of sophistication. Cartage is widely practiced throughout the cities of developing countries and is one of the most common non-Western systems. It is reported in China (Sebastian 4405), Japan (3101), Nigeria (3104), and Taiwan (McGarry 3113).

The technology of cartage is not complicated (see Night-Soil Collection, p.19). The main criticism leveled against it is the high degree of efficient central organization required for successful operation. The cartage system always operates at full capacity from its inception. This contrasts sharply with piped sewage schemes, which may not operate at capacity for many years after beginning construction. The costs of cartage systems vary from case to case, but two factors stand out: the frequency of collection, and the distance from vault to disposal point. In most Asian countries the contents of the vault are pumped out every 2-4 weeks (3101). If this time were increased by utilizing larger vaults, collection cost reductions would result. The distance from the vault to the point where the vacuum truck discharges its contents also affects the size of the truck fleet, as well as the travel cost. This is pointed out in specific studies for Yemen (3003) and Chad (3204).

Unfortunately, little work has been done on reducing the cost of vacuum trucks, or on low-cost methods for night-soil treatment. It is clear that vacuum truck systems from relatively advanced countries such as Japan will have to be

adapted to the conditions in the poorer developing countries. Smaller-scale vehicles, such as hand-operated vacuum carts (McGarry 4140), which could be locally fabricated, would make the cartage system much more adaptable to incremental adoption by the informal sector.

One of the advantages of cartage is that it can be used to upgrade conditions in existing built-up areas, where the construction of underground sewers would be impossible. Cartage can also be used in conjunction with on-site systems. An example of this is reported in Jakarta (2103) where existing cesspools have been made operable by periodic pumping out, in spite of high groundwater and poor soil conditions. It was found that the cost of this service was affordable by the low-income community.

It seems likely that the only cartage system that can be hygienically operated is the vacuum truck, or the smaller scale version vacuum cart, into which the night soil can be sucked directly from the vault. This avoids the problems of odour, uncleanliness, and unpleasantness associated with the pail or bucket systems, both for the user and scavenger.

The On-Site Options

All of the urban options identified in this review require large-scale activity in the planning phase, whether to design a sewerage network or to organize a truck and vault system. The same is true of the on-site options — adequate systems must be designed and information disseminated throughout the community. The unique characteristic of this third option, as distinct from the first two, is that the on-site options can be implemented and operated by the individual.

Recently it has become recognized that the informal sector in many developing countries is more successful at providing services, such as housing, than the central authority. This concept goes beyond the traditional “self-help” approach, where people provide the labour component of centrally administered projects. Most urban slum dwellers out of necessity build their own houses, roads, and community buildings. In many cases they also install water, electricity, and drainage. Even in those developing countries with avowed centralist goals, the informal sector plays an important role.

The simplest on-site systems are the pit latrine and its urban offshoot, the cesspool. There are reports of urban pit latrines working satisfactorily in India (Kharkar et al. 2114) and the already mentioned practice in Jakarta, where individual cesspools are operated by periodic pumping out (2103). The possible density of use of pit latrines varies greatly with soil conditions (Wagner and Lanoix 2125). In African site-and-service projects, pit latrines are used with population densities of up to 150 persons per hectare.

The most common on-site treatment in the industrial countries in rural areas is the septic tank. The developing country version of this is the aqua-privy, which is used in urban areas but, being a wet system, is limited by soil conditions to an even greater extent than the pit privy. There has been a recent proposal for the periphery of Manila to install aqua-privies connected to mini-oxidation ponds for about half the population who cannot afford sewerage. A modification of the aqua-privy that increases the retention time to 90 days might have application in urban areas (Teodorovic 2343). Aqua-privies, periodically desludged by vacuum trucks, have been proposed as

public latrines in Belize (3103). Although put forward in recent literature as an appropriate alternative (Oluwande 2331; Mann 2330), there is evidence of operational difficulties (2301).

The possibility of urban applications for biogas plants has already been mentioned. Two areas in particular have not been well reported in the literature. One is the production of biogas with human excreta alone. The second is the optimal scale for urban biogas plants, whether "block" scale to service 20-30 families, or individual mini-plants for an individual household.

This technology review has identified few waste treatment systems that have been developed since 1950; one of these is the *compost privy*. The largest single example is the Vietnamese program of anaerobic composting toilets (2202), primarily a rural technology but with some application in suburban areas. There have been suggestions that the aerobic composting toilet, or multrum, could be adapted to urban tropical conditions (Winblad 2231) but so far this has only been done on a pilot scale in Tanzania (Eygelaar 2210) and in Manila (Rybczynski 2224).

Composting privies should not necessarily be regarded as an "interim solution." Although greywater could be disposed of by surface drains, this could ultimately be done by underground pipes, while maintaining a dry on-site system for excreta disposal. The now-developing countries have an opportunity that was not available to the industrial countries in the mid-19th century, that is to choose a dual system: dry treatment of excreta and underground drainage of greywaters. This is a crucial decision that could avoid many of the difficulties that only now are becoming evident in Europe and North America.

Economic Comparisons

There are a number of studies (Holland 2113; Hansen and Therkelsen 3225; McGarry 3113) that have attempted an economic comparison between different urban systems. The general method is the same, that is, to determine the least cost solution while considering certain factors such as population density and interest rates. Only the capital and operating costs are considered. The fact that these studies utilize an abstract site limits their application to actual conditions, though the methodology is instructive. A number of engineering master plans have made economic comparisons of two or more systems (3003, 3204) but these are also least financial cost calculations that give a very crude picture indeed as they cannot realistically take into account side benefits.

The difficulties with evaluating different systems on the basis of economic comparisons are multiple. The cost-benefits of the different technologies are not all equally understood, and the data on some of the systems are quite meagre. It is difficult, if not impossible to take account, in money terms, of the social-cultural-medical aspects of sanitation without distorting them or losing their significance (Adams 3001). It is difficult to incorporate important factors such as the extent of off-shore costs versus the use of locally available materials. Finally, it is impossible to compare the economics of systems that are essentially engineering works (cartage and waterborne) with systems that could be implemented on an individual scale (on-site).

Table 1 summarizes in a very general way some of the significant characteristics of the three classes of systems, waterborne, cartage, and

Table 1. A summary of the significant characteristics of the three classes of systems.

	Waterborne	Cartage	On-site
Capital cost	High	High / low	Low
Operating cost	Low	High	Low
Offshore cost component	High	High / low	Nil
Water consumption	High	Low / nil	Low / nil
Optimal density	High density (high rise)	High density (low rise)	High and low density (low rise)
Adaptability to incremental implementation	Nil	High	High
Adaptability to self-help	Nil	Low	High
Reuse potential	High	High	High / low

on-site. These characteristics will of course vary from country to country, and final decisions would require quantitative data.

A New Approach to Identifying Waste-Disposal Solutions

Sewerage has been regarded as a universal solution to waste disposal. This fact, more than any other, has played such an important role in the widespread adoption of underground sewers in American and European cities, and, with less success, in the rest of the world. The same engineering formulas have been applied, often by the same engineers, whether in Madras, Montreal, Mexico City, or Manila. Once the variables are known for any particular situation, tried and true techniques have been used to achieve a predetermined result. A technical solution that is universal, such as the bicycle, has enormous durability, and instead of being *adapted* it can simply be *adopted*. As long as the advantages outweigh the compromises there is tremendous advantage in adopting a solution that has been developed over a long period of time. The fact that the universal solution ignores many variables is, from an engineering point of view, only advantageous as far as implementation is concerned.

However, universality is not the goal of engineering, rather an occasional achievement. All attempts to universalize housing, for instance, have been a failure and it is becoming accepted that the optimal solution and often the only possible solution, is the one that takes into account local and circumstantial resources, both human and material. Just as particular solutions should not be maintained out of a misplaced sense of superior knowledge (ethnocentrism), so universal solutions should be discarded if it turns out that they are not doing the job.

There is a danger in assuming that the alternative lies with another universal solution. It is much more probable that it will be a combination of solutions adapted to different situations and communities. The fact that a universal solution is replaced by particular solutions should not be seen as a disadvantage. There is a danger that the main criticism leveled at any nonconventional waste-disposal system will be that it is not universal, that it

will be difficult to implement, that new standards will have to be set, that personnel will have to be trained, and so on. All this is undoubtedly true, but it must be weighed against the disadvantage of a “universal” solution that so far has been able to reach only 6.5% of the people in the developing countries.

It must be understood that the solution to a problem is very much a function of the way that the problem is defined. Alternative solutions emerge as the result of an alternative statement of the problem. As long as the problem of urban sanitation is not restated, a consideration of the technological options will inevitably lead back to the sewerage solution. There are three assumptions in the conventional approach to urban sanitation in a developing country that must be reconsidered. Firstly, any improvement to urban sanitation implies drastic change to the existing condition; secondly, this change must follow a “master plan” model; thirdly, the goal is to dispose of, or get rid of, the human waste.

Over the years, as sewerage has become synonymous with sanitation, it has been assumed that improved sanitation implies drastic change. It is probably for this reason that so little literature has been identified dealing with indigenous excreta disposal practices — it has been assumed that these are of little importance as they will eventually be replaced by sewerage. As a result, the potential for upgrading existing practices has been largely ignored, although there is a project for maintaining urban cesspools in Jakarta (2103) for over 1 million people who could simply not afford sewerage. It is important to recognize that any improvements to existing waste-disposal practices are first steps to improving urban sanitation.

The key device of such endeavours is the master plan, and the implementation usually follows a planning construction model that may last 20-30 years. Sewerage is seen as a frozen, once-and-for-all solution, and often the same attitude is applied to other waste-disposal options, but it would be a mistake to assume that the conventional master plan model can be applied to the on-site or cartage options. For example, the master plan model was applied to aqua-privies in Botswana where they were mass produced and installed on a very large scale. The results were disastrous (2301).

The process of adaptation rather than adoption has important ramifications for the way that urban waste-disposal systems are implemented. It implies a dynamic process of problem solving; a model might be the housing sector, in which designs are continually adapted to local conditions, and the scale of planning is very much reduced, even though the aggregate of a number of years production may be significant. It is obvious that the developmental model puts the emphasis on local problem solving and that there is consequently less need for international expertise.

Neither sewerage nor conventional sewage treatment are answers to the question of how to make use of the nutrients in human excreta. If any of the reuse technologies that have been described herein are to have application, it is clear that they must be rephrased. Increasing costs of energy and other resources require that options be evaluated on the basis of reuse capability rather than disposal capability. Reuse of night soil in farming is a traditional practice. Reuses of excreta in fish culture, algae production, and aquatic plants / energy production are new and promising technologies that radically change the context of urban sanitation.

We believe that a new approach to urban sanitation, based on a step-by-step upgrading of existing situations, will have no difficulty in

identifying suitable options. Once existing conditions are understood as a starting point, certain solutions will be more compatible with resources available. Particular options will integrate reuse possibilities that reflect energy, food, or agricultural needs of the particular community. Whether or not such solutions lead ultimately to waterborne sanitation is less important than the fact that they will be the beginning of a dynamic process of development.

Part II

State of the Literature

This technology review is supported by an abstracted bibliography of references that are the result of an intensive literature search lasting several months. It was the purpose of this search to identify specific technical literature that could form the basis for a planner, engineer, or decision-maker in a developing country to understand, evaluate, and implement specific technologies. The inappropriateness of conventional wastewater technologies for solving the sanitation problem of the urban and rural poor in a developing country has been pointed out in the technology review and though many national governments and international organizations appreciate that different approaches to waste disposal must be adopted, nonconventional wastewater and excreta-disposal technologies are, by definition, less well known and less well documented. It is the aim of this technology review to begin to fill in some of the gaps, and to facilitate access to valuable technical documents that would otherwise remain obscure.

Literature Search

The unconventional structure of the literature search is an inevitable result of the subject matter being documented: nonconventional technologies. This has led to a two-pronged investigation: a rationalized *computer search* of a number of very large, internationally available data bases, and an ad hoc *manual search* of a selected number of information centres.

A computer search was carried out by the IDRC library in Ottawa and supplemented by the National Oceanographic and Atmospheric Administration library in Washington, D.C. It was found that access to information in the data bases is not indexed for developing country needs, and hence it is not possible to retrieve literature on the basis of "low-cost," "developing country," or "nonconventional technology." The search technique that finally evolved required casting a very broad net using the subject matter "wastewater" and "waste disposal" and eliminating only obvious fringe areas such as "industrial," "nuclear," or "tertiary treatment." This produced a long list of titles that was manually sifted on the basis of title, author, and keywords to a short list. The objective at this point was to eliminate all literature dealing with waterborne sewerage, sophisticated treatment processes, as well as documents judged to be of purely regional interest (economic studies, environmental impact statements). The documents on the short list were acquired, and after reading, the final choice was made. The criteria for this final choice were threefold: the document should be technical in nature and contain data that would be useful either for evaluating or implementing a

technology; the document should deal with nonconventional methods of collecting, treating, and reusing human waste; the third criterion was the most important, and the most elusive: the document should deal with a “level of technology” that is appropriate to the needs and resources of a developing country. This third criterion places more stress on labour intensiveness than on automation, emphasizes low capital cost, and takes into account differences in standards of living. Most of all it places the accent on documents that describe experiences in a developing country. The results of the computer searches are summarized in Table 2.

Table 2. Results of computer searches for documents relevant to the study.

Data base	Long list	Short list
U.S. National Agricultural Library (AGRICOLA)	2023	148
Aquarius	—	—
Biological Sciences Information Service (BIOSIS)	1487	86
Congressional Information Service (CIS)	—	—
Computerized Engineering Index (COMPENDEX)	3321	125
Environmental Data Base Directory (EDBD)	—	—
Environmental Information On Line (ENVIROLINE)	3316	29
Information Service in Mechanical Engineering (ISMEC)	146	4
Instructional Resources Information Systems (IRIS) on water quality	2150	11
National Technical Information Service (NTIS)	2669	50
Pollution Abstracts (PAB)	1253	182
Science Citation Index (SCISEARCH)	1543	72
Congressional Research Service (SCORPIO)	—	—
Solid Wastes Information Retrieval System (SWIRS)	—	—
Selected Water Resources Abstracts (SWRA)	2788	20
Total	20 696	727

Out of the 727 titles, approximately 240 were relevant; however, a second screening, eliminating documents of marginal importance and overlapping data, yielded a final choice of 188 references for the Bibliography. It is not surprising that the data bases do not provide a large amount of references on nonconventional wastewater technologies. Most data bases are, after all, enterprises that reflect the information requirements of their clientele, which are universities, engineering firms, and government agencies in North America and Europe. As a result more than 99% of the published literature on wastewater is of no practical value to the urban and rural poor in the developing countries. “Published” as used here means published in a form readily available to the international reader. This study has shown that valuable technical literature is in fact published as studies and reports, which tend to be hard to acquire.

The ad hoc manual search was carried out by eight external consultants engaged by the World Bank. The criteria used for selection were essentially those used in making the final choice in the computer search. In many cases the consultants are recognized experts in a related technical field. The information centres visited by the consultants are summarized in Table 3.

Table 3. Information centres visited by consultants for manual searches.

Asian Institute of Technology (AIT), Bangkok, Thailand
Bureau central d'études pour les équipements d'outre-mer (BCEOM), Paris, France
Centro de Investigaciones Multidisciplinarias en Desarrollo Rural (CIMDER), Cali, Colombia
Centro Panamericano de Ingeniería Sanitaria y Ciencias del Ambiente (CEPIS), Lima, Peru
Department of Civil Engineering, University of Dundee, U.K.
Empresa de Saneamiento de Lima (ESAL), Lima, Peru
Fish and Aquaculture Research Station, Dor, Israel
Instituto Nacional para Programas Especiales de Salud (IMPES), Bogota, Colombia
Israel Engineers and Architects Association, Tel Aviv, Israel
Israel Oceanographic and Limnological Research Library, Haifa, Israel
Ministère de la coopération pour l'Afrique, Paris, France
National and University Library, Jerusalem, Israel
National Environmental Engineering Research Institute (NEERI), Nagpur, India
Ross Institute of Tropical Hygiene, London School of Hygiene and Tropical Medicine, London, U.K.
Royal Institute of Technology, Stockholm, Sweden
Secrétariat des missions d'urbanisme et d'habitat (SMUH), Paris, France
Technion-Israel Institute of Technology, Haifa, Israel
Tel Aviv University, Tel Aviv, Israel
University of Technology, Loughborough, U.K.
World Bank (IBRD), Washington, D.C., USA
World Health Organization, Geneva, Switzerland

Selected documents have been provided by the U.S. Agency for International Development (U.S. AID); the National Institute for Water Research (NIWR), South Africa; and the WHO-International Reference Centre for Community Water Supply, The Hague.

Unfortunately, this is a short list indeed, as exigencies of time, personnel, and budget preclude personal visits to information centres in all regions,

notably Africa and the Middle East. Nevertheless, the project team is confident that this bibliography represents the most comprehensive collection of documents on the subject of waste-disposal technologies for developing countries that has been available to date. It is hoped that it will form the basis for a data base in this important but neglected field.

The external consultants had a copy of the short list to minimize duplication. The documents identified by the consultants differed from the computer-retrieved documents in a number of respects. The computer search was limited to documents published from 1970. The consultants were not under this restraint, and selected a number of useful older documents. Some of the documents identified by the consultants are undoubtedly in the computerized data bases but were missed by the initial broad search due to anomalies of indexing. About 35% of the manually retrieved documents are unpublished reports, field studies, or unpublished papers. Of the total 531 references in the bibliography, 121 (23%) are unpublished documents (Table 4).

Table 4. Source of document retrieval, both published and unpublished.

	Unpublished	Published	Total
Computer search	—	188	188
External consultants	82	152	234
World Bank reports	17	—	17
Additional literature	22	70	92
Total	121	410	531

The final bibliography includes the documents retrieved by the computer search, those provided by the external consultants' ad hoc manual search, a number of World Bank Appraisal Reports, as well as additional literature, both published and unpublished, that was identified by the team during the course of the project.

The subject of waste disposal is correctly linked to that of water supply, the assumption being that whoever takes care of one will take care of the other. The experience of this study has been that most information classified under "water supply and waste disposal" deals almost entirely with the former and hardly at all with the latter. Information on waste disposal / reuse tends to be concerned with public health, engineering, biology, town planning, and medicine, and careens wildly across institutional boundaries. As a result, no organizations were identified during this study that effectively document, coordinate, and disseminate information on waste-disposal / reuse technologies, either nationally or internationally. The fact that nowhere was there a comprehensive listing of documents dealing with nonconventional waste disposal motivated this technology review and bibliography.

The type of literature cited in the bibliography is varied. It includes, in addition to journal articles, engineering master-plan reports, pamphlets,

feasibility studies, governmental reports, and papers from international, national, and academic institutions. As in so many fields most research is going on in the richer industrial countries; nevertheless, 37% of the references in the bibliography originate in developing countries, and an additional 18%, although originating in Europe or North America, deal specifically with conditions in developing countries. The balance of the literature, 45%, originates in the industrially developed countries, but is considered relevant to conditions in developing countries.

Literature

There is generally very little data on *deposition*, and though designs for water-seal toilets and squatting plates are often described, little is reported of actual experiences. It seems likely that deposition devices play a key role in public health, and work needs to be done to improve designs, based on field surveys. Solutions to deposition are often local in character, and if documented, which they seldom are, could be adapted from one region to another.

The literature on *on-site collection and treatment* tends to focus on the septic tank, which is widely used in the United States, but not generally appropriate to a developing country for reasons of cost. The much more adaptable pit latrine tends to be ignored, and little serious scientific work has been done on this simple technology since the 1930s. Two questions in particular need elaboration: how the operation of the pit latrine could be improved to overcome problems of flies, smell, and cleanliness; and how the nontechnical aspects of rural latrine programs contribute to their success or failure. Most of the literature assumes the latrine to be a purely technical problem, though it is clear that “fecal sociology,” a yet-to-be-born science, plays a key role in rural, and also urban, sanitation programs. Most of the literature takes for granted that privies are a rural solution, ignoring the fact that for many urban slum dwellers they have been, and will continue to be, the only affordable solution. A large gap exists in the literature when it comes to the question of urban pit latrines or composting toilets — how can they be improved and upgraded, what are the risks (tolerable or intolerable) and limitations?

The literature on *collection and off-site treatment* tends to focus on sewage treatment for developing countries, while ignoring the fact that sewerage serves such a small fraction of the population. Consequently, the subject of stabilization ponds is thoroughly documented by researchers in both developed and developing countries, though the method of getting the excreta to the pond remains unexamined. Not enough operating data are known concerning truck collection, even though this system is quite widely used. Extremely little data are reported on the various cart and night-soil conservancy systems that are practiced throughout the developing countries, even though these form the backbone of existing urban waste disposal.

The *reuse* of treated sewage and sludges is well documented in Western literature with regard to irrigation and aquaculture, both in hot and temperate climates. However, the use of night soil, which is so widely practiced in fertilization and fish culture, is virtually ignored and little data are reported on actual practices. Biogas technology is well described, particularly in the Indian literature.

The characteristics of *greywater* have only recently been studied in the industrial countries and data are not extensive. Nothing has been reported from a developing country in this area.

A number of *water-saving* techniques are described in the Western literature that might have application, particularly in areas with water supply problems. Even though the population served by sewers in developing countries is small, their proportion of water consumption is so high that water-saving measures could play an important role.

In general, this technology review has found that the differences in climate, socioeconomic conditions, and the sheer scale of the problem make it difficult to apply technical data from an industrial country directly to conditions in a developing country, even when the data are of a "scientific" nature. This is particularly true with respect to nonconventional waste-disposal technologies. The influence of conventional Western research in wastewater collection and treatment on attitudes in most developing countries cannot be overestimated. Wastewater research, even when it is going on in a developing country, in many cases follows Western models and turns its back on local traditions and practices. The result is that very little is known about what is actually going on. Any attempt to upgrade or improve the existing situation, and this is surely the only strategy that has any chance of success, will have to be based on sound understanding of existing resources, limitations, and possibilities.

Part III

Subject Scope and Contents of Bibliography

This bibliography is comprised of technical documents that describe experiences and contain data useful in the evaluation or implementation of a technology related to human excreta and wastewater disposal. The coverage includes nonconventional and conventional methods of collecting, treating, and reusing wastewater and human excreta. Emphasis has been placed on low-cost, labour-intensive technologies appropriate to the needs and resources of rural and peri-urban areas. Sophisticated treatment processes and related “industrial” and “nuclear” technologies are therefore not covered. Also excluded are documents of purely regional interest such as economic studies and environmental impact statements.

Each document has been assigned a unique identification number. The first two digits of this number indicate the subject category as outlined in the table of contents and the last two digits give the accession number within that category. For example, document 2204 is the fourth document accessioned describing composting privies for on-site collection and treatment.

References in the bibliography contain author's corporate affiliation, keywords, and a brief informative abstract to assist in identifying documents for retrieval. The more important documents have been abstracted in some length, which makes this bibliography useful as an information source as well as a reference guide. Standard reference texts on a subject are denoted by an open box □. Documents that the reviewers have identified as throwing new light on nonconventional waste disposal are denoted by a solid box ■.

The usefulness of this bibliography is limited if the documents and the knowledge upon which they are based are not made easily accessible. In response to the ever-increasing demand for information in this field, the Asian Institute of Technology (AIT, Box 2754) in Bangkok, Thailand, is in the process of creating an international information centre for sanitation to become operational in late 1978. Relevant material collected for this study will form the initial information base for the new information centre; documents appearing in this publication will therefore be available from AIT on request in early 1979. It is also likely that regional focal points for the collection and dissemination of relevant information materials in the field of environmental sanitation will be established, thus forming the basis for the continued exchange of information between regions.

1. Deposition Devices

1001

Blair Research Laboratory, Salisbury, Rhodesia
Sanitation and hygiene in rural areas. Unpublished report. 11p. 1974.

The problems of inadequate rural sanitation are reviewed and standard solutions discussed. It is felt that an adequate seal reduces the fly and odour problems. A mechanical self-flushing water-seal privy system (Watergate) is proposed that requires very little water to operate (1 litre per visit) and is durable and nonclogging.

rural; pit latrines; water-seal privies; design; Rhodesia; household; water saving

1002

Directorate General of Health Services, Ministry of Health, New Delhi, India
Rural latrine programme. Central Health Education Bureau Brochure, India. 19p. 1962. 4 plates. 9 figures.

This practical brochure describes the organization and implementation of rural latrine programs in India. Latrine construction is discussed as well as educational, social, and organizational aspects. Designs are provided for water-seal squatting plates.

pit latrines; squatting plates; rural; construction; design; public health; social acceptance; India; disposal

1003

Booker McConnell Ltd., London, U.K.
Introduction to Watergate. Booker McConnell Ltd., U.K. Manufacturer's sales leaflet.

The patented self-flushing and self-sealing Watergate latrine is described. Designed as a squatting plate, the unit has an integral self-tipping pivoted pan that operates automatically when excreta are deposited on it; water or sullage is then admitted under low pressure into the pan to remake the water seal.

excreta; water-seal latrines; self-flushing

1004

Directorate General of Health Services, Ministry of Health, Government of India, New Delhi, India

Sanitary methods of excreta disposal in villages. Directorate General of Health Services, Ministry of Health, Government of India, New Delhi, India. 8p. 1955. 4 drawings.

This pamphlet describes methods for fabricating and installing water-seal squatting plates over pit latrines. The squatting plate is cast from concrete in a sheet metal and wooden mold that is also homemade. The water seal prevents odours from leaving the pit and keeps flies and mosquitoes from the fresh feces. It

requires about 0.5-1 gal (4.546 litres) to flush the water-seal trap.

India; rural; water-seal latrines; design; construction

1005

Bhaskaran, T. R.
All-India Institute of Hygiene and Public Health, Calcutta, India

A decade of research in environmental sanitation (1951-1960) latrines for rural areas. India Council of Medical Research, India. Special Report No. 4. 67p. 1962. 1 photograph. 6 tables. 2 diagrams.

A report of work to evolve an improved pan and trap for pit latrines. Details of construction and cost are given. Ten different types of lining for pit latrines in waterlogged ground were tested and compared. Four designs of septic tanks were found suitable for rural areas with respect to removal of suspended solids, biological oxygen demand (BOD), and helminths.

pit latrines; India; helminths; septic tanks

1006

Bopari, M. S.
Varma, R. N.
(Both) Office of the D.G., A.F.M.S.*, Ministry of Defence, New Delhi, India

Proceedings of symposium on environmental pollution. Central Public Health Engineering Research Institute (CPHERI — now NEERI), India. 244-254. 1973. 3 figures. 2 references. 1 appendix. Discussion.

A review of waste-disposal methods adopted in the field by the Indian Armed Forces. A deep-trench latrine, a water-seal latrine, and a field hand-flush latrine are described with dimensional drawings and their advantages and disadvantages compared. The hand-flushed pan connected to a detached covered pit or located over a deep trench, in either case with water sealing, are now preferred for military use in India.

rural sanitation; field sanitation; trench latrines; water-seal latrines; India; squatting plates

1007

Langshaw, C. L.
Sanitation in the British West Indies. Journal of the Institution of Sanitary Engineers, U.K. Vol. 51. 82-109. 1952. 7 photographs. 6 diagrams.

This paper describes the work of the public health engineering unit of the Windward and Leeward Islands 1944-1950. The unit was set up to train local personnel. Work on low-cost housing, water supply, storm drainage, malaria control, and refuse collection is described. Improvement of latrines was an important function. Standard precast concrete box seats, squatting slabs, etc. were made for pit and borehole latrines. Details are given of household aqua-privies and public latrines.

British West Indies; sanitation; pit latrines; aqua-

privies; storm drains; septic tanks

1008

Morgan, P.

Booker McConnell Ltd., London, U.K.

A new self-flushing toilet for use in rural latrines. Submitted for publication in American Journal of Tropical Medicine and Hygiene. USA. 10p. 4 references.

■ A self-flushing squatting plate, the "Watergate," has been designed specifically for people living in rural areas. The device consists of three basic parts: a chute and squatting plate; a swivelling pan mounted at the base of the chute; and a valve that regulates the level of water in the pan. The pan is pivoted and counterbalanced so that it holds approximately 3 litres of water to form a seal around the lower rim of the chute. The addition of excreta and water causes the pan to tip its contents into the pit. It then returns to the resting position and refills with water. The device normally flushes once during two visits. The first prototype was tested in August 1973, and both the pivot and the valve, the only moving parts, have withstood considerable abuse. A rural installation, which was inspected daily for over 16 months, showed that water consumption per visit varied between 1.29 and 1.11 litres. It is felt that an advantage of this system is that the pit latrine is turned into a "septic pit" by the continual addition of small quantities of water. The presence of water promotes digestion and also increases exfiltration, thus prolonging the life of the pit. Based on actual experiences, it is concluded that simplicity of operation is a distinct advantage, and the lack of flies and odours significantly improves the traditional pit latrine.

excreta; latrine design; water-seal toilets; pit latrines; self-flushing

1009

Muhondwa, E. P. Y.

Department of Sociology, University of Dar es Salaam, Tanzania

Latrine installation and use in Bagamoyo District ... a study of sociological factors. Thesis for a Master of Arts in Sociology, University of Dar es Salaam, Tanzania. v-75p. June 1976. 26 references.

■ This study is about the social phenomena of peasants' reluctance, if not objection, to building and using latrines. The observations are based on a 2-month stay and formal interviews and surveys of 60 households in a village where a state program of rural latrine building was underway with varying degrees of success. Although two-thirds of the households had built latrines (mostly under compulsion), a high incidence of abuse or nonuse of latrines was found. The health benefits of latrines are not sufficiently understood by the peasants, and the connection between hookworm and insanitary latrines is often not acknowledged. Another serious reason for nonacceptance is traditional etiquette that sees defecation as a rather shameful activity, which more properly should go on in the bush. There are also certain technical

difficulties that are seen to discourage latrine use. Soil conditions require shoring of the pit and since lumber is not available this is often done with small sticks, the result being pit collapse. Cleansing after defecation is by ablution, and since the floors of the latrine are usually earth, poor environmental conditions result, as well as weakening of the squatting plate. In addition, smelly and unpleasant interiors further discourage adoption of "localized" defecation, and peasants revert to traditional practices.

latrines; Tanzania; social acceptance; excreta disposal

1010

Ross Institute Industrial
Advisory Committee

London School of Hygiene, and Tropical
Medicine, London, U.K.

Rural sanitation in the tropics. The Ross Institute Information and Advisory Service, U.K. Bulletin No. 8. 7-17 and 29-32. April 1972. 1 table. 14 figures. 7 references.

Family and communal waterborne latrines (cistern-flushed and pour-flush types) are described. These systems, which are recommended for locations having sufficient water supply, require from 3 to 10 gal (13.64-45.46 litres) per user and their effluent can be discharged to either septic tanks or seepage pits. Methods of operation and maintenance of the latrines are also discussed.

pour-flush latrines; septic tanks; seepage pits; maintenance; community; public toilets

1011

Sikkema, A. V.

Asian Regional Institute for School Building
Research, Colombo, Sri Lanka

Sewage disposal for rural schools. Building for Education, Asian Regional Institute for School Building Research, Technical Note No. 6, Sri Lanka. 15-20 1972. 6 diagrams. 2 tables.

A practical guide to the design and installation of squatting plates, septic tanks, absorption trenches, and seepage pits for communal toilets in rural areas is given. The relationship between adequate sanitation and water supply is discussed, and the importance of social customs with respect to proper use of sanitary facilities is pointed out.

septic tanks; construction; design; infiltration; community; rural; absorption trenches; seepage pits; public health; squatting plates; water supply; public toilets; Sri Lanka

1012

Stanbridge, H. H.

History of sewage treatment in Britain. I. Introduction of the water carriage system. Institute of Water Pollution Control (publishers), U.K. Chapter 1, "Introduction of the Water Carriage System." 1-16. 1976. 11 figures.

□ Chapter 1 reviews sanitation practices in England

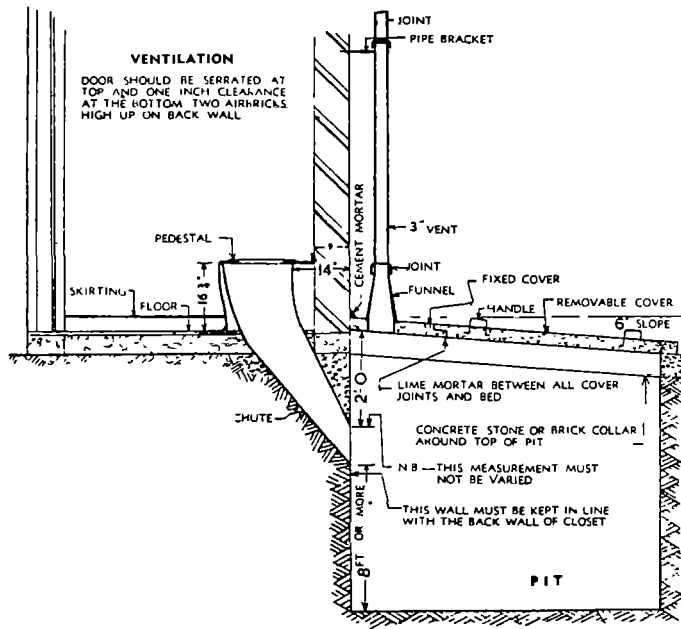
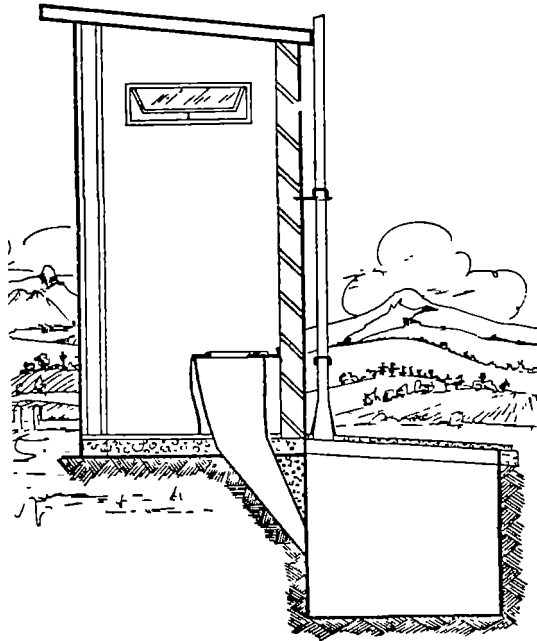

The R.O.E.C. latrine (from 2101).

before the introduction of waterborne sewerage in the mid-19th century; these included middens, water closets connected to cesspools, simple privies, pail conservancy systems, earth closets, and "slop-water" (sullage) closets, the last mentioned being for use by the working class in water-scarce areas.

England; historical aspects; middens; pit latrines; earth closets; cesspools

1013 Thakor, V. H.
Health and Medical Services, Gujarat State,
Ahmedabad, India

Bavla type rural latrines. Papers for Seminar on Environmental Health Problems of Ahmedabad, Civil Engineering Department, L.D. College of Engineering, India. B-4-1 - B-4-6 1972. 1 appendix.

Brief review of a water-seal latrine program in Gujarat State includes details of latrine design and gives numbers of latrines installed between 1963 and 1970.

rural sanitation; India

1014 Watt, S. B.
Intermediate Technology Development Group,
London, U.K.

Village sanitation improvement scheme, India. Appropriate Technology, U.K. 3(4). 5-6. 1976. 1 diagram. 2 photographs. 3 references.

This article gives detailed instructions for the construction of a water-seal latrine with soakage pit, as provided in a village near the National Environmental Engineering Research Institute (NEERI), India.

water-seal latrines; India; rural sanitation

1015 Kira, A.
Cornell University, Ithaca, N.Y., USA

The bathroom. Centre for Housing and Environmental Studies, Cornell University, School of Architecture, Research Report No. 7, 59-80. 1966. 1 table. 16 figures. 21 references.

The process of defecation is studied from an anatomical point of view. An analytical study of modern water closets and urinals is made, and it is determined that biologically, the squatting position is better than the normal Western sitting-down position for defecating. Anthropometric data on both sexes is synthesized and after considering daily clothing habits, etc., new designs for semisquatting toilets are proposed. Similarly, a design for a household urinal also is developed.

design; flush toilets; squatting plates; urinals

1016 Morgan, P. R.
de V. Clarke, V.

(Both) Blair Research Laboratory, Salisbury,
Rhodesia

Recent developments in rural sanitation. Sanitation in Developing Countries Today. A conference sponsored by OXFAM with the Ross Institute of Tropical Hygiene, 5-9 July 1977, Pembroke College, Oxford. 3 figures.

Three kinds of toilets developed at the Blair Research Institute in Rhodesia are described. the Watergate self-flushing toilet, the vented pit privy, and a flood-through system. When appropriately used with excreta-disposal systems, these three systems have considerably improved rural sanitary conditions.

rural; hygiene; Rhodesia; self-flushing; pit-latrines

1017 Rajagapalan, S.
Shuffman, M. A.

Department of Environmental Sciences & Engineering, School of Public Health, University of North Carolina, Chapel Hill, N.C., USA

Guide to simple sanitary measures for the control of enteric diseases. World Health Organization, Geneva. 41-42. 1974. 1 figure.

The authors describe construction of a bucket latrine. A checklist is provided to ensure proper building of a small conservancy system. A few tips are given on how to run a bucket latrine and on night-soil disposal.

conservancy systems; bucket latrines; night-soil disposal

2. On-Site Collection and Treatment

2.1 Pit Latrine

2101

Bestobell Engineering (SA) Ltd./Bpk., Durban, South Africa

R.O.E.C. sanitation. Patent No. 991/1944. Bestobell Engineering (SA) Ltd./Bpk., South Africa. 11p. 11 figures.

These instructions cover the installation of both the pedestal and squat types of a composting toilet system, the principles involved being the same but fittings slightly different. Construction of a urinal system for men is also described. Each closet of the toilets and urinal, which is water-tight, works independently with its own ventilator shaft. These systems are reported to provide satisfactory results, as they are odourless and free from flies.

composting toilets; installation; urinals; construction

2102

Central Public Health Engineering Research Institute (CPHERI — now NEERI), Nagpur, India

Evaluation of rural latrine design. Proceedings of a

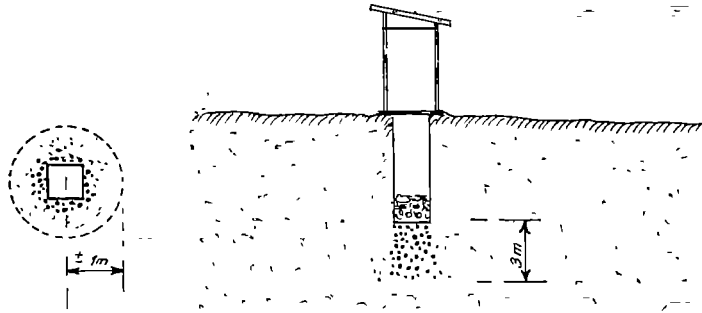

Movement of pollution in dry soil from the pit privy (from 2108).

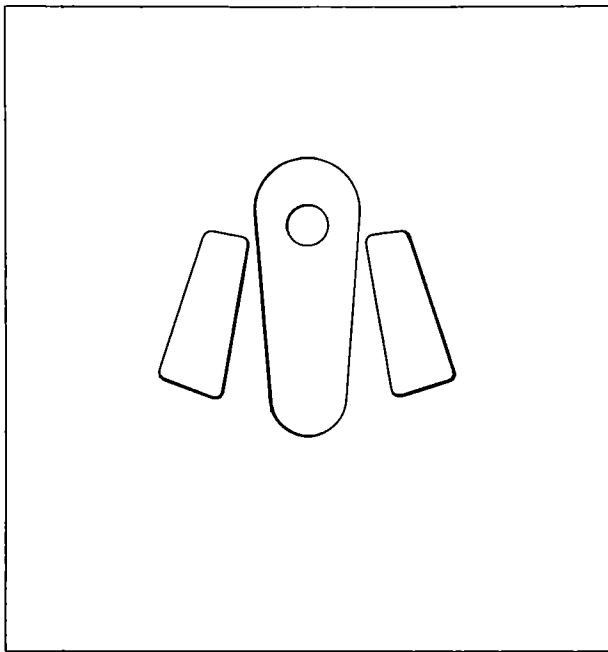

Plan

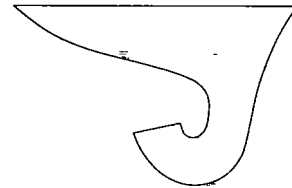

Elevation

Water-seal pan.

symposium held at CIPHERI, India on October 28, 1964. About 190p. A compilation of 21 papers including numerous figures and tables.

The use of sanitary latrines is the only economical satisfactory method for excreta collection and disposal to effectively deal with the harmful parasites and infections present in human feces. The problems of rural sanitation in India have been recognized and are considered of vital importance for the improvement of national health. These reports deal extensively with methodology of rural latrine design, its criteria, methods of construction, operation, and maintenance. Nine types of deposition devices (pans) designed for rural uses in India are described along with various types of pits for disposal of night-soil. The pan shape is suggested to be smooth without sharp corners to collect the night-soil material. Then, physical comforts of seating during use should determine the top shape and dimensions of the pans rather than any arbitrary designs. A pit design can generally be classified as a circular or square pit with vertical walls and some supporting masonry in mud or cement mortar with brick work and a suitable cover. Factors affecting the pit designs include its volume to retain the sludge and infiltration capacity of the soil to absorb water. The shape of the pit also plays an important part in its durability and prevention against collapse, and the conical design with apex toward the bottom appears to be more suitable for all general purposes, but it results in reduced capacity. Special design for collapsible soils is considered a must for good latrines. Other papers address some aspects of rational design of latrine superstructure, economics of latrine installation, use of pit contents as fertilizer, social acceptance of latrines, and pollution aspects of night soil affecting rural water supply. Dissemination of the available data has led to conclusions that installation of latrines in rural areas is a safe and economical means of excreta disposal provided that proper design, construction, operation, and maintenance of the latrines are well carried out. Many useful schematic diagrams of how to construct the deposition devices, pits, and superstructures are also included.

India; latrine design; rural; construction; maintenance; deposition devices; pit latrines

2103

Nihon Suido Consultants Co. Ltd., Tokyo, Japan

Immediate programme for sanitation for kampung improvement programme of Jakarta. In "Jakarta Sewerage and Sanitation Project, Indonesia." A report prepared for the Government of Indonesia / WHO / UNDP, Project 1NO-P1P-00Z (INS / 72 / 068). Draft. 1977. Vol VII. Comprises about 250p.

■ This report summarizes an analysis made in 1975-77 of sanitation improvements made in 88 kampungs, i.e., low income-high density native village communities with an aggregate population of about 1.2 million, included within the metropolitan Jakarta area. The sanitation improvements were made as part

of an overall slum infrastructure improvement program, called "KIP Pelita I," carried out by the Municipality of Jakarta over the period of 1969-74. The sanitation improvements, comprising about 30% of the total program, included improvements in: (a) water supply through installation of public taps, (b) facilities for water utilized for hygienic purposes (drinking and cooking, washing, bathing, toilets); (c) waste disposal; (d) surface drainage; and (e) solid waste handling. With respect to disposal of excreta from toilets (mostly water-seal type), it was found that provision of piped sewers will hardly be affordable in the foreseeable future but reasonably satisfactory disposal can be achieved very economically by use of cesspools, despite the high groundwater and poor soil leaching conditions prevalent in much of the area, *provided* that service is made available for periodic pumping out of the cesspools at a frequency ranging from a few months to 2 years, depending on groundwater soil-loading conditions. The cost of such a service is readily affordable by low-income families, and the total cost of this solution is small compared to septic tank / leaching systems. A second key feature in the village waste-disposal picture is the role of the paved surface drains furnished by the program. For these to be operative for removing sillage including kitchen wastes, and not to be used for trash disposal, the ditches must be periodically cleaned by crews responsible to the village headman. Also, these drainage ditches discharge to the local rivers, and their dry-weather flow will be intercepted by a system of sanitary sewer interceptors planned to be located along the rivers under the master sewerage plan. Also, for lower low-income families in the kampungs with *own* home toilet facilities, a system of communal toilet-washing-bathing stations has proven successful if within ready walking distance of intended users and provided arrangements are made by the village headman to recruit and support a station operations manager who will maintain cleanliness, and that when cleanliness is maintained the stations are used and the users are willing to pay fees sufficient to finance the maintenance costs. A program of work is recommended that would further upgrade the improvements built by the city to achieve an overall system meeting minimum desirable standards applicable over the next several decades. A pilot program including quantification of the socioeconomic acceptance of the improvements is proposed to demonstrate the feasibility of the recommendations at four selected kampungs before undertaking the full-scale program.

Indonesia; sanitation; pit latrines; greywater; public toilets

2104

Port Moresby Office, Division of Building Research, CSIRO, Boroko, Papua New Guinea
Proceedings of the seminar on sewage disposal in urban development (with particular reference to low-cost housing). Papua New Guinea. 67p. July 19, 1971.

Six papers were presented at this seminar, mainly dealing with waterborne sewerage systems and their advantages in terms of health and convenience over other forms of sanitation. One paper, however, draws attention to the widespread use of pit latrines and open defecation in areas of traditional urban housing. In another paper the use of septic tanks in urban areas is discouraged. Instead it is recommended that the effluent should be discharged into a percolation trench laid in the middle of the adjacent access road, and the pipe in this trench should be the same size as a conventional sewer. This "septic pipe" can eventually be used as a sewer proper, discharging into a waste stabilization pond.

sewage treatment; Papua New Guinea; industrial wastewater; excreta; stabilization ponds; septic tanks social acceptance; economics; single houses

2105

Housing Research and Development Unit, University of Nairobi, Kenya
Prototypical sewage disposal system design for small low cost housing schemes on deep black cotton soil. Unpublished preinvestment interim report, Housing Research and Development Unit, University of Nairobi, Kenya. 13p. April 1973. 5 appendices.

A description of sanitation systems suitable for semirural housing groups of approximately 10 dwellings is given. Dry sanitary systems are considered appropriate where constant water supply cannot be assumed. Semiwet systems are proposed for dry climate conditions when water supply is reliable. Water is evaporated in a top soil-layered vegetation bed. Wet sewage disposal linked to oxidation ponds is also described.

Kenya; rural; waste-disposal systems; arid climates

2106

VITA, Mt. Rainier, USA
Village technology handbook. VITA Publication, USA. 147-181. January 1975. 19 figures.

This handbook contains a description of sanitary latrines for developing countries with special emphasis on water-seal privies that have been in practice in the Philippines and Thailand. Details of construction techniques are included, such as how to make the mould, the bowl, and install the toilet etc.

developing countries; water-seal latrines; Philippines; Thailand; construction

2107

Baars, J. K.
National Health Research Council, The Hague, Netherlands

Travel of pollution, and purification en route, in sandy soils. Bulletin of the World Health Organization, Switzerland. Vol. 16. 727-747. 1957. 9 references. 7 figures. 4 tables.

The travel of pollution in sandy soils and the extent to which purification takes place en route are discussed. Two types of soil pollution are considered: (a) severe pollution of the surface layers with matter concentrated in a small volume of water (e.g., pit privy); and (b) moderate pollution of the surface layers with matter contained in large quantities of water. It is shown that in both types self-purification is sufficient to prevent contamination of groundwater, provided that the soil is fine and — in the case of pit privies — dry and well aerated, and provided that the water table is not too high or the rate of infiltration too great.

pit latrines, Netherlands; sand; infiltration; subsurface disposal; soil pollution

2108

Caldwell, E. L.
Alabama State Dept. of Health, Andalusia, USA

Studies of subsoil pollution in relation to possible contamination of the ground water from human excreta deposited in experimental latrines. Journal of Infectious Diseases, USA. Vol. 62. 272-291. 1938. 7 figures. 6 tables. 6 references.

□ This is a report of a 6-month study on the effects of pollution from human excreta deposited in experimental pit latrines located in unconsolidated soils above the water table. The general observations show that intestinal organisms are confined to the vicinity of the pit unless transported by water flow, and furthermore this transportation is generally downward with gravity flow, in previous soils. Hence, in a pit receiving only excreta, seepage of fecal organisms extended less than 1 ft (30.48 cm). In a similar pit with vain seepage, organisms were carried less than 4 ft (121.92 cm) below the pit. Another pit that received 100 gal (454.6 litres) of water daily showed a deeper penetration of fecal matter, but less than 7 ft (2.7 m) down. In all three cases lateral penetration was less than 1 ft. It was observed that lateral carriage did occur if soil conditions at the bottom of the pit impeded penetration. The results of the test demonstrate that in all moisture conditions not only is there a limit to the depth of penetration, but sooner or later, a regression of the bacterial stream occurs. The uniform mantle of contents at the bottom — fecal mass or sludge — serves also to retard penetration of fresh organisms and the clogged sands constitute an impervious, or semi-impervious, layer constantly increasing in thickness. The intestinal bacteria die off at a faster rate than the fresh supply, and there is a steady regression back toward, and sometimes into, the pit.

pit latrines; pollution; groundwater; household; sandy soils; gravity flow; lateral flow; pathogens; excreta

2109

Campos de Carvalho, M. E.
Direccas de Servicos de Urbanismo e Habitacao de Ministerio de Ultramar, Angola

Contribucao para a resolucao de saneamento de aguas negras em agrupamentos de economicamente debéis. (A study of sanitation systems for low income people.) Segundas jornadas de Engenharia e Arqintectura de Ultramar, Angola. Vol. 5. Paper 118. 290-310. May 26-31, 1969.

A description of a number of sanitation systems of various complexities for low-income people is given. The choice of system is based on the availability, or absence, of running water. Ventilated pit latrines and borehole privies use no water. Collective aqua-privies are reported to need close supervision for adequate operation. Individual septic tanks are also described. (Original paper written in Portuguese.)

Angola; pit latrines; septic tanks; communal latrines; design; water

2110

Coffey, K.
Reid, G. W.

(Both) Bureau of Water and Environmental Resources Research, The University of Oklahoma, Norman, Oklahoma, USA

Historic implication for developing countries of developed countries, water and wastewater technology. A report published by the Office of Research Administration, University of Oklahoma, USA for the U.S. AID. 183p. December 1976. 8 tables. 34 figures. 56 references.

The thought behind this report throughout its preparation was that certain lessons could be learned from past developments in the technology of water handling and usage in developed areas that might be of benefit in accelerating progress in improvements in this field in the developing areas. Information from less-developed regions was included in certain instances where it seemed of interest. The general purpose was to show that certain historically used techniques in developed regions might be applicable today in less-developed areas. The idea was to find historical evidence of alternatives for those less-developed regions. The first section comprised an inventory of historically used techniques, together with associated health conditions when possible. It was mentioned in connection with this section that it was difficult in many instances to determine the actual data, place, or originator of an invention, since often a series of ideas of only partial results can eventually lead to a successful conclusion. In addition, it was noted that inventions or patents are often in existence long before the item is actually put into use. The second section contained a description of the chronological development of water usage and handling, first in Great Britain, particularly London, and also in the United States, these being the two areas for which the most complete information was available. In the last section an attempt was made to describe life-style levels as a chronological concept in the developed areas. In addition, levels of technology were developed as a chronological concept. Finally, an attempt was made to tie historical technology levels to the life-style levels. A time scale was developed for the

principal historical regions covered by the inventory. Each regional scale was correlated with the other regional scales as well as with the chronological scales of technology levels and life-style levels.

developing countries; historical aspects; technical; sewage treatment

2111

Handa, B. K.
Panickar, P. V. R. C.
Kulkarni, S. W.
Gadkari, A. S.
Raman, V.

(All) National Environmental Engineering Research Institute, and Governmental Medical College, Nagpur, India

An integrated approach to rural sanitation towards better health. Unpublished report. 14p. 1977. 5 tables. 4 figures. 5 references.

A rural sanitation pilot project looking into the health effects of sanitary latrines, protected water supply, health education, and specific drug treatment in 10 villages near Nagpur reports that the whole population (793) of one village had their stools, blood, and clinical history examined. Twenty-five percent of the people in five other villages were examined for base-line health conditions. Hookworm was the most prevalent infestation and deworming medicine was administered in one village. After latrines and protected water supplies have been in use by the majority of the population, stool and blood samples will be examined over a period of time to record the impact of rural sanitation on health.

rural sanitation; latrines; health; India; hookworm

2112

Hardenbergh, W. A.
Jefferson County Board of Health, Alabama, USA

Home sewage disposal. J. B. Lippincott Co., USA. Part 2 (Chapters 5-10) "Sewage Disposal for Unsewered Sections." viii. 274p. 1924.

□ The need for sanitation for areas not reached by sewers is emphasized. These chapters describe an early American experience (before 1924) in household sewage disposal with particular reference to on-site waste-disposal systems. The earliest known form of sanitary privy is the pit. For an average privy for one family, with one or two seat holes, design of the pit should be 36-44 inches (1 inch = 2.54 cm) in length, 30-36 inches wide, and 48-60 inches deep. For each additional privy seat, 24 inches should be added to the length, but no changes made in width and (or) depth to prevent groundwater pollution. Sheeting of the inside of the pit will be necessary in soils subject to caving, such as sand or loose loam. The lining should also extend above the ground surface 4-8 inches, forming a curb around which earth should be banked to prevent the inflow of surface water. Methods of pit construction and operation are described in detail and photographs of each construction step included. The

main advantages of the pit are its initial cheapness and ease of operation; among its disadvantages is the danger of water pollution and the chance of the pit acting as fly and mosquito breeding areas. The double-compartment concrete vault privy consists of a concrete box built in the ground, a central wall dividing it into two compartments, a rear wall sloped 60° to allow for easier cleaning, a seat riser, and seats on top, and the whole covered with a privy house. Each compartment, serving consecutively by turns, has a capacity of 75-100 gal (341-454 litres), or theoretically is sufficient to provide storage for the wastes of the average family for 3-6 months. Scavenging is through the rear, where a removable cover is provided. The main disadvantages of this system are high cost, difficulty in maintaining proper cleaning service, and rapid deterioration of flytightness. Odours cannot be prevented entirely but may be reduced somewhat by liberal use of dust, ashes, lime, or other absorbent material added immediately after using the privy. The box-and-can type of privy is so-called because it is essentially a fly-proof box that contains a waterproof receptacle or can to catch excreta. Scavenger service is carried out by removing the filled cans to dumping stations by single or double-deck wagons. The main problem is maintenance of proper scavenging service at regular intervals. Final disposal of the excreta can be done through burial land disposal or by dumping through sewers to the final treatment and disposal system.

sewage; excreta; household; pit latrines; bucket latrines; septic closets; aqua-privies; chemical closets; night-soil treatment; conservancy tanks

2113 Holland, R. J.
Unit costs of domestic sewage disposal in Kenya. University of Nairobi, Department of Civil Engineering, Kenya. November 16, 1973. 2 diagrams. 1 table.

The paper provides comparative costs of sanitation by bucket latrine, pit latrine, aqua-privy, cesspit, and by sewerage with conventional treatment or waste stabilization ponds. The mode of use of each method is defined. Capital costs and life and running costs are estimated and the total annual costs are presented, calculated using interest rates of 6 and 10%.

costs; sewage; unsewered system; Kenya; latrines; stabilization ponds

2114 Kharkar, C. B.
Tiwari, A. R.
Venkatesan, T. L.
Community waste water disposal with reference to labour colonies around Bhilai Township. Proceedings of Symposium on Community Water Supply and Waste Disposal, Central Public Health Engineering Research Institute, India. Vol. 2. 55-61. December 19-21, 1966. 2 figures. 1 appendix.

Methods used to dispose of wastes from camps housing construction workers around Bhilai Township

in India are reviewed. Central sanitary blocks with stand-post water supply draining through communal latrines, as flushing water, to septic tanks and drainage fields are described. Pit latrines served lower category housing, a 3½-ft diameter X 7-ft deep pit lasting a family of five for 3 years. Similar pit latrines were used as public latrines, designed for 20 users per pit to last 1 year. Borehole latrines, 15 inch diameter X 15 ft deep, were accepted by the public but trench-type latrines were not popular. Soakage pits collecting sullage water were unsuccessful and promoted mosquito breeding. The problems of at-source waste disposal are considered and costs compared but the author's preference is for wastewater collection and treatment in stabilization ponds with subsequent reuse in agriculture. A pond scheme serving a population of 12 000 is described and the per capita capital cost is given as 25 rupees.

rural sanitation; India; labour camps; communal latrines; pit latrines; borehole latrines; septic tanks; soakage pits; stabilization ponds

2115 Kouete, J. R.
Organisation de lutte contre le péril fécal dans une localité du Congo (Mossaka). (Organizing the fight against the fecal peril in a region of the Congo (Mossaka).) Unpublished report of the Para-Medical Section, École Nationale de la Santé Publique, France. 69p. 1975-76. 5 references.

A description of existing conditions with regard to sanitation in the town of Mossaka is given. The prevalence of enteric diseases is thought to be directly linked to unhygienic excreta disposal. Improved practices for the construction and use of pit latrines are described. (Original paper written in French.)

Congo; pit latrines; public health; public opinion

2116 Lech, H. H.
Oil-flushed toilets gain. Compost Science, USA. Journal of Waste Recycling. Vol. 18. No. 1. 25p.

This article describes a sanitation method that uses no water in disposing of body wastes. A colourless, low-viscosity mineral oil replaces water as the flushing media and wastes are carried to a holding tank where the oil floats to the top and the water-saturated wastes sink to the bottom where they are removed and disposed of. After filtration the oil is piped back to the toilet in a continuous recycling process.

sanitation; flush toilets; oil flush

2117 Majumder, N.
National Environmental Engineering Research Institute, Nagpur, India

Sanitation facilities for slums and rural areas. National Environmental Engineering Research Institute, India. 24p. 1975. 2 appendix tables. 15 figures.

This is a concise review of sanitation provisions for slum areas and communities including communal washing and bathroom units, communal latrine blocks, and individual household latrine units. Dimensional drawings of each type are given and estimated costs tabulated.

rural sanitation; night-soil disposal; latrines; communal latrines; slum sanitation; India

2118 Morton, S. D.
Warf Institute, Wisconsin, USA

Sawyer, E. W.
Pennsylvania Glass Sand Corp., West Virginia, USA

Clay minerals remove organics, viruses and heavy metals from water. Water and Sewage Works, USA. 116-118. 1976. 4 tables. 6 references.

Various grades of attapulgite clay, sepiolite, and an amorphous zeolite exhibit a high degree of adsorption for enteric viruses when contacted with contaminated water. The effects of contacting time on poliovirus adsorption, the effects of clay concentration on poliovirus adsorption, and the removal of organics by percolation with granular low-volatile matter are examined.

viruses; adsorption; percolation; sewage; clay; soils

2119 Pedregal, H.
Viera, J. L.

Dirección de Malariología y Saneamiento Ambiental, Oficina de Estudios Especiales, Planeación y Presupuesto, Caracas, Venezuela

Sistemas constructivos para letrinas. (Construction methods for latrines.) Centro Panamericano de Ingeniería Sanitaria y Ciencias del Ambiente (CEPIS), Peru. 23p 2 tables.

Asbestos cement, fibreglass, and tablopan are evaluated in terms of cost, availability, and labour requirements for the construction of latrines in Venezuela. Tablopan, a kind of pressed wood, was found to be the most desirable alternative for building latrines given its low cost, the reduction of the numbers of assembly parts, its weight, and time required for construction. (Original paper written in Spanish.)

Venezuela, asbestos; concrete latrines; construction; fibreglass latrines; tablopan latrines

2120 Richard, C.
South Pacific Commission, Nouméa, New Caledonia

Simple environmental sanitation on the smaller islands. South Pacific Bulletin, New Caledonia. 21-23. Fourth quarter, 1972. 2 figures. 1 table.

Rural sanitation measures are described for improving conditions in small Pacific islands. Pit latrines are seen as the first step toward eventual septic

tank and water supply installation.

rural; pit latrines; flush toilets; night-soil disposal

2121 Saldias, A.
Gutierrez, L.
Boquin, G.

(All) Universidad Técnica de Oruro, Facultad Nacional de Ingeniería, Bolivia

Manual de disposición de excretas, desagües y basuras. (Excreta, wastewater and garbage disposition manual.) Facultad Nacional de Ingeniería, Departamento de Publicaciones, Universidad Técnica de Oruro, Bolivia. 78p. 1970. 14 figures. 4 tables.

This paper is divided into three parts: the first part refers to garbage collection and disposal and presents several alternatives for it, such as land refill, incineration. The author recommends land refill as the most viable solution for developing countries where land is available. Further utilization of garbage for the production of fertilizers is highly recommended. The second part discusses the most common off- and on-site excreta-disposal systems. Design criteria for latrines, septic tanks, etc. are provided, as well as guidelines and requirements for their operation and maintenance. The last section of the paper is dedicated to reviewing the methodology for project preparation and appraisal. (Original paper written in Spanish.)

Bolivia; chemical latrines; chlorination; night-soil collection; disinfection; disposal; garbage; incineration; landfill; maintenance; septic tanks; soil pollution; pit latrines

2122 Shelat, R. N.
Mansuri, M. G.

(Both) S. V. Regional College of Engineering and Technology, Surat, India

Problems of village sanitation. Journal of the Institution of Engineers, India. Vol. 52. 21-24. October 1971. 2 tables. 2 figures. 8 references.

Current sanitation practice in Gujarati villages (up to 5000 population) is reviewed and methods for sanitary improvement are suggested. These include the conversion of pit latrines and pail latrines to pour-flush latrines connected to a brick-lined seepage pit; septic tanks to serve groups of latrines; improved containers and wheelbarrows for night soil; and, where a piped water supply is available, sewage treatment in waste stabilization ponds. The importance of community education in matters of sanitation is strongly advocated.

excreta; India; pour-flush latrines; cartage; septic tanks; sewerage; sewage treatment; stabilization ponds

2123 Subrahmanyam, K.
Bhaskaran, T. R.
(Both) All India Institute of Hygiene and Public

Health, Calcutta, India
The risk of pollution of ground water from borehole latrine. The Indian Medical Gazette, India. Vol. LXXXV. No. 9. 418-423. September 1950. 1 table. 1 graph. 4 references.

The use of borehole or pit latrines as a means of safe disposal of human excreta is considered practical in India. These latrines do not require any handling of night soil; they are cheap and can be made fly-proof and free from the risk of hookworm propagation. The extent of pollution diffusing from a borehole latrine into the groundwater is reported to depend mainly on the velocity of flow of groundwater. Hence the safe distance between a borehole latrine or leaching cess pit and a groundwater source may be taken as 25 ft (762 cm) or about 8 days travel of the groundwater. However, the above distance may have to be increased correspondingly if the soil is fissured or spongy or contains large voids, as in the case of badly shattered rock, limestone, or gravel.

India; borehole latrines; pit latrines; excreta; pollution

2124 Susikaran, M.
Research Cum Action Project, Poonamallee, India

An analysis of 296 individual house sanitary latrines in villages in Poonamallee area (Madras State). Proceedings of the Symposium on Evaluation of Rural Latrine Designs, the Central Public Health Engineering Research Institute, India. 73-80. October 28, 1964. 5 tables. 2 references.

A review of factors affecting the success of latrine programs in South India is given. Among the subjects discussed are health education to promote latrine acceptance, influence of religion, influence of house superstructure, effects of distance of house from water source and distance of latrine from house, and importance of type of enclosure for the latrine. The importance of the availability of latrine materials and need for follow-up advice and checking usage of latrines are stressed.

rural sanitation; night-soil disposal; pit latrines; India; public health; on-site treatment

2125 Wagner, E. G.
Lanoix, J. N.

Excreta disposal for rural areas and small communities. World Health Organization Monograph No. 39, Switzerland. 25-120. 1958. 46 references. 57 figures.
□ A review of a number of well-known rural on-site disposal techniques, including engineering factors, human factors, criteria for selection, and detailed descriptions of specific techniques, is given.

pit latrines; disposal; design; construction; infiltration; excreta; rural; household; squatting plates; compost privy

2126 Watson, M.
Ross Institute of Tropical Hygiene, London School of Hygiene and Tropical Medicine, London, U.K.

A note on the construction of bored-hole latrines. The Ross Institute Memorandum, London School of Hygiene and Tropical Medicine, U.K. 4p. June 15, 1936. 3 figures.

The borehole latrine, one for each family or small group, can provide a means of disposing human excreta and has proved successful in several different countries. Methods of latrine construction are described and a hole diameter of 16 inches (40.64 cm) is recommended to avoid soiling of the sides near the top and to ensure a sufficient cubic capacity. Some advantages and disadvantages of the borehole latrines and ways to overcome the difficulties during operation periods are included.

borehole latrines; excreta; construction

2127 Watson, M.
Ross Institute of Tropical Hygiene, London School of Hygiene and Tropical Medicine, London, U.K.

African highway ... the battle for health in Central Africa. Publisher, John Murray, U.K. Chap. 33, "Latrines." 165-168. 1953. 1 figure.

Chapter 33 describes simple types of latrines suitable for use in labour camps on agriculture estates. The need for strict maintenance and supervision of sanitary facilities is strongly emphasized.

shallow-trench latrines, smoking-pit latrines; borehole latrines, Africa

2128 Yeager, C. H.
Well pollution and safe sites for bored hole latrines. The Malayan Medical Journal, Singapore. 4(4). 118-125. December 1929. 9 figures. 1 table.

Experiments were conducted to determine the distance of travel of fecal coliform bacteria in very permeable soil from borehole latrines to determine the minimum spatial separation between the latrine and a shallow unprotected well. The bacteria were found to travel at least 23 m but not as far as 31 m. It was found that fluorescein could not be used satisfactorily as a chemical tracer of bacteriological pollution.

excreta; Singapore; borehole latrines; shallow wells; water pollution; groundwater

2129 Caldwell, E. L.
Field Research Laboratory of Alabama, State Department of Health, Andalusia, Alabama, USA

Study of an envelope pit privy. Journal of Infectious Diseases. Vol. 59. 264-269. November / December 1937. 3 figures. 5 tables.

■ This brief study demonstrates the marked influ-

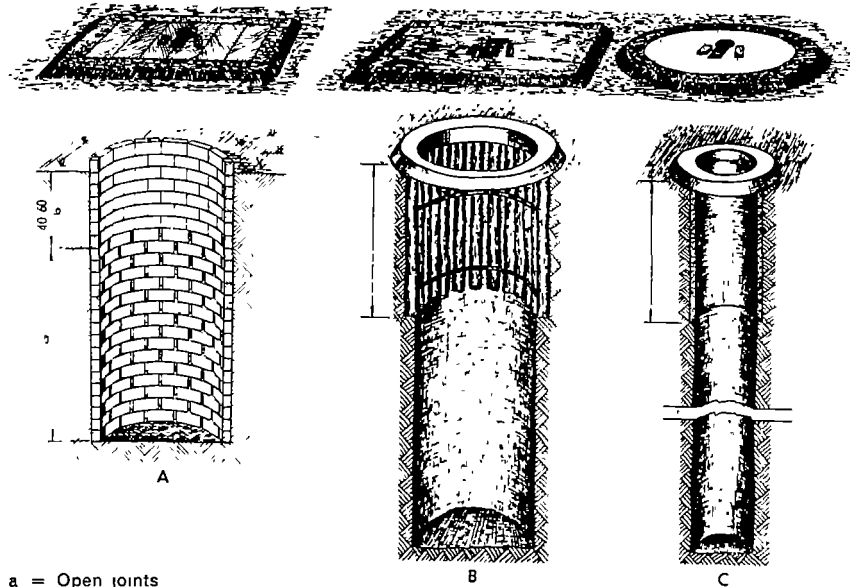

- a = Open joints
 b = Joints laid with mortar
 A = Square pit with brick lining and base and wooden floor
 B = Round pit with partial lining of cut tree limbs, soil-cement base, and built-up floor
 C = Bored pit with concrete lining, base, and floor

Various combinations of different types of pit, pit lining, base, and floor (from 2125).

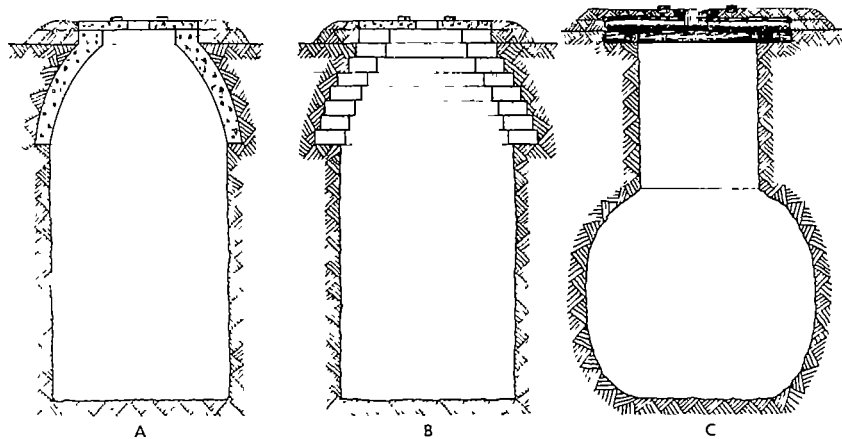

Large-volume pits with small floors and superstructures (from 2125).

ence of velocity of groundwater flow on the lineal travel of fecal organisms of the colon aerogenes group. It suggests a practical application in safeguarding the groundwater from dangerous contamination, in areas of suspected or observed high rate of flows, by the interposition of an envelope of fine-textured soil around the pit latrine. In the experiment discussed in this paper, the envelope encircled the pit. When the general direction of the

groundwater flow is known, only the lower half of the pit would require such protection.

groundwater; pit latrines; pollution; fecal bacteria

2130 Yeager, C. H.
 The bored-hole latrine. The Malaya Medical Journal.
 Vol. 2. 3p. March 1929.

This paper contains a short discussion on borehole latrines. Initially, the discussion centres around the advantages of a borehole latrine: they are low-cost, their construction is simple, and the operation or the upkeep of them is inexpensive and simple. As later suggested, this type of latrine does pose a problem of polluting the subsoil or the groundwater if it is not located properly. To see that borehole latrines do not pollute the drinking water supply from the nearby wells, it is recommended that, in a very permeable soil, they be located at least 100 ft (30 m) or farther from the source of water supply. It is also reported that the motile bacteria (*E. coli*) traveled through sandy quartzite earth for a distance of 70 ft (22.5 m) but did not reach a well 100 ft (30 m) away.

borehole latrines; groundwater; pollution

2131 Yeager, C. H.
Practical bored-hole latrine construction. The Malaya Medical Journal. Vol. 4. 11p. June 1929. 18 figures.

This paper discusses practical methods for building borehole latrines. Instruction for manufacturing and maintaining inexpensive tools for digging such latrines, in almost all types of soil, are given. If the soil conditions are such that the side walls of the latrines may cave in, it is suggested that a bamboo basket be inserted inside the borehole. The basket is specially made for this purpose and is allowed to protrude out of the ground a few inches; bricks or stones are placed around the extended portion, which prevents caving in at the surface.

borehole latrines; equipment

2132 Dyer, B. R.
Studies of ground water pollution in an alkaline alluvium soil. Indian Journal of Medical Research. Vol. 29. No. 4. October 1941. 1 photograph. 7 tables. 5 figures.

This paper describes, at length, an experiment that was carried out in Punjab, India, on how a borehole latrine could contaminate the subsoil water. To investigate, a borehole was sunk to the level of the subsoil water in an open space away from any known source of pollution. At measured distances from the borehole, hand pumps were introduced tapping the subsoil water. Before the introduction of filth into the borehole, the quality of subsoil water drawn from the hand pumps was determined by repeated bacteriological and chemical examination. The quality of the water having been established, nightsoil from a small community of 15 individuals (2 gal (9 litres)) was introduced into the borehole daily. Subsequent to this, regular examinations of the water from the pumps were carried out. The extent of the pollution, as shown by the MacConkey method, passed the 5-ft (1.5 m) zone but did not reach the 10-ft (3-m) zone. After retreat and subsequent advance, pollution, as shown by the Eijkman and MacConkey tests, passed the

2½-ft (.75-m) zone but did not reach the 5-ft (1.5-m) zone.

borehole latrines; groundwater pollution

2133 Handa, B. K. (author)
Dabadghao, S. B. (editor)
(Both) National Environmental Engineering Research Institute, Nehru Marg, Nagpur 440020, India

Rural latrines. National Environmental Engineering Research Institute, Nehru Marg, Nagpur 440020, India. 12p. 1976. 4 figures. 2 photographs.

A short description of hand-flushed, water-seal, dug-well latrines is given. Material requirements and their respective costs for building either one or a group of latrines, for use in rural India, are presented in easy-to-understand, simple tables. A step-by-step explanation of how to build a pan, water-seal / trap, soakage pit, and a superstructure to house toilet and urnals is furnished with drawings.

rural; latrines; soakage pits; water-seal latrines; India

2134 Ehlers, V. M.
Steel, E. W.
Municipal and rural sanitation. Sixth Edition, McGraw-Hill Series in Sanitary Science and Water Resources Engineering, 146-150. 2 figures. 14 references.

□ Design and construction details of a pit privy, covered with a concrete slab, are provided. How excreta could pollute the groundwater is explained and tips on how and where to locate a pit privy are given. Waste disposal using water carriage may not be possible in many farmhouses, residences in smaller towns and villages, and unsewered sections of cities. It is possible, however, to dispose of body wastes in a manner that will minimize or eliminate the transmission of diseases and the pollution of soil and water. It is stated that an excreta-disposal method should meet the following requirements for satisfactory results: there should be no contamination of groundwater that may enter springs or wells; there should be no contamination of surface water; there should be no contamination of surface soil; excreta should not be accessible to flies and animals; there should be freedom from odour and unsightly conditions; and the method used should be simple and inexpensive in terms of construction and operation. Design and construction details of a pit privy, covered with a concrete slab, could meet the above requirements provided the latrine is well located.

excreta; pit latrines; construction

2135 Matson, S.
Warshall, P.
Drum privy guidelines. Box 42, Elm Road, Bolinas, California 94924, USA, or Co-Evolution Quarterly,

Box 428, Sausalito, California 94965, USA. 12 figures. 4 references.

This paper gives guidelines for the construction of a drum-compost privy. According to the authors, it is the best design they have encountered. The drum privy uses low-cost materials, like a 50-gal (227-litre) drum, a garbage bin, and a few pieces of plywood and pipes; therefore, it should not cost more than \$50.00. Since all this experimentation is relatively recent, the drum-compost privy is still open to modifications and suggestions. The total volume of the drum privy is relatively small, and as a result it tends to flood if not

used properly. To counter peak loads resulting from get-togethers, construction of a separate urinal is recommended. Wood shavings are added after every use, and once the drum is full it is replaced by a new empty one. For fast composting, contents of the full drum could be transferred into a trench and composted along with animal and agricultural waste. If the conditions for open trench composting are not suitable for collected matter, it is allowed to compost within the drum for at least 1 year.

construction; composting; pit latrines

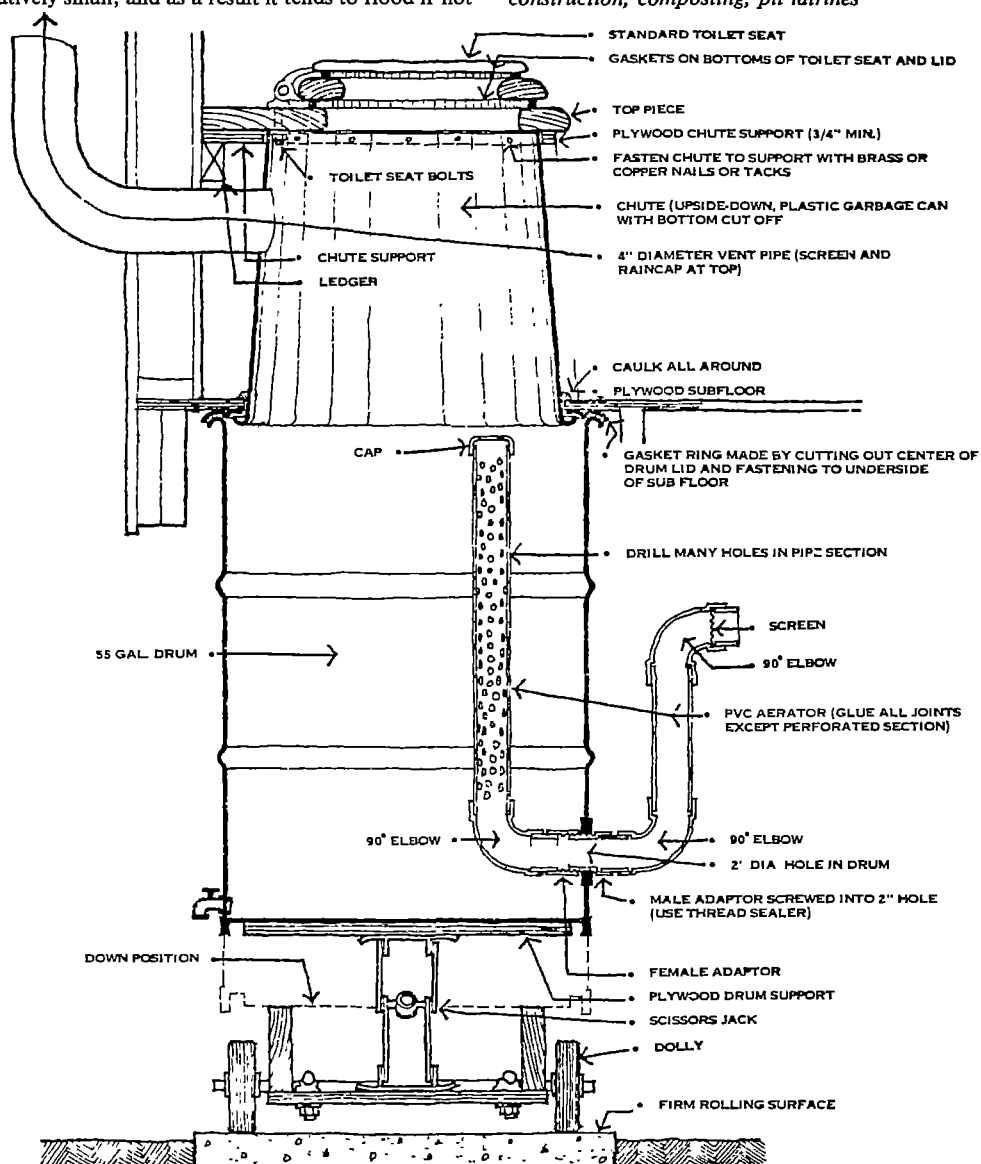

Matson drum privy (from 2135).

2136 Rajagapalan, S.
Shiffman, M. A.
University of North Carolina, Chapel Hill,
N C., USA

Guide to simple sanitary measures for the control of enteric diseases. World Health Organization, Geneva. 41-52. 1974. 9 figures. 25 references.

This review of a number of well-known on-site disposal techniques also includes checklists, emergency measures to counter small operational problems, appraisal of existing facilities, and construction details.

pit latrines; squatting plates; excreta; compost privy

2137 Secretaria de Salubrida y Asistencia,
Comision Constructura e Ingenieria Sanitaria,
Mexico

Los desechos humanos. Latrinas sanitarias. (Human waste and sanitary latrines.) Comision Constructura e Ingenieria Sanitaria, Mexico. 17 illustrations. 2 tables.

This handbook provides the design and explanation for the construction of sanitary latrines that are economical to build and run. The system is formed by utilizing local materials like flag stones, curb stones, and small wooden pieces.

pit latrines; sanitation; construction

2.2 Composting Privy

2201 Clivus Multrum USA Inc., USA

Clivus Multrum in public use facilities. Report of Clivus Multrum USA Inc., USA. 9p. 1976. 11 diagrams.

The Clivus Multrum composting toilet has been used in public installations, and this report describes two such installations in state parks in Sweden. One of these facilities is used by 600-1000 persons per week on a year-round basis. The design and operation of these facilities are described in detail.

composting toilets; community; disposal; Sweden; design; construction; public toilets

2202

The Department of Hygiene and Epidemiology,
Ministry of Health, Democratic Republic of
Vietnam

Double septic bins. A booklet published by the Department of Hygiene and Epidemiology, Ministry of Health, Democratic Republic of Vietnam. 33p. 1968. 3 tables. 12 figures.

□ A system has been developed in the Democratic Republic of Vietnam for on-the-spot composting of excreta. It consists of a two-compartment watertight vault. The compartments serve by turns for defecation and for composting. A groove channels the urine to a

separate container so as not to flood the interior of the vault. Before initiating use, a layer of ashes or lime is applied to the floor of the vault to absorb humidity, as well as to prevent the feces from sticking to the floor when being removed. After each use, wood ashes are sprinkled over the feces to absorb odours, and the hole is sealed with a wooden lid. When the tank is almost full the contents are leveled with a stick and it is filled with ashes. Then openings are sealed with lime cement or clay and the adjoining compartment goes into use as a vault. The composting (anaerobic) is allowed to go on for at least 2 months before the contents are removed by a rear access door. It has been found that following an 8-week period 85% of the intestinal worm ova are destroyed. Two factors are felt to contribute to more effective pathogen destruction — the use of kitchen ashes, which promote the anaerobic process, and as long a composting period as possible. After 8 weeks, 98% of organic nitrogen is changed into useful inorganic form, and the percentage of inorganic nitrogen (ammonium nitrate) increases rapidly in the latter stages of the composting process. The use of the Vietnamese double vault has resulted in a recorded drop in disease due to handling fresh excreta used for fertilization, as well as an increase in crop production due to the fixing of the nitrogen in the compost product. The compost product is used to fertilize rice, as well as secondary food crops, mainly vegetables, and the quantity of fertilizer is estimated to be the equivalent to 2.3 million tons of protein sulfate per year. To serve a family of 5-10 persons the vault required is 1.2 m wide, 0.7 m high, and 1.7 m long. A variety of construction materials can be used, depending on local availability. Clay, lime mortar, stone, rammed earth, bamboo wattle, unbaked bricks, and concrete are used in various regions to fabricate the container. In certain mountain regions where human wastes are not used in agriculture, the vault is dug as a pit and only a movable lid is constructed, which is removed to a new site once the pit is full.

Vietnam; Vietnamese double vault; excreta; urine; composting; agriculture; health; mouldering toilets

2203

International Reference Centre for Community
Water Supply, The Hague, Netherlands

Contribution to a mail survey on practical solutions in drinking water supply and wastes disposal for developing countries. A report prepared by the International Reference Centre for Community Water Supply, The Hague, under Contract with the University of Oklahoma Project, USAID Contract No. AID/CM-ta-C-73-13, Netherlands. 156 p. February 1977. Numerous figures included.

This mail survey was conducted for the purpose of collection of field experience and unpublished data with particular reference to practical solutions in drinking water supply and waste disposal in developing countries. A need was felt for a compilation of information on alternative techniques that would be uncomplicated, easy to work with, require less

maintenance, and that could be managed by the local people. These could be noncurrent techniques, adaptations of existing ones, or new developments. Made widely available, such a compilation would enable engineers to select the solutions that would best suit the social, cultural, and economic conditions of the country and technical level of their personnel.

developing countries; sanitation; latrines; aqua-privies; stabilization ponds; septic tanks; mouldering toilets

2204

Konsumentverket, Fack, Sweden
Klosetter for fritid. (Toilets for recreation.) ISBN 91-7398-068-4. Sweden. 40p. Issued April 1976. 1 figure. 4 tables. 10 references.

The document is meant as a handbook to owners of recreation huts in their choice of toilet. It is a follow-up of the 1973 edition of "Toilets for Recreation Huts" and includes the new types introduced since 1973, especially since the range of mouldering toilets has increased. Principles for different toilet types on the market are described. For each individual toilet price, operating cost, manufacturer, and any special technical requirements needed for the type of toilet are tabulated. Judging, from an environmental point of view, is done of the effects of the different types of toilets. The influence of given preconditions like purifying demands, given technical standards, service available, and soil conditions on the choice of toilets is also discussed. (Original paper written in Swedish.)

on-site treatment; mouldering toilets; incinerator toilets; flush toilets; night-soil disposal; latrines

2205

Mikrobiologisk Institutt, Norges Landbruks-hogskole, 1432 As, Norway

21 Biologiske klosetter, komposteringsklosetter for hytter og fritidshus. (21 Biological toilets, mouldering toilets for recreation huts.) Reprinted from Forbruker-Rapporten nr 10. Norway. 15p. 1975. 3 figures 4 tables.

□ Twenty-one different mouldering toilets appearing on the Norwegian market have been tested at the Agricultural University, Norway. The toilets were grouped as follows: big toilets with flat container (1200-1600 litres); big toilets with an inclined container (200-1200 litres); small toilets with a warming-up system (80-200 litres); small toilets without a warming-up system. The report is meant as a guide for choosing toilets for recreation huts. The tests were carried on for 5 months and during that time the different toilets were charged with excreta according to instructions given by the producers. The results are given both in tables for each toilet and in a summing up for the four groups separately. Group 1 toilets gave an unsatisfactory aeration of the material, anaerobic conditions, and as a consequence of this the

mouldering effect was low. None of the types worked satisfactorily as a mouldering toilet. In group 2 some of the types gave a better decomposition. Problems occurred with the inclination: a steeper angle than 20% made all excreta fall to the bottom of the container straight away and it was filled up very quickly. Problems with the urine were also noted. On the whole, group 2 was somewhat better than group 1. Group 3 gave a better mouldering effect, thanks to the increased temperature and the better aeration resulting from built-in levers for stirring the excreta. This higher activity is important because of the small size of the container. One toilet from group 4 was tested and it was found to work less efficiently than group 3 toilets. (Original paper written in Norwegian.)

mouldering toilets; composting; excreta; on-site treatment; Norway; analysis

2206

Berry, W.
A composting privy. Organic Gardening and Farming, USA. Vol. 20(12). 88-97. December 1973. 6 figures.

An experiment with an on-site composting privy is described. The container has four compartments that permit alternative use and composting of excreta and dry organic matter. The humus product has been used in fertilizing nonfood crops. The composting process is primarily anaerobic.

household; design; construction; on-site treatment; disposal; compost privy; USA

2207

Blackmore, M. D.
Boydell, R. A.
Mbere, N.
Moselele, P.

Low cost sanitation research project: first and second interim reports. Unpublished Reports to the Ministry of Local Government and Lands, Republic of Botswana and to the International Development Research Centre, Botswana. 75p. September 1976. 1st report, 9 appendices. 18 diagrams. 10 tables. 2nd report, 47 tables.

Problems arising from unplanned migrations to urban areas have necessitated a search for low-cost sanitation systems that will be low (or non-) water consuming, hygienic, and socially acceptable. Following a review of local conditions and regional experiences, three systems were proposed for consideration: aqua-privies, composting toilets, and modified pit latrines.

Botswana; compost privy; aqua-privies; pit latrines; social acceptance; economics

2208

Service de l'habitat et de l'urbanisme, Paris, France
Le péril fécal et le traitement des déchets en milieu rural tropical. (The fecal peril and waste treatment in

the rural areas of the tropics.) Bureau central d'études pour les équipements d'outre-mer, (B.C.E.O.M.), France. 139p. May 1957.

□ Rural excreta-disposal techniques for African villages are reviewed. These range from pit and borehole latrines to septic tanks and aqua-privies. Emphasis is placed on the desirability of separating feces and urine in dry latrines, and a number of squatting plates are described that accomplish this purpose. A movable dry compost privy is recommended. The decomposition of dry feces is reported to take 6-8 weeks. (Original paper written in French.)

Africa; rural; construction; pit latrines; compost privy; squatting plates

2209 Danielsson, K.
Klosetter for fritidshus. (Toilets for recreation huts.) Konsumentverket, Fack. Sweden. 53p. 1973. 9 figures. 3 tables.

This publication is meant as a guide to owners of recreation huts in planning the sanitary part of the house. The following types of toilets have been tested: traditional type of dry toilets; composting toilets; freeze toilets; packeting toilets; burning toilets; flushing toilets. The toilets were judged from both a private-hygiene point of view and from their polluting effects on the environment. In addition to this, costs and technical requirements (e.g., electricity, water, space needed) are listed in a table. Four mouldering toilets were tested, as well as three smaller types using electricity and one bigger type not using electricity (Clivus). The results show that in the smaller toilets excreta is not completely decomposed and needs "after-composting" for some time in addition to the treatment in the toilet itself. In contrast to this the product coming from Clivus is satisfactorily decomposed and can be used immediately. The other types of toilets discussed do not imply any final treatment of the excreta (except for the burning toilet) because the sludge produced has to be treated another time in a central purifying plant. Altogether 23 different toilet types are presented. Finally, a summing up of 13 smaller purifying plants for single houses or small house-groups is given, with prices and test-results. (Original paper written in Swedish.)

mouldering toilets; freeze toilets; burning toilets; excreta; on-site treatment; composting; small-scale purifying plants

2210 Eygelaar, J.
Composting toilets — report of a visit to the alternative waste disposal project, Dar-es Salaam, Tanzania. Unpublished report. Housing Research and Development Unit, University of Nairobi, Kenya. 9p. April 4, 1977. 1 diagram.

This is a description of a research project in Tanzania that tested four types of improved latrines — continuous composting, double vault, odourless ventilated pit latrine (R.O.E.C.), and the ventilated pit

latrine. Only preliminary results are given. Operation so far is said to be satisfactory and the majority of users seem to adapt easily to the required operation.

Tanzania; composting toilets; rural; social acceptance; pit latrines

2211 Fogel, M.
Clivus Multrum USA, 14A Eliot Street, Cambridge, USA

Chemical analysis of Clivus Multrum compost. A report issued by Clivus Multrum, USA. 9p. February 1977. 4 tables 9 literature references.

Samples of finished compost from seven Swedish Clivus Multrum units, which had been in use for between 4 and 14 years, were collected and analyzed for organic matter, major plant nutrients, minor and trace plant nutrients, and toxic metals. The Multrum compost averaged 58% organic matter. The concentrations of the major plant nutrients, N, P, K, were respectively 2.4%, 3.6%, and 3.9%, which is higher than in ordinary garden compost, municipal compost, or composted sewage sludge. The values are about one-third of those for ordinary fertilizers. Also, in regard to minor and trace plant nutrients, the compost had suitable concentrations. For toxic metals (Zn, Cu, Ni, Cd, Pb, Cr, Bo) the concentrations were far below the recommended safe levels (USDA). The values were lower than in common sewage sludge. Concentrations of soluble salts were also measured and found acceptable.

mouldering toilets; composting; soil amendment; plant nutrients; metals; on-site treatment

2212 Jounge, L. D.
Enviroscope, Inc., Corona del Mar., California, USA

The Toa-Throne — a new compost toilet. Compost Science, USA. Vol. 17(4). 16-17. September / October 1976. 2 tables.

A Swedish Toa-Throne compost toilet capable of processing both human and kitchen organic wastes is described. The unit, which can accommodate from four to six persons, is small, compact (1300 litres gross volume), and its overall cost in Europe is about U.S. \$1000. Experiments conducted in Norway show that reduction of mass solids after composting is from 72 to 92% and the end product is free from pathogenic organisms such as *Salmonella* and poliovirus, hence its suitability for use as fertilizer or soil conditioners.

composting toilets; kitchen wastes; Sweden; Norway; pathogens; fertilizer; soil conditioners; excreta

2213 Lindstrom, C. R.
Institutionen for Uppvarmningsoch ventilations- teknik, KTH S-100 44 Stockholm, Sweden
Multrum, undersokning av driftsforhallanden hos en formultnings-anlaggning for organiskt hushallsavfall. (Multrum, investigation of the working conditions of

a mouldering establishment for organic household-waste.) A report issued by Clivus AB, Sweden in 1969. 44p. 5 figures. 9 diagrams. 5 tables. 6 literature references.

■ The construction and function of Clivus Multrum are described, and the differences between Clivus and a normal privy are pointed out. These are primarily the addition of kitchen waste, the aeration, and the inclination that prevents the urine from staying with the excreta, making it too wet. These factors make it possible for a decomposition to take place in the mouldering toilet, which is not the case in a normal privy. The investigations concern the question of balance between added and removed amount of solid materials and water in the toilet, if an equilibrium is reached, and the importance of temperature to this process. Through calculations of the heat balance it is found that at 19 °C a steady state is reached for water and organic material, when the toilet is used by four persons. The temperature in the mixture of excreta and kitchen waste reached its maximum about 10 cm below the surface (+35 °C) and sank to average room temperature at about 50 cm depth. The decomposing activity was also highest where the temperature was at its maximum. (Original paper written in Swedish.)

mouldering toilets; on-site treatment; excreta; kitchen-wastes; temperature

2214

Lindstrom, C. R.
The Clivus-Multrum system ... composting of toilet waste, food waste, and sludge within the household. Water Pollution Control in Low Density Areas, University Press, USA. 429-444. 1975. 7 figures. 5 tables.

The use of household composting is proposed as a way to reduce water pollution. Properly constructed ground infiltration systems for wastewater from bath, sink, and laundry will have little or no impact on the environment. Swedish experiences are cited.

household; treatment; composting toilets; wastewater

2215

Lindstrom, R.
A simple process for composting small quantities of community wastes. Compost Science, USA. 30-32. Spring 1965. 2 figures.

An experimentally tested process is described that achieves an aerobic biological change in organic wastes. The key to this process is that excreta is deposited into a naturally ventilated chamber and moves by gravity along the sloped bottom to a second chamber. This second chamber holds organic refuse from the kitchen and garden. The garden refuse adds the important nitrate bacteria that increases slowly but

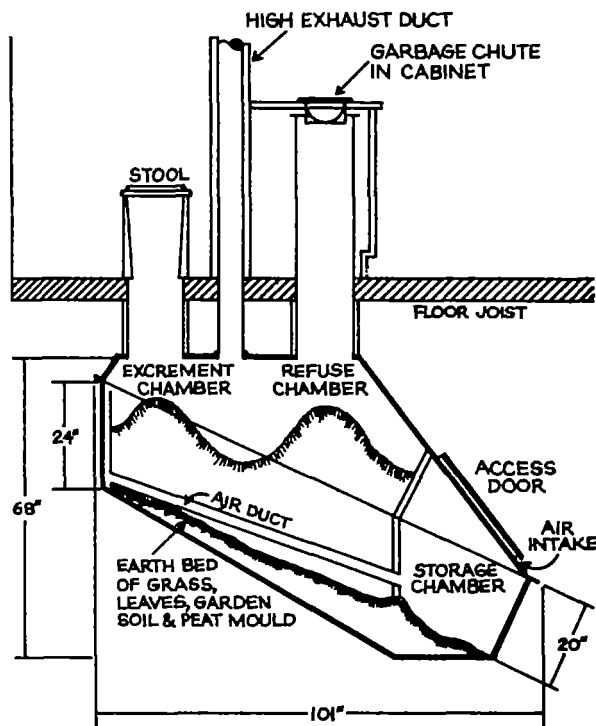

Cross section of the Clivus Multrum

must be present in adequate numbers later so that a complete change of the ammonium carbonate into ammonium nitrate occurs. The slope of the tank bottom provides continual movement of decomposed refuse to the third (storage) chamber as additional wastes are added to the other two compartments. When more refuse is added, the lower layer is compressed and decays. The waste volume is reduced to a fraction of the original during this process. Experiments have shown that the bottom slope must be between 14.0° and 18.5°. The unit is not connected to any drain pipes and the moisture content from urine is sufficient for the conversion process. Aeration of the wastes is of primary importance in the decomposition process. Air movement is achieved by natural ventilation via an exhaust stack, which also eliminates odours. The size of the tank, which is of impervious material such as concrete, can be varied. Minimal dimensions are 1 m wide and 3.5 m long. The major advantage of this process is that it is fully automatic, does not require fuel, chemicals, or water, and the end product contains large amounts of humus-forming substances.

composting; disposal; household; aerobic digestion

2216 McMichael, J. K.
Health in the third world ... studies from Vietnam. Spokesman Books, U.K. 40-50. 1976. 7 references. 4 diagrams.

A description of the Five Year Plan (1961-1965) of the Democratic Republic of Vietnam for rural hygiene, with particular reference to experiences with the Vietnamese double vault, an anaerobic compost privy. This successful program is based on social, cultural, economic, as well as technical solutions. The Vietnamese double vault receives feces only and produces significant quantities of disinfected fertilizer.

Vietnam; anaerobic digestion; composting; rural; sanitation; public health; hygiene; customs; Vietnamese double vault

2217 Nesbitt, P. M.
Seldman, N. N.
(Both) Institute for Local Self-Reliance, Washington, D.C.

Cities need sewerless toilets. Building Systems Design, USA. Vol. 73(3). 11-17. April-May 1976.

Advanced sewage treatment facilities in the Washington, D.C., area alone will cost \$2 billion to build and \$70 billion to operate. If 1 million biological toilets were installed the initial outlay would be about \$800 million plus a minimal annual maintenance expense. Advantages of compost toilets in urban areas are discussed.

urban; composting toilets; USA; aerobic digestion

2218 Nichols, H.W.
Analysis of bacterial populations in the final product of the Clivus Multrum. Report of the Center for the Biology of Natural Systems, Washington University, USA. 16p. December 7, 1976. 6 tables. 13 references.

The Clivus Multrum is a mouldering toilet designed and produced in Sweden and the United States. An evaluation was made of the bacterial populations that occur in the final product of the Multrum, and was compared with the populations ordinarily encountered in soil, particularly with respect to pathogenic species. It was found that the bacterial composition of the composted product is similar to that of soil, the number and species of pathogenic bacteria present are similar to soil, and the final product appears to be suitable for use as a soil conditioner.

composting toilets; bacteria; fertilizer; soils; analysis; solid wastes; excreta

2219 Nimpuno, K.
Dept. of Architecture, Chalmers Technical University, Gothenburg, Sweden
Excreta disposal without water. Appropriate Technology, U.K. Vol. 3. No. 4. February 1977. 1 diagram. 1 table.

This article describes a low-cost latrine that uses a two-stage biochemical process. The first stage is a two-part decomposition process (aerobic and anaerobic), and the second stage is a chemical treatment obtained by using household ashes. Ample supplies of natural oxygen ensure a rapid breakdown of the excreta. To neutralize the urine acids, household ashes are thrown in each day. Paper and other household wastes supply the cellulose needed in the process. Sustained high temperatures destroy pathogens and help to break down large organic molecules. The latrine serves a family of six for 9-12 months.

excreta disposal, waterless toilets; disposal; urban; rural, criteria; household; compost privy

2220 Pedersen, T. A.
Mikrobiologisk Institutt Norges Landbrukshogskole, 1432 As, Norway
Biologiske klosetter — virkesmate og muligheter. (Biological toilets — function and possibilities.) Vann, No. 4. Norway. 240-267. 1974. 4 figures. 11 tables. 8 literature references.

A summary of existing toilet-types is made, and their suitability for use in recreation huts is evaluated. The mouldering toilet is pointed at as the most acceptable alternative in recreation areas. The factors of importance for obtaining an effective composting process are discussed. These are aeration, humidity, temperature, C:N ratio, and others. Then a laboratory test is described where excreta was composted for 2 months under various conditions. The factors altered were temperature, air humidity, and composition of the material composted. After 1 and 2 months of composting, samples were taken and

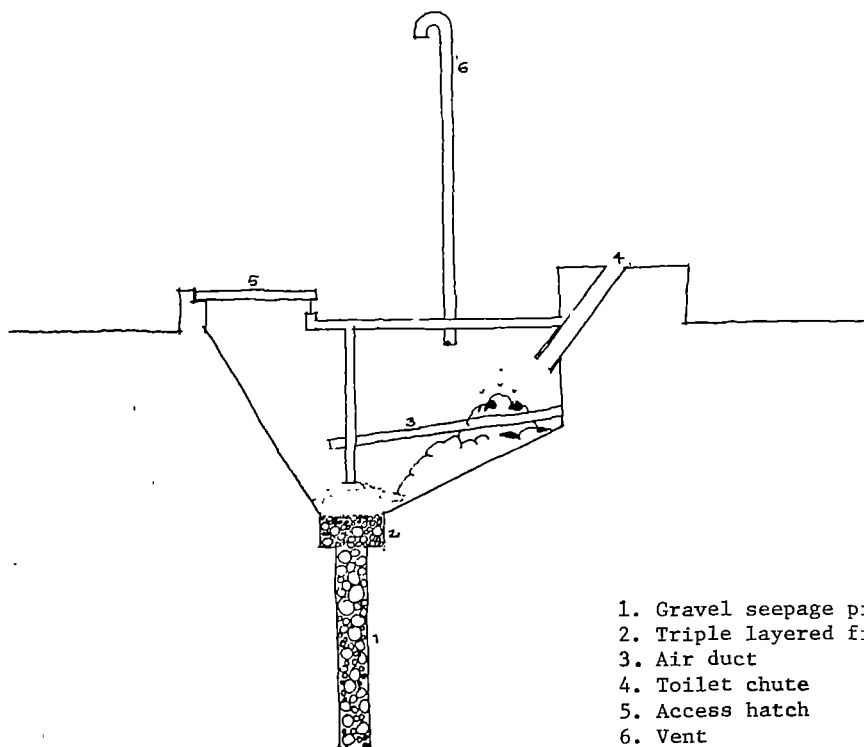

1. Gravel seepage pit
2. Triple layered filter
3. Air duct
4. Toilet chute
5. Access hatch
6. Vent

The biopit composting toilet (from 2219).

analyzed with respect to rate of decomposition, odour, production of CO₂, bacteria content, development of actinomycete colonies, and fungoid growth. The C:N ratio in some samples was measured at the start and the end of the test. The results show among other things that a humidity of 40% seems to give the best decomposition, while higher humidity has a negative effect on the process. An addition of kitchen waste had a positive effect and also higher temperature gave a faster decomposition. The existence of actinomycete colonies at the surface and the development of CO₂ in the material gave a good indication of the decomposition activity. (Original paper written in Norwegian.)

composting; mouldering toilets; excreta; odours; decomposition; microorganisms; humidity; temperature

2221 Reid, G.
Practical sanitation. Charles Griffin & Co. Ltd., U.K. 163-165. 1905.

A waterless privy, Moule's earth closet, is described. Dry earth is used to "flush" the waste into a container. Following a suitable holding period (3 months) the composted matter is removed.

earth closets; composting; disposal; household; England

2222

Rybczynski, W.
Ortega, A.

(Both) Minimum Cost Housing Group, McGill University, Montreal, Canada

Stop the five gallon flush! a survey of alternative waste disposal systems. Minimum Cost Housing Group, McGill University, Canada. 82p. April 1976 18 references. 77 figures.

□ This survey describes 66 on-site disposal systems, both proposed and commercially produced, that are alternatives to waterborne sanitation, both from developed and developing countries. The emphasis is placed on systems that reduce water consumption. Composting toilets are described in detail and a low-cost model is proposed.

sanitation; disposal; water reduction; composting; design; materials; on-site treatment

2223

Rybczynski, W.
Minimum Cost Housing Group, McGill University, Montreal, Canada

Small is beautiful ... but sometimes bigger is better, new developments in composting and mouldering toilets. Solar Age, USA. Vol. 1(5). 8-11. May 1976. 8 diagrams.

Recent world developments in one-family composting and mouldering toilets are reviewed. Eight

designs, both tried and untried, are discussed. Four of these designs are intended for use in developing countries, the others are for use in the United States and Scandinavia. The author concludes that a large holding volume is required for successful continuous composting.

excreta; disposal; composting; fertilizer; sewage treatment; design; rural; household; compost privy

2224 Rybczynski, W.
Minimum Cost Housing Group, McGill University, Montreal, Canada

The Minimus composting toilet ... an inexpensive sanitation solution for the Philippines. Unpublished Report to U.N.E.P., Philippines. 3p. September 13, 1976. 2 figures.

■ The Minimus composting toilet is based on the realization that the combination of human excreta with organic kitchen wastes under conditions of extreme aeration will, with time, result in first-class fertilizer. The chamber where this takes place is provided with air ducts and a vent pipe to promote aeration, as well as a sloped bottom to move the decomposing matter toward the low end from whence it is removed, after a mouldering period of 2-3 years. The odourless product, called humus, is a nutrient-rich fertilizer. The chamber (2.5 m long X 1.0 m wide) is built of concrete blocks plastered inside, and has a concrete floor. It is covered with G.I. roofing. The vent pipe is galvanized metal, and the air ducts are PVC or asbestos cement. The main advantages of the composting toilet are: operation is hygienic, odourless, and maintenance free; no water is used; it accommodates all the organic household garbage; nutrient-rich fertilizer is produced; it is self-contained and hence not affected by a high-water table; it is a low-cost toilet that is easy to construct. The first Philippine Minimus, completed in September 1976 at the Manpower Skills Training Centre in Magsaysay Village, has shown that no particular problems occur in the construction process that cannot be undertaken by someone with some skill in masonry. This has also permitted a fairly accurate cost estimate to be made on the basis of actual experience. The total material cost is P 385 00 (1976). Construction time is about 6 man-days. A second toilet, located in an actual household in the project area has also been built.

Philippines; composting toilets; urban; economics

2225 Rybczynski, W.
Minimum Cost Housing Group, McGill University, Montreal, Canada

Appropriate sanitation for the world's poor. Paper presented to the Seventh Annual Composting and Water Recycling Conference, University of Amherst, USA. 9p. May 4-6, 1977.

A review of dry excreta-disposal alternatives for tropical countries with specific examples of successful applications in China, the Democratic Republic of

Vietnam, and India is given. The author concludes that dry biological decomposition processes are an appropriate disposal technique, though certain questions still remain to be answered — maintenance, availability of additional organic materials for composting, the cost-benefits of producing fertilizer, and social costs.

developing countries; composting; dry treatment

2226 Save, U.
Ekoteket, Box 7287, S-103 85 Stockholm, Sweden

Odling — foda — kompostering — Ateranvandning. (Cultivation — food — decomposing — reuse.) Report from 'EKOTEKET,' Sweden. No. 5. 4p. 1976. 3 figures.

This article is a description of the Clivus mouldering toilet, its function and use. In the mouldering toilet one person produces about 40 kg of soil amendment, instead of polluting 25 000 litres of water a year with excreta. Waste from the kitchen and excreta are mixed and decomposed together, without addition of either chemicals or electrical heat. The author points out that Clivus is both uncomplicated and cheap to use, and it should therefore be possible to use in developing countries where water often is a limited resource. Clivus is the oldest mouldering toilet on the Swedish market and also the most efficient one, mainly because of its large size. (Original paper written in Swedish.)

mouldering toilets; composting; excreta; on-site treatment; Sweden

2227 Valdmaa, K.
Dept. of Soil Sciences, Section for Waste Biology, The Royal Agricultural College, Uppsala, Sweden

The Mullbank toilet. Compost Science, USA. Vol. 15(5). 23-27. 1974. 4 tables. 3 figures.

The results of an investigation into the functioning of a particular electric composting toilet are reported here. The composition of the final product of eight tested toilets is identified and the occurrence of bacteria determined. The product is comparable to farmyard manure and is well suited as a fertilizer or soil conditioner.

Sweden; analysis; composting toilets; bacteria; fertilizer

2228 Van Der Ryn, S.
Composting privy. Technical Bulletin No. 1. The Farallones Institute, USA. 17p. January 1974. 8 references. 9 illustrations.

Instructions for building a two-compartment compost privy are given. A discussion of composting theory indicates that the privy is designed to optimize the size of the pile for aerobic decomposition.

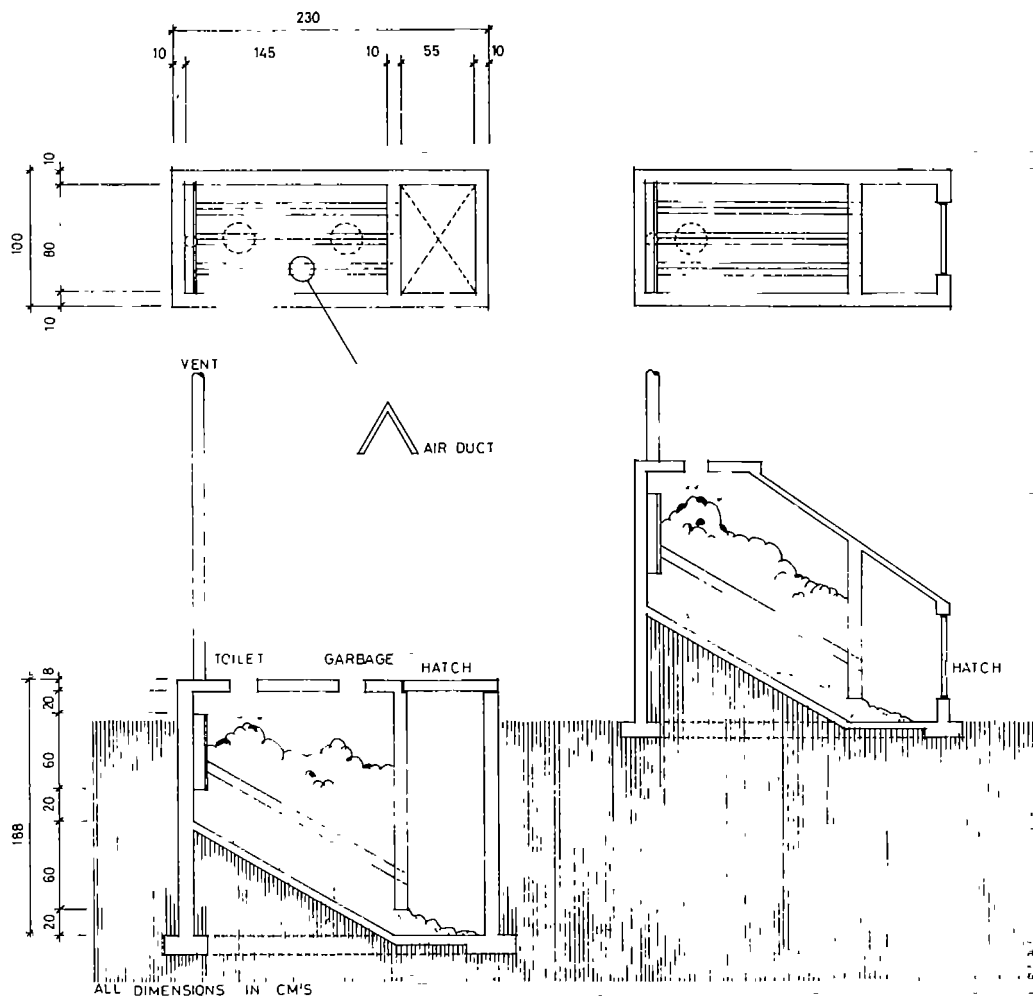

The Minimus composting toilet (from 2224).

household; rural, compost privy; disposal; construction; design

2229 Van Der Ryn, S.
The Farallones composting privy. Compost Science, USA. Vol. 17(3). 15-17. 1976.

This is a general discussion of a two-compartment composting privy. The compost is moved manually to the second compartment for a total decomposition period of 1 year. Sawdust is added with each use. The

humus product is used for fertilizing nonfood crops.

compost privy; household; disposal; design; USA

2230 Wagner, E. G.
 Lanoix, J. N.
Excreta disposal for rural areas and small communities. World Health Organization Monograph No. 39, Switzerland. 115-119. 1958.

☐ The author describes the construction and opera-

tion of a double vault compost privy. The human waste is left undisturbed for at least 6 months to ensure destruction of pathogens and ova of helminths.

composting; rural; disposal; design; household; compost privy

2231 Winblad, U.
Compost latrines — a review of existing systems. Unpublished Report, Environmental Sanitation Research Project. Tanzania. 46p. July 1975. 23 figures. 24 references

■ A review is given of 23 existing systems of compost privies that have been used worldwide. The discussion is related to advantages and disadvantages of the systems and their methods of construction and operation. Figures of each system are also included.

compost privy; construction; excreta; public health

2232 Winblad, U.
Evaluation of waste disposal systems for urban low income communities in Africa. SPC Report No. 3. Scan Plan Coordinator, Denmark. 34p. 1972. 45 references

A description of conditions in urbanizing Africa leads to the conclusion that an intermediate solution is required for urban utilities, particularly waste disposal, that will reduce per capita investment while increasing population density. General performance criteria for such a waste-disposal system are formulated. A review and evaluation of existing systems indicated that no system fulfills all the criteria, though those based on microbiological decomposition such as composting toilets seem to offer the best possibilities for development.

Africa; sanitation; disposal; criteria; urban; composting; compost privy

2233 McKernan, J. M.
Sym/Bios Consulting Services, Winnipeg, Manitoba, Canada

Morgan, D. C.
Manitoba Department of Northern Affairs, Winnipeg, Manitoba, Canada

Experiences with the Clivus-Multrum and Mull-Toa toilets in northern Manitoba. An interim report on a mouldering toilets testing programme carried out by the Department of Northern Affairs, Province of Manitoba, Winnipeg. 17p. August 18, 1976. 8 photographs. 2 drawings

■ A report on two types of composting toilets is given. Nine Mull-Toa and three Clivus-Multrum toilets were installed in remote communities of northern Manitoba. It is reported that five of nine Mull-Toas had to be removed due to chronic malfunctioning whereas all three Clivus-Multrums have functioned reasonably well. The relatively lower consumption of fresh fruits and vegetables in the

northern areas has resulted in little waste contribution to the Clivus-Multrum waste unit. New substitutes like peat moss and sawdust are being tried in place of vegetable matter to obtain higher C:N ratio. After monitoring two types of toilets for about a year and a half, the interim conclusions seem to indicate that the Mull-Toa has little practical value for use in northern Manitoba, whereas the Clivus-Multrum could help solve the northern sanitary problem provided it is used with some care.

composting toilets; Manitoba

2234 Ortega, A.
United Nations Mission on Housing, Building and Planning, Dubai, United Arab Emirates
Lefebvre, B.
Minimum Cost Housing Group, School of Architecture, McGill University, Montreal, Canada

Water saving devices for sanitation. United Nations Mission on Housing, Building and Planning, Ministry of Public Works and Housing, Dubai, United Arab Emirates. 8p. 10 photographs. 3 drawings.

This monograph outlines how to build and run a composting toilet in a desert climate. This composting toilet has three compartments: in the first, human excreta is deposited; in the second, household garbage and kitchen waste are deposited; and the third and the last compartment is the one from where digested, accumulated compost is retrieved. The toilet is built like a big container (3 X 1.5 X 2 m deep) using 20 X 20 X 40-cm concrete blocks. A slope of 30° is formed at the bottom, which allows the compost pile to slide out slowly toward the collection chamber. Three inverted v-shaped ducts placed in the middle of the tank allow the air to pass from the collection chamber, through the compost pile to aerate it, and then escape through the vent pipe. The cover of the container was made of plywood; it also could be of reinforced concrete. For the garbage chute, a plastic bin without the bottom is used. The toilet is a squatting type, called a "watergate"; this unit provides a waterseal with only 1 litre of water. The amount of water added to the compost does not unbalance the decomposition process, evaporation being so rapid in desert regions. At the end of this monograph, operating instructions are given.

composting toilets; construction; water saving

2235 Regnell, S.
Nimpuno, K.
(Both) Byggnadskonsult Tekn. lic. Stig Regnell
AB Falkvagen 41, 183 52 Taby, Sweden

Excreta disposal in the less developed countries. Report prepared for and by direction of the Swedish International Development Authority (SIDA). 46p. September 1975. 5 tables. 3 figures. 17 diagrams.

The state of public health in less-developed countries (LDCs) is often low compared with the

industrialized part of the world. The low standard of hygiene is in many respects a result of insufficient toilet systems. The Western systems are far beyond the financial resources of the poor countries. In some LDCs there are, however, some fairly good and inexpensive types of latrines, called compost latrines, that make use of the biological decomposition of excreta mixed with kitchen wastes and grass, etc. A similar process has been applied to new and cheap types of latrines for recreation houses in the Nordic countries. The criteria for the latrines to be used in the LDCs are drawn up and the different types of latrines have been scrutinized. It is recommended that some of the new types of latrines be developed based on decomposition suitable for LDCs.

developing countries; economics; latrines; hygiene; composting

2.3 Septic Tank and Aqua-Privy

2301

Daily News, Botswana, Africa.

Aqua privy outlawed for the time being. Daily News, Botswana. No. 218. 1p. November 13, 1975. 1 figure.

A newspaper report of a governmental ban on the construction of aqua-privies in Botswana explains that the ban was introduced because of severe odour problems experienced with aqua-privies and that the ban would remain in force until design improvements have been made to overcome this problem.

Botswana; Africa; aqua-privies; odours

2302

College of Agricultural and Life Sciences, College of Engineering, University of Wisconsin, Madison, USA

On site disposal of small wastewater flows. Small Scale Waste Management Project. University of Wisconsin — Extension Division of Economic and Environmental Development, USA. 85p January 1976 103 references. 23 figures. 10 tables.

The report illustrates the scope of the problem of on-site wastewater disposal and describes the general nature of the research and demonstration studies completed and in progress by the Small Scale Waste Management Project. Objectives of the project are to determine and understand the causes of septic tank system failure, to improve methods of site characterization, system design, and system construction for on-site wastewater disposal, to develop more efficient management techniques of on-site wastewater disposal systems, and to assess the implication of new wastewater disposal technologies for land-use planning.

on-site treatment; wastewater; septic tanks; design; construction; absorption; seepage pits; evapotranspiration

2303

The Epidemic Prevention Station, Department of Hygiene and Revolution Committee of the District of Chiong, Province of Kiangsu, China

The two-partitions-three-tanks type hygiene toilet. In "Compilation of Data on Experience and Sanitary Management of Excreta and Urine in the Village." Unpublished report of the International Development Research Centre, Canada. Translated from Chinese by Lee Thim Loy. 33-43. 3 tables. 26 figures.

■ This article describes the design and construction and operation of the Chinese three-tank toilet system in which only human excreta and a minimal amount of flushing water (2 litres/person/day) are passed through three tanks in a series. Studies of the contents of the tanks indicated that the first acts as a settling chamber for the heavier solids; the excreta in the second is liquified and undergoes fermentation; the third tank is used for excreta storage before its extraction and use as fertilizer. The detention periods of the first, second, and third tank are 10, 10, and 30 days. The tanks are normally circular but could easily be rectangular. The settled excreta is drawn off at about three-quarters depth from the first tank and passed through the second tank entering at the same depth. Through its 10-day residence in the second tank it rises to the overflow pipe at the surface, which leads to the bottom of the third tank. The water levels of the first two tanks are therefore equal, whereas that of the third tank depends on how much night soil is being used. The design of the system ensures that even during periods of high fertilizer demand the excreta undergoes at least 20 days of anaerobic treatment. Samples were drawn from typical systems and analyzed for ascarid egg viability and nitrogen levels. Liquid temperatures were generally below 8 °C. More than 2000/g of ascarid eggs were observed in the upper layers of the first tank, more than 80% of them living. No eggs were observed in the third tanks' upper and middle layers, but 2263 were found on the bottom; however, all of these were dead. Active nitrogen levels (as being available in inorganic form to plant life) were compared to total nitrogens, which includes organic nitrogen. At one plant in Shih Chiao the total nitrogen before and after the three-tank treatment was dropped from 0.39 to 0.25%, indicating an overall loss of 35%; however, the active nitrogen rose from 0.08 to 0.35%, illustrating the degree to which anaerobic treatment in the three tanks can transform the wastes into a more assimilable form for plant growth. (Original paper written in Chinese.)

excreta; urine; China; nitrogen; septic tanks; design

2304

Housing and Home Finance Agency, Office of the Administrator, Division of Housing Research, Dept. of Housing and Urban Development, Washington, D.C., USA

Septic tanks — their use in sewage disposal. Housing Research Paper No. 18. Government Printing Office, USA. 16p. 1952. 8 figures.

A short guide to the design and construction of septic tanks and drainfields for their effluent is given, and soil percolation test methods are described.

sewage; septic tanks; percolation; analysis

2305 Feachem, R. G.
Ross Institute of Tropical Hygiene, London
School of Hygiene and Tropical Medicine,
London, England

Mara, D. D.
Dept of Civil Engineering, University of
Dundee, Scotland

Water and waste water engineering for low income communities in developing countries: discussion. Proceedings of the Institution of Civil Engineers, U.K Part 1. Vol. 62. 163-165. February 1977.

Arguments were put forward for providing more people with inferior water, and for the provision of water only if it was of safe quality. Sewerage was too costly for most developing countries. The aqua-privy sewerage system with treatment in waste stabilization ponds was advocated. Both night soil and sewage effluent could be utilized beneficially.

developing countries; low income; water supply; stabilization ponds; sewage treatment

2306 Public Health Service, U.S. Dept. of Health,
Education and Welfare, USA

Manual of septic tank practice. Public Health Service Publication No. 526. U.S. Dept. of Health, Education and Welfare, USA. 92p. 1969. 29 figures. 6 appendices. 34 references.

□ This guide deals in a comprehensive way with the design and construction of septic tanks and soil absorption systems, both for private residences and community installations. Particular attention is paid to the absorption capacity of different soils and its effect on design.

septic tanks; household; community; design; construction; USA

2307 Ministry of Environmental Protection, Norway
Kloakkutslipp fra spredt bolig-og fritidsbebyggelse. (Wastewater-disposal from households in thinly populated areas.) Ministry of Environmental Protection Publication, Norway. 52p. June 1975. 18 figures. 7 tables. 6 appendices.

This publication is issued by the Norwegian Ministry of Environmental Protection and contains guidelines for the solution of wastewater problems in low-density areas. The definition of "low-density" is given as seven dwellings or less in a limited area. The main principle given for the treatment is that wastewater should be infiltrated in the ground or alternatively purified in a sand-filter bed and then be

disposed of into a lake or stream. In regard to treatment in the ground, infiltration or resorption can be used. Before infiltration in the ground or in a sand filter the water has to be desludged. Detailed instructions are given for the construction of infiltration and resorption plants as well as for sand-filter beds. Tables for dimension pipes and recharge wells are prepared for different ground conditions. A diagram showing the importance of grain sizes for the infiltration capacity of the soil is given, and limitations are set up for soils recommended for infiltration. To give the infiltration plant a longer lifetime, it is recommended that two infiltration pipes or more should be in alternate use, and that the water should be distributed intermittently rather than constantly. (Original paper written in Norwegian.)

wastewater; resorption; sand filtration; on-site treatment; rural; construction; single houses; Norway

2308 Bouma, J.
Converse, J. C.
Otis, R. J.
Walker, W. G.
Ziebell, W. A.

(All) Small Scale Waste Management Project,
University of Wisconsin, Madison, USA

A mound system for onsite disposal of septic tank effluent in slowly permeable soils with seasonally perched water tables. Journal of Environmental Quality, USA. Vol. 4(3). 382-388. 1975. 6 figures. 3 tables. 9 references.

Slow permeable soils with seasonal high-water tables cannot be used for conventional subsurface disposal of septic tank effluent. An alternative mound system is described that consists of soil-covered seepage trenches on top of 60 cm of sand fill deposited on the original soil surface. The bottom area of the mound is large enough to allow soil absorption of the effluent. Monitoring data for four experimental mound systems and their design and construction criteria are discussed.

septic tanks; effluent; disposal; mound system; seepage pits; construction; criteria

2309 Obeng, L. E.
United Nations Environment Programme,
Nairobi, Kenya

Report on a UNEP schistosomiasis study tour of China. Unpublished Report, U.K. 1 and 8-10. 1977. 1 figure.

A three-compartment septic tank is described for use in sanitation programs designed specifically for parasite control. The parasite ova are retained in the sludge zones of the first two compartments, the liquid effluent from the third compartment containing only relatively few ova. In one area, prevalence rates for hookworm and ascariasis fell from 78% and 98% respectively to 2% and 36% respectively, after one introduction of septic tanks.

excreta; China; septic tanks; Ascaris; sanitation; hookworm

- 2310 Chowdhry, N. A.
Pollution Control Planning Branch, Ontario Ministry of the Environment, Canada
Sand and red mud filters ... an alternative media for household effluents. Water and Pollution Control, Canada. Vol. 113(2), 17-18. February 1975. 2 tables. 1 figure. 3 references.

For an area where the physical characteristics or depth of soil are not suitable for installing a conventional tile field, a sand filter of specific effective size and uniformity coefficient appears to be an effective device for the disposal of household waste. Filter sand mixed with "red mud," a waste by-product in the bauxite purification process, are reported to reduce the phosphate content in the waste by 90%.

septic tanks; effluent; disposal; alumized red mud solids; household; sewage; phosphorus; sand filtration

- 2311 Chuang, F. S.
C. E. Maguire Inc., New Britain, USA
Treatment of septic tank water by an anaerobic-aerobic process. Water Pollution Control Federation Deeds and Data, USA. D3, D8, D9, D10p. July 1976. 1 diagram. 6 references.

A report of laboratory studies on the treatment of septic tank wastes explains that pumped wastes were retained for 15 days in an anaerobic digester heated to 32 °C. The supernatant liquor was aerated for 40 days at ambient temperature and then passed through a sand bed. A 99% reduction of BOD, COD, and suspended solids was achieved.

septic tanks; sludge; anaerobic-aerobic ponds

- 2312 Clemesha, W. W.
University of Calcutta, India

Sewage disposal in the tropics. Thacker, Sprak & Co., India. 232p. 1910. Chap. 2. The design of the latrine. Chap. 10. Miscellaneous matters connected with the septic tank latrine. Chap. 14. The dumping-septic tank. Chap. 16. The final disposal of septic tank effluent. Chap. 17. The management and laying out of 'trenching grounds.' Chap. 18. The incineration of nightsoil.

□ This is a well-illustrated textbook on sewage and night-soil treatment practices in India up to 1910; many of the designs are still suitable for use in tropical developing countries today. Improved pit latrines, pour-flush latrines, and septic tanks are described, together with details of septic tank effluent disposal. The management of night-soil collection and treatment systems is discussed, with particular reference to incineration and trenching.

sewage; India; septic tanks; aqua-privies; incineration; management; excreta; seepage pits

- 2313 Duchinskii, B. M.
Department of Environmental Hygiene, Kiev Medical Institute, USSR

Effectiveness of subsurface filtration beds with respect to Salmonella. Journal of Hygiene and Sanitation, USSR. Vol. 35(10). 117-119. 1970.

An experiment was conducted to determine the effectiveness of *Salmonella* removal from septic tank effluents using subsurface filtration beds. The filtering bed is made of medium-grained sand 1 m thick. No contamination of groundwater is observed when an applied loading is less than 15 litres / day per running metre of the surface area. However, with a biologically matured filtration bed, a loading of 10 litres / day per running metre of irrigation network can be safely applied.

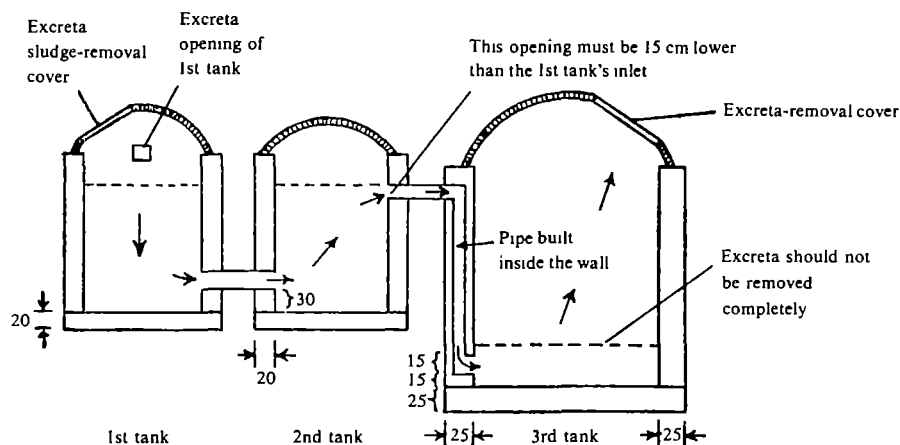

The Chinese three-tank toilet (from 2303).

USSR; *Salmonella*; loading; septic tanks; effluent; contamination; sand filtration

2314 Englov, P.
Synpunkter på infiltration av avloppsvatten. (Considerations about infiltration of wastewater.) Proceedings of Nordisk hydrologisk forening (Scandinavian Hydrologic Association) Conference, Denmark. 64-73. July 23-26, 1974. 3 figures. 2 tables.

Some Swedish infiltration plants for smaller communities have been examined to find out the effect of the treatment, the degree of groundwater pollution, and how the infiltration capacity is decreasing with time. The results show very high purifying effects in all of the infiltration plants. Soil analysis at different depths below the works shows that the main biological and physical-chemical purification takes place in the upper part of the soil layers. Analysis of groundwater in the surroundings of the works points at a BOD reduction of at least 90% and an almost complete phosphorus and colibacteria reduction. The polluting influence on the groundwater is noticed through increases in chloride, nitrate, and sulphate ion concentrations. With regard to the decreasing infiltration capacity, it is shown that a biological film is developed in the surface layer of the soil, which lowers the infiltration capacity. In this process the grain size distribution is important. After resting periods the infiltration capacity can rise again. The article is a summary of the results of a bigger investigation concerning wastewater infiltration carried out by the Swedish National Environmental Protection Board between 1970 and 1973. (Original paper written in Swedish.)

wastewater; infiltration; small communities; groundwater pollution

2315 Fetter, C. W., Jr.
Sloey, W. E.
Spangler, F. L.

(All) Department of Geology, University of Wisconsin / Oshkosh, Wisconsin, USA

Potential replacement of septic tank drain fields by artificial marsh wastewater treatment systems. Ground Water, USA. Vol 14(6). 396-402. November / December, 1976. 3 tables. 3 figures. 16 references.

A pilot-scale waste-treatment system using emergent marsh vegetation (bulrush, *Scirpus validus*) was employed to treat septic tank effluent. The plant, which grows in a gravel substrate in a plastic-lined trench, is capable of removing more than 70% organic and 99.9% coliform bacteria when it is loaded at 29 litres per square metre of surface area and a retention time of about 10 days. The author cites potential uses of this system for areas such as rural or summer houses where growth of bulrushes is possible.

septic tanks; effluent; organics; bacteria; loading; aquatic weeds; sewage treatment

2316 Fitzgerald, E. L.
Institute of Public Health, College of Medicine,
National Taiwan University, Taiwan

Study of two kinds of Japanese septic tanks. Memoirs of the College of Medicine of National Taiwan University, Taiwan 13(12). 138-153. April 1968. 5 tables. 10 figures. 8 references.

A study of treatment efficiencies of two septic tank systems in operation in Japan and Taiwan is reported. Although the system employing an anaerobic filter is reported to provide better organics and solids removal than the aerobic filter, information concerning their loading rates and operation is not available. Schematic drawings of the two systems are presented and the author urges further exploratory study toward a standard design.

septic tanks; Japan; Taiwan; anaerobic; filtration; aerobic digestion; loading; sewage treatment

2317 Goldstem, S. N.
Moberg, W. J., Jr.
(Both) National Demonstration Water Project,
Washington, D.C., USA

Wastewater treatment systems for rural communities. Commission on Rural Water Publication. U.S.A. 340p. 1973

□ This book is a guide to systems and components available for treating wastewaters in rural areas. A representative selection of equipment is presented in Appendix C that contains illustrations and data sheets abstracted from manufacturer-supplied information. Major categories of the contents include: self-contained systems, wastewater collection and conveyance subsystems, septic tank systems, and water consumption reduction techniques.

wastewater; rural; equipment; septic tanks; water saving; sewage treatment; night-soil collection

2318 Howard, J.
Lloyd, B
Webber, D.

(All) Oxfam, U K.

Oxfam's sanitation unit. Oxfam Technical Paper, U.K. 14p. July 1975. 8 tables. 2 diagrams. References.

Following 3 years of research and development work including microbiological studies, a prototype sanitation unit was tested during November and December 1974 at Dacca, Bangladesh. The unit consists of 20 squatting plates connected in series to two 21 000-litre flexible rubber sedimentation tanks that provide an 8-10 day retention time. Tests demonstrating reduction in *Vibrio cholerae* and *Salmonella* counts are described.

Bangladesh, construction; sewage treatment; community; public health; diseases; anaerobic; design; public toilets

2319 Hvatum, O. O.
PRA-prosjekt 3.5-infiltrasjon av avlopsvann og slam binding av fosfor i jord ved infiltrasjon av avlopsvann. (PRA-project 3.5-infiltration of wastewater and sludge binding of phosphorus from infiltrated wastewater in soil.) The publication is issued in the series "PRA-project 3.5-infiltration of wastewater and sludge" from: Agricultural University of Norway, Environmental Pollution Research Group, P C Boks 57, 1432 As-NLH, Norway. 58p. February 1977. 17 figures. 20 tables. 11 literature references.

Laboratory tests have investigated the phosphorus binding in various soil types. Cylinders were filled up with soil and both wastewater and phosphorus solutions of known concentrations were infiltrated. The changes in phosphorus content were measured after the tests in both the soil and the water. The results show that the binding capacity in soil from the B horizon in a podsol profile is much higher than that of the parent material. Addition of lime to the soil also proved to have a positive effect on phosphorus binding. The main part of the phosphorus was bound very weakly and could be leached out with distilled water. At high phosphorus charging (>200 mg / litre) the soil was saturated with phosphorus after 1-2 weeks of infiltration and thereafter the purifying effect sank below 20%. The highest purifying effect (72%) was obtained in soil from the B horizon with limestone powder spread in the soil. (Original paper written in Norwegian.)

phosphorus; wastewater; infiltration

2320 Impey, L. H.
Sewage treatment and disposal for small communities and institutions ... the development and use of the septic tank. Journal of the Proceedings of the Institute of Sewage Purification, U.K. No. 3. 311-317. 1959. 2 tables. 4 diagrams.

This paper gives points governing a decision to install a septic tank and deals in some detail with the design of subsoil irrigation systems. Three proved designs of septic tanks are described.

septic tanks; subsurface irrigation; design criteria

2321 Jewell, W. J.
Howley, J. E.
Perrin, O. R.
(All) Cornell University, Ithaca, USA

Design guidelines for septic tank sludge treatment and disposal. Progress in Water Technology, U.K. Vol. 7(2). 191-205. 1975. 8 diagrams. 4 tables. 21 references.

A report on laboratory tests to ascertain the treatability of septic-tank sludge is given. Methods used were aerated lagoons and aerobic digestion. Settling and dewatering characteristics of untreated and treated sludge were examined.

septic tanks; sludge; aerated lagoons; dewatering; aerobic digestion; design criteria

2322 Kamppi, A.
Erfarenheter fran system med infiltrationsdiken i Finland. (Experiences from systems with infiltration trenches in Finland.) Proceedings of Internationella vattenvarldsutställningen Varlden, Vattnet och V (International water management exhibition: the world, the water, and us), Sweden. Chap. 7. 161-171. September 1-5, 1975. 2 figures. 2 tables. 8 literature references.

In Finland there are huge areas of peat bogs. As a result some 15 smaller communities have chosen to infiltrate their wastewater in open ditches in the peat. The water is supplied to one ditch and after infiltration in the peat it is led away in another ditch some 15-30 m aside from the first ditch. It is important for the function that the ground be flat. The purification of the wastewater takes place in the upper part of the peat. The flat surface of the peat bog gives the water a low velocity, which is important from the purifying point of view. Comparisons between incoming and outgoing water show a purifying effect of around 60% for BOD₇, 30% for phosphorus, 40% for nitrogen, and some 80% decrease in enterococci. The system works most efficiently in the summer when the evapotranspiration is high. During the winter the biological activity is low and the purification is therefore also low. During snow melting in the spring and after heavy rains overflows may occur, which naturally lowers the purifying effect considerably. The method does not stand up to the demands set by the authorities for permanent dwellings, but according to the author it is a good solution for recreation huts with wastewater problems. (Original paper written in Swedish.)

wastewater; infiltration; open ditches; on-site treatment; peat bogs; Finland

2323 Khan, A. N.
Siddiqi, R. H.
(Both) National Environmental Engineering Research Institute, Nagpur, India.

Wastewater treatment by anaerobic contact filter. Indian Journal of Environmental Health, India. Vol. 18(4). 282-291. October 1976. 5 tables. 2 figures. 7 references.

A 2-year laboratory study treating a synthetic sewage in an upflow anaerobic filter at ambient temperatures of from 24 to 33 °C is reported. Reductions of 80% of COD were achieved at a loading rate of 225 lb COD / 1000 ft³ / day, with 8 hours detention time. The efficiency of treatment did not improve above a height of 4 ft of stone medium for the waste used (approximately 900 mg / litre COD).

sewage treatment; analysis; biological filters; India

2324 Klein, S. A.
Sanitary Engineering Research Laboratory,
University of California, Berkeley, California,
USA

NTA removal in septic tank and oxidation pond systems. Journal of the Water Pollution Control Federation, USA. Vol. 46(1). 78-88. January 1974. 11 figures. 2 tables. 12 references.

Sodium nitrotriacetate (NTA) is being considered as a partial replacement for phosphate builders in synthetic detergents. Field experiments indicate that aerobic percolation fields can degrade essentially all of the NTA from septic tank effluents containing concentrations up to 60 mg/litre. Little degradation of NTA is accomplished in anaerobic (saturated) soil columns. In oxidation ponds, after a 2-month acclimation period, removal of NTA is observed to be in excess of 90% when influent concentrations are in the range normally expected in wastewater (up to 30 mg/litre.)

NTA; wastewater; detergent; percolation; septic tanks; effluent; oxidation ponds

2325 Krafft, R. J. G.
Regional Office for Africa, World Health Organization, Brazzaville, Congo
Wastes disposal and drainage, Ibadan. Unpublished Report No. AFR/EH/131, Brazzaville, Congo. 16p. July 21, 1972.

A public toilet demonstration project was conducted in Ibadan, Nigeria. An aqua-privy system was introduced because it can satisfy many health requirements if properly used and maintained. This report includes design criteria, planning and construction procedures, and operation and maintenance of the demonstrated aqua-privy system.

Nigeria; public toilets; aqua-privies; public health; design criteria; planning; construction; maintenance

2326 Lindbak, P.
PRA-prosjekt 3.5-infiltrasjon av avlopsvann og slam — avlop fra spredt bolig — og fritidsbebyggelse. (PRA-project 3.5-infiltration of wastewater and sludge — wastewater from houses in thinly populated areas.) Published by Agricultural University of Norway, Department of Hydro-technique, Norway. 296p. February 1977. 52 figures and tables. 1 appendix. 68 literature references.

Desludged wastewater from single houses and smaller communities (up to 1100 population equivalent) in Norway has been infiltrated in artificial sand-filter trenches, and in some cases in natural soil layers. One test with combined resorption and infiltration has also been carried out. The purification effect regarding BOD₇, suspended material, phosphorus, and nitrogen has been measured. For six single-house sand-filter trenches the mean reduction of BOD₇ was 95%, of suspended material 68%, of phosphorus 75%, and of nitrogen 47%. No decline in the purifying effect during the test period (1972-77) was noticed. From the technical, managing, and pollution points of view no upper limit for the size of a sand-filter trench was found. Due to the areal need

and need of pipes, an economical upper limit is supposed to be around 100 population equivalent, above which conventional purifying plants are preferred. If the geological and hydrological preconditions for infiltration in natural soil layers are good, that method is superior to artificial filters. (Original paper written in Norwegian.)

wastewater; infiltration; resorption; sand-filter trenches; biological filters; on-site treatment; rural; single houses

2327 Machmeier, R. E.
Agricultural Extension Service, University of Minnesota, USA

How to run a percolation test. Extension folder 261. Agricultural Extension Service, University of Minnesota, USA 6p. 1971. 2 tables. 2 figures.

This manual describes how to run a percolation test for the determination of trench bottom area required to absorb septic-tank effluent. Methods of percolation measurement and calculation of the percolation rates are presented.

USA; percolation; septic tanks; effluent; seepage pits

2328 Majumder, N.
Prakasam, T. B. S.
Suryaprakasam, M. V.
(All) Section of Sanitary Engineering, All India Institute of Hygiene and Public Health, Calcutta, India

A critical study of septic tank performance in rural areas. Journal of the Institution of Engineers, India. 743-761. 1960. 10 tables. 5 figures. 10 references.

In the absence of underground sewers, septic tanks may be used for treatment of sewage. A survey conducted in India indicates that they can function well even when the sewage is comparatively strong. However, the presence of hookworm and *Ascaris* eggs in septic-tank effluents poses a potential health hazard. Some hygienic techniques are suggested such as a subsurface disposal of the septic-tank effluents and the use of dip pipes for withdrawal of septic-tank sludges.

septic tanks; sewage; India; hookworm; Ascaris; effluent; public health; hygiene; subsurface disposal

2329 Malan, W. M.
National Institute for Water Research, Pretoria, South Africa

A guide to the use of septic tank systems in South Africa. CSIR Research report 219. Council for Scientific and Industrial Research, South Africa. viii +40. 1964. 6 tables. 12 figures.

The basic scientific principles underlying the design of septic-tank systems and the considerations that will ensure the most successful functioning of the tank and disposal of the effluent are discussed. The

influence of a scientifically designed septic-tank system of sewage disposal on public health is considered, as well as the effects of such factors as synthetic detergents, disinfectants, grease traps, and racial diets on the design and operation of the system. The relative merits of the separate and combined methods of disposal are given, together with instructions on starting a new tank and the maintenance of the system. Design criteria are suggested and useful data are given on the volume of sewage to be expected, the best location for the tank and the capacities suitable for different communities, provision for the storage of sludge, ventilation, and the materials suitable for construction. A soil-percolation system designed in terms of soil type as indicated by a percolation test or visual observation and the possibility of applying the principle of evapotranspiration to soils relatively impervious to water, as well as to areas with a high water table, are described.

Africa; septic tanks; percolation; evapotranspiration

2330 Mann, H. T.
Water Research Centre, Stevenage, U.K.
Sanitation without sewers — the aqua-privy. Building Research Establishment, Overseas Building Note No. 168, U.K. 8p. June 1976. 3 figures.

Following a review of the principal methods of excreta disposal in sewerless areas, the author describes in detail the aqua-privy and gives sketch designs of its various modifications: (1) a conventional aqua-privy connected to an evapotranspiration trench; (2) a double chamber aqua-privy made from standard precast concrete pipe discharging into a seepage pit; and (3) a simple aqua-privy made from five oil drums connected in series, drums no. 3 and 4 being filled with loose twigs and drum no. 5 discharging into a seepage pit

aqua-privies; latrines; excreta; septic tanks; design

2331 Oluwande, P. A.
University of Ibadan, Nigeria, Africa
A simplified approach to aqua privy construction. *Appropriate Technology*, U.K. Vol. 3(3). 26-28. November 1976. 6 figures. 1 table. 4 references.

An aqua-privy system is considered to have greater potential for use in developing countries than the pit-latrine or septic-tank systems because, if properly managed, it can function without odour or fly breeding and with less cost. Three simple methods of construction for incorporating an inlet drop pipe to the aqua-privy floor slab are described in detail, with the use of local materials suggested.

aqua-privies; pit latrines; septic tanks; construction; materials

2332 Patterson, J. W.
Minear, R. A.

Nedved, T. K.
(All) Illinois Institute of Technology, Chicago, USA

Septic tank and the environment. Report No. IIEQ 71-2, USA. 107p. June 1971. 4 figures. 7 tables. 127 references.

This report reviews and evaluates the available literature on septic tanks, and the influence of septic tanks on public health and environmental quality. The consistently poor performance of septic tanks indicates that other waste-disposal methods are necessary in densely populated areas and that more rigorous regulation of design criteria, installation, and operation are required in sparsely inhabited areas suitable for septic tank installations.

septic tanks; public health; design criteria; installation

2333 Peel, C.
Elsan Sewage Systems Limited, London, U.K.
Design, operation and limitations of septic tanks. Public Health Inspector, U.K. 328-334. April 1966. 6 tables. 6 references.

The article describes the pollution resulting from the untreated discharge of septic tank effluents and the biological processes in the tank. Secondary aerobic treatment by percolating (trickling) filters and subsurface irrigation are compared, and previously published reports of performance of septic tanks and filters in terms of suspended solids, BOD, and *E. coli* are cited and discussed. Design criteria and advice on maintenance are outlined.

septic tanks; design; maintenance; effluents; trickling filters

2334 Raman, V.
All India Institute of Hygiene and Public Health, Calcutta, India
Secondary treatment and disposal of effluent from septic tank: — 1 — disposal by subsurface soil absorption systems; — 2 — disposal on land, underground and water; — 3 — methods of treatment. *Journal of Institution of Engineers, Public Health Division, India*. Vol. 48(10). Part PH3. 213-221. June 1968; Vol. 49(2). Part PH1 23-30. October 1968; Vol. 49(6). Part PH2. 86-89. February 1969. 16 diagrams. 24 references.

■ This was a field experiment conducted at three locations in India on treatment of septic-tank effluents using anaerobic upflow gravel filters. About 60-70% reduction of 5-day biochemical oxygen demand and suspended solids are reported, with the treated effluents relatively free from any odour. Schematic drawings of the system are shown in detail. The authors site no serious operational problems during the 18-month investigation.

subsurface irrigation; percolation; evapotranspiration; seepage pits; septic tanks; effluents; stabilization ponds; trickling filters; sand filtration

- 2335 Reid, G. W.
Bureau of Water and Environmental Resources
Research, The University of Oklahoma, Norman, Oklahoma, USA
A catalog of water supply and waste disposal methods for individual units. A report prepared for the U.S. AID project on Lower Cost Methods of Water and Wastewater Treatment in Less Developed Countries, USA. 183p. October 1975. 183 figures.
The purpose of this manual is to provide a collection of methods of water supply and waste disposal for individual units; however, some practices compiled are also applicable to groups of housing units. This manual consists of 183 figures taken from published literature listed in the reference table. A list of subjects assists in locating topics of interest. No explanation or discussion was given of the various possible methods, further documentation being possible by consultation of the reference list. Many of the methods compiled are currently in use in small communities of developed countries, though it is believed that the various methods in the manual would be appropriate for less-developed countries.
developing countries; waste-disposal systems, small communities; bibliography
- 2336 Ross Institute Industrial
Advisory Committee
London School of Hygiene and Tropical
Medicine, London, U.K.
Rural sanitation in the tropics. The Ross Institute Information and Advisory Service, U.K. Bulletin No. 8. 18-22 and 33-35. April 1972 5 figures. 7 references.
An aqua-privy system for family and communal types, essentially designed for arid areas, is described. Effluent from the privy tank is discharged into either a septic tank or a seepage pit. Although this system costs approximately the same as the waterborne latrine, it can stand more abuse. Methods of operation and maintenance are also described
aqua-privies; community; arid climates; septic tanks; seepage pits; maintenance; public toilets
- 2337 Sauer, D. K.
Boyle, W. C.
Otis, R. J.
(All) Dept. of Civil and Environmental Engineering, University of Wisconsin, Madison, Wisconsin, USA
Intermittent sand filtration of household wastewater. Journal of the Environmental Engineering Division, American Society of Civil Engineers, USA. 102(EE4). Proceeding paper 12295. 789-803 August 1976. 3 figures. 10 tables. 9 references.
Intermittent sand filtration of septic tank and aerobic unit effluents is investigated as a feasible on-site wastewater treatment technique and disposal system. Sand filters have been constructed and monitored at two home sites in Wisconsin. The hydraulic loading rates ranging from 2 to 20 gal per day / ft² are used. Operating data, including effluent qualities, methods of rejuvenation, and costs of the sand filters, are presented.
septic tanks; wastewater; sewage treatment; costs; USA; sand filtration
- 2338 Schwiesow, W. F.
Soil and Water Division, Steering Committee,
American Society of Agricultural Engineers,
St. Joseph, USA
Bibliography of rural and suburban sewage treatment and disposal publications. Special publication SP-03-73 published by the American Society of Agricultural Engineers, USA. 27p. 1973
A bibliography of on-site rural and suburban sewage treatments that have been in practice in various states of the USA are given. The common system employed is the septic tank; some literature on pit latrines is available but date back to the early 1900s. A total of 401 bibliography titles are included.
on-site treatment; USA; rural; septic tanks; pit latrines; bibliography
- 2339 Sebastian, S.
Buchanan, I. C.
(Both) Medical and Health Dept., Anguilla,
British West Indies
Feasibility of concrete septic privies for sewage disposal in Anguilla, B.W.I. Public Health Reports, USA. Vol. 80(12). 1113-1118. December 1965. 3 figures.
A two-compartment septic privy (aqua-privy with box seat rather than squatting plate) made from two 3-ft (0.9-m) lengths of 3-ft (0.9-m) diameter precast concrete pipe is described for use in households of up to five people Effluent disposal is by evaporation and percolation from a long, shallow, rubble-filled trench. Experience over 7 years showed that there was minimal sludge accumulation in the privy and no odour nuisance. Public acceptance of the system was reported to be good.
Anguilla; Caribbean; aqua-privies; concrete latrines
- 2340 Shetty, M. S.
College of Military Engineering, Poona, India
Septic tank design, construction and maintenance practices. Seminar on water supply and sanitation problems of urban areas. Public Health Engineering Division The Institution of Engineers, India. Vol. II. Paper D-5. 21p. April 8-9, 1971. 3 tables.
From a study of literature the author makes recommendations for tank capacity and construction methods for effluent disposal, and tank maintenance is reviewed.
septic tanks; design; construction; maintenance

2341 Skaarer, N.
PRA-prosjekt 3.5-infiltrasjon av avlopsvann og slam bruk av resorpsjon som mottaker av avlopsvann. (PRA-project 3.5-infiltration of wastewater and sludge use of resorption as wastewater treatment.) The publication is issued in the series "PRA-project 3.5-infiltration of wastewater and sludge" from: Agricultural University of Norway, Environmental Pollution Research Group, P.C. Boks 57, 1432 As-NHL, Norway. 47p December 1976. 5 figures. 11 tables. 4 appendices. 59 literature references.

The report discusses resorption as a method for wastewater treatment. The theory behind resorption is described. The amounts of different pollutants from households (total amount of water, phosphorus, and nitrogen) are estimated. On the basis of the hydrological balance equation, the space for additional supplies of wastewater to the ground under Norwegian weather conditions is discussed. In most places in Norway it is only during a few summer months that there is a space for resorption. During the rest of the year the rainfall is higher than potential evapotranspiration. In spite of this the author finds the method interesting, and he feels that more research and practical tests should be done in this field. Advice and guidelines for construction of resorption plants as well as figures of areal demand and the need for pipes are given. (Original paper written in Norwegian.)

wastewater; resorption; evapotranspiration; nutrients; on-site treatment, Norway

2342 Sproul, O. J.
Dept. of Civil Engineering, University of Maine, Maine, USA

Virus movement into groundwater from septic tank systems. Proceedings of a Conference on Water Pollution Control in Low Density Areas, USA. Paper No. 12. 135-144. September 26-28, 1973. 4 tables. 18 references.

Data from many experiments conducted in the USA indicate the presence of viruses in the effluents from soil and sand columns receiving septic tank effluents. However, with a long absorption distance such as filtration through 200 ft (ca. 60 m) of an 8-12-ft (ca. 2.4-3.7-m) layer of sand and gravel, no viruses could be detected in the effluents. The author proposes criteria to promote virus removal in the soil and discusses some research needs for this area.

USA; viruses; effluents; soils; sand; septic tanks; absorption; criteria; filters

2343 Teodorovic, B.
University of Zagreb, Yugoslavia

A modified septic (LRS) privy. World Health Organization, Switzerland. Unpublished report. WHO / WD / 68.3. 5p. 1963. 2 figures. 13 references.

■ A modified septic privy (an aqua-privy with a raised covered seat rather than a squatting plate) with two compartments is described. The retention time in

the first compartment is 90 days (capacity 0.3 m³ for a family of five) and in the second compartment 180 days. Samples of digested excreta taken from 30 modified privies in Yugoslavia between April and August 1965 (mean monthly temperatures 9-20 °C) indicated that absence of viable *Ascaris* ova, although in 12 of 13 unmodified privies with only 1-month excreta retention in the first compartment, viable eggs were found.

aqua-privies; excreta; pathogens; Ascaris; Yugoslavia

2344 Viraraghavan, T.
Warnock, R. G.
(Both) Dept. of Civil Engineering, University of Ottawa, Ottawa, Canada

Treatment through soil of septic tank effluent. Paper presented at International Conference on Land for Waste Management, Canada. 17p. October 1973. 4 tables. 4 graphs.

Results of a field investigation of the disposal of septic tank effluent through an 8-metre lay field drain are given. The soil removed a high percentage of BOD, COD, ammonia nitrogen, total phosphorus, iron, and bacteria.

septic tank effluent; subsol irrigation; sewage treatment

2345 Wagner, E. G.
Lanoix, J. N.

Excreta disposal for rural areas and small communities. World Health Organization Monograph No. 39, Switzerland. 121-155. 1958. 46 references. 13 figures. □ The author describes small-scale waterborne waste-disposal systems for rural areas, with particular emphasis on the design and construction of septic tanks and the proper disposal of effluent.

night-soil collection; rural; disposal; design; construction; septic tanks; sewerage

2346 Webber, D.
Department of Biological Sciences, University of Surrey, Guildford, U.K.

An investigation of the survival of *Vibrio cholerae* biotypes in anaerobic sewage sludge liquor, in relation to the development of emergency sanitation systems. A B.Sc thesis in Microbiology, Department of Biological Sciences, University of Surrey, U.K. 89p. 1974. 9 tables. 6 figures. 82 references. 2 appendices.

Factors involved in the survival of *Vibrio cholerae* biotypes in anaerobic sewage sludge liquor were investigated. The experimental conditions employed are designed to simulate those of the Oxfam emergency sanitation system. The results indicate a rapid decline in organism numbers over a 2-week period; however, higher numbers survive this period with increasing solid concentration. The addition of urine caused a marked rise in the pH of the liquor,

although with no significant difference in the survival levels of the organisms. A broad survey of survival of *V. cholerae* in different mediums is included.

Vibrio cholerae; anaerobic; pathogens; urine; pH; solids

2347 Winneberger, J. H. T.
Septic Tank Systems, Berkeley, USA

Ryon's septic-tank practices corrected. Proceedings of the National Home Sewage Disposal Symposium. USA. 215-221 December 9-10, 1974. 8 references.

Contrary to traditional belief, studies conducted in the USA have demonstrated that bottom areas of absorption fields for disposal of septic-tank effluents are considerably less useful than side-wall areas. A concept of alteration of disposal fields is proposed in which two absorption fields are used 1 year at a time. This system is reported to be capable of extending many times the lifespan of the disposal fields.

USA; septic tanks; seepage pits; effluents; disposal

2348 Bendixen, T. W.
Berk, M.
Sheehy, J. P.
Weibel, S. R.
Coulter, J. B.

Studies on household sewage disposal systems. Parts II and III. U.S. Department of Health, Education and Welfare, Public Health Service, Bureau of State Services, Division of Sanitary Engineering Services, Robert A. Taft Sanitary Engineering Center, Cincinnati, Ohio. 1950. 1952. 1954. Part II. 37 plates. 31 tables. 23 references; Part III. 52 plates. 75 tables. 57 references.

These are research reports on individual sewage-disposal systems mainly concerning the research studies and laboratory work done on septic tanks and related aspects. Design practices across the United States and many different parts of the world are studied; technical aspects like inlets and outlets, percolation capacity, soil-clogging effects, sludge and scum accumulation, etc., are also discussed.

sewage; septic tanks; disposal

2349 Campbell, P. A.
University of Nairobi, Nairobi, Kenya
Mara, D. D.
University of Dundee, Dundee, Scotland

A septic tank system for use on black cotton soil. Proceedings of a Seminar on Sewage Treatment, Department of Civil Engineering, University of Nairobi, Nairobi, Kenya. 41-47. 1973. 6 references. 2 figures.

This paper describes the design of a septic tank for use on black cotton soil. The design of this septic tank has an additional filter built in within the second compartment of an ordinary septic tank. The second

compartment is expanded a bit to better accommodate this filter. The filter is submerged and operates under upward (reverse) flow. The septic tank effluent enters at the base, flows upward through a layer of coarse filter media about 0.5 m deep, and is discharged over a weir at the top. Anaerobic bacteria grows on the surface of the media and oxidizes the effluent as it passes by. It is reported that these filters can effect 70% reduction in BOD and change malodorous, highly turbid, grey-to-yellow influent to an odourless, clear, light-yellow effluent.

septic tanks; design; filters; anaerobic

2350 Ehlers, V. M.
Steel, E. W.

Municipal and rural sanitation. Sixth edition. McGraw-Hill Series in Sanitary Science and Water Resources Engineering. 105-131. 14 references. 20 figures.

□ The collection and safe disposal of human wastes are among the most important problems of environmental health. In this chapter, methods of treatment and disposal of human excreta, using on-site methods, are discussed. Soil characteristics along with excreta and sewage characteristics and bacteriology are studied. Fundamentals of the septic tank, its capacity, the cesspool, large septic tanks, and seepage pits/disposal fields are explained. Design and operation guidelines for septic tanks of various sizes using different types of filters to answer the needs of changing soil conditions are provided.

excreta; sewage; septic tanks; design; on-site treatment

2351 Mara, D.
University of Dundee, Dundee, Scotland, and
University Federal da Paraíba, Brazil

Current design capabilities in appropriate sanitation technologies. Sanitation in Developing Countries Today. A conference sponsored by Oxfam with the Ross Institute of Tropical Hygiene, 5-9 July 1977, Pembroke College, Oxford 3-10. 14 references. 3 figures.

Four alternatives to the conventional sewerage system, according to the author, are the latrine (improved pit latrine, borehole latrine), the compost toilet, the aqua-privy, and night-soil cartage systems. The aqua-privy is studied in detail, and current design problems and limitations are pointed out. Using the available historical data and analysis of existing aqua-privies, new design proposals are made.

urban; tropics; developing countries; sewerage, disposal, design

2352 Oluwande, P. A.
Aqua privies in Nigeria. Sanitation in Developing Countries Today. A conference sponsored by Oxfam with the Ross Institute of Tropical Hygiene, 5-9 July

1977, Pembroke College, Oxford. 1 figure. 10 references.

This paper discusses the potentials of the aqua-privy as a method for excreta and sewage disposal in Nigeria and other developing countries. The practical problems that were encountered when it was introduced to communities in Nigeria are outlined. Steps taken to solve the problems are also given.

aqua-privies; Nigeria; developing countries; socio-economic

2353 Stephenson, J. W.
Public Health Department, Billesdon, RDC
Common defects in design and construction of septic tanks. Municipal Engineering (U.S.). 705-796. April 19, 1968. 7 figures.

Common defects in design of septic tanks are described. From his wide experience the author has observed the following seven commonly committed errors: (1) size of the septic tank is too small; (2) inlet and outlet are placed on the shorter instead of longer sides; (3) inlet and outlet are placed at one corner; (4) compartments have poor proportions; (5) there is poor design of inlets and outlets; (6) there is a missing, hanging, or wrong baffle; (7) inlet is too deep, which could force the sludge to flow out and block up the drain field.

septic tanks; anaerobic; design; construction

2354 Warshall, P.
Septic tank practices. Box 42, Elm Road, Bolinas, California 94924, USA. To be published again in May 1978 by Doubleday / Anchor. 17 references.

This book presents a brief survey of the present practices of waste management. After pointing out major problems associated with each system, it goes on to discuss at length septic tank practices. The

following topics are also covered: behaviour of soil; aerobic vs. anaerobic conditions within soil; using soil characteristics to our advantage in the design of drain fields; laying drain fields in different types of site and soil conditions; sizing the tank; planning and constructing septic tanks with ecological considerations; saving water; maintaining the septic tank; sewerage problems related to small communities; and other related topics.

2355 Winneberger, J. H. T.
Francis, L.
Klein, S. A.
McGauhey, P. H.
(All) Sanitary Engineering Research Laboratory, College of Engineering and School of Public Health, University of California, Berkeley, USA

Biological aspects of failure of septic tank percolation systems (final report). Sanitary Engineering Research Laboratory, College of Engineering and School of Public Health, University of California, Berkeley. August 31, 1960. Reprinted April 1977. 44 figures. 10 tables. 24 references.

□ In this report, results of studies conducted at the University of California over a period of 27 months are presented. The scope of these studies include: an evaluation of pertinent literature, with special attention to the relevance of data previously obtained by the University of California in studies concerned with infiltration and percolation phenomena; a study of the relationship of infiltration rate to surface area per unit cross-section of a porous soil; a preliminary study of the possibility of confining clogging to the surface of pit liners, from which it might be removed to reestablish original infiltration rates; an evaluation of the relative importance of mechanical clogging and the growth of biological slimes in reducing soil infiltration rates under aerobic and anaerobic condi-

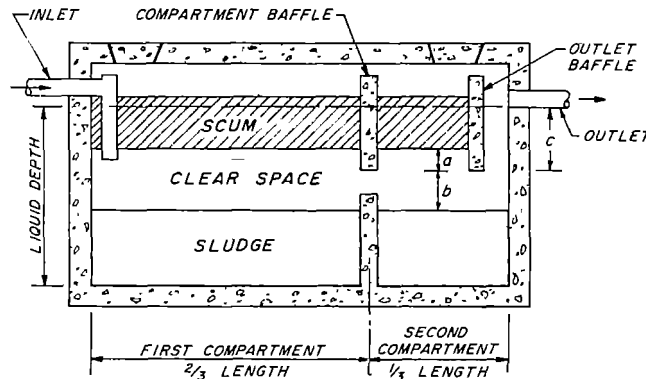

Two-compartment septic tank: a, scum clear space (75 mm minimum); b, sludge clear space (300 mm minimum); c = 40% of liquid depth.

tions; studies of the mechanism of clogging by both biological and physical means; a study of the effects of intermittent dosing on soil clogging and on the quality of the percolating liquid; an observation of the effect of percolation on the quality of effluent from aerobic and anaerobic tanks; development of appropriate research techniques.

septic tanks; aerobic digestion; anaerobic; infiltration; biological treatment

2356

Raman, V.
Chakladar, N.

(Both) National Environmental Engineering
Research Institute, Zonal Laboratory, Bombay,
India

Upflow filters for septic tank effluents. Journal of the Water Pollution Control Federation, USA. Vol. 44(8). 1552-1560. August 1972 3 figures. 3 tables. 5 references

The use of septic tanks for treatment of sewage from individual houses or isolated institutions is well recognized. However, the septic tank itself does not fulfill the object of complete sewage treatment because its main function is to remove suspended solids from the sewage, to liquefy the major portion of solids that have been retained, and to condition the sewage to facilitate further disposal in a soil-absorption field. The pathogenic bacteria, cysts, and worm eggs may pass through the tank practically unharmed, the effluent is highly septic and stale, becomes malodorous, and has a high oxygen demand. Due to its potential health hazard and nuisance, further treatment or means of satisfactory disposal of the effluent from the septic tank becomes necessary before its discharge into the environment. These four papers describe the secondary treatment and disposal methods of the septic tank effluent, which are usually based on biological degradation and (or) discharging it into land, surface water course, and subsurface and underground water, respectively. The subsurface tile-field disposal or soakage gallery is the most common system used where sufficient land is available, the subsoil is reasonably porous, and the groundwater table is at least 1.5-1.8 m below ground level. Tile pipes, which are placed at a depth of 45-100 cm below the ground surface, should be laid at an average gradient of 0.25-0.50% and the filtering materials employed should be washed gravel, broken stones, or burnt slags of 12-60 mm size and should surround the pipe with a minimum of 100-150 mm at the bottom and 50 mm at the top. Design formula to determine the absorptive capacity or the allowance rate of application of sewage per area of soil is presented, which is based on a standard percolation test at the site. However, recent investigations have shown that the infiltration rate of sewage into the soil is a factor more critical than the rate of percolation within the soil to control failure of the subsurface

percolation systems. On the other hand, the ability to infiltrate water or sewage is a function of the clogging materials rather than of the original soil. Thus, the largest contributing factor to the failure of percolating systems is microbiological activity when suspended and dissolved solids are present. The most probable cause of ultimate clogging is the occurrence of ferrous sulfide in association with the anaerobic activity within the systems. The optimum combination of criteria for preventing failure of the soil absorption system is as follows: avoidance of continuous inundation of the infiltrative surface; maintenance of aerobic conditions in the soil; maintenance of the infiltrative surface initially similar to the internal plane of undisturbed soil; uniform and simultaneous loading of the entire infiltrative surface if feasible; filling the trench with material graded uniformly from coarse gravel at the centre of the trench to sand of almost the same size as soil particles at the side wall; provision of maximum of side wall surface per unit volume of effluent and a minimum of bottom surface; and proper functioning of the septic tank resulting in effluent with a minimum amount of suspended solids and nutrients. Alternatives to the subsurface soil-absorption system for disposal of the septic tank effluent are available. They include: evapotranspiration; surface irrigation; soakage pit; dilution in water courses; sand filters, subsurface or open; trickling filters; oxidation ponds or ditches; and chlorination. Design criteria and construction methods of those systems are briefly discussed. However, their applications are relatively limited as compared to the subsurface soil absorption system and their uses should only be considered on a case-by-case basis. Another promising alternative is the use of anaerobic upflow gravel filter operation under submerged conditions for treatment of septic tank effluent. Results of laboratory and field studies in India are encouraging. After a maturing period of 3 months, a BOD removal from 65 to 75% is achieved when influent BOD is from 170 to 240 mg/litre. Suspended solids removal averages 53-60% with influent ranges between 350 and 450 mg/litre. Flow rates of the septic tank effluent are reported to be intermittent and range from 40 to 60 litres/day for the systems employed. The authors report that the filters can function continuously for at least 18 months without any need for cleaning. Washing of sludge from the filter, which should be done once or twice yearly, can be accomplished by emptying the filter through the bottom and pouring water from the top. Experience with the use of upflow filters favours 1.25-1.90 cm medium filled to a depth of 68-90 cm. For better efficiency, the top 7.5 cm may be filled with 0.32-0.64 cm media. Per capita filter capacity for these filters is 42-58.0 litres. Effluent from the upflow filters can also be disposed of into the subsurface soil absorption system.

India; anaerobic; filters; upflow filters; septic tanks; effluents; suspended solids; odours; BOD

3. Collection and Off-Site Treatment

3001 Adams, E. G.
University of Oklahoma, Norman, Oklahoma,
USA

Cost effectiveness of the socio-cultural and health benefits of sewerless alternatives for domestic waste disposal in developing countries. A report submitted to the Office of Health, U.S. AID, USA. 105p. March 1976. 12 figures. Numerous references.

Cost-effective analysis of sewerless alternatives versus conventional treatment systems for domestic waste disposal in developing countries have been carried out. The above analysis utilizing decision-weighting models is considered necessary for placing some value on the importance of varied considerations and summing these values for each alternative when considering projects where real data or data sources are inadequate. Methodology of the decision weighing and selection of criteria and subcriteria for each specific case are addressed in detail. Results of a comprehensive survey of waste-disposal systems, both conventional and nonconventional, and hardware manufacturers on available systems are included.

cost effectiveness; developing countries; waste-disposal systems

3002 Danmarks Geologiske Undersogelse, Thoravej
31, 2400 Kobenhavn NV, Denmark
Nedsivning af husspildevand i bassinanlaeg ved Frederiks. (Infiltration of household wastewater at Frederiks.) Miljostyrelsen Kampmannsgade 1. ISBN 87-503-2052-1. 1604 Kobenhavn V, Denmark. 31p. Issued August 1976. 1 figure. 3 tables. 20 appendices. 4 references.

Geohydrological investigations in the small community of Frederiks were carried out in connection with an infiltration plant for wastewater. The plant has been in use since 1965 and treats water from households and a dairy. The amount of wastewater in 1975 was measured as up to 287 m³/day. The infiltration capacity was determined to be 60 mm/day over an area of 4000 m². Observations are made regarding both the spread of wastewater in the soil downstream of the plant and how the chemical / physical composition of the water is changed during its transport in the soil. The water-bearing material consists of water-transported glacial sand and gravel. The infiltration of wastewater raises the groundwater level about 10-20 cm around the plant, which affects the groundwater flow in a way that makes the field of wastewater flow many times wider than the infiltration basin. Comparisons of the chemical composition of the water in the basins and the groundwater were made at various distances from the plant. The analysis shows a high reduction of phosphorus and nitrogen content in the water increasing with the distance from the plant. The concentration of chloride, on the other hand, does not decrease in the same way and therefore

it is suggested that Cl⁻ is used as an indicator of wastewater pollution in groundwater. (Original paper written in Danish.)

wastewater; infiltration; groundwater pollution; chloride; phosphorus; nitrogen

3003 James M. Montgomery Consulting Engineers
Inc., Pasadena, California, USA

Water supply and sewerage facilities for Taiz, Yeman Arab Republic. Wastewater System. Unpublished report to United States Department of State Agency for International Development. Contract No AID/ASIA-C-1081. Vol. 1. Chap. 9. 23p. April 30, 1975. 1 figure.

Proposed wastewater collection is conventional waterborne. Considering the extremely limited supply of water available, it was decided to reclaim sewage water by recharge into the groundwater basin. Five systems are evaluated: neighbourhood septic tanks, raw sewage lagoons, mechanically aerated lagoons, Imhoff tanks, and trickling filters. Trickling filters are chosen as the optimum system with low maintenance. Sewage flows through primary sedimentation tanks, two stages of trickling filters, secondary tanks, and through percolation beds.

Yeman Arab Republic; trickling filters; septic tanks; aerated lagoons; economics; sewerage; stabilization ponds

3004 Instituto Nacional para Programas Especiales de
Salud, División de Saneamiento Basico Rural
Sección de Promoción, Bogotá, D.E., Colombia
Manual de procedimientos en promoción comunitaria para el programa nacional de saneamiento basico rural. (Manual for community promotion for the national program for basic rural sanitation.) Instituto Nacional para Programas Especiales de Salud, División de Saneamiento Basico Rural Sección de Promoción, Bogotá, D.E., Colombia. 120p. January 1975. 2 tables. 26 annexes.

The Colombian National Program for Basic Rural Sanitation has five consecutive and clearly defined stages: (a) study of the community; (b) preparation and approval of the project; (c) motivation promotion and organization of the community; (d) construction of the works; and (e) administration and supervision of the works. This paper presents the methods and activities to complete each phase. Twenty-six well-prepared annexes provide all the complementary information to undertake each step. Examples of how to determine labour input, followed by payments for the works, etc., are also included. (Original paper written in Spanish.)

Latin America; rural sanitation; excreta disposal; community development; water supply

3005

Swedish National Environmental Protection Board, Sweden

SNV publikation 1974:15. Sma avloppsanlaggningar, rening av spillvatten från enstaka fastigheter. (SNEP publication 1974:15. Small scale wastewater treatment plants, wastewater-treatment for single houses.) Swedish National Environmental Protection Board, Sweden. No. 1974.15 in the series "SNV Publikationer." ISBN 91-38-02022-X. 17p. 1974. 6 figures. 3 appendices. No references.

This publication is issued by the Swedish National Environmental Protection Board to serve as a guideline for treatment of wastewater from single houses used all year round that cannot be easily connected to conventional wastewater purifying plants. Three methods for treatment are suggested and described: (1) infiltration in natural soil; (2) treatment in sand-filter trenches; (3) treatment in single-house purifying plants. Advice is given about the design of infiltration plants, suitable dimensions of pipes and wells, and the geological preconditions necessary for infiltration. A method for testing the suitability of different natural soils for infiltration is given. The construction of simple artificial sand-filter trenches is briefly described for cases where natural infiltration is unsuitable. The first step of purification when both these methods are used must be to desludge the wastewater. A method for this is described. A short description of principles and working methods of single-house purifying plants is given. (Original paper written in Swedish.)

wastewater; infiltration; sand-filter trenches; on-site treatment; single houses; rural; small-scale purifying plants; sewage treatment; construction

3006

Taiwan Institute of Environmental Sanitation (PHA), Taipei, Taiwan

The study of microbial treatment of nightsoil. A report prepared by Taiwan Institute of Environmental Sanitation PHA, Taipei, under contract with the University of Oklahoma Project on Lower Cost Methods of Water and Waste Treatment in Developing Countries. (U.S. AID Contract No. AID / CM-ta-C-73-13) 31p. February 1976 7 tables. Plus an appendix.

■ In Taiwan there are few sanitary sewerage systems in the cities or towns, and treatment of large amounts of night soil has become a very serious problem. The Taiwan Provincial Institute of Environmental Sanitation has run studies on the treatment of night soil, using anaerobic digestion for night-soil treatment and activated sludge for the supernatant. The problem of the bulky sludge remained. Therefore an experiment was devised using a combined microbial method for night-soil treatment. A genus of photosynthetic bacteria (purple nonsulfuric bacteria) and *Chlorella* were used to decompose the organic matter in night soil to make it stable. The multiplied photosynthetic bacteria and *Chlorella* contain protein and can be collected for animal feed. Aerobic digestion was used for the pretreatment of the night soil. The digested liquid was then used to culture the photosynthetic bacteria (PSB). After collection of the PSB, the remaining liquid was diluted and used to culture *Chlorella*. The conditions that produced the most *Chlorella* and the best BOD removal were found to be the use of a culture liquid BOD of 400-420 mg / litre, a tank depth of 30 cm, and a culture duration of 3 days. (If it were possible to devise a method to use a greater depth of tank, the land area required and thus the cost of the process could be reduced.) Following culture of the *Chlorella*, the liquid was centrifuged to collect *Chlorella*; then it was chlorinated and discharged. The PSB obtained on a dry basis was 0.4 g / litre of culture liquid, or 0.404 kg (dry basis) for 1 metric tonne (t) of night soil. Under continuous operation conditions, *Chlorella* obtained was 0.831 kg (dry basis) for 1 t of night soil.

night-soil treatment; Taiwan; bacteria; algae

3007

Chen, C. S.

Environmental Engineering Division, Asian Institute of Technology, Bangkok, Thailand

Development of tropical design criteria for biological disc filtration. Master of Engineering thesis no. 590. Asian Institute of Technology, Thailand. 104p. 1973. 31 tables. 24 figures. 30 references. 2 appendices containing 18 figures.

A report on research studies of performance of a rotating biological disc filter unit incorporating an anaerobic compartment for solids digestion is given. For disc areal loadings between 16 g COD / m²d and

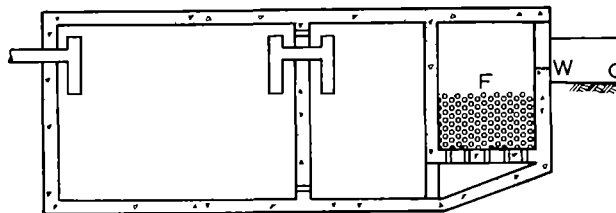

The septic tank with upflow filter (from 2356): F, filter; W, effluent weir; C, effluent channel.

30 g COD/m²d and influent COD levels ranging from 300 mg/litre to 4000 mg/litre, COD removal was 60-85%. Disc areal COD loading was found to have the greatest effect on total COD and nitrogen removal efficiencies.

sewage treatment; biological discs; rotating biological contactors; Asia; design

3008 Devroey, E.
Les installations sanitaires dans les colonies tropicales et le réseau d'égouts avec stations d'épuration d'Elisabethville (Congo belge). (Sanitation in the tropical colonies and sewerage with treatment plants in Elisabethville (Belgian Congo).) Revue Universelle des Mines, Belgium. Vol. 15(12). 3-8. December 1939. 4 figures.

A description of rural and urban sanitation, particularly as applied in the Belgian Congo, is given. Borehole latrines are used in the rural areas, as are smoking-pit latrines and earth closets. The septic tank linked with a percolating or biological filter is the most common treatment in higher density settlements and serves up to 100 persons. A sewerage network was built in Elisabethville in 1923, and treatment is effected by a combination of settling chambers, coagulation chambers, and septic tanks with percolating filters. (Original paper written in French.)

Belgian Congo; borehole latrines; septic tanks; sewerage; sewage treatment; smoking-pit latrines; percolating filters

3009 Enayatullah
Environmental Engineering Division, Asian Institute of Technology, Bangkok, Thailand
Performance of a rotating drum filter in treatment of wastewaters in the tropics. Master of Engineering thesis no. 825. Asian Institute of Technology, Thailand. 97p. 1975. 7 tables. 44 figures. 53 references. 2 appendices containing 6 tables and 11 figures.

Performance testing of a 60-cm diameter floating rotating biological drum treating two industrial wastewaters with average BOD concentrations of 4200 and 790 mg/litre is reported. For the two wastes mentioned, 82 and 98% efficiencies of soluble BOD removal were achieved at BOD loadings of 143 and 29.5 g/day per m² of surface area of drum packing corresponding to volumetric BOD loadings of 14 and 2.92 kg/day per m³ of drum. It was recommended that filter contact chamber volume should be only large enough to accommodate the drum, otherwise mixing was poor. An additional study is reported comparing a 30-cm diameter packed drum with a 12-cm diameter turbine aerator used on pilot scale lagoons treating domestic sewage.

sewage treatment; rotating biological contactors; rotating biological drums; tropics; Asia; aerated lagoons; drum aerators

3010 Gien, I.
Vosloo, P B B.
Stander, G. J.
Digestion of night soil by an elutriation technique. Public Health, South Africa. 31-35. January 1957. 1 diagram. 1 table. 1 reference.

Laboratory tests on digestion of night soil with dilution are reported. Results showed that satisfactory digestion occurs when at least eight volumes of diluting water are added, the effluent then being suitable for aerobic treatment. At lower dilutions ammonia concentrations appear to inhibit digestion; the pH did not rise above 7.8.

anaerobic digestion; elutriation; excreta

3011 Hindhaugh, G. M. A.
Ward, Ashcroft and Parkman, Liverpool, U.K.
Night-soil treatment. Consulting Engineer, U.K. Vol. 37(9). 47-49. September 1973. 1 map. 1 diagram. 2 photographs.

The paper describes a nearly completed plant to treat 190 m³/d night soil and septic tank sludge by screening, dilution, disintegration, and aeration in two lagoons. The lagoons were constructed on reclaimed land, were lined with synthetic rubber sheeting, and were each provided with four 56-kW floating aerators. Effluent would be discharged through a 120-m long 400-mm diameter pipe to Lagos harbour.

night-soil treatment; Nigeria; septic tanks; sludge; aerobic digestion; aerated lagoons

3012 Ikeda, I.
Sewage Works Bureau, Yokohama, Japan
Experimental study on treatment of night soil by the wet air oxidation process. Water Research, U.K. Vol. 6. 967-979. 1972. 7 diagrams. 3 photographs. 3 references.

The importance of night-soil treatment in Japan is described. A pilot wet-air oxidation plant with a capacity of 2.7 t/day dry solids was tested at Yokohama, Japan, at temperatures around 200 °C and flow rates around 50 m³/d. Treated sludge was stable, easily separated, and dried. Supernatant could be treated by activated sludge.

night-soil treatment; Japan; wet-air oxidation

3013 Jahn, S. A.
Dept. of Physiology, University of Khartoum, Sudan

Sudanese native methods for the purification of Nile water during the flood season. In Tourbier, J., and Pierson, R. W., Jr, eds., Biological Control of Water Pollution. USA. 95-106. University of Pennsylvania Press. 1976. 4 tables. 3 diagrams. 14 references.

The waters of the Nile have been traditionally purified using clay soil as a flocculant, and also a number of local plants for the same purpose.

Bacteriological studies were done to determine the effectiveness of these methods. All samples of untreated water were found to be contaminated with feces. There is evidence that treatment with clay soil reduces *E. coli* to a certain extent.

Sudan; sanitation; environmental hazards; water treatment

3014 Martinez, J. M.
Lagunas de oxidacion con aereacion forzada, criterios de calculo, diseno y ejecucion. Necesidad de un nuevo standard para control del efluente. (Aerated lagoons, design criteria and construction.) XII Inter American Congress of Sanitary Engineering. Venezuela. 27p. August 1970. 36 pictures.

The author proposes mechanical aeration as a viable solution to avoid most of the inconveniences presented by oxidation ponds. Two projects in Argentina are given as examples of the results achieved by introducing mechanical aeration. Transformation of animal organic matter into live vegetables is suggested as a cost-effective measure for treatment as opposed to the traditional depuration of effluents by retention periods. Finally the paper demonstrates that control of BOD levels alone does not constitute sufficient criteria to approve or disapprove industrial wastewater treated in oxidation ponds (Original paper written in Spanish.)

Argentina; BOD; cost-benefit; design criteria; effluents; mechanical aeration; oxidation ponds; detention time, sewage treatment

3015 Matsumoto, J.
Endo, I.
(Both) Dept. of Civil Engineering, Faculty of Technology, Tohoku University, Sendai, Japan
Anaerobic digestion of night soil. Second International Conference on Water Pollution Research, Japan. Paper No. 2. 13p. August 24-28, 1964. 1 table. 9 figures 7 references.

A laboratory experiment on anaerobic digestion of night soil at temperatures from 30 to 60 °C and detention time from 3 to 30 days is reported. An effective temperature range was found to be between 33 and 37 °C with the optimum temperature at 33 °C. It was concluded that night-soil digesters should not have less than a 20-day detention time at any temperature to avoid digester failure.

anaerobic; digestion detention time; excreta

3016 Mijares, C. R.
La desinfeccion del agua en areas tropicales. (Water disinfection in tropical areas.) Boletin de la Academia de Ciencias Fisicas, Matematicas y Naturales. No. 87 Caracas, Venezuela. (Separata.) 19p. 1970. 7 tables. 2 graphs. 21 references.

Relatively little research has been done to investigate the wide variety of parasite pathogens

actively present in the tropical zones. Protozoa, nematodes, pathogen trematodes, etc., are amongst the organisms frequently found residing in humans living in the tropics. This paper familiarizes the sanitary engineer with the effectiveness of the various treatment processes — physical, chemical, and biological — in destroying such microorganisms. (Original paper written in Spanish.)

Latin America; Venezuela, tropics; sewage treatment; bacteria; viruses; Protozoa; parasites; Salmonella; Shigella; enterovirus; biological treatment

3017 Muga, E.
Socio-economic conditions which pertain to cost of construction and operation of water and sewage treatment facilities and quantity of water consumption in Kenya. A report prepared for the U.S. AID project on Lower Cost Methods of Water and Wastewater Treatment in Less Developed Countries. USA. 1976.

This report entails a detailed analysis of the socioeconomic conditions that pertain to cost of construction and operation of water and sewage treatment facilities and quantity of water consumption in Kenya. It was stated that rational planning for the supply of adequate water and wastewater facilities, their operation and maintenance, and the total cost of construction of such facilities consider many factors, derived as a result of this study. Because of the African traditional way of life many people are not in favour of shared water and wastewater facilities. However, communal water points may be necessary where there are those who cannot pay for their water. Where it is not possible to construct more sophisticated water supply and wastewater facilities due to lack of funds, it might be advisable to use pit latrines, which would be cheaper to construct and maintain.

Kenya, sewage treatment, socioeconomic

3018 Pescod, M. B.
Nair, J. V.
(Both) Environmental Engineering Division, Asian Institute of Technology, Bangkok, Thailand

Biological disc filtration for tropical waste treatment: experimental studies. Water Research, U.K. Vol. 6. 1509-1523. 1972. 1 table. 12 figures 10 references.

Experimental studies on organic wastewater treatment under tropical conditions using biological disc filtration units incorporating an anaerobic digestion are reported. Up to 95% COD removal was achieved in treating a waste with COD near 1000 mg/litre at an aerobic volumetric loading of 4 kg COD/m³ day, giving 6 h detention. An anaerobic compartment with the same capacity as the aerobic section gave a high degree of digestion of biological solids sloughing off the rotating discs.

sewage treatment; biological discs; rotating biological contactors; tropics

3019

Pillai, S. G.
Mohanrao, G. J.
Prabhakaro Rao, V. S.
Sastry, C. A.
Subrahmanyam, P. V. R.
Natarajan, C. V.

(All) Department of Biochemistry, Indian
Institute of Science, Bangalore, India

Natural purification of flowing sewage. Current
Science, India. Vol. 29. 461-465. December 1960. 4
photographs. 4 tables. 7 references.

■ The object of this paper is to describe conditions, particularly at Bangalore, India, under which some 16 million gal (72.7 million litres) of sewage flows daily down on the outskirts of the town and purifies itself naturally without any treatment. Bangalore is an inland town situated on the Deccan Plateau at a height of about 3000 ft (ca. 900 m) above sea level. Its temperature ranges from 46 to 102 °F (7.7-38.8 °C) in the winter and summer, respectively. The population of Bangalore during the investigation period is reported to have been 1.4 million and the daily water consumption about 17 million gal (77 million litres). Most areas of Bangalore are provided with underground sewerage systems. The bulk of the sewage is taken to three outfalls from which the sewage is allowed to flow down in three natural channels having varying gradients, viz., 1:50, 1:100, and 1:800. It has been observed that the turbid, foul liquid flowing in these channels becomes clear and is oxidized to an appreciable extent after its flow over a distance generally of 1 to 5 miles (1.6-8 km), depending on the channel gradients. The purified effluent is then used by the villagers in the vicinity for irrigating the land, raising crops, and washing purposes. No pathogenic organisms have been found at the point where the liquid is used for washing but the presence of total bacteria at densities 3000 to 10 000 numbers per millilitre is reported. A close study of the natural treatment process has revealed that the important factors influencing purification of the flowing sewage include: (a) adequate agitation or turbulence of the sewage and other conditions in the channel, which facilitate the dissolution of oxygen to the extent of about 3.5 mg / litre. This evidence is supported by the fact that, for the channel having the gradient of 1:50, distance from the outfall at which sewage is completely purified is 1.29 miles (2.08 km), while for the channels having the gradients of 1:100 and 1:800, the required flow distances are over 4 miles (6.4 km); (b) the consequent development in large numbers of ciliated Protozoa in the clarification zone of the channels. These organisms provide flocculating activity and clarification of the sewage. Apart from that, they bring about nitrification that results in removal of ammonia and amino acids from the sewage. The quality of the final effluents from these channels is reported to be similar to that from the activated sludge process. Observations have also been made at other locations in India on the flowing sewage. The authors made conclusions from these investigations that the extent of agitation of the sewage during its flow is a basic factor in the process

of natural purification as it influences the initial oxygenation of the sewage, development of the *Protozoa*, and the consequent changes leading to purification. When, however, sewage flowed down in a more or less contour channel, it could not be oxygenated or purified to any appreciable extent even after its flow over a distance of 5 miles (8 km).

India; natural purification; sewage

3020

Reid, G. W.

Bureau of Water and Environmental Resources
Research, University of Oklahoma, Norman,
Oklahoma, USA

Final report: lower cost methods of water and wastewater treatment in less developed countries (LDC). A report submitted to the Office of Health, U.S. AID, under Contract No. AID / CM-ta-C-73-13. 28p. 1 March 1977. 7 figures. 5 tables. 6 references. 6 annexes.

The specific products of this research project are: a predictive or selection model supported with cost and demand analysis, computer and manual user guides, and an in-country supportable analytical kit. In addition a data classification and collection system was developed along with in-depth state-of-the-arts involving historic, unpublished, and published sources. Selected studies were made of the "high make" technologies, at global sites, of both water and wastewater treatment in terms of not only economic performance but of consumer acceptance. The models were tested for consumer acceptance and the field analytical kit was also tested for complete in-country capability to monitor water and wastewater treatment devices.

developing countries; sewage treatment; mathematical models

3021

Reid, G. W.

Bureau of Water and Environmental Resources
Research, University of Oklahoma, Norman,
Oklahoma, USA

Discenza, R.

University of Maine, Orono, Maine, USA

Prediction methodology for suitable water and wastewater processes. A report prepared by the Office of Research Administration, University of Oklahoma, USA for the U.S. AID. USA. October 1976.

A predictive model was developed to help planners select suitable water and wastewater treatment processes appropriate to the material and manpower resource capabilities of particular countries at particular times. This model was computerized and a manual approach was developed. The model brings together a number of critical inputs relating to the effective installation and use of various water and wastewater treatment methods, processes, and combinations of processes. The output of the model is a list of the plausible alternatives for water and(or) wastewater treatment in developing country com-

munities. This output allows planners or project engineers to look at all the plausible processes and their related construction costs, plus the operation, maintenance, and manpower requirements associated with each of the various processes. This technique will eliminate the problem of overlooking good processes for water and wastewater treatment.

computer models; developing countries; sewage treatment

3022

Reid, G. W.

Bureau of Water and Environmental Resources Research, University of Oklahoma, Norman, Oklahoma, USA

Discenza, R.

University of Maine, Orono, Maine, USA

Prediction methodology for suitable water & wastewater processes. Supplement I manual computation method. A report prepared by the Office of Research Administration, University of Oklahoma, USA for the U.S. AID USA. 21p. October 1975. 4 tables.

The selection of the most appropriate water and wastewater treatment method for developing countries by using the predictive model is not limited to situations where an electronic computer is available. A manual computation method has also been devised consisting of 12 steps: first, weights are assigned to the data, which will determine the socio-technical level of the community under consideration. Next, determination is made from information from the data form of the availability of the operation equipment, process materials, operation and maintenance supplies, and chemical supplies, and comparison is made with the basic processes and their manpower and resource requirements. Comparisons are also made either of the water quality of the community or the volume of receiving water, with the criteria given for a list of various combinations of processes. Feasible processes for the community have been identified at this point. Costs for the various feasible combinations of processes can be determined from data for the various water treatment costs contained in Appendix D of the model and the current population of the community. The final step is selection of the lowest total cost or the lowest maintenance cost combination of processes.

developing countries; sewage treatment; computer models

3023

Reid, G. W.

Muiga, M. I.

(Both) Bureau of Water and Environmental Resources Research, University of Oklahoma, Norman, Oklahoma, USA

A mathematical model for predicting water demand, waste water disposal and cost of water and waste water treatment systems in developing countries. A report prepared by the Office of Research Administration, University of Oklahoma, USA for the U.S. AID. USA. 1140p. January 1976. 15 tables. 5 figures. 54

references. 4 appendices.

This study uses mathematical modeling techniques to develop predictive equations for water supply and wastewater disposal models in developing countries utilizing socioeconomic, environmental, and technological indicators. Predictive equations are developed for three regions (Africa, Asia, and Latin America) for water demand, wastewater amounts, and construction and operation and maintenance costs of slow sand filter, rapid sand filter, stabilization lagoon, aerated lagoon, activated sludge, and trickling filter processes. The primary objective of this study was to provide engineers, planners, and appropriate public officials in developing countries with an innovative technique for more effective development of in-country water resources. Data analysis indicated that water demand is a function of population, income, and a technological indicator (percentage of households connected to water supply), while wastewater disposal was found to be a function of water demand, and two technological indicators (percentage of homes connected to public sewerage systems and percentage of household systems). The predictive equations for water treatment costs were found to be a function of a technological indicator (percentage cost of imported water supply materials), population, and the design capacity. The variables that gave the best correlation for wastewater treatment costs were population, design capacity, and the percentage of imported wastewater disposal materials.

developing countries; mathematical models; sewage

3024

Reyes, W. L.

Kruse, C. W.

Batson, M. S. C.

(All) School of Hygiene and Public Health, Johns Hopkins University, Maryland, USA

The effect of aerobic and anaerobic digestion on eggs of ascaris *Lumbricoides var. suum* in night-soil. American Journal of Tropical Medicine and Hygiene, USA. Vol. 12(1). 46-55. 1963. 2 tables. 4 figures. 10 references.

Aerobic and anaerobic batch digestions of night soil seeded with eggs of pig *Ascaris* as a test organism have been investigated at various temperatures to determine whether the eggs are preserved, cultured, or destroyed. The authors report that in neither system is the destruction of eggs complete at the end of night-soil stabilization, unless temperatures are held at or above 38 °C for the anaerobic and 45 °C for the aerobic digestion. Below 38 °C for anaerobic and 45 °C for aerobic night-soil digestion, apparently viable *Ascaris* eggs in anaerobic digestion remain at the single-cell stage, while for aerobic digestion, the apparently viable *Ascaris* eggs develop to multicell stages with some reaching the infective larval stage. At these temperatures, night soil is well digested and drainable in about 30 days of anaerobic and 20 days of aerobic digestion. Simple heating of raw night soil at 55 °C for 20 min can also provide public health safety but this process has some practical objections because

the undigested night soil has offensive odours and poor dewatering characteristics.

excreta; aerobic digestion; anaerobic digestion; Ascaris; public health

- 3025 Ruderman, P.
Pflucker, J.
Espinoza, R.
Brown, J. C.
(All) Organizacion Panamericana de la Salud,
Universidad Nacional de Ingenieria, Facultad de
Ingenieria Sanitaria, Lima, Peru

Curso sobre financiacion de obras sanitarias. (Course on financing of sanitary works.) Universidad Nacional de Ingenieria, Facultad de Ingenieria Sanitaria, Lima, Peru. July 1968. 26 tables. 21 graphs. 4 references. 4 papers.

This course is designed to make the sanitary engineer aware of the input once played by sanitation in the overall development process of Latin America. The four papers presented touched on different aspects of economics, finances, and engineering specifically applied to sanitation. Through the use of several practice examples, the course teaches how to evaluate cost and benefits, how to design functional tariff structures that allow systems to be self sufficient, and how to maximize the benefits from the scarce resources available. (Original paper written in Spanish.)

Latin America; sanitation; rural; financing; cost-benefit

- 3026 Secretaria de Recursos Hidraulicos, Mexico
Sistemas economicos de tratamiento. (Low cost systems for waste water treatment.) Direccion General de Usos del Agua y Prevencion de la Contaminacion, Direccion del Centro de Investigaciones y Entrenamiento, Contrato No. SP-73-C-16, Clave UAPC 73-16, Mexico. 1974. 13 chapters. 37 tables. 42 figures.

Laboratory modeling and field investigations were designed to evaluate technically and economically seven of the most widely used alternatives for wastewater treatment in Mexico, giving special interest to stabilization ponds, and its application to cities whose populations range was between 500 and 50 000 inhabitants. The study concludes that stabilization ponds proved to be the best alternative, given the social, technical, and environmental conditions of the country and highlighted the need to develop design manuals for sewage treatment in small communities. (Original paper written in Spanish.)

Mexico; economics; extended aeration; Imhoff tanks; primary treatment; secondary treatment; septic tanks; stabilization ponds; sewage treatment

- 3027 Sieberg, D.
Estudio comparativo de costos de construcción, operación y mantenimiento para diferentes tipos de plantas de tratamiento de aguas residuales para poblaciones de 1 000 a 150 000. (Comparative study of the construction, operation and maintenance costs for wastewater treatment plants in communities from 1000 to 150,000 inhabitants.) XIII Congreso Interamericano de Ingeniería Sanitaria, Paraguay. August 1972. 42 tables. 13 figures. 3 graphs.

The paper is oriented to aiding the engineer in the selection of the different alternatives for wastewater treatment. It analyzes the major factors that enter into the decision-making process. A comparative study on the costs and alternatives for small communities is presented taking into consideration manpower, resource availability, soil characteristics, land availability, etc. (Original paper written in Spanish.)

wastewater treatment plants; activated sludge; construction; costs; design; extended aeration; lagoons; maintenance; oxidation ponds; percolating filters

- 3028 Yanez, F.
Centro Panamericano de Ingeniería Sanitaria y Ciencias del Ambiente (CEPIS), Lima, Peru
Consideraciones en la selección y aplicación de tecnologías de tratamiento. (Considerations in the selection and application of wastewater treatment technologies.) Simposio sobre Tratamiento y Disposición de Aguas Sanitarias Centro Panamericano de Ingeniería Sanitaria y Ciencias del Ambiente, Buenos Aires, Argentina. 31p. June 1976. 10 figures. 6 tables. 28 references.

This paper evaluates several alternatives for wastewater treatment, emphasizing those of lower costs in developing countries. Needs of engineering working levels for each alternative are discussed. Financial considerations for selecting a given technology are presented for each case; the possibility of saving up to one-third of the energy consumption by intermittent operation of aerators in the deep oxidation ditch is discussed. (Original paper written in Spanish.)

wastewater; activated sludge; aeration; dissolved oxygen; stabilization ponds; sewage treatment; extended aeration; energy conservation

- 3029 Ross Institute of Tropical Hygiene, London
School of Hygiene and Tropical Medicine,
London, U.K.
Sanitation in developing countries today. A conference sponsored by Oxfam with the Ross Institute of Tropical Hygiene, 5-9 July 1977, Pembroke College, Oxford, England. 23p. Bulletin No. 2. October 1977.

Reports of six working groups on: pit latrines and derivatives; composting latrines; aqua-prives; septic tanks, and derivatives; bucket latrines or vaults with cartage systems; provision of sanitation for the urban

poor; and the reuse or reclamation of sewage for fertilizer, fuel, or other purposes, cover the most urgent topics of sanitation and provide a global state-of-the-art review of alternatives that are available to conventional sewage systems.

pit latrines; composting toilets; aqua-privies; cartage; urban

3.1 Cartage

3101

Camp Dresser and McKee International Inc.,
Boston, Massachusetts, USA

Sewerage planning in the greater Taipei area. A Master Plan Report WHO/UNDP/SF/CHA-27 prepared for the World Health Organization as Executing Agency for the United Nations Development Programme. Vol. II. Technical report. Part 2. "Interim Measures for Nightsoil Disposal." 175-197. Vol. IV. Appendix XVII. "Data from Japan." XVII/1-XVII/13. 1970. Part 2. 5 tables. 7 figures. Appendix XVII. 8 figures.

■ In most parts of Taiwan, including Taipei, older buildings have night-soil latrines and newer ones have flush toilets with septic tanks. Removal of night soil from the latrine vaults is done periodically either by public collection services or by private individuals through vacuum trucks and manual cartages (using dippers and buckets). The estimated quantities of night soil generated in 1969 are 1600 m³/day in the urban areas and 300 m³/day in rural areas. Some of the night soil is used as fertilizers in agriculture and some is dumped into local drains, canals, and the main rivers. Although several covered detention tanks have been constructed for the purpose of destroying pathogenic organisms before the night soil is used by farmers, or alternatively, of reducing the oxygen demand before discharge to the rivers, the retention period (10 days) is reported to be too short for any effective treatment. Another finding is that more than half of the latrine vaults surveyed are very insanitary, from which it is estimated that the cost of converting the night-soil latrines to flush toilets with suitable septic tanks would be less than the resulting economic benefit deriving from improved health, even without considering esthetic and other social benefits, as long as the new facilities will have a useful life of approximately 5 years or more. Treatment of night soil to make it safe for agricultural use is technically but not economically feasible. A carefully planned disposal or dumping of night soil into the river or estuary is considered practical because of the relatively small portion of total organic pollution load that would be contributed from the night soil. As soon as sanitary sewers are available, night soil should be dumped into them for disposal with sewage. A night-soil dumping station is needed to be included in the sewerage program. A survey of night-soil data from Japan reveals that the population served by public night-soil collection and disposal facilities is

about six times that served by sewerage systems. Collection is usually done by vacuum tanker truck, because of the inefficiency and insanitary nature of collection by dipper and bucket. The general nature of the latrine and that of the night soil are similar to those in Taipei, except that a good deal of newspaper is introduced, which must be removed before treatment. Several treatment and disposal methods that have been tried include: (a) chemical conditioning; (b) anaerobic digestion; (c) wet oxidation; (d) activated sludge treatment (small plants only because of expense); and (e) ocean disposal by barge and pipeline. Sewerage progress in Japan is reported to be slow and resulted in several years (5-20 years) delay between the start of construction and completion of the basic components necessary for an operating system. The major causes of delay involve high cost and difficulty in sewer construction and the need for public education on the need and desirability of the installation of modern plumbing including flush toilets.

Taiwan; Japan; night-soil treatment; night-soil disposal; flush toilets; septic tanks; vacuum trucks; cartage, dipper and bucket; health; sewerage; cost-benefit; conservancy tanks

3102

Camp Dresser and McKee International Inc.,
Boston, Massachusetts, USA

Supporting material concerning nightsoil, Appendix X. Sewerage Planning in the Greater Taipei Area. A Master Plan Report prepared for the World Health Organization as Executing Agency for the United Nations Development Programme. Taipei. Vol. IV. Appendices. C/1-X/17. 1970. 3 tables.

A survey was made of a random sampling of 1286 latrines served by truck collection in Taipei. The data were accumulated by a questionnaire that covered the characteristics of the households, the condition of the latrines, and the social habits of the users. The survey questionnaire is discussed in detail. A check survey showed up certain discrepancies in surveying techniques.

Taiwan; conservancy tanks; truck collection; public opinion; disease; public health; urban; hygiene; customs; household; economics; surveys; excreta

3103

CBA Engineering Ltd., Vancouver, Canada
Belize City, feasibility study, water supply and sewerage. Report No. 7321. Prepared for the Canadian International Development Agency. Vol. 2. Water Supply and Sewerage. 6-1 - 6-9. December 1973. 2 figures.

A sani-station system is proposed for Belize City for the disposal of excreta and sullage. The system, which can be used as a private facility or public facility, consists of an on-site holding tank and a dump tank for discharging of the waste to the ocean.

Transportation of wastes from the holding tank to the dump tank is done by buckets.

Belize City, excreta; greywater; disposal; dump tanks; bucket latrines

3104

Maclaren International Ltd., Willowdale, Ontario, Canada

Master plans for wastes disposal and drainage, Ibadan, Nigeria. Vol. III. "Sewerage." Report prepared for WHO acting as Executing Agency for UNDP. Nigeria. 287p. May 1971. 45 figures. 96 tables.

A conservancy system is practiced in Ibadan. Night soil is collected manually at storage depots, and thence removed by truck to trenching grounds outside the town. Operating problems of this system are described and improvements recommended. Night-soil waste stabilization ponds are proposed. A general sewerage plan, including improved aqua-privies and public toilets, is also proposed.

Nigeria; conservancy systems; truck collection; stabilization ponds; sewers

3105

Central Public Health Engineering Research Institute, Nagpur, India

Night soil wheel barrows. Technical Digest No. 32. Central Public Health Engineering Research Institute, India. 1p. August 1972. 1 diagram. 1 table.

Designs for night-soil wheelbarrows intended for use by scavengers are given. Public health and personal hygiene are improved by using closed buckets mounted on a pushcart.

cartage; design; public health; community; India; night-soil collection; excreta

3106

Projects Department, Europe, Middle East and North Africa Regional Office, International Bank for Reconstruction and Development, Washington, D.C., USA

Appraisal of the Kabul water supply and sanitation project Afghanistan. International Bank for Reconstruction and Development. Report No. 746-AF. USA. 27p of main text and 32 of annexes. May 1975. 14 annexes. 9 tables. 4 graphs. 1 map.

Water supply in Kabul is totally inadequate for the community requirements. Supply is intermittent for a few hours daily. Proposed works to improve water supply include the drilling of 20 deep wells and construction of rusted transmission and storage facilities. Over 200 km of distribution mains will be laid. In addition the project would improve sanitation by financing modifications to 8000 household latrines and the purchase of vehicles and trailers to collect night soil on a regular basis; the total cost is estimated

at US\$ 11 million. The Afghan Water Supply and Sewerage Authority (AWSSA) will be the executing agency. Feasibility studies were prepared by Proctor and Redfern International Ltd. (PRIL) of Canada.

Afghanistan, water supply, sewerage; urban; sanitation; night-soil collection, household

3107

Directorate General of Health Services, Ministry of Health, New Delhi, India

Urban latrines (conservancy type) and public urinals. Central Public Health Engineering Organization, Directorate General of Health Services, Ministry of Health, New Delhi, India. 13p. 1965. 4 appendices.

Two-thirds of the urban population in India are not served by sewers and the conservancy system remains the most popular method of excreta disposal. Water-seal toilets are proposed as a method of upgrading pit latrines into septic tanks. These can be built safely to discharge effluent in sandy soil. In poor soils the effluent will have to be removed periodically by truck. Removal of night soil can be improved by use of mechanized vehicles instead of night-soil depots.

India; latrines; urinals; night-soil collection; conservancy systems

3108

Hennessy, P. V.
Langer, W. F.
Lin, Y. S.
Rhodes, F.

(All) James M. Montgomery Consulting Engineers Inc., Pasadena, California, USA

Master plan for development of water supply, sewerage and drainage for Khulna, East Pakistan. Sect. IV. "Proposed Sewerage System" from an unpublished report to the Directorate of Public Health Engineering, Government of East Pakistan. USA. 23p. April 30, 1965. 7 tables. 7 figures.

Phase 1 of a proposed sewerage system for a city of 265 000 persons includes the construction of public latrines and the removal of night soil by vacuum truck to treatment ponds, as well as water supply via street hydrants. Future phases will include widespread water distribution and full sewerage and treatment in oxidation ponds. Investigation of the present economic level, family income, and tax structure of the city of Khulna indicates that the community could not repay the capital costs of even the phase 1 program.

East Pakistan; economics; excreta; sewerage

3109

Hillmer, T. J., Jr

U.S. Environmental Protection Agency, Washington, D.C., USA

Transporting liquid sewage sludge by tank truck: an economic perspective. Compost Science, USA. Vol. 17(4). 28-32. September / October 1976. 6 figures. 7

references.

Costs of sewage sludge transportation in 15 municipalities throughout the United States of America are presented in graphic models. These economic analyses, which include factors such as mileage of hauling, loading and unloading times, and percentage solids of the sludge, are intended for decision-makers as an aid in environmental planning.

sludge; USA; economics; planning; mileage; vacuum trucks

3110

Hogg, C.
Dyer, E. A.

(Both) J.D. and D.M. Watson, U.K.

Main sewerage and sewage purification, Kuala Lumpur, Malaya. Proc. Conf. Civil Engineering Problems Overseas, U.K. The Institution of Civil Engineers. 173-185. 1958. 5 figures. Appendix.

The planning and construction of the nearly completed foul sewerage system at Kuala Lumpur are described. At the Pantai sewage treatment works, night-soil collection vehicles would unload buckets and be washed by pressure hoses. Bucket contents and washwater were pumped into sludge-digestion tanks where they were mixed with primary sludge. Digested sludge was dried on open beds.

sewerage; sewage treatment; Malaysia; night-soil treatment; vacuum trucks

3111

Huat, T. T.

Sewerage Branch, Public Works Department,
Singapore

Sewerage, sewage treatment and disposal in Singapore. Regional Workshop on Water Resources Environment and National Development, Singapore. Vol. 2. Selected papers. 143-180. 13-17 March 1972. 9 figures. 3 tables. 6 references.

Despite the existence of a waterborne sewerage system since 1915, some 700 000 people (34% of the population) in Singapore are served by a bucket night-soil collection system, partly operated by the Ministry of Health and partly by private contractors. The night-soil is dumped into three special night-soil pumping stations from where it is pumped to one of the two main sewage treatment works. The night soil is digested anaerobically in admixture with sewage sludge. The paper also gives full descriptions of Singapore's sewage treatment works.

Singapore; sewerage; sewage treatment; excreta

3112

Lien, J. C.

Camp Dresser and McKee International Inc.,
Boston, Massachusetts, USA

Preliminary report on the flies breeding in latrine vaults in the Greater Taipei Area. Sewerage Planning in the Greater Taipei Area. A Master Plan Report prepared for the World Health Organization as

Executing Agency for the United Nations Development Programme. Vol. IV. Appendix X. X/18-X/21. 1970. 1 table. 9 references.

This is a report of a study of the species of flies breeding in latrine vaults in 14 districts of Taipei. The largest percentage identified were *Chrysoma magacephala* (blow flies) and *Boettcherisca peregrina* (flesh flies). In addition, *Hermetia illucens* (soldier flies), *Telematoscopus albipunctatus* (moth flies), and *Brachymeria paraplesia* (Chalcidids) were found. Public health implications of fly breeding are discussed.

truck collection; diseases; public health; latrine vaults; flies; Taiwan; night soil; urban

3113

McGarry, M. G.

International Development Research Centre,
Ottawa, Canada

Developing country sanitation. A report prepared for the International Development Research Centre, Canada. Chap. 5 "The Choice Between Technology." 5.1-5.21. 1972. 3 figures. 6 tables. 2 references.

This chapter deals with a decision-making process to determine the most cost-effective wastewater management system for a town of evenly distributed population, 1 km² in area. The kilometre analysis and assessment are done through a cost/sensitivity exercise on a well-defined hypothetical urban model. Four technologies considered include (i) the conventional sanitary sewerage system, (ii) the aqua-privy cum sewer system, (iii) the Japanese vacuum truck and household vault, and (iv) the septic tank. On a comparative basis, the vacuum truck and vault is more attractive than the other systems because of its low capital cost and annual costs and there is little change in unit costs over population densities under variations in interest rates. However, each of the above systems has trade-offs in itself and further investigations are recommended for each specific location condition.

cost-benefit; sanitation; sewerage; aqua-privies; vacuum trucks, septic tanks

3114

McGarry, M. G.

International Development Research Centre,
Ottawa, Canada

Waste collection in hot climates ... a technical and economic appraisal. In Feachem, R., McGarry, M. G., and Mara, D., eds., "Water, Wastes and Health in Hot Climates." A Wiley-Interscience Publication, U.K. ISBN 0-471-99410-3. Chap. 13. 239-263. 1977. 6 figures. 10 references.

□ A broad spectrum of technologies available to rural and urban areas of developing countries for hygienic excreta disposal is described. The pit privy, borehole latrines, PRAI latrines, overhung latrine or the feuillée, and excreta composting and the biogas plant have been employed for rural sanitation. Other systems for urban sanitation include the septic tank, conventional sanitary sewerage, bucket latrine, aqua-

privy, aqua-privy-sewerage system, vacuum truck and vault, compost toilet, and chemical and other individual toilet units. The choice for any of the above technologies depends on many criteria. Under empirical conditions, the vacuum truck and vault was found to have the lowest costs when compared to the other urban sanitation systems.

excreta disposal; costs; urban; rural; developing countries

3115 Miller, N.
Lagos Executive Development Board, Nigeria, Africa

The sanitation of Lagos. Journal of the Institution of Municipal Engineers, U.K. Vol. 88(12). 441-446. December 1961. 1 photograph. 1 map. 1 diagram. 1 table.

This paper describes a century of sanitary progress in Lagos, Nigeria. A system used for night-soil collection between 1907 and 1933 is described. Subsequent improvements in sanitation are outlined.

Nigeria; night-soil collection

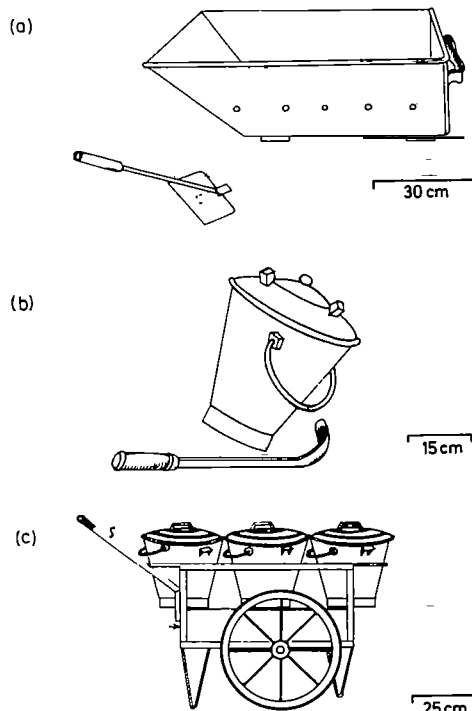

(a) Night-soil container (made from 24-gauge galvanized iron sheet) and scraper. (b) Night-soil bucket and scraper. (c) Wheelbarrow for three or six buckets (from 3116). (Designs by Department of Social Welfare, Ahmadabad.)

3116 Mohanrao, G. J.
Central Public Health Engineering Research Institute (CPHERI), Nagpur, India
Waste collection, treatment and disposal in India. Indian Journal of Environmental Health, India. Vol. 15(3). 222-235. July 1973. 6 tables. 7 references.

The present deficiency of sewerage in India and the high cost of providing it for those not served lead the author to query whether satisfactory alternatives to water-carried sewerage can be found. In India the majority of sewage is at present discharged untreated to land or water. Waste stabilization ponds can provide a lower-cost alternative to conventional treatment. About 70% of the urban population is still served by bucket latrines, and efficient treatment of night soil should be developed. Improved refuse collection methods are needed.

India; sewerage; night-soil treatment; sewage treatment

3117 Morrow, D.
Sanitary waste disposal in low-income communities in Jakarta. Unpublished report Workshop II. Public Policy Program. 77p. May 6, 1975. Bibliography.

The present conditions with regard to waste-disposal practices in Jakarta are described, with particular reference to health dangers and environmental pollution. Various alternatives are described and their feasibility evaluated. The author concludes that a night-soil collection system, utilizing vacuum carts and steam pasteurization and eventual use as fertilizer, is not only the most economic but has the best chance of easy implementation.

Indonesia; urban; collection; vacuum trucks; aqua-privies; sanitation; economics; excreta

3118 Pradt, L. A.
Zimpro Inc., Rothschild, Wisconsin, USA
Some recent developments in night soil treatment. Water Research, U.K. Vol. 5. 507-521. 1971. 4 tables. 5 figures. 15 references.

The collection and treatment of night soil in present day Japanese cities is described. Three treatment processes (digestion, chemical treatment, and aerobic oxidation) are described in detail. The author concludes that the night-soil collection and treatment systems as practiced in Japan are more practical for most Asian and underdeveloped communities than a Western-style waterborne system, at least for the next 10-20 years.

Japan; collection; vacuum trucks; economics; wet-air oxidation; aqua-privies; conservancy tanks; sewage treatment; excreta

3119 Tabago, J. L.
Asian Institute of Technology, Bangkok, Thailand

Evaluation of night soil collection, treatment and utilization in agriculture. Master thesis No. 586. Asian Institute of Technology, Thailand. 111p. October 1973. 30 tables. 15 figures. 44 references.

■ A promising alternative waste-disposal system for urban areas in developing countries is that of night-soil (excreta) collection by vacuum trucks, treatment, and utilization. The night-soil collection operation for a residential city or town of 50 000 population would require about 17 units of 8-m³ tank truck at an 8-h working day. For a 16-h working period (two shifts), nine units of the tank truck would be needed. The cost of night-soil collection depends on many factors but the use of the larger tank truck and transfer stations (tank trailers) will significantly reduce the unit cost of the collection. For a system using an 8-m³ tank truck with a crew of two, a collection frequency at 2-week intervals, an amount of flushing water at 2 litres / capita-day, and the distance of the collection area to treatment plant equal to 2 km, the collection cost is estimated to be U.S. \$ 0.40 / m³ or U.S. \$ 0.60 / capita-year. A laboratory study indicated that destruction of the harbouring parasites including ascarid eggs in the night soil can be accomplished by moist heat treatment under atmospheric pressure at 60 °C and an exposure time of 10 min. The proposed heat treatment facilities include a receiving facility for the collected raw night soil, heat exchanges, and a temporary storage coupled to a series of anaerobic and aerobic lagoons having a required area of 3.0 hectares. The boiler capacity is estimated at 1880 kg steam / h that could treat night soil at a rate of 25 m³ / h. The cost of this treatment system is estimated to be U.S. \$ 0.30 / m³ or U.S. \$ 0.45 / capita-year. The overall cost of night-soil collection and treatment is therefore U.S. \$ 0.70 / m³ or U.S. \$ 1.05 / capita-year. Considering the fertilizer value of night soil (U.S. \$ 3.5-4.5 / m³) and the cost of land application (U.S. \$ 1 / m³), the treated night soil may be sold at about U.S. \$ 2.5-3.5 / m³. These analyses imply that the collection and treatment of night soil is economically feasible provided that a market exists for the utilization of the human waste.

collection; Thailand; vacuum trucks; reuse; Ascaris; pasteurization; excreta

3120 Thomas, R H.
Camp Dresser and McKee International Inc.,
Boston, Massachusetts, USA
Wastewater system for Taipei, Taiwan. Journal of the Water Pollution Control Federation, USA. Vol 44(8). 1611-1622. August 1972. 4 diagrams 4 tables. 1 reference

The present night-soil collection method is described. Alternative water-carried sewerage systems are compared and some details are given of the proposed system, which includes a staging program and construction costs. Partly treated sewage would be discharged to sea. The proposal includes a night-soil dumping station for six vehicles. Night soil and washwater would pass to the sewer.

Taiwan; sewerage; sewage treatment; excreta

3121 Briscoe, J.
Epidemiology Division, Cholera Research Laboratory, Dacca, Bangladesh

The organisation of labour and the use of human and other organic resources in rural areas of the Indian subcontinent. Sanitation in Developing Countries Today, a conference sponsored by Oxfam and the Ross Institute of Tropical Hygiene, 5-9 July 1977, Pembroke College, Oxford, England. 10p. (To be published in the book "Sanitation in Developing Countries Today," by John Wiley & Sons, October 1978.) 52 references.

The author has examined the ways in which the distribution and use of organic resources in Bangladesh and other parts of the Indian subcontinent are affected by the forms of labour organization. Presently underutilized resources like human excreta may be most easily mobilized since the use of these resources, it is assumed, is not severely constrained by social relationships. Adoption of improved technologies for the use of limited resources is hastening the deterioration of the resource base for the poor. Use of human excreta might shore up this base, but the Indian experience shows that unless programs are explicitly tailored for the poor, these programs are likely to exacerbate an already inequitable distribution of resources.

organic wastes, rural; Bangladesh; India; socio-economic

3122 Kochar, V.
Dept. of Preventive and Social Medicine,
Institute of Medical Sciences, Benaras Hindu
University, Varanasi 221005, India

Intrinsic regulators of man-parasite interactions: culture patterns and human behavior relevant to hygiene, sanitation and disposal of excreta in a rural W. Bengal region. Sanitation in Developing Countries Today, a conference sponsored by Oxfam with the Ross Institute of Tropical Hygiene, 5-9 July 1977, Pembroke College, Oxford, England. 23p. (To be published in a book "Sanitation in Developing Countries Today," by John Wiley & Sons, October 1978.) 3 tables 2 figures. 24 references.

This paper describes the attempts that were made to develop a quantitative index of sanitation for households to explore the relationship of such an index to social and health variables. A scoring method was developed after analyzing common indicators such as condition of ponds, condition of cattle sheds, etc. Such indexes, even though very crude, showed moderate to strong association with other social variables, namely: family occupation, caste, socio-economic status, family size. It is concluded that the goal of sanitary latrines and use of shoes may be able to answer the problems associated with the spread of fecal diseases but will have to wait for many, many years to diffuse in the whole rural population. The

behavioural control measures (which are cheap, feasible, and acceptable) offer a chance of some relief and benefit in the immediate future.

sanitation; health; hygiene; India; socioeconomic

3.2 Waterborne

3201

Asia Projects Department, International Bank for Reconstruction and Development, Washington, D.C., USA

Appraisal of Bombay water supply and sewerage project. International Bank for Reconstruction and Development. Report No. 88a-IN. USA. 76p. 22 of main text. 54 of annexes. 14 annexes. 9 tables. 4 graphs. 6 maps.

This report covers the appraisal of a U.S. \$58 million project to increase water supplies and to rehabilitate and commence expansion of existing sewerage systems in Bombay. The objectives are to improve living conditions for over 6 million people by providing 7-8 h of water supply, and expand sewage collection, treatment, and disposal systems. The engineering designs were carried out by the Bombay Municipal Corporation (BMC), Binnie and Partners, and tata engineers

India; water supply; sewerage; sewage treatment; urban; public health; septic tanks; flush toilets

3202

Asia Projects Department, International Bank for Reconstruction and Development, Washington, D.C., USA

Appraisal of the Singapore sewerage project — second stage Singapore. International Bank for Reconstruction and Development. Report No. 1602-SI. USA. 42p. 13 of main text. 29 of annexes. June 1973. 12 annexes. 7 tables. 3 graphs. 1 map.

This report covers the appraisal of a U.S. \$29.5 million sewerage project to improve and expand sewage collection and treatment. The project is the second stage of an on-going sewerage program. Its objective is to continue a program to provide sewer service to urban renewal and new housing areas. The project consists of extensions of the sewer system and the construction of new pumping stations and treatment works. These facilities will provide sewer services to all estimated 400 000 people not now served and reduce the number of households using night-soil collection.

Singapore; sewerage; urban renewal; night-soil collection

3203

Asia Projects Department, Water Supply Division, International Bank for Reconstruction and

Development, Washington, D.C., USA

Nepal water supply and sewerage project. International Bank for Reconstruction and Development. Report No. 2702-NEP. USA. 91p. 19 of main text. 72 of annexes. April 1974. 17 annexes. 19 tables. 3 graphs 5 maps.

This report covers the appraisal of a U.S. \$10.4 million water supply and sewerage project directed to improve and extend the service in Kathmandu and Talitpur. The water supply component includes two new spring sources for Kathmandu and Pokhara, a pumping station, a service reservoir, transmission and distribution mains, etc. The sewerage component consists of some 40 km of sewers, a pumping station, and two waste-stabilization lagoons for Kathmandu and Talitpur that will prevent raw sewage from contaminating nearby popular bathing places. Technical studies were carried out by Binnie and Partners of London.

Nepal; water supply; sewerage

3204

Black and Veatch International, Kansas City, Missouri, USA

Master plan, feasibility and preliminary engineering study for storm drainage and sanitary sewerage for the city of N'Djamena, Chad. Final report of a Master Plan prepared for the African Development Bank as executing agency for the Government of Chad. Africa. 12-1 - 12-8, 13-1 - 13-12, A3-1 - A3-10 1975. Chap. 12, Existing sanitary sewerage facilities. Chap. 13, Sanitary sewerage concepts. Appendix 3, Economic comparison between aqua-privy and conventional sewerage systems.

Chapter 12 of this master plan reviews existing sanitation systems in N'Djamena. The principal systems in use are septic tanks and pit privies although defecation in the open is common. Septic tank effluent disposal is by leaching well. Chapter 13 discusses the comparative merits of conventional sewerage and a combined aqua-privy sewerage system, and concludes, on the basis of cost, that the latter is the system of choice for N'Djamena.

Chad; aqua-privies; sewerage; stabilization ponds; costs; drainage; rainwater

3205

East Asia and Pacific Projects Dept., Water Supply Division, International Bank for Reconstruction and Development, Washington, D.C., USA

Malaysia appraisal of the Kuala Lumpur sewerage Project. International Bank for Reconstruction and Development. Report No. 890a-MA. USA. 64p. 22 of main text. 42 of annexes. February 1976. 12 annexes. 18 tables. 4 graphs. 1 map.

This report covers the appraisal of a U.S. \$60.5 million project to improve and extend sewage collection and treatment facilities in Kuala Lumpur. It

is the first stage (1976-1981) of a 30-year master plan for sewerage development. In addition, the project would provide service to three newly created zones by means of new sewers, treatment plants, pumping stations, and sewage lagoons. The sewerage department of the city of Kuala Lumpur is responsible for carrying out the project.

Malaysia; sewerage; urban; stabilization ponds

3206

Europe, Middle East and North Africa Projects Department, International Bank for Reconstruction and Development, Washington, D.C., USA

Appraisal of the Amman water supply and sewerage project — II Jordan. International Bank for Reconstruction and Development. Report No. 71a-JO. USA 72p. 20 of main text. 52 of annexes. May 1973. 19 annexes. 18 tables. 3 graphs. 3 maps.

This report covers the appraisal of a U.S. \$11.5 million water supply and sewerage project that will extend the water service to the entire municipality, reduce the unaccounted for water, provide new sewer laterals and service connections to meet Amman's requirements until 1982. The Amman Municipal Water and Sewerage Authority (AWSA) is the agency in charge of the project.

Jordan; water supply, sewerage

3207

Projects Department, International Bank for Reconstruction and Development, Washington, D.C., USA

Appraisal of the Singapore sewerage project, Singapore. International Bank for Reconstruction and Development. Report No. TO-644a. USA. 42p. 23 of main text. 19 of annexes. June 1968. 14 annexes. 9 tables. 4 graphs. 2 maps.

The report covers the appraisal of a 4-year U.S. \$22.4 million sewerage project that is part of the Singapore overall development plan. The project provides for the construction of main sewers and pumping stations in nine areas. Several sludge treatment and disposal facilities will be upgraded and constructed. Planning, design, and construction were the responsibility of Public Works Department (sewerage branch) of the Government of Singapore.

Singapore; sewerage; urban renewal; sludge; public health; low income population

3208

Projects Department, Europe, Middle East and North Africa Regional Office, International Bank for Reconstruction and Development, Washington, D.C., USA

Appraisal of a Hodeida water supply and sewerage project, Yemen Arab Republic. International Bank for

Reconstruction and Development. Report No. 7732-YAR USA. 40 of annexes. 16 annexes. 20 tables. 6 graphs. 2 maps.

This report covers the appraisal of a U.S. \$31.2 million project that is part of the Hodeida's master plan to the year 2000. The water supply component will provide house connections to 70% of the population and public taps to the remainder. The sewerage component provides for sewers to be constructed in all streets where water mains are to be laid, thus eliminating the unsanitary conditions that exist in the city as a result of the difficulty of disposal of sewage in septic tanks or cesspools. The sewage treatment and final disposal have not been selected. Among the possibilities are: ocean disposal, conventional complete treatment, or treatment in stabilization ponds followed by reuse for irrigation. Feasibility studies were prepared by Italconsult of Italy.

Yemen Arab Republic; water supply; urban; sewerage; ocean disposal; irrigation; stabilization ponds; wastewater reuse

3209

Public Utilities Projects Division, Eastern Africa Regional Office, International Bank for Reconstruction and Development, Washington, D.C., USA

Swaziland — appraisal of the water supply and sewerage project. International Bank for Reconstruction and Development. Report No. 5092-SW. 46p. 16 of main text. 30 of annexes. October 1974. 13 annexes. 11 tables 2 graphs. 1 map.

This report appraises a water supply and sewerage project in Mbabane Manzini and Nhlango at a cost of U.S. \$4 5 million. The project includes pumping stations using pipe lines for the Mbabane water supply as well as the extension of the reticulation system, a new trunk sewer system using oxidation ponds to serve the population.

Swaziland; urban; rural; stabilization ponds; septic tanks

3210

Regional Projects Department, Europe, Middle East and North Africa Regional Office, International Bank for Reconstruction and Development, Washington, D.C., USA

Appraisal of the first urban sewerage project, Tunisia. International Bank for Reconstruction and Development. Report No. 5812-TN. USA. 25 pages of main text. 36 of annexes. January 1975. 18 annexes. 7 tables. 5 graphs. 5 maps.

This report covers the appraisal of an U.S. \$86.11 million project. The major component of the project consists of facilities to improve the existing inadequate sewerage of greater Tunis. The sewer network will be renewed and expanded and collector sewers constructed to intercept the dry weather flows and carry them to sewage treatment plants. Interceptor canals will be

constructed to prevent storm water overflows from polluting the Lake of Tunis. The major benefits are land appreciation and some revenues devised from the sale of treated sludge for fertilizer use. The Office National de l'Assainissement (ONAS) has the design, construction, and operation of the project.

Tunisia; sewerage; urban; interceptor canals; pollution; sludge

3211

Regional Projects Department, Latin America and the Caribbean Regional Office, International Bank for Reconstruction and Development, Washington, D.C., USA

Appraisal of Kingston sewerage I and water supply project — Jamaica. International Bank for Reconstruction and Development. Report No. 615a-JM. USA. 61p. 19 of main text. 42 of annexes. 13 annexes. 16 tables. 5 graphs. 2 maps.

This report covers the appraisal of a U.S. \$30 million sewerage and water supply project for the Kingston-St. Andrew area in Jamaica. The objective of the water portion is to satisfy water decreases during 1976-1980. The project considers the development of the Blue Mountain rivers and Wag Water River. The sewerage port is intended to reduce health hazards that arise from contamination of groundwater and pollution of the harbour and its tributary streams. The Water Commission of Kingston-St. Andrew is responsible for carrying out the project.

Jamaica; water supply; sewerage; harbour pollution; groundwater pollution; health

3212

Regional Projects Department, Latin America and the Caribbean Regional Office, International Bank for Reconstruction and Development, Washington, D.C., USA

Appraisal of medium cities water supply and sewerage project — Mexico. International Bank for Reconstruction and Development. Report No. 885a-ME. USA. 57p. 25 of main text. 32 of annexes. November 1975. 8 annexes. 11 tables. 3 graphs. 1 map.

This report covers the appraisal of a U.S. \$90 million water supply and sewerage project in eight medium-size cities in Mexico. The project will increase the water supply in the cities concerned. The sewerage service provided to low-income groups will be an important factor in controlling diseases caused by land excreta disposal. The executing agency is the Secretaria de Recursos Hidraulicos (SRH).

Mexico; water supply; sewerage; excreta disposal; low-income population

3213

Regional Projects Department, Latin America and the Caribbean Regional Office, International

Bank for Reconstruction and Development, Washington, D.C., USA

Appraisal of the water supply and sewage project for New Providence Island — Bahamas. International Bank for Reconstruction and Development. Report No. 940a-BM. USA. 68p. 18 of main text. 50 of annexes. June 1976. 15 annexes. 18 tables. 4 graphs. 1 map.

This report covers the appraisal of a U.S. \$32 million project to improve the water supply and sanitary sewerage services for the Island of New Providence. The primary goal is to increase the supply of water to 6 million gallons (ca. 22 million litres) per day from well fields to be developed on Andros Island and transported by tankers to New Providence. The project also supports a water conservation program as well as the rehabilitation of the sewerage system and an interceptor for ship sewage. The executing agency is the Water and Sewerage Corporation.

Bahamas; urban; water saving; ship sewage; sewerage; harbour pollution

3214

Regional Projects Department, Latin America and Caribbean Regional Office, International Bank for Reconstruction and Development, Washington, D.C., USA

Bolivia — Appraisal of the urban and rural communities water supply and sewerage project. International Bank for Reconstruction and Development. Report No. 1076b-BO. USA. 70p. 28 of main text. 30 of annexes. October 1974. 8 annexes. 26 tables. 4 graphs. 3 maps.

This project is designed to improve and extend water supply in approximately 70 rural communities and two cities in Bolivia in addition to extending sewerage in Sucre, at a cost of approximately U.S. \$15.0 million. The report provides practical criteria for the selection of communities to be improved. The main benefits of the rural port will be the improvement of health and disease in immigration to the urban centres. The studies and design will be prepared by local and foreign consultants for the urban component and by Corpaguas for the rural. Executing agencies will be Corpaguas, Arpos, and Ecapas.

Bolivia; water supply; sewerage; rural; maintenance

3215

Regional Projects Department, Latin America and the Caribbean Regional Office, International Bank for Reconstruction and Development, Washington, D.C., USA

Brazil — Appraisal of Minas Gerais water supply and sewerage project II. International Bank for Reconstruction and Development. Report No. 1042c-BR. USA. 58p. 22 of main text. 36 of annexes. June 1976. 12 annexes. 14 tables. 4 graphs. 1 map.

This report covers the appraisal of a U.S. \$134 million program for water supply and sewerage

projects in the state of Minas Gerais, Brazil. The project is composed of about 108 water-supply and sewerage subprojects to be constructed in communities ranging from 500 inhabitants to 1.6 million, benefiting a half-million new customers, improving the quality of water to 140 000 people, and providing sewerage service for about 400 people, thus reducing migration to major metropolitan areas. The Companhia de Saneamento de Minas Gerais, S.A. (COPASA), is responsible for the design and construction of the project.

Brazil; water supply; sewerage; urban; rural; irrigation

3216

Regional Projects Department, Western Africa Regional Office, International Bank for Reconstruction and Development, Washington, D.C., USA

Appraisal of the Abidjan sewerage and drainage project Ivory Coast. International Bank for Reconstruction and Development Report No. 5802-IVC. USA. 44p. 20 of main text. 24 of annexes. January 1975. 16 annexes. 22 tables. 1 graph. 2 maps.

A 10-year project consisting of laying 19.1 km of sewers with construction of associated works, 3.6 km of drains, a pilot scheme for the construction of public showers and toilets in low-income areas, a supply of vehicles, service equipment, and training of staff is described. The cost of the project is U.S. \$17 million. The main advantages of this project will be the improvement of public health and the environment, the reduction of pollution levels, and the reduction of incidences of flooding in low-lying sectors. The technical responsibility for the sewerage and drainage development lies with the Société d'équipement des terrains urbains (SETU).

sewerage; drainage; public showers; flooding; public toilets; low-income population; Ivory Coast

3217

Secrétariat des missions d'urbanisme et d'habitat (SMUH), Paris, France

Bibliographie sur l'assainissement et l'approvisionnement en eau dans les pays en voie de développement. (A bibliography on sanitation and water supply in developing countries.) Secrétariat des missions d'urbanisme et d'habitat (SMUH), France. January 1977. 139 references.

This is a bibliography of 139 entries with short abstracts of primarily French language literature dealing with both sanitation and water supply. (Original paper written in French.)

sanitation; sewers; developing countries; tropics; bibliography; water supply

3218

Service de l'habitat et de l'urbanisme, Paris, France

Principes d'assainissement collectif en milieu rural tropical. (Principles of rural community sanitation in the tropics.) Bureau central d'études pour les équipements d'outre-mer, France. 64p. December 1960.

This report describes the application of wastewater sewage to rural settlements in the tropics and discusses methods for calculating pipe diameters, slopes, etc. Some basic principles for treatment are given. (Original paper written in French.)

sewers; tropical; sewage treatment; construction

3219

South Asia Projects Department, Water Supply Division, International Bank for Reconstruction and Development, Washington, D.C., USA

Pakistan — Appraisal of the Lahore water supply, sewerage and drainage project, phase II. International Bank for Reconstruction and Development. Report No. 996A-PAK. USA. 131p. 25 of main text. 110 of annexes. April 1976. 16 annexes. 27 tables. 3 graphs. 3 maps.

This report covers the appraisal of a project that forms part of a long-range program for improving water supply, sewerage, and drainage in Lahore. The project, at a cost of U.S. \$46.3 million, will provide a water supply to 600 000 people, sewerage to an additional 250 000 and will alleviate flooding that takes place during the monsoon by means of the drainage works. The water component includes the construction of 47 tube wells and 193 miles (ca. 310 km) of transmission lines and filters. The sewerage and drainage components include about 300 miles of sewers, 21 miles of drainage channels, four pumping stations, and one large waste stabilization pond. The project will have definite environmental impacts in the Lahore area. Camp Dresser and McKee Ltd. and A.F. Ferguson & Co. were the consulting engineers for the project.

Pakistan; water supply; sewerage; drainage; flood prevention; stabilization ponds; night-soil collection

3220

World Health Organization, Geneva, Switzerland

Community water supply and excreta disposal in developing countries. Review of progress. World Health Statistics Report. Switzerland. Vol. 29(10). 544-631. 1976. (Bilingual: English and French.) 10 tables. 16 figures.

□ This special WHO issue reviews the progress of community water supply and excreta-disposal services in the developing countries in the period 1970 to 1975. It furnishes estimates of investments required to meet the WHO targets for 1980 and outlines courses of action to meet these goals. Globally, there has been an

increase in the percentage of urban population served by excreta-disposal facilities from 71% (337 million people) to 75% (437 million people) in this 5-year period. These were served either by connection to the public sewerage system or through household systems. There was, however, a drop in the percentages of population with house connections to the public sewerage systems from 27% in 1970 to 25% in 1975; that is to say, any increase in connections to the public sewerage system could not keep pace with the increase in urban population. The 1980 WHO targets expect that 95% of the urban population would have excreta-disposal facilities and roughly U.S. \$16 billion would be required to accomplish this goal. The global percentage of rural people who had adequate excreta-disposal facilities rose from 11% (134 million people) in 1970 to 15% (209 million people) in 1975. The 1980 WHO targets expect to increase this figure to 25% and that approximately U.S. \$2 billion would be needed for this purpose.

developing countries; water supply; excreta disposal; costs

3221 Contractor, J. C.
Agrawal, M. C.
(Both) Department of Civil Engineering, S. V. Regional College of Engineering and Technology, Surat, India

Simplified treatment for urbanized village. Report on the seminar on sewage treatment and disposal for small communities. India. Paper No. 11. 4p. March 13-14, 1971. 3 tables. 6 references.

The costs of sewers and sand filters used to collect and treat sewage from Umra and Piplod villages on the outskirts of Surat are reviewed. Sewers and manholes cost 9 rupees per capita at Umra, population 2500, and 12.6 rupees per capita at Piplod, population 450. Sand filtration sewage treatment cost at both villages was about 8 rupees per capita.

sewage treatment; sewer costs; sand filtration; India; urban

3222 de Azevedo Netto, J. M.
Sistemas de Esgotos Sanitarios de Baxo Costo Otimizacao Economica dos Projetos de Esgotos, Sao Paulo, Brazil

Otimizacao economica dos projetos de esgotos. (Cost optimization (minimization) of sewer design.) Revista DAE. Brazil. Vol. 35(105). 71-81. 1976. 4 figures. 9 tables

A review of sewer design principles shows that substantial cost savings (40-50%) can be made by improved layouts for sewer networks, correct choice of pipe material, and the use of small diameter inspection holes to replace more expensive manholes at many points in the network. (Original paper written in Portuguese.)

economics; sewer costs; design criteria

3223 Elong, P. M.
University of Cameroon, Cameroon

Study of Douale's wastewater disposal system. Planning, Housing, Information (Secrétariat des missions d'urbanisme et d'habitat). France. No. 74. 62-67. August 1973. 1 table.

A sewerage system in the city of Donale, Cameroon, serves only a sixth of the area of the town and due to lack of maintenance, poor operation is reported; as a result, the surface rainwater drainage system is utilized for waste disposal. Environmental pollution results also from lack of sewage treatment facilities.

Cameroon; sewers; urban

3224 Feachem, R.
Dept. of Civil Engineering, University of Birmingham, U.K.

Appropriate sanitation. New Scientist. U.K. 68-69. Issue 8. January 1976. 1 figure.

The author shows that conventional sewerage is, in economic and social terms, an inappropriate solution for excreta transport in tropical cities. More research on alternative solutions such as aqua-prives is required and it is suggested that the World Health Organization should play a more active role in evaluating alternative sanitation technologies.

sanitation; sewerage; excreta disposal; costs; construction; aqua-prives; water consumption

3225 Hansen, J. A.
Dept. of Sanitary Engineering, Technical University of Denmark, Denmark

Therkelsen, H.
Dept. of Civil Engineering, University of Washington, Seattle, USA

Alternative sanitary waste removal systems for low-income urban areas in developing countries. Polyteknisk Forlag Publishers. Denmark. 143p. 1977. 16 chapters.

An investigation of alternatives to traditional Western world sewerage (flushed toilet and piped network) for the removal of human wastes from high density, low-cost housing in developing countries is reported. A hypothetical case based on background data from Lagos, Nigeria, has been used for the analyses of cost-benefits of various systems and the systems applicability. It is concluded that at high densities, e.g., above 400 capita / ha, an aqua-privy and piped liquid disposal systems are more favourable. At low densities, e.g., 125 capita / ha and less, the nonpiped disposal systems appear preferable.

developing countries; excreta; cost-benefit; aqua-prives; economics; waste-disposal systems

3226 Kenneth, L.
Hutzler, N.
Boyle, W. C.

(All) Civil and Environmental Engineering Dept., University of Wisconsin, Madison, Wisconsin, USA

Household wastewater characterization. Journal of the Environmental Engineering Division, Proceedings of the American Society of Civil Engineers, USA. 100(EE1), Paper No. 10372. 201-213. February 1974. 9 tables. 46 references.

To effectively study alternatives to the treatment and disposal of wastewaters from individual homes, a study was conducted to evaluate the qualitative and quantitative characteristics of wastes generated by both rural and urban households. A survey of a number of households, in concert with the analysis of current information available in the literature, provided data to establish guidelines characterizing individual wastewater events within the homes.

wastewater; household; rural; urban; sewage treatment

3227 Koneigsberger, O. H.
International urbanization survey — removal and treatment of solid and liquid wastes. Report of the Ford Foundation. USA. 98-142. 1972. 64 references.

A general discussion of excreta-disposal problems in rapidly urbanizing areas of developing countries is given.

urban; excreta removal; developing countries; surveys

3228 Lemome, L.
Comité interafricain d'études hydrauliques, Upper Volta

Michel, C.
École inter-États des ingénieurs de l'équipement rural, Upper Volta

Essai d'adoption à l'Afrique tropicale des méthodes classiques de calcul du débit des ouvrages d'assainissement urbain. (Experiments in applying traditional urban sanitation formula to tropical Africa.) Série Hydrologie du Comité interafricain d'études hydrauliques, Upper Volta. 35p. May 1972. 8 references.

A study of adapting Western mathematical methods for designing waterborne sewerage systems to tropical African conditions, is reported. (Original paper written in French.)

Africa; sewers; design; mathematical models

3229 Marais, G. V. R.
Dept. of Civil Engineering, University of Cape Town, South Africa

Design criteria for community wastewater collection systems for developing countries. World Health Organization. Switzerland. Unpublished report. CWSS / WP / 73.6. 7p. 1973.

A review of sanitation needs for low-income high-density housing schemes leads the author to conclude that the best solution in areas where there is a

water supply is an aqua-privy sanitation block connected to small-bore (100 mm) flat-grade sewers discharging into a series of stabilization ponds. The water supply need not be an in-house or on-lot piped supply. The proposed system is most suitable for "site and service" housing schemes.

sewage; excreta; sewerage; aqua-privies; latrines; waste-disposal systems; design criteria

3230 Marais, G. V. R.
University of Cape Town, South Africa

Sanitation and low cost housing. In Jenkins, S. H., ed., Water Quality: Management and Pollution Control Problems U.K. Pergamon Press, Oxford. 115-125. 1973. 1 figure. 4 references.

The author claims that access to work, water supply, and sanitation are more important than shelter when providing housing in the tropics and subtropics. The disadvantages of pit and bucket latrines, water-carried sanitation, and communal facilities are described. An aqua-privy system in which sullage is discharged to the tank and effluent is passed to waste stabilization ponds is advocated.

sanitation; pit latrines; aqua-privies; stabilization ponds; tropics; single houses

3231 Oakley, H. R.
Goode, G. S. G.
(Both) J.D. and D.M. Watson, High Wycombe, U.K.

The planning of sewage systems in developing countries. In Civil Engineering Problems Overseas. U.K. 383-400. Published by Institution of Civil Engineers. 1971. 7 tables. 16 references.

□ This paper describes the planning of sewerage schemes in developing countries in Southeast Asia and the Middle East. The influences of climate, water supply, availability of skilled labour and materials, and the living and health standards of the community are discussed. Project appraisal, design criteria and the administrative requirements of sewerage schemes are discussed in general terms and in relation to specific cities in the Middle and Far East.

Southeast Asia; Middle East; sewerage; planning; costs; sewage

3232 Pickford, J.
Loughborough University of Technology, Loughborough, U.K.

Sewage treatment in developing countries. Water Pollution Control. U.K. Vol. 76(1). 65-66. 1977. 1 table. 21 references.

The shortage of water in many urban areas of developing countries makes water-carried sewerage unsuitable. Waste stabilization ponds are usually ideal, but a number of plants using conventional treatment processes have been built.

- 3233 Siddiqi, R. H.
National Environmental Engineering Research
Institute, Nagpur, India
Characteristics of domestic and municipal sewage in India. Public Health Engineering Division, Institute of Engineers, India. Vol. 55(3). 85-88. June 1975. 5 tables. 4 figures. 11 references.

This paper deals with the characteristics of domestic and municipal sewage from some cities in India along with average values reported for the USA. Various parameters that are described include physicochemical and biological characteristics, per capita daily contribution of sewage, BOD rate constants, and relationships between BOD and COD.

India; USA; domestic; municipal sewage; BOD; COD; flow rate

- 3234 Singh, G. P.
The sewage system of the city of Rangoon. Public Health Engineer. U.K. No. 9. 96p. May 1974.

A brief account of the history and present extent of sewerage in Rangoon is given. Night soil is dumped into sewers, which discharge untreated sewage into the Irrawaddy River, or the night soil is buried.

Burma; sewerage; excreta

- 3235 Vincent, L. J.
Algie, W. E.
Marais, G. V. R.
(All) African Housing Board, Lusaka, Northern Rhodesia (Zambia)

A system of sanitation for low cost high density housing. Symposium on Hygiene and Sanitation in Relation to Housing, CCTA/WHO. Niger. Publication No. 84. 135-173. 1961. 18 figures. 7 references.

■ An aqua-privy sewerage system has been proposed and developed in Rhodesia for effective treatment and disposal of sewage from dwelling houses. The ideas that form the basis of the system are: (a) to discharge all the wastewater from the household into the aqua-privy tank and by this means retain the seal around the chute; (b) to dispense completely with soakaways by discharging the effluent from the aqua-privy tank into sewers to stabilization ponds; (c) to use the aqua-privy as a sedimentation tank for all inorganic solids and to pretreat the organic pollution solids to a more amenable form for transportation in the sewers. The important features of the system include: (a) the sanitation block, which can be located astride the common boundary or corners of the plots it serves. It consists of two, three, or four units, one unit per family. Each unit comprises a latrine cubicle with an aqua-privy squat plate and chute, an ablution cubicle, in which a shower can be installed, and a washing trough under cover of the roof; (b) the tank, which receives all the wastewater,

located underneath the building. This wastewater maintains the seal around the chute of the aqua-privy squatting plate, thus dispensing with the necessity of manually adding water to the tank; (c) the water carriage system for transportation of overflow from the tank into the collecting sewer is drained into a series of stabilization ponds where it is purified. Since there are no sand, stones, and other large solids entering the sewer, design of the sewer can be economic because the minimum velocity of flow can be reduced to 1 ft/s (30.48 cm/s). In consequence the grade of sewer layout can be very flat, and sewer diameter can also be reduced to a certain extent; (d) the stabilization ponds for final purification of the tank effluent. Treatment can be accomplished to a high degree by employing a series of ponds, usually three. Since there are no stones or sand present, the inlet arrangement to ponds treating aqua-privy effluent can be of the simplest character. Design details of each of the above facilities are described in appendices. Installation cost of the ponds and ancillaries in Northern Rhodesia is reported to be between six pence and one shilling as compared to between 5 shillings and 1 pound (1961) for conventional small-disposal works per gallon (4.546 litres) treated per day. Maintenance costs are also minimal as there are no pumps, cisterns, or other mechanical equipment to give rise to high maintenance costs. Experience with existing installations of this type of system has revealed random blockages in the sewer lines due to introduction of large-size materials into the manholes. Some correction measures suggested include replacement of the manhole covers with medium duty-type covers and transporting the effluent containing large materials directly to the ponds through a tanker service.

aqua-privies; household; wastewater; sewage treatment; stabilization ponds; design; installation; maintenance; costs; Rhodesia Zambia

- 3236 Wall, J. D.
Howard Humphreys and Sons, U.K.

The proposed main drainage of Lagos. Proceedings of a Conference on Civil Engineering Problems Overseas. The Institution of Civil Engineers. U.K. 133-140. 1958. 1 figure.

A report of a proposal for sewerage of Lagos, Nigeria is given. Collected night soil would be screen-washed and the wash-water discharged to sewer. Previous unsuccessful attempts to disintegrate night soil are described. The "Apapa method" of sewerage is proposed: effluent from septic tanks together with sullage would pass to shallow sewers laid at flat gradients, with considerable saving of capital cost.

sewerage; septic tanks; Nigeria; night-soil treatment

- 3237 Mann, H. T.
Stevenage Laboratory, Stevenage, Hertford-

shire, England
Sewage treatment for small communities. Environmental Conservation. Vol. 1(2). 145-152. Summer 1974. 5 figures 10 references.

Many small communities use septic tanks as a method of partial sewage treatment in situations where effluents may be satisfactorily discharged into the soil. These systems are also suitable for use in many situations where intermittent occupation occurs. Where effluents are discharged into streams in which serious pollution is likely, further treatment by secondary processes is necessary, and in many situations tertiary treatment processes are added as a final safeguard. Prefabricated or package-plant systems, using variants of the activated-sludge process or special types of percolating filter, have become available and can be designed by the manufacturers to satisfy all of the purposes of primary and secondary treatment in specific situations. Maintenance requirements of most of these processes are small, but no system may be operated for long periods without a minimum of maintenance.

sewage treatment; small communities; septic tanks; activated sludge

3238 Pickford, J.
Loughborough University of Technology, Department of Civil Engineering, Loughborough, England

Indexed bibliography of publications on water and waste engineering for developing countries. Loughborough University of Technology, Department of Civil Engineering, Water and Waste Engineering for Developing Countries Group. June 1977

A bibliography arranged in alphabetical order of the first-named authors with cross-references to other authors and a keyword index is given. More than 550 documents are listed on water and waste engineering for use in developing countries.

bibliography; wastewater; developing countries

3239 Pineo, C. S.
Consulting Engineer, 5936 Avon Dr., Bethesda, Maryland

Subrahmanyam, D. V.
Sanitary Engineer, World Health Organization, Geneva, Switzerland

Community water supply and excreta disposal situation in the developing countries (a commentary). World Health Organization, Geneva, Switzerland. Offset publication no. 15. 1975. 9 tables. 11 references.

This publication is an analysis and commentary on the salient data presented in the earlier publications of the World Health Organization. Progress made in the urban sector between 1962 and 1970 is reviewed and prospects of reaching the new goals for developing countries are studied.

developing countries; water supply; excreta disposal

3240

Tarr, J.
McMichael, F.
(Both) Carnegie-Mellon University, Pittsburgh, PA., USA

Decisions about wastewater technology. Journal of the Water Resources Planning and Management Division, American Society of Civil Engineers. Vol. 103(1). May 1977. 47 references.

Discussion of this paper is focused on the key turning points in evolution of methods of collecting and treating domestic wastes between 1850 and 1932. It is suggested that there are many analogues between today's water-quality movement and those in the past. The 1850-1932 time span can be divided into three periods: 1850-1880, 1880-1900, and 1900-1932. Each of these periods was dominated by a critical decision in terms of dealing with domestic wastes. The three turning points were: (1) the adoption of a system of sewers, one using water for transport of wastes; (2) the decision to build combined sewers to carry storm water as well as the wastewater; and (3) the decision on whether to treat wastewater or drinking water. The adoption of a technology and its development in each historical period strongly influenced choices in subsequent periods; here it is indicated that the heritage of the original adoption of a water-carriage system for domestic waste removal is at the root of today's water pollution problem.

wastewater; sewage treatment; sewers; water treatment; water supply; water quality

3241

World Health Organization, Geneva, Switzerland

Global workshop on appropriate water and waste water treatment technology for developing countries. A report on the Global Workshop held in Voorburg, The Netherlands. 17-22 November 1975. WHO International Reference Centre for Community Water Supply, The Hague, The Netherlands. Bulletin series no. 7.

This pamphlet contains the collective views of an international group of experts who reviewed the most important problems of community water supply and wastewater disposal in developing countries. Broad areas of further research are defined and recommendations are made.

wastewater; developing countries

3242

World Health Organization, Geneva, Switzerland

Disposal of community wastewater. WHO Technical report series No. 541. Geneva. 72p. 1974.

This pamphlet contains the collective views of an international group of experts who reviewed the most important problems of community wastewater disposal in developing countries and defined broad areas for further research. It briefly assesses the

various methods of night-soil disposal in both urban and rural areas.

sewage treatment; reuse

3.3 Ponds

3301 Alagarsamy, S. R.
Bhalerao, B. B.
(Both) Central Public Health Engineering
Research Institute, Nagpur, India

Low cost waste treatment system for cantonment and townships. Proceedings of the Seminar on Distribution and Maintenance of Electric Supply and Public Health Engineering Services in Cantonments and Townships. India. Held at the College of Military Engineering. 129-135. 1973. 4 tables. 2 figures. 5 references.

The design, operating efficiency, and costs of waste-stabilization ponds, mechanically aerated lagoons, and oxidation ditches in comparison with trickling filters are reviewed. The design of a sewage treatment plant to handle wastes from a population increasing from 1000 to 10 000 over 2 years is discussed.

sewage treatment; stabilization ponds; aerated lagoons; oxidation ditches; trickling filters; India

3302 Central Public Health Engineering Research
Institute, Nagpur, India

Design of oxidation ditch for M/s Hindustan Photo Film Manufacturing Co. Ltd., Ootacamund. Special report (consultancy) to M/s Hindustan Photo Film Manufacturing Co. Ltd. India. 16p. March 1974. 1 figure. 2 appendices. 2 drawings.

A report recommending oxidation ditch treatment for two communities of 1600 and 2100 people is given. Each treatment plant recommended included an oxidation ditch of 4 ft (1.2 m) depth, two cage rotors, one hopper-bottom settling tank, and sludge drying beds. A layout drawing of the plant is given for each case and details of construction outlined. Specifications for mechanical equipment are included as appendices.

sewage treatment; oxidation ditches; low-cost treatment; India; urban

3303 Secretaria de Recursos Hidraulicos, Mexico
City, Mexico

Determinación y desarrollo de costos de construcción, operación y mantenimiento de los diferentes procesos de tratamiento de aguas residuales. (Determination and development of construction, operation and maintenance costs of the different processes for the treatment of wastewater.) Secretaria de Recursos

Hidraulicos, Subsecretaria de Planeación Dirección General de Usos del Agua y Prevención de la Contaminación. Mexico. C. Proyectos INTUAL, S.A. Contrato No. SP-74-C-13. 2 volumes. 520p. 1974. 65 annexes. 150 figures.

The study determines the state of the art of wastewater treatment in Mexico and includes for several processes, the construction, operation, and maintenance costs. Through a nationwide inventory of the existing facilities, a rehabilitation program is designed to fulfill the treatment needs of each region. The report points out the lack of proper management as the major cause for poor operating conditions of the systems. Treatment cost data and curves are presented to aid the calculation of new projects. Finally, the report recommends construction of stabilization ponds for cities with populations up to 300 000, providing land availability; and sedimentation tanks for those cities where land is scarce. Imhoff tanks are suggested as an immediate solution for cities with populations of less than 100 000. (Original paper written in Spanish.)

Mexico; anaerobic lagoons; construction; costs; Imhoff tanks; maintenance; primary treatment; secondary treatment; sedimentation; stabilization ponds; vacuum filters; sewage treatment

3304 Arceivala, S. J.
Alagarsamy, S. R.
(Both) Central Public Health Engineering
Research Institute, Nagpur, India

Design and construction of oxidation ditches under Indian conditions. In Sastry, C. A., and Nandgaonkar, K. M., ed. Proceedings of the symposium on low cost waste treatment. India. Central Public Health Engineering Research Institute. 172-184. May 1972. 2 tables. 4 figures. 10 references. 1 appendix. Discussion.

This is a review of the design and construction of oxidation ditches for Indian conditions. Essential design criteria are listed, and the possible range of values given in a table. A design example is worked in the appendix, and a discussion is included.

sewage treatment; oxidation ditches; rural; design; India

3305 Arceivala, S. J.
Alagarsamy, S. R.
Lakshminarayana, J. S. S.
(All) Central Public Health Engineering Research Institute, Nagpur, India

Design and construction of aerated lagoons in India. In Sastry, C. A., and Nandgaonkar, K. M., eds., Proceedings of the symposium on low cost waste treatment. India. Central Public Health Engineering Research Institute. 131-138. May 1972. 1 table. 3 figures. 6 references.

A review of the design procedure for aerated lagoons in India. Construction features are discussed

and this form of treatment is recommended as the best compromise between conventional sewage treatment processes and stabilization ponds. A worked design example is included

sewage treatment; aerated lagoons; rural; design; India

3306 Arceivala, S. J.
Bhalerao, B. B.
Alagarsamy, S. R.

(All) Central Public Health Engineering Research Institute, Nagpur, India

Cost estimates for various sewage treatment processes of India. In Sastry, C. A., and Nandgaonkar, K. M., eds., Proceedings of the symposium on low cost waste treatment. India. Central Public Health Engineering Research Institute, India. 239-254. May 1972. 7 tables. 11 figures. 5 references. 1 appendix.

A comparison of estimated costs for construction and operation of waste-stabilization ponds, mechanically aerated lagoons, oxidation ditches, and conventional treatment using trickling filters is given. Five typical designs for populations between 5000 and 200 000 were compared. Land costs were considered separately as being variable from place to place. Waste stabilization ponds were found to be cheapest if land was not more costly than 55 000 rupees / acre (1972). The mechanically aerated lagoon was the next cheapest, and the oxidation ditch was less costly than trickling filtration up to a population level of 150 000 in India

sewage treatment; costs; India

3307 Arceivala, S. J.
Lakshminarayana, J. S. S.
Alagarsamy, S. R.
Sastry, C. A.

(All) Central Public Health Engineering Research Institute, Nagpur, India

Design, construction, and operation of waste stabilization ponds in India. Central Public Health Engineering Research Institute Publication. India. 128p. 1970. 20 figures. 16 tables.

A review of waste-stabilization pond principles and their application in design for Indian conditions is given. Techniques of pond construction are detailed and pond operation and maintenance discussed. Health aspects of sewage treatment in stabilization ponds are covered and alternatives for effluent reuse in agriculture, pisciculture, algal reclamation, and water recycle are introduced. A unique feature of this text is a collection of operating data from 38 stabilization ponds from different parts of the country and an evaluation of each pond for its treatment efficiency.

sewage treatment; low-cost treatment; stabilization ponds; anaerobic lagoons; India; effluent reuse

3308 Bokil, S. D.
Agrawal, G. D.
(Both) Department of Civil Engineering, Indian Institute of Technology, Kanpur, India

Performance of high rate shallow stabilization ponds. Indian Journal of Environmental Health. India. Vol. 18(2). 87-98. 1976 14 references.

The performance characteristics of high-rate shallow stabilization ponds treating domestic sewage are described. It is found that the overall BOD removal efficiency was about 85%. Depending on the rate of organic loading and the depth, even a pond as shallow as 35 cm had an anaerobic zone at the bottom. The algal cultures in the ponds showed an adaptability of growth that is in consonance with modern continuous culture theories. The percentage of the incoming total nitrogen converted to algae was about 25%, and about 30% of the total nitrogen was lost from the system. There was complete absence of *E. coli* at any depth and at any time.

sewage treatment; stabilization ponds; algae; loading

3309 Canter, L. W.
University of Oklahoma, Norman, Oklahoma, USA

Malina, J. F.

University of Texas, Austin, Texas, USA

Sewage treatment in developing countries. A report prepared by the University of Oklahoma, USA, for US AID Contract No. AID / CM-ta-C-73-13. 170p. December 1976. 2 figures. 18 tables. Plus numerous references from various countries.

The purpose of this study was to provide an overview of the state-of-the-art of sewage treatment in developing countries. Mention was made of processes utilized in developing countries from the context of available treatment system technology. No attempt was made to cover every process in detail. The paper was oriented to treatment applied for *sewered wastewaters*. Individual treatment systems were discussed in a report by van den Berg (Internal Report, AID Project, University of Oklahoma, 1974). Very little was located in the literature relative to "Alternative Disposal Methods." However, since this type of treatment has been finding wider application, an overview of current topics of interest was included in Appendix II of this report. Topics include algae removal by fish production, dutch ditch, advanced sewerless treatment, and wastewater reuse. This paper was developed following a review of published references on wastewater treatment in developing countries. In addition, selected non-U.S. and some U.S. references for developed countries were also identified relative to wastewater treatment. Because ponds are the process most used in developing countries, a portion of this report presents the use and costs of ponds and increases in treatment costs associated with the use of more sophisticated wastewater treatment processes.

developing countries; sewage treatment; bibliography

- 3310 Chaudhuri, N. Basu, A.
(Both) Jadavpur University, Calcutta, India
Ecologically balanced community wastewater disposal systems for developing countries. Journal of the Institution of Engineers, India. Vol. 56. Part EN2. 71-75. February 1976. 7 references. 6 tables. 5 figures.
The authors argue that wastewater disposal in large metropolitan areas such as Calcutta must be based on ecologically sound principles of waste reclamation and reuse. They propose a waste stabilization pond system whereby all the nutrients in wastewater are conserved for reuse as irrigation water, manure, and fish protein; in addition the wastewater treatment plant would be landscaped in an afforested green-belt area that would serve as a major recreational park for the area. It is estimated that 50 ha of land would be required for each unit flow of 10 000 m³ / day, i.e., about 6.7 m² of land per capita.
wastewater; India; sewage treatment; stabilization ponds; aquaculture
- 3311 Drews, R. J. L. C.
National Institute for Water Research, CSIR, South Africa
Field studies of large-scale maturation ponds with respect to their purification efficiency. Journal and Proceedings of the Institute of Sewage Purification. U.K. Part 3. 280-294. 1966. 3 tables. 7 figures. 4 references.
Large-scale maturation ponds situated in different climatic regions of South Africa have been studied with respect to their treatment efficiencies. It is concluded that the actual organic load applied per unit of pond capacity is a deciding factor so far as pond performance and effluent quality are concerned. Other parameters such as solar radiation and temperature also have effects on the pond performance as they supply heat and(or) energy for photosynthesis and organic decomposition, respectively. No definite correlation between bacterial die-off in the ponds and the intensity of solar radiation and(or) temperature has been found from this investigation.
South Africa; sewage treatment; stabilization ponds; organic wastes; temperature; solar; bacterial die-off
- 3312 Gloyna, E. F.
College of Engineering, University of Texas, Austin, Texas, USA
Facultative waste stabilization pond design. In Gloyna, E. F., Malna, J. F., Jr, and Davis, E. M., eds., Ponds as a Wastewater Treatment Alternative. Water Resources Symposium no. 9. Center for Research in Water Resources, College of Engineering, University of Texas at Austin. USA. 143-157. 1976. 2 figures. 4 tables. 13 references.
Facultative ponds are capable of handling wastewaters varying in both quantity and quality. Climatic conditions, primarily temperature and secondarily light, are most important design parameters. A basis for design of facultative ponds is presented that includes empirical equations and diagrams. Based on both economics and the overall quality of the effluent, facultative pond systems frequently are reported to compare favourably with conventional high-rate biological systems.
facultative ponds; wastewater; temperature; design; solar; economics; effluents
- 3313 Gloyna, E. F.
College of Engineering, University of Texas, Austin, Texas, USA
Waste stabilization ponds. World Health Organization Monograph Series No. 60. Switzerland. 175p. 1971. 44 figures. 28 tables. 164 references.
□ This is a general reference text written for sanitary engineers that includes basic theory of biological waste treatment, process design procedures and their alternatives, public health aspects, and common operational problems. A unique feature of the book is a worldwide survey of stabilization pond uses with a brief description of practices within various countries.
stabilization ponds; design; public health; sewage treatment
- 3314 Haridass, G. Sundaresan, B. B.
(Both) Public Health Engineering Dept., University of Madras, Guindy, India
Design criteria for batch operation of oxidation ditches. Journal of Institution of Engineers, Public Health Engineering Division. India. Vol. 54, Part PH 3. 84-88. June 1974. 6 figures. 5 tables. 5 references.
A pilot-scale oxidation ditch with cage rotor has been operated under batch process at various submergences. Experimental data on BOD removal, DO in the mixed liquor, oxygenation capacity, and power consumption indicate 13.5 cm submergence at 72 rpm to be the optimum. Design criteria for batch operation to counteract fluctuations in flow have been outlined and compared with a similar continuous system. A marked reduction in power consumption can be achieved without deleterious effects on effluent quality.
oxidation ditches; cage rotor; BOD; power consumption; sewage treatment; rotor speed; design criteria; batch system; effluents; India
- 3315 Harris, S. E. Reynolds, J. H. Hill, D. W. Filip, D. S. Middlebrooks, E. J.
(All) Utah Water Research Laboratory, College

- of Engineering, Utah State University, Logan USA
- Intermittent sand filtration for upgrading waste stabilization pond effluents.** Journal of the Water Pollution Control Federation. USA Vol. 49(1) 83-102. January 1977. 12 figures. 9 tables. 7 references.
- A pilot-scale experiment on intermittent sand filters indicates that lagoon effluents can be economically polished to become high-grade water. No serious operational problems are encountered during winter seasons; however, the effluent quality is observed to be slightly lower when compared to warm weather effluent quality. From the data obtained, the authors conclude that length of filter run is related to influent suspended solids concentration, hydraulic loading rates, and algal growth in standing water above the filter.
- algae; sand filtration; effluents; sewage treatment; stabilization ponds*
- 3316** Hernandez, L.
Investigación sobre una laguna de oxidación. (Investigation of an oxidation pond.) XIII Interamerican Congress of Sanitary Engineering. Paraguay. 13p. August 1972. 3 tables. 2 maps. 2 graphs. 8 references.
- This paper summarizes technical data relevant to research done in an oxidation pond in Venezuela where it was demonstrated that loads of 240 kg of BOD per day were feasible and that retention periods of 9.5 days did not reduce the efficiency of the pond in tropical climates, nor did it produce any other nuisances such as odours. (Original paper written in Spanish.)
- Venezuela; loading; organic wastes; stabilization ponds; odours; detention time; tropics*
- 3317** Jayangoudar, I. S.
Kothandaraman, V.
Thergaonkar, V. P.
Shaik, G.
(All) Central Public Health Engineering Research Institute, Field Centre, Ahmedabad, India
- Rational process design standards for aerobic oxidation ponds in Ahmedabad, India.** Journal of Water Pollution Control Federation. USA. Vol. 42(8). 1501-1514. August 1970. 7 tables. 22 references.
- The development of design criteria for oxidation ponds treating domestic wastewater in India is described. By utilizing data from pilot-scale experiments conducted year-round, the authors recommended the following: organic loading (BOD₅) = 200-250 lb/acre-day (90-113 kg), detention time = 6-7 days, and pond depth = 3-4 ft (ca. 1 m).
- design criteria; India; stabilization ponds; sewage treatment; loading; detention time; pond depth*
- 3318** Kharkar, C. B.
Venkatesan, T. L.
Tiwari, A. R.
(All) Bhilai Steel Plant, Bhilai, India
- Review of performance of the stabilization ponds at Bhilai.** In Sastry, C. A., and Nandgaonkar, K. M., eds., Proceedings of the Symposium on Low Cost Waste Treatment. India. Central Public Health Engineering Research Institute. 70-77. May 1972. 6 tables
- A review of the performance results from 1955 to 1968 of stabilization ponds at Bhilai in India is given. The ponds perform satisfactorily, are leased out for 2-year periods for fish culture, and the effluent is used to irrigate agricultural land.
- sewage treatment; stabilization ponds; pisciculture; effluent reuse; irrigation; India*
- 3319** Kremer, M.
Mekorothe Water Co. Ltd., Tel Aviv, Israel
- Dan Region sewage reclamation project.** Water Research. U.K. Vol. 6(4-5). 351-356. 1972. 1 table. 4 figures.
- Facultative recirculated ponds are employed to treat raw sewage from the Dan Region Association of Towns in Israel. Long detention time of the sewage permits accurate control and quality check before further treatment and recharge to groundwater. Although pond stratification is overcome by stirring, this method encourages algal growth including an increase of 20-30% of organic load to the ponds.
- facultative ponds; sewage; detention time; recharge; pond stratification; algae; Israel*
- 3320** Lee, S. J.
Environmental Engineering Division, Asian Institute of Technology, Bangkok, Thailand
- Performance of oxidation ditches in Thailand.** Master of Engineering Thesis No. 829, Asian Institute of Technology. Thailand. 85p. 1975. 9 tables. 33 figures. 57 references. 4 appendices containing 6 tables and 6 figures.
- A performance study of two full-scale oxidation ditches treating waste from a soft drink and milk plant in Thailand is reported. The milk plant waste-treatment plant was incorrectly designed and operated, and performance was always unsatisfactory. The soft drink waste plant performed well at organic loadings between 0.07 and 0.12 kg COD/kg MLSS per day and gave an effluent with COD less than 50 mg/litre. Fish were being bred in the ditch and no solids accumulation was noted during the study period. Laboratory studies of sludge settling are also reported.
- sewage treatment; oxidation ditches; Thailand; fish*

3321 Ling, H. C.
Environmental Engineering Division, Asian
Institute of Technology, Bangkok, Thailand
**Planning for water supply, liquid and solid wastes
handling in Asian towns.** Master of Engineering
Thesis No. 592. Asian Institute of Technology.
Thailand. 208p. 1973. 14 tables. 17 figures. 34
references. 11 appendices containing 21 tables and 14
figures.

This is a report on a study of alternatives for
economically and effectively administering and
operating water supply, and liquid and solid wastes-
handling systems in Asia. Slow sand filters were found
to be preferable for water supply, followed by
groundwater and, last, rapid sand filters. Sanitary
landfill was recommended for solid waste disposal but
collection of food wastes for swine feeding looked
attractive if administrative difficulties could be
overcome. Combined wastewater systems were found
to be most suitable, and use of night soil as fertilizer
was not considered economic. The town of Nong Khai
in Northeast Thailand, with a population of 25 000,
was used in a case study.

*water supply; sewage treatment; solid wastes; urban;
Asia*

3322 Malina, J. F., Jr
Rios, R. A.
(Both) Environmental Health Engineering,
University of Texas, Austin, Texas, USA
Anaerobic ponds. In Gloyna, E. F., Malina, J. F., Jr,
and Davis, E. M., eds, Ponds as a Wastewater
Treatment Alternative. Water Resources Symposium
no 9. Center for Research in Water Resources,
College of Engineering, University of Texas at Austin.
USA. 131-141. 1976. 4 figures. 13 references.

Anaerobic ponds are effective in the removal of
70-80% of wastewater BOD. The major mechanism of
waste stabilization is the bacterial conversion to
methane gas. Provision of sufficient depth is critical
for the anaerobic zone, and the practical depth
limitations are reported to be between 9 and 12 ft (ca.
3-4 m). These depths will also provide a surface
aerobic polishing zone for pond effluents. Recom-
mended detention times are 2-5 days. Another
essential element for maximum waste stabilization is a
uniform distribution of the influent, which should be
near the bottom of the pond.

*anaerobic ponds, wastewater; BOD; methane; pond
depth; detention time; effluents*

3323 Malnati, L.
Ministerio de Salud, Oficina de Saneamiento
Ambiental, Lima, Peru
**Experiencia en el Peru con lagunas de oxidación.
(Experience in Peru with oxidation ponds.)** Simposio
sobre Tratamiento y Disposición de Aguas Sanitarias.
Argentina. 38p. June 1976. 10 tables. 2 figures.

After 18 years of experience with oxidation ponds,
Lima's semi-arid climate has proven to be quite

suitable for efficient treatment of wastewaters This
report summarizes the bacteriological and biological
investigations done in Lima regarding the reuse of
wastewater for irrigation and aquatic life purposes. It
concludes that oxidation ponds are the most
economical means for sewage treatment in coastal
cities with tropical temperatures and sandy soils; these
can even be recovered for agricultural uses. (Original
paper written in Spanish.)

*Peru; agriculture; arid climates; aquaculture; fertili-
zation; fish harvesting; irrigation; landfill; reuse; solid
wastes; stabilization ponds; wastewater; tropics*

3324 Mara, D. D.
Dept. of Civil Engineering, University of
Dundee, Dundee, Scotland
Proposed design for oxidation ponds in hot climates.
Journal of the Environmental Engineering Division,
American Society of Civil Engineers. USA.
Vol. 101(EE2). 296-300. April 1975. 20 references.

The author proposes a design procedure of a series
of five to seven ponds operating in hot climates, each
having a retention time of 5 days, which is supposed to
reduce the BOD₅ of a strong wastewater from
1000 mg/litre to less than 25 mg
/ litre and reduce its fecal coliform count from
4 X 10⁷ / 100 ml to less than 100 / 100 ml. Although
the described technique is a mixture of mathematical
models and empirical design factors, it is claimed to be
an extremely economical design that can achieve a
high bacteriological quality without chlorination of
the effluent.

*design; sewage treatment; stabilization ponds; math-
ematical models; BOD; bacteriological quality;
effluents; tropics*

3325 Mara, D. D.
Dept. of Civil Engineering, University of
Dundee, Dundee, Scotland
Sewage treatment in hot climates. John Wiley & Sons
Ltd., U.K. 184p. June 1976.

□ Emphasizing appropriate designs for developing-
country situations, this book gives a succinct
description of facultative, maturation, anaerobic
pretreatment, and high-rate ponds. The major
advantages of pond systems are that they require less
maintenance, mechanical equipment, and energy than
other processes achieving secondary treatment of
wastewater. They are also far less subject to failure
than other forms of mechanical or chemical processes.
They are without doubt the most important method of
sewage treatment in hot climates where sufficient land
is normally available and where the climate is
favourable for their operation. The term "facultative"
refers to the most commonly used type of pond, which
is aerobic in its surface layers but anaerobic at the
bottom. A symbiosis exists between the bacteria
decomposing organics using carbon dioxide and
producing organic nutrients, and the microscopic

plant life algae, which use the inorganic nutrients and carbon dioxide to produce more cell material and the oxygen needed by the bacteria. Mixing is important to effective operation of the pond to break up thermoclines that separate the anaerobic benthic layers producing nutrients from the upper layers requiring them for oxygen production. Solar radiation is the driving force behind treatment, and algae the mechanism used to produce the oxygen through photosynthesis, which is required for treatment of the wastewater. Anaerobic ponds are often placed in a series with, but ahead of the facultative pond. Being heavily loaded they are anaerobic throughout their depth, and effect treatment through sedimentation of the settleable solids and their digestion in the benthic sludge layers. Although odours are often claimed to be the greatest drawback in employing this type of scheme, the relationship between odour development and organic loading is now reasonably well understood so this problem can be overcome at the design stage. Tremendous economies of land that are achieved by use of anaerobic ponds will often dictate their inclusion in large schemes. Such pond systems as described can achieve any required degree of purification at the lowest cost and with a minimum of maintenance by unskilled operators. Removal of pathogens within these ponds is considerably greater than in other methods of sewage treatment. They are well able to withstand both organic and hydraulic shock loads. They appear to be able to treat a wide variety of industrial and agricultural wastes and be designed so that the degree of treatment is easily altered. The methods used in construction are such that, should at some future date the land be required for some other purpose, it is easily reclaimed. Finally, the algae produced in the pond are a potential source of high protein food, which can be exploited by fish farming. Pond design layouts and parameters are discussed. Facultative pond design is suggested as best, being based on the principles of first-order kinetics in completely mixed reactors using temperature as the mean temperature of the coldest month that will provide the designer with the required pond areas. The resulting design can then be checked against operational characteristics of ponds in other parts of the world operating under similar climatological conditions. Design equations for expected indicators of disease-causing organisms in the effluent are also given. Example designs are provided and illustrate the techniques of calculation and implicit assumptions made.

stabilization ponds; sewage treatment; aerated lagoons; oxidation ditches; septic tanks; aqua-privies; effluent reuse; aquaculture; irrigation; biological filters; night-soil treatment

3326 Mara, D. D.
Dept. of Civil Engineering, University of Nairobi, Kenya
Design manual for sewage lagoons in the tropics. East African Literature Bureau. Kenya. 35p. 1975. 11

figures.

□ This is a small design manual for the construction of waste stabilization ponds (sewage lagoons) in tropical countries. The chosen method of design for facultative ponds is the modified Marais and Shaw procedure. Several designs are given for inlet and outlet structures and interpond connections.

stabilization ponds; design; tropics

3327 Marais, G. V. R.
African Housing Board, Ridgeway, Northern Rhodesia

A design chart for a series of oxidation ponds treating raw sewage and some remarks on the depth of the first pond. The Civil Engineer in South Africa. Africa. Vol. 5(9). 241-245. September 1963. 3 diagrams. 2 references.

Based on previously published theory, design charts are given from which the area required for a first-stage waste stabilization pond can be found, for a fixed BOD contribution per person per day.

stabilization ponds; sewage treatment; Africa

3328 Marais, G. V. R.
University of Cape Town, South Africa

Faecal bacterial removal in stabilization ponds. Journal of the Environmental Engineering Division, ASCE, USA. Vol. 100(EEL). 119-139. February 1974. 6 references. 12 figures. 2 tables.

A review of the kinetics of fecal bacterial removal in waste-stabilization ponds working from the earlier model of simple first-order kinetics in completely mixed ponds is given. The author shows that maximum efficiency of bacterial removal in a series of ponds occurs when each pond in the series has the same retention time. An Arrhenius equation is presented to describe the highly sensitive variation of the first-order rate constant for fecal bacterial removal with temperature. It is shown that in temperate climates with low winter temperatures little advantage is gained by having a series of small ponds rather than a single large pond; conversely in hot climates there is considerable advantage in series operation.

stabilization ponds; coliform bacteria; fecal bacteria

3329 Marais, G. V. R.
University of Cape Town, South Africa

New factors in the design, operation and performance of waste-stabilization ponds. Bulletin of the World Health Organization. Switzerland. Vol. 34. 737-763. 1966. 18 figures. 2 tables. 30 references.

The theory of waste stabilization pond design is reviewed and the operational performance of the full-scale ponds is discussed with particular reference to the removal of BOD and fecal bacteria and to the influence of wind action in preventing the onset of thermal stratification. When aqua-privies or septic

tanks are used as anaerobic pretreatment units, the surface area required for the pond system can be substantially reduced and there will be less likelihood of anaerobic conditions or rising sludge problems in hot weather. The use of the self-topping aqua-privy is recommended for use in low-cost high-density housing schemes. The health aspects of ponds systems are discussed in relation to pathogen survival and snail and mosquito breeding.

Africa; sewage treatment; anaerobic-aerobic ponds; septic tanks; stabilization ponds; aqua-privies; pathogens

3330 Martinez, C. F.
Departamento Nacional de Higiene Urbana y Rural, Ministerio de Salud Publica, Havana, Cuba

Funcionamiento de lagunas de oxidación en Cuba. (Operation of stabilization ponds in Cuba.) XIV Congreso Interamericano de Ingeniería Sanitaria. Mexico. August 1974. 1 table.

A study on 17 of the 260 stabilization ponds that exist in Cuba reports that BOD levels, suspended and settleable solids, and coliform content of the water were closely monitored under different loads. The author concludes that stabilization ponds are satisfactory for the treatment of domestic wastewater. BOD levels below 20 mg/litre and coliform removal from 90 to 99% was obtained, and the efficiency in sedimenting solids was 95%. (Original paper written in Spanish.)

Cuba; BOD; coliform bacteria; sedimentation; stabilization ponds; solids; tropics

3331 McGarry, M. G.
Pescod, M. B.
(Both) Environmental Engineering Division, Asian Institute of Technology, Bangkok, Thailand

Stabilization pond design criteria for tropical Asia. Proceedings of the Second International Symposium for Waste Treatment Lagoons. USA. 114-132. June 23-25, 1970. 6 tables. 15 figures. 38 references.

Based on experimental data of stabilization ponds from various locations in tropical climates, the authors find that areal BOD loading is a more significant factor in controlling areal BOD removal than detention period and depth of both anaerobic and facultative ponds. Design formulas for maximum areal BOD loadings of both types of the pond systems are present, which are reported to result in greatest areal BOD removal and decreasing pond area requirement

stabilization ponds; tropics; BOD; loading; design; detention time; pond depth; anaerobic; facultative ponds; sewage treatment

3332 Meiring, P. G. J.
Drews, R. J. L. C.
Van Eck, H.
Stander, G. J.
(All) National Institute for Water Research, Pretoria, South Africa

A guide to the use of pond systems in South Africa for the purification of raw and partially treated sewage. South African Council for Scientific and Industrial Research. South Africa. Special Report WAT 34. 48p. 1968. 6 tables. 5 figures. 43 references.

The design and operation of waste-stabilization ponds in South Africa is described with particular reference to anaerobic pretreatment, removal of fecal bacteria in maturation ponds, and the health impact of pond systems. Mechanically aerated lagoons are described, and a flotation method for the removal of algae from pond effluents is given.

sewage; Africa; stabilization ponds; septic tanks; health; aerated lagoons; flies; parasites; pathogens; fecal bacteria

3333 Middlebrooks, E. J.
Porcella, D. B.
Gearheart, R. A.
Marshall, G. R.
Reynolds, J. H.
Grenney, W. J.
(All) Water Research Laboratory, Utah State University, Logan, USA

Techniques for algal removal from wastewater stabilization ponds. Journal of the Water Pollution Control Federation. USA. Vol. 46(12). 2676-2695. December 1974. 1 table. 2 figures. 129 references.

This is an extensive review of 14 techniques for algal removal from stabilization pond effluents. Although many problems still exist, centrifugation, microstrainers, and coagulation-flocculation are considered as the potential processes. These evaluations are based on the criteria and available data, on their ease and dependability of operations, minimum maintenance and costs, and efficiencies of particulate removal.

algae ponds; effluents; centrifugation; microstrainers; coagulation; maintenance; costs; biological discs; autoflocculation; soil mantle; air flotation; granular media filtration; sand filtration

3334 Moshe, M.
Betzer, N.
Kott, Y.
(All) Water Commission, Ministry of Agriculture, Israel, and Technion, Haifa, Israel

Effect of industrial wastes on oxidation pond performance. Water Research. U.K. Vol. 6. 1165-1171. 1972. 1 figure. 4 tables. 12 references.

Cadmium, copper, nickel, zinc, and hexavalent chromium ions were tested in a bench-bioassay experiment for toxicity limits and possible application

to experimental oxidation ponds. It was found that the metal ions mentioned above are toxic, inhibiting *Chlorella* growth. However, when added at concentrations of 0.5-1.5 mg / litre to influent of oxidation ponds, the ponds continued to operate normally. Higher concentrations of 3 and 6 mg / litre did not adversely affect pond performance — not even a concentration of 6 mg / litre of each ion (a total metal ion concentration of 30 mg / litre) A mixture of 60 mg / litre metal ions brought about a decrease in algal numbers and caused a sharp drop in dissolved oxygen concentration. It is believed that since high pH causes metal ions to precipitate, oxidation ponds operating normally above pH 8.0 will tolerate metal ions in sewage containing industrial wastes for a long time before sludge accumulation will affect pond performance.

Israel; stabilization ponds; heavy metals; industrial wastewater

- 3335 Nadgir, K. N.
Murthy, C. K.
Shetty, M. S.
Murthy, C. R. N.
Murty, K. R.

(All) The Institution of Military Engineers, India

Distribution and maintenance of electric supply and public health engineering services in cantonments and townships. Proceedings of the Seminar held at the College of Military Engineering, India. 439p. 1973. 18 papers on water supply. 12 papers on sewage disposal. 18 papers on electrical services. 12 papers on maintenance and operation

Seminar proceedings including papers on water supply, sewage disposal, electrical services and maintenance, and operation make up this publication. Sewage treatment design, construction, and maintenance are included. Waste stabilization ponds, oxidation ditches, aerated lagoons, and septic tanks are among the waste-treatment systems covered.

sewage treatment; stabilization ponds; oxidation ditches; India; septic tanks

- 3336 Oswald, W. J.
Sanitary Engineering and Public Health Department, University of California, Berkeley, USA
Waste pond fundamentals. A syllabus in a course on waste ponds presented in conjunction with the International Bank for Reconstruction and Development Training Program. USA. 65p. December 5, 1975. 18 figures. 12 tables. 12 references.

Theoretical aspects of waste stabilization in pond systems are discussed, which include physical factors and biochemical and microbiological processes in the ponds. A summary of current design criteria of ponds in California and their performance data are presented and compared with each other according to the pond series numbers, loadings, depths, and detention times.

theory; wastewater; stabilization ponds; design criteria; USA; loading; pond depth; detention time

- 3337 Parhad, N. M.
Rao, N. V.
(Both) National Environmental Engineering Research Institute, Nagpur, India

Decrease of bacterial content in different types of stabilization ponds. Indian Journal of Environmental Health. India. Vol. 18(1). 33-46. January 1976. 2 tables. 8 figures. 11 references.

A report on studies of the efficiency of bacterial removal in three stabilization pond systems is given. Highest removal of coliforms *E. coli* and enterococci was achieved in a pond system with three cells and the lowest in the single-cell system.

sewage treatment; stabilization ponds; Escherichia coli; enterococci; India

- 3338 Parker, C. D.
Water Science Laboratories, Victoria, Australia
Experience with anaerobic lagoons in Australia. Proceedings of the 2nd International Symposium for Waste Treatment Lagoons. USA. 334-347. June 23-25, 1970. 6 figures. 16 tables. 4 references.

The design, performance, and operation of anaerobic lagoons in Victoria, Australia, are described. These lagoons treat either domestic sewage or domestic sewage plus industrial wastewaters from eight communities ranging from a population of 2.4 million down to 3500. A low level of odour generated from the ponds could be maintained if pond organic loadings were from 400 to 800 lb / acre-day (181-363 kg) during winter and summer, respectively.

anaerobic lagoons; sewage; Australia; odour; loading; sewage treatment

- 3339 Pescod, M. B.
Asian Institute of Technology, Bangkok, Thailand

Sludge handling and disposal in tropical developing countries. Journal Water Pollution Control Federation. USA. Vol. 43(4). 555-570. April 1971. 8 tables. 12 figures. 5 references.

A review of studies on the anaerobic digestion, lagooning and sand-bed drying of night soil and sewage sludges is given. No heating is necessary for anaerobic digestion with average temperatures near 30 °C and 10-day detention with loading up to 4.5 g volatile solids / day per litre of active digester volume. Air drying of sludges on sand beds will produce a cake with 25% solids at bed loading rates between 67.5 and 475 kg day solids / m² per year with optimum application depth of 20 cm. Lagooning efficiency can be improved if a decantation arrangement can be designed to remove separated supernatant.

sludge; anaerobic digestion; sludge lagooning; sand-

3340 Sanchez, A.
Aliaga, P.

(Both) Sección de Ingeniería Sanitaria, Universidad de Chile, Santiago de Chile, Chile
Experiencia en lagunas de estabilización en Cexas, Melipilla, Chile. Resultados principales. (Main results of the experiences with oxidation ponds in Cexas, Melipilla, Chile.) XIV Inter American Congress of Sanitary Engineering. Mexico. 30p. August 1974. 11 tables. 5 graphs. 3 references.

The performance of a system of three stabilization ponds operated in parallel and series is analyzed. BOD removal, coliform content, nutrients, suspended solids, and sludge accumulation are monitored for different loads and depths. The report concludes that anaerobic-facultative systems are more advantageous than simpler schemes. The study also proves experimentally some new design criteria based on temperature as the main parameter. (Original paper written in Spanish.)

Chile; anaerobic lagoons; BOD; coliform; design; domestic; facultative lagoons; nitrogen; sludge; stabilization ponds; temperature; wastewater

3341 Sastry, C. A.
Mohanrao, G. J.

(Both) National Environmental Engineering Research Institute, Nagpur, India
Waste stabilization pond design and experiences in India. In Gloyna, E. F., Malina, J. F., Jr, and Davis, E. M., eds., Ponds as a wastewater treatment alternative. Water resources symposium no. 9. Center for Research in Water Resources, College of Engineering, The University of Texas at Austin. USA. 299-313. 1976. 5 figures. 6 tables. 32 references.

The efficiency of stabilization ponds has been found to be somewhat comparable in BOD removal and superior in pathogen removal to that of conventional treatment (excluding disinfection). Many approaches that have been used in India for the design of waste stabilization ponds are discussed. Facultative ponds are favourable because they will reduce the area requirement.

stabilization ponds; facultative ponds; BOD; pathogens; sewage treatment; design; India

3342 Sauze, M.
Gervais, M.
Francette, M.

(All) Bureau central d'études pour les équipements d'outre-mer, Paris, France
Les étangs de stabilisation — synthèse des principales connaissances actuelles. (Stabilization ponds — a state of the art.) Informations et documents, 1^{er} trimestre. No. 1. BCEOM. France. 21-53. 1971. 2 figures. 2 tables.

This report summarizes basic concepts on oxidation ponds, including data from experiments in southern France. (Original paper written in French.)

France; economics; sewage treatment; stabilization ponds

3343 Shaw, V. A.
National Institute for Water Research, Council for Scientific and Industrial Research, Pretoria, South Africa

A system for the treatment of nightsoil and conserving tank effluent in stabilization ponds. CSIR reprint RW 166. Originally published in Africaans in Public Health (J'berg), South Africa. Vol. 63. 17-22. Originally presented at the 20th Annual Health Congress of the Institute of Public Health, U.K. 1963. 1 figure. 2 tables.

■ A report on a pilot plant waste stabilization pond study for the treatment of night soil and conservancy tank effluent is given. Recommendations for the design and construction of full-scale ponds are included.

South Africa; night-soil treatment; conservancy tanks; stabilization ponds

3344 Slanetz, L. W.
Bartley, C. H.
Metcalf, T. G.
Nesman, R.

(All) Dept. of Microbiology, University of New Hampshire, Durham, USA
Survival of enteric bacteria and viruses in municipal sewage lagoons. Proceedings of the Second International Symposium for Waste Treatment Lagoons. USA. 132-141. June 23-25, 1970. 6 figures. 6 tables. 12 references.

A study of the survival of enteric bacteria and viruses in oxidation pond systems used by three different communities in New Hampshire for the disposal of domestic wastes is reported. About 95-99% reduction of fecal bacteria was observed when these ponds were operated as one or two ponds in a series and their percentages of survival increase during the winter season. With systems of three or four ponds in a series, excellent removal of bacteria was obtained, but enteric viruses could still be isolated from the effluents, thus creating a chance of health hazards if such effluents are discharged into the environment.

bacteria; viruses; USA; domestic; stabilization ponds; public health; sewage treatment

3345 Sless, B. J.
Technion — Israel Institute of Technology, Haifa, Israel

Biological and chemical aspects of stabilization pond design. Reviews on Environmental Health. Israel. Vol. 1(4). 327-354. 1974. 6 tables. 4 figures. 29

references

The results of monitoring 29 stabilization ponds in Israel and laboratory model and pilot-scale ponds for physical, chemical, and biological parameter variation, show that pond design criteria, such as organic loading and retention time, exert a much greater influence on algal species composition and concentrations than does temperature. It was found that a series of ponds did *not* provide superior BOD removal than did a single large pond with a retention time equal to that in the series of ponds; in both cases BOD and nutrient reductions were about 70-80%. It is concluded that unless algal crops can be harvested economically, optimization of algal growth in conventional pond systems is unwarranted.

algae; stabilization ponds; Israel; sewage treatment

3346

Stander, G. J.

Mering, P. G. J.

(Both) National Institute for Water Research,
Pretoria, South Africa

Employing oxidation ponds for low cost sanitation. Journal Water Pollution Control Federation. USA. Vol 37(7). 1025-1033. July 1965. 1 figure. 4 tables. 11 references.

Sewerage and sewage treatment costs in southern Africa are reviewed and it is shown that it is possible to provide waterborne sewerage with treatment in stabilization ponds at a total cost similar to that of a pail conservancy system. The use of the self-topping aqua-privy in combination with small-bore flat sewers is described and recommended for low-income high-density areas. The treatment and disposal of night soil in facultative ponds are recommended in preference to trenching or spreading on land.

Africa; sewage; stabilization ponds; aqua-privies; excreta; economics

3347

Stander, G. J.

Mering, P. G. J.

Drews, R. J. L. C.

Van Eck, H.

(All) South African Council for Scientific and Industrial Research, National Institute for Water Research, Pretoria, South Africa

A guide to pond systems for wastewater purification. In Shuval, H. I., ed., Developments in Water Quality Research. USA. 125-164. 1970. 5 figures. 6 tables. 41 references

A description of waste stabilization ponds, according to its theories, methods of operation, and maintenance, is given. Although waste stabilization ponds provide economic advantages and are simple to construct and operate, they require proper planning and application, and periodical review of pond loading. Public health aspects of waste stabilization ponds are also discussed.

sewage treatment; stabilization ponds; theory; main-

tenance; construction; planning; pond loading; public health

3348

Talboys, A. P.

Centro Panamericano de Ingeniería Sanitaria y Ciencias del Ambiente (CEPIS), Lima, Peru

Stabilization pond installations in Latin America. CEPIS — Pan American Center for Sanitary Engineering and Environmental Sciences. Peru. July 1971.

This publication records the results of a survey of stabilization pond use in Latin America conducted by CEPIS in October 1970; 181 pond installations were reported in 20 Latin American and Caribbean countries and details are given of these systems. An abstracted bibliography of important local publications from 1956 to 1971 on waste stabilization ponds is included.

South America; sewage treatment; stabilization ponds; installation

3349

Van Eck, H.

Simpson, D. E.

The anaerobic pond system. Journal and Proceedings of the Institute of Sewage Purification. U.K. Part 3. 251-260. 1966. 3 figures. 10 tables. 10 references.

The anaerobic-aerobic ponds treating domestic sewage at Chatsworth in South Africa incorporate recirculation from the aerobic pond to the anaerobic pond. It is shown that this system is capable of treating much higher organic loadings without smell nuisance than a single aerobic primary stabilization pond. At temperatures above 25 °C, BOD removal of over 30% has been recorded; however, this efficiency decreases during the winter months and a thick scum forms on the anaerobic pond surface. The sludge that accumulates in the anaerobic ponds is reported to be well digested and similar to sludge produced by a conventional sewage works.

anaerobic-aerobic ponds; organic wastes; sewage treatment

3350

Varadarajan, A. V.

Raman, A.

Venkataswamy, R.

Munichami, M.

(All) Sewage Reclamation Research Unit, Kodungaiyur, Madras, India

Studies on the anaerobic lagooning of municipal sewage at Kodungaiyur, Madras. In Sastry, C. A., and Nandgaonkar, K. M., eds., Proceedings of the Symposium on Low Cost Waste Treatment. India. 23-29. Central Public Health Engineering Research Institute. May 1972. 2 tables. 5 references. Discussion.

A report of studies on anaerobic lagooning of Madras city sewage carried out between November 1967 and April 1969 is given. Lagoons were 38 X 38 m and were operated at depths of 2.4 and 2.1 m. BOD

removal ranged from 58 to 78% with a 4 - 5-day detention time and influent BOD between 276 and 560 mg/litre. Performance was best during summer months. Organic loading changes from 1080 kg/ha-day to 1360 kg/ha-day did not affect performance significantly. Odour was not a serious problem with the Madras sewage, containing about 50 mg/litre sulfate but sludge accumulation was high and desludging would be necessary after about 3 years.

sewage treatment; excreta disposal; anaerobic-aerobic ponds; India, urban

- 3351 Watson, J. L. A.
Ministry of Health, Jerusalem, Israel
Oxidation ponds and use of effluent in Israel. Proceedings of the Institution of Civil Engineers. U.K. Vol. 22. 21-40. 1962.

A description of the design and field performance of waste stabilization ponds in Israel is given. Recommendations are given for the design, construction, and maintenance of anaerobic and facultative ponds. Agricultural use of pond effluent for irrigation is discussed with particular reference to effluent quality in terms of its sodium absorption ratio.

Israel; effluent reuse; stabilization ponds; design; construction; maintenance; sodium absorption ratio

- 3352 Yanez, F.
Centro Panamericano de Ingeniería Sanitaria y Ciencias del Ambiente (CEPIS), Lima, Peru
Lagunas de estabilización. (Stabilization ponds.) Curso Intensivo sobre diseño de Plantas de Tratamiento de Aguas Residuales para Países en Desarrollo. Peru 36p. November 1976. 5 graphs. 2 figures. 29 references.

The author reports an increment of 357 lagoon installations in seven countries of Latin America and the Caribbean region in a 5-year period. This report provides a description of design criteria for various types of lagoons and outlines its restrictions according to geographic and climatic factors. Several practical suggestions learned from wide experience are presented. Special emphasis is given to the application of oxidation ponds in tropical climates where conditions allow for superficial loads 10-25 times greater than those permitted in countries with seasonal variations. (Original paper written in Spanish.)

Latin America; anaerobic-aerobic ponds; construction, design criteria; developing countries; facultative lagoons; loading; stabilization ponds

- 3353 Yao, K. M.
Institution of Public Health Engineering,
London, U.K.
Mosquito breeding in oxidation ponds. National Symposium on Wastewater Disposal. Pakistan. 56-61. April 17, 1975. 10 references.

A report on a 1-year study of mosquito breeding in four oxidation ponds is given. It was observed that the key to mosquito-breeding control is to keep the banks clear of weeds. In dirty water pools, malaria mosquitoes were observed.

mosquitoes; malaria; stabilization ponds

- 3354 Yau, C. H.
Environmental Engineering Division, Asian Institute of Technology, Bangkok, Thailand
Design parameters for oxidation ditches in the tropics. Master of Science Thesis, No. 643. Asian Institute of Technology. Thailand. 56p. 1974. 12 tables. 19 figures. 41 references. 1 appendix containing 1 table and 5 figures.

A report of pilot-scale studies on oxidation ditch treatment of a soft-drink bottling plant waste to develop design criteria suitable for tropical countries is given. Effluent COD increased with increasing COD loading but removal efficiency remained above 96% throughout the range of F/M of 0.07-0.78 with detention 48 h. At F/M 0.38, neither the COD removal rate nor ash content of the sludge varied when detention time varied between 17.5 and 48 h. Laboratory tests indicated that 0.6 g/litre of calcium acetate and 0.5 g/litre of sodium nitrate suppressed the growth of *Sphaerotilus* and eliminated bulking sludge problems in the ditch within 8 days.

sewage treatment; oxidation ditches; design; tropics; Asia

- 3355 Siddiqi, R. H.
Handa, B. K.
(Both) National Environmental Engineering Research Institute, Nagpur, India
Evaluation of some stabilization ponds in India. Journal of the Sanitary Engineering Division, Proceedings of the American Society of Civil Engineers. Vol. 97. No. SA1. Proceedings Paper 7912. 91-100. 1971. 7 figures. 11 references.

Due to favourable climatic conditions in India and simplicity of construction and operation, engineered waste stabilization ponds are successful. An analysis of the reported performance of some ponds found that anaerobic reactions dominate in waste stabilization at higher organic loadings.

algae; anaerobic; stabilization ponds; sewage treatment; India

3.4 Composting

- 3401 Dept. of Environmental Health, Institute of Health, Chinese Academy of Medical Sciences, Peking, China
Sanitary effects of urban garbage and night soil

composting in China. Chinese Medical Journal. China. Vol. 1(6). 406-412. November 1975. 8 tables.

In Peking, noncompostable material is reclaimed for utilization, and organic wastes are promptly transported out of the city and mixed with night soil for high-temperature composting. This not only helps improve sanitation, but provides agriculture with large quantities of high-quality organic fertilizers. The composition of the garbage, processing conditions of composting physical and chemical indices, and the effect of composting on ascarid eggs and maggots is discussed.

China; composting; excreta; urban; garbage; fertilization; health; reuse

3402

Department of Hygiene, District of Chien Ann Revolution Committee, Province of Hopei, China

Discussion on the implementation of unified management and hygienic disposal of excreta and urine. In Compilation of data on experience and sanitary management of excreta and urine in the village. Unpublished report of the International Development Research Centre. Canada. Translated from Chinese by Lee Thum Loy. 2-10. 1976. 3 tables. 3 figures.

■ Two methods of composting human excreta, livestock manures, and refuse with soil are described as being commonly used in China. These are said to raise the efficiency and increase the quantities of natural fertilizers, promote food production, reduce the pathogen content of the fertilizer and fly-breeding areas, and improve public health. The standardized techniques are twofold: (1) the surface aerobic continuous method; and (2) the large-pit aerobic composting method. The surface method is best for climates that do not reach freezing temperatures in the winter. The four materials are mixed in equal weights (the proportions vary considerably depending on the location and availability of raw materials) and laid on the ground 9 ft X 9 ft X 6 inches deep. Three-inch diameter bamboo rods are placed on the pile at 3-ft intervals in both directions. Bamboos are erected vertically where the horizontal bamboos cross. More compost is added to reach a pile depth of 3 ft. The pile is then covered with earth or preferably an earth and horse manure mix. The timbers are extracted when the earth is slightly dried. Generally it takes 20-30 days for the compost to be fully fermented in summer and winter, respectively. The large-pit aerobic composting method employs a pit of varying lengths, but one that is always 5 ft X 4 ft deep in which 3-inch² channels are dug along its bottom (one lengthwise and two across the pits width). These are covered with stalks of millet or the like and 3-inch diameter vertical bamboos erected at the ends and where the channels meet. The pit is filled with compost and covered with a layer of earth to prevent ingress of vermin and flies and with grass material to insulate the pit. The vertical bamboos are extracted, and the channels then act to ventilate the compost during fermentation, which takes 30 days.

This method can be used in below-freezing conditions. This article provides full details of mixing, pile preparation, and maintenance. The optimum water content in the composting material depends on the evaporation rate but should be about 30% during winter when evaporation is low, rising to 50% in the summer. The temperature should reach from 50 to 60 °C for at least 5-7 days. A report is made of experiments on the die-off of pathogens in the compost. Above 95% kill of ascarid eggs in the compost was achieved throughout the trials. (Original paper written in Chinese.) (Now available as IDRC-TS8e, "Compost, fertilizer, and biogas production from human and farm wastes in the People's Republic of China.")

composting; excreta; urine; animal wastes; China; pathogens; garbage

3403

Bhaskaran, T. R.
Ghosh Roy, B. K.
SamPATHkumaran, M. A.
Radhakrishnan, I.
Mukherjee, D. B.

(All) All India Institute of Hygiene and Public Health, Calcutta, India

Studies on the survival of pathogens in nightsoil compost. Indian Journal of Agricultural Science. India. Vol. 27. Part I. 91-102. March 1957. 2 diagrams. 5 tables. 9 references

■ The Bangalore method of composting, in which refuse and human excreta are used for manufacture of compost, has been advocated by the Central and State governments in India for disposal of night soil and refuse in rural and municipal areas. The purpose of this investigation was to study the fate of pathogenic organisms of intestinal origin in the composting process and to determine conditions under which night-soil compost could be free from the risk of infection. Data on the presence and viability of pathogens of the *Salmonella* and *Shigella* group of bacteria and the eggs of intestinal helminthic parasites such as *Ascaris*, hookworm, and *Trichurus* were obtained by analyzing compost samples from five different parts of the country as well as from eight experimental compost pits maintained under controlled conditions. For the latter case, city refuse and night soil were stacked in the pits in alternate layers of 6 and 2 inches (15 and 5 cm) respectively. In some of the pits refuse and night soil were mixed together in equal proportions of weight before filling in the pits. The size of each pit is 6 ft 3 inches wide at the base, 3 ft 3 inches wide at the top, 2 ft high, and about 6 ft 1 inch long. Sample collection was made by a 2-inch-auger and care was taken to see that representative samples were obtained from the pits at different stages. Results of the analysis show that in the experimentally controlled compost pits, both the number and viability of helminthic ova decrease rapidly within the first 1 month and they are completely eliminated in the course of 3 months. Bacteriologically, all the samples were uniformly

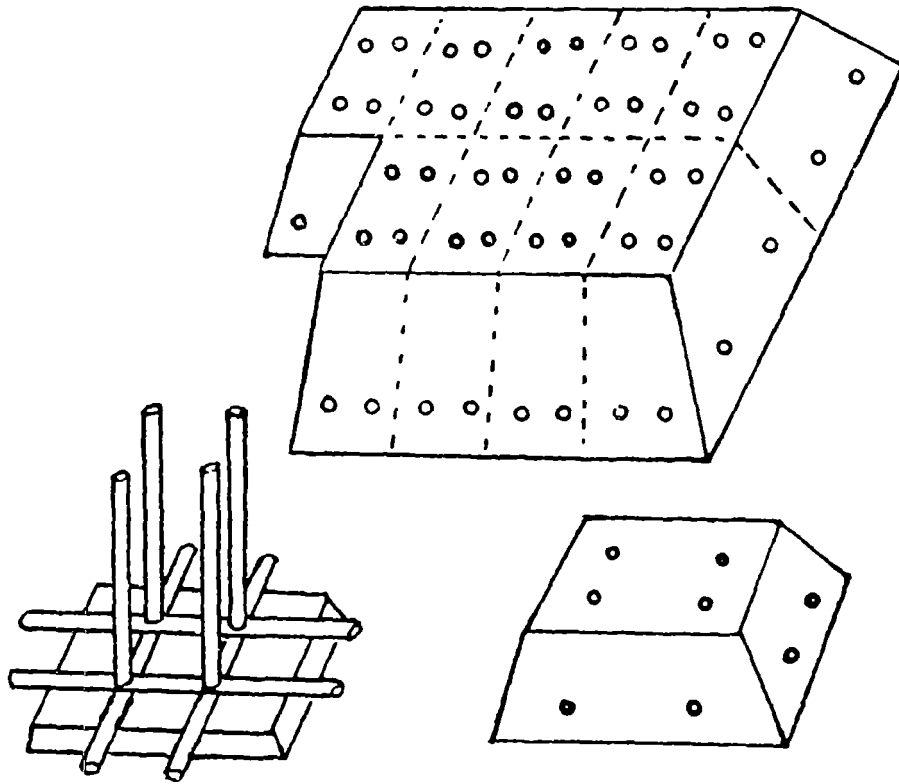

Chinese ground-surface continuous aerobic composting pile (from 3402).

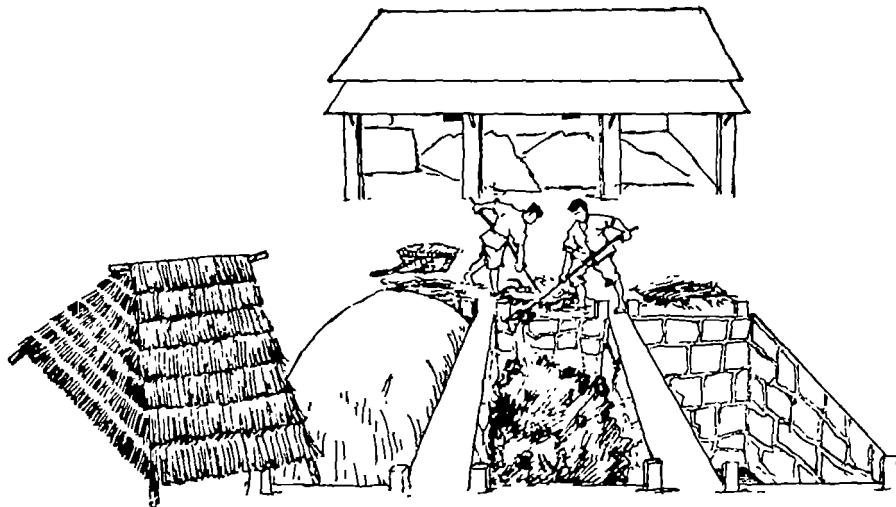

Full pit covered with earth and sheltered

Pit being filled

Empty pit

Fertilizer collecting pits being used in rotation (from 3402).

negative. This rapid destruction of the pathogens is reported to be caused by rising temperature inside the pits (about 104 °F), which was maintained under anaerobic conditions for a period of 10-15 days. However, the results of the samples collected from different states are found to be somewhat irregular, due to inadequate care and control in making of compost pits, and insanitary supervision during maturity period of the composting process. In a few cases, even 6-month-old samples showed the presence of a few eggs, some of which were viable. Chemical analysis of the compost obtained with night soil and town refuse shows that the product forms a well-digested manure that has potential agricultural value, having about 1% nitrogen and C/N ratio of 6 to 8. An important observation arising from these studies is that composting of night soil and refuse can be satisfactorily employed for hygienic disposal of human excreta provided that composting operations are carried out under controlled supervision. If the health departments of the states arrange for regular supervision of the composting operations so as to ensure that the compost pits are properly made up and are fully ripe before the material is taken out of the pits and used as manure, then there is very little hygienic risk involved in the use and handling of compost for agricultural purposes.

compost privy; India; pathogens; excreta

3404 Gilles, E. C.
Health Department, Nigeria
Composting. Farm and Forest. Nigeria. No. 2. 92-102. 1946. 2 tables. 2 graphs. 2 figures. 3 references

Disposal of human and animal excreta and domestic refuse by means of composting in Kane, Northern Nigeria, has resulted in the satisfactory and economic conversion of waste matter into humus of manurial value. This paper describes the methods of composting: its requirements, operation, and effects of weather/temperature. The use of the composting products as fertilizers has been very successful.

Nigeria; animal wastes; composting; fertilization; excreta, solid wastes

3405 Golueke, C. G.
Sanitary Engineering Research Laboratory,
University of California, Berkeley, USA
Composting: a review of rationale, principles and public health. Compost Science. USA. Vol. 17(3). 11-15. Summer 1976.

Composting is a process of waste treatment that will yield many advantages. However, the compost operation has to be done properly or otherwise it will make the conditions worse. Principles of composting and its related public health aspects are discussed.

composting; public health; theory; sewage treatment

3406 Gotaas, H. B.
University of California, Berkeley, USA

Composting-sanitary disposal and reclamation of organic wastes. World Health Organization. Monograph Series No. 31. Switzerland. 205p. 1956. 48 figures. 94 references.

□ Composting is proposed as a sanitary method for reusing human wastes in agriculture, while maintaining public standards. The fundamental theory of composting is described. A number of techniques are proposed that can be applied to cities, small towns, villages, and individual farms, respectively.

composting; rural; design; construction; urban; excreta; community

3407 Gray, K. R.
Sherman, K.
Biddlestone, A. J.
Clark, R.
(All) Department of Chemical Engineering,
University of Birmingham, U.K.

A review of composting — parts I, II, III. Process Biochemistry. U.K. Part I, June 1971. Part II, October 1971. Part III, October 1973. 17p. 11 figures. 12 tables. 168 references.

□ This three-part review discusses the process of composting as a municipal waste-disposal process that can provide humus to maintain intensively cultivated soils in a state of adequate fertility. The microbiological and biochemical aspects of the fundamental composting process are described. The chemical and physical parameters are described and it is concluded that sufficient data now exists for accurate process design of composting plants. The historical development and various systems of composting practiced since 1930 are enumerated. The properties of the compost product are described, as well as analytical methods involved in understanding the composting reaction.

composting; solid wastes

3408 Hills, L. D.
Henry Doubleday Research Association, Bocking, Braintree, Essex, U.K.
European methods of composting and sludge utilization. Compost Science. USA. 18-19. July-August 1972.

Methods of composting and sludge utilization in Europe are described. Sludge is primarily used as fertilizer, fish food, and for land reclamation, while composting is done by means of a "Clivus toilet." It is a family municipal compost plant that takes the excreta and urine and composts them with the kitchen waste to produce roughly 100 lb (45 kg) a year from a family of three, of a good high-potash organic fertilizer.

sewage treatment; landfill; excreta; fertilization; urine; Europe; organic wastes

- 3409 Hovsenius, G.
National Environmental Protection Board,
Solna, Sweden
Composting and the use of compost in Sweden.
Journal of the Water Pollution Control Federation.
USA. Vol. 47(4). 741-747. April 1975. 3 tables.
A description of a Swedish research program in
large-scale composting of dewatered sewage sludge,
domestic refuse, and night soil is given. Economic and
technological parameters are discussed. The problems
of using such compost in agriculture are referred to.
- composting; urban; economics; sludge; garbage;
fertilization; Sweden*
- 3410 Hovsenius, G.
Statens Naturvardsverk Fack, S-171 20 Solna,
Sweden
**Kompostering av hushallsavfall tillsammans med
slam. (Composting of household waste together with
sludge.)** AVFALL 76. Chap. K3. The work is part of
the documentation from the International Fair
"AVFALL 76" (WASTE 76) in Jonkoping, Sweden.
September 27-October 1, 1976. Sweden. 15p. Issued
1976. 8 figures 2 tables.
A review is made of the composition of household
waste. The preconditions for a good composting are
discussed. It is noted that the C/N ratio is too high in
household waste. By the addition of sludge from
purifying plants the ratio can be lowered to a suitable
value. The addition has to be of that size so that all the
sludge produced in the area where the household waste
is collected can be used. Other factors of importance
for good composting are water content, aeration,
transportation of CO₂, and the rate of fragmentation
of the material. The principles for fragmentation with
systems based on mills and on big drums are
described. Some results from the research concerning
composting of household waste and sludge that is
carried out at Laxa, Sweden, are given. Among other
things, a preliminary review is done of heavy metals
occurring in different types of waste. This content is
compared with that in farmyard manure. The main
parts of these metals come from material that could be
separated by magnetic means. The problem with
plastic waste is pointed out, but as yet there is not any
good separation method for plastic materials.
Different forms of composting are compared:
reactor-composting, some kinds of open composting,
and aeration methods. The placing of compost
material in rows of various sizes is found to give very
poor aeration. An artificial addition of oxygen is
therefore concluded to be necessary for obtaining an
efficient decomposition. (Original paper written in
Swedish.)
- composting; sludge; aeration; humidity; heavy metals*
- 3411 Jalal, K. F.
**A technological evaluation of composting for
community waste disposal in Asia.** Compost Science.
USA. Vol. 10. 20-25. Spring/Summer 1969. 3
figures. 29 references.
The various methods of low-cost waste disposal
that have been practiced in Asia are discussed and
criticized. A quantitative evaluation of the fertilizer
value of compost is presented, and specific recom-
mendations are made with regard to the method of
composting.
- disposal; agriculture; nutrients; reuse; composting;
rural; fertilization*
- 3412 Krogstad, O.
Gudding, R.
(Both) Dept. of Microbiology and Immunology
and Dept. of Food Hygiene, The Veterinary
College of Norway, Norway
**The survival of some pathogenic micro-organisms
during reactor composting.** Acta Agriculturae
Scandinavica 25, Sweden. 201-204. December 8, 1975.
16 references.
A report on microorganism survival after com-
posting of urban solid wastes mixed with septic and
dehydrated sludge is given. Previously inoculated
Salmonella typhimurium and *Serratia marcescens*
could not be detected in the waste after 3 days
composting at 60-65 °C. *Bacillus cereus* was
demonstrated in the compost after 7 days composting,
but when the temperature rose to 70 °C and was
maintained during the composting period, this
organism could not be detected in the compost.
- composting; pathogens; sludge; garbage; analysis*
- 3413 Peel, C.
**The public health and economic aspects of composting
nightsoil into municipal refuse in tropical Africa.**
Proceedings of the Conference on Planning for Water
and Waste in Hot Countries. Loughborough Univer-
sity of Technology. U.K. 25-36. September 1976. 1
diagram. 2 tables. 13 abbreviated references.
The value of composting night soil with refuse is
related to agricultural needs and public health in this
article. Details are given of a composting plant at
Kano, Nigeria, using the Indore composting system.
The maximum temperature in the windrow was 69 °C,
sufficient for destruction of pathogens.
- composting; refuse; excreta*
- 3414 Unakul, S.
Southeast Asia Research Organization, New
Delhi, India
Rural sanitation in China. Unpublished report. 26p.
February 3, 1975. 18 references.
This report describes rural health services in China
with emphasis given to organizational aspects. The
composting of animal and human waste for reuse in
agriculture is described. Digested night soil is mixed
with animal manure, rice straw, or grass and soil at

special composting sites. Details of composting pits are given

China; rural; disposal; composting; public health; agriculture

3415 Wilson, G. B.
Walker, J. M.
(Both) Agricultural Research Service, U.S.
Dept. of Agriculture, Washington, D.C.

Composting sewage sludge: how? Compost Science. USA. Vol. 14(5). 30-32. September / October 1973. 8 figures.

Preliminary full-scale tests indicate that sewage sludge can be windrow-composted if bulking materials such as woodchips or sawdust are added. Methods of compost operation are described. The authors conclude that the sludge can be composted outdoors in Maryland, despite some operational problems, mainly due to rainfall.

sludge; composting; USA; sewage; aeration

3416 Golueke, C. G.
Sanitary Engineering Research Laboratory
(SERL), University of California, Berkeley,
USA

Composting. Rodale Press, Book Division, Emmaus, PA. 18049. 4th printing. 1976. 2 tables. 1 figure. 62 references.

The process and principles of composting, one of the more ancient agricultural arts, are explained in this book. The progress of "scientific" composting, starting in the early 1900s from Sir Albert Howard and Van Vurn, is traced. The technology of composting, health aspects, use of the product, home composting, and trouble shooting in case your compost pile has problems are the main topics covered

composting; health

3.5 Aquatic weeds

3501 National Academy of Sciences, Washington,
D.C., USA

Making aquatic weeds useful: some perspectives for developing countries. Report of an ad hoc panel of the Advisory Committee on Technology Innovation, Board on Science and Technology for International Development, Commission on International Relations. USA. Chap. 13. 115-126. 1976. 9 figures. 14 references.

□ A state-of-the-art review of an aquatic weed-wastewater treatment system is given. Pilot-scale experiments conducted in developed countries show that these plants are capable of extracting large portions of organic and inorganic constituents from water and incorporating them into their own

structure, thus making them suitable for reuse as animal feed or soil conditioners. Miscellaneous uses of aquatic weeds in developing countries are reported, including fish harvesting and food production. The authors also discuss some public health limitations and research needs for improvement of this technique.

aquatic weeds; wastewater; developing countries; sewage treatment; nutrients; reuse; animal feed; soil conditioners; aquaculture; public health; human food

3502 Bagnall, L. O.
Furman, T. D. S.
Hentges, J. F., Jr
Nolan, W. J.
Shirley, R. L.

(All) Agricultural Engineering, University of
Florida, Gainesville, USA

Feed and fiber from effluent-grown water hyacinth. Environmental Protection Technology Series EPA-660 / 2-74-041. USA. 116-141. June 1974. 7 figures. 7 tables. 26 references.

A water hyacinth-covered pond with a detention time of over 10 h removes 10% of the nitrogen and phosphorus from secondary treated sewage effluent. Removal is increased to 80% and 60%, respectively, by increasing detention time to 5 days. Only 10% of the nutrients removed are found in the plant tissue. Cattle and sheep can readily eat processed water hyacinths in complete diets and remain in good health. Paper can be made from water hyacinths but production cost is uneconomically high. Compost may be the best use, having the highest value and lowest processing cost

detention time; nitrogen; phosphorus; aquatic weeds; animal feed; reuse

3503 Cornwell, D. A.
Zoltek, J., Jr
Patrinely, C. D
Furman, T. D. S.
Kim, J. I.

(All) Dept. of Environmental Engineering
Sciences, University of Florida, Gainesville,
USA

Nutrient removal by water hyacinths. Journal of the Water Pollution Control Federation. USA. Vol. 49(1). 57-65. January 1977. 4 tables. 5 figures. 15 references.

A field experiment was conducted in Florida on the use of water hyacinths (*Eichhornia crassipes*) to remove nutrients from secondary effluents. It was observed that water hyacinths can grow twice as fast in ponds containing secondary effluents as they do in natural conditions. About 80% total nitrogen and 40% total phosphorus removals are obtained with those ponds that have a depth of 0.34 m and a detention time of 48 h, whereas ponds with a greater depth and a lesser detention time do not provide satisfactory results. A direct correlation is found to

exist between the percentage nutrient removal and a loading parameter defined as surface area per unit flow.

sewage; effluents; nutrients; aquatic weeds; biological filters; USA

3504 Culley, D. D., Jr
Epps, E. A.
(Both) School of Forestry and Wildlife Management, Louisiana State University, Baton Rouge, USA

Use of duckweed for waste treatment and animal feed. Journal of Water Pollution Control Federation. USA Vol. 45(2). 337-347. February 1973. 5 tables. 1 figure. 28 references.

Aquatic plants provide good animal feed, are immune to certain pests, grow well in water containing organic wastes, and purify the water in which they grow. This report presents analyses of several aquatic plants and compares them to conventional animal feeds. Based on laboratory-scale experiments, yields of about 2 tonnes of duckweed (dry weight) per hectare per 3 weeks could be attained.

sewage treatment; pollution; animal feed; aquatic weeds

3505 DeJong, J.
Federal Commission for the IJsselmeerpolders, Netherlands

The purification of wastewater with the aid of rush or reed ponds. In Tourbier, J., and Pierson, R. W., Jr, eds., Biological Control of Water Pollution. USA. 133-139. 1976. 5 tables. 7 figures. 3 references.

A description of an actual project of sewage treatment utilizing aquatic weeds is given. On the basis of this work it is concluded that treatment of sewage with rush ponds is considerably cheaper than with activated sludge-type plants.

Netherlands; aquatic weeds; sewage treatment

3506 Koltypin, Y. A.
Central Research Station for Agricultural Utilization of Sewage, All Union Kostyakov Research Institute of Hydraulic Engineering and Land Development, USSR

Decontamination of sewage in paddy fields. Hygiene and Sanitation. USA. Vol. 34(7). 87-90. 1969. 2 tables.

An investigation of the decontamination of municipal sewage in biological ponds under the conditions of the Hissar Valley in the Tadzhik SSR, followed by additional processing and utilization in paddy fields, is reported. The settling ponds are reported to achieve the settling of up to 93% of the suspended solids and most of the helminth eggs. A high degree of decontamination is attested when the pond effluent is passed through paddy fields. Various

potential utilizations of paddy fields for the decontamination of other wastewaters are discussed. (Original paper written in Russian.)

wastewater; paddy fields; USSR; stabilization ponds; helminths; sewage treatment

3507 Miner, J. R.
Agricultural Engineering Dept., Iowa State University, Ames, Iowa, USA

Wooten, J. W.
Dodd, J. D.

(Both) Dept. of Botany and Plant Pathology, Iowa State University, Ames, Iowa, USA

Water hyacinths to further treat anaerobic lagoon effluent. In "Livestock Waste Management and Pollution Abatement." Proceedings of the International Symposium on Livestock Wastes, held in Columbus, Ohio, April 19-22, 1971. Published by the American Society of Agricultural Engineers, St. Joseph, Michigan. 170-173. 7 tables. 4 figures. 4 references.

A pilot experiment to evaluate the use of water hyacinths (*Eichhornia crassipes*) in a treatment system to transform anaerobic swine manure-lagoon effluent into water suitable for discharge to a surface water course is described. Four circular plastic swimming pools, 10 ft in diameter and 24 ft in depth (ca. 3 X 7 m) operated in series, are used as the treatment scheme utilizing water hyacinths. Results show that the effluent is free of colour and sufficiently lowered in organic matter and nutrients to allow discharge into the natural water courses. Reduction of nitrogen concentration by water hyacinths also allows more intense application of the effluent to cropland without danger of groundwater pollution by excess nitrogen.

organics; animal wastes; nutrients; aquatic weeds; sewage treatment

3508 Seidel, K.

Max Planck Institute, Krefeld, West Germany
Macrophytes and water purification. In Tourbier, J., and Pierson, R. W., Jr, eds., Biological Control of Water Pollution. USA. University of Pennsylvania Press. 109-121. 1976. 6 tables. 10 figures. 6 references.

■ This paper describes a long-term research program carried out in West Germany on treatment of wastewater utilizing aquatic weeds. Questions that the research have been oriented toward include: (a) Which types of plants could endure varying water conditions? (b) Could certain plants eliminate water contaminants? (c) Do plants have an influence on the condition of water, subsoil, and sludge? (d) Do plants themselves change when confronted with new/polluted environments? It was found from this extensive study that most plants could grow well or much better in fecal or domestic sewage than in uncontaminated water. Anatomical and physiological changes inside the plant bodies were also observed when they were confronted with toxic chemicals present in the

wastewater, e.g., formation of hydropods (water cells) on the epidermis and irregular arrangement of the stomata of *S. lacustris* when cultivated in water containing phenol solutions. The beneficial properties of aquatic weeds in elimination of inorganic and organic pollutants from wastewater are reported to be remarkable. Absorption capacities of heavy metals and other chemicals by various macrophytes have been investigated and results tabulated; the capacities are shown to increase from 4 to 40 times when a species (*S. lacustris*) is grown in sewage instead of a healthy nonpolluted lake. Another experiment involved testing a wide range of plants for their compatibility with phenol and cyanide. A few plants of the *Juncus* species and *Schoenoplectus* species, especially *S. lacustris*, were found to suit this purpose well as they could reduce from 10 to 100 mg/litre of phenol to nondetectable levels within the designated period. However, a lag phase in plant adaptation to high phenol concentrates was particularly evident during cold weather months. Further analysis demonstrates that, at least in *S. lacustris*, phenol is cleared by the plant itself and afterward metabolized to amino acids for production of protein and the plant biomass. Average percentage reduction of fecal indicator and pathogenic bacteria after 2 h contact with certain species of macrophytes was significantly high, i.e., 80-90%. The mode of organism inactivation is possibly by excretions from the plant roots. The pH of water is also affected by the action of certain plants as it is observed to be neutralized when passing through the plant roots. The use of aquatic weeds for the purification and reclamation of sludge from coastal areas and from sewage has been encouraging. The plant roots could turn the otherwise dead silt at the sea coast into genuine soil having an abundance of oxygen, which is vital for marine lives. Stabilization of sewage sludge could also be effectively accomplished when the plants (*Phragmites communis*) are grown in the sludge bed. About 80-90% dry matter sludge is obtained from the actions of the plant roots while clear water from the sludge is drained off easily. Reduction by excretions from plant roots of disease-causing organisms present in the sludge are reported to be significant. Guidelines for operation of the system utilizing aquatic weeds for wastewater treatment are described in detail. They include providing oxygen to the plants by either means of small water falls or by drainage pipes into the sludge beds. Harvesting of the plants should be carried out periodically and care must be taken not to damage the planting beds. Reuse of the plant stems as fodder has been found to be useful as they are rich in protein and minor elements. The plant stems can also be used as a compost material (with the resulting by-products of biogas and fertilizer) and as wicker, often in expensive furniture.

West Germany; aquatic weeds; sewage treatment; sludge; bacteria

3509

Wolverton, B. C.
McDonald, R. C.

(Both) National Space Technology Laboratories (NASA), Bay Saint Louis, Miss., USA
Don't waste waterweeds. New Scientist. U.K. 318-320. August 12, 1976. 3 figures. 3 tables.

A description of a NASA demonstration plant for the secondary treatment of sewage or excreta by water hyacinth plants is given. The plants very efficiently convert sewage nutrients into new plant material, which is then harvested and chopped up to produce either methane and a fertilizer residue or, after sun drying, a processed animal feed.

stabilization ponds; biogas; aquatic weeds; excreta; sewage; animal feed

3510

Wolverton, B. C.
McDonald, R. C.

(Both) National Space Technology Laboratories (NASA), Bay Saint Louis, Miss., USA

Water hyacinths for upgrading sewage lagoons to meet advanced wastewater treatment standards, Part I. Report No. TM-X-72729. U.S. National Aeronautics and Space Administration. 9p. October 1975.

Water hyacinths (*Eichhornia crassipes*) have been found to function well as an efficient and inexpensive final filtration system in a secondary domestic sewage lagoon during a 3-month test period. These plants reduced the suspended solids, biochemical oxygen demand substances, and other chemical parameters to levels below the standards set by EPA. The desired quality of final sewage effluent can be controlled by the water hyacinth surface area, harvesting rates, and the detention time of sewage in the lagoons.

filtration; stabilization ponds; chemical characteristics; sewage treatment; aquatic weeds; solids; BOD

3511

Wolverton, B. C.
McDonald, R. C.

(Both) National Space Technology Laboratories (NASA), Bay Saint Louis, Miss., USA

Water hyacinths for upgrading sewage lagoons to meet advanced wastewater treatment standards, Part II. Report No. TM-X-72730. U.S. National Aeronautics and Space Administration. 22p. October 1976.

Field experiments using water hyacinths as biological filtration agents have been conducted by NASA in the Mississippi Gulf Coast Region. The plants were installed in one single cell and one multiple cell sewage lagoon systems. Water hyacinths have demonstrated the ability to maintain both BOD₅ and suspended solids levels within the EPA prescribed limits of 30 mg/litre. Excellent year-round results were obtained with a multiple-cell sewage lagoon system consisting of two aerated and one water-hyacinth covered cell connected in a series.

USA; sewage treatment; stabilization ponds; BOD; aquatic weeds; solids

- 3512 Wolverson, B. C.
McDonald, R. C.
(Both) National Space Technology Laboratories
(NASA), Bay Saint Louis, Miss., USA

Water hyacinths (*Eichhornia crassipes*) for removing chemical and photographic pollutants from laboratory wastewaters. Report No. TM-X-72731. U.S. National Aeronautics and Space Administration. 10p. October 1976.

Experiments have been conducted by NASA to investigate the ability of water hyacinths (*Eichhornia crassipes*) to act as a biological filtration agent to remove toxic heavy metals and organic compounds from laboratory waste discharges. Water hyacinths were installed in a specially designed zig-zag lagoon into which the laboratory wastes were diverted. Results of a 1-year study showed that the water hyacinths were efficient at removing heavy metals as well as many organic substances. Heavy metals were most concentrated in the plant roots, but were also detected in the stems and leaves. Means of utilizing harvested plants are discussed.

sewage treatment; heavy metals; organics; aquatic weeds; bioaccumulation; stabilization ponds

- 3513 Wolverson, B. C.
McDonald, R. C.
Gordon, J.

(All) National Space Technology Laboratories
(NASA), Bay Saint Louis, Miss., USA
Bio-conversion of water hyacinths into methane gas, part I. Report No. TM-X-72725. U.S. National Aeronautics and Space Administration. 13p. July 1975.

■ Biogas production from the anaerobic decomposition of water hyacinths (*Eichhornia crassipes*) has been investigated by NASA. The experiments demonstrated the ability of water hyacinths to produce an average of 13.9 ml of methane gas per gram of plant wet weight. Pollution of water hyacinths by nickel and cadmium almost doubled the rate of methane production as compared to the noncontaminated plants incubated at the same temperature (36 °C). The methane content of biogas evolved from the anaerobic decomposition of Ni-Cd-contaminated plants was 91% as compared to 69.2% methane content of biogas collected from the fermentation of noncontaminated plants.

biogas; nickel; cadmium; anaerobic digestion; aquatic weeds

4. Reuse

4.1 Irrigation

- 4101 Aquirre, J.
Centro de Investigacion y Entrenamiento para el
Control de la Calidad de Agua, Mexico
Reutilizacion de aguas residuales para propositos agricolas e industriales. (Wastewater reuse for

agriculture and industry.) Secretaria de Recursos Hidraulicos. Mexico. 16p. October 1974. 6 tables.

Urban and industrial development in Mexico has not taken place in those areas where water is abundant; therefore, reuse of water has become a first priority in the development of new hydric resources. Agriculture demands 90% of the recycled water. The report analyses the possible effects on human metabolism of the crops that have been irrigated with wastewaters and provides standards for water quality. (Original paper written in Spanish.)

Mexico; bacteria; barium; domestic; industrial reuse; salts; irrigation; soils; wastewater reuse; water quality

- 4102 Amirov, R. O.
Salamov, D. A.

(Both) Department of Hygiene, Aliev Azerbaidzhan Graduate Medical Institute, Baku, USSR
Sanitary-helminthological evaluation of sewage farms under climatic conditions of the Apsheron Peninsula. Hygiene and Sanitation. USA. (Gigienai Sanitariia. USSR.) Vol. 32(6). 437-439. 1967.

Domestic sewage from Baku district, USSR, has been utilized in irrigated agriculture in conditions of the Apsheron Peninsula, which are sandy and sandy-loamy soils, having a hot climate in the summer. The results show that vegetables grown on soil irrigated by flooding with sewage are contaminated with helminth eggs. However, in the case of furrow irrigation the vegetables carry no viable helminth eggs. The contamination of vegetables is lower in summer and higher in autumn and winter. The authors recommend that irrigation should be limited only to food plants that undergo thermal processing before being eaten and only by furrow irrigation.

USSR; domestic; sewage; tropics; vegetables; irrigation; helminths

- 4103 Central Public Health Engineering Research
Institute, Nagpur, India

Sewage farming — a course manual. A course given by Central Public Health Engineering Research Institute. India. November 1973. 10 chapters. 19 tables. 2 figures.

This is a manual for a 2½-day course given for 3 years to compost development officers, public health engineers, farm superintendents, etc. It provides an introduction to scientific farming and describes Indian practice. Important sections in the manual include descriptions of factors affecting plant life, sewage as an irrigant, principles of farm management, problems of salinity and alkalinity, sewage farming in India, public health aspects of sewage farming, and desirable management practices. A final chapter gives a simple design for a sewage farm in Nagpur.

sewage; effluent reuse; public health; irrigation; India

4104

Committee on Natural Resources, Planning Commission, Government of India, India

Utilization of urban wastes. Unpublished report. 26p. August 1963. An appendix of 4 tables.

Sewage/sullage from most cities in India is disposed of by irrigation on the land with or without treatment, and discharge into the nearest river or stream either throughout the year where no sewage irrigation farms exist or at least for some part of the year where there are sewage farms. The government is encouraging further uses of sewage in irrigation and has laid out several plans in the coming years. Selected towns in India that are utilizing sewage/sullage for irrigation are included.

sewage; sullage; India; irrigation

4105

Instituto Nacional de Planificación (INP), Banco Interamericano de Desarrollo (BID), and Universidad Nacional de Ingeniería, Lima, Peru
Proyecto de inversión ... uso de aguas servidas de Lima para riego documento de trabajo. (Investment project ... utilization of Lima's wastewaters for land irrigation.) Programa de Capacitación en Preparación y Evaluación de Proyectos de Inversión. Peru. 394p. May 1974. 59 tables. 11 graphs. 9 annexes. 3 maps.

Two alternatives are presented for the treatment of Lima's wastewaters: stabilization ponds and biological filters. Both are designed to reduce the sea pollution from the dumping of wastes into the Pacific Ocean. Economic analysis favours the second choice since there exists the potential for recovering through irrigation 6900 hectares in the vicinity of the city. An additional benefit derived from the biological treatment is the reduction in nitrogenated fertilizer that would be needed to upgrade the lands. (Original document written in Spanish.)

Peru; biological filters; economics; groundwater; irrigation; ocean disposal; wastewater reuse

4106

Water Quality Control Branch, Robert S. Kerr Environmental Research Center, Ada, Oklahoma, USA

Land application of sewage effluents and sludge ... selected abstracts. U.S. Environmental Protection Agency, Technology Series. USA. Report No. EPA-660/2-74-042. 248p. June 1974.

This report includes 568 selected annotated abstracts that have been compiled as part of several EPA contracts on land application of sewage effluents and sludge. The literature, which dates from 1930 to 1973, contains various topics of waste disposal on land such as: land reclamation, aquaculture and agricultural reuses, public health aspects, and groundwater recharge.

sludge, disposal; reuse; sewage treatment; irrigation;

groundwater; recharge; public health; agriculture; economics

4107

World Health Organization, Geneva, Switzerland

Aprovechamiento de efluentes: métodos y medidas de protección sanitaria en el tratamiento de aguas servidas. (Reuse of effluents: methods of wastewater treatment and health safeguards.) Report of a World Health Organization meeting of experts. Technical report series no. 517. Switzerland. 63p. 1973. 2 volumes. 5 tables. 4 figures. 60 references. 2 annexes.

The state of the art in wastewater treatment technologies is registered in the report as well as the risks involved in the reuse of effluents for agricultural, industrial, recreational, and domestic purposes. Quality and supervision criteria for recycled waters are set forth. The paper is complemented with an extensive bibliography on the subject and with the results of a survey on wastewater reuse in 30 countries throughout the world.

wastewater; agriculture; effluents; industrial reuse; public health; viruses

4108

Applegate, C. H.
Gray, D. V.

(Both) Environmental Health Division, General Electric Company, St. Petersburg, Fla., USA

Land spreading effluent from a secondary facility. Water and Sewage Works Journal. USA. 122(7). 85-87. July 1975. 1 table. 2 figures.

The system described in this article is used for treatment of combined sewage and industrial wastewaters. It comprises an extended aeration-activated sludge treatment of sewage and pH adjustment of the industrial wastes; the combined effluents are directed to an aerated lake. They are then sprayed over a 10-acre (ca. 4 hectares) field containing a network of subsurface drainage pipes. The percolated effluent is pumped to a secondary retention lake before discharging to a saltwater bayou. Data are presented showing both the efficiency of the system in pollutant removal and the quality of the effluent as compared to the Florida state standards, USA. Some considerations for reuse of the secondary lake water are discussed.

industrial wastewater; sewage treatment; percolation; USA

4109

Babov, D. M.
Nadvornyi, N. N.
Keimakh, A. S.

(All) Department of Hygiene, Odessa Medical Institute, USSR

The microflora of vegetables and other crops grown on sewage farms. Hygiene and Sanitation. USA. Vol. 32(8). 273-275. 1967. 1 reference.

A study of bacterial contamination of crops grown on sewage farms is reported. Although irrigation with sewage may result in the contamination of vegetables and other crops by enteric bacteria, under the conditions of the southern Ukraine and USSR, pathogenic microorganisms are rarely detected 2 weeks after the cessation of irrigation because of the imitiation of active self-purification processes. (Original paper written in Russian.)

bacterial contamination; sewage; agriculture; USSR; irrigation; pathogens

4110

Bajaj, K. L.
Singh, J.
Verma, A. K.
Bhatia, I. S.

(All) Dept. of Chemistry and Biochemistry,
Punjab Agricultural University, Ludhiana,
India

Evaluation of the sewage water of the Punjab State for irrigation. Journal of Research, India. Vol. 11(1). 80-83. 1974. 2 tables. 14 references.

Sewage water from different cities of the Punjab State, India, has been analyzed for its suitability for irrigation. Based on the conductivity and sodium adsorption ratio (SAR) values, four types of sewage water are classified ranging from low-salinity water to very high-salinity water. The sewage waters are found to contain considerable amounts of nutrients such as N, P, and K.

sewage; India; sodium absorption ratio; nutrients; salts; irrigation

4111

Baubinas, A. K.
Nauchno-Issledovatelsku Institut Epidemiologii
Mikrobiologu i Gigeny, Vilnius, USSR

Bacterial contamination of perennial grasses in overhead irrigation with sewage. Gigena i Sanitariya. USSR. 97-99. 1975.

The bacterial contamination of perennial grasses by *E. coli* enterococci and pathogenic organisms during and after overhead irrigation with sewage at sewage farms in USSR has been studied. The bacteria in the sewage during overhead irrigation can be carried far by air currents, leading to massive contamination of the grass. The microorganisms on the plants exposed to direct solar rays generally die-off within 1 week. Grazing of cattle 14 days after irrigation is reported to be safe. (Original paper written in Russian.)

bacterial contamination; USSR; Escherichia coli; enterococci; pathogens; irrigation; sewage; agriculture

4112

Bell, R. G.
Agriculture Canada, Canada

Persistence of fecal coliform indicator bacteria on alfalfa irrigated with municipal sewage lagoon effluent. Journal of Environmental Quality. USA. Vol. 5(1). 39-42. January-March 1976. 3 tables.

Fecal coliforms on alfalfa plants irrigated with sewage lagoon effluent are completely destroyed by exposure to 10 h of bright sunlight. No decrease is observed in the absence of bright sunlight under cool, damp, overcast conditions. The author concludes that it requires at least 2 sunny days between cessation of effluent irrigation and consumption of forage to adequately protect the livestock.

bacteria; effluents; irrigation; animal feed

4113

Bishnoi, O. P.
Dilution of sewage for irrigation. Journal of the Institution of Engineers. India. Vol. 47. PH1. 11-17. October 1966. 4 tables. 2 references.

Domestic sewage can be profitably used for irrigation of land to increase food supply. From the point of view of manurial content, sewage can be diluted to provide the same percentage of nutrients as would be obtained from the required dose of chemical fertilizer for a given crop. However, the dilution for different crops needs to be worked out. Some problems that may be involved in sewage utilization for agricultural purposes are discussed.

irrigation; sewage; fertilization; nutrients

4114

Bouwer, H.
Lance, J. C.
Riggs, M. S.
U.S. Water Conservation Laboratory, Phoenix,
Arizona, USA

High rate land treatment II. Water quality and economic aspects of the Flushing Meadows Project. Journal of the Water Pollution Control Federation. Vol. 46(5). 844-859. May 1974. 9 figures. 3 tables. 15 references.

A report of a 5-year experimental work project on renovating secondary sewage effluent by groundwater recharge with rapid infiltration basins in the sandy and gravelly materials of the Salt River bed in Arizona is given. The filtration of the secondary effluent through the sands and gravels resulted in essentially complete removal of suspended solids and BOD. Most fecal bacteria were removed in the first 2 ft (0.6 m) of the soil and none were encountered after 300 ft (91 m) of horizontal travel of the renovated water. Other characteristics of the renovated water analyzed were found to be within the ranges suitable for unrestricted irrigation and recreation. The cost of this renovation system has been estimated at about U.S. \$4.3/1000 m³. This is reported to be much less than the cost of equivalent inplant tertiary treatment to produce renovated water of similar quality.

USA; effluents; renovation; groundwater; recharge; rapid infiltration; bacteria; irrigation; costs

- 4115 Bouwer, H.
Rice R. C.
Escarcega, E. D.
(All) U.S. Water Conservation Laboratory,
Phoenix, Arizona, USA

High-rate land treatment I. Infiltration and hydraulic aspects of the Flushing Meadows Project. Journal of the Water Pollution Control Federation. USA. Vol. 46(5). 834-843. May 1974. 5 figures. 5 tables. 11 references.

An experimental project for renovating secondary sewage effluent by groundwater recharge with infiltration basins located in Phoenix, Arizona is described. One acre (0.4047 ha) of basin area is found to be capable of receiving 1350 m³ / day of effluent. A mature stand of grass can receive higher infiltration rates than bare soil. The hydraulic conductivity of the aquifer is not measurably affected by the effluent recharge.

renovation; effluents; recharge; groundwater; infiltration; USA

- 4116 Bruvold, W. H.
Ward, P. C.
(Both) School of Public Health, University of California, Berkeley, Calif., USA

Using reclaimed wastewater — public opinion. Journal of Water Pollution Control Federation. USA. Vol. 44(9). 1690-1696. September 1972. 4 tables. 10 references.

A survey in 10 cities in California of public opinion on the use of reclaimed wastewater is reported. Although the results do not indicate major opposition to such reuse, the authors suggest a way to foster more public acceptance by starting with uses of least opposition, such as lawn irrigation, and then moving upward step by step, as acceptability increases and as reclamation techniques improve.

USA; public opinion; reclamation; wastewater; irrigation; reuse

- 4117 Crites, R. W.
Pound, C. E.
Land treatment of municipal wastewater. Environmental Science and Technology. USA. Vol. 10(6). 548-551. June 1976. 2 photos. 2 tables.

A description of slow rate, rapid infiltration, and overland-flow land-disposal systems for municipal wastewater is given. Soil treatment mechanisms are explained. Examples of the different disposal systems in communities in the USA and Australia are included.

sewage; recharge; percolation; USA; Australia

- 4118 Day, A. D.
Taher, F. A.
Katterman, F. R.
(All) University of Arizona, Arizona, USA

Influence of treated municipal wastewater on growth fiber, acid-soluble nucleotides, protein and amino acid content in wheat grain. Journal of Environmental Quality. USA. Vol. 4(2). 167-169. April-June 1975. 2 tables.

The effects of treated municipal sewage on growth fiber, acid-soluble nucleotides, protein, and amino acid content in grain from wheat are examined. The authors conclude that the treated municipal sewage can be an effective source of irrigation water and plant nutrients for the production of good quality grain grown in sandy loam soil.

sewage; irrigation; land disposal; nutrients; agriculture

- 4119 Dowdy, R. H.
Larson, W. E.
(Both) APS and University of Minnesota, USA

The availability of sludge-borne metals to various vegetable crops. Journal of Environmental Quality. USA. Vol. 4(2). 278-282. April-June 1975. 1 figure. 5 tables. 29 references.

The extent to which sludge-borne metals accumulate in the edible tissue of seven vegetable crops grown on a sludge-amended sandy soil is determined under field conditions. Generally, metal contents of vegetable tissue are higher than those of the fruiting, root, and tuber tissue. Soil with an application of 450 ton / ha sludge does not provide an increase of metal accumulations in crop tissues of more than two- or threefold. Lettuce is an accumulator, but potatoes and carrots are excellent non-accumulators of metals.

sewage; heavy metals; sludge; bioaccumulation; vegetables

- 4120 Dugan, G. L.
Young, R. H. F.
Lau, L. S.
Ekern, P. C.
Loh, P. C. S.
(All) Dept. of Civil Engineering, University of Hawaii, Honolulu, USA

Land disposal of wastewater in Hawaii. Journal of Water Pollution Control Federation. USA. Vol. 47(8). 2067-2087. August 1975. 7 tables. 4 figures. 11 references.

A feasibility study of applying secondary treated wastewater effluent to selected irrigation pond areas in the State of Hawaii is reported. Both pilot and field experiments have been carried out and favourable results were obtained with respect to nutrients, solids, and salts removal. Another extensive study also reveals that the test soils are highly effective in adsorbing viruses from the applied effluent. The

authors discuss some management measures in irrigation systems that are essential to achieve the goal of wastewater utilization.

effluents; land disposal; irrigation; nutrients; solids; reuse; salts; viruses; management; USA

4121 Dunlop, S. G.
Department of Microbiology, University of Colorado Medical Center, Boulder, USA

Survival of pathogens and related disease hazards. In Wilson, C. W., and Beckett, F. E., eds., Proceedings of Municipal Sewage Effluent for Irrigation, Louisiana Polytechnic Institute Symposium, the Louisiana Polytech Department of Agricultural Engineering. USA. 107-121. July 30, 1968. 1 table. 62 references.

This is a survey of health hazards that may result from irrigation with reclaimed municipal wastewater. No disease outbreak has been traced to irrigation with properly treated and disinfected sewage, but many epidemics have been caused by irrigation with improperly treated wastes. Survival times of various pathogenic organisms in soils, plants, and waters are tabulated and discussed.

health; irrigation; effluents; sewage; pathogens; bacterial die-off

4122 Fedotov, V. E.
Gorkopenko, F. G.
Ispolzovaiye stochnykh vod dlya orosheniya. (Use of sewage for irrigation.) NWWA Translation from Gidrotekhnika i Melioratsya. Transcript No. 9. 1, 4-6. September 1972.

The experiences of a collective farm with irrigation by means of sewage from a community located in a dry area in the USSR are given. Yields of crops irrigated with sewage have been found to be higher than the yields of those irrigated with usual irrigation water (river water). Irrigation of treated wastewater from a series of settling ponds is found to be better than those with the untreated sewage, since the materials in the untreated sewage clogged the soil causing rotting of the crops in the fields. An addition of industrial wastewater to sewage is found to adversely affect crop yield. (Original paper written in Russian.)

irrigation; USSR; sewage; crops; stabilization ponds; industrial wastewater

4123 Feinmesser, A.
Water Commission, Israel
Survey of sewage utilization for agricultural purposes in Israel. Advances in Water Pollution Research. Proceedings of the 5th International Water Pollution Research Conference. Pergamon Press. U.K. Vol. 1. I-33 / 1-7. 1971. 4 tables.

A summary of sewage treatment and effluent reuse

practices in Israel is given. The most common form of sewage treatment is waste stabilization ponds (anaerobic and facultative). Approximately one-third of all treated urban sewage is reused, principally for irrigation of crops (63%) and fruit trees (30%) and in fish culture (7%).

sewage; Israel; agriculture; irrigation; stabilization ponds

4124 Fogg, C. E.
Soil Conservation Service, U.S. Department of Agriculture, Washington, D.C., USA

Land application of sewage effluents. Proceedings of the 28th Symposium of the Soil Conservation Society of America. 148-152. 1973. 4 tables.

Spray irrigation is reported to be a satisfactory method for final treatment of sewage effluents. This paper describes some typical characteristics of sewage effluents and a guide to renovative capacity of soils recommended for spray irrigation, overland runoff, and rapid infiltration systems. A list of representative amounts per acre of nitrogen, phosphorus, potassium, magnesium, and sulfur that may be used by various crops each year is also included.

sewage effluents; spray irrigation; overland flow; rapid infiltration; nitrogen; phosphorus; potassium; magnesium; sulfur; crops

4125 Furr, A.
Stoewsand, G. S.
Bache, C. A.
Lisk, D. J.
(All) Virginia Polytechnic Institute, Virginia, USA

Study of guinea pigs fed Swiss chard grown on municipal sludge-amended soil. Archives Environmental Health. USA. Vol. 31(2). 87-91. March-April 1976. 3 tables.

The effects on guinea pigs of ingestion of Swiss chard field-grown on soil amended with 100 dry ton / acre of municipal sewage sludge from Washington, D.C., are examined. Elevated concentrations of several elements found in the Swiss chard also appear at higher levels in certain animal tissues. The elements include antimony in adrenal, cadmium in kidney, manganese in liver tissues, and tin in several tissues. The animals show no observable toxicological effects.

heavy metals; sewage; sludge; animal feed; toxic substances; vegetables

4126 Gagnon, J. D.
Environment Canada, Quebec 10, Canada
Environmental aspects of sewage-derived fertilizers. U.S. Forest Service Technical Report No. NE3. USA. 101-107. 1973. 1 table. 1 figure. 10 references.

A 4-year study on the application of digested sludge as fertilizer on a 10-year-old white spruce

plantation established on sandy soil is reported. There is a 30% increase in height-growth response as compared to the control trees having no sludge addition. Environmental hazards resulting from this application are reported to be minimal.

sludge; growth kinetics; fertilization; forest agriculture; environmental hazards

4127 Gerba, C. P.
Wallis, C.
Melnick, J. L.

(All) Baylor College, Houston, Tex., USA

Fate of wastewater bacteria and viruses in soil. Journal Irrigation and Drainage Division, American Society of Civil Engineers. USA. Vol. 101(3). 157-174. September 1975. 5 tables. 63 references.

Bacterial survival in soil is affected by moisture content, temperature, organic matter, and antagonism by soil microflora. In most instances survival of pathogens is less than 2-3 months. Removal of bacteria from sewage during percolation through soil is accomplished largely at the soil surface by straining, sedimentation, and adsorption. The fate of wastewater bacteria and viruses in soil is reviewed.

bacteria; viruses; soils; pathogens; percolation; bacterial removal; sedimentation; adsorption

4128 Gilbert, R. G.
Rice, R. C.
Bouwer, H.
Gerba, C. P.
Wallis, C.
Melnick, J. L.

(All) U.S. Drug Administration, Arizona, USA

Wastewater renovation and reuse ... virus removal by soil filtration. Science. USA. Vol. 192(4243). 1004-1005. 4 June 1976. 1 table.

Secondary sewage effluent and renovated water from four wells in operation since 1967 were tested about every 2 months in 1974 for viruses during flooding periods. Viruses were not detected in any renovated water samples. Human viral pathogens did not move through soil into groundwater, but were apparently absorbed and degraded by the soil.

viruses; sewage; recharge; wastewater; reuse

4129 Giordano, P. M.
Mortvedt, J. J.
Mays, D. A.

(All) Tennessee Valley Authority (TVA), USA

Effect of municipal wastes on crop yields and uptake of heavy metals. Journal of Environmental Quality. USA. Vol. 4(3). 394-399. July-September 1975. 7 tables.

Crop uptake of several heavy metals contained in garbage compost and sewage sludge applied at relatively high rates is determined. Application of

rather high rates of garbage compost and sewage sludge results in increased yields of corn, although tissue concentrations of several heavy metals are higher. In contrast, lower yields of beans are obtained with this same application, possibly due to the greater sensitivity of beans to high rates of available zinc.

crops; heavy metals; composting; sludge; bioaccumulation

4130 Goldberg, S. D.
Irrigation Department, The Hebrew University of Jerusalem, Israel

New techniques in the reuse of effluents. A report prepared for the World Bank, Washington, D.C., USA. 7p. November 1976. 2 tables. 5 references.

■ An experiment is described in which raw sewage was used to irrigate cucumbers and eggplants. These crops were selected as being most vulnerable to contamination by the sewage. Drip irrigation of sewage was practiced by: laying the drip irrigation pipes on the ground; covering the ground with plastic and burying the edges; fumigating the soil under the plastic; and punching holes in the plastic through which the vegetables were planted. This method was compared to cultivation of the cucumbers with drip irrigation but without any plastic cover protection. It was shown that both methods using drip irrigation exhibited lower bacteriological contamination than similar cucumbers purchased on the open market that had been grown using conventional irrigation techniques. In a second phase of experimentation, an "artificial epidemic" was created in which mutated bacteria and Sabin's weak poliomyelitis-type viruses were introduced into the sewage irrigation waters in very high concentrations. It was concluded that, with high levels of significance, the protected treatment (with plastic and fumigation) yielded a safe crop of cucumbers in contrast to highly contaminated cucumbers from nonprotected treatment.

sewage effluents; vegetables; drip irrigation; disinfection

4131 Hinesly, T. D.
U.S. Corps of Engineers, Washington, D.C., USA

Water renovation for unrestricted re-use. Water Spectrum. USA. Vol. 5(2), 1-8. 1973. 10 photos. 1 chart.

The author states that a wastewater recycling through spray irrigation has the greatest applicability to different soil types and cultural practices of all methods of wastewater treatment. The physical, chemical, and biological actions that take place during land treatment processes are described, giving communities a scientific basis for determining which choice is best. Through effective management practices, erosion and health hazards will not be a serious problem.

spray irrigation; wastewater reuse; health

Israel; oxidation ponds; effluents; viruses; agriculture; chlorination; solar

- 4132 Katzenelson, E.
Telch, B.
(Both) The Hebrew University of Jerusalem,
Israel

Dispersion of enteric bacteria by spray irrigation. Journal of Water Pollution Control Federation. USA. Vol. 48(4). 710-716. April 1976. 2 figures. 4 tables. 21 references.

Data were obtained about the number and types of enteric bacteria dispersed into the air during spray irrigation with sewage in two communities in Israel. Coliform bacteria were found in the air at 350 m downwind from the irrigation line. In one case, a *Salmonella* bacterium was isolated 60 m from the irrigation source.

Salmonella; Israel; spray irrigation; sewage; coliform bacteria

- 4133 Kotia, R. R.
Compost Development Office, Krishibhuvan,
Paldi, Ahmedabad, India

Sewage farming in Gujarat. Report on the Seminar on Sewage Treatment and Disposal for Small Communities. India. Paper No. 15. 7p. 13-14 March 1971. 3 tables in Appendix.

This is a review of sewage farming in Gujarat State in India. Sewage distribution and farm management are discussed, and problems in sewage farming are outlined and solutions recommended. Sewage dosage rates used at different locations are given in a table and application rates for different soil types are suggested in another table.

sewage; agriculture; irrigation; India

- 4134 Kott, H.
Fishelson, L.
(Both) Dept. of Food Engineering and Biotechnology, Technion-Israel Institute of Technology, Haifa, Israel

Survival of enteroviruses on vegetables irrigated with chlorinated oxidation pond effluents. Israel Journal of Technology. Israel. Vol. 12(5-6). 290-297. 1974. 5 figures. 3 tables. 19 references.

An investigation conducted in Israel on the survival of poliovirus 1 LSC on the surface of vegetables contaminated by virus-infected and chlorinated oxidation pond effluents is reported. A factor is found in oxidation pond effluents that, affected by solar radiation (over a minimum of 0.35 cal/cm² per minute), accelerates the rate of inactivation of viruses on the vegetable surface. The maximum percentage of viruses remaining is observed to be 1.63% when exposed to sunlight for 6 h as compared to 8.45% when the vegetables are kept in darkness.

- 4135 Kott, Y.
Environmental Engineering Laboratory, Technion-Israel Institute of Technology, Haifa, Israel

Hazards associated with the use of chlorinated oxidation pond effluents for irrigation. Water Research. U.K. Vol. 7(6). 853-862. June 1973. 7 tables. 17 references.

A possibility of overcoming the health hazards that may arise due to irrigation with oxidation pond effluents in Israel has been investigated. The use of chlorine is found to be practical because algal cells in the pond effluent do not exert chlorine demand during a 2-h contact time. For maximum safety, the author suggests an application of 15 mg/litre chlorine dose for a 2-h contact.

Israel; irrigation; oxidation ponds; chlorine; public health; effluents; algae; contact time

- 4136 Krishnamoorthi, K. P.
Abdulappa, M. K.
Anwikar, A. K.

(All) Central Public Health Engineering Research Institute, Nagpur, India

Intestinal parasitic infections associated with sewage farm workers with special reference to helminths and protozoa. Proceedings of Symposium on Environmental Pollution. Central Public Health Engineering Research Institute. India. 347-355. 17-19 January 1973. 9 tables. 3 references.

This is a report on the findings of stool examinations of workers at five large sewage farms at Jaipur, Madras, Hyderabad, Trivandrum, and Poona in India. Four hundred and sixty-six samples from sewage farm workers were compared with 432 samples from a control population for the presence of *Ancylostoma duodenale* (hookworm), *Ascaris lumbricoides* (roundworm), *Trichuris trichura* (whipworm), *Enterobius vermicularis* (pinworm), *Hymenolepis nana* (dwarf tapeworm), *Entamoeba histolytica*, and *Giardia intestinalis*. The incidence and multiplicity of infection was found to be much greater in sewage farm workers.

sewage; parasites; India; pathogens; public health; agriculture; night-soil disposal

- 4137 Kutera, K.
Treatment and disposal of wastewaters of settlements in rural, agricultural, non-urban areas. 7th Conference on Water Pollution Research. Paris, France. 12p. 13 September 1974. 8 figures. 16 references in Polish.

This article describes a year-round system for spreading and/or irrigation of household wastewaters from small rural communities. It discusses ice formation, winter irrigation, as well as types and kinds

of soils.

rural; irrigation; sewage

4138

Larkin, E. P.
Tierney, J. T.
Sullivan, R.

(All) Virology Branch, Division of Microbiology, Bureau of Foods, Cincinnati, Ohio, USA.
Persistence of virus on sewage-irrigated vegetables. Journal of the Environmental Engineering Division, American Society of Civil Engineers. USA. Vol. 102(EE1). Proceeding paper 11935. 29-35. February 1976. 3 tables. 23 references.

A number of municipalities are contemplating land disposal of sewage effluents. However, the present treatment systems do not completely remove viruses from such wastes. A pilot-scale spray-irrigation project of vegetables irrigated with virus-inoculated sewage sludge and effluent has demonstrated that poliovirus 1 persists on vegetable surfaces for as long as 36 days, indicating potential contamination of vegetables when spray-irrigation systems are used.

diseases; spray irrigation; sludge; vegetables; viruses; land disposal

4139

Law, J. P.
Water Quality Control Research Program,
Robert S. Kerr Water Research Centre, Ada,
Oklahoma, USA

Agricultural utilization of sewage effluent and sludge ... an annotated bibliography. Federal Water Pollution Control Administration, U.S. Dept. of the Interior. USA. Paper No. CWR-2. 89p. January 1968.

This report brings together about 300 annotated references on agricultural reuses of sewage effluents and sludge that have been in practice in Europe and the USA. Such uses aid crop production, but also make use of water that would have been wasted and decrease the pollutant load on the receiving streams. A chapter on public health aspects of wastewater utilization is included.

reuse; agriculture; sewage effluents; pollution; public health; sludge; nutrients; irrigation

4140

McGarry, M. G.
Asian Institute of Technology, Bangkok, Thailand

Sewage as a natural resource ... economic disposal of domestic wastewaters. Proceedings of a Symposium on the Role of the Engineer in Environmental Pollution Control. Malaysia. 4p. March 1972. 4 figures. 6 references.

Traditional collection and reuse of night soil in agriculture and fishponds are discussed. The author points out the economic value of night soil and proposes a schematic treatment system that includes pasteurization and algae growth ponds to destroy the

pathogenic organisms and maximize those productions, respectively.

night-soil collection; agriculture; reuse; aquaculture; pasteurization; pathogens; high-rate ponds

4141

Novoderzhkina, Y. G.
Kigel, T. V.
Makarenko, E. V.

(All) Rostov-Na-Donu Gosudarstvenni Meditsinskii Institut, USSR
Harmlessness of grain grown on sewage farms. Voprosy pitania. USSR. Vol. 2. 86-88. 1974.

Experiments have been conducted for 1½ years on rats and rabbits to study the effect of wheat grain grown on sewage farms irrigated with conditionally pure sewage containing Ca, Mg, Na, K, sulfates, chlorides, toluene, petroleum products, caprolactum, and formaldehyde from a chemical plant. The general health of the animals, condition of hair, motor activity, change of body weight and relative weight of organs, rectal temperature, enzyme spectrum of the blood and liver tissue, protein and carbohydrate metabolism, and pigment-producing function of the liver were determined. Feeding grains grown on sewage farms apparently does not cause any changes in the laboratory animals. (Copyright 1975, Biological Abstracts no. 24 / 5 / 0000001-0000200.) (Original paper written in Russian.)

sewage; health; animal feed; agriculture

4142

Parker, C. O.
Water Science Laboratories, Victoria, Australia
Low cost methods of wastewater treatment. Water Quality, Management and Pollution Control Problems, Pergamon Press, Oxford, U.K. 141-148. 1973. 17 references.

Irrigation of raw sewage as a method of treatment is described and some details of the 11 000-ha irrigation area at Melbourne are given. The loading of waste stabilization ponds is discussed. Aeration lagoons and (Pasveer) oxidation ditches are discussed.

sewage treatment; oxidation ditches; irrigation; stabilization ponds; aerated lagoons

4143

Pescod, M. B.
Okun, D. A.
Water supply and wastewater disposal in developing countries. Proceedings of a Water Supply and Sanitation Seminar held in Bangkok, Asian Institute of Technology. Thailand. 309p. January 1971. 39 papers. Summary. List of participants.

This is a collection of papers on the water supply and sanitation situation in Asia, planning of water projects, water resources development, water quality management, wastewater management, system operation and management, and new developments. Papers on wastewater solids utilization and disposal

and on water reclamation and protein production through sewage treatment present data on studies carried out in Thailand.

water supply; sanitation; developing countries; reuse; sewage; protein

4144 Reed, S. C.
Buzzell, T.
(Both) U.S. Army Cold Regions Research and Engineering Laboratory, Hanover, USA

Land treatment of wastewaters for rural communities. In Jewell, W. J., and Swan, R., eds., Proceedings of a Conference on Water Pollution Control in Low Density Areas. USA. Paper No. 3. 23-40. 26-28 September 1973. 13 references.

Under proper conditions, wastewater disposal by land can offer a higher level of treatment at lower costs than existing advanced waste-treatment technologies. Three methods of land treatment such as rapid infiltration, overland flow, and spray irrigation are discussed according to their design criteria and suitabilities.

wastewater; land disposal; rapid infiltration; overland flow; spray irrigation; design criteria

4145 Romanenko, N.A.
Martsinovskii Institute of Medical Parasitology and Tropical Medicine, Moscow, USSR

On helminth eggs in crops grown on sewage farms. Hygiene and Sanitation. USA. Vol. 35(11). 257-259. 1970. 1 table.

The contamination with helminth eggs of agricultural crops from sewage farms using three irrigation methods (sprinkling, flooding, and subsurface) has been investigated. Subsurface irrigation through clay pipes laid at 60-cm depths is reported to be the best method as the root crops (fodder beet) are free of helminth eggs even when irrigated with unclarified effluent. Helminth eggs, including viable ones, are discovered on beets irrigated by sprinkling and flooding through furrows. (Original paper written in Russian.)

helminths; sewage; spray irrigation; irrigation

4146 Romanenko, N. A.
Abaev, A. N.
Dolivo-Dobrovolskii, L. B.
Smirnova, Z. M.

Possibility of using solar radiation for dehelminthization of sewage sediments. Meditsinskaya Parazitologiya i Parazitarnye Bolezni. USSR. Vol. 44(2). 227-229. 1975. 2 figures.

The results of studies under laboratory and pilot conditions indicate the feasibility of using solar radiation for dehelminthization of sewage sediments in the Tajik area, USSR. The optimum operating conditions were found to be as follows: temperature

of sediment heating 60 °C, exposure time 20 min, and the thickness of the sediment layer should not be more than 25 cm. (Original paper written in Russian.)

USSR; solar; dehelminthization; sewage; sedimentation

4147 Secretaria de Recursos Hidraulicos (SRH), Mexico City, Mexico

Reuso del agua en la agricultura, la industria, los municipios y en la recarga de acuíferos. (Water reuse in agriculture, industry, community and aquifer recharge.) Dirección General de Usos del Agua y Prevención de la Contaminación, Contrato No. SP-73-C-15. Mexico. Clave UAPC 73-15. January 1974. 37 tables. 12 figures. 12 blueprints. 5 references.

Mexican arid lands have forced the government to investigate the potential for water reuse not only in agriculture but in industry and aquifer recharge as well. The effectiveness of the reuse of wastewaters for agriculture is studied through a comparative analysis of the productivity of the soils and chemical residuals that affect them. Experiments were carried out and closely monitored where lands were irrigated with potable water, wastewater, and mixed waters. The reports conclude: (a) that productivity is a function of the soil; (b) that there are several basic crops that grow better when irrigated with wastewaters; and (c) that wastewaters should not be applied to those lands where drainage is deficient, the texture too fine, or the crops not tolerant to saline components. (Original paper written in Spanish.)

Mexico; recharge; agriculture; barium; crops; water reuse

4148 Sepp, E.
Bureau of Sanitary Engineering, California State Dept. of Public Health, Berkeley, Calif., USA

Disposal of domestic wastewater by hillside sprays. Journal of the Environmental Engineering Division. Proceedings of the American Society of Civil Engineers. USA. Vol. 99(EE2). Paper No. 9673. 109-121. April 1973. 1 figure. 23 references.

Spray irrigation of hillsides is considered a suitable method for wastewater disposal in areas where the soils have good infiltration capacity and the terrain does not permit construction of large ponds. It is a method of land confinement that is being used by 100 small systems located in foothills and mountain areas in California. The use of adequate reliability features for the protection of public health is also discussed.

wastewater; sprays; USA; infiltration; land disposal; public health; disposal; recharge

4149 Shende, G. B.
Central Public Health Engineering Research Institute, Nagpur, India

Sewage utilization in agriculture. Indian Farming. India. Vol. 23(11). 25-27. February 1974.

Reclamation and reuse of sewage for agricultural uses is a practical proposition for India. A scientific approach to sewage farming should be taken for the purpose of maximizing the farm production without jeopardizing the soil productivity, public health, and environment. Some recommendations for proper practices of sewage farming are discussed. Research on utilization of sewage in agriculture in different regions having different agroclimatic conditions is encouraged.

India; agriculture; sewage; public health

4150 Shtarkas, E. M.
Krasil'shchikov, D. G.
(Both) Research Institute of Epidemiology,
Microbiology and Hygiene of the Ministry of
Health of the Lithuanian, USSR

On the sanitary zone around sewage farms irrigated by sprinkling. Hygiene and Sanitation. USA. Vol. 35(7-9). 330-331. July-September 1970.

Sprinkling with sewage is widely done in sewage farms outside the USSR. However, data on the possible spread of microflora as a result of sprinkling with sewage are scant and contradictory. Results of this study indicate that sprinkling of sewage produces bacterial contamination of the air, its degree depending upon the wind velocity. The findings suggest the need for a sanitary zone of at least 1000 m around sewage farms using sprinkling. Further experiments are needed to determine the feasibility of the extensive use of this technique under various meteorological conditions. (Original paper written in Russian.)

sewage; spray irrigation; bacterial contamination; USSR; air pollution

4151 Shuval, H. I.
The Hebrew University of Jerusalem, Israel
Disinfection of wastewater for agricultural utilization. 7th International Conference on Water Pollution Research. France. Paper No. 7C(ii). 10p. 9-13 September 1974. 5 figures. 12 references.

The presence of pathogenic organisms in sewage makes it necessary to disinfect the treated effluent before its reuse in agriculture. The author has conducted laboratory experiments and found dosages of chlorine required to achieve coliform counts of about 100 per 100 ml are from 10 to 20 mg/litre at a contact time of 1 h. As much as 10 times the amount of chlorine dose is required to accomplish an equivalent degree of inactivation of poliovirus.

pathogens; sewage; reuse; agriculture; chlorine; contact time; coliform bacteria; poliovirus; Israel

4152 Sidle, R. C.
Hook, J. E.
Kardos, L. T.
(All) Pennsylvania State University, University
Park, Pennsylvania, USA

Accumulation of heavy metals in soils from extended wastewater irrigation. Journal of Water Pollution Control Federation. USA. Vol. 49(2). 311-318. February 1977. 9 tables. 21 references.

An investigation was done of both the accumulation and distribution of heavy metals in the soil profile in two sites in Pennsylvania, a reed canary grass area and a corn rotation area, that have been irrigated with treated municipal wastewater and sludge-injected wastewater for approximately 7 yr. The rate of wastewater application is about 50 mm/week at 40-45 weeks/year and concentrations of the heavy metals in the applied wastewater are less than 1 mg/litre. It is concluded from the study that no serious soil contamination of heavy metals in either study area is observed, and copper is the only heavy metal that accumulated at a significant rate over time in the 0-30-cm depth in the treated corn areas. However, annual monitoring of heavy metals, especially cadmium, zinc, and copper, in the surface foot of the soil and in the vegetation would be desirable to avoid any future possibility of their entry into the food chain at unacceptable levels.

heavy metals; USA; irrigation; secondary effluents; wastewater; sludge; heavy metals

4153 Sivanappan, T. R. K.
Soil and Water Conservation Engineering,
College of Agricultural Engineering, Tamil
Nadu Agricultural University, Coimbatore,
India

Methods of wastewater application for agriculture. Unpublished paper on refresher course on waste recycling: Utilization for Agriculture. Public Health Engineering Dept., College of Engineering. India. 10-1 to 10-15. 10-14 March 1975. 1 table.

A general review of methods of wastewater irrigation being practiced in India and elsewhere is given. The author describes four physical-chemical characteristics of wastewater that are essential criteria for judging its suitability for irrigation as well as three main categories of wastewater application to irrigation such as surface, subsurface, and overhead techniques.

wastewater; irrigation; India; physical characteristics; chemical characteristics; criteria; sprays

4154 Stone, R.
Ralph Stone and Co. Inc., Los Angeles, Calif.,
USA

Water reclamation ... technology and public acceptance. Journal of Environmental Engineering Division, American Society of Civil Engineers. USA. Vol 102(EE3). Proceeding paper 12193. 581-594. June 1976. 4 tables. 7 figures. 3 references.

An investigation into the socioeconomic and

technical practicability of wastewater reclamation for domestic, agricultural, irrigational, recreational, and industrial reuses is reported. Attitudes of the public have been obtained mainly from 10 Southern California communities. Results of the survey indicate the general order of reuse preference as nonbody contact to body contact to consumptive uses. A cost-benefit model is presented that can determine the overall socioeconomic feasibility of reclaiming wastewater for a variety of alternative uses, taking into account differing local constraints likely to be encountered.

reuse; wastewater; USA; public opinion; technical; socioeconomic

4155 Sutherland, J. C.
Williams and Works Inc., Grand Rapids,
Michigan, USA

Cooley, J. H.
Neary, D. G.
Urie, D. H.

(All) U.S. Department of Agriculture, Cadillac,
Michigan, USA

Irrigation of trees and crops with sewage stabilization pond effluent in southern Michigan. U.S. EPA Publication. Series EPA 660 / 2-74-041. 295-313. June 1974. 9 tables. 8 references.

Results on the use of sewage pond effluents for irrigation of hardwood and conifer plantings in southern Michigan, USA, are reported. Irrigated red pine has shown increases in length and dry weight of needles by as much as 36 and 56%, respectively, over that of nonirrigated controls. However, nutrient analysis of the red pine foliage has indicated elevated levels of boron that may lead to toxicity conditions in future years. Considerable increases in survival and height growth of hardwoods are also observed when irrigated with the pond effluents.

USA; boron; irrigation; pond effluents; forest agriculture

4156 Thomas, R. E.
Jackson, K.
Penrod, L.

(All) Robert S. Kerr Environmental Research
Centre, Ada, Oklahoma, USA

Feasibility of overland flow for treatment of raw domestic wastewater. Publication No. EPA-660/2-74-087. USA. 31p. July 1974. 5 figures. 4 tables. 6 references.

A pilot-scale field study was conducted in Oklahoma to evaluate the capability of overland flow to provide complete treatment of raw comminuted wastewater on a year-round basis in a mild climatic zone. The results of this 18-month study indicate that such a system can perform satisfactorily when loaded at an average loading of 10 cm/week with the applicator operating at a pressure of 1.0 kg/cm² to avoid the formation of aerosols.

overland flow; USA; loading; sewage treatment

4157 Trout, T. J.
Smith, J. L.
McWhorter, D. B.

(All) Agricultural Engineering Dept., Colorado
State University, Fort Collins, USA

Environmental effects of land application of anaerobically digested municipal sewage sludge. Transactions of the American Society of Agricultural Engineers. USA. Vol. 19(2). 266-270. 1976. 4 figures. 12 references.

Anaerobically digested sludge from the city of Boulder, Colorado, has been applied to agricultural land for the purpose of environmental hazard evaluation. Pathogenic dangers and metal contamination of groundwater and plants are found to be insignificant at the sludge loadings up to 65 000 kg/ha on neutral pH soils but a serious threat from nitrate pollution occurs. The author proposes some management techniques involving timing and balancing of nitrogen applications with crop uptake and other factors to overcome the problem of nitrate leaching.

agriculture; land disposal; environmental hazards; pathogens; metals; loading; pH; nitrates; pollution; management; USA; anaerobic digestion

4158 Viraraghavan, T.
Ministry of Health, India

Sewage treatment with special reference to use on land for irrigation. Journal of the Institution of Engineers. India. Vol. 50. Part PH1. 25-28 October 1969. 2 tables. 14 references. 1 appendix.

The public health aspects of both restricted and unrestricted irrigation with raw and treated sewage are discussed. It is concluded that treatment in waste stabilization ponds should be encouraged before beginning restricted irrigation to minimize risks to public health. This has the added advantage that when the effluent is not required for irrigation it can be discharged more safely into a surface watercourse.

India; sewage treatment; irrigation; health; stabilization ponds

4159 Watermeyer, J. M.
Department of Conservation and Extension,
Rhodesia

Use of sewage effluent for irrigation. Rhodesian Agricultural Journal. Technical Bulletin No. 15. 37-44. 1972. 3 figures. 5 references.

The author has reviewed literature on the subject of sewage irrigation in Rhodesia and the experience gained elsewhere in the world. Except where high and excessively long pumping lifts are involved, disposal of sewage effluents through irrigation either by the municipalities themselves or by selling or subsidizing the sale of effluents to nearby farmers is considered

economical. Since there is no evidence of disease outbreaks or epidemics that can be directly attributed to irrigation with sewage effluent that has been subjected to secondary treatment, it can be assumed that secondary effluent is safe for irrigation use, provided that the health regulations are strictly adhered to.

Rhodesia; sewage; irrigation; secondary treatment; secondary effluents; economics; public health

- 4160 Wellings, F. M.
Lewis, A. L.
Mountain, C. W.
(All) Epidemiology Research Centre, State of Florida Dept. of Health and Rehabilitative Services, Tampa, USA

The fate of virus in Florida soils following secondary effluent spray irrigation. Proceedings of a National Conference on "Individual Onsite Wastewater Systems." USA. 117-124. 18-20 September 1974. 7 references.

The studies reported here confirm the findings of others, which show that secondary wastewater treatment processes, including chlorination, do not provide a virus-free effluent. More importantly, those viruses do survive aeration and sunlight during spraying and percolation through 10-20 ft (ca. 3-6 m) of sandy soil. Their survival periods can vary from a few days to a few months, depending on the surrounding environment. Attention is drawn to a potential danger of aquifer contamination over a period of time from wastewater spray irrigation.

wastewater; effluents, viruses; spray irrigation; recharge; pollution

- 4161 Wellings, F. M.
Lewis, A. L.
Mountain, C. W.
(All) Epidemiology Research Centre, State of Florida Department of Health and Rehabilitative Services, Tampa, USA

Pathogenic viruses may thwart land disposal. Water and Wastes Engineering Journal USA. Vol. 12(3). 70-74. March 1975.

Land disposal of sewage may cause hazardous build-up of pathogenic viruses in soil and in groundwater. Experiments conducted in Florida, USA, indicate that viruses can and do survive percolation through the soil. At an application rate of sewage of 58 500 gal (ca. 266 000 litres) per day containing seeded viruses of about 12 million plaque-forming units per day, a burst of virus is demonstrated in groundwater at both 10- and 20-ft (ca. 3 and 6 m) depths. The authors conclude that secondary wastewater spray irrigation of sandy soils should be recognized as one of the hazards of wastewater spray irrigation.

land disposal; sewage; pathogens; spray irrigation;

groundwater; soils; USA

- 4162 Klausner, S. D.
Cornell University, Ithaca, New York, USA
Kardos, L. T.
Department of Agronomy, Pennsylvania State University, Penn., USA

Oxygen relationship in a soil treated with sewage effluent. Journal of Environmental Quality. Vol. 4(2). 1974-1978. 1975. 4 tables. 1 figure. 15 references.

Field plots that have been irrigated with chlorinated secondary treated sewage effluent were examined for their aeration conditions. Average gaseous oxygen concentrations to a depth of 46 cm ranged from 19.6 to 19.8 to 18.4% as weekly application of effluent changed from 0 to 2.5 to 5.1 cm. Gaseous oxygen concentration was not affected by crop cover (corn or hay) but oxygen diffusion rate was less under hay than under corn. Application of 5.1 cm of sewage effluent at weekly intervals has not degraded the aeration status of the soil.

aeration; irrigation; secondary effluents

- 4163 Marsh, J. H.
Engineering Enterprises Inc., Norman, Oklahoma, USA

Irrigation with wastewater, parts 1, 2, 3. Irrigation Age. February, March, April 1975.

This is a three-part article discussing the techniques and advantages of combining waste treatment with the need for recycling and utilization of wastewaters for agricultural irrigation and other uses. The basic concept is to pretreat municipal sewage in a simplified manner and then utilize the pretreated nutrient-laden waste for beneficial irrigation of selected agricultural crops. The main thrust throughout considers the nutrient-laden enriched waste as a resource instead of a waste.

irrigation; wastewater; crops; reuse; sewage treatment

- 4164 Overman, A. R.
Agricultural Engineering Dept., University of Florida, Gainesville, Florida 32611, USA

Effluent irrigation of pearl millet. Journal of the Environmental Engineering Division. Vol. 101. No. EE2 193-199. April 1975. 4 tables. 3 figures. 7 references

This paper reports that pearl millet, which has been found to rank very high in cereal grains, also has a high N uptake when irrigated. In the field experiments that were conducted at the Southwest Waste Water Treatment Plant at Tallahassee in April 1972, pearl millet was planted in rows 3 ft (0.9 m) apart and 100 ft (30 m) long. Plots were irrigated with secondary effluent from the trickling filter plant at rates of 2 inches (5 cm)/week, 4 inches (10 cm)/week, 6 inches (15 cm)/week, and 8 inches (20 cm)/week. Plots were harvested with a commercial

forge cutter in early June and again in September. Measurements were made to determine recovery. Pearl millet respond well to irrigation with secondary municipal effluent. Recovery efficiency shared a decrease with application rate. It was shown that an N/K of 1.6 in the effluent would be desirable for pearl millet. Yields and forage quality were found comparable to those obtained in standard fertility studies.

effluents; irrigation; crops

- 4165** Overman, A. R.
Nguy, A.
(Both) Agricultural Engineering Dept., University of Florida, Gainesville, Florida 32611, USA
Growth response and nutrient uptake by forage crops under effluent irrigation. Commun. Soil Science and Plant Analysis. Vol. 6(1). 81-93. 1975. 2 tables. 16 references.

The forage crops corn (*Zea mays*), sorghum-Sudan grass (*Sorghum vulgare* Pers. X *Sorghum sundanese* Stapf.), and kenaf (*Hybiscus cannabinus* L.) were irrigated with municipal effluent at rates of 5, 10, 15, and 20 cm/week on Lakeland fine sand. Plant samples were collected weekly from each plot to measure green weight, dry matter, and nitrogen content. From these data crop nitrogen (kg/ha) was calculated for each week. Finally, uptake of nitrogen was calculated to determine efficiency of nitrogen recovery from the effluent as the crops matured. In all cases, efficiency of uptake decreased with increasing application rates, as expected from fertility studies. For corn, efficiency of uptake continued to increase up to harvest. For sorghum-Sudan grass and kenaf a peak was reached at about 50 days after planting, after which efficiency of uptake declined rapidly.

wastewater; crops; effluents; irrigation

- 4166** Sopper, W. E.
Kardos, L. T.
(Both) School of Forest Resources and Department of Agronomy, Pennsylvania State University, USA

Vegetation responses to irrigation with treated municipal wastewater. 19 tables. 7 references.

Treated wastewater from the Pennsylvania State University campus was used for irrigation purposes, on an experimental basis, for 10 years. In this paper, responses of different types of crops (such as wheat, oats, corn, alfalfa, red clover) and forest trees (mixed hard wood, red pines, and white spruce) are recorded. To establish net gain/loss within the experimental growth period of crops and forests, control plots were maintained and comparative growth tables are provided.

wastewater; irrigation; crops

4.2 Aquaculture

- 4201** Allen, G. H.
Division of Natural Resources, Humboldt State College, Arcata, Calif., USA

A preliminary bibliography on the utilization of sewage in fish culture. FAO Fisheries Circular No. 308. Italy. 15p. March 1969.

This is a compilation of papers dealing with the direct utilization of sewage or effluents from sewage treatment plants in fish culture. Included are 224 references dating from 1898 to 1966 and are derived primarily from the yearly reviews of the Journal of Water Pollution Control Federation (USA) and various institutions and authors in Germany.

USA; Germany; sewage; effluents; bibliography; reuse; aquaculture

- 4202** Allen, G. H.
School of Natural Resources, Humboldt State College, Arcata, Calif., USA

The constructive use of sewage, with particular reference to fish culture. Food and Agricultural Organization of the United Nations. Italy. FIR: MP/70/R-13. 26p. December 1970. 10 figures. 1 appendix. 122 references.

□ This is a review of literature on the use of sewage in aquaculture, especially as related to Germany, United States, Israel, and India. The review brings some highlights in the history of sewage fish culture in these countries, stresses the increased fish production in these ponds (though actual yields are not given), and discusses the biology of sewage fishpond systems, while pointing to the need for further research. In conclusion, the author states that there is good reason to believe that there will be a worldwide increase in the use of wastewater for fish and shellfish culture, and recommends that an appropriate international agency, or private foundation, should be solicited for funding an international program of research and training in utilization of wastewater in integrated agriculture-aquaculture systems.

aquaculture; fish yields; fishponds; public opinion

- 4203** Allen, G. H.
Busch, A.
Morton, W.

(All) Fisheries Department, School of Natural Resources, Humboldt State College, Arcata, Calif., USA

Preliminary bacteriological experiences with waste water-fertilized marine fish ponds, Humboldt Bay, California. FAO Technical Conference on Aquaculture. Japan. 12p. 26 May-2 June 1976. 5 tables. 30 references.

■ The results from studies undertaken during 1971-1975 with wastewater-fertilized marine fishponds at Arcata, Humboldt Bay, California, are described

with respect to: (a) salmonid fish diseases (especially *Vibrio anguillarum*); (b) the pathobiology of cultured salmonids; (c) the bacterial levels in these fishpond waters. *Vibrio anguillarum* was isolated as the causative agent of an epizootic in fingerling coho salmon in closed recirculating aquaria originally charged with wastewater-sea water. Almost one-half of the microorganisms recovered from gastrointestinal tract washings were members of the family Enterobacteriaceae, indicating a contamination of public health. Results from kidney, liver, and spleen samples indicate that none of the potential pathogens had become systemic under the fish culture conditions.

wastewater; marine aquaculture; salmon; fish diseases; Enterobacteriaceae

4204 Allen, G. H.
Fisheries Department, Humboldt State College,
Arcata, Calif., USA

Hepher, B.
Fish and Aquaculture Research Station, Dor,
Israel

Recycling of wastes through aquaculture and constraints to wider application. FAO Technical Conference on Aquaculture. Paper No. FIR: AQ/Conf./76/R 19. Japan. 18p. 26 May-2 June 1976. 5 tables. 94 references.

■ Allen and Hepher give a broad coverage of the literature related to fish culture in wastewater-fed systems, while emphasizing the inherent value in combining a waste-treatment system with a food-production system that results in an improved quality of treated wastewater. Both fresh- and saltwater regimes are reviewed. Wastewater/aquaculture processes are considered as falling into four groupings: (a) use of treated effluent in fish culture ponds; (b) dilution of wastewaters, which have received only primary treatment in fish culture ponds; (c) dilution of treated effluent in fishponds; and (d) use of sewage with minimal pretreatment or dilution. Feeding wastewater to fishponds has given 70% increases in yields of fish despite a 40% reduction in supplemental feeds. Absolute productivity figures from Israel have been in the order of 3500 kg/ha over an 8-month growth period. These results exceed commercial production rates in ponds using supplemental feed and inorganic fertilizers. Wastewater-fertilized ponds produce high fish yields because of the increase in natural foods produced by these wastes including the growth of phytoplankton and zooplankton of nitrogen, phosphorus, and trace elements consequent to bacterial breakdown of waste materials in the pond. Wastewater treatment incorporating aquaculture and use of the treated wastewater for irrigation in agriculture has been practiced in Germany for decades. Conventional stabilization used in United States ponds tends to produce an effluent that is high in algae content, which are regarded as a pollutant in themselves. Algae-eating fish, such as the Chinese carp, can extend the biological chain and act to "harvest" the algae before discharge or reuse of the pond's effluent. These

fish can be used to remove elements that would otherwise become bound up in the ponds' benthic deposits or plant life such as phosphorus and the nitrogens. Sewage/fish-culture systems can also produce higher quality effluents in terms of reduced pathogens or disease-causing organisms. A study in Oklahoma showed virtually no human pathogens in cultured fish and drastic reductions in coliforms. The authors warn, however that although the current literature indicates negative findings on human bacterial diseases being transmitted through fish, these results must be confirmed through more intensive studies. There are constraints to the production of fish in sewage-fed ponds. Among the most important is the possibility of excessive organic loading on the pond that results in reduced dissolved oxygen with consequent fish kill. Substances found in various wastewaters can be deleterious to fish; each wastewater must be evaluated on its own merits. Fish caught in natural waters frequently possess off-tastes and odours when caught in areas subject to discharges of raw wastes (particularly those containing hydrocarbons). Personal observations by several workers indicate that, on the contrary, fish grown in well-treated domestic wastes are equal to or even superior in taste or odour to nonwastewater-cultivated fish. The high pH and high oxygen levels in wastewater fishponds could actually be producing quite disease-free environmental conditions as opposed to the psychological expectation that such systems must encourage fish parasites, diseases, and pathologies. In general, the literature on wastewater-cultured fish has not reported heavy losses from fish diseases, something that would be inconsistent with the high production rates reported. Recent studies of human pathogens in salmonids reared in U.S. wastewater fishponds showed bacteria-causing human infections only in the gut. As in all water supply and wastewater processing systems, the fate of viral particles infectious to man requires a major commitment to low-cost standard-methods development for identifying and quantifying virus. Probably the most critical need for data to obtain public acceptance of wastewater-grown fish is its content of human pathogens. Depuration, such as is often used in cleaning bivalves before marketing, is the primary precautionary measure against transmission of human diseases in wastewater-reared fish. Undoubtedly some systematic study of the length of time human pathogens might stay in the intestinal tract of a fish placed in an environment clear of human pathogens would provide the type of data required. Obviously, initial development of reutilization schemes not involving direct consumption of the product by human beings would allow time to develop background data on the entire zoonoses problem. It appears that where the fishpond acts as an improved oxidation pond, a high-quality effluent for such crops, plus a crop of fish provided by a fishpond in the system, seems an eminently practical system for widespread consideration. Such integrated systems do exist throughout the world on informal or unauthorized bases. They probably do work without excessive

public health risks.

aquaculture; fish yields; fish meal; disinfection; dissolved oxygen; public opinion

4205

Allen, G. H.
Carpenter, R. L.

(Both) Fisheries Department, School of Natural Resources, Humboldt State College, Arcata, Calif., USA

The cultivation of fish in municipal wastewater lagoons as an available protein source for human beings with emphasis on salmonids. In D'Itri, F., ed., *Wastewater renovation and reuse*. Marcel Dekker Inc. USA. ISBN 0-8247-6505-2. 479-528. 1977. 8 figures. 11 tables. 54 references. Discussion by Balfour Hepher.

Two pilot projects employing wastewater to produce fish are presented. One project, Quail Creek, near Oklahoma City, Oklahoma tested the use of a fish polyculture system in six municipal lagoons operated in series. The second project, Humboldt Bay, Arcata, north-coastal California, tested empirically the feasibility of rearing juvenile salmonids on natural food chains. In addition some of the nontechnical considerations surrounding wastewater aquaculture in one of these regions (California) are presented.

wastewater; aquaculture; USA; salmonids; fish diseases

4206

Bose, P. C.

Corporation of Calcutta, India

Nair, K.

Department of Fisheries, Bengal, India

Fowler, G. J.

A symposium on the utilization of sewage for fish culture. Proceedings of the National Institute of Science of India. Vol. 10(4). 411-467. 1944.

Four papers on the utilization of Calcutta's sewage for fish culture are presented. The primary sewage treatment plant at Calcutta and the effect of the discharge of settled sewage on the fish life in local rivers are described. The utilization of sewage in local fisheries is discussed with particular reference to the various types of fish able to grow in sewage-fertilized waters and the alternate use of fishponds for fish culture and rice cultivation. The symposium highlighted the large profitability of sewage-fed fish culture both from the point of view of protein production and wastewater treatment.

India; sewage; fish; aquaculture; carp

4207

Carpenter, R. L.
Coleman, M. S.
Jarman, R.

(All) Oklahoma State Department of Health, USA

Aquaculture as an alternative wastewater treatment system. In Tourbier, J., and Pierson, R. W., ed., *Biological Control of Water Pollution*. University of Pennsylvania Press. USA. 215-224. 1976. 1 table. 5 figures. 22 references.

A report of a full-scale aquaculture pond, serially operated system, treating domestic wastewater in Oklahoma, USA, is given. The system is reported to provide a high-grade effluent low in nutrients and bacteria counts and yields of fish biomass are moderate. The authors propose future studies to maximize the fish production and examine its potential effects on public health.

aquaculture; stabilization ponds; USA; effluents; nutrients; bacteria; fish; public health; domestic; wastewater; reuse

4208

Chan, W. L.

Fisheries Research Division, Agriculture and Fisheries Department, Hong Kong

A general account of fish culture trials in the oxidation ponds on the pilot sewage treatment plant at Shek Wu Hui, Hong Kong. Unpublished report. 13p. September 1976. 1 figure. 8 tables.

This is a report on an experiment carried out in Hong Kong in which fish were stocked in six ponds of 0.2 ha each receiving treated effluent from the nearby Shek Wu Hui experimental sewage treatment plant. The fish cultured were *Tilapia mossambica*, the catfish *Clarias fuscus*, grass carp *Ctenopharyngodon idella*, bighead carp *Aristichthys nobilis*, silver carp *Hypophthalmichthys molitris*, and common carp *Cyprinus carpio*. Due to low stocking densities the average net yield of carps was 1.6 tons/ha. The survival of the catfish was low.

aquaculture; fish yields; fish; Tilapia; catfish; grass carp; silver carp; bighead carp; common carp; Hong Kong

4209

Ghosh, A.

Rao, L. H.

Banerjee, S. C.

(All) Central Inland Fisheries Research Institute, Barrackpore, West Bengal, India

Studies on the hydrobiological conditions of a sewage-fed pond with a note on their role in fish culture. Journal of Inland Fisheries Societies. India. Vol. 6. 51-61. 1974. 2 figures. 2 tables. 15 references.

Hydrobiological conditions of a sewage-fed pond in relation to fish culture are presented and discussed. It is observed that the fluctuation in biota and other chemical factors of the pond are mainly governed by the characteristics of the applied sewage effluent. A 0.67-ha sewage-fed pond stocked with rohu, calta, mrigal, and silver carp at a stocking density of 50 000 / ha has a gross production of 7676 kg / ha in 7 mo.

stabilization ponds; sewage; effluents; aquaculture

- 4210 Hefher, B.
Schroeder, G. L.
(Both) Fish and Aquaculture Research Station,
Dor, Israel
Wastewater utilization in integrated aquaculture and agriculture systems. United States Environmental Protection Agency. USA. Series EPA 660 / 2-74-041. 9-15 June 1974. 1 figure. 7 references.
The authors describe some benefits gained from utilizing aquaculture ponds receiving waste effluent from a treatment plant, instead of direct reuse of the effluent in agriculture. Apart from fish yields, water from the fish ponds is observed to have higher dissolved oxygen (DO) with less nutrient content and bacteria count than the system without fish. Two factors that may affect the fish stocks, such as DO depletion and the presence of toxic substances, are also discussed.
stabilization ponds; aquaculture; agriculture; reuse; dissolved oxygen; nutrients; bacteria; toxic substances; effluents
- 4211 Jhugran, V. G.
Central Inland Fisheries Research Institute,
Barrackpore, West Bengal, India
A critical appraisal of the water pollution problem in India in relation to aquaculture. Proceedings FAO Indo-Pacific Fisheries Council. New Zealand. 15th session. Section II. 45-50. 1974. 1 table. 16 references.
The major sites of freshwater pollution lie along the important river systems of India. The present status of sewage-fed fish culture in India is reviewed. It is estimated that there are more than 132 sewage-fed fisheries in India, covering an area of about 12 000 ha. In experimental investigations conducted in a West Bengal State fisheries sewage-fed farm near Calcutta, yields up to 3.2 t / ha per annum have been attained. More than 50 wastewater stabilization ponds are used for fish culture and appreciable fish production has been reported from some of them. Pollutants that pose a major threat to aquaculture are listed and discussed.
aquaculture; India; water pollution
- 4212 Kerfoot, W. B.
Redmann, G. A.
(Both) Woods Hole Oceanographic Institution,
Boston, Mass., USA
Permissible levels of heavy metals in secondary effluent for use in a combined sewage treatment-marine aquaculture system II. Development of guidelines by method of addition. Wastewater use in the production of food and fiber. Proceedings: U.S. Environmental Protection Technology Series. USA. EPA-660 / 2-74-041. 79-101. June 1974. 7 figures. 2 tables. 23 references.
An attempt to develop guidelines for the permissible concentrations of six metals (zinc, copper, lead, cadmium, chromium, and nickel) in a combined sewage treatment-marine aquaculture system is discussed. This was done experimentally by enriching effluent added to algae culture used in a model aquaculture system with these metals and studying their accumulation in the algae and oysters and the toxicity effects of the metals. Suggested permissible concentrations were (ppm): copper, 0.2; cadmium 0.1; nickel, 0.05; chromium, 0.5; lead, 1.0; and zinc, 1.0.
marine aquaculture; heavy metals; oysters; secondary effluents
- 4213 Krishnamoorthi, K. P.
Abdulappa, M. K.
Sarka, R.
Siddiqi, R. H.
(All) Central Public Health Engineering Research Institute, Nagpur, India
Productivity of sewage fertilized fish ponds. Water Research. U.K. Vol. 9(3). 269-274. 1975. 8 figures. 7 references.
A pilot-scale experiment, conducted in India, of fish-culture ponds receiving effluent from a stabilization pond treating domestic wastewater is reported. Fish yields are observed to be better where diluted effluent is used than without dilution, and a similar trend is also noted for primary productivity (or algal growth). An energy balance shows that 3.86% of incident solar energy is fixed through primary production and 0.1% can be harvested in the form of fish.
India; fish harvesting; stabilization ponds; effluents; domestic; wastewater; algae; energy; solar
- 4214 Mortimer, C. H.
Freshwater Biological Association, Ambleside,
Cumbria, U.K.
Fertilizers in fishponds. Colonial Office Fishery Publications No. 5. Her Majesty's Stationery Office. U.K. 1954. Section 10: Utilization of sewage in fishponds. 28-29. Abstracts of literature on this subject. p. 46, 48, 57-58, 83-85, 98, 106, 108, 118-119, and 133.
A selected annotated bibliography of the literature on sewage fertilization of fishponds from 1899 to 1954 is given.
sewage treatment; fertilization; bibliography; aquaculture
- 4215 Mortimer, M. H. E.
Ruth, D. J.
Mulnwa, L.
(All) Game and Fisheries Dept., Northern Rhodesia (Zambia)
Ducks, vegetables and fish ... Rhodesia Agriculture. 82-87. May / June 1963.
A simple irrigated small holding pond, 0.8 ha in

size, centred on fish, duck, and vegetable production is described. The fishpond, fertilized with duck feces, yielded 1120 kg of fish per hectare per annum.

Zambia; irrigation; animal wastes; ducks; aquaculture

- 4216 Muthuswamy, S.
Govindan, S.
Sundaresan, B. B.
(All) Public Health Engineering Dept., College of Engineering, Madras, India

Productivity of *Cyprinus carpio* in stabilization pond effluents. Indian Journal of Environmental Health. India. Vol. 16(4). 370-379. 1974. 7 figures. 10 references.

A report on a 6-month study of growth of *Cyprinus carpio* in fishponds fed with sewage stabilization-pond effluent in Madras is given. The test fish attained maturity in about 4 months from fingerling stock and a maximum weight of 620 g was achieved in 6 months. Maximum gross primary production was 43.3 g O₂ / m² per day and the rate of fish survival was high, giving a fish production rate of 7700 kg / ha per year.

stabilization ponds; effluents; reuse; carp; fishponds; rural sanitation; India; aquaculture

- 4217 Prowse, G. A.
Tropical Fish Culture Research Institute, Malacca, Malaysia

A review of the methods of fertilizing warm-water fish ponds in Asia and the Far East. Proceedings of FAO World Symposium on Warm-Water Pond Fish Culture. Italy. 7-12. 18-25 March 1966.

Traditional methods of fishpond fertilization are reviewed. In China, Hong Kong, Taiwan, and Malaysia, Chinese carp are raised in conjunction with pigs and ducks. Cut plants and night soil are often added. In India where other carps are cultured, cut plants, oilseed cake, and sewage are used as fertilizers. Experiments on artificial fertilizers have been carried out in Taiwan, the Philippines, and India, and have been based on N-K-P mixtures.

fishponds; China; Hong Kong; Taiwan; Malaysia; fertilization; excreta; sewage; Philippines; India

- 4218 Radebaugh, G. H.
Agersborg, H. P. K.
(Both) Urbana-Champaign Sanitary District, Illinois, USA

The economic value of treated sewage effluent in wildlife conservation, with special reference to fish and water fowl. Transactions of the American Fisheries Society. USA. Vol. 64. 443-456. 1934. 4 tables. 19 references.

A report on the use of undiluted humus tank effluent for the culture of fish and molluscs in Urbana-Champaign, Illinois, is given. The fish

included carp, bullheads, catfish, and mudcats, carp being the most successful. Mussels were suggested as "indicators" of the fitness of the lagoon to rear marketable fish and waterfowl.

sewage treatment; mussels; aquaculture; USA

- 4219 Ryther, J. H.
Woods Hole Oceanographic Institution, Boston, Mass., USA

Preliminary results with a pilot plant water recycling-marine aquaculture system. In D'Itri, F., ed., Wastewater Renovation and Reuse, Marcel Dekker Inc. Institute of Water Research, Michigan State University. USA. 89-132. 1977. 1 figure. 5 tables. 7 references. Discussion by Malcolm S. Gordon.

The paper gives the results of a 1-year period testing of a combined waste recycling-marine aquaculture system that has been developed on a pilot-plant scale at Woods Hole Oceanographic Institution. Successful cultures of unicellular algae, mostly diatoms, and seaweeds have been sustained over long periods of time (months) with only minor problems. Algae yields and nitrogen removal capacity vary seasonally by three- to fourfold and are controlled by solar radiation but not by temperature. Bivalve mollusc culture was unsuccessful during the first year of operation. Good growth of flounders and lobsters was obtained, but carrying capacity of the system and potential yields have not yet been determined.

marine aquaculture; unicellular algae; diatoms; seaweed; nitrogen removal; oysters; flounders; lobsters

- 4220 Schillinger, Von A.
Von der abwassereinigung in fischteichen. (On the wastewater treatment in fishponds.) Gesundheits-Ingenieur, Zeitschrift für die gesamte Stadtthygiene. Germany. Vol. 58(14). 192-193. April 1935.

The paper describes briefly the wastewater-fishpond system near Munich. It points out the advantages of the system, especially the smaller area required for treatment as compared to land application, and also the constraints, especially the need for dilution waters. In general at normal temperatures 1 ha of fishpond can treat primary sewage effluents from 2000 persons. The paper discusses the economics of the treatment system. (Original paper written in German.)

wastewater; fishponds; sewage treatment; Germany; economics

- 4221 Schroeder, G. L.
Nighttime material balance for oxygen in fish ponds receiving organic wastes. Bamidgah. Israel. Vol. 27(3). 65-74. 1975. 3 figures. 1 table. 1 appendix. 7 references.

Factors using oxygen in fishponds receiving organic wastes are discussed. Biological oxygen

demand (BOD) of the pond water and suspended material was the largest consumer of oxygen for the cases studied. Transfer of oxygen across the pond surface was calculated. A system for reaerating pond water is described.

dissolved oxygen; aeration; BOD; aquaculture; organic wastes

4222 Tapiador, D. D.
FAO Regional Fisheries for Asia and the Far East, Bangkok, Thailand

A preliminary review on the possibility of commercial fish meal production from sewage fish farming. Draft paper prepared for the FAO Technical Conference on Fisheries Products. Japan. 3p. 4-11 December 1973.

A preliminary review is made of sewage fish farming and its possible use as a new nontraditional source of commercial fish meal manufacture. The author concludes that the aforementioned possibility exists and that interested member governments or international or regional organizations with the financial resources should immediately undertake a pilot project in this field.

sewage, fish meal; commercial manufacture; aquaculture

4223 Vinberg, G. G.
Lyakhovich, V. P.
Udobrenie prudov ... glava IV. Organicheskoye udobrenie prudov-5. Udobrenie stochnimi vodnami. (Fertilization of ponds ... chapter IV. Organic fertilization of ponds-5. Fertilization by wastewater.) Isdatelstvo "Pyshchevaya Promishlenoste." USSR. 167-172. 1965. 22 references.

The chapter discusses the advantages and problems related to the use of wastewater in fishponds and reports previous experiments carried out on this aspect, such as those on the wastewater-receiving fishpond at Munich, Germany; fish culture in wastewater-treating ponds at Lyubarchi, near Moscow, USSR; the use of treated sewage in fish ponds near Kielce, Poland; and studies carried out in Czechoslovakia on the use of dairy and sugar factory wastes in fishponds. (Original paper written in Russian.)

fishponds; fertilization; fish yields; wastewater; flow-through ponds; industrial wastewater; carp; agriculture

4224 Wolny, P.
Instytut Rybactwa Srodladowego, Drss Zabieniec, Poland

The use of purified town sewage in fish rearing. Selected translations from Roczniki Nauk Rolniczych. The Scientific Publications, Foreign Cooperation Center of the Central Institute for Scientific, Technical and Economic Information. Poland. TT65-

50503. 36-51. 1966. 1 figure. 8 tables. 3 diagrams. 16 references.

A study on the use of treated wastewater in fishponds was conducted during 1958-1961 at Kielce, Poland, near the sewage-disposal works. Stagnant and flow-through fishponds were stocked with carp fingerling. The composition of the sewage and pond water is reported; maximum yield obtained in the wastewater fishpond was 1317.7 kg/ha, a record yield for Poland. In contrast, the flow-through ponds had an adverse effect on fingerling growth. There was no need for dilution of the treated sewage before introduction into the pond. The treated sewage is suitable also for wintering ponds. The presence of carp in the stagnant ponds enhances photosynthesis, improves oxygen conditions, accelerates the cycling of materials in the pond, and accelerates sewage purification.

aquaculture; sewage; carp; Poland; fishponds; dissolved oxygen; fish meal

4225 Kulkarni, B. W.
Fish production in sewage oxidation ponds. Association of Central Inland Fisheries Education, Bombay, India. Souvenir. Vol. 1(5). 34-38. 1975. 3 tables. 4 references.

Sewage fertilizes fishponds because of its high organic value. The sewage matter, however, if not judiciously used, may cause serious depletion of dissolved oxygen content of water, leading to high mortality of fish. This paper discusses the results of 4 years' observation of fish production from an oxidation pond located at Bhilai (Madhya Pradesh, India).

oxidation ponds; sewage; dissolved oxygen; aquaculture

4226 Schroeder, G. L.
Fish and Aquaculture Research Station, Dor, Israel

Some effects of stocking fish in waste treatment ponds. Water Research. Great Britain. Vol. 9. 591-593. 1975.

Oxidation ponds or sewage lagoons often present characteristics of natural water bodies in an extreme state of ecological imbalance. Excess nutrients of decaying wastes give rise to plankton blooms that subsequently die. The addition of fish to ponds, which twice a week received, per hectare, wastes with a 5-day BOD of up to 800 kg (20 °C) and 5600 kg solids, reduced plankton and benthic populations, increased the average dissolved oxygen, and raised the pH. All these changes improve the effectiveness of a waste-treatment pond for reducing BOD and removing nutrients from the water.

dissolved oxygen, pH; BOD; stabilization ponds; aquaculture

4227

Sundaresan, B. B.
Muthuswamy, S.
Govindan, S.(All) College of Engineering, Madras 600025,
India

Low cost waste treatment and utilization system. Sanitation in Developing Countries Today. A conference sponsored by Oxfam in association with the Ross Institute of Tropical Hygiene. 5-9 July 1977. Pembroke College, Oxford. p. 7. 3 figures. 5 tables. 9 references.

A demonstration plant, involving wastewater treatment in oxidation ponds, fishponds, and use of effluent with nutrients for agriculture, was built and operated for several years. The performance of various units in the system for reduction in pollution, bacterial population, algae yield, fish growth, and coconut plant cultivation has been observed. Bacterial survival at various stages of sewage treatment and utilization was recorded using periodic analysis. There is considerable reduction in bacterial population in the oxidation pond; however, presence of fecal coliforms, fecal streptococci, and *Salmonella* in fishponds was recognized in pisciculture. It is felt that additional revenue generated from fish production and coconut palms would not only meet the operation and maintenance expenditures but will add to the income of local communities.

sewage; oxidation ponds; algae; fish; low-cost treatment

4.3 Algae

4301

NOAA News Release, USA

Algae and brine shrimp treat sewage and help produce crops and seafood. NOAA News Release. USA. 7p. July 1974.

Brine shrimp used with certain algae that thrive in raw sewage can biologically treat effluent and provide food for raising fish at the same time. Brine shrimps are used to keep the organism in a continuous state of exponential growth. Component chemicals highly nutritious to algal growth, especially phosphate, are reduced to levels similar to those of conventional secondary or possible tertiary treated sewage.

algae; biological treatment; shrimp

4302

Commonwealth Bureau of Animal Nutrition,
Bucksburn, Aberdeen

Fungi and unicellular algae as foods. Annotated bibliography no. 6 of the Commonwealth Bureau of Animal Nutrition. Supplement covering the period 1968-1970. 15p.

□ This is a worldwide literature search and annotated bibliography on the use of fungi and unicellular algae as foods for man and animals. About 70 reports deal

with fungi and 13 reports with algae.

algae; fungi; nutrition; bibliography; aquaculture; animal feed; human food

4303

Technion-Israel Institute of Technology and
Sherman Environmental Engineering Research
Center with the Fish and Aquaculture Research
Station, Ministry of Agriculture, Israel

Fish feeding experiments with algae. A progress summary of a project "Combined Systems for Algal Wastewater Treatment and Reclamation and Protein Production, October 1975-May 1976." 3p.

■ A series of algal digestibility experiments on carp has been conducted and results obtained indicate that the drum-dried algae were more digestible than the sun-dried algae, and that milling increased the digestibility of the drum-dried algae. On growth experiments, it was shown that algae of the *Euglena* species could successfully replace part of the fish-meal diet. Further tests in field conditions of these growth experiments are being carried out in Israel.

Israel; carp; growth kinetics; algae harvesting; dewatering

4304

Dugan, G. L.
Golueke, C. G.
Oswald, W. J.(All) Sanitary Engineering Research Laboratory,
University of California, Richmond,
Calif., USA

Photosynthetic reclamation of agricultural solid and liquid wastes. Solid Waste Research and Development, II, Engineering Foundation Research Conference. USA. 34p. 22-26 July 1968. 4 tables. 5 figures. 28 references.

This is a research report on the design of a reclamation facility for converting animal wastes into useful materials, such as algae. The study involves a practical method of handling chicken manure, an anaerobic digestion of the manure, and an algal production in ponds receiving effluents from the digesters and other operations. Drawings of a pilot-scale poultry house that is representative of a practical egg-production operation are included.

animal wastes; algae; anaerobic; design; reuse; digesters

4305

Golueke, C. G.
Oswald, W. J.(Both) Sanitary Engineering Research Laboratory,
University of California, Richmond,
Calif., USA

Harvesting and processing sewage-grown planktonic algae. Journal of the Water Pollution Control Federation. USA. Vol. 37(4). 471-498. April 1965. 7 figures. 7 tables. 12 references.

□ An extensive investigation in the laboratory and the field concerning the harvesting of algae from sewage is reported. Three steps involved in the harvesting are: initial concentration, dewatering (secondary concentration), and final drying. A number of methods have been tried. Economics of the algal-production process are also analyzed in detail.

algae; sewage; economics

4306

Golueke, C. G.
Oswald, W. J.

(Both) University of California, Berkeley, Calif., USA

An algal regenerative system for simple-family farms and villages. Compost Science. USA. Vol. 14(3). 12-15. May/June 1973 2 figures.

A design proposal for a rural house, in which the principal components are an anaerobic digester for animal and human wastes, combined with an algal regenerative system situated in a roof pond, is described. The algae product is used as animal feed. Vapours from the algal pond pass through a solar still and provide potable water.

rural; household; biogas; algae; design

4307

Grisanti, N. E.
Oswald, W. J.

(Both) Public Health and Civil Engineering Dept., University of California, Berkeley, Calif., USA

Protein from algae. Session on Processes for New Protein Foods. American Institute of Chemical Engineers National Meeting. USA. 25p. 14 April 1976 4 tables. 42 references.

□ Many investigations are being conducted for the purpose of maximizing algal production from wastewaters. Although algae are considered a good source of protein for man and animals, some qualitative problems still exist, such as a lack of balance of complement amino acids; the cell walls being indigestible by nonruminant animals; and some public health aspects. However, the authors report that these problems are being overcome and the future of algae as a protein supplement for animal feed appears promising.

algae; wastewater; protein; animal feed; human food; public health

4308

Hintz, H. F.
Heitman, H., Jr
Weir, W. C.
Torell, D. T.
Meyer, J. H.

(All) Dept. of Animal Husbandry, University of California, Davis, Calif., USA

Nutritive value of algae grown on sewage. Journal of Animal Science. USA. Vol. 25(3). 675-681. August

1966. 10 tables. 19 references.

An experiment conducted in California to determine the nutritive values of sewage-grown algae fed to pigs, cattle, and sheep is reported. Several feeding trials indicate that these algae are capable of supplying adequate proteins and other essential elements to the animals; however, they have to be pelleted with other more desirable feeds, such as barley or alfalfa, to avoid an unpleasant taste.

USA; algae; sewage; protein; animal feed; nutrition

4309

Lee, E. S.

Environmental Engineering Division, Asian Institute of Technology, Bangkok, Thailand
Economics of algal protein production, harvesting and processing, from high-rate oxidation ponds. Master of Engineering Thesis No. 974. Asian Institute of Technology. Thailand. 126p. 1976. 16 tables. 46 figures. 35 references. 8 appendices containing 82 tables and 1 figure.

A report on an updated evaluation of the economics of algal production in high-rate oxidation ponds and their harvesting is given. Sewage was fed to a pilot-scale pond operated without chemical addition and with the addition of 2 mg/litre Purifloc-C31 or 0.4 mg/litre of ferric chloride to effect autoflocculation. The raw effluent from the pond was subjected to sedimentation (autoflocculation) flotation and centrifugation as alternatives for algal harvesting. Algal paste drying was by open-air pan drying and sand-bed drying. Pelletization of the algae both as sole constituent and in combination with tapioca was studied in an attempt to produce a more marketable product. It was concluded that autoflocculation without chemicals for 7 h was the most economic algal harvesting method. For an autoflocculation plant with a capacity of 15 750 m³/day of oxidation pond effluent containing 200 mg/litre algae, the estimated cost of the algal product is U.S. \$0 12 and an annual profit of U.S. \$111 200 if the product is sold at the same price as fish meal.

sewage treatment; oxidation ponds; effluent reuse; protein; algae harvesting; economics; Asia

4310

McGarry, M. G.

Asian Institute of Technology, Bangkok, Thailand

Unicellular protein production using domestic wastewater. Thai Journal of Agricultural Science. Thailand. Vol. 4. 213-223. October 1971. 3 tables. 2 figures. 9 references.

Unicellular algae have been grown on a pilot-plant scale in open ponds receiving domestic sewage. An overall process of algal harvesting, concentration, dewatering, and drying is described. Preliminary experiments reveal that the algae may be used as a dietary source of protein for chickens, swine, and cattle.

algae ponds; domestic; sewage; algae harvesting; protein

- 4311 McGarry, M. G.
Lin, C. D.
Merto, J. L.
(All) Division of Environmental Engineering,
Asian Institute of Technology, Bangkok,
Thailand

Photosynthetic yields and byproduct recovery from sewage oxidation ponds. In Jenkins, S. H., ed., *Advances in Water Pollution Research*. U.K. 521-535. 1973. 6 figures. 17 references.

This paper describes sewage treatment and algal growth under tropical conditions as affected by pond mixing, solar radiation, and diurnal variations in pond loading. Research into processing the algal by-product is also discussed.

oxidation ponds; algae; sewage treatment; effluents

- 4312 McGarry, M. G.
Ng, K. S.
Leung, N. H.
Lee, T. L.
(All) Asian Institute of Technology, Bangkok,
Thailand

Wastewater reclamation under tropical conditions. *Process Biochemistry*. U.K. Vol. 9(7). 14-24. September 1974. 4 figures. 18 references.

A report on studies aimed at reclaiming a potable water from domestic wastewater using techniques appropriate to tropical and savanna developing countries is given. High-rate treatment oxidation ponds, dissolved air flotation with alum coagulation, roughing filtration through coarse sand, photosynthetic nitrogen stripping ponds, powdered activated carbon adsorption, dual media filtration and chlorination were necessary to remove nitrogen and low-level organic constituents to produce a physically, chemically, and bacteriologically suitable water.

sewage treatment; effluent reuse; algae harvesting; Asia

- 4313 McGarry, M. G.
Tongkasame, C.
(Both) Asian Institute of Technology, Bangkok,
Thailand

Water reclamation and algae harvesting. *Journal of the Water Pollution Control Federation*. USA. Vol. 43(5). 824-835. May 1971. 3 tables. 9 figures. 8 references.

The high-rate oxidation pond is considered as a potential method of waste treatment in tropical regions. Products of the process are reclaimed water and edible protein harvested from the pond in the form of algae that may be incorporated directly into stock feeds. This paper describes findings that were obtained from laboratory and pilot-scale experiments

conducted in Thailand. The reports are concerned with the following: operating conditions of the ponds; methods of algal harvesting; and an urban model development for recycling of the reclaimed water.

high-rate ponds; algae; algae harvesting; Thailand; tropics; effluent reuse

- 4314 Neil, J. H.
Environment Canada, Ottawa, Canada

The harvest of biological production as a means of improving effluents from sewage lagoons. *Environment Canada Research Report No. 38*. Canada. 40p. 1976. 9 tables. 38 references.

The feasibility of removing phosphorus, nitrogen, and organic matter through harvest of algae, duckweed, daphnia, or midge larvae has been examined. Data from five Ontario sewage lagoons and from the literature are analyzed. Sufficient nutrients can be removed by this method. Effective harvesting would greatly enhance effluent quality.

sewage; lagoons; algae; aquatic weeds; nutrients; Canada

- 4315 Oswald, W. J.
Sanitary Engineering Research Laboratory,
College of Engineering and School of Public
Health, University of California, Berkeley,
Calif., USA

The high-rate pond in waste disposal. *Developments in Industrial Microbiology, American Institute of Biological Sciences*. USA. Vol. 4. 112-119. 1963. 2 tables. 4 figures.

□ High-rate algal laden ponds are used as systems for waste disposal, nutrient reclamation, and water reclamation. From laboratory and pilot-plant experiments, the optimum depth and detention time of ponds are found to be 8-10 inches (ca. 20-25 cm) and 3-4 days, respectively. The optimum period of mixing is 2-3 h per day. Algae produced in the ponds is reported to be high-vitamin, high-protein animal feed concentrate, and its production is estimated to be 1 ton (0.907 tonnes) per million gal (4.5 million litres) of sewage.

high-rate ponds; algae; sewage; disposal; reuse; nutrients; pond depth; detention time; protein

- 4316 Sastry, C. A.
Rao, A. V.
Rao, M. N.

Reuse of stabilization pond effluents for harvesting of algae. *Proceedings of a Seminar on Water Resources Development organized by the Institution of Engineers (India) Durgapur Sub-Centre, in collaboration with Central Mechanical Engineering Research Institute, and Regional Engineering College, Durgapur, India.* p. 243. 22-23 September 1973. 9 tables. 6 references.

This is a report of jar test studies of algal flocculation from the effluent of Shahpura oxidation ponds, Bhopal. An alum dose of 200-240 mg/litre was required to remove 90-97% of the algae after sedimentation for 30 min. pH 8.0-9.0 and flocculation time 20-25 min were optimum. Nirmali seed at a dosage of 8 mg/litre in combination with 180 mg/litre alum effected 98-99% algae removal. The harvested algae contained 49.4% protein.

stabilization ponds; effluent reuse; India; algae harvesting; alum flocculation

4317 Shelef, G.
Schwarz, M.
Schechter, H.

(All) The Environmental Health Laboratories, Dept. of Medical Ecology, The Hebrew University of Jerusalem, Israel

Prediction of photosynthetic biomass production in accelerated algal-bacterial wastewater treatment system. Proceedings of the Sixth International Water Pollution Research Conference. Israel. No. 9. A/5/9/1 - A/5/9/10. 18-23 June 1972. 6 figures. 2 tables. 23 references.

The rate of algal production and the concentration of algae in a sewage stabilization pond with respect to detention time can be formulated and predicted according to the incident solar irradiance levels. The model is developed using algal growth kinetics and continuous mixed culture theories from which the predicted values are shown to be comparable to actual data.

algae, sewage; stabilization ponds; detention time; mathematical models; solar; growth kinetics

4318 Songer, J. G.
Smith, R. F.
Trief, N. M.

(All) Department of Preventive Medicine and Community Health, University of Texas Medical Branch, Galveston, Texas, USA

Sewage treatment by controlled eutrophication ... bacterial study. Applied Microbiology. USA. Vol. 28(3). 359-361. September 1974. 1 figure. 1 table. 6 references.

A system has been developed on a laboratory scale involving the use of marine algae *Tetraselmis chuni* for controlled eutrophication of raw sewage. Algae grown from raw sewage are fed to brine shrimp, *Artemia salina*. Net products of the system are reported as: (a) brine shrimp for use as food or shrimp food; and (b) a purified effluent. The authors studied bacterial pathogen flow through the system. Significant reductions in fecal coliforms and enterococci were noted from raw sewage to effluent. *Salmonella* and *Shigella* were not detected at any stage, nor were they isolated from the effluent only, reflecting the halophilic nature of the organism. Brine shrimp were tested and found to have extremely low numbers of

the above organisms.

marine aquaculture; algae; brine shrimp; coliform; bacteria; Salmonella; Shigella; enterococci

4319 Tenore, K. R.
Dunstan, W. M.

(Both) Department of Biology, Woods Hole Oceanographic Institution, Woods Hole, USA

Growth comparisons of oysters, mussels and scallops cultivated on algae grown with artificial medium and treated sewage effluent. Chesapeake Science. USA. Vol. 14(1). 64-66. March 1973. 2 tables. 13 references.

This article describes the experiments carried out at the Woods Hole Oceanographic Institution on the culture of shellfish, American oyster (*Crassostrea virginica*), the blue mussel (*Mytilus edulis*), and the bay scallop (*Aequipecten irradians*), on algae grown in artificial medium and in secondary treated sewage effluent (10% dilution) in 9-litre trays. No significant differences were observed in shell growth, dry meat weight, and mortality.

marine aquaculture; shellfish; oysters; mussel; scallops; algae; effluents

4320 Vincent, W. A.
Battelle Institute, Geneva, Switzerland

Algae for food and feed. Process Biochemistry. U.K. 3p. June 1969 5 tables. 14 references.

A possibility of using algae for human food and animal feed is discussed. The author reports maximum protein production is obtained with algae as compared to other kinds of plants and animals, but he differentiates their nutritive values, such as the hard-cell-wall and thin-cell-wall algal species that are suitable for ruminant and nonruminant animals, respectively. The promise of algal culture is not yet fulfilled, the reasons being technical, nutritional, and socioeconomical.

algae; human food; animal feed; protein; public opinion; nutrition; technical; economics

4321 Wachs, A. M.
Shelef, G.
Sandbank, E.
(All) Technion-Israel Institute of Technology, Haifa, Israel

Algae of stabilization pond — their separation and utilization. Unpublished final report. Project No. 013-366. 67p. April 1971. 9 figures. 28 tables. 28 references.

An investigation conducted in Israel to find a practical and economical method of algal separation from pond effluent and to produce algal by-products that can be used as animal feedstuff is reported. Data from several experiments indicate that improved effluent quality during algal harvesting can be obtained with a combination of alum flocculation and

air flotation. Preliminary fish feeding with alum-separated algae proves very encouraging with algae rations of up to 30% of the total feed.

Israel; algae; effluents; alum flocculation; air flotation; stabilization ponds; aquaculture

4.4 Fertilization

4401

Department of Agriculture, Stock and Fisheries, Papua New Guinea

Workshop on waste recycling systems. Proceedings of a workshop held at the University of Papua New Guinea. 127p. 1974.

Seventeen papers and three summary papers on waste recycling systems and their application in Papua New Guinea are given. The first section (five papers) covers anaerobic digestion of human and animal wastes and digester designs for maximum gas yield. The second section (seven papers) deals with the growth of algae and fish in stabilization ponds, the use of algae and dried animal excreta as livestock feeds, fertilization of sweet potato crops with wet pig manure, and integrated rural development (biogas generation in a modified septic tank, waste stabilization ponds, and fish and duck ponds to treat septic tank effluent, and vegetable gardens). The third section (five papers) is concerned with socioeconomic aspects of human and animal waste-recycling systems, principally with the economics and management of biogas generation systems.

Papua New Guinea; biogas; anaerobic digestion; algae; stabilization ponds; animal feed; land disposal; excreta; reuse

4402

McGarry, M. G.

International Development Research Centre, Ottawa, Canada

The taboo resource ... the use of human excreta in Chinese agriculture. The Ecologist. U.K. Vol. 6(4). 150-154. June 1976. 2 tables. 11 references.

■ A review of popular practices in the use of human excreta as fertilizer in China from 1949 to 1974 is given. Night soil is compared in nutrient value with other fertilizers, and the total contribution of human fertilizer to Chinese agricultural development is estimated. Health education campaigns have reduced the spread of intestinal diseases due to this practice.

excreta; agriculture; China; fertilization; public health; diseases; community; household

4403

Peterson, J. R.

The Metropolitan Sanitary District of Greater Chicago, Chicago, Illinois, USA

McCalla, T. M.

University of Nebraska, Lincoln, Neb., USA

4404

Sastry, C. A.

National Environmental Engineering Research Institute, Zonal Laboratory, Madras, India

Public health considerations of waste recycling. Unpublished Paper on Refresher Course on Waste

Smith, G. E.

University of Missouri, Columbia, Mo., USA

Human and animal wastes as fertilizers. Fertilizer Technology and Use. 2nd edition. Published by Soil Science Society of America, Inc. USA. 557-596. 1971. 8 figures. 27 tables. 42 references.

□ The solid waste from municipal wastewater treatment plants in the USA amounts to 45 million tonnes/year. This material contains from 2.6 to 5.6% N, 2.8 to 3.4% P, 35 to 47% organic matter, and a large assortment of other chemical elements. If properly digested, the sludge has little odour and is relatively free of pathogens. Sludge is generally considered as a slow-release fertilizer. The use of digested sludge to ameliorate spoils has been proven. Three years' use of digested sludge on corn land has resulted in increased grain yields and no visual toxic symptoms to the plants. The incorporation of the first year's sludge and plant residues resulted in a decrease in metal concentrations in the leachate water. Application of excessive amounts of digested sludge on cropland results in soil nitrate accumulations and possible groundwater contamination. The lagooning of digested sludge reduces the N content to about 2.6%. This allows an increase in the safe application rate to the soil and provides additional decay time for possible pathogens in the sludge. Almost 1.8 billion t of animal waste are generated in the USA annually by livestock and poultry. This waste, primarily feces and urine, although highly variable in composition, contains about 3 kg N, 2 kg P, and 3 kg K/t of wet weight; it also contains numerous trace elements needed by plants and organic matter that improves many soils. The maximum amount of manure that can safely be applied to land is determined by composition of manure, frequency of application, soil, rainfall or quality of irrigation water, and type of crop. Much research has been done with application of manure in quantities ranging from 4.5 up to 45 t/ha. These results can be used only to a limited extent in predicting maximum loading of land with animal waste for optimum crop production and maintaining environmental quality. Disease organisms of animals and humans in wastes must be watched carefully. Most disease organisms are generally destroyed in the holding of waste. Weed infestations may be a problem with the application of animal waste to soil. Tremendous quantities of plant nutrients are in the human and animal wastes produced in this country. In the conservation of resources, workable methods of applying maximum amounts of wastes to land with the least cost and still maintaining environmental quality would be highly desirable.

sludge; wastewater; USA; fertilization; odours; pathogens; animal wastes

Recycling: Utilization for Agriculture. Public Health Engineering Dept., College of Engineering. India. 8-1 to 8-18. 10-14 March 1975. 3 tables.

A review of public health hazards associated with the use of raw and undiluted sewage for crop irrigation is given. Data from India clearly indicate higher infection incidences in sewage farm workers than in the control population. The author suggests a 2-week interval between sewage irrigation and harvesting to yield vegetables free from enteric pathogens. Another effective method of decontamination is by immersing the vegetable in warm water at 60 °C for 10-30 min.

public health; sewage; irrigation; India; pathogens; decontamination

4405 Sebastian, F. B.
Envirotech Corporation, Menlo Park, Calif., USA

Waste treatment in China ... ancient traditions and high technology. *Ambio*. Norway. Vol. 1(6). 209-216. December 1972. 4 figures. 17 references.

This is a report of some methods of treating wastes as practiced in China. While old traditions of night-soil collection and recycling to agriculture and fishponds are still followed, Western technology is applied in industrial waste treatment. The author also discusses some health and economic aspects related to pollution control.

China; night soil; agriculture; fertilization; fishponds; wastewater; health; economics; night-soil collection

4406 Shuval, H. I.
Environmental Health Laboratory, The Hebrew University-Hadassah Medical School, Jerusalem, Israel

Public health considerations in wastewater and excreta re-use for agriculture. In Feachem, R., McGarry, M., and Mara, D., eds., *Water, Wastes and Health in Hot Climates*. A Wiley-Interscience Publication. U.K. ISBN 0-471-99410-3. Chap. 19. 365-381. 1977. 1 photograph. 1 table. 2 figures. 32 references.

□ The use of human excreta or night soil for crop fertilization has been widely practiced for years in many regions of the world. Although the improvement in soil productivity is of vital importance, the health risks caused by disease transmission to farm workers or to consumers of vegetable crops eaten raw must be carefully considered. There are various species of pathogenic microorganisms present in human excreta or municipal wastewater and most conventional treatment processes can only partially remove such pathogens. Some of these organisms have also been reported to survive a long period of time in the fields and crops irrigated with sewage. The author recommends a balance approach such as combining low-cost waste-treatment methods capable of providing reasonable reductions in pathogen levels with restricted irrigation to crops that present a low level of

health risk.

excreta; health; diseases; crops; agriculture

4407 Williams, G. B.
Sewage disposal in India and the Far East. Thacker, Spink & Co. India. X + 230p. 1924. Chap. 4. Simple methods of sewage disposal; Chap. 7. Septic tanks; Chap. 10. Sewage irrigation; Chap. 14. Domestic sewage disposal.

The Indian practice of sewage and night-soil treatment, before 1924, is described. Dumping depots, connected to the sewerage system, are recommended for night-soil bucket collection schemes in partially sewered cities. Aqua-privies, improved latrines, and septic tanks for both town and household wastes are described. The use of sewage effluent for agricultural irrigation is discussed with particular reference to the sewage irrigation works at Dacca.

India; sewage treatment; excreta; irrigation; septic tanks; aqua-privies; disinfection

4408 Hu-nan Chung i Yoa
Yen Chiu So
Ko Wei Hui

A barefoot doctor's manual, the American translation of the official Chinese paramedical manual. Running Press, Philadelphia, Pennsylvania. 1977. Reprint of 1974 edition published by the U.S. Department of Health, Education and Welfare. 36-37.

Excreta management is a measure designed to curtail multiplication/propagation of flies and for eliminating/killing disease-causing bacteria and parasite ova. Collected feces and urine are stored in pits and are kept under cover for 15 days in summer or up to 30 days in winter. In schistosomiasis endemic areas, feces and urine may be mixed in a proportion of 1:7, whereby the ammonia produced by the urine may be used to kill the *Schistosoma* ova. For composting manure, animal feces and human feces are mixed with agricultural waste.

excreta; bacteria; night-soil collection; composting; animal wastes

4409 Julius, D.
Energy, Water and Telecommunication Department, World Bank, Washington, D.C.

Urban waste an economic good (bad?). Sanitation in Developing Countries Today. A conference sponsored by Oxfam with the Ross Institute of Tropical Hygiene. 5-9 July 1977. Pembroke College, Oxford, p. 6. 1 reference.

This paper briefly reviews the theory of inferior goods, presents an admittedly limited amount of empirical support for placing urban waste within that category, and discusses the practical implications of such a view. With the general demand behaviour of inferior goods in mind, whether or not urban waste

seems to belong to this class is examined. The case is further analyzed on a comparative basis where study of this topic is carried out at two levels: first, a look at consumer behaviour across countries that differ in per capita income; Japan, Korea, and Taiwan are taken as case studies. Second is the consideration of patterns over time within a single country. It is concluded that if urban waste is indeed an inferior good, countries with relatively low per capita incomes are likely to be more susceptible to the spread of low-cost reuse technologies.

economics; Japan; Korea; Taiwan; technology

4410 Milivoj, P.
Faculty of Engineering, University of Zabreb,
Yugoslavia

Utilization of night-soil, sewage and sewage sludge in agriculture. Bulletin, World Health Organization. no. 10. 207-228. 1954. 49 references.

The author reviews the agricultural use of night soil, sewage, and sewage sludge from two points of view: the purely agricultural and the sanitary. Knowledge of the chemistry and bacteriology of human fecal matter is still rather scant, and much additional work has to be done to find practical ways of digesting night soil in a short time into an end product of high fertilizing value free of pathogens, parasites, and weeds. More is known about sewage and sewage sludge, but expert opinion is not unanimous as to the manner or value of their use in agriculture. The author reviews a number of studies and experiments made in many countries of the world but concludes that the chemistry, biology, and bacteriology of the various methods of treatment and use of waste matter need further investigation.

sewage; agriculture; reuse; excreta

4411 Scott, J. C.
Health and agriculture in China. Faber and Faber Ltd., 24 Russell Square, London, England. 1954. 29 tables. 14 figures. 24 illustrations. 149 references.

From time immemorial, the Chinese farmer has practiced the conservation of all human wastes for use as fertilizer. There was no evidence available on how much it cost in terms of ill health and loss of human life because although their principles were good, in reusing the night soil, their methods were nonhygienic. This book studies the issue of night soil reuse from two sides: health and agriculture. Part one of the book describes methods of disposal of feces, both in cities and in the country. The connection between these methods of disposal and the spread of fecal-borne diseases is suggested. Part two of the book reports the attempts that were made to solve the above problem at Cheeloo University, North China, between 1932 and 1941. The results of field experiments that were carried out under the guidance of Professor Winfield are also documented

China; agriculture; composting; fertilization; excreta

4412 van Vuren, J. P. J.
Soil fertility and sewage. Faber and Faber, 24 Russell Square, London, England. p. 236. 1948. 28 illustrations. 2 appendices.

This book is a detailed account of the composting process as carried out in Ficksburg and a few other places in South Africa. No unpleasant odours are given off when the process of composting is carried out correctly; it is advisable nevertheless to consider the direction of prevailing winds when selecting a site. It is also advisable to erect the pits on a gentle slope so as to facilitate the handling of the night soil. Ample space should be allowed for possible future expansion. The method by which compost is made from urban wastes, including night soil or crude, settled sludge (in the case of a waterborne sewage system) is best carried out in specially constructed pits. The success here depends chiefly on factors such as the availability of sufficient quantities of suitable organic residues, thorough aeration, and drainage. To facilitate the latter requirements, channels are constructed in the floor of each pit. All surplus liquid from the various pits drain into a main channel. During the active fermentation period, or during hot windy weather, the contents of pits generally become too dry, for optimum results, so that the addition of moisture becomes necessary. This affluent is then used with advantage for this purpose. In regard to the method of charging the pits, it is essential that: a correct ratio between the quantity of dry refuse and night soil be maintained; materials reach the compost site in a fairly homogeneous state (instead of dumping this mixture directly into a pit, it should be screened through a sieve of ½-inch (1.27-cm) mesh); if dry enough, the coarse material left on the sieve be dumped into a pit, raked into a layer of 12-15 inches deep (if not dry enough, it should be air dried); the bottom be arranged as well as subsequent layers of dry refuse in such a way as to allow the night soil to gradually flow over the contents, thus allowing time for more efficient absorption (a 12-inch (ca. 30.5 cm) fall over a 30-ft (ca. 9 m) pit was found to be sufficient). After the bottom layer is ready with the dry mass, night soil should be discharged from the top end of the pit. After about an hour, the night soil layer should be given a good sprinkling of materials such as fine wood ash, loamy soil, or ground limestone. Before each charge of night soil is given, similar layers of dry refuse are arranged. This procedure is continued until the pit is filled, within 3 days. On the fifth day after the charging has been completed, the contents of the pits are turned, which apart from promoting aeration, mixes various ingredients thoroughly and, in addition, helps destroy fly eggs and larvae. After another 5 days, contents are turned a second time. During winter it is not necessary to turn the contents of the compost pit twice, but during summer months, the number of turnings should be dictated by the presence and stage of development of larvae. It is seldom necessary to keep the material in a compost pit for more than 30 days. The contents are then transferred from the pit to the ripening floor, a hard-surfaced floor covered with a rain shelter. Here

the compost is allowed to ripen in neat stacks, for a period of about 4-6 weeks. The number and size of pits should be determined by the quantity of town refuse and night soil available. It is very important to have enough pits so that when the last pit is filled, at the end of the month, the first one must again become empty and ready for the next recharge. It is advisable to have one or two extra pits. A suitable length of pit is 30 ft (ca. 9 m) for medium-sized and larger urban areas and 12-18 ft (ca. 3.5-5.5 m) for smaller centres. Instead of increasing the length of pits for a population above 3000, it is better to increase the number of pits.

soils; urban; flies; temperature; sludge; excreta; South Africa; fertilization

4.5 Biogas

4501

Central Public Health Engineering Research Institute, Nagpur, India

Nightsoil digestion scheme for Delhi Cantonment Board. Special Report (Consultancy) to Delhi Cantonment Board. India. 6p. May 1974. 1 drawing.

This is a consultancy report recommending an anaerobic-digestion oxidation pond, sludge-drying bed system for treating night soil from 30 000 people in the Delhi Cantonment Board area. The area is served by a dry conservancy system but 6000 gal / day (27 276 litres) of night soil containing some urine and ablation water has been designed for. To handle a future population of 40 000, a 24-m diameter, 4.5-m liquid depth digester was designed for batch feeding every half hour with homogenized night soil. Overflow is displaced to two oxidation ponds, 55 X 1.5 m, in series and digested sludge is drawn from the digester every 5-6 days and dried on four 10 X 6 m drying beds. About 850 m³ / day of digester gas is expected to be generated, containing 550 m³ / day methane, with estimated fuel value of 140 000 rupees / year (1974). Dried sludge cake, at a rate of about 1.5 t / day with moisture content 50%, is expected to be sold as fertilizer for 20 000 rupees / year (1974). A scale drawing of the installation is included in the report.

night-soil disposal; conservancy systems; anaerobic digestion; biogas; oxidation ponds; sludge drying; India; urban

4502

Economic and Social Commission for Asia and the Pacific, New York, USA

Report of the preparatory mission on bio-gas technology and utilization (RAS 74 041 A 01 01). Proceedings of ESCAP Workshop on Biogas Technology and Utilization. Philippines. 146p. 8 May 1975. 7 tables. 14 figures. 74 references.

A report on biogas technology and utilization based on information gathered in India, Japan, Pakistan, the Philippines, the Republic of Korea, and

Thailand is given. It principally relates to the treatment of animal and agricultural wastes with gas production through anaerobic digestion. Designs from the various countries are given and technological, economic, and social aspects discussed. An integrated approach is needed, utilizing the liquid effluent for growing algae and raising fish and duck, together with gas use in cooking and lighting.

anaerobic digestion; night-soil treatment; biogas; design; Asia

4503

J.D. & D.M. Watson, Singapore

Treatability of nightsoil. Master Plan report prepared for the Ministry of the Environment, Government of Singapore. Bukit Timah Area: Sewerage and Sewage Treatment. Singapore. Vol. 2. Appendix L. L1-L3. March 1974. 2 figures.

Experiments carried out in Singapore show that maximum gas production was obtained when 1 part of night soil was digested with 4 parts of crude primary sewage sludge. Consolidation (thickening) of the night soil before digestion was advised to remove some of the water used to wash out the night-soil buckets, this water being passed to the main sewage treatment works for full treatment.

Singapore; night-soil treatment; sludge

4504

Revolution Committee, District of Mien Chu, Province of Szechwan, China

Excreta removal from the middle layer of a fully enclosed type biogas plant (tank). In "Compilation of data on experience and sanitary management of excreta and urine in the village." Unpublished report of the International Development Research Centre. Canada. Translated from Chinese by Lee Thim Loy. 55-65. November 1976. 12 tables. 18 figures.

■ This article is the most descriptive of several compiled to illustrate rural practices of excreta and manure treatment and reuse at the village level in China. The biogas plant is extensively described as comprising six parts: (1) the inlet chamber that daily receives human excreta (10%), animal feces (30%), crop stalks (10%), and water (50%); (2) the rectangular or circular fermentation tank used to store the wastes during fermentation; (3) the fixed-top gas-storage tank providing space for gas accumulation; (4) the outlet chamber receiving digested wastes from the fermentation tank at its middepth; (5) the slurry displacement tank located on top of the fixed gas-storage tank that is used to store excess slurry as the gas accumulates; (6) the gas vent pipe and ancillary equipment. This biogas plant design, which is extensively used in China, offers an outstanding advantage of employing a fixed gas-storage tank. Unlike other designs used primarily in Korea and India, the gas tank is made of concrete and fixed in place. As biogas is produced by digestion of the wastes

it accumulates under the inverted gas holder, forcing the liquid level in the fermentation tank downward. The equivalent volume of slurry is displaced moving through the outlet chamber and on top of the fixed gas-storage tank where it is stored in what is called the slurry-displacement tank. As gas is used in the household, the displaced slurry returns to the outlet chamber. Full details of design, construction, testing, operation, and repair are given. Safety requirements, and in particular safety values, are described. The designs of an earthenware biogas cooker and lamp are also given. The biogas plant's capacity to destroy bacterial pathogens and parasitic worms was investigated. Samples were drawn from the influent, the tank bottom, and the bottom and top of the outlet chamber. Total parasite eggs (including *Schistosoma*, *Ascaris*, and hookworm) were counted; it was determined that there was 94% egg removal in the effluent compared to the influent. It is emphasized, however, that the effluent still contained over 1500 parasite eggs per 100 ml; this was due to the fact that there were over 23 000 eggs / 100 ml in the influent. The hookworm die-off was both rapid and effective. The reduction in levels of disease-causing organisms is due both to the physical separation of the organism by its settling to the bottom of the tank and to its natural die-off in the tank under adverse growth conditions. Certainly, the major contributing factor to their reduction in the case of the hardier parasite eggs is that of physical separation. In one experiment an improvement of the plant's effluent storage chamber and point of effluent removal from the tank clearly indicated an improvement in total parasite egg reduction from 80% to 98%. (Original paper written in Chinese.) (Now available as IDRC-TS8e, "Compost, fertilizer, and biogas production from human and farm wastes in the People's Republic of China.")

China; biogas; rural; construction; pathogens; digesters

4505

Committee for the Assessment of the Cost-Benefit Effects of Cow-Dung Gas Plants, Indian Council of Agricultural Research, New Delhi, India

The economics of cow-dung gas plants. A report by the Indian Council of Agricultural Research. India. 66p. First printed April 1966. 18 tables. 2 figures. 28 references.

A survey was done of 133 cow-dung biogas plants at various rural locations in India for the purpose of cost-benefit assessment and identifying necessary measures to gain more public acceptance of the system. It is concluded that there will be a return of approximately 2.5-5 rupees (1966) for every rupee invested in a 100 ft³ (ca. 2.8 m³) gas plant, and as benefits increase with the size of the plant, payback for capital investment is possible in about a 4- to 6-year period. Some of the major problems inhibiting widespread adoption of the system are also discussed.

cow dung; biogas; India; cost-benefit; public acceptance; investments; rural

4506

Florida, N.

Small-scale bio-gas plants. Unpublished report. Appropriate Technology Series. 45p. December 1973. 17 figures. 7 tables. 7 references.

This is a general discussion based on observations of Indian experiences in rural biogas installations. The general conclusions are that biogas plants are rather too expensive for widespread use, the corrosion and cost of the steel gas cap remains an unresolved problem, and the dehydration of sludge during monsoon periods is problematic. Standardization of digester designs and public education is called for.

India; biogas; rural; economics

4507

Fry, L. J.

Practical building of methane power plants for rural energy independence. Standard Printing. USA. 96p. 1974. 53 figures. 73 references.

□ This book describes early work done by the author in developing practical batch-loaded and displacement methane digestors on a South African farm. Raw materials, digester design and operation, sludge reuse, and gas and gas usage are described.

rural; biogas; South Africa; design; construction

4508

Hanumanulu, V.

National Environmental Engineering Research Institute, Nagpur, India

Community waste treatment and utilization for rural areas. Unpublished manuscript. 21p. 1977. 7 tables. 5 figures. 9 references.

A review of possible application of the biogas system for digestion of night soil from communities of 100-2000 is given. The design of a system, including homogenizer, night-soil digester, two stabilization ponds for liquid effluent, and sludge-drying beds for digested sludge, is given. Capital and operating costs for such a system are presented for different populations in the range mentioned. A community latrine and night-soil digestion scheme is outlined and estimated to cost about 90 000 rupees (1977) in India for a population of 1000.

sewage treatment; biogas; night-soil disposal; India; design; economics

4509

McGarry, M. G.

International Development Research Centre, Ottawa, Canada

Domestic wastes as an economic resource ... biogas and fish culture. In Feachem, R., McGarry, M., and Mara, D., eds., "Water, Wastes and Health in Hot Climates." A Wiley-Interscience Publication. U.K. ISBN 0-471-99410-3. Chap. 18. 347-364. 1977. 1

photograph. 4 figures. 24 references.

The treatment and reuse of domestic wastes through biogas and fish culture have been employed by several countries in Asia. This chapter described general processes of the biogas and fish culture, including their methods of construction, operation, and maintenance. Cost-benefit analyses of the biogas plant are favourable as the end-product gas can be used for heating and cooking while its effluent slurry is suitable for use as fertilizers. Increases in fish production in fish ponds receiving sewage are evident. Some public health aspects of these two systems are discussed.

domestic; treatment; reuse; biogas; cost-benefit; public health; Asia; aquaculture

4510

Moulik, T. K.
Srivastava, U. K.

(Both) Centre for Management in Agriculture,
Indian Institute of Management, Ahmedabad,
India

Bio-gas plants at the village level — problems and prospects in Gujarat. Unpublished report. Centre for Management in Agriculture. Indian Institute of Management. India. 149p. November 1975. 27 tables. 5 figures. 19 references.

An investigation of 199 rural biogas plants in Gujarat, India, with reference to socioeconomic and operational problems is reported. Investments in biogas plants of all sizes are found to be economically viable, but economies of scale are obtained with the larger-sized plants for richer households. The authors propose community gas plants as a means of solving these problems and suggest strong cooperation from major organizations to make the program a success.

rural; biogas; socioeconomic; investments; India; economics; community; households

4511

Mudri, S. S.

Central Public Health Engineering Research
Institute, Field Unit, Poona, India

Some observations on the anaerobic digestion of nightsoil. Environmental Health. India. Vol. 9(2). 133-136. 1967. 2 tables. 1 figure. 3 references.

This is a report of a study of the performance of a night-soil digester at St. Joseph Technical School, Nagpur, serving four latrines. Digester influent and effluent analyses were tabulated showing a highly variable performance, from 29 to 93% reduction in volatile solids for a detention time of 60 days. Gas production was 1.2 ft³ / lb of wet night soil and this was used as fuel for cooking in the kitchen of the school hostel.

excreta disposal; anaerobic digestion; biogas; India; rural

4512

Nagar, B. R.

Indian Agricultural Research Institute, New
Delhi, India

Biogas plants based on night soil and/or animal dung. World Health Organization International Reference Centre for Waste Disposal. Dübendorf, Switzerland. IRCWD News. No. 8. 4p. June 1975. 1 figure.

A description of an Indian biogas plant, principles, construction, operation / maintenance, and uses of the gas are given. About five livestock units or 60 persons are required to provide sufficient raw materials for a plant having a 2-m³ gas holder. Methods of stimulating gas production in winter are also suggested, such as the addition of cattle urine, powdered leaves and(or) wheat straw, to the digester.

biogas; construction; maintenance; digesters; rural; animal wastes

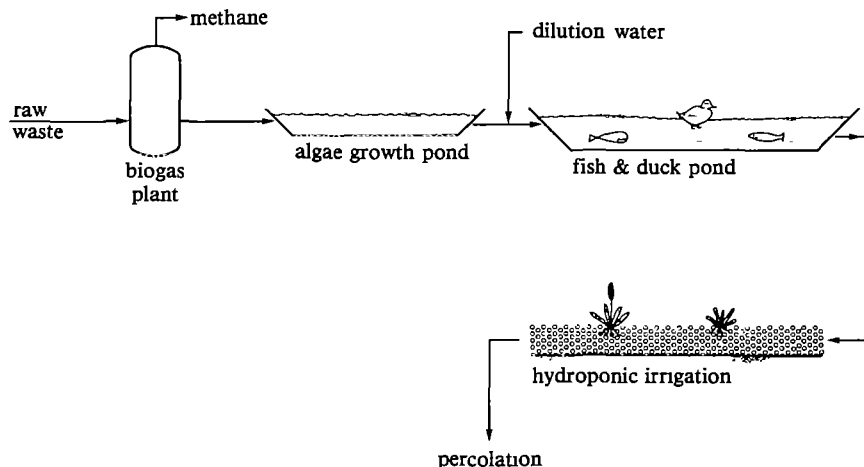

Integrated waste-disposal system (from 4509).

- 4513** Oswald, W. J.
Public Health and Civil Engineering Dept.,
University of California, Berkeley, Calif., USA
Gas production from microalgae. Presented at the
Institute of Gas Technology Symposium, "Clean
Fuels from Biomass, Sewage, Urban Refuse and
Agricultural Waste." USA. 14p. 29 January 1976. 3
figures. 2 tables. 7 references.
A description of a methodology of methane
production from integrated solid wastes and algal
biogas facility, in which dry wastes could be used to
generate power, release CO₂ for algae, and heat the
algal digesters is given. Economic analyses of the
system reveal its feasibility and the author discusses
some crucial research areas that need to be carried out
for the maximization of algal harvesting.
algae; digesters; economics; solid wastes; biogas
- 4514** Pfeffer, J. T.
Dept. of Civil Engineering, University of
Illinois, Urbana, Ill., USA
Reclamation of energy from organic waste. Report
No. EPA-670 / 2-74-016. U.S. Environmental Protec-
tion Agency, National Environmental Research
Centre, Office of Research & Development. 142p.
March 1974. 45 tables. 27 figures. 48 references.
A study of methane production from an anaerobic
fermentation of a mixture of organic shredded refuse
and raw sewage sludge is reported. The experiments
were carried out in the laboratory at temperatures
ranging from 30 to 60 °C, and parameters evaluated
included the quality and quantity of gas produced, the
rate of gas production, percentage solids reduction,
nutritional requirements, and operating problems.
These results, together with other published cost data,
indicate that methane can be produced and sold at a
price that is competitive with the current energy costs
in the United States.
*anaerobic digestion; shredded refuse; sewage; biogas;
sludge; temperature; nutrients; costs; USA*
- 4515** Prasad, C. R.
Prasad, K. K.
Reddy, A. K. N.
Bio-gas plants ... prospects, problems and tasks.
Economic and Political Weekly. India. 1347-1364.
August 1974. 4 tables. 5 figures. 63 references.
Biogas plants are reported to be capable of
fulfilling a demand for small-scale electricity and
fertilizer. For a village of 500 persons and 250 cattle,
the biogas-energy production is claimed to be the
equivalent of 667 kilowatt-hours per day with the
organic manure by-product of about 295 t per year.
However, the author points out some socioeconomic
problems and further tasks for research and
development that need to be carried out to gain more
public acceptance of the system.
biogas; fertilization; socioeconomic; rural; animal
- wastes; energy*
- 4516** Pyle, D. L.
Dept. of Chemical Engineering and Chemical
Technology, Imperial College, London, U.K.
**Technical options in anaerobic digestion — a
background paper.** Unpublished report prepared for
the International Development Research Centre.
Canada. 146p. November 1976. 84 references.
This is a general review of the state-of-the-art in
biogas technology based on existing literature.
Possible directions for future research are in reducing
the capital cost of the plant; it is emphasized that in
the biogas field at this time, good engineering is more
important than "research." The implications of
alternatives (fuel sources, designs, loading rates, etc.)
in assessing biogas technology are emphasized.
*biogas; economics; analysis; digesters; mathematical
models*
- 4517** Pyle, D. L.
Fraenkel, P.
(Both) Intermediate Technology Development
Group, London, U.K.
Methane. Proceedings of a one-day seminar. Inter-
mediate Technology Publications Ltd. U.K. 51p.
1975.
Twelve short papers covering three main areas of
discussion are contained in this report, covering
theoretical and practical aspects of methane gener-
ation and early methane generator designs; problems
faced in the research, development, and marketing of
methane generators; and the potential application of
methane generation in rural communities with
particular reference to developing countries.
*biogas; anaerobic digestion; sewage sludge; rural
excreta; agriculture*
- 4518** Ramaprasad, T. N. C.
Srinivasan, M. V.
Shanta, S.
(All) National Environmental Engineering Re-
search Institute, Nagpur, India
**An integrated system of treatment and disposal of
nightsoil with an emphasis on by product utilization.**
Paper presented at the seminar on utilization of farm
wastes for rural industrial growth. National Dairy
Research Institute. India. 12p. 31 December 1975. 2
tables. 11 references.
A report on experimental digester studies with
night soil and cow dung and pilot plant digestion of
night soil of Nagpur Central Prison is given.
Laboratory oxidation pond studies on digester
supernatant are reported. Results of a laboratory
study of survival of hookworm and *Ascaris* ova in
night-soil digestion are presented.
excreta disposal; night-soil treatment; anaerobic

digestion; biogas; India; oxidation ponds; hookworm; Ascaris

4519 Sathianathan, M. A.
Association of Voluntary Agencies for Rural
Development, New Delhi, India

Bio-gas — achievements and challenge. Published by Association of Voluntary Agencies for Rural Development, India. 192p. First edition June 1975. 16 chapters. 201 references.

This book concerns various aspects of biogas commonly in practice in India. It includes a historical survey of biogas from 1951 to the present, and a detailed explanation of the formation, production, and use of the biogas. The performance of a number of biogas plants in the country is surveyed, from which an economical analysis reveals that capital cost on these plants can be paid back within a short period. The study also reports that community plants in villages can provide power to at least two small industries in each village. A number of research and development problems concerning the future of biogas are discussed.

India, biogas, historical aspects; economics

4520 Singh, R. B.
Biogas plant — designs with specifications. Gobar Gas Research Station, India. 49p. 1973. 49 drawings.

A collection of blueprints for 21 biogas plants of various sizes, ranging from a 100-ft³ (ca. 2.8-m³) per day family size to a 4000-ft³ (ca. 113-m³) per day plant.

India; biogas; design

4521 Singh, R. B.
Bio-gas plant — generating methane from organic wastes. Gobar Gas Research Station, India. 104p. 1974. 23 drawings. 19 references
□ A practical handbook for the design, construction,

and operation of small-scale rural biogas plants based on the author's experiences. A short history of the development of biogas is followed by a detailed discussion of operation techniques: loading, ingredients, and temperature control. The construction procedures for a number of specific designs, ranging from family size to community scale, are described.

biogas; design; construction; India; animal wastes; energy; rural

4522 Singh, R. B.
Indian Council of Agricultural Research, New
Delhi, India

The bio-gas plant — generating methane from organic wastes. Compost Science. USA. Vol. 13. 20-25. January / February 1972. 2 tables. 3 figures.

A description is given, based on the author's experiences in India, of how to design, operate, and maintain a biogas plant. Both single and double-stage digesters for small-scale (less than 500 ft³ (ca. 14 m³) of gas produced per day) and large-scale plants are discussed including methods of gas collection.

India; biogas; design; maintenance; digesters; biogas

4523 Singh, R. B.
Indian Council of Agricultural Research, New
Delhi, India

Building a bio-gas plant. Compost Science. USA. Vol. 13. 12-16. March / April 1972. 1 figure. 1 table.

Construction techniques of five types of biogas plants in many areas of the world are described. The author claims successful operation of all the systems and intends to provide the reader with an idea of different levels of technology and scales of the plants that he can choose from.

construction; biogas; technology

4524 Srinivasan, H. R.
Khadi and Village Industries Commission,

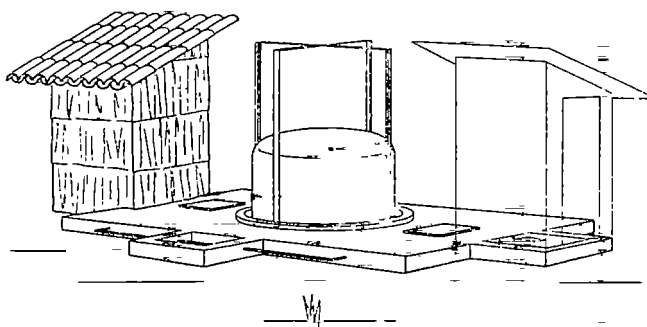

The excreta-fed biogas plant (from 4520).

Bombay, India

Gobar-gas plants: promises and problems. Indian Farming. India. Vol. XXIII(11). 29-33. February 1974.

A brief review is given of the application of anaerobic digestion of village wastes in gobar gas plants, including their social effects and economic impact. Some problems of this system are discussed and possible solutions suggested. Future plans of the Khadi and V.I. Commission for installing gas plants are mentioned.

night-soil disposal; anaerobic digestion; biogas; India; rural sanitation

4525 Subrahmanyam, P. V. R.
National Environmental Engineering Research Institute, Nagpur, India

Digestion of night soil and aspects of public health. Paper presented at Workshop on Biogas Systems. The Management Development Institute. India. 21p. 1977. 5 tables. 3 figures. 19 references.

A progress report on the NEERI research on anaerobic digestion of feces from the Nagpur prison is given. Laboratory and pilot-plant studies are reviewed. The pilot plant has been in operation for 1½ years, and at an organic loading of 2.6 kg volatile solids (VS) / m³ day the VS destruction was more than 50% and the gas generated was 0.448 m³ / kg VS added. The gas contained 60-65% methane and 0.05-0.1% H₂S. Details of the digester and layout of the unit with stabilization ponds and sludge-drying beds to serve a community of 1000 are given.

rural sanitation; night-soil treatment; biogas; anaerobic; India

4526 Subramanian, S. K.
Management Development Institute, New Delhi, India

Biogas in Asia. Unpublished report. International Development Research Centre. Canada. 97p. November 1976.

■ Biogas plants have found their greatest popularity in Asia where the number of installed plants has increased remarkably over the past two decades. This report was written as a background paper for a meeting on the social and economic evaluation of the biogas plant held in Sri Lanka and sponsored by the International Development Research Centre. It covers the historical development of biogas plants in India and present practices involving their use in India, South Korea, the Philippines, Thailand, Indonesia, and Japan. The report also discusses dominant social and economic issues related to the biogas plant in each country; problems of data collection and gaps in information; and finally the various technical approaches being used within the region. There are over 36 000 plants in India, nearly 27 000 in Korea, 100 in the Philippines, and 225 in Thailand. Success in their continued operation is varied and affected by numerous interrelated factors. In India, most plants

are fed by cow dung although a significant percentage (particularly in the State of Harayana) are connected to toilets for direct feeding of human excreta. The gas is used essentially for cooking; the fertilizer slurry effluent is most often introduced into drying beds for later application to the land or into composting pits that utilize other forms of agriculture waste, and refuse. Adverse climatical conditions during the Korean winter limits the biogas units' effective use to the warmer months. Most are operated only with cattle and pig dung although toilets are attached to the digester in some cases. The digesters are insulated with rice husks to improve winter gas production rates; the gas collector dome is PVC, and thus less expensive than the conventional Indian dome made of painted steel. The effluent slurry is most often used on the land without prior desiccation. Although India has standardized its biogas plant design through its implementing agency (The Khadi Village and Industry Commission) there are many variations being used in Asia including horizontal and vertical units made of both flexible and rigid materials and operated under continuous, intermittent, and batch-loading conditions. The report briefly describes the numerous attempts to use different locally available materials, to build plants in different ways to different designs, to find locally suitable methods of using the gas outputs or to experiment with using the effluent slurry. Subramanian notes that, in contrast to the impression given by official publications on the subject, a wide diversity in designs and practices exists in Asia and warns that the emphasis on uniformity may seriously reduce the potential usefulness of the technology. Several international agencies have recently become interested in the biogas plant as an "appropriate technology." In particular, ESCAP and UNEP have become actively involved in projects while UNIDO, UNDP, UNICEF, WHO, The World Bank, and IDRC are interested, the latter two, particularly, in the plant's technical, social, and economic evaluation. Demand or motivational aspects are reviewed. The dominant motivation for adopting biogas plants varies between and even within countries. The gas as used for cooking does, however, appear to be the primary benefit with the manurial value of the slurry often being given only marginal emphasis. The more hidden benefits related to public health and deforestation are recognized only by the governments that provide grants or soft loans (but decreasingly so) to individuals interested in installing biogas units. The author stresses that the perceived manurial value of the slurry may be more substantial than is commonly assumed. Not only do some people value the manure, which was previously burnt, others value the composting of other waste materials with the digester's slurry. The perception of these advantages, other than the availability of gas household use, could increase in the future. Again, as perceived, benefits vary from country to country; so do problems with propagation and operation of the units. In particular, extension services vitally needed for maintenance and repair are often lacking; likewise credit facilities are commonly cumbersome. One fact that is common to most

situations where the plant is individually owned is that the biogas plant is adopted by and benefits the wealthier farmer as the landless labourer or tenant has neither the required capital to construct nor animals to feed the system. Water and land also pose problems where they are not readily available; in particular, the land required for slurry drying or composting has a high opportunity cost in urban or peri-urban situations. Use of night soil or human excreta in the biogas plants is resisted for religious and psychological reasons in many locations. However, over 30% of the units in Harayana are attached to toilets; in the opinion of many, the psychological inhibitions are bound to die in the course of time. Serious strong resistance would likely be encountered in Thailand and the Philippines but in Indonesia such would not likely be the case as human waste is already used to feed backyard fishponds. Although institutional plants connected to agroindustries or schools are operating successfully in many parts of Asia, successful communal plants are rare, and indeed nonexistent in India. Communal plants such as may be attached to cooperative movements require strong, honest, and dedicated leadership in overcoming the inherent problems of distribution of construction costs, operating responsibilities, contributions of wastes, and use of the gas and slurry products. Evaluating the biogas plant is complex and site specific; in particular, great variations and a dearth of basic information exist with respect to the capital costs of the biogas unit, costs of land, the dung produced by animals, seasonal fluctuations on demands, availabilities and values of resource, inputs and products, product yields, etc. With respect to the plants design and operation, wide variations exist in loading but the normal practice in India is to load 1.6-2 kg volatile solids per cubic metre of digester volume per day (kg/m-day). The general concept of maximum loadings is 2-3 kg/m-day within the mesophilic temperature range, and 5-6 kg/m-day within the thermophilic. Considerably higher loadings are reported from research findings in Japan. Detention periods are normally 50 days in India but this can be reduced to 20-40 days as practiced in the Philippines. Variance of opinion exists on the minimum number of animals that are required to feed the smallest viable plant. Although a minimum number of five cattle are stipulated to support even a 60-ft³ (ca. 1.7-m³) plant, such units have been found to operate successfully on two cattle, a buffalo, and a calf, or even one animal and an attached toilet. The dung produced by animals varies widely with the breed of animal. For example, a cow in Kerala may yield 4 kg of dung a day, whereas a well-fed buffalo in Harayana may produce up to 30 kg daily. As a result of over-standardization and application of criteria over widely varying conditions, the potential of biogas systems may be constrained. The author emphasizes the need for site-specific socioeconomic evaluations, development of less expensive gas holder and digester designs, gas burners with higher efficiencies, improved modes of by-products use, increased efficiencies of digestion, the compiling of the biogas system with other noncon-

ventional energy sources, and its use in agroindustrial wastes treatment. (Now available as IDRC-103e, "Biogas Technology in the Third World.")

India; biogas; rural; household; community; economics; public opinion; energy; construction; agriculture; customs; Korea; Philippines; Thailand; Indonesia; Japan

4527 Subramanian, S. K.
Ganesh, S.

Biogas technology — performance and prospects in India. Unpublished report NCST / SG / GG-74. National Committee on Science and Technology. India. 28p. December 1974. 22 references.

This is a short discussion based on observations of Indian experiences with biogas plants in rural areas. It is felt that the two main problems retarding wider use of biogas are the lack of organization in installation and maintenance procedures, and the actual cost of the plant.

India; biogas; rural; economics

4528 Tennakore, L.
Jayawardena, J.
Wijesekerna, B.

Biogas — why and how? Industrial Development Board of Ceylon. IDB-684. 13p. July 1976. 3 diagrams.

A short discussion of biogas technology is followed by a description of a biogas generator design developed in Sri Lanka, and Lakgen, which eliminates the metal floating gas cylinder and replaces it with an all-masonry unit.

Sri Lanka; biogas; design

4529 Trevelyan, W. E.
Tropical Products Institute, London, U.K.

The methane fermentation ... a discussion paper. Tropical Science. U.K. Vol. 17(4). 193-209. 1975. 66 references.

The current status of scientific and technological studies of the anaerobic (methanogenic) fermentation is summarized. The process of the formation of methane through anaerobic fermentation is not as well understood as other major industrial fermentations, because of the difficulty in isolating and culturing pure strains of the highly oxygen-sensitive methanogenic bacteria, and of lack of knowledge of the biochemical pathways leading to the formation of methane.

anaerobic digestion; theory; biogas

4530 Snell, J. R.
U.S. Engineers, Repairs and Utilities Division,
Boston, Mass., USA

Anaerobic digestion, II. Nitrogen changes and losses

during anaerobic digestion. Sewage Works Journal. Vol. XV. 56-70. Jan-Dec 1943. Published by the Federation of Sewage Works Association. 5 figures. 3 tables. 12 references.

This paper describes special experiments devised to study the changes and losses of nitrogen from human excreta under anaerobic digestion. The results of the experiments are in perfect accordance with the theory that, in the limited conditions in which no oxygen is present, nitrogen cannot be evolved as a gas unless it is present in the form of nitrate or nitrite. When present in this form, however, a large percentage may break down into N_2 , N_2O , and NO gases, and the remainder may be reduced to ammonia. A review is given of literature that claims that nitrogen is lost during anaerobic digestion, and explanations of probable errors are pointed out that adequately account for the contrary results. A few practical applications are also pointed out.

nitrogen; excreta; anaerobic digestion

4531 Snell, J. R.
U.S. Engineers, Repairs and Utilities Division,
Boston, Mass., USA
Anaerobic digestion, III. Anaerobic digestion of undiluted human excreta. Sewage Works Journal. Vol. 1. No.15(4). 679-701. 1943. 11 tables. 6 figures. 10 references.

An undiluted mixture of urine and feces, unlike the solids separated from sewage, do not undergo anaerobic digestion in a normal way, even though they are properly seeded and held for as long as a year. When urine and feces are mixed, urine breaks down to form ammonium carbonate, but insufficient carbon dioxide is present for the formation of bicarbonates. This results in a higher pH, which in turn shuts down the digestion as well as methane production. Effects of added carbon dioxide-producing substances on the digestion of seeded excreta are also reported.

excreta; urine; biogas; anaerobic digestion

4532 McGarry, M.
International Development Research Centre,
Ottawa, Canada
Sanitation in China, practices of excreta treatment and reuse. Sanitation in Developing Countries Today. A conference sponsored by Oxfam and the Ross Institute of Tropical Hygiene. 5-9 July 1977. Pembroke College, Oxford, England. 15p. To be published in a book "Sanitation in Developing Countries Today" by John Wiley and Sons. October 1978. 1 table. 11 references.

This paper explains how a Chinese biogas plant is different from the ones used in India and Korea. The Chinese plant does not have a floating gas holder; instead, it employs a fixed-top gas holder, which is cheaper and more maintenance-free. It is also reported that the biogas plant is capable of removing or

destroying many parasites. It is by no means certain that the effluent from the plant is free from disease-causing organisms.

biogas; China; parasites

5. Greywater

5001 World Health Organization, International Reference Centre for Community Water Supply, Netherlands

Health effects relating to direct and indirect re-use of wastewater for human consumption. Technical Paper Series No. 7. WHO, International Reference Centre for Community Water Supply. Netherlands. 164p. September 1975. 4 appendices.

□ This report presents the current knowledge relating to refractory water contaminants and their possible impact on health in relation to direct or indirect wastewater reuse for human consumption. A detailed survey of maximum reported concentrations of organic and inorganic compounds in water as well as microbiological contaminants in water is presented in the appendices.

public health; wastewater; reuse; standards; pollution

5002 Office of Science and Technology, Agency for International Development, Washington, USA
Water quality standards and international development. Report No. TA/OST-71-4. U.S. Agency for International Development. 34p. October 1971. 15 references.

This report summarizes progress to date in establishing water quality standards in the United States and in developing countries. Its purpose is to assist those broadly concerned with environmental policies in developing countries to better understand past efforts and future needs in this field.

water quality; standards; drinking water; water supply

5003 Edling, M.
Ekstrand, G.
Avdelningarna for Vattenforsorjnings-och Avloppsteknik samt Vattenkemi. KTH, S-100 44 Stockholm, Sweden

Infiltration av bdt-vatten. (Infiltration of greywater.) A report issued December 1975. 30p. 13 figures and diagrams. 3 appendices. 11 literature references.

Infiltration tests were made with greywater in the laboratory and in an existing filter bed for greywater. The laboratory tests were aimed at checking: if the bed material itself has any purifying effect or if it only spreads the water over the infiltration area; if the kind of material in the bed is important; if a mixture with organic material gives a different purification; and if

the thickness of the bed has any importance. Three materials (fine gravel, coarse gravel, and leca) were tested but no difference in purifying effect due to the different materials was noted. The bed gave an efficient spreading of the water over the infiltration area, but the purification obtained was low (partly due to the short period of investigation). To control the importance of thickness and humus content in the bed, greywater was infiltrated in a mixture, to various proportions, of gravel and peat, with varying heights. The reduction of phosphorus and COD took place mostly in the upper 20 cm of the material. An analysis of a Clivus filter bed for greywater gave rather varying results. Its effect is very dependent on the flow through the bed. As there is no equalizing of the flows, the filter is washed out at heavy flows, while it works efficiently during low flows. As an improvement of the filter it is suggested that it be made cylindrical instead of conical and that the aeration be made more efficient through a construction that makes the water fall freely through a part of the filter bed. (Original paper written in Swedish.)

greywater; wastewater; infiltration; materials

5004

Fogel, M.
Lindstrom, C. R.

The treatment of household washwater in homes equipped with the Clivus Multrum organic waste treatment system. An unpublished report of Clivus Multrum, USA, Inc 7p. June 1976. 13 references.

The nature of greywater is compared with that of combined wastewater. It is noted that an elimination of the blackwater, which is the result when using a Clivus Multrum, lowers the wastewater amount to about 40%. In addition, the BOD, nitrogen, and phosphorus concentrations are lowered considerably. The bacteria content remains high even after a separation, though most of the disease-causing organisms are eliminated. Different methods for treatment of greywater are discussed. The methods are based on existing infiltration and resorption techniques, but some changes and simplifications are suggested due to the low pollution load in greywater compared with combined wastewater. It is also noted that the methods are quite new and not yet fully tested.

household; greywater; filtration; seepage pits

5005

Frankel, R. J.
Sevilla, A. S.

(Both) Asian Institute of Technology, Bangkok, Thailand

An Asian technological approach to water reuse series filtration using local filter media. Sixth International Conference. Advances in Water Pollution Research. Israel. 723-731. 8-23 June 1972. 5 figures. 1 table.

A new approach to the filtration of water and wastes utilizes locally available materials, principally burnt rice husks and shredded coconut fibre, as media. These materials are cheap enough to discard,

thus eliminating backwashing. The results of 1 year of testing are reported.

sullage; filtration; water; materials; coconut fibre; construction

5006

Htun, M. N.
Aftab, M. P.
Ramachandran, P. N.

(All) Asian Institute of Technology, Bangkok, Thailand

Some applications of solar energy in Thailand. Research Report to the John F. Kennedy Foundation of Thailand. Asian Institute of Technology. 78p. June 1976. 8 tables. 38 figures. 24 references.

A report on research studies of solar drying, solar distillation, and solar cooking is given. Good quality water can be produced at a rate of 2.04 litres / m²d at the mean solar radiation level of 5.1 kw / m² and, with mirrors, the rate can be increased to 4.95 litres / m²d. Addition of activated carbon to the feed at 12 g / litre increased the efficiency by 48.6% to an overall efficiency level of 27.5%. Burnt rice husk suspended in the feed was less efficient than activated carbon but overall efficiency increased to 33% when a static bed of burnt rice husk was used. Using a static bed of burnt rice husk and constructing the still so as to collect rainwater, when weather permits, the cost of producing 1 litre of potable water is calculated to be 11 Baht (U.S. \$0.52). The solar dryer reduced the moisture content of tapioca chips from 71% to 14% within 8 h at a loading of 15 g / m² and costing 10 Baht (U.S. \$0.45) per kilogram of chips.

solar; technical; Thailand

5007

Huisman, L.
Department of Civil Engineering, Technology University, Delft, Netherlands

Wood, W. E.
World Health Organization, Geneva, Switzerland

Slow sand filtration. World Health Organization. Switzerland. 122p. 1974. 52 figures. Selected bibliography.

A detailed review of the technology of slow-sand filtration as a method of water treatment is given. This traditional method is still the cheapest and simplest option for developing countries, as it makes use of locally available skills and materials. The construction and design of slow-sand filters are described as well as operating techniques and the theory of biological filtration. The application of slow-sand filtration to the artificial recharging of groundwater sources is described.

sand; filtration; water treatment; sullage; construction

5008

Hypes, W. D.
Batten, C. E.
Wilkins, J. R.

(All) NASA Langley Research Center, Hampton, USA

Processing of combined domestic bath and laundry waste waters for reuse as commode flushing water. Report No. NASA TND-7937. USA. 66p. October 1975. 18 tables. 9 figures. 4 references.

■ An experimental investigation of processes and system configurations for reclaiming combined bath and laundry wastewaters (greywater) for reuse as commode flush water has been conducted. Filtration by single pass (no control of pressure and flow rate), 90-min recycle, and 120-min recycle flows, through a diatomaceous earth cake filter, has been investigated as a means for improving physical/chemical characteristics of the greywater. A 90-min recycle flow is reported to be effective in removing particulates down to 1 micrometre in maximum dimension and in improving other physical characteristics to the extent that the filtered water is subjectively acceptable for reuse. A further improvement in physical and selected chemical characteristics of the treated water can be obtained by activated charcoal adsorption following the 90-min recycle flow that has resulted in noticeable reductions in colour, turbidity, and sudsing. Heating of the wastewaters to temperatures of 135 °F and 145 °F for periods of 15, 30, and 45 min, and chlorination at available chlorine concentrations of 1, 15, 20, and 25 mg/litre to reduce/eliminate coliform organism counts have been investigated. A temperature of 145 °F for 30 min and chlorine concentrations of 20 mg/litre in the collection tank followed by 10 mg/litre in the storage tank are determined to be adequate for public health safety. The volume of bath and laundry waters available from a typical American family of four is found to be greater than the volume of water required for commode flushing when the water-conserving shallow-trap commode is used. Losses due to collection-tank overflow and tank drainage to remove accumulated particulates will reduce the volume of wastewater available and could possibly result in the need for a small volume of makeup tap water. The amount of energy required to operate this typical reusing system is reported to be relatively low. A system using diatomaceous earth filtration and chlorine sterilization to process the waters for reuse requires an average of 0.695 kwg/day.

reuse; wastewater; filtration; greywater; materials; public health; chlorination

5009

Kabbash, A.

Greywater treatment. Unpublished report. Renewable Resources Project. Macdonald College of McGill University. Canada. 29p. March 1977. 7 diagrams. 9 references.

A filtration system is designed to treat household washwater (greywater), which is then tested and evaluated. Possible methods of discarding the

greywater (e.g., infiltration) or the possibility of reuse (e.g., for toilet flushing) are discussed. Similar research projects are briefly outlined.

filtration; greywater; reuse

5010

Katzenstein, L. B.
Braswell, J. A.

(Both) Naval Coastal Systems Laboratory, Panama City

Virus elimination in water and wastewater. Unpublished report. 34p. January 1976. 128 references.

The effectiveness of various techniques for disinfecting sewage and drinking water are discussed. Special emphasis is given to the elimination of viruses. Basic concepts of water and wastewater treatment are reviewed. Information is presented on economically feasible methods for improving virus removal.

wastewater; sedimentation; disinfection; viruses; microorganisms

5011

Olsson, E.
Karlgrén, L.
Tullander, V.

(All) The National Swedish Institute for Building Research, Stockholm, Sweden

Household wastewater. Report 24: 1968, UDC 628-31 by the National Swedish Institute for Building Research, Stockholm. 162p. 1968. 36 figures. 98 tables. 58 references.

■ The purpose of this investigation was to obtain information about the quantity and characteristics of wastewater from dwelling houses. The study emphasized greywater, i.e., wastewater from bathrooms, kitchens, and laundry, and the results obtained were compared with the pollution in wastewater from toilets (i.e., black water). About 25 flats in a suburb of Stockholm, Sweden, were used as the subjects of this experiment. It was established from this extensive study that the flow as well as the pollution, with respect to both volume and nature, was the same from day to day without any noticeable differences between days of the week. On the other hand, the variations within the day itself are so great and so unsystematic that the analysis results from separate parts of the day did not provide any useful representative figures of the quantities of pollution. Average flow of the greywater was reported to be 121.5 litres/capita-day and of black water 8.5 litres/capita-day. Analysis of the composition of the greywater revealed that kitchens contributed nearly 70% of BOD, while approximately 60% of the quantities of phosphorus originated from the laundry. The quantities of nitrogen were split up in such a way that the kitchens supplied 51%, the bathroom 31%, and the laundry 18%. The amount of BOD₅ from the greywater averaged 25 g/capita-day while for black water it was 20 g/capita-day. The ranges of coliform bacteria densities were 1.7 X 10⁹-83.0 X 10⁹ and 3.8 X 10⁹-62.2 X 10⁹ bacteria numbers/capita-day for greywater and black water, respectively. The rates of organic decomposition of the greywater were compared with about 65% per 24

h, which is relatively fast compared with 20% per 24 h for black water and municipal wastewater. Furthermore, the secondary (indirect) aspect of pollution from the greywater was calculated to yield theoretically about 7.5 more BOD than the primary (direct) oxygen/demand via phosphorus synthesis into plankton cells. These results suggest that special attention must be paid to the greywater and that proper treatment of the greywater should be carried out before it is discharged into the environment.

greywater, Sweden; BOD; phosphorus; nitrogen; bacteria, decomposition

5012 Shannon, E. E.
Wastewater Technology Centre, Environmental Protection Service, Environment Canada, Ottawa, Canada

Verghese, K. I.
Chemical Development Department, Aluminium Company of Canada Ltd., Arvida, Quebec, Canada

Utilization of alumized red mud solids (ARMS) for phosphorus removal. Water Pollution Control Directorate. Technology Development Report EPS 4-WP-75-2. Environment Canada. 15p. August 1975. 3 figures. 5 tables. 4 references.

Alumized red mud solids (ARMS) is a new material with coagulant properties that is derived from the waste product (red mud) of the Bayer process for producing aluminium. Pilot plant experiments utilizing ARMS to treat a municipal wastewater are described. BOD, suspended solids, and total phosphorus-removal efficiencies are reported and compared to results from a similar aluminium sulfate (alum) experiment. The fate of heavy metals impurities in the ARMS has also been investigated. It is concluded that ARMS can be used in full-scale phosphorus-removal systems, resulting in chemical operating costs as much as 50% lower than comparable alum systems.

alumized red mud solids; coagulation; phosphorus removal; sewage treatment; heavy metals

5013 Siegrist, R.
Witt, M.
Boyle, W. C.
(All) Civil and Environmental Engineering Dept., University of Wisconsin, Madison, Wisc., USA

Characteristics of rural household wastewater. Journal of the Environmental Engineering Division, American Society of Civil Engineers. USA. Vol. 102(EE3). Proceeding paper 12200. 533-548. June 1976. 17 tables. 3 figures. 15 references.

■ Field studies were conducted for 434 days at 11 homes in Wisconsin to study their water usage characteristics, flow per use, and flow per capita per day. Daily and weekly flow patterns were also developed. Wastewater quality characterization was carried out consequently, from which the concentra-

tion and mass of pollutants per event occurrence and the mass of pollutants per capita per day were determined.

rural; household; wastewater; USA; greywater; pollution; water usage

5014 Sivakumar, M.
Environmental Engineering Division, Asian Institute of Technology, Bangkok, Thailand
Horizontal flow prefiltration of tropical surface water. Master of Engineering Thesis No. 993. Asian Institute of Technology. Thailand. 75p. 1976. 17 tables. 38 figures. 32 references. 4 appendices containing 12 tables. 2 figures and computer programs.

A report on studies of horizontal flow prefiltration through crushed stone for turbid surface water treatment is given. Multiple regression of data indicated that influent turbidity, depth of media, length of media, and flow rate were significant parameters in affecting turbidity removal. For raw water turbidity, about 35 JTU, the optimum filtration rate was $0.34 \text{ m}^3 / \text{m}^2\text{h}$ and, with 150 JTU raw water, the optimum rate of filtration was $0.19 \text{ m}^3 / \text{m}^2\text{h}$. A cost model for a pilot-size horizontal flow prefilter unit was developed and solved using Lagrange's function. This type of filter is very effective in removing suspended solids from turbid surface waters.

water treatment; filtration; Asia

5015 Thanh, N. C.
Pescod, M. B.
(Both) Environmental Engineering Division, Asian Institute of Technology, Bangkok, Thailand

Application of slow filtration for surface water treatment in tropical developing countries. Research Report No. 65 to WHO International Reference Centre for Community Water Supply. Asian Institute of Technology. Thailand. 75p. July 1976. 6 tables. 15 figures. 11 references. 4 appendices containing 8 tables and 4 figures.

A report on a 1-year performance evaluation of a slow sand / burnt rice husk filter in combination with a coconut fibre roughing filter, and dual media filters containing coconut fibre overlying burnt rice husk and burnt rice husk overlying sand in the same filter box is given. With the series filter combination of coconut husk and burnt rice husk, a filter run of 2-3 months can be expected with a raw water turbidity 100 JTU and filtration rate $0.2 \text{ m}^3 / \text{m}^2\text{h}$. The dual media combination of the same materials gave a 2 1/2-month run with 100 JTU influent turbidity at the same filtration rate, but a 7-month run with 50 JTU influent and $0.1 \text{ m}^3 / \text{m}^2\text{h}$ filtration rate. A series filter system was estimated to cost 25% more to install than the dual media filter, but both would have running costs of 5 Baht / month per person (U.S. \$0.25). The burnt

rice husk and sand dual media filter was expected to be more appropriate for village use.

water treatment; filtration; materials; coconut fibre; Thailand

5016 Yen, T. C.
Environmental Engineering Division, Asian Institute of Technology, Bangkok, Thailand
Study of potential effectiveness of various local materials in filtering industrial and domestic wastes. Master of Engineering Thesis No. 567. Asian Institute of Technology. Thailand. 156p. 1973. 26 tables. 18 figures. 5 appendices containing 42 figures. References.

A report on laboratory scale filtration using a series of units with local materials as media in the treatment of industrial and domestic wastes is given. Fifty cm of shredded coconut husk and 30 cm of burnt rice husk, operated at a filtration rate of $1.24 \text{ m}^3/\text{m}^2\text{-h}$, were feasible as a tertiary treatment process, giving 40% BOD removal with oxidation pond effluent. Eighty cm of shredded coconut fibre at a filtration rate of $2.5 \text{ m}^3/\text{m}^2\text{-h}$ was 40% efficient with the same waste and effective as secondary or tertiary treatment of domestic waste. Fifty-five percent of BOD removal was achieved using a dual media filter comprised of 50-cm pea gravel and 30-cm sugar cane bagasse ash at a filtration rate of $1.25 \text{ m}^3/\text{m}^2\text{-h}$.

sewage treatment; materials; coconut fibre; filters

5017 Warshall, P.
Above-ground use of greywater. Unpublished report. Office of Appropriate Technology, State of California, Sacramento, Calif., USA. 161-190. 2 tables. 11 references.

In this paper, the possibility of reusing household greywater is considered. The State of California bylaws for reuse of treated sewage water are studied, and recommended quality standards are examined. The BOD counts, presence of trace elements, other chemical compounds etc. that could affect human health if the treated sewage water were used are determined. Chemical characteristics of greywater are compared with those of treated sewage water and possible means of above-ground reuse of greywater are found. Some very practical, low-cost solutions are given.

greywater; health; reuse

6. Water Saving

6001 De Bell and Richardson Inc., Enfield, USA
Final report on washwater waste pretreatment system study. U.S. National Aeronautics and Space Admin-

istration. USA. Contract NAS 9-14518. 59p. March 1976. 29 tables.

This is an evaluation of numerous chemical agents as antifoams for synthetic washwater. A low-foaming liquid soap for sponge bathing and hand washing is described.

water; water saving; soaps; washing apparatus

6002 Environmental Control Technology Corporation, Ann Arbor, Mich., USA
Evaluation and performance results of the flushmate tank. A report published by Water Control Products/N.A., Incorporated. USA. 36p. November 1975. 4 tables. 9 figures. 5 references.

Basic operating characteristics of the Flushmate Tank with three leading water closets have been investigated. Water supply and discharge characteristics of both Flushmate- and gravity tank-operated water closets have been measured and compared. Fixture performance tests and backflow prevention tests have also been conducted on both Flushmate and gravity tank fixtures. The results of the testing program have shown the following results: (1) Flushmate-operated water closets place a substantially lower water demand on the water supply system (52% less water usage). (2) Peak discharge flow rates were influenced primarily by bowl design, and Flushmate- and gravity tank-operated fixtures had similar discharge peak flow rates; however, the Flushmate discharge time was 49% shorter. (3) Flushmate-operated units were good performance water closets.

design; water supply; water saving; toilet performance; low-flush toilets

6003 Information Office, McGill University, Montreal, Que., Canada
Shower with one litre of water. Research McGill. Canada. 5-7. May 1975.

This article describes work done in developing a shower that operates for 10 min using only 1 litre of water. A composting toilet that allows for the hygienic disposal of wastes without an elaborate plumbing system is also described.

washing apparatus; water; water conservation; atomization

6004 Building Research Establishment News, U.K.
Saving water in the home. Building Research Establishment News. U.K. Vol. 38. 4-5. Winter 1976. 2 figures.

Research on water-saving devices for British homes is described. A retrofitted device reduces flush-water consumption in toilets by 40%. Bathroom wastewater is recycled to be used for toilet flushing.

Atomized water is proposed for washing. It is estimated that savings of up to 50% could be achieved by various combinations of these devices.

household; water reduction; wastewater; reuse; atomization; low-flush toilets; design

6005

Ultraflo Corporation, Sandusky, Ohio, USA
How ultraflo systems conserve energy and water. Ultraflo Ecology Bulletin. USA. 10p. 1973. 7 tables.

Based on electronic monitored programs in actual households, data compiled on water use and user habits demonstrated with the Ultraflo pushbutton one-line system that there was a saving of 12-20% of total water consumed compared to households with conventional two-line systems. The Ultraflo system eliminates waste or heated water normally left standing in lines between uses.

domestic; energy conservation; water saving; wastewater; one-pipe system; water consumption; economics; push-button faucet

6006

Washington Suburban Sanitary Commission,
Hyattsville, Md., USA

Its up to you. A customer handbook on water-saving and wastewater reduction. The Washington Suburban Sanitary Commission. USA. 24p. May 1976. 30 illustrations. 1 table.

Three reasons for saving water are given: (1) water resources are limited; (2) water costs are rising because of increased processing required to meet today's health standards for water, as is the cost of wastewater disposal, and (3) the load on collection and treatment systems, potentially dangerous for pollution, must be reduced. Many helpful hints for more effective use of conventional plumbing fixtures are offered. Mention is also made of water-saving devices that attach to existing fixtures as well as alternative fixture equipment. Water-use figures are stated to point up actual quantities of normal use and waste. Hints are given for water saving outside the house, and a plant watering guide is shown.

water saving; dishwashing; clothes washing; bathing; plumbing; flow reduction; domestic; toilet performance

6007

Bailey, J. R.
Benoit, R. J.
Dodson, J. L.
Robb, J. M.
Wallman, H.

(All) General Dynamics, Groton, Conn., USA

A study of flow reduction and treatment of wastewater from households. Water Pollution Control Research Series 11050 FKE 12/69. Department of the Interior. Federal Water Quality Admin-

istration. USA. 154p. December 1969. 18 figures. 14 tables. 108 references.

□ This study identifies practical means of waste-flow reduction for American households. Commercially available devices for water saving are described and literature on advanced water and waste treatment is reviewed. A consumer survey was conducted and showed that water used in household functions such as bathing and toilet flushing can be substantially reduced by the use of more efficient appliances and plumbing devices.

water saving; devices; household; wastewater; flow reduction

6008

Bailey, J. R.
Wallman, H.

(Both) Electric Boat Division, General Dynamics, Groton, Conn., USA

Flow reduction of waste water from households. Water and Sewage Works. USA. Vol. 118(3). 68-70. March 1971. 3 tables. 4 figures. 8 references.

Water-saving devices such as the dual-flush toilet tank system and the vacuum toilet system are currently available. These systems are reported to provide, at no overall cost penalty to the homeowner, a water saving (and waste-flow reduction) of 30-50%. A limited survey indicates that the use of such water-saving devices would be readily accepted by homeowners.

water saving; low-flush toilets; vacuum toilets; flow reduction; public acceptance; devices

6009

Bender, T.

Department of Architecture, University of Minnesota, Minneapolis, Minn., USA

Living lightly ... energy conservation in housing. A report published by Department of Architecture, University of Minnesota. USA. 12-15. October 1973. 7 illustrations. 5 references.

The conservation of water is related to energy conservation. Water requires energy for treatment, which in turn affects the physical environment. Water savings are possible by reusing the water in toilets, water-reduction devices, toilet redesign, use of compost toilets, and use of foot-operated faucet valves on sinks and wash basins and locating them close to water heaters. Design of clothes washers and even clothing material can affect the amount of water used. Heated water is a great energy consumer. Use of solar water heaters, proper water heater location, and insulation can all save heat.

energy conservation; flush toilets; water saving; bathing; clothes washing; dishwashing; pedal valves; atomization; composting toilets; water heaters; domestic

6010

Borjesson, E.
Bobeda, C.

(Both) Corporacion de Obras Sanitarias de Asuncion, Paraguay
New concept in water service for developing countries. Journal of the American Water Works Association. USA. Vol. 56(7). 11p. July 1964. 5 figures. 5 tables.

This is a report about a system that effectively accomplishes an improvement in public health and social conditions in three areas in developing countries. The problem was to provide a permanent healthful water supply in adequate amounts to individual dwellings in all urban areas at a price that the customer could afford and that would also pay for the service. The solution was the installation of a one-pipe water supply line serving a group of domiciles, each provided with a "Fordilla" spring-loaded faucet. This device restricts the overuse and waste of water much as the hand pump does. Details of water distribution and costs and use data are presented, as well as public acceptance of the system.

domestic; spring-loaded faucet; plumbing; water supply; water consumption; public health; one-pipe system; push-button faucet; developing countries; water saving

6011 Boston, H. E.
Cohen, S.
Wallman, H.

(All) U.S. Environmental Protection Agency
Saving water in the home. Water Conditioning. USA. Vol. 16(10). 16-21. November 1974. 3 diagrams. 2 tables. 18 references.

A report of two studies conducted by General Dynamics and by the Washington Suburban Sanitary Commission of equipment available for saving water in the home is given. This equipment includes reduced-flow toilets, flow-limiting shower heads, and faucet aerators. It is concluded that there is justification for installing such devices to save water.

wastewater reuse; domestic; water saving

6012 Cohen, S.
Wallman, H.

Demonstration of waste flow reduction from households. U.S. Environmental Protection Agency. USA. Report No. EPA-670/2-74-071. 102p. September 1974. 29 tables. 28 figures. 12 references. 1 appendix.

□ A 2-year demonstration program was conducted to evaluate water savings, costs, performance, and acceptability of various water-saving devices. Reduced-flow toilets and flow-limiting shower heads were installed in eight single-family dwellings. In three of the homes, bath and laundry water were filtered, disinfected, and reused for toilet flushing and/or lawn sprinkling. The experimental portion of the program ran from May 1971 to May 1973. Water requirements for toilet flushing were substantially reduced in an economically attractive and aesthetically acceptable manner. Shallow-trap and dual-flush toilets resulted in average decreases in toilet-water usage of 25% and

23%, respectively. Flow-restricting shower heads proved to be relatively ineffective; however, this result may have been due to use patterns unique to this study. Wash-water recycle systems provided satisfactory operation throughout the test period. The average savings for toilet-flushing reuse ranged between 23% and 26% of total water usage. The incorporation of lawn sprinkling as a supplemental reuse further reduced waste flow from homes by 16-18%. For single-family dwellings, recycle systems could effect marginal cost savings in high-water and sewer-use rate areas. They are definitely warranted when septic systems with poor drainage (due to soil or topography) are encountered.

domestic; sewage treatment; water saving; filtration; disinfection; cost analysis; plumbing; reuse; flow rate; toilet performance

6013 Fowell, A.
Bransdorfer, A.
Fletcher, P.
Orend, R.
Pavel, H.
Williams, G.

Residential water use and the potential for conservation. Water and Water-Related Conservation in Buildings. USN CCIB/CIB International Symposium on Water Supply and Drainage, National Academy of Sciences. USA. 5-9. 28-30 September 1976. 4 tables. 1 figure. 19 references.

Differences in U.S. and European domestic water consumption are attributed to personal habits, water-consuming appliances, and mainly water-closet design. Fixture and fitting minimum flow rates based on function have not been researched in the U.S., but two criteria for estimating potential for water saving in appliances and fixtures are given. Energy savings can result from improved efficiency of water heaters, from reduced consumption of hot water, and by use of flow restrictors in showers and basin faucets. Research is needed to provide a comprehensive study of energy use in water supply and wastewater treatment systems, and from the point of view of economic impact in contrast to technology of conservation; safe economic quantities of water required for acceptable performance of fixtures; and safety and practicality of greywater use. Without thorough evaluation of water-saving water closets and add-on devices, the result may be a hazard to health and double flushing of toilets. In sum, research should establish energy impact of water conservation by energy-benefit analysis as well as impact of water-saving measures.

USA; Europe; flow rate; flush toilets; plumbing; water saving; energy conservation; water heaters; flow reduction; greywater; water supply

6014 Fuller, B.
Marks, R.
The Dymaxion world of Buckminster Fuller. Anchor

Books Anchor Press/Doubleday, USA. 99-100. 1973. 5 illustrations.

The author considers the Dymaxion bathroom as an interim sanitary facility. A fog gun combines water and air at high pressure to release skin cells and dirt. Illustrations show a laboratory setup and three magnified photographs of skin surface, and students researching fog-gun use in bathing. With such fog guns, tons of plumbing would be saved as well as bathroom-enclosing walls.

bathing; atomized water; plumbing; water saving; shower; domestic; hygiene

6015 Gay, D. E.
Spray faucets save water and energy. Building Systems Design. U.K. Vol. 71(4). 35-36. June/July 1974. 1 table. 1 figure.

A spray-faucet system is reported to provide savings for both water and energy. Investigations conducted in London show that an average time taken for washing with spray faucets is less than 60 seconds, compared with 90 seconds for the traditional method. Future uses of this system are expected to increase.

spray faucets; water saving; energy conservation; England

6016 Goldstein, S. N.
Moberg, W. J., Jr
Wastewater treatment systems for rural communities. Commission on Rural Water. National Demonstration Water Project. USA. 294-307. 1973. 1 table. 9 diagrams.

Reducing water consumption in households by careful use by individuals, by reducing the amount of water that flows through plumbing fixtures, and by recycling water used in certain functions reduces wastewater, treatment facilities, and allows more users to be served by water systems of lesser capacity. A survey of available equipment includes illustrations, identifies manufacturer, shows performance and characteristics, and includes comments.

water consumption; water saving; household; wastewater; community; plumbing; flow reduction; low-flush toilets; rural; equipment; surveys; flow reduction

6017 Guarneri, C.
Reed, A.
Renman, R.
(All) Grumman Aerospace Corporation, Bethpage, N.Y., USA

Study of water recovery and solid waste processing for aerospace and domestic applications. NASA Contract NAS 9-12503. Manned Spacecraft Center. USA. Vol. I. 31p. Final report summary. Vol. II. 192p. Final report. Vol. I. 8 figures. 3 tables. Vol. II. 49 figures. 23 tables. 46 references. 3 appendices.

Land development in many parts of the country is discouraged by inadequate water resources or by incompatibilities between water supply and waste-treatment plans. Many established areas cannot satisfactorily keep pace with rapidly expanding urban populations for the same reasons. In addition, the cost of additional water supply and waste management in such areas can be extremely high. Practical alternatives to conventional water and waste-treatment systems are required in newly constructed or redeveloped communities where such difficulties exist. This report evaluates the manner in which current and advanced technology can be applied to develop practical solutions to existing and emerging water-supply and waste-disposal problems. An overview of water resource factors as they affect new community planning, and requirements imposed on residential waste-treatment systems are presented. The results of equipment surveys contain information describing commercially available devices and appliances designed to conserve water; devices and techniques for monitoring water quality and controlling back contamination; and advanced water- and waste-processing equipment system concepts, developed and compared on the basis of current and projected costs. Economic evaluations are based on community populations of from 2000 to 250 000. The most promising system concept is defined in sufficient depth to initiate detailed design.

water recovery; solid wastes; community; water saving; costs; equipment; design; vacuum toilets; water; domestic

6018 Hershaft, A.
Environmental Studies, Enviro Control Inc., Rockville, Md., USA

Wastewater flow reduction in the home. Environmental Systems. USA. Vol. 4(3). 217-239. Fall 1974. 5 tables. 4 figures. 51 references.

Methods of residential wastewater flow reduction, devices, and practices are presented and discussed in detail. The author indicates a trend of future shortage of high-quality water supply and suggests cooperation from institutions and government agencies to effectively carry out a program to reduce household water usage.

wastewater; flow reduction; household; water consumption; water supply; devices

6019 Hershaft, A.
Von Hasselin, R.
Roop, R.

Water management alternatives on Long Island. A report published by Booz, Allen and Hamilton, Incorporated and Environmental Technology Seminar, Incorporated. USA. 39-44. October 1974. 2 tables. 2 figures. 7 references.

Water reduction can be achieved through introduction of flow reduction and recycling devices that

complement described conservation practices. Some more common owner-installed flow-reduction devices are listed in a table as to type, operation, effectiveness, cost, and name of manufacturer. Recycling domestic water assumes that water quality need only be sufficient for the intended purpose. A promising approach to water reduction is water-saving toilets that are described as to their nature, operation, effectiveness, cost, and manufacturer of the more common designs. If flow-reduction practices suggested by the Washington Suburban Sanitary Commission could shift water consumption to off-peak hours, they would be particularly effective in decreasing required water and wastewater treatment plant capacity.

flow reduction; devices; water-saving; water consumption; wastewater; domestic; USA; low-flush toilets

6020 Irons, F.
Hand sprayers and dusters. U.S. Department of Agriculture, Home and Garden Bulletin No. 63. USA. 12p. 1970. (Out of print.) 1 table. 17 illustrations.

This pamphlet describes various hand-operated pesticide spraying and dusting devices for use in the home, in the garden, and on farms. Intermittant sprayers discharge the spray material only with each forward stroke of the pump. Continuous sprayers develop and maintain a constant pressure, and develop a continuous spray discharge of uniform pattern while the pump is being operated. Useful information, such as operating pressure, tank sizes, and spray patterns, is given, as well as information on maintenance and pesticide handling.

sprays; households; bucket pump; nozzles

6021 Mani, J. S. V.
Srinivas, V.
Subba Rao, V.
Rao, N.

(All) Andhra University, Waltair, India
Atomization by pressure nozzles. Indian Institute of Chemical Engineering Journal. India. Part I, 111-118. Part II, 151-159. Part III, 10-13. 1955-1956. Part I: 1 table. 9 figures. 9 references. Part II: 3 tables. 8 figures. 5 references. Part III: 2 tables. 5 figures. 4 references.

An investigation on atomization of liquids by nozzles using a swirl-disk nozzle was conducted in India. The following characteristics were determined: total flow rate, volume-rate distribution, drop-size distribution, and cone angles. Correlation for the effect of pressure on total flow rate, volume rate, distribution, drop size distribution, cone-angle, and capacity was also attempted. The effect of tangential and vertical velocity components on "atomization" in a swirl thread nozzle using water was examined, as well as the effect of surface tension of liquids on "atomization," using aqueous isoamyl alcohol.

nozzles, flow rate, sprays; atomization; water saving; plumbing; India

6022 Morse, A. B.
School of Architecture, McGill University,
Montreal, Que., Canada

The use of atomization for washing and showering to conserve water. Master of Architecture Thesis. School of Architecture. McGill University. Canada. 124p. August 1976. 71 illustrations. 27 tables. 50 references.

■ A number of devices to reduce domestic-water consumption are available on the American market. These include spring-loaded self-closing faucets, pressure-reducing shower heads, and flow-reducing valves. These devices are based on pressurized water pressure in the house. There is also a need for devices that allow bathing with extremely small quantities of water, where the latter is not available within the home. To reduce the amount of water needed for individual bathing, and, in turn, to reduce household consumption of water as well as production of wastewater, atomizer nozzles have been tested for washing and showering purposes. Atomization is the mechanical subdivision of a bulk liquid (e.g., water) into a fine droplet spray. This is accomplished by passing water under pressure, through a nozzle. A test of a number of nozzles indicates best performance with industrial hydraulic nozzles having flow rates of 0.13-0.33 litres/minute at 1.3 atmospheres, which have enough impact to remove soapsuds from the skin. A prototype shower was built utilizing a 2.5-litre water tank in which pressure could be manually induced with a bicycle pump. A series of showering tests indicated a 5-8-min shower utilized 2 litres of water. Some problems were encountered with rinsing excess soapsuds and hair washing. The atomized shower was pleasant to use and showed a water reduction of over 90% compared to a conventional shower. To measure cleansing ability, a bacterial count was taken before and after atomized showering with biosidal soap. Sample results taken after 48 hours incubation showed a reduction in bacteria of 95%.

water saving; atomization; nozzles; showering; hygiene; design; plumbingless bathroom; domestic

6023 Murawczyk, C.
Ihrig, D.
Mayeux, J.
Weber, R.

(All) Martin Marietta Corporation, Denver,
Colo., USA

Water recovery and solid waste processing for aerospace and domestic applications. NASA Contract NAS 9-12504, Manned Spacecraft Center. USA. 41p. January 1973. 2 figures. 3 tables.

The final report describes (a) compiling information needed to establish the current water supply and wastewater processing requirements for dwellings, and (b) developing a preliminary design for a wastewater to potable water-management system. Data generated

as a result of item (a) was used in the formulation of design criteria for the preliminary design of the wastewater to potable water-recycling system. The system as defined herein was sized for a group of 500 dwelling units.

water consumption; aerospace technology; wastewater reuse; water quality; water recovery; solid wastes

6024

Ortega, A.
Rybczynski, W.
(Both) Minimum Cost Housing Group, School of Architecture, McGill University, Montreal, Que., Canada

Stop the five gallon flush! A survey of alternative waste disposal systems. School of Architecture, McGill University, Canada. 82p. April 1976. 73 illustrations. 18 references.

This book is a survey of alternative domestic water-conserving waste-disposal systems. Part I reviews the known methods for the disposal of household waste, noting the advantages and disadvantages with special interest in self-contained systems and ones that use little or no water. Part II is a catalogue of data emphasizing low-cost systems being manufactured in various countries, not purporting, however, to be a consumer's guide. Classification of waste-disposal systems is by processes that occur to the human waste: manual removal, mechanical removal, destruction, infiltration, and decomposition. Part III describes the operation of composting toilets, and ends with a low-cost design by the authors for use in temperate climates, which can be made for \$100 or less. A useful summary chart gives concise data on all toilets listed.

waste-disposal systems, household; water saving; excreta; composting toilets; mouldering toilets; sanitation; toilet performance; domestic; design

6025

Rosener, A.
Parker, D.
Brzeczek, M.
Ott, G.
Harris, S.
Lenda, J.

(All) Martin Marietta Corp., Denver, Colo., USA

Technology development for a zero-gravity whole body shower. Contract No. NAS1-9819. National Aeronautics and Space Administration. USA. 268p. 116 illustrations. 41 tables. 4 references.

Initially, the program consisted of theoretical and experimental investigations to establish design parameters. These design parameters were used to establish the test hardware for further experimental investigations in both one-gravity and zero-gravity environments. This report describes these efforts and the resulting conclusions concerning shower feasibility, shower design concepts, liquid-gas separation techniques, and their related zero-gravity design criteria.

During Task 1, an analysis of zero-gravity air-water behaviour, stall configuration and related habitability parameters were made before the test hardware was constructed. The Task 2 effort investigated and refined these concepts to establish the minimum impact on the contract baseline mission model. Based on Task 1 and Task 2 test results, basic design criteria were established for two zero-gravity whole body shower concepts. The amount of water required to bathe the whole body, including the head, averages approximately 0.5 gal (2.273 litres), which is due to the use of a hand-controlled nozzle, the nozzle design, operating procedures, and the tendency of the water to cling to the body.

aerospace technology; design criteria; hygiene; water collection; bacteria; nozzles; flow rate; showering; water saving

6026

Rosener, A.
Parker, D.
Harris, S.

(All) Martin Marietta Corp., Denver, Colo., USA

Hall, J.
NASA Langley Research Centre, Hampton, USA

Space shower habitability technology. American Institute of Aeronautics and Astronautics Conference. USA. Paper No. 71-873. 8p. 9-11 August 1971. 10 figures. 6 tables.

A zero-gravity, whole body shower design has been developed that provides crewmen with bathing facilities similar to those used on earth. In the absence of gravity, surface tension is the primary force that governs water behaviour. Shower stalls and associated hardware must be designed to effectively collect water for subsequent processing. The shower habitability parameters must be integrated with this technology to ensure crew compatibility and comfort. Test results are presented concerning these habitability parameters and how they are effective in providing a shower to cleanse the hair and body and provide a psychological lift.

space shower; bathing; water saving; water collection; showering; water quality; bacterial removal; nozzles

6027

Schumacher, E.
Lenda, J.

(Both) Martin Marietta Corp., Denver, Colo., USA

Design, fabrication and acceptance testing of a zero-gravity whole body shower. American Institute of Aeronautics and Astronautics. Intersociety Conference on Environmental Systems. USA. Paper No. A74-39144. 11p. July 29-August 1, 1974. 5 tables. 7 figures

This paper describes the three-task effort to design, fabricate, and accept a zero-gravity whole body shower for the Space Station Prototype.

Conceptual designs for various subsystems of the shower were established as part of Task 1. Task 2 involved the formulation of preliminary and final designs for the shower. The design has separate modules for the showering area, electrical, and mechanical components. Task 3 included the fabrication and test of the shower assembly.

space shower; bathing; water saving; design; water collection; showering

6028 Sharpe, W.
Pennsylvania State University, Institute for Research on Land and Water Resources and the Cooperative Extension Service, University Park, USA

Water conservation and wasteflow reduction in the home. The Pennsylvania State University, College of Agriculture Extension Service and the Institute for Research on Land and Water Resources. USA. Special Circular 184. 9p. 1977. 9 figures. 7 tables. 6 references.

□ A step-by-step explanation of treatment of water supply and wastewater is given. What is shown are ways for the homeowner to save water and energy without changing a normal style of living. The less water we use, the smaller the volume of wastewater produced, and the less it costs for treatment. There is a description of water-using appliances and of water-saving devices for taps, toilets, and showers, as well as a table showing water and cost savings by reusing wash water in toilets. Two-cycle, vacuum, and incinerator toilets are also discussed.

water-saving; two-cycle toilets; vacuum toilets; incinerator toilets; sewage treatment; wastewater reuse; sewage

6029 Sobolev, A.
Building Research Station, Garston, U.K.
Water supply installations and appliances. Royal Society of Health Journal U.K. Vol. 79(1). 39-41. January / February 1959. 7 references. 2 figures.

A report on some techniques for domestic water conservation is given. A new efficient type of ball valve for toilet-flushing cisterns has been designed. Spray taps reduce water consumption in communal washrooms. The need for investigating the efficiency of flush toilets relative to water used is pointed out.

water saving; spray faucets

6030 Sobolev, A.
Lloyd, C. J.
(Both) Building Research Station, Garston, U.K.

Trials of dual flush cisterns. Journal of the Institution of Water Engineers. U.K. Vol. 18(1). 53-58. February 1964. 1 figure. 2 tables.

This paper describes the construction of a dual-flush cistern and the way it saves water. Details of trials carried out to determine the saving likely to be achieved are given.

water saving; low-flush toilets; water; sewerage

6031 Vincent, L. J.
Keppie, G.

(Both) Zambia Housing Board, Lusaka, Zambia
Reduction of water waste by the use of constant-flow valves. AID-UNC / IPSED Series Item No. 2. USA. 4p. September 1966. 3 figures.

■ Installation of inexpensive constant-flow valves rated at 9.1 litres / min in the supply lines to individual houses in Kitwe, Zambia, reduced the water use by 25-30%. No complaints regarding inadequate supply have been received. Cost of the constant flow valve is approximately U.S. \$1.50-2.00.

Zambia; water reduction; costs; water supply; household

6032 Milne, M.
School of Architecture and Urban Planning,
University of California, Los Angeles, Calif.,
USA

Residential water conservation. California Water Resources Center. Report No. 35. University of California / Davis. March 1976. 250 references in an annotated bibliography, a list of manufacturers and distributors of water conservation products in the USA.

A "typical" residential consumption profile is presented, along with a brief history of how water has been used in the home. Water conservation is not simply a matter of inventing new fixtures; in fact, there are four types of constraints that must be satisfied before any innovation in water conservation can be implemented: economic, institutional, socio-cultural, and technological. The impact of each of these factors is discussed. Over four dozen commercially available devices that affect water consumption in the home are evaluated. In an attempt to discover future trends, a survey was made of relevant aerospace technology, including Apollo and Skylab systems, as well as the systems installed in commercial jet aircrafts, trains, and ships. Recent patent applications were searched and dozens of new water-conserving fixtures and appliances were discovered. Four scenarios are laid out to show the homeowner different strategies for reducing water consumption. Finally, a series of recommendations is made defining specific actions that can be taken by utility companies, lawmakers, and plumbingware manufacturers to reduce residential water consumption. It is made very clear that the only alternative to continually increasing the supply of water is to reduce the demand.

residential water; water consumption; water saving

Keyword Index

- Absorption, 2302, 2342
Absorption Trenches, *See: seepage pits*
Activated Sludge, 3027, 3028, 3237
Adsorption, 2118, 4127
Aerated Lagoons, 2321, 3003, 3009, 3011, 3301, 3305, 3325, 3332, 4142
Aeration, *See also: extended aeration*, 3028, 3410, 3415, 4162, 4221
Aerobic Digestion, 2215, 2217, 2316, 2321, 2355, 3011, 3024
Aerobic Lagoons, *See: anaerobic-aerobic ponds, stabilization ponds*
Aerospace Technology, 6023, 6025
Afghanistan, 3106
Africa, 2127, 2208, 2232, 2301, 2329, 3228, 3327, 3329, 3332, 3346
Agriculture, *See also: forest agriculture, vegetables, crops*, 2202, 3323, 3411, 3414, 4106, 4107, 4109, 4111, 4118, 4123, 4133, 4134, 4136, 4139, 4140, 4141, 4147, 4149, 4151, 4157, 4210, 4223, 4402, 4405, 4406, 4410, 4411, 4517, 4526
Air Flotation, 3333, 4321
Air Pollution, 4150
Algae, *See also: unicellular algae*, 3006, 3308, 3315, 3319, 3345, 3355, 4135, 4213, 4227, 4301, 4302, 4304, 4305, 4306, 4307, 4308, 4311, 4313, 4314, 4315, 4317, 4318, 4319, 4320, 4321, 4401, 4513
Algae Harvesting, 4303, 4309, 4310, 4312, 4313, 4316
Algae Ponds, *See: high-rate ponds*
Alum Flocculation, 4316, 4321
Alumzed Red Mud Solids, 2310, 5012
Anaerobic, 2316, 2318, 2346, 2349, 2353, 2355, 2356, 3015, 3331, 3355, 4304, 4525
Anaerobic-Aerobic Ponds, 2311, 3303, 3307, 3322, 3329, 3338, 3340, 3349, 3350, 3352, 3513
Anaerobic-Aerobic Treatment, *See: anaerobic-aerobic ponds*
Anaerobic Composting, *See: anaerobic digestion*
Anaerobic Digestion, 2216, 3010, 3024, 3339, 3513, 4157, 4401, 4501, 4502, 4511, 4514, 4517, 4518, 4524, 4529, 4530, 4531
Anaerobic Filter, *See: biological filters*
Anaerobic Lagoons, *See: anaerobic-aerobic ponds*
Anaerobic Ponds, *See: anaerobic-aerobic ponds*
Anaerobic Pretreatment, *See: anaerobic-aerobic ponds*
Analysis, 2205, 2218, 2227, 2304, 2323, 3412, 4516
Angola, 2109
Anguilla, 2339
Animal Feed, 3501, 3502, 3504, 3509, 4112, 4125, 4141, 4302, 4307, 4308, 4320, 4401
Animal Wastes, 3402, 3404, 3507, 4215, 4304, 4403, 4408, 4505, 4512, 4515, 4521
Aquaculture, *See also: marine aquaculture*, 3310, 3318, 3323, 3325, 3501, 4140, 4201, 4202, 4204, 4205, 4206, 4207, 4208, 4209, 4210, 4211, 4214, 4215, 4216, 4218, 4221, 4222, 4224, 4225, 4226, 4302, 4321, 4401, 4509
Aqua-privies, *See also: mound system, septic tanks*, 1007, 2112, 2203, 2207, 2301, 2312, 2325, 2330, 2331, 2336, 2339, 2343, 2352, 3029, 3113, 3117, 3118, 3204, 3224, 3225, 3229, 3230, 3235, 3325, 3329, 3346, 4407
Aqua-Privy Sewerage System, 3113, 3230
Aquatic Weeds, 2315, 3501, 3502, 3503, 3504, 3505, 3507, 3508, 3509, 3510, 3511, 3512, 3513, 4314
Aquifer Recharge, *See: recharge*
Aquifers, *See: recharge*
Argentina, 3014
Aridity, *See: arid climates*
Arid Climates, 2105, 2336, 2337, 3323
Asbestos, 2119
Ascaris, 2309, 2328, 2343, 3024, 3119, 4518
Asia, *See also: Southeast Asia*, 3007, 3009, 3321, 3354, 4309, 4312, 4502, 4509, 5014
Atomization, 6003, 6004, 6009, 6014, 6021, 6022
Atomized Sprays, *See: atomization*
Atomized Water, *See: atomization*
Australia, 3338, 4117
Autoflocculation, 3333
Bacteria, *See also: Enterobacteriaceae, enterococci, Escherichia coli, fecal bacteria, pathogens, Shigella*, 2218, 2227, 2315, 3006, 3016, 3340, 3344, 3508, 4101, 4114, 4127, 4207, 4210, 4408, 6025
Bacterial Contamination, 4109, 4111, 4150
Bacterial Die-Off, 3311, 4121
Bacterial Removal, 4127, 6026
Bacteriological Quality, 3324
Bahamas, 3213
Bangladesh, 2318, 3108, 3121
Barium, 4101, 4147
Batch System, 3314
Bathing, 6006, 6009, 6014, 6026, 6027
Belgian Congo, 3008
Belize City, 3103
Bibliography, 2335, 2338, 3217, 3238, 3309, 4201, 4214, 4302
Bighead Carp, 4208
Bioaccumulation, 3512, 4119, 4129
Biofilters, *See: biological filters*
Biofiltration, *See: biological filters*

- Biogas, *See also: digesters*, 3322, 3509, 3513, 4306, 4401, 4501, 4502, 4504, 4505, 4506, 4507, 4508, 4509, 4510, 4511, 4512, 4513, 4514, 4515, 4516, 4517, 4518, 4519, 4520, 4521, 4522, 4523, 4524, 4525, 4526, 4527, 4528, 4529, 4531, 4532
- Biological Discs, 3007, 3018, 3333
- Biological Filters, 2323, 2326, 3325, 3503, 4105
- Biological Treatment, 2355, 3016, 4301
- BOD, 2356, 3014, 3233, 3314, 3322, 3324, 3330, 3331, 3340, 3341, 3510, 3511, 4221, 4226, 5011
- Bolivia, 2121, 3214
- Borehole Latrines, *See also: pit latrines, trench latrines*, 2114, 2123, 2126, 2127, 2128, 2130, 2131, 2132, 3008
- Boron, 4155
- Botswana, 2207, 2301
- Box and Can Privies, *See: bucket latrines*
- Brazil, 3215
- Brine Shrimp, 4301, 4318
- British West Indies, 1007
- Bucket, *See: bucket latrines*
- Bucket Conservancy, *See: bucket latrines*
- Bucket Latrines, 1017, 2112, 3103
- Bucket Pump, 6020
- Bulrushes, *See: aquatic weeds*
- Burma, 3234
- Burning Toilets, *See: smoking-pit latrines*
- Cadmium, 3513
- Cage Rotor, 3314
- Cameroon, 3223
- Canada, 4314
- Caribbean, 2339
- Carp, 4206, 4208, 4216, 4223, 4224, 4303
- Cartage, 2122, 3029, 3101, 3105
- Catfish, 4208
- Centrifugation, 3333
- Cesspools, *See: pit latrines*
- Chad, 3204
- Chemical Characteristics, 3510, 4153
- Chemical Closets, *See: chemical toilets*
- Chemical Latrines, *See: chemical toilets*
- Chemical Substances, *See: chemical characteristics*
- Chemical Toilets, 2112, 2121
- Chile, 3340
- China, 2303, 2309, 3401, 3402, 3414, 4217, 4402, 4405, 4411, 4504, 4532
- Chloride, *See: chlorination*
- Chlorination, 2121, 3002, 4134, 4135, 4151, 5008
- Chlorinator, *See: chlorination*
- Chlorine, *See: chlorination*
- Clay, 2118
- Clothes Washing, 6006, 6009
- Coagulation, 3333, 5012
- Coconut Fibre, 5005, 5015, 5016
- COD, 3233
- Coliform, *See: bacteria*
- Coliform Bacteria, 2315, 3328, 3330, 4112, 4132, 4151, 4318
- Collection, *See: night-soil collection*
- Commercial Manufacture, 4222
- Common Carp, 4208
- Communal Latrines, *See: public toilets*
- Communal Toilets, *See: public toilets*
- Community, 1010, 1011, 2201, 2306, 2318, 2336, 3105, 3406, 4402, 4510, 4526, 6016, 6017
- Community Development, 3004
- Compost, *See: composting*
- Composting, 2135, 2202, 2205, 2207, 2209, 2211, 2215, 2216, 2218, 2220, 2221, 2222, 2223, 2225, 2226, 2230, 2232, 2235, 3401, 3402, 3404, 3405, 3406, 3407, 3409, 3410, 3411, 3412, 3413, 3414, 3415, 3416, 4129, 4408, 4411
- Composting Toilets, *See also: Vietnamese double vault, mouldering toilets*, 2101, 2201, 2210, 2212, 2214, 2217, 2218, 2224, 2227, 2233, 2234, 3029, 6009, 6024
- Compost Privy, 2125, 2136, 2206, 2207, 2208, 2219, 2223, 2228, 2229, 2230, 2231, 2232, 3403
- Computer Models, *See also: mathematical models*, 3021, 3022
- Concrete Latrines, 2119, 2339
- Congo, 2115
- Conservancy Systems, *See also: dipper and bucket, night-soil collection, vacuum trucks*, 1017, 3102, 3104, 3107, 3110, 3112, 3113, 4501
- Conservancy Tanks, 2112, 3101, 3102, 3112, 3118, 3343
- Conservancy Tank Effluent, *See: conservancy tanks*
- Conservation, *See: water saving*
- Construction, *See also: design*, 1002, 1004, 1011, 2101, 2102, 2106, 2119, 2125, 2126, 2134, 2135, 2137, 2201, 2206, 2208, 2228, 2231, 2234, 2302, 2304, 2306, 2307, 2308, 2318, 2325, 2331, 2340, 2345, 2353, 3005, 3027, 3218, 3224, 3303, 3347, 3351, 3352, 3406, 4504, 4507, 4512, 4521, 4523, 4526, 5005, 5007
- Consumer Acceptance, *See: public opinion*
- Contact Time, 4135, 4151
- Contamination, *See: pollution*
- Conventional Sewerage, *See: sewerage*
- Cost Analysis, *See: costs*
- Cost-Benefit, 3001, 3014, 3025, 3101, 3113, 3225, 4505, 4509
- Cost Effectiveness, *See: cost-benefit*
- Costs, *See also: sewer costs*, 2113, 2337, 3027, 3114, 3204, 3220, 3224, 3231, 3235, 3303, 3306, 3333, 4114, 4514, 6012, 6017, 6031
- Cow Dung, *See: animal wastes*
- Cow Manure, *See: animal wastes*
- Criteria, *See also: design*, 2219, 2232, 2308, 2325, 2342, 4153
- Crops, 4122, 4124, 4129, 4147, 4163, 4164, 4165, 4166, 4406
- Cuba, 3330
- Customs, 2216, 3102, 4526
- Cyprinus carpio*, *See: carp*
- Dairy Wastes, *See: animal wastes*
- Decomposing, *See: composting*
- Decomposition, 2220, 5011
- Decontamination, 4404
- Dehelminthization, *See also: helminths*, 4146
- Democratic Republic of Vietnam, *See: Socialist*

- Republic of Vietnam*
- Deposition Devices, 1002, 1006, 1011, 1015, 2102, 2125, 2136, 2208
- Design, *See also: design criteria, latrine design, construction*, 1001, 1002, 1004, 1011, 1015, 2109, 2125, 2201, 2206, 2222, 2223, 2228, 2229, 2230, 2302, 2303, 2306, 2318, 2330, 2333, 2340, 2345, 2349, 2350, 2351, 2353, 2354, 3007, 3027, 3105, 3228, 3235, 3304, 3305, 3312, 3313, 3324, 3326, 3331, 3340, 3341, 3351, 3354, 3406, 4304, 4306, 4502, 4507, 4508, 4520, 4521, 4522, 4528, 6002, 6004, 6017, 6022, 6024, 6027
- Design Criteria, *See also: design*, 2320, 2321, 2325, 2332, 3014, 3222, 3229, 3314, 3317, 3336, 3352, 4144, 6025
- Detention Time, 3014, 3015, 3316, 3317, 3319, 3322, 3331, 3336, 3502, 4315, 4317
- Detergent, 2324
- Developing Countries, *See also: individual countries*, 2106, 2110, 2203, 2225, 2235, 2305, 2335, 2351, 2352, 3001, 3020, 3021, 3022, 3023, 3114, 3217, 3220, 3225, 3227, 3238, 3239, 3241, 3309, 3352, 3501, 4143, 6010
- Devices, 6007, 6008, 6018, 6019, 6030
- Dewatering, 2321, 4303
- Diatoms, 4219
- Digested Sludge, *See: sludge*
- Digesters, *See also: biogas*, 4304, 4504, 4512, 4513, 4516, 4522
- Digestion Detention Time, *See: detention time*
- Dipper and Bucket, *See also: conservancy systems, night-soil collection, vacuum trucks*, 3101
- Diseases, *See also: fish diseases, malaria, pathogens*, 2318, 3102, 3112, 4138, 4402, 4406
- Dishwashing, 6006, 6009
- Disinfection, 2121, 4130, 4204, 4407, 5010, 6012
- Disposal, 1002, 2121, 2125, 2201, 2206, 2212, 2215, 2219, 2221, 2222, 2223, 2228, 2229, 2230, 2232, 2308, 2310, 2345, 2347, 2348, 2351, 3103, 3411, 3414, 4106, 4144, 4148, 4315
- Dissolved Oxygen, 3028, 4204, 4210, 4221, 4224, 4225, 4226
- Domestic, 3233, 3340, 3344, 3410, 4101, 4102, 4207, 4213, 4310, 4509, 6005, 6006, 6009, 6010, 6011, 6012, 6014, 6017, 6019, 6022, 6024
- Double Septic Bins, *See: Vietnamese double vault*
- Drainage, *See also: storm drains*, 3204, 3216, 3219
- Drinking Water, 5002
- Drip Irrigation, 4130
- Drum Aerators, 3009
- Dry Conservancy System, *See: conservancy systems*
- Dry Treatment, 2225
- Dual-Flush Toilets, *See: low-flush toilets*
- Ducks, 4215
- Duck Weeds, *See: aquatic weeds*
- Dump Tanks, 3103
- Earth Closets, 1012, 2221
- East Pakistan, *See Bangladesh*
- Economics, 2104, 2207, 2224, 2235, 3003, 3026, 3102, 3108, 3109, 3117, 3118, 3222, 3225, 3312, 3342, 3346, 3409, 4105, 4106, 4159, 4220, 4305, 4309, 4320, 4405, 4409, 4506, 4508, 4510, 4513, 4516, 4519, 4526, 4527, 6005
- Effluents, *See also: pond effluents, secondary effluents, septic tank effluent*, 2308, 2310, 2313, 2315, 2324, 2327, 2328, 2333, 2334, 2342, 2347, 2356, 3014, 3312, 3314, 3315, 3322, 3324, 3333, 3503, 4107, 4112, 4114, 4115, 4120, 4121, 4124, 4130, 4134, 4135, 4139, 4160, 4164, 4165, 4201, 4207, 4209, 4210, 4213, 4216, 4311, 4319, 4321
- Effluent Quality, *See: effluents*
- Effluent Reuse, 3307, 3318, 3325, 3351, 4103, 4309, 4312, 4313, 4316
- Electricity, *See: energy*
- Elutriation, 3010
- Energy, 4213, 4515, 4521, 4526
- Energy Conservation, 3028, 6005, 6009, 6013, 6015
- Energy Saving, *See: energy conservation*
- England, 1012, 2221, 6015
- Enterobacteriaceae, *See also: Escherichia coli*, 4203
- Enterococci, *See also: bacteria, Escherichia coli, fecal bacteria*, 3337, 4111, 4318
- Enterovirus, *See also: poliovirus, viruses*, 3016
- Environmental Hazards, 3013, 4126, 4157
- Equipment, 2131, 2317, 6016, 6017
- Escherichia coli*, *See also: bacteria, enterococci, fecal bacteria*, 3337, 4111
- Europe, 3408, 6013
- Evapotranspiration, 2302, 2329, 2334, 2341
- Excreta, *See also: animal wastes, urine*, 1003, 1008, 1017, 2104, 2108, 2112, 2122, 2123, 2125, 2126, 2128, 2133, 2134, 2136, 2202, 2205, 2209, 2212, 2213, 2218, 2220, 2223, 2226, 2231, 2303, 2309, 2312, 2330, 2343, 2350, 3010, 3015, 3024, 3102, 3103, 3105, 3108, 3111, 3112, 3117, 3118, 3119, 3120, 3225, 3229, 3234, 3346, 3401, 3402, 3403, 3404, 3406, 3408, 3413, 3509, 4140, 4217, 4401, 4402, 4405, 4406, 4407, 4408, 4410, 4411, 4412, 4512, 4517, 4530, 4531, 6024
- Excreta Disposal, *See: night-soil disposal*
- Excreta Removal, *See: night-soil disposal*
- Extended Aeration, *See also: aeraton*, 3026, 3027, 3028
- Facultative Lagoons, *See: facultative ponds*
- Facultative Ponds, *See also: stabilization ponds*, 3312, 3314, 3319, 3331, 3340, 3341, 3352
- Fecal Bacteria, *See also: bacteria, enterococci, Escherichia coli*, 2129, 3328, 3332, 4319
- Fertilization, 2212, 2218, 2223, 2227, 3323, 3401, 3404, 3408, 3409, 3411, 4113, 4126, 4214, 4217, 4223, 4402, 4403, 4405, 4411, 4412, 4515
- Fertilizer, *See: fertilization*
- Fiberglass Latrines, 2119
- Field Sanitation, 1006
- Filters, *See also: biological filters, percolating filters, trickling filters, upflow filters*, 2316, 2342, 2349, 2356, 5016
- Filtration, *See also: infiltration, sand filtration*, 2316, 3510, 5004, 5005, 5007, 5008, 5009, 5014, 5015, 6012
- Financing, 3025
- Finland, 2322

- Fish, *See also: carp, flounder, salmon, salmonids, Tilapia*, 3320, 4206, 4207, 4208, 4227
 Fish Culture, *See: aquaculture*
 Fish Diseases, 4203, 4205
 Fish Feeding, *See: aquaculture*
 Fish Harvesting, 3323, 3501, 4213
 Fish Meal, 4204, 4222, 4224
 Fishponds, 4202, 4216, 4217, 4220, 4223, 4224, 4405
 Fish Yields, 4202, 4204, 4208, 4223
 Flies, 3112, 3332, 4412
 Flooding, 3216
 Flooding Irrigation, *See: irrigation*
 Flood Prevention, 3219
 Flounder, 4219
 Flow Rate, 3233, 6012, 6013, 6016, 6021, 6025
 Flow Reduction, 6006, 6007, 6008, 6013, 6016, 6018, 6019
 Flow Restriction, *See: flow reduction*
 Flow Restrictor, *See: flow reduction*
 Flow-Through Ponds, 4223
 Flushing, *See: toilet performance*
 Flush Toilets, 1008, 1015, 2116, 2120, 2204, 2214, 3101, 3201, 3216, 6009, 6013
 Forest Agriculture, 4126, 4155
 France, 3342
 Freeze Toilets, 2209
 Freshwater Aquaculture, *See: aquaculture*
 Fuels, 4526
 Fumigation, *See: disinfection*
 Fungi, 4302
 Furrow Irrigation, 4102
- Garbage, 2121, 3401, 3402, 3409, 3412, 3413
 Garbage Compost, *See: composting*
 Gas Collection, *See: biogas*
 Gas Production, *See: biogas*
 Germany, *See: West Germany*
 Gobar Gas, *See: biogas*
 Granular Media Filtration, 3333
 Grass Carp, 4208
 Gravity Flow, 2108
 Greywater, 2103, 3103, 4104, 5003, 5004, 5005, 5007, 5008, 5009, 5011, 5013, 5017, 6013, 6014
 Groundwater, 2108, 2128, 2129, 2130, 4105, 4106, 4114, 4115, 4161
 Groundwater Contamination, *See: groundwater pollution*
 Groundwater Pollution, 2132, 2314, 3002, 3211
 Growth Kinetics, 4126, 4303, 4317
- Harbour Pollution, 3211, 3213
 Harvesting, *See: fish harvesting*
 Health, *See also: public health*, 2111, 2202, 3101, 3122, 3211, 3332, 3401, 3416, 4107, 4121, 4131, 4141, 4158, 4405, 4406, 5017
 Heavy Metals, *See also: metals*, 3334, 3410, 3512, 4119, 4125, 4129, 4152, 4212, 5012
 Helminths, *See also: dehelminthization*, 1005, 3506, 4102, 4145
 High-Rate Ponds, 3333, 4140, 4310, 4313, 4315
 Historical Aspects, 1012, 2110, 4519
- Holding Tank, *See: dump tanks*
 Hong Kong, 4208, 4217
 Hookworm, 2111, 2309, 2328, 4518
 Hot Climates, *See: tropics*
 Households, *See also: single houses*, 1001, 2108, 2112, 2125, 2206, 2214, 2215, 2219, 2221, 2223, 2228, 2229, 2230, 2306, 2310, 3102, 3106, 3226, 3235, 4306, 4402, 4510, 4526, 5004, 5013, 6004, 6007, 6016, 6018, 6020, 6024, 6031
 Housing, *See: single houses*
 Housing Sanitation, *See: single houses*
 Human Excreta, *See: excreta*
 Human Food, 3501, 4302, 4307, 4320
 Human Wastes, *See: excreta*
 Humidity, 2220, 3410
 Humus, *See: composting*
 Hygiene, *See also: public health, sanitation*, 1016, 2216, 2235, 2328, 3102, 3122, 6014, 6022, 6025
- Imhoff Tanks, 3026, 3303
 Incineration, 2121, 2312
 Incinerator Toilets, 2204, 6028
 India, 1002, 1004, 1005, 1006, 1013, 1014, 2102, 2111, 2114, 2117, 2122, 2123, 2124, 2133, 2312, 2323, 2328, 2334, 2356, 3019, 3105, 3107, 3116, 3121, 3122, 3201, 3221, 3233, 3301, 3302, 3304, 3305, 3306, 3307, 3310, 3314, 3317, 3318, 3335, 3337, 3341, 3350, 3355, 3403, 4103, 4104, 4110, 4133, 4136, 4149, 4153, 4158, 4206, 4211, 4213, 4216, 4217, 4316, 4404, 4407, 4501, 4505, 4506, 4508, 4510, 4511, 4518, 4519, 4520, 4521, 4522, 4524, 4525, 4526, 4527, 6021
 Indonesia, 2103, 3117, 4526
 Industrial Reuse, 4101, 4107
 Industrial Wastewater, 2104, 3334, 4108, 4112, 4122, 4223
 Infiltration, *See also: rapid infiltration, sand filtration*, 1011, 2107, 2125, 2314, 2319, 2322, 2326, 2355, 3002, 3005, 4115, 4148, 5003
 Installation, 2101, 2332, 3235, 3348
 Interceptor Canals, 3210
 Intestinal Parasites, *See: parasites*
 Investments, 4505, 4510
 Irrigation, *See also: spray irrigation*, 3208, 3215, 3318, 3323, 3325, 4101, 4102, 4103, 4104, 4105, 4106, 4109, 4110, 4111, 4112, 4113, 4114, 4116, 4118, 4120, 4121, 4122, 4123, 4133, 4135, 4136, 4137, 4139, 4142, 4145, 4149, 4152, 4153, 4155, 4158, 4159, 4162, 4163, 4164, 4165, 4166, 4215, 4404, 4406, 4407
 Israel, 3319, 3334, 3345, 3351, 4123, 4132, 4134, 4135, 4151, 4303, 4321
 Ivory Coast, 3216
- Jamaica, 3211
 Japan, 2316, 3012, 3101, 3118, 4409, 4526
 Jordan, 3206
- Kenya, 2105, 2113, 3017
 Kitchen Wastes, *See: organic wastes*

- Korea, 4409, 4526
- Labour Camps, 2114
- Lagoons, *See: stabilization ponds*
- Land Disposal, 4118, 4120, 4138, 4144, 4148, 4157, 4161, 4401
- Landfill, 2121, 3323, 3408
- Lateral Flow, 2108
- Latin America, *See: South America*
- Latrine Design, 1008, 2102
- Latrines, *See also: aqua-privies, borehole latrines, bucket latrines, concrete latrines, fiberglass latrines, compost privy, earth closets, pits latrines, pour-flush latrines, shallow-trench latrines, smoking-pit latrines, tablopan latrines, trench latrines, water-seal latrines, 1009, 2111, 2113, 2117, 2133, 2203, 2204, 2235, 2330, 3107, 3229*
- Latrine Vaults, *See: conservancy tanks*
- Leaching Chamber, *See: seepage pits*
- Less-Developed Countries, *See: developing countries*
- Light, *See: solar*
- Loading, 2313, 2315, 2316, 3308, 3316, 3317, 3331, 3336, 3338, 3352, 4156, 4157
- Loading Rates, *See: loading*
- Lobsters, 4129
- Low-Cost Treatment, 3302, 3307, 4227
- Low-Flush Cisterns, *See: low-flush toilets*
- Low-Flush Toilets, 6002, 6004, 6008, 6016, 6019, 6030
- Low Income, *See: low-income population*
- Low-Income Population, 2305, 3207, 3212, 3216
- Macrophytes, *See: aquatic weeds*
- Magnesium, 4124
- Maintenance, 1010, 2102, 2121, 2325, 2333, 2336, 2340, 3027, 3214, 3235, 3303, 3333, 3347, 3351, 4512, 4522
- Malaria, 3353
- Malaysia, 3110, 3205, 4217
- Management, 2312, 4120, 4157
- Manitoba, 2233
- Manual Collection, *See: night-soil collection*
- Manure, *See: animal wastes*
- Marine Aquaculture, 4203, 4212, 4219, 4318, 4319
- Materials, 2222, 2331, 5003, 5005, 5008, 5015, 5016
- Mathematical Models, *See also: computer models, 3020, 3023, 3228, 3324, 4317, 4516*
- Maturation Ponds, *See: stabilization ponds*
- Mechanical Aeration, 3014
- Metals, *See also: heavy metals, 2211, 4157*
- Methane, *See: biogas*
- Methane Production, *See: biogas*
- Mexico, 3026, 3212, 3303, 4101, 4147
- Microorganism Control, *See: microorganisms*
- Microorganisms, 2220, 5010
- Microstrainers, 3333
- Middens, 1012
- Middle East, 3231
- Mileage, 3109
- Mist Shower, *See: atomization*
- Models, *See: mathematical models*
- Mosquitoes, 3353
- Mouldering Toilets, *See also: composting toilets, Vietnamese double vault, 2202, 2203, 2204, 2205, 2209, 2211, 2213, 2220, 2226, 6024*
- Mound System, *See also: aqua-privies, septic tanks, 2308*
- Municipal Sewage, *See: sewage*
- Municipal Wastes, *See: solid wastes*
- Municipal Wastewater, *See: sewage*
- Mussels, 4218, 4319
- Natural Fish Food, *See: fish meal*
- Natural Purification, 3019
- Nepal, 3203
- Netherlands, 2107, 3505
- Nickel, 3513
- Nigeria, 2325, 2352, 3011, 3104, 3115, 3236, 3404
- Night Soil, *See: excreta*
- Night-Soil Collection, *See also: conservancy systems, dipper and bucket, vacuum trucks, 2121, 2317, 2345, 3105, 3106, 3107, 3115, 3117, 3118, 3119, 3202, 3219, 4140, 4405, 4408*
- Night-Soil Disposal, 1009, 1017, 2112, 2117, 2120, 2124, 2204, 2219, 3004, 3101, 3114, 3212, 3220, 3224, 3227, 3239, 3350, 4136, 4501, 4508, 4511, 4518, 4524
- Night-Soil Treatment, 2112, 3006, 3011, 3012, 3101, 3110, 3116, 3236, 3325, 3343, 4502, 4503, 4518, 4525
- Nitrates, 4157
- Nitrogen, 2303, 3002, 3340, 3502, 4124, 4530
- Nitrogen Bacteria, 5011
- Nitrogen Removal, 4219
- Norway, 2205, 2212, 2307, 2341
- Nozzles, 6020, 6021, 6022, 6025, 6026
- NTA, 2324
- Nutrients, 2341, 3411, 3501, 3503, 3507, 4110, 4113, 4118, 4120, 4139, 4207, 4210, 4314, 4315, 4514
- Nutrient Uptake, *See: nutrients*
- Nutrition, 4302, 4308, 4320
- Ocean Disposal, 3208, 4105
- Odours, 2220, 2301, 2356, 3316, 3338, 4403
- Oil Flush, 2116
- One-Line System, *See: one-pipe system*
- One-Pipe System, 6005, 6010
- On-Site Treatment, 2124, 2204, 2205, 2206, 2209, 2211, 2213, 2222, 2226, 2302, 2307, 2322, 2326, 2338, 2341, 2350, 3005
- Open Ditches, 2322
- Operation Manuals, 3349
- Organic Compounds, *See: organics*
- Organics, 2315, 3507, 3512
- Organic Wastes, 2212, 2213, 3121, 3311, 3316, 3349, 3408, 4221
- Overhead Irrigation, *See: irrigation*
- Overland Flow, 4124, 4144, 4156
- Overland Runoff, *See: overland flow*
- Oxidation Ditches, 3301, 3302, 3304, 3314, 3320, 3325, 3335, 3354, 4142
- Oxidation Ponds, *See: stabilization ponds*
- Oysters, 4212, 4219, 4319

Paddy Fields, 3506
 Pakistan, 3219
 Papua New Guinea, 2104, 4401
 Parasites, 3016, 3332, 4136, 4532
 Pasteurization, 3119, 4140
 Pathogens, *See also: bacteria*, 2108, 2212, 2343, 2346, 3329, 3332, 3341, 3402, 3403, 3412, 4109, 4111, 4121, 4127, 4136, 4140, 4151, 4161, 4157, 4403, 4404, 4504
 Peat Bogs, 2322
 Pedal Valves, 6009
 Percolating Filters, 3008, 3027
 Percolation, 2118, 2304, 2324, 2327, 2329, 2334, 4108, 4117, 4127
 Percolation Fields, *See: percolation*
 Peru, 3323, 4105
 pH, 2346, 4157, 4226
 Philippines, 2106, 2224, 4217, 4526
 Phosphorus, 2310, 2319, 3002, 3502, 4124, 5011
 Phosphorus Binding, *See: phosphorus*
 Phosphorus Removal, 5012
 Physical Characteristics, 4153
 Pisciculture, *See: aquaculture*
 Pit Latrines, *See also: borehole latrines, concrete latrines, shallow-trench latrines, smoking-pit latrines, tablopian latrines, trench latrines, water-seal latrines*, 1001, 1003, 1005, 1007, 1008, 1009, 1012, 1013, 1016, 2102, 2103, 2107, 2108, 2109, 2111, 2112, 2114, 2115, 2117, 2119, 2120, 2121, 2123, 2124, 2125, 2129, 2134, 2135, 2136, 2137, 2203, 2204, 2207, 2208, 2210, 2330, 2331, 2338, 3029, 3107, 3229, 3230
 Pit Privies, *See: pit latrines*
 Pits, *See: pit latrines*
 Planning, 2325, 3109, 3231, 3347
 Plant Nutrients, 2211
 Plants, *See: aquatic weeds, irrigation, vegetables*
 Plumbing, 6006, 6010, 6012, 6013, 6014, 6016, 6021
 Plumbingless Bathroom, 6022
 Poland, 4224
 Poliovirus, *See also: enterovirus, viruses*, 4151
 Pollution, *See also: air pollution, groundwater pollution, harbour pollution, soil pollution, water pollution*, 2108, 2123, 2129, 2130, 2313, 3210, 3504, 4139, 4157, 4160, 5001, 5013
 Pond Depth, 3317, 3322, 3331, 3336, 4315
 Pond Effluents, *See also: effluents, septic tank effluent*, 4155
 Pond Loading, 3347
 Ponds, *See: facultative ponds, fishponds, high-rate ponds, stabilization ponds*
 Pond Stratification, 3319
 Potassium, 4124
 Poultry Wastes, *See: animal wastes*
 Pour-Flush Latrines, 1010, 2122
 Power Consumption, 3314
 Primary Treatment, 3026, 3303
 Privies, *See: pit latrines*
 Protein, 4143, 4307, 4308, 4309, 4310, 4315, 4320
 Protozoa, 3016
 Public Acceptance, *See: public opinion*
 Public Attitudes, *See: public opinion*
 Public Health, *See also: health*, 1002, 1011, 2115, 2124, 2216, 2231, 2318, 2325, 2328, 2332, 3024, 3102, 3105, 3112, 3201, 3207, 3313, 3344, 3347, 3405, 3414, 3501, 4103, 4106, 4107, 4135, 4136, 4139, 4148, 4149, 4159, 4207, 4307, 4402, 4404, 4509, 5001, 5008, 6010
 Public Opinion, 1002, 1009, 1011, 2104, 2115, 2207, 2210, 3102, 4116, 4154, 4202, 4204, 4320, 4505, 4526, 6008
 Public Opposition, *See: public opinion*
 Public Showers, 3216
 Public Toilets, 1010, 1011, 2103, 2109, 2114, 2117, 2201, 2318, 2325, 2336, 3216
 Purifying Plants, *See: small-scale purifying plants*
 Push-Button Faucet, 6005, 6010
 Rainwater, 3204
 Rapid Infiltration, 4114, 4124, 4144
 Recharge, 3319, 4106, 4114, 4115, 4117, 4128, 4147, 4148, 4160
 Reclamation, *See: reuse*
 Red Mud, *See: aluminized red mud solids*
 Refuse, *See: garbage*
 Renovation, 4114, 4115
 Residential Water, *See: water supply*
 Resorption, 2307, 2326, 2341
 Reuse, *See also: effluent reuse*, 3119, 3242, 3323, 3349, 3401, 3411, 3501, 3502, 4106, 4116, 4120, 4128, 4129, 4139, 4140, 4143, 4151, 4154, 4158, 4163, 4201, 4207, 4210, 4216, 4304, 4313, 4315, 4401, 4410, 4509, 5001, 5008, 5009, 5017, 6004, 6012, 6019
 Rhodesia, 1001, 1016, 3235, 4159
 Rotating Biological Contractors, 3007, 3009, 3018
 Rotating Biological Drums, 3009
 Rotor Speed, 3314
 Rural, 1001, 1002, 1004, 1011, 1016, 2102, 2105, 2120, 2125, 2133, 2208, 2210, 2216, 2219, 2223, 2228, 2230, 2307, 2317, 2326, 2338, 2345, 3005, 3020, 3025, 3114, 3121, 3209, 3214, 3215, 3226, 3304, 3305, 3406, 3411, 3414, 4137, 4306, 4504, 4505, 4506, 4507, 4510, 4511, 4512, 4515, 4517, 4521, 4526, 4527, 4528, 5013, 6016
 Rural Sanitation, 1006, 1013, 1014, 2111, 2114, 2117, 2124, 3004, 3114, 4216, 4524, 4525
 Rural Wastewater Disposal, *See: sewage*
 Rush Ponds, *See: aquatic weeds*
 Salinity, *See: salts*
 Salmon, 4203
 Salmonella, 2313, 3016, 4132, 4318
 Salmonids, 4205
 Salts, 4101, 4110, 4120
 Sand, 2107, 2342, 5007
 Sand-Filter Beds, *See: sand filtration*
 Sand Filters, *See: sand filtration*
 Sand-Filter Trenches, 2326, 3005, 3339
 Sand Filtration, *See also: infiltration*, 2307, 2310, 2313, 2334, 2337, 3005, 3221, 3315, 3333
 Sandy Soils, 2108
 Sanitary Latrines, *See: pit latrines*
 Sanitation, *See also: slum sanitation, rural sanitation*,

1007, 2103, 2116, 2137, 2203, 2216, 2222, 2232,
 2309, 3013, 3025, 3106, 3113, 3117, 3122, 3217,
 3224, 3230, 3232, 4143, 6024
 Scallops, 4319
 Seaweeds, 4219
 Secondary Effluents, 4152, 4159, 4162, 4212
 Secondary Treatment, 3026, 3303, 4159
 Sedimentation, 3303, 3330, 4127, 4146, 5010
 Seepage Pits, 1010, 1011, 2302, 2308, 2312, 2327,
 2334, 2336, 2347, 5004
 Self-Flushing, 1003, 1008, 1016
 Septic Closets, 2112
 Septic Tank Effluent, *See also: effluents, pond
 effluents*, 2334, 2344
 Septic Tanks, *See also: aqua-privies, mound system*,
 1005, 1007, 1010, 1011, 2104, 2109, 2114, 2121,
 2122, 2203, 2302, 2303, 2304, 2306, 2308, 2309,
 2310, 2311, 2312, 2313, 2315, 2316, 2317, 2320,
 2321, 2324, 2327, 2328, 2329, 2330, 2331, 2332,
 2333, 2334, 2336, 2337, 2338, 2340, 2342, 2345,
 2347, 2348, 2349, 2350, 2353, 2354, 2355, 2356,
 3003, 3008, 3011, 3026, 3101, 3113, 3201, 3209,
 3236, 3237, 3325, 3329, 3332, 3335, 4407
 Series Filtration, 5015
 Settlement Tanks, *See: settling tanks*
 Settling Ponds, 4122
 Settling Tanks, 3028
 Sewage, *See also: ship sewage, waste-disposal systems*,
 2105, 2112, 2113, 2118, 2304, 2310, 2312, 2328,
 2335, 2348, 2350, 3019, 3023, 3201, 3213, 3229,
 3231, 3233, 3319, 3325, 3332, 3338, 3346, 3415,
 3503, 3505, 3508, 3509, 4102, 4103, 4104, 4109,
 4110, 4111, 4113, 4117, 4118, 4119, 4121, 4122,
 4123, 4125, 4128, 4132, 4133, 4136, 4137, 4141,
 4143, 4145, 4146, 4149, 4150, 4151, 4159, 4161,
 4201, 4206, 4209, 4217, 4222, 4224, 4225, 4227,
 4305, 4308, 4310, 4314, 4315, 4317, 4404, 4410,
 4514, 4517, 6028
 Sewage Effluents, *See: effluents*
 Sewage Lagoons, *See: stabilization ponds*
 Sewage Sludge, *See: sludge*
 Sewage Treatment, 2104, 2110, 2112, 2122, 2214,
 2223, 2305, 2315, 2316, 2317, 2318, 2323, 2334,
 2337, 2344, 3005, 3007, 3008, 3009, 3014, 3016,
 3017, 3018, 3020, 3021, 3022, 3026, 3028, 3110,
 3111, 3116, 3118, 3119, 3120, 3201, 3213, 3218,
 3221, 3226, 3232, 3235, 3237, 3240, 3242, 3301,
 3302, 3303, 3304, 3305, 3306, 3307, 3308, 3309,
 3310, 3311, 3313, 3314, 3315, 3317, 3318, 3320,
 3321, 3324, 3325, 3327, 3329, 3331, 3335, 3337,
 3338, 3341, 3342, 3344, 3345, 3347, 3348, 3349,
 3350, 3354, 3355, 3405, 3408, 3501, 3504, 3505,
 3506, 3507, 3508, 3510, 3511, 3512, 4106, 4108,
 4131, 4142, 4156, 4158, 4163, 4214, 4218, 4220,
 4309, 4311, 4312, 4407, 4508, 4509, 5012, 5016,
 6012, 6028
 Sewerage, 2122, 2345, 2351, 3003, 3008, 3101, 3104,
 3106, 3108, 3110, 3111, 3113, 3116, 3118, 3120,
 3201, 3202, 3203, 3204, 3205, 3206, 3207, 3208,
 3210, 3211, 3212, 3214, 3215, 3216, 3217, 3218,
 3219, 3223, 3224, 3228, 3229, 3231, 3234, 3236,
 3240, 3325, 4313, 6030
 Sewer Costs, *See also: costs*, 3221, 3222
 Sewers, *See: sewerage*
 Shallow-Trench Latrines, 2127
 Shallow Wells, 2128
 Shellfish, *See also: lobsters, mussels, oysters, scallops,
 shrimps*, 4319
Shigella, 3016, 4318
 Ship Sewage, 3213
 Showering, 6014, 6022, 6025, 6026, 6027
 Shredded Refuse, 4514
 Shrimps, 4301
 Silver Carp, 4208
 Singapore, 2128, 3111, 3202, 3207, 4503
 Single Houses, 2104, 2307, 2326, 3005, 3230
 Sludge, *See also: activated sludge*, 2311, 2321, 3011,
 3109, 3207, 3210, 3339, 3340, 3409, 3410, 3412,
 3415, 3508, 4106, 4119, 4125, 4126, 4129, 4138,
 4139, 4152, 4403, 4412, 4503, 4514, 4517
 Sludge Drying, 4501
 Sludge Lagooning, 3339
 Slum Sanitation, *See also: sanitation*, 2117
 Small Communities, 2314, 2335, 3237
 Small-Scale Purifying Plants, 2209, 3005
 Smoking-Pit Latrines, 2127, 2209, 3008
 Soakage Pits, 2114, 2133
 Soaps, 6001
 Social Acceptance, *See: public opinion*
 Socialist Republic of Vietnam, 2202, 2216
 Socioeconomic, 2352, 3017, 3121, 3122, 4154, 4510,
 4515
 Sodium Absorption Ratio, 3351, 4110
 Soils, 2108, 2118, 2218, 2342, 2354, 4101, 4127, 4161,
 4412
 Soil Absorption, *See: absorption*
 Soil Amendment, 2211
 Soil Conditioners, 2212, 3501
 Soil Mantle, 3333
 Soil Percolation, *See: percolation*
 Soil Pollution, *See also: pollution, water pollution*,
 2107, 2121
 Solar, 3311, 3312, 4134, 4146, 4213, 4317, 5006
 Solids, 2346, 2356, 3330, 3510, 3511, 4120
 Solid Wastes, 2218, 3321, 3323, 3404, 3407, 4513,
 6017, 6023
 South Africa, 3111, 3343, 4412, 4507
 South America, 3004, 3016, 3025, 3348, 3352
 Southeast Asia, *See also: Asia*, 3231, 3321, 3325
 Space Shower, 6026, 6027
 Spray Faucets, 6015, 6029
 Spraying, *See: sprays*
 Spray Irrigation, 4124, 4131, 4132, 4138, 4144, 4145,
 4150, 4160, 4161, 4211
 Sprays, 4148, 4153, 6020, 6021
 Spray Taps, *See: spray faucets*
 Spring-Loaded Faucet, 6010
 Sprinkling Irrigation, *See: spray irrigation*
 Squatting Plates, *See: deposition devices*
 Sri Lanka, 1011, 4528
 Stabilization Ponds, *See also: facultative ponds*, 2104,
 2113, 2114, 2122, 2203, 2305, 2324, 2334, 3003,
 3014, 3026, 3027, 3028, 3104, 3204, 3205, 3208,
 3209, 3219, 3230, 3235, 3301, 3303, 3307, 3308,
 3310, 3311, 3313, 3315, 3316, 3317, 3318, 3323,
 3324, 3325, 3326, 3327, 3328, 3329, 3330, 3331,

3332, 3334, 3335, 3336, 3337, 3340, 3341, 3342, 3343, 3344, 3345, 3346, 3347, 3348, 3351, 3352, 3353, 3355, 3502, 3506, 3509, 3510, 3511, 3512, 4122, 4123, 4134, 4135, 4142, 4158, 4207, 4209, 4210, 4213, 4216, 4225, 4226, 4227, 4309, 4311, 4313, 4314, 4315, 4316, 4317, 4321, 4401, 4501, 4518
 Standards, 5001, 5002
 Starch Factory Wastes, *See: industrial wastewater*
 Storm Drains, *See also: drainage*, 1007
 Storm Water, *See: rainwater*
 Straining, *See: bacterial removal*
 Subsoil Irrigation, *See: subsurface irrigation*
 Subsurface Disposal, 2107, 2328
 Subsurface Filtration, *See: sand filtration*
 Subsurface Irrigation, 2320, 2334, 2344, 4145, 4153
 Sudan, 3013
 Sugar Industry Wastewater, *See: industrial wastewater*
 Sugar Pulp Wastewater, *See: industrial wastewater*
 Sulfur, 4124
 Sullage, *See: greywater*
 Surveys, 3102, 3227, 6016
 Survival Times, *See: bacterial die-off*
 Suspended Solids, *See: solids*
 Swaziland, 3209
 Sweden, 2201, 2212, 2226, 2227, 3409, 5011
 Swine Manure, *See: animal wastes*

Tablopan Latrines, 2119
 Taiwan, 2316, 3006, 3101, 3102, 3112, 3120, 4217, 4409
 Tank Trucks, *See: vacuum trucks*
 Tanzania, 1009, 2210
 Technical, 2110, 4154, 4320, 4409, 4523, 5006
 Technical Aspects, *See: technical*
 Technology, *See: technical*
 Temperature, 2213, 2220, 3311, 3312, 3340, 4412, 4514
 Testing, *See: analysis*
 Thailand, 2106, 3119, 3320, 4313, 4526, 5006, 5015
 Theory, 3336, 3347, 3405, 4529
 Tilapia, 4208
 Toilet Flushing, *See: toilet performance*
 Toilet Performance, 6002, 6006, 6012, 6024
 Toilets, *See: composting toilets, flush toilets, public toilets, two-cycle toilets, vacuum toilets*
 Toxic Substances, 4125, 4210
 Treated Effluent, *See: effluents*
 Treatment, *See: sewage treatment*
 Trench Latrines, *See also: pit latrines*, 1006
 Trickling Filters, 2333, 2334, 3003, 3301
 Tropical, *See: tropics*
 Tropical Countries, *See: tropics*
 Tropics, 2351, 3009, 3016, 3018, 3217, 3218, 3230, 3316, 3323, 3324, 3326, 3330, 3331, 3339, 3353, 3354, 4102, 4313
 Truck Collection, *See: conservancy systems*
 Tunisia, 3210
 Two-Cycle Toilets, 6028
 Two-Partitions-Three-Tanks System, *See: septic tanks*

Unicellular Algae, *See also: algae*, 4219
 Unsewered System, 2113
 Upflow Filters, 2356
 Upgrading, *See: sewage treatment*
 Urban, 2217, 2219, 2224, 2232, 2351, 3029, 3102, 3106, 3112, 3114, 3117, 3201, 3205, 3208, 3209, 3210, 3213, 3215, 3221, 3223, 3226, 3227, 3302, 3321, 3350, 3401, 3406, 3409, 4412, 4501
 Urban Renewal, 3202, 3207
 Urinals, 1015, 2101
 Urine, *See also: excreta*, 2202, 2303, 2346, 3402, 3408, 4531
 USA, 2206, 2217, 2229, 2306, 2327, 2337, 2338, 2342, 2347, 3109, 3233, 3336, 3344, 3415, 3503, 3511, 4108, 4114, 4115, 4116, 4117, 4120, 4148, 4152, 4154, 4155, 4156, 4157, 4161, 4201, 4205, 4207, 4218, 4308, 4403, 4514, 5013, 6013, 6019
 USSR, 2313, 3506, 4102, 4109, 4111, 4122, 4146, 4150
 Utilization, *See: reuse*

Vacuum Filters, 3303
 Vacuum Toilets, 6008, 6017, 6028
 Vacuum Trucks, *See also: conservancy systems, night-soil collection*, 3101, 3109, 3110, 3113, 3117, 3118, 3119
 Vault Privies, *See: conservancy tanks*
 Vault Systems, *See: conservancy systems*
 Vegetables, 4102, 4119, 4125, 4130, 4138
 Venezuela, 2119, 3016, 3316
Vibrio cholerae, 2346
 Vietnam, *See: Socialist Republic of Vietnam*
 Vietnamese Double Vault, *See also: composting toilets, mouldering toilets*, 2202, 2216
 Village Sanitation, *See: rural sanitation*
 Viruses, *See also: enterovirus, poliovirus*, 2118, 2342, 3016, 3344, 4107, 4120, 4127, 4128, 4134, 4138, 4160, 5010

Washing, *See: washing apparatus, dishwashing, clothes washing, bathing, showering*
 Washing Apparatus, 6001, 6003
 Washwater, *See: greywater*
 Waste-Disposal Systems, *See also: sewage*, 2335, 3001, 3225, 3229, 6024
 Wastes, *See: animal wastes, excreta, wastewater*
 Wastewater, *See also: industrial wastewater*, 2214, 2302, 2307, 2314, 2317, 2319, 2322, 2324, 2326, 2337, 2341, 3002, 3005, 3028, 3226, 3235, 3238, 3240, 3241, 3310, 3312, 3322, 3323, 3336, 3340, 3501, 3506, 4107, 4116, 4128, 4144, 4148, 4152, 4153, 4154, 4160, 4163, 4165, 4166, 4203, 4205, 4207, 4213, 4220, 4223, 4307, 4403, 4405, 5001, 5003, 5008, 5010, 5013, 6004, 6005, 6007, 6016, 6018, 6019
 Wastewater Collection, *See: sewerage*
 Wastewater Disposal, *See: sewage*
 Wastewater Effluent, *See: effluents*
 Wastewater Reduction, *See: water saving*
 Wastewater Reuse, 3208, 4101, 4105, 4131, 4147, 6011, 6023, 6028
 Wastewater Treatment Plants, 3027

Water, 2109, 5005, 6001, 6003, 6017, 6030
 Waterborne Disposal, *See: sewerage*
 Water Closet, *See: flush toilets*
 Water Collection, 6025, 6026, 6027
 Water Conservation, *See: water saving*
 Water Consumption, 3224, 5013, 6005, 6010, 6016,
 6018, 6019, 6023, 6032
 Water Heaters, 6009, 6013
 Water Hyacinths, *See: aquatic weeds*
 Waterless Toilets, 2116, 2219
 Water Pollution, *See also: groundwater pollution,*
pollution, soil pollution, 2128, 4211
 Water Quality, 3240, 4101, 5002, 6023, 6026
 Water Reclamation, *See: reuse*
 Water Recovery, 6017, 6023
 Water Reduction, *See: water saving*
 Water Reuse, *See: wastewater reuse*
 Water Saving, 1001, 2222, 2234, 2317, 3213, 6001,
 6002, 6003, 6004, 6005, 6006, 6007, 6008, 6009,
 6010, 6011, 6012, 6013, 6014, 6015, 6016, 6017,
 6019, 6021, 6022, 6024, 6025, 6026, 6027, 6028,
 6029, 6030, 6031, 6032
 Water-Saving Devices, *See: water saving*
 Water-Seal Latrines, 1001, 1003, 1004, 1006, 1013,
 1014, 2106, 2133
 Water-Seal Privies, *See: water-seal latrines*
 Water-Seal Toilets, *See: flush toilets*
 Water Supply, 1011, 2305, 3004, 3106, 3201, 3203,
 3206, 3208, 3211, 3212, 3214, 3215, 3217, 3219,
 3220, 3232, 3239, 3240, 3321, 4143, 5002, 6002,
 6010, 6013, 6018, 6031, 6032
 Water Treatment, 3013, 3240, 5007, 5014, 5015
 Water Usage, *See: water consumption*
 Weeds, *See: aquatic weeds*
 West Germany, 3508, 4201, 4220
 Wet-Air Oxidation, 3012, 3118
 Wheelbarrow, *See: cartage*
 Yemen Arab Republic, 3003, 3208
 Yugoslavia, 2343
 Zambia, 4215, 6031

Author Index

- Abaev, A. N., 4146
Abdulappa, M. K., 4136, 4213
Adams, E. G., 3001
Aftab, M. P., 5006
Agersborg, H. P. K., 4218
Agrawal, G. D., 3308
Agrawal, M. C., 3221
Alagarsamy, S. R., 3301, 3304, 3305, 3306, 3307
Algie, W. E., 3235
Aliaga, P., 3340
Allen, G. H., 4201, 4202, 4203, 4204, 4205
Amirov, R. O., 4102
Anwikar, A. K., 4136
Applegate, C. H., 4108
Aqurre, J., 4101
Arcevala, S. J., 3304, 3305, 3306, 3307
- Baars, J. K., 2107
Babov, D. M., 4109
Bache, C. A., 4125
Bagnall, L. O., 3502
Bailey, J. R., 6007, 6008
Bajaj, K. L., 4110
Banerjee, S. C., 4209
Bartley, C. H., 3344
Basu, A., 3310
Batson, M. S. C., 3024
Batten, C. E., 5008
Baubinas, A. K., 4111
Bell, R. G., 4112
Bender, T., 6009
Bendixen, T. W., 2348
Benoit, R. J., 6007
Berk, M., 2348
Berry, W., 2206
Betzer, N., 3334
Bhalerao, B. B., 3301, 3306
Bhaskaran, T. R., 1005, 2123, 3403
Bhatia, I. S., 4110
Biddlestone, A. J., 3407
Bishnoi, O. P., 4113
Blackmore, M. D., 2207
Blanc, M., 2208
Bobeda, C., 6010
Bokil, S. D., 3308
Boparai, M. S., 1006
Boquin, G., 2121
Borjesson, E., 6010
Bose, P. C., 4206
Boston, H. E., 6011
Bouma, J., 2308
- Bouwer, H., 4114, 4115, 4128
Boydell, R. A., 2207
Boyle, W. C., 2337, 3226, 5013
Brandsdorfer, A., 6013
Braswell, J. A., 5010
Briscoe, J., 3121
Brown, J. C., 3025
Bruvold, W. H., 4116
Brzeczek, M., 6025
Buchanan, I. C., 2339
Busch, A., 4203
Buzzell, T., 4144
- Caldwell, E. L., 2108, 2129
Campbell, P. A., 2349
Campos de Carvalho, M. E., 2109
Canter, L. W., 3309
Carpenter, R. L., 4205, 4207
Chakladar, N., 2356
Chan, W. L., 4208
Chaudhuri, N., 3310
Chen, C. S., 3007
Chowdhry, N. A., 2310
Chuang, F. S., 2311
Clark, R., 3407
Clemesha, W. W., 2312
Coffey, K., 2110
Cohen, S., 6011, 6012
Coleman, M. S., 4207
Contractor, J. C., 3221
Converse, J. C., 2308
Cooley, J. H., 4155
Cornwell, D. A., 3503
Coulter, J. B., 2348
Crites, R. W., 4117
Culley, Jr, D. D., 3504
- Dabadghao, S. B., 2133
Danielsson, K., 2209
Day, A. D., 4118
de Azevedo Netto, J. M., 3222
DeJong, J., 3505
de V. Clarke, V., 1016
Devroey, E., 3008
Discenza, R., 3021, 3022
Dodd, J. D., 3507
Dodson, J. L., 6007
Dolivo-Dobrovolskii, L. B., 4146
Dowdy, R. H., 4119
Drews, R. J. L. C., 3311, 3332, 3347

Duchinskii, B. M., 2313
 Dugan, G. L., 4120, 4304
 Dunlop, S. G., 4121
 Dunstan, W. M., 4319
 Dyer, B. R., 2132
 Dyer, E. A., 3110

Edling, M., 5003
 Ehlers, V. M., 2134, 2350
 Ekern, P. C., 4120
 Ekstrand, G., 5003
 Elong, P. M., 3223
 Enayatullah, 3009
 Endo, I., 3015
 Englov, P., 2314
 Epps, E. A., 3504
 Escarcega, E. D., 4115
 Espinoza, R., 3025
 Eygelaar, J., 2210

Feachem, R. G., 2305
 Fedotov, V. E., 4122
 Feinmesser, A., 4123
 Fetter, Jr, C. W., 2315
 Filip, D. S., 3315
 Fishelson, L., 4134
 Fitzgerald, E. L., 2316
 Fletcher, P., 6013
 Florida, N., 4506
 Fogel, M., 2211, 5004
 Fogg, C. E., 4124
 Fowell, A., 6013
 Fowler, G. J., 4206
 Fraenkel, P., 4517
 Francette, M., 3342
 Francis, L., 2355
 Frankel, R. J., 5005
 Fry, L. J., 4507
 Fuller, B., 6014
 Furman, T. D. S., 3502, 3503
 Furr, A., 4125

Gadkari, A. S., 2111
 Gagnon, J. D., 4126
 Ganesh, S., 4527
 Gay, D. E., 6015
 Gearheart, R. A., 3333
 Gerba, C. P., 4127, 4128
 Gervais, M., 3342
 Ghosh, A., 4209
 Ghosh Roy, B. K., 3403
 Gien, I., 3010
 Gilbert, R. G., 4128
 Gilles, E. C., 3404
 Giordano, P. M., 4129
 Gloyna, E. F., 3312, 3313
 Goldberg, S. D., 4130
 Goldstein, S. N., 2317, 6016
 Golueke, C. G., 3405, 3416, 4304, 4305, 4306
 Goode, G. S. G., 3231

Gordon, J., 3513
 Gorkopenko, F. G., 4122
 Gotaas, H. B., 3406
 Govindan, S., 4216, 4227
 Gray, D. V., 4108
 Gray, K. R., 3407
 Grenney, W. J., 3333
 Grisanti, N. E., 4307
 Guarneri, C., 6017
 Gudding, R., 3412
 Gutierrez, L., 2121

Hall, J., 6026
 Handa, B. K., 2111, 2133, 3355
 Hansen, J. A., 3225
 Hanumanulu, V., 4508
 Hardenbergh, W. A., 2112
 Haridass, G., 3314
 Harris, S., 6025, 6026
 Harris, S. E., 3315
 Hettman, Jr, H., 4308
 Hennessy, P. V., 3108
 Hentges, Jr, J. F., 3502
 Hephher, B., 4204, 4210
 Hernandez, L., 3316
 Hershaf, A., 6018, 6019
 Hill, D. W., 3315
 Hillmer, Jr, T. J., 3109
 Hills, L. D., 3408
 Hindhaugh, G. M. A., 3011
 Hinesly, T. D., 4131
 Hintz, H. F., 4308
 Hogg, C., 3110
 Holland, R. J., 2113
 Hook, J. E., 4152
 Hovsenius, G., 3409, 3410
 Howard, J., 2318
 Howley, J. E., 2321
 Htun, M. N., 5006
 Huat, T. T., 3111
 Hu-nan Chung i Yoa, 4408
 Husman, L., 5007
 Hutzler, N., 3226
 Hvatum, O. O., 2319
 Hypes, W. D., 5008

Ihrig, D., 6023
 Ikeda, I., 3012
 Impey, L. H., 2320
 Irons, F., 6020

Jackson, K., 4156
 Jahn, S. A., 3013
 Jalal, K. F., 3411
 Jarman, R., 4207
 Jayangoudar, I. S., 3317
 Jayawardena, J., 4528
 Jewell, W. J., 2321
 Jhingran, V. G., 4211
 Jounge, L. D., 2212

Julius, D., 4409

 Kabbash, A., 5009
 Kamppi, A., 2322
 Kardos, L. T., 4152, 4162, 4166
 Karlgren, L., 5011
 Katterman, F. R., 4118
 Katzenelson, E., 4132
 Katzenstein, L. B., 5010
 Keimakh, A. S., 4109
 Kenneth, L., 3226
 Keppie, G., 6031
 Kerfoot, W. B., 4212
 Khan, A. N., 2323
 Kharkar, C. B., 2114, 3318
 Kigel, T. V., 4141
 Kim, J. I., 3503
 Kira, A., 1015
 Klausner, S. D., 4162
 Klein, S. A., 2324, 2355
 Kochar, V., 3122
 Koltypin, Y. A., 3506
 Koneigsberger, O. H., 3227
 Kothandaraman, V., 3317
 Kotta, R. R., 4133
 Kott, H., 4134
 Kott, Y., 3334, 4135
 Kouete, J. R., 2115
 Ko Wei Hui, 4408
 Krafft, R. J. G., 2325
 Krasil'shchikov, D. G., 4150
 Kremer, M., 3319
 Krishnamoorthi, K. P., 4136, 4213
 Krogstad, O., 3412
 Kruse, C. W., 3024
 Kuklausner, S., 4162
 Kulkarni, B. W., 4225
 Kulkarni, S. W., 2111
 Kuttera, K., 4137

 Lakshminarayana, J. S. S., 3305, 3307
 Lance, J. C., 4114
 Langer, W. F., 3108
 Langshaw, C. L., 1007
 Lanoix, J. N., 2125, 2230, 2345
 Larkin, E. P., 4138
 Larson, W. E., 4119
 Lau, L. S., 4120
 Law, J. P., 4139
 Lee, E. S., 4309
 Lee, S. J., 3320
 Lee, T. L., 4312
 Lefebvre, B., 2234
 Leich, H. H., 2116
 Lemoine, L., 3228
 Lenda, J., 6025, 6027
 Leung, N. H., 4312
 Lewis, A. L., 4160, 4161
 Lien, J. C., 3112
 Lin, C. D., 4311
 Lin, Y. S., 3108

 Lindbak, P., 2326
 Lindstrom, C. R., 2213, 2214, 5004
 Lindstrom, R., 2215
 Ling, H. C., 3321
 Lisk, D. J., 4125
 Lloyd, B., 2318
 Lloyd, C. J., 6030
 Loh, P. C. S., 4120
 Lyakhnovich, V. P., 4223

 Machmeier, R. E., 2327
 Majumder, N., 2117, 2328
 Makarenko, E. V., 4141
 Malan, W. M., 2329
 Malina, J. F., 3309, 3322
 Malnatif, L., 3323
 Mani, J. S. V., 6021
 Mann, H. T., 2330, 3237
 Mansuri, M. G., 2122
 Mara, D. D., 2305, 2349, 2351, 3324, 3325, 3326
 Marais, G. V. R., 3229, 3230, 3235, 3327, 3328, 3329
 Marks, R., 6014
 Marsh, J. H., 4163
 Marshall, G. R., 3333
 Martinez, C. F., 3330
 Martinez, J. M., 3014
 Mathuswamy, S., 4227
 Matson, S., 2135
 Matsumoto, J., 3015
 Mayeux, J., 6023
 Mays, D. A., 4129
 Mbere, N., 2207
 McCalla, T. M., 4403
 McDonald, R. C., 3509, 3510, 3511, 3512, 3513
 McGarry, M. G., 3113, 3114, 3331, 4140, 4310, 4311, .
 4312, 4313, 4402, 4509, 4532
 McGauhey, P. H., 2355
 McKernan, J. M., 2233
 McMichael, F., 3240
 McMichael, J. K., 2216
 McWhorter, D. B., 4157
 Meiring, P. G. J., 3332, 3346, 3347
 Melnick, J. L., 4127, 4128
 Merto, J. L., 4308, 4311
 Metcalfe, T. G., 3344
 Meyer, J. H., 4308
 Michel, C., 3228
 Middlebrooks, E. J., 3315, 3333
 Mijares, C. R., 3016
 Milivoj, P., 4410
 Miller, N., 3115
 Milne, M., 6032
 Minear, R. A., 2332
 Miner, J. R., 3507
 Moberg, Jr, W. J., 2317, 6016
 Mohanrao, G. J., 3019, 3116, 3341
 Morgan, D. C., 2233
 Morgan, P., 1008
 Morgan, P. R., 1016
 Morrow, D., 3117
 Morse, A. B., 6022
 Mortimer, C. H., 4214

Mortimer, M. H. E., 4215
 Morton, S. D., 2118
 Morton, W., 4203
 Mortvedt, J. J., 4129
 Moselele, P., 2207
 Moshe, M., 3334
 Moulik, T. K., 4510
 Mountan, C. W., 4160, 4161
 Mudri, S. S., 4511
 Muga, E., 3017
 Muhondwa, E. P. Y., 1009
 Muiga, M. I., 3023
 Mukherjee, D. B., 3403
 Mulnwa, L., 4215
 Munichami, M., 3350
 Murawczyk, C., 6023
 Murthy, C. K., 3335
 Murthy, C. R. N., 3335
 Murty, K. R., 3335
 Muthuswamy, S., 4216, 4227

Nadgir, K. N., 3335
 Nadvornyi, N. N., 4109
 Nagar, B. R., 4512
 Nair, J. V., 3018
 Nair, K., 4206
 Natarajan, C. V., 3019
 Neary, D. G., 4155
 Nedved, T. K., 2332
 Neil, J. H., 4314
 Nesbitt, P. M., 2217
 Nesman, R., 3344
 Ng, K. S., 4312
 Nguy, A., 4165
 Nichols, H. W., 2218
 Nimpuno, K., 2219, 2235
 Nolan, W. J., 3502
 Novoderzhkina, Y. G., 4141

Oakley, H. R., 3231
 Obeng, L. E., 2309
 Okun, D. A., 4143
 Oluwande, P. A., 2331, 2352
 Olsson, E., 5011
 Orend, R., 6013
 Ortega, A., 2222, 2234, 6024
 Oswald, W. J., 3336, 4304, 4305, 4306, 4307, 4315, 4513
 Otis, R. J., 2308, 2337
 Ott, G., 6025
 Overman, A. R., 4164, 4165

Pamckar, P. V. R. C., 2111
 Parhad, N. M., 3337
 Parker, C. D., 3338
 Parker, C. O., 4142
 Parker, D., 6025, 6026
 Patrinely, C. D., 3503
 Patterson, J. W., 2332
 Pavel, H., 6013

Pedersen, T. A., 2220
 Pedregal, H., 2119
 Peel, C., 2333, 3413
 Penrod, L., 4156
 Perrin, O. R., 2321
 Pescod, M. B., 3018, 3331, 3339, 4143, 5015
 Peterson, J. R., 4403
 Pfeffer, J. T., 4514
 Pflucker, J., 3025
 Pickford, J., 3232, 3238
 Pillai, S. G., 3019
 Pineo, C. S., 3239
 Porcella, D. B., 3333
 Pound, C. E., 4117
 Prabhakaro Rao, V. S., 3019
 Pradt, L. A., 3118
 Prakasam, T. B. S., 2328
 Prasad, C. R., 4515
 Prasad, K. K., 4515
 Prowse, G. A., 4217
 Pyle, D. L., 4516, 4517

Radebaugh, G. H., 4218
 Radhakrishnan, I., 3403
 Rajagapalan, S., 1017, 2136
 Ramachandran, P. N., 5006
 Raman, A., 3350
 Raman, V., 2111, 2334, 2356
 Ramaprasad, T. N. C., 4518
 Rao, A. V., 4316
 Rao, L. H., 4209
 Rao, M. N., 4316
 Rao, N., 6021
 Rao, N. V., 3337
 Reddy, A. K. N., 4515
 Redmann, G. A., 4212
 Reed, A., 6017
 Reed, S. C., 4144
 Regnell, S., 2235
 Reid, G., 2221
 Reid, G. W., 2110, 2335, 3020, 3021, 3022, 3023
 Renman, R., 6017
 Reyes, W. L., 3024
 Reynolds, J. H., 3315, 3333
 Rhodes, F., 3108
 Rice, R. C., 4115, 4128
 Richard, C., 2120
 Riggs, M. S., 4114
 Rios, R. A., 3322
 Robb, J. M., 6007
 Romanenko, N. A., 4145, 4146
 Roop, R., 6019
 Rosener, A., 6025, 6026
 Ruderman, P., 3025
 Ruth, D. J., 4215
 Rybczynski, W., 2222, 2223, 2224, 2225, 6024
 Ryther, J. H., 4219

Salamov, D. A., 4102
 Saldias, A., 2121
 Sampathkumaran, M. A., 3403

Sanchez, A., 3340
 Sandbank, E., 4321
 Sarka, R., 4213
 Sastry, C. A., 3019, 3307, 3341, 4316, 4404
 Sathianathan, M. A., 4519
 Sauer, D. K., 2337
 Sauze, M., 3342
 Save, U., 2226
 Sawyer, E. W., 2118
 Schechter, H., 4317
 Schilling, Von A., 4220
 Schroeder, G. L., 4210, 4221, 4226
 Schumacher, E., 6027
 Schwarz, M., 4317, 4321
 Schwiesow, W. F., 2338
 Scott, J. C., 4411
 Sebastian, F. B., 4405
 Sebastian, S., 2339
 Seidel, K., 3508
 Seldman, N. N., 2217
 Sepp, E., 4148
 Sevilla, A. S., 5005
 Shaik, G., 3317
 Shannon, E. E., 5012
 Shanta, S., 4518
 Sharpe, W., 6028
 Shaw, V. A., 3343
 Sheehy, J. P., 2348
 Shelat, R. N., 2122
 Shelef, G., 4317, 4321
 Shende, G. B., 4149
 Sherman, K., 3407
 Shetty, M. S., 2340, 3335
 Shiffman, M. A., 1017, 2136
 Shurley, R. L., 3502
 Shtarkas, E. M., 4150
 Shuval, H. I., 4151, 4406
 Siddiqi, R. H., 2323, 3233, 3355, 4213
 Sidle, R. C. 4152
 Sieberg, D., 3027
 Siegrist, R., 5013
 Sikkema, A. V., 1011
 Simpson, D. E., 3349
 Singh, G. P., 3234
 Singh, J., 4110
 Singh, R. B. 4520, 4521, 4522, 4523
 Sivakumar, M., 5014
 Sivanappan, T. R. K., 4153
 Skaarer, N., 2341
 Slanetz, L. W., 3344
 Sless, B. J., 3345
 Sloey, W. E., 2315
 Smirnova, Z. M., 4146
 Smith, G. E., 4403
 Smith, J. L., 4157
 Smith, R. F., 4318
 Snell, J. R., 4530, 4531
 Sobolev, A., 6029, 6030
 Songer, J. G., 4318
 Sopper, W. E., 4166
 Spangler, F. L., 2315
 Sproul, O. J., 2342
 Srinivas, V., 6021
 Srinivasan, H. R., 4524
 Srinivasan, M. V., 4518
 Srivastava, U. K., 4510
 Stanbridge, H. H., 1012
 Stander, G. J., 3010, 3332, 3346, 3347
 Steel, E. W., 2134, 2350
 Stephenson, J. W., 2353
 Stoewsand, G. S., 4125
 Stone, R., 4154
 Subba Rao, V., 6021
 Subrahmanyam, D. V., 3239
 Subrahmanyam, P. V. R., 3019, 4525
 Subrahmanyam, K., 2123
 Subramanian, S. K., 4526, 4527
 Sullivan, R., 4138
 Sundaresan, B. B., 3314, 4216, 4227
 Suryaprakasam, M. V., 2328
 Susikaran, M., 2124
 Sutherland, J. C., 4155
 Tabago, J. L., 3119
 Taher, F. A., 4118
 Talboys, A. P., 3348
 Tarr, J., 3240
 Tapiador, D. D. 4222
 Telch, B., 4132
 Tennakore, L., 4528
 Tenore, K. R., 4319
 Teodorovic, B., 2343
 Thakor, V. H., 1013
 Thanh, N. C., 5015
 Thergaonkar, V. P., 3317
 Therkelsen, H., 3225
 Thomas, R. E., 4156
 Thomas, R. H., 3120
 Tierney, J. T., 4138
 Tiwari, A. R., 2114, 3318
 Tongkasame, C., 4313
 Torell, D. T., 4308
 Trevelyan, W. E., 4529
 Tneff, N. M., 4318
 Trout, T. J., 4157
 Tullander, V., 5011
 Unakul, S., 3414
 Urie, D. H., 4155
 Valdmaa, K., 2227
 Van Der Ryn, S., 2228, 2229
 Van Eck, H., 3332, 3347, 3349
 van Vuren, J. P. J., 4412
 Varadarajan, A. V., 3350
 Varma, R. N., 1006
 Venkataswamy, R., 3350
 Venkatesan, T. L., 2114, 3318
 Verghese, K. I., 5012
 Verma, A. K., 4110
 Viera, J. L., 2119
 Vinberg, G. G., 4223

Vincent, L. J., 3235, 6031
Vincent, W. A., 4320
Viraraghavan, T., 2344, 4158
Von Hasseln, R., 6019
Vosloo, P. B. B., 3010

Wachs, A. M., 4321
Wagner, E. G., 2125, 2230, 2345
Walker, J. M., 3415
Walker, W. G., 2308
Wallman, H., 6007, 6008, 6011, 6012
Walls, C., 4127, 4128
Wall, J. D., 3236
Ward, P. C., 4116
Warnock, R. G., 2344
Warshall, P., 2135, 2354, 5017
Watermeyer, J. M., 4159
Watson, J. L. A., 3351
Watson, M., 2126, 2127
Watt, S. B., 1014
Webber, D., 2318, 2346
Weber, R., 6023
Weibel, S. R., 2348
Weir, W. C., 4308
Wellings, F. M., 4160, 4161

Wijesekera, B., 4528
Wilkins, J. R., 5008
Williams, G., 6013
Williams, G. B., 4407
Wilson, G. B., 3415
Winblad, U., 2231, 2232
Winneberger, J. H. T., 2347, 2355
Witt, M., 5013
Wolny, P., 4224
Wolverton, B. C., 3509, 3510, 3511, 3512, 3513
Wood, W. E., 5007
Wooten, J. W., 3507

Yanez, F., 3352, 3028
Yao, K. M., 3353
Yau, C. H., 3354
Yeager, C. H., 2128, 2130, 2131, 2132
Yen Chiu So, 4408
Yen, T. C., 5016
Young, R. H. F., 4120

Ziebell, W. A., 2308
Zoltek, Jr, J., 3503

Authors' Corporate Affiliation Index

- African Housing Board, Ridgeway, Lusaka, Northern Rhodesia (Zambia), **3235, 3327**
- Agency for International Development (AID), Washington, D.C., USA, **5002**
- Agricultural Research Service, U.S. Department of Agriculture, Washington, D.C., **3415**
- Alabama State Department of Health, Andalusia, USA, **2108**
- Aliev Azerbaidzhan Graduate Medical Institute, Baku, USSR, **4102**
- All India Institute of Hygiene and Public Health, Calcutta, India, **1005, 2123, 2328, 2334, 3403**
- All Union Kostyakov Research Institute of Hydraulic Engineering and Land Development, USSR, **3506**
- Aluminium Company of Canada Ltd., Arvida, Canada, **5012**
- American Society of Agricultural Engineers (ASAE), USA, **2338**
- Andhra University, Waltair, India, **6021**
- Asian Institute of Technology (AIT), Bangkok, Thailand, **3007, 3009, 3018, 3119, 3320, 3321, 3331, 3339, 3354, 4140, 4309, 4310, 4311, 4312, 4313, 5005, 5006, 5014, 5015, 5016**
- Asian Regional Institute for School Building Research, Colombo, Sri Lanka, **1011**
- Association of Voluntary Agencies for Rural Development, New Delhi, India, **4519**
- Avdelningarna for Vattenforsorjnings — och Avloppsteknik samt Vattenkemi, KTH, S-100 44 Stockholm, Sweden, **5003**
- Banco Interamericano de Desarrollo (BID), **4105**
- Battelle Institute, Geneva, Switzerland, **4320**
- Baylor College, Houston, USA, **4127**
- Benaras Hindu University, Varanasi, India, **3122**
- Bestobell Engineering, Durban, South Africa, **2101**
- Bhilai Steel Plant, India, **3318**
- Black and Veatch International, Missouri, USA, **3204**
- Blair Research Laboratory, Salisbury, Rhodesia, **1001, 1016**
- Booker McConnell Ltd., London, U.K., **1003, 1008**
- British West Indies Medical and Health Department, Anguilla, BWI, **2339**
- Building Research Establishment News, U.K., **6004**
- Building Research Station (BRS), Garston, U.K., **6029, 6030**
- Bureau central d'études pour les équipements d'outre-mer (BCEOM), Paris, France, **2208, 3342**
- Byggnadskonsult, Sweden, **2235**
- California State Dept. of Public Health, Berkeley, California, **4148**
- Camp Dresser and McKee International Inc., Boston, USA, **3101, 3102, 3112, 3120**
- Carnegie-Mellon University, Pittsburgh, USA, **3240**
- CBA Engineering Ltd., Vancouver, Canada, **3103**
- C.E. Maguire Inc., New Britain, USA, **2311**
- Central Inland Fisheries Research Institute, West Bengal, India, **4209, 4211**
- Central Public Health Engineering Research Institute (CPHERI), Nagpur, India. *See: National Environmental Engineering Research Institute (NEERI)*
- Centro de Investigación y Entrenamiento para el Control de la Calidad de Agua, Mexico, **4101**
- Centro Panamericano de Ingeniería Sanitaria y Ciencias del Ambiente (CEPIS), Peru, **3028, 3348, 3352**
- Chalmers Technical University, Gothenburg, Sweden, **2219**
- Chinese Academy of Medical Sciences, Peking, China, **3401**
- Cholera Research Laboratory, Dacca, Bangladesh, **3121**
- Clivus Multrum, Cambridge, USA, **2201**
- College of Engineering, Madras, India, **4216, 4227**
- College of Military Engineering, Poona, India, **2340**
- Colorado State University, USA, **4157**
- Comité interafricain d'études hydrauliques, Upper Volta, **3228**
- Committee for the Assessment of the Cost-Benefit Effects for Cow-Dung Gas Plants, **4505**
- Commonwealth Bureau of Animal Nutrition, Bucksburn, Aberdeen, **4302**
- Commonwealth Scientific and Industrial Research Organization (CSIRO), Port Moresby Office, Boroko, Papua New Guinea, **2104**
- Compost Development Office, Ahmedabad, India, **4133**
- Cornell University, Ithaca, N.Y., USA, **1015, 2321, 4162**
- Corporacion de Obras Sanitarias de Asuncion, Paraguay, **6010**
- Daily News, Botswana, Africa, **2301**
- Danmarks Geologiske Undersogelse, Denmark, **3002**
- De Bell and Richardson Inc., Enfield, USA, **6001**
- Democratic Republic of Vietnam, Department of Hygiene and Epidemiology, **2202**
- Direccas de Servicios de Urbanismo e Habitacao de

- Ministerio de Ultramar, Angola, **2109**
 Dirección de Malariología y Saneamiento Ambiental
 Oficina de Estudios Especiales, Planeación y
 Presupuesto, Caracas, Venezuela, **2119**
 Directorate General of Health Services, Ministry of
 Health, Government of India, New Delhi, India,
1002, 1004, 3107
- École inter-États des ingénieurs de l'équipement rural,
 Upper Volta, **3228**
 Economic and Social Commission for Asia and the
 Pacific (ESCAP), United Nations, New York,
 USA, **4502**
 Ekoteket, Stockholm, Sweden, **2226**
 Elsan Sewage Systems Ltd., London, U.K., **2333**
 Engineering Enterprises Inc., Oklahoma, USA, **4163**
 Enviro Control Inc., Maryland, USA, **6018**
 Environmental Control Technology Corp., Michigan,
 USA, **6002**
 Environmental Protection Agency (EPA), USA, **3109,**
6011
 Environment Canada, Ottawa, Canada, **4126, 4314,**
5012
 Enviroscope, Inc., California, USA, **2212**
 Envirotech Corp., California, USA, **4405**
 Epidemiology Division, Cholera Research Labora-
 tory, Dacca, Bangladesh, **3121**
 Epidemiology Research Centre, Tampa, USA, **4160,**
4161
- Federal Commission for the IJsselmeerpolders,
 Netherlands, **3505**
 Fish and Aquaculture Research Station, Dor, Israel,
4204, 4210, 4226
 Food and Agriculture Organization (FAO) Regional
 Fisheries for Asia and the Far East, Bangkok,
 Thailand, **4222**
 Freshwater Biological Association, Cumbria, U.K.,
4214
- General Dynamics, Connecticut, USA, **6007, 6008**
 General Electric Company, USA, **4108**
 Government of Canada, **4112, 4126, 4314, 5012**
 Government of China, **2303, 3402, 4504**
 Government of Cuba, **3330**
 Government of Denmark, **3002**
 Government of Hong Kong, **4208**
 Government of India, **1002, 1004, 3107, 3350, 4104,**
4158, 4206
 Government of Israel, **3334, 3351, 4123**
 Government of Mexico, **3303, 3026, 4101, 4147**
 Government of Netherlands, **2107, 3505**
 Government of Nigeria, **3404**
 Government of Northern Rhodesia, **4215**
 Government of Papua New Guinea, **4401**
 Government of Peru, **3323**
 Government of Portugal, **2109**
 Government of Rhodesia, **4159**
 Government of USA, **3415, 4128, 4138, 4144, 4155**
 Government of USSR, **4150**
- Government of West Bengal, India, **4211**
 Grumman Aerospace Corp., New York, USA, **6017**
 Gujarat State Health and Medical Services,
 Ahmedabad, India, **1013**
- Hebrew University of Jerusalem, Israel, **4130, 4132,**
4151, 4317, 4406
 Henry Doubleday Research Association, Essex, U.K.,
3408
 Housing Research and Development Unit, University
 of Nairobi, Kenya, **2105**
 Howard Humphreys and Sons, U.K., **3236**
 Humboldt State College, California, USA, **4201,**
4202, 4203, 4204, 4205
- Illinois Institute of Technology, Chicago, USA, **2332,**
 Imperial College, London, U.K., **4516**
 Indian Agricultural Research Institute, New Delhi,
 India, **4512**
 Indian Council of Agricultural Research, New Delhi,
 India, **4505, 4522, 4523**
 Indian Institute of Management, Ahmedabad, India,
4510
 Indian Institute of Science, Bangalore, India, **3019**
 Indian Institute of Technology, Kanpur, India, **3308**
 Institute for Local Self-Reliance, Washington, D.C.,
 USA, **2217**
 Institutionen for Uppvarmningsoch ventilations-
 teknik KTH S-100 44 Stockholm, Sweden, **2213**
 Institution of Civil Engineers, London, U.K., **2305**
 Institution of Military Engineers, India, **3335**
 Institution of Public Health Engineering, London,
 U.K., **3353**
 Instytut Rybactwa Srodladowego, Drss Zabieniec,
 Poland, **4224**
 Instituto Nacional de Planificación (INP), **4105**
 Instituto Nacional para Programas Especiales de
 Salud, División de Saneamiento Basico Rural
 Sección de Promoción, Bogotá, D.E., Colombia,
3004
 Intermediate Technology Development Group,
 London, U.K., **1014, 4517**
 International Bank for Reconstruction and Develop-
 ment (IBRD), Washington, D.C., USA, **3106, 3201,**
3202, 3203, 3205, 3206, 3207, 3208, 3209, 3210,
3211, 3212, 3213, 3214, 3215, 3216, 3219, 4409
 International Development Research Centre (IDRC),
 Ottawa, Canada, **3113, 3114, 4402, 4509, 4532**
 International Reference Centre for Community Water
 Supply, The Hague, Netherlands, **2203**
 Iowa State University, USA, **3507**
- Jadavpur University, Calcutta, India, **3310**
 James M. Montgomery Consulting Engineers Inc.,
 California, USA, **3003, 3108**
 J.D. and D.M. Watson, U.K., **3110, 3231, 4503**
 Jefferson County Board of Health, Alabama, USA,
2112
 Johns Hopkins University, Maryland, USA, **3024**

- Khadi and Village Industries Commission, Bombay, India, **4524**
 Kiev Medical Institute, USSR, **2313**
 Konsumentverket Fack, Sweden, **2204**
- Lagos Executive Development Board, Nigeria, **3115**
 London School of Hygiene and Tropical Medicine, U.K., **1010, 2126, 2127, 2305, 2336, 3029**
 Loughborough University of Technology, U.K., **3232, 3238**
 Louisiana State University, USA, **3504**
- Maclaren International Ltd., Ontario, Canada, **3104**
 Management Development Institute, New Delhi, India, **4526**
 Manitoba Department of Northern Affairs, Manitoba, Canada, **2233**
 Martin Marietta Corp., Denver, USA, **6023, 6025, 6026, 6027**
 Martsinovskii Institute of Medical Parasitology and Tropical Medicine, Moscow, USSR, **4145**
 Max Planck Institute, Krefeld, West Germany, **3508**
 McGill University, Montreal, Canada, **2222, 2223, 2224, 2225, 2234, 6003, 6022, 6024**
 Mekoroth Water Co. Ltd., Tel Aviv, Israel, **3319**
 Metropolitan Sanitary District of Greater Chicago, USA, **4403**
 Mikrobiologisk Institutt Norges Landbrukshogskole, 1432 As, Norway, **2205, 2220**
 Ministry of Environmental Protection, Norway, **2307**
 Ministry of Defence, New Delhi, India, **1006**
- National Academy of Sciences, Washington, D.C., USA, **3501**
 National Aeronautics and Space Administration (NASA), USA, **5008, 6026**
 National Demonstration Water Project, Washington, D.C., USA, **2317**
 National Environmental Engineering Research Institute (NEERI), Nagpur, India, **2102, 2111, 2117, 2133, 2323, 2356, 3105, 3116, 3233, 3301, 3302, 3304, 3305, 3306, 3307, 3317, 3341, 3355, 3357, 4103, 4136, 4149, 4213, 4404, 4501, 4508, 4511, 4518, 4525**
 National Environmental Protection Board, Solna, Sweden, **3409**
 National Health Research Council, The Hague, Netherlands, **2107**
 National Institute for Water Research (CSIR), Pretoria, South Africa, **2329, 3311, 3332, 3343, 3346, 3347**
 National Space Technology Laboratories (NASA), Mississippi, USA, **3509, 3510, 3511, 3512, 3513**
 National Swedish Institute for Building Research, Stockholm, Sweden, **5011**
 National Taiwan University, Taiwan, **2316**
 Nauchno-Issledovatelsku Institut Epidemiologii Mikrobiologii i Gigieny, Vilnius, USSR, **4111**
 Naval Coastal Systems Laboratory, Panama City, **5010**
- Nihon Suido Consultants Co. Ltd., Tokyo, Japan, **2103**
 NOAA, USA, **4301**
- Odessa Medical Institute, USSR, **4109**
 Oklahoma State Department of Health, USA, **4207**
 Ontario Ministry of the Environment, Canada, **2310**
 Oxfam, U.K., **2318**
- Pennsylvania Glass Sand Corp., West Virginia, USA, **2118**
 Pennsylvania State University, USA, **4152, 4162, 4166, 6028**
 Public Health Department, Billesdon, RDC, **2353**
 Punjab Agricultural University, Ludhiana, India, **4110**
- Ralph Stone and Co. Inc., Los Angeles, USA, **4154**
 Research Cum Action Project, Poonamallee, India, **2124**
 Robert S. Kerr Environmental Research Centre (EPA), Oklahoma, USA, **4106, 4139, 4156**
 Ross Institute of Tropical Hygiene, London, U.K., **2126, 2127, 2305, 3029**
 Ross Institute Industrial Advisory Committee, **1010, 2336**
 Rostov-Na-Donu Gosudarstvenni Meditsinsku Institut, USSR, **4141**
 Royal Agricultural College, Uppsala, Sweden, **2227**
- Secretaria de Recursos Hidraulicos, Mexico, **3026, 3303, 4147**
 Secrétariat des missions d'urbanisme et d'habitat (SMUH), Paris, France, **3217**
 Septic Tank Systems, Berkeley, California, USA, **2347**
 Service de l'habitat et de l'urbanisme, Paris, France, **2208, 3218**
 Secretaria de Salubrida y Asistencia, Comision Constructura e Ingenieria Sanitaria, Mexico, **2137**
 Sewage Reclamation Research Unit, Kodungaiyur, Madras, India, **3350**
 Sewage Works Bureau, Yokohama, Japan, **3012**
 Singapore Public Works Department, Sewerage Branch, **3111**
 Sistemas de Esgotos Sanitarios de Baxo Custo Otimizacao Economica dos Projetos de Esgotos, Sao Paulo, Brazil, **3222**
 Southeast Asia Research Organization (SEARO), New Delhi, India, **3414**
 South Pacific Commission, Nouméa, New Caledonia, **2120**
 State Department of Health, Andalusia, Alabama, USA, **2129**
 Statens Naturvardsverk Fack, S-171 20 Solna, Sweden, **3410**
 Stevenage Laboratory, Hertfordshire, England, U.K., **3237**
 S.V. Regional College of Engineering and Technology, Surat, India, **2122, 3221**

Swedish National Environmental Protection Board, Sweden, 3005
 Sym / Bios Consulting Services, Winnipeg, Manitoba, Canada, 2233

Taiwan Institute of Environmental Sanitation (PHA), Taipei, Taiwan, 3006
 Tamil Nadu Agricultural University, Coimbatore, India, 4153
 Technical University of Denmark, Lyngby, Denmark, 3225
 Technion-Israel Institute of Technology, Israel, 3334, 3345, 4134, 4135, 4303, 4321
 Technology University, Delft, Netherlands, 5007
 Tennessee Valley Authority (TVA) USA, 4129
 Tohoku University, Sendai, Japan, 3015
 Tropical Fish Culture Research Institute, Malacca, Malaysia, 4217
 Tropical Products Institute, London, U.K., 4529

Ultraflo Corp., Ohio, USA, 6005
 United Nations Environment Programme, Nairobi, Kenya, 2309
 United Nations Mission on Housing, Building, and Planning, Dabi, United Arab Emirates, 2234
 Universidad de Chile (University of Chile), Santiago de Chile, Chile, 3340
 Universidad Nacional de Ingenieria, Lima, Peru, 3025, 4105
 Universidad Tecnica de Oruro, Bolivia, 2121
 University Federal de Paraiba, Brazil, 2351
 University of Anzosa, USA, 4118
 University of Birmingham, U.K., 3224, 3407
 University of Calcutta, India, 2312
 University of California, Berkeley, USA, 2324, 2355, 3336, 3405, 3406, 3416, 4116, 4306, 4307, 4315, 4513
 University of California, Davis, USA, 4308
 University of California, Los Angeles, USA, 6032
 University of California, Richmond, USA, 4304, 4305
 University of Cameroon, Cameroon, 3223
 University of Cape Town, South Africa, 3229, 3230, 3328, 3329
 University of Colorado Medical Center, USA, 4121
 University of Dar es Salaam, Tanzania, 1009
 University of Dundee, U.K., 2305, 2349, 2351, 3324, 3325
 University of Florida, Gainesville, USA, 3502, 3503, 4164, 4165
 University of Hawaii, Honolulu, USA, 4120
 University of Ibadan, Nigeria, 2331
 University of Illinois, Urbana, USA, 4514
 University of Khartoum, Sudan, 3013
 University of Madras, India, 3314, 4216
 University of Maine, USA, 2342, 3021, 3022
 University of Minnesota, USA, 2327, 4119, 6009
 University of Missouri, USA, 4403

University of Nairobi, Kenya, 2349, 3326
 University of Nebraska, USA, 4403
 University of New Hampshire, USA, 3344
 University of North Carolina, USA, 1017, 2136
 University of Oklahoma, USA, 2110, 2335, 3001, 3020, 3021, 3022, 3023, 3309
 University of Ottawa, Canada, 2344
 University of Sao Paulo, Brazil, 3222
 University of Surrey, Guildford, U.K., 2346
 University of Texas, Austin, USA, 3309, 3312, 3313, 3322
 University of Texas, Galveston, USA, 4318
 University of Washington, Seattle, USA, 3225
 University of Wisconsin, Madison, USA, 2302, 2308, 2315, 2337, 3226, 5013
 University of Zagreb, Yugoslavia, 2343, 4410
 Urbana-Champaign Sanitary District, Illinois, USA, 4218
 U.S. Corps of Engineers, Washington, D.C., USA, 4131
 U.S. Department of Agriculture, Cadillac, Michigan, 4155
 U.S. Department of Agriculture, Soil Conservation Service, Washington, D.C., 4124
 U.S. Department of Health, Education and Welfare, Washington, D.C., 2306
 U.S. Department of Housing and Urban Development, Washington, D.C., 2304
 U.S. Engineers, Repairs and Utilities Division, Boston, 4530, 4531
 U.S. Water Conservation Laboratory, Arizona, 4114, 4115
 Utah State University, USA, 3315, 3333

Veterinary College of Norway, 3412
 Virginia Polytechnic Institute, USA, 4125
 Volunteers in Technical Assistance (VITA), Mt. Ramier, USA, 2106

Ward, Ashcroft and Parkman, Liverpool, U.K., 3011
 Warf Institute, Wisconsin, USA, 2118
 Washington Suburban Sanitary Commission, Maryland, USA, 6006
 Water Research Centre, Stevenage, U.K., 2330
 Water Science Laboratories, Victoria, Australia, 3338, 4142
 Williams and Works Inc., Michigan, USA, 4155
 Woods Hole Oceanographic Institution, Massachusetts, USA, 4212, 4219, 4319
 World Bank, Washington, D.C., 4409
 World Health Organization (WHO), Geneva, Switzerland, 3220, 3239, 3241, 3242, 4107, 5001, 5007
 World Health Organization (WHO), Regional Office for Africa, Brazzaville, Congo, 2325

Zambia Housing Board, Lusaka, Zambia, 6031
 Zimpro Inc., Wisconsin, USA, 3118

Glossary of Selected Technical Terms

The following list has been included in this Bibliography to clarify several of the more common but often misunderstood terms related to wastewater and excreta management. The reader will notice that some of the descriptions are not entirely accurate in the technical sense. They have been abbreviated, and necessarily so, to facilitate reading and are given within the context in which they are used in the Bibliography.

- Aerobic:** in the presence of free oxygen
- Algae:** plant life, normally microscopic in oxidation ponds, that is capable of producing oxygen for the treatment of wastewaters
- Anaerobic:** without the presence of free oxygen
- Aquaculture:** the culture of fish or other aquatic life in water
- Aqua-privy:** a toilet system comprising a vertical downpipe into which one defecates, leading to a settling chamber below. The solids are retained in the settling chamber and the liquids are allowed to escape into a percolation pit nearby. A water seal is maintained at the downpipe's end by extending it below the water level.
- Biochemical oxygen demand (BOD):** the demand for oxygen of a substance undergoing aerobic decomposition, often measured in terms of milligrams of oxygen per litre
- Biogas:** a mixture of gases, predominantly methane and carbon dioxide, produced in anaerobic fermentation
- Borehole latrine:** a toilet system similar to the pit latrine but having a vertical hole, in which the excreta is stored, bored into the soil by an auger
- Bucket latrine:** a toilet system in which defecation takes place into a bucket and the excreta is removed from the household by municipal or private contractors
- Carbon/nitrogen ratio:** the ratio of organic carbon to that of total nitrogen (C/N ratio)
- Coliform:** a rod-shaped bacterium common in fecal matter, which is often used as an indicator to detect fecal contamination
- Composting:** controlled decomposition of organic matter under aerobic conditions by which material is transformed into humus. The process is normally exothermic resulting in a rise in temperature
- Denitrification:** a process of bacterial decomposition by reduction of nitrogens, e.g., of nitrates to elementary nitrogen
- Detention time:** the theoretical period of residence in a given volume or unit. It is normally calculated by dividing the volume of the unit by the flow of the liquid through it.
- Digestion:** the controlled decomposition of organic substances, normally under anaerobic conditions
- Digester:** the unit in which anaerobic digestion takes place, which often has the capability of retaining the biogas produced by anaerobic digestion
- Dipper and bucket system:** an excreta collection system, commonly employed in Asia, to remove excreta by a dipper pail on the end of a long handle from a vault beneath the toilet attached to a house. The excreta is transferred to buckets for transport to tank carts.
- Exothermic:** a process by which heat or energy is given off
- Gobar gas:** *see* Biogas
- Greywater:** *see* Sullage
- High-rate ponds:** oxidation ponds receiving wastewaters and operated at shallow depths and low detention periods to maximize algae and oxygen production
- Humus:** the end product of the composting process
- Infiltration:** penetration of water into porous or cracked material
- Manure:** animal excreta, normally fecal matter from livestock
- Maturation ponds:** ponds that are used to treat the effluent from wastewater treatment plants
- Mesophilic:** within a moderate temperature range, normally 20-40 °C
- Methane fermentation:** anaerobic decomposition of organic substances by which methane is formed
- Night soil:** human feces and urine collected without dilution in large volumes of water
- Nitrification:** the bacterial oxidation of nitrogenous compounds, such as the production of nitrite and nitrate from ammonia and proteinaceous substances
- Pasteurization:** heat treatment below 100 °C (normally between 60 and 70 °C) at which most of the vegetative forms of bacteria are killed
- Pathogen:** disease-causing organism
- Pit latrine:** a hole dug in the ground used for defecation, normally having a rudimentary superstructure and floor
- Privy:** latrine
- Refuse:** discarded solid wastes, e.g., vegetable wastes

- from the kitchen
- Sedimentation:** the settling of heavier particles from sewage by force of gravity, normally in a settling tank
- Septic tank:** a tank receiving household sewage with or without sullage, located on the household property. The principle of treatment is the same as the aqua-privy, but its volume is much larger as the flow into the septic tank is far greater.
- Sludge:** the slurry of settled particles resulting from the process of sedimentation
- Stabilization ponds:** ponds or lagoons used in treatment of sewage, also called oxidation ponds or stabilization lagoons. These may be either anaerobic (due to high sewage loads and lack of oxygen), aerobic (with oxygen provided by algae), or more commonly facultative (being aerobic in the surface layers and anaerobic toward the bottom).
- Sullage:** domestic wastewater not containing excreta; also called greywater
- Thermophilic:** of a relatively high temperature, normally in the range of 40-80 °C
- Vacuum truck and vault system:** a method of collecting night soil from vaults located beside or beneath the household, normally used in Japan. The vacuum truck collects the excreta by suction through flexible hoses and transports it to the treatment or disposal plant.
- Vietnamese double vault:** on-site latrine system developed in Vietnam using two vaults in which feces and ash are deposited and composted for later reuse as fertilizer. The vaults are used alternatively at about 2-month intervals.
- Water seal:** the seal provided by water, as in a U-trap normally located immediately below the toilet bowl



1000

1000

1000

1000

1000

1000

1000

1000

1000

1000

1000

1000