

# DEVELOPING WORLD

200 90DE



# WATER

GROSVENOR PRESS INTERNATIONAL

200-90DE-8055

All our production is designed  
and realized in order to guarantee  
the safety and easinness of use  
in the irrigation field, drinking water  
and chemical products supplying

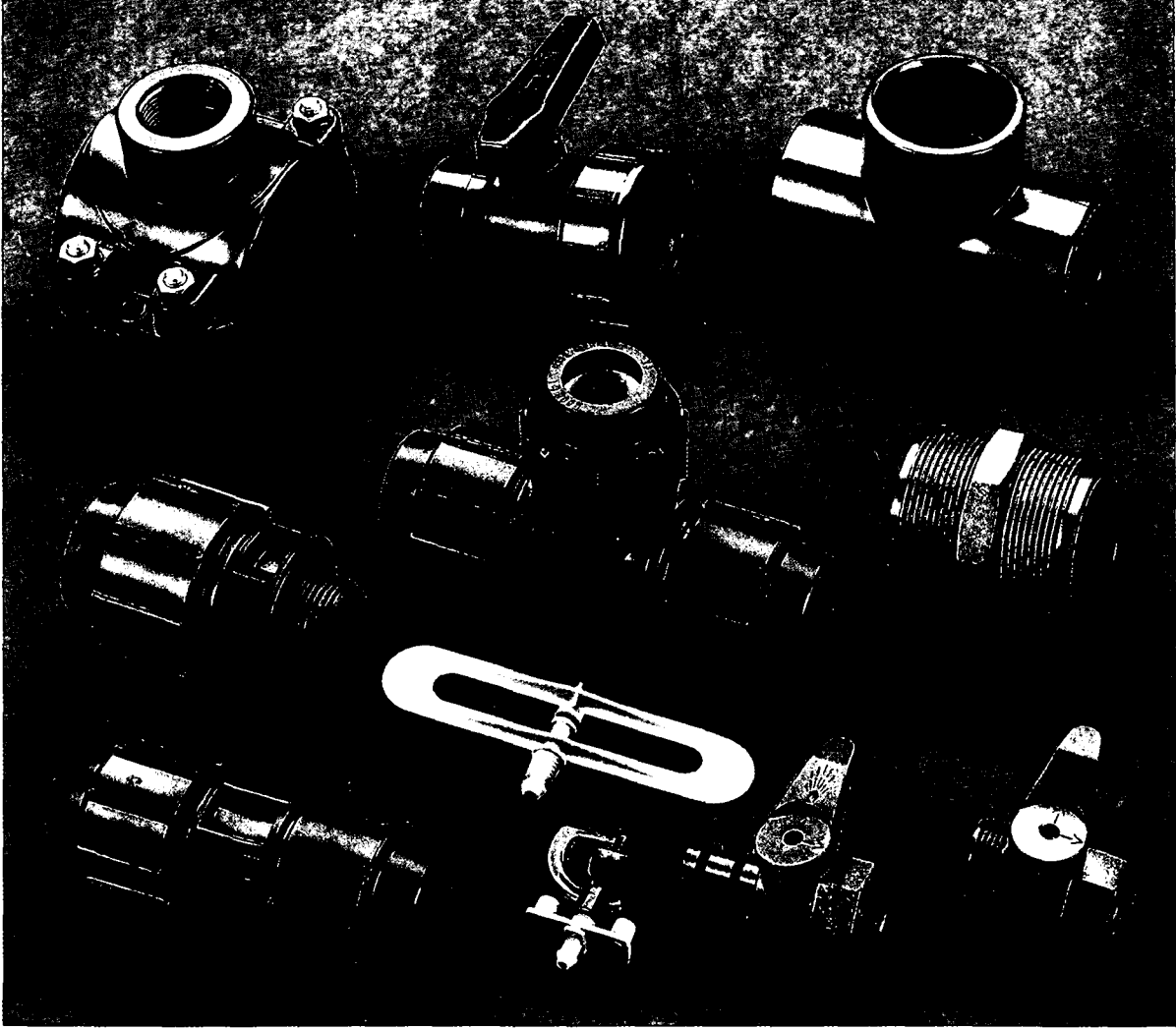

**ESSE BI PLASTIC** s.r.l.

Production of P.P. and P.V.C.  
pipe fittings for irrigation  
and the building industry

Via La Forma, 1  
60020 Sirolo (AN)-Italy  
Tel. 071/7360014-5  
Telex: 560606 HARRAI  
Fax: 071/936787

# DEVELOPING WORLD WATER

Editor: Professor John Pickford of the WEDC Centre,  
Loughborough University of Technology

LIBRARY, UNIVERSITY OF WATERLOO  
CENTRE FOR DEVELOPING WORLD WATER  
AND RURAL SERVICES  
180 UNIVERSITY AVENUE  
WATERLOO, ONTARIO N2L 2G1  
CANADA  
Tel: (519) 885-1219  
Fax: (519) 885-1218  
E-mail: jpickford@uwaterloo.ca

519 885 1219  
200 90 DE (1st copy)

Grosvenor Press International

DEVELOPING WORLD  
**WATER**  
**Contents**

<b>WATER RESOURCES .....</b>	<b>11</b>
Surface Resources - Crisis Management Versus Creative Planning, by Henry Gunstone, Institute of Hydrology .....	12
Aquaculture and Pisciculture .....	16
Bank Protection, River Training and Canals .....	16
Dams & Reservoirs .....	17
Flexible Linings and Geotextiles .....	20
Flood Protection .....	24
Recreational Use of Water .....	28
Water Transportation and Export .....	28
Rainfall, Instruments etc .....	28
Land Drainage .....	28
<b>GROUNDWATER .....</b>	<b>31</b>
Contemporary Developments in Well Drilling by W. S. Moffat .....	32
Photovoltaic Energy - from Outer Space to Planet Earth - by Poul Erik Mortensen and Keld Madsen .....	34
Remote Sensing and Site Investigation .....	39
Geophysical Equipment .....	40
Casings and Screens .....	42
Handpumps .....	50
Deep Well Pumps, Pump Tests and Groundwater Sampling .....	55
Alternative Energy Pumps (Wind, Solar) .....	64
Drilling and Drilling Equipment .....	69
<b>WATER DISTRIBUTION AND SEWERAGE .....</b>	<b>85</b>
Public Water Supply for Urban Slums, by Andrew Cotton, WEDC .....	86
Corrosion and Scale Protection and Control .....	89
Location and Inspection Underground Services .....	91
Laying of Pipes (Including Trench Excavation) .....	93
Leak Detection and Control .....	99
Fittings for Pipes .....	101
Pumping Stations .....	117
Renovation, Lining and Replacement of Pipes .....	124
Surge Protection .....	129
Tanks (including Pressure Vessels) and Water Towers .....	129
Drainage (Including Drainage of Buildings) .....	137
Plumbing - Water in Buildings .....	139
<b>WATER TREATMENT .....</b>	<b>143</b>
Water Treatment Design for Reliability, by Adrian Coad .....	148
Chemicals for Water Treatment .....	151
Desalination and Water Softening .....	166
Disinfection .....	182
Municipal Water Treatment .....	188
Package and Portable Treatment Units .....	194
Swimming Pool Water Treatment .....	200
Treatment for Industry and Medicine .....	202

Editor: Professor John Pickford of the WEDC Centre, Loughborough University of Technology

DEVELOPING WORLD  
**WATER**  
**Contents**

	208
	224
<b>WASTEWATER TREATMENT .....</b>	<b>231</b>
Trends in Wastewater Treatment, by K.V. Ellis .....	232
Biological Treatment .....	237
Chemicals for Wastewater Treatment .....	242
Industrial Wastewater Treatment .....	245
Package and Portable Treatment Units .....	248
Preliminary Treatment - Screens and Disintegrators .....	250
Sedimentation: Solid/Liquid Separation .....	252
Sludge Treatment and Disposal .....	252
General Equipment and Processes .....	256
Specialised Equipment and Processes .....	263
<b>IRRIGATION .....</b>	<b>267</b>
Food Security through Irrigation, by Richard Faulkner .....	270
Agricultural Chemicals (Pesticides, Fertilizers) .....	274
Agricultural Machinery .....	274
Control Equipment -Valves and Gates .....	275
Overhead and Drip Irrigation Systems .....	277
Software and Irrigation Services .....	284
Special Purpose Pumps, Pipes and Other Equipment .....	285
<b>MECHANICAL AND ELECTRICAL EQUIPMENT .....</b>	<b>293</b>
Energy Efficient Pumping and Pumping Systems by Maurice A Yates .....	294
Cranes, Lifting Equipment and Hydromechanical Equipment .....	299
Diesel, Petrol and Natural Gas Engines .....	299
Electrical Motors, Starters, Control, Transformers, Switchgear, Alternators, and Generators .....	304
Hydroelectric Turbines and Equipment .....	307
Lighting Equipment .....	316
Pumps- Centrifugal Axial Flow and General .....	316
Pumps - Positive Displacement and Other Special Pumps .....	331
Pumps - Submersible .....	335
Miscellaneous Mechanical Equipment, Including Compressors and Blowers .....	345
<b>INSTRUMENTATION, CONTROL AND ANALYSIS .....</b>	<b>349</b>
Instrumentation, Control and Analysis, by L. G. Hutton .....	350
Control Equipment .....	356
Data Acquisition, Analysis, Storage and Transmission .....	363
Dosing Systems and Equipment .....	366
Field and On-Site Testing .....	368
Pressure and Temperature Guages and Regulators .....	370
Laboratory Equipment .....	371
Level Indicators and Controls .....	373
Meters - Flow Measurement .....	377
Microbiological Analysis Equipment .....	383

# Almost 2 billion people drink water you wouldn't use to wash your car.

# Another 1.2 billion wish they had that water to drink.

---

## **In much of the world, getting enough water to survive is a daily crisis.**

Waterwise, the world is divided into three parts: sufficient, insufficient and polluted. In 1981, the World Health Organization estimated that more than three billion people did not have enough clean water to meet daily needs. Even more disturbing, 80 percent of all disease and sickness is related to water or inadequate sanitation. And in the most vulnerable population group, children under five, there are about 25 million deaths each year from water-related diseases.

---

## **One solution lies just below the earth's surface.**

Only three percent of all the water in the world is considered fresh enough to drink. Three quarters of that is locked in ice. Of the remaining 25 percent, atmospheric and surface water make up less than one percent. The rest—24 percent—is groundwater.

---

## **The key to groundwater recovery: simplicity.**

Most water-starved regions of the world are vast, rugged and barely accessible. Often, climates are inhospitable,

and the technical capability of the indigenous population is low. In this type of environment most drilling equipment is too costly and difficult to operate and maintain.

Ingersoll-Rand developed a line of simple, lightweight drilling rigs that are highly mobile and inexpensive to own and operate.

The TH-10 is a modular drill that can be transported on available trucks or trailers. It is as easy to operate, maintain and repair as simple construction and farm equipment, yet it uses modern methods to drill water wells in sand, gravel or the

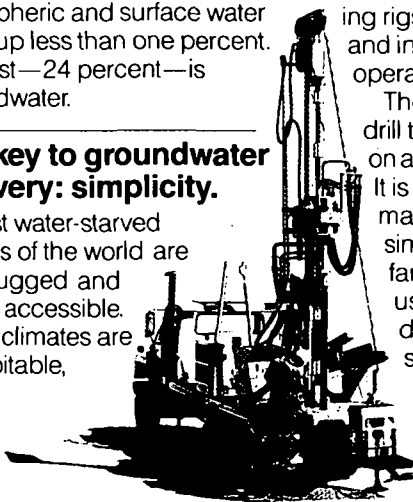



hardest rock. More than 100 are operating in some of the world's most inaccessible regions.

The smaller TH-5 is light enough to be trailer-mounted. Or, it can be transported by jeep to the drilling site and dropped off, freeing the vehicle for other jobs. Because it can fit into tight spaces, the TH-5 is used to drill in the bottom of dug wells, or pit wells that have gone dry. It can also drill wells in tight confines of villages near the people and animals that use water.

In addition to small drills for village level water supply, Ingersoll-Rand has more than 500 of its larger well drilling rigs operating in more than 40 countries. These wells are supplying water for factories, massive irrigation schemes and human consumption. They are also helping dewater areas that have

high water tables or heavy saline concentrations.

### World power in drilling.

The world needed simple, maneuverable, cost-effective rigs for water drilling in remote areas. Ingersoll-Rand delivered ... just as, for over a century, we've been delivering drilling

equipment for surface mining, quarrying, construction, shallow oil and gas and exploration drilling. Wherever our equipment is operating, you'll find Ingersoll-Rand's service, operator training, parts and technical support.

For more information, please write.

**INGERSOLL-RAND®**  
**CONSTRUCTION EQUIPMENT**



**World Class.  
World Quality.**

Ingersoll-Rand Company  
253 East Washington Ave., Dept. B-463  
Washington, New Jersey 07882 USA

Please send me more information about the TH-10 drill rig.

Please send me more information about the TH-5 drill rig.

Please send me information about Ingersoll-Rand Construction Equipment.

Name: \_\_\_\_\_

Title: \_\_\_\_\_

Company: \_\_\_\_\_

Address: \_\_\_\_\_

City: \_\_\_\_\_ State: \_\_\_\_\_ Zip: \_\_\_\_\_

Phone: ( ) \_\_\_\_\_ Telex: \_\_\_\_\_

## ANSALDO WATER TECHNOLOGIES

Ansaldo Sistemi Industriali S.P.A. is the contracting and engineering company of Ansaldo S.P.A. operating in the field of industrial plants, material handling, ports, ships and offshore, plants and systems for integrated environment management.

The company is involved in study, design, engineering, procurement, marketing and implementation activities, including supply, installation, commissioning, start up, technical assistance and training.

As part of a sector within the Iri and Finmeccanica group, Ansaldo Sistemi Industriali can also rely on technical and financial resources of associated companies with whom it closely cooperates in the design, engineering and implementation of integrated civil and industrial systems.

Ansaldo Sistemi Industriali is present in the most significant international markets and its primary aim is to increase this presence through its competitiveness, high technology, reliability and assistance.

A highly qualified team of mechanical and electrical engineers is maintained to carry out plants realization on sites throughout the world.

The work on site is closely supervised by a team of experienced engineers to ensure that the desired standards are achieved. Qualified staff undertakes the training of users' operating and maintenance personnel.

The team also provides emergency service and can attend to problems anywhere on very short notice.

### Plants and systems for integrated environment management

Applications:

- Water pumping systems and fluid distribution networks
- Land reclamation and irrigation plants
- Mini-hydro power plants
- Port and airport facilities
- Technological plants for administrative centers, universities and large public and industrial complexes
- Integrated projects for socioeconomically developing countries

Among the above mentioned applications, Ansaldo Sistemi Industriali has recently been awarded one of the largest water supply schemes in the world for the city of Kirkuk (Iraq), sized at 388.000 CU.M./Day of treated water output.

The general arrangement of the scheme is based on four supply areas including:

- Water treatment facility
- N.3 ground storage tanks located several kilometers from each other and from the water treatment facility

### Main characteristics of the plant

- Raw water pumping station (at Iab River) with N.8 Archimede screw lift pumps, capacity 2700 CU.M./H, each, 5,7 M.w.c. lift
- Treated water pumping station with N.7 horizontal split-casing type pumps, capacity 2520 CU./M./H each, normal head 115 M.w.c. driven by 925 KW - 3,3 KV Ansaldo asynchronous induction motors
- Booster pumping station GST-2 with N.6 horizontal split casing type pumps, capacity 1200 CU.M./H each 35 M.w.c. nominal head
- Drinking water treatment plant capacity 388.00 CU.M./Day complete with:
  - . N.16 clariflocculators diameter 38,00 MT each
  - . N.80 gravity gravel filters total surface 3.200 Sq/Mt
  - . N.6 backwash pumps
  - . N.4 air blowers
- Chemical preparation and dosing system
- N.2 x 3650 KVA - 11 KV - 50 HZ diesel generating sets complete
- Electrical substation complete for plant's electrical supply
- All M.V. and low voltage switchgears and control centers for the plant
- Chemical laboratories
- All control and supervising control boards
- Scada system for plant monitoring and automatic control.



Typical small-sized water treatment scheme.



**We produce development by producing  
technology.**



Choosing the proper new technology means making the best use of resources and giving your company the ability to operate efficiently without neglecting the human and natural environment.

Putting your trust in Ansaldo Sistemi Industriali for your hydraulic engineering needs means being able to take advantage of our complete water supply systems, sewage treatment plants, land reclamation and irrigation projects, pumping stations for oil and slurry pipelines, pumping systems for harbor and airport facilities, mini-hydroelectric power plants. Ansaldo Sistemi Industriali combines a long and prestigious tradition with a dynamic approach to produce development by implementing the most up-to-date technology.

**ANSALDO**  
Sistemi Industriali

IRI / FINMECCANICA

via Pieragostini 50, Genoa-Italy  
Telex 281311-271194 ANSASI I

DEVELOPING WORLD  
**WATER**  
**Contents**

Transducers .....	384
Sampling Equipment .....	385

**CONSULTANTS AND CONTRACTORS ..... 389**

The Role of European Contractors in the Third World, by Rolf Bollinger and Ulrich Paelzold .....	390
The Changing Nature of Consultancy Work, by Alistair Wray .....	393
General Civil Engineering Contractors .....	395
Procurement Specialists .....	396
Project Management .....	397
Treatment Plant Equipment Installation .....	398
Turnkey Services .....	404
Consultants .....	406

**RESEARCH, TRAINING AND PUBLICATIONS ..... 425**

Sustaining the Impetus of the Decade, by John Pickford .....	426
Book Publishers .....	428
Exhibition and Conference Organisers .....	430
Research Organisations .....	430
Technical Journals .....	432
Training Establishments .....	436

**INSTITUTIONS AND ORGANISATIONS ..... 437**

A Diplomatic Approach To Development, by Richard Franceys .....	438
United Nations Agencies .....	440
Bilateral Development Organisations .....	440
International Organisations .....	442
Other Relevant Non-Governmental Organisations .....	444
Financial and Insurance Institutions .....	445

**GENERAL ..... 447**

Beyond The Decade, by Alexander H. Rotival .....	448
Community Involvement in Ugandan Water Projects, by Graham Piper .....	450
The Value of Educating Tanzanian Woman For Their Role In Water Development, by Mrs E. J. Chaggu .....	453
Communal Water Points, by Bob Reed .....	456
Involvement of Farmers in Small Scale Irrigation Projects, by Ian Smout .....	458
Social Aspects of Sulabh Shauchalaya, by Bindeshwar Pathak .....	460
Building Components and Materials .....	462
Tools, Clothing and Miscellaneous Small Equipment .....	462
Large Equipment (e.g. Earth Moving, Transport, etc) .....	463
Cooling Towers and Equipment .....	464
Miscellaneous .....	465

**ADVERTISERS' INDEX ..... 467**

Printed and published by  
Grosvenor Press International Ltd, Holford Mews,  
Cruikshank Street, London  
WC1X 9HD. The Publishers  
cannot accept responsibility  
for errors or omissions although every care is taken to ensure that all the information in Developing World Water is accurate and up to date.

# Constructing with Preussag. Water Supply

Do you have any problems with water well drilling, water transportation, water treatment, water storage? Why not contact us? We solve your water problems:



## Geological Services

We provide full geological services. From the very beginning of finding water make sure of success.



## Water Well Drilling

We offer a full programme:

- borehole drilling up to 1000 m (3000 ft.)
- by: air-lifting, reverse and hammer drilling method
- core drilling
- piezometer drilling
- sale and installation of submersible pumps and turbine pumps, foot/hand driven pumps for shallow wells



## PVC-Casing and Screens

### Drilling Muds

We developed PVC-casing and screens 20 years ago and produce them since.

Our drilling muds (CMC-Tylose, Barytes, bentonites) are offered with mud engineering.



## Handpumps

LOMP (Village Level Operation Maintenance Pump)



## Storage Tank Production and Installation

Pipeline Construction of any size and Material



## Water Treatment

Based on profound research and development Preussag is continuously engaged to create new marketable products of water treatment technologies. Our main activities

- drinking water, desalination
- industrial water
- sewage
- swimming pool water

### PAC-

## Preussag Aquatech Compact™

are compact water treatment plants for production of drinking water divided into 4 types:

- SAG: well water
- SAO: surface water
- SRG: high saline well water or brackish water
- SRO: sea water

Regardless of the nature of raw water all types constantly produce pure water according to WHO-Recommendations.

## Chlorine and Chemicals for Water Conditioning

We supply high purity liquefied chlorine gas in cylinders and ton containers from our own factory. We offer the following advantages.

- all chemicals for water conditioning
- comprehensive advice on safe handling of chemicals
- dosing and controlling systems and equipment



## Steel Valves

- steel gate valves
- steel swing check valves
- butterfly valves



# PREUSSAG

Preussag AG Bauwesen

P.O. Box 48 40 · D - 3000 Hannover 1 · Phone (05 11) 5 66-00 · Telex 9 22 828 · Telefax (05 11) 5 66-00  
Federal Republic of Germany

# DANN

# Esperare un poco, Señor Contratista

TAMROCK  
SPEAKS  
YOUR  
LANGUAGE

IMAGINE YOUR FUTURE  
IMAGINE THE KIND OF EQUIPMENT  
YOU'RE GOING TO NEED.

Tamrock is a 100% committed specialist in innovative excavation equipment. Over the years we have patented many innovations. Today our raise boring and overburden drilling equipment, our compact Commando drilling rig, and the SUPERDRILLING jumbo series have taken the profitability of your whole work cycle to the limits of the imagination.

Tamrock equipment like this commands respect. You will be proud to own it in the future, too. Tamrock innovativeness is planned for efficiency, safety, user-friendliness, because Tamrock speaks your language, and we know what we're talking about.

Senior Contratista, imagine what Tamrock innovativeness could mean to you.

# TAMROCK

Tampella Ltd, Tamrock Group  
P.O. Box 279, SF-33101 Tampere, Finland, Tel: int'l +358-31-2414111  
Telex: 22623 tamet sf, Telefax: int'l +358-31-132152



• Water Resources •

# SURFACE RESOURCES

## CRISIS MANAGEMENT VS CREATIVE PLANNING

by

Henry Gunston  
Institute of Hydrology

**When reviewing development of surface water resources across the tropical world a recurrent theme is the clash between short-term and long-term perspectives. Immediate matters — a dreadful African drought, a burst pipeline or a sudden river pollution crisis — make demands on water supply organisations which may quite literally lead to the cry: “All hands to the pump!”.**

In the heat of a crisis, however, resources originally allocated to longer term development operations are often sacrificed and the organisation's ability to combat future problems is seriously reduced.

### **Drought hinders development**

At a village level this clash of interests has been dramatically illustrated in the drought stricken areas of Ethiopia, Somalia and Sudan. The urgent need to truck water over long distances to refugee camps and other stricken settlements diverts funding from longer term improvements such as small scale village water supplies and simple treatment plants. Likewise, trained staff — both local and expatriate — may be diverted to cope with an immediate crisis instead of continuing work on development projects which tackle long term degradation of rural or urban areas.

### **Low priority for vital river data**

Another area where crisis management is undermining proper water resource planning is the downward trend both in the quantity and quality of hydrological data. Field hydrologists are often considered poor relations by engineers in headquarters offices titled “Operation and Maintenance” and “New Works.” Ironically, new water supply works can only be designed on the basis of long term field data from raingauges and river gauging stations. If the hydrologist has a vehicle at all, it will be among the first to be reallocated to emergency duty and shortages of funds for staff field allowances play havoc with essential regular river gauging schedules.

### **No upward funding trends**

The International Drinking Water Supply and Sanitation Decade has focussed world attention on water resources. It might be expected, therefore, that extra funding would now be available both to tackle short-term crises and to support longer term planned water development. However, despite progress in the rural water sector indicated by Peter Lowes in his article “Half Time in the Decade” in the last edition of “Developing World Water”, the world trade recession has not encouraged extensive funding for water resource development — either from within countries or through international agencies. World Bank lending in the water supply and sewerage sector remained at around five percent of overall lend-

ing for each year in the 1983 to 1987 period with no clear indication of an upward trend.

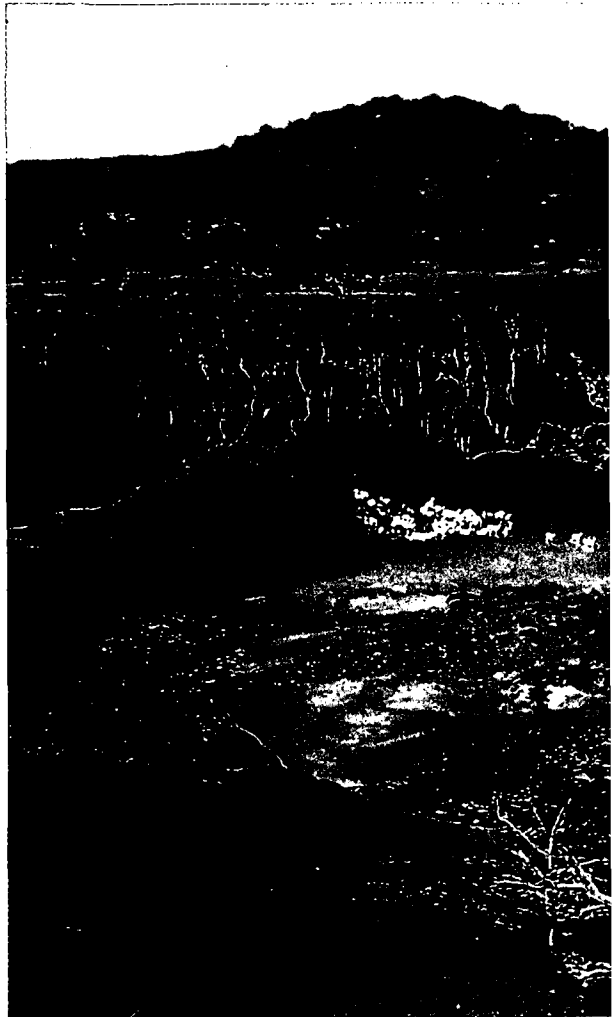

## WATER RESOURCES

**Development not closely linked to water availability or need?** Controversial conclusions on the factors which determine national water resource planning were presented by Kathy Wood Loveless in her paper "Water Resources Development : A Six-Nation Study", presented at the Special Session of the 13th Congress of the International Commission on Irrigation and Drainage in Rabat, Morocco in 1987. Water Resources Development was taken as comprising four major dimensions: multi-purpose use of water; innovational methods and the use advanced technology; degrees of decentralisation of planning decisions; and integration of the costs and benefits of water development into a national economy. Independent variables used in analysis were: available water resources; water needs; and socio-economic indicators. Using data from Algeria, Hungary, India, Israel, Mexico and Syria, Loveless showed that the overall national socio-economic trends were far more significant indicators of water resource development in a country than the more specific factors of availability of water or

consumer need.

### **Village level methods favoured**

Among current approaches to developing surface water resources there is a trend towards concentrating action at the village, as opposed to the organisation (e.g., government ministry) level. Large dams continue in favour for hydro-power generation, but in surface irrigation a focus has been rehabilitation of existing schemes, with particular attention on improved management methods and social approaches which aim to involve the smaller farmer in decision making.

Water supply at village level has continuing high priority, with greater use of subsurface or gabion dams across seasonal rivers, together with "leaky" reservoirs, to encourage shallow subsurface storage. These methods reduce evaporation loss and the passage of water through the shallow sand aquifers aids initial treatment to improve quality. Simple water quality test kits are also playing an important part in the development of new sources derived from surface water at village level. •

*Watering stock [A] — river channels themselves provide direct access to water for animals — but at risk of bank erosion. This view is in Kenya.*



## WATER RESOURCES

*Essential river data (A) – a field hydrology team installing a water level recorder to gauge a river at a remote site in Kenya.*



**All photos by Henry Gunston**

*Village level storage — construction of a gabion dam in India for erosion control and water storage.*







# WORLD DEVELOPMENTS WITHIN YOUR GRASP



Grosvenor Press International, Holford Mews,  
Cruikshank St., London WC1X 9HD.

Credit Card sales are on 01 278 3000.

## AGRICULTURE

Developing World Agriculture, charts the rise of the cash crop and shows how countries are balancing the need to buy with the need to eat.

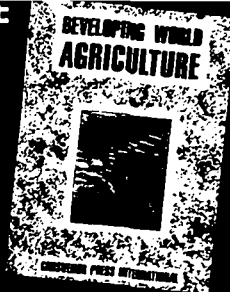

## COMMUNICATIONS

Developing World Communications keeps you in touch, with its detailed coverage of communication systems and methods, from satellites down



## HEALTH

Developing World Health is THE guide to trends and new developments in worldwide healthcare



## TRANSPORT

Developing World Transport identifies the changes in transport infrastructures and the ways in which they are being met and overcome.

DEVELOPING WORLD  
TRANSPORT

GROSVENOR PRESS INTERNATIONAL

## WATER

Developing World Water covers the provision of clean, safe water throughout the world, and identifies the major suppliers of services and equipment

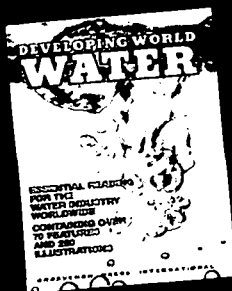

All titles cost £49.95, discounts available for multiple purchase.

## Aquaculture and Pisciculture

**AQUASHADE INC** Box 198 Eldred NY 12732 USA  
Tel: +1-914-557-8077, Fax: +1-914-557-8015, Contact:  
Billie Wilson. Aquashade® aquatic plant growth control.  
Through light reduction.

**BS FLOCOR LTD** E5 Stafford Park 15 Telford TF3 3BB  
UK Tel: +44-952-290350, Telex: 35835, Fax: +44-952-  
290353. Suppliers of patented Flocor® plastics biofiltration  
media for sewage and effluent treatment, MAT  
Aerators and Cyclomat units for aeration of lagoons,  
fish farms, lakes and sewage treatment. Also Photo-  
zone activated air systems for sterilisation of water.

**GRUNDFOS INTERNATIONAL A/S** P D Jensensvej  
7, Bjerringbro 8850 Denmark Tel: +45-6-68-1400, Telex:  
+60731 gfos dk, Fax: +45-6-68-44-72. The Grundfos range  
includes pumps for fresh water supply, aeration (even  
solar driven), for hot water transportation and for cleaning  
purposes. Pumps for both land and sea based farms.

**GUIGHER SPA** Vigano Brianzo 2 Via G Gallei Como  
22060 Italy Tel: +39-39-949-471, Telex: 335301, Fax: +39-  
39-955853. Tenax is the trade mark throughout the world  
of a wide range of extruded nets made totally of plastic  
material. In particular Guigher Spa produce tubular  
nets specially for the cultivation of mussels in sea water.  
Tenax nets do not deteriorate and their original properties  
and strength are not affected in salt water conditions.  
In addition to the Tenax structures for growing mussels,  
there are other nets suitable for packing, dispatch and  
sale of mussels and also oyster bags.

**HYDRO-BIOS APPARATEBAU GmbH** P O Box 8008  
Kiel 17 2300 W Germany Tel: +49-431-362-007, Telex:  
292880, Fax: +49-431-362009, Contact: Mr Mueller.  
Manufacturers of oceanographic and hydrobiological  
equipment, especially water and bottom sampling  
equipment, as well as plankton nets.

**IDEAL HORIZONS INC** PO Box 1707, Rutland, Vermont  
05701 1701 USA Tel: +1-802-773-4346, Fax: +1-  
802-773-2538. Ideal Horizons manufacture stainless steel  
ultra-violet disinfection equipment. Our modular  
systems allow for versatility over a wide range of  
applications and flow rates. These systems are engineered  
for durability and performance.

**MARSÜN BROSYSTEM** P O Box 154 Halmstad 30103  
Sweden Tel: +46-35-109-670, Fax: +46-35-11-1194,  
Contact: Benjt Mahrstron. Specialised in water treatment  
for aqua culture farming of fish and crustacean.  
Oxygenation, nitrification, aeration, filtration and heat  
exchange.

**REDPORT NET CO LTD** 94 East St Bridport Dorset  
DT6 3LL UK Tel: +44-308-22592, Fax: +44-308-27934,  
Contact: P D Cox. Manufactures and makers up of all  
types of materials, webbing and netting for use in many  
fields, especially angling, fish farming and pisciculture.  
Netting machines that are suitable for filtration purposes,  
to that used for deep sea fishing.

**TIFA (C I) LTD** 50 Division Avenue Millington NJ

07946 USA Tel: +1-201-647-4570, Fax: +1-201-647-2517/  
7338. Fishery chemicals.

**WESTMOOR LTD** 3452 N Knox Avenue Chicago IL  
60641 USA Tel: +1-312-282-2237, Fax: +1-312-282-4954.  
Manufacture rotary vane, positive displacement air  
blowers used for aeration. Products include pumps  
and pump units plus aeration kits. Aeration systems by  
Westmoor are used in waste water facilities, lake  
management and aquaculture, where conventional  
blowers are unable to overcome the static pressure of  
greater than 3ft of water.

**YSI INCORPORATED** YSI Scientific, Lysons Avenue,  
Ash Vale, Aldershot, Hampshire GU12 5QR UK. Tel:  
+44-252-513006, Telex: +858210 INSTCOG, Fax: +44-  
252-511855, Contact: Lynda Hart. YSI dissolved oxygen  
and conductivity meters, monitor wastewater treatment,  
providing environmental control and enforcement.  
Other YSI systems help maintain pure water supplies  
by monitoring temperature, conductivity, pH and ORP  
in surface water and groundwater as it is pumped from  
test wells. YSI instruments assure healthy crops of fish  
and shellfish in hatcheries and on fish farms.

## Bank Protection, River Training and Canals

**AQUATICS UNLIMITED** 2150 Franklin Canyon Rd  
Martinez CA 94553 USA Tel: +1-415-370-9175, Fax: +1-  
415-370-9179, Contact: James R Ziegler. Manufacturer  
of Aquamog-a multi purpose marine maintenance vessel  
with many easily interchangeable attachments. Aquamog  
cuts aquatic weeds deep and fast, rotovates  
hydrosol, removes rooted vegetation. Aquamog is a  
powerful suction dredge and bucket dredge. Self  
propelled, eliminates cables, reduces downtime, reaches  
under piers, inside boatslips, close to shore and cleans  
waterways.

**CONCRETE ARMOR SYSTEMS** 3 Garmany Place  
Yonkers NY 10710 USA Tel: +1-914-779-5858, Fax: ,  
Contact: Ray O'Neill. Research and development of  
concrete shapes for bank stabilization and flood walls.  
Designed products for river and coastal protective  
works.

**GOMACO INTERNATIONAL LTD** 769 Buckingham  
Avenue Trading Estate Slough Berks SL1 4NL UK Tel:  
+44-753-821926, Telex: 847243 gomaco g, Fax: +44-753-  
693093, Contact: David Willis. Concrete lining and  
finishing for canals.

**GRASS CONCRETE LTD** 22 Bond St Wakefield West  
Yorkshire UK Tel: +44-924-374818/375997, Telex: 51458,  
Fax: +44-924-290289, Contact: Mr B Fernley. Grass  
Concrete provide a range of concrete surfacing, for  
spillways, embankment stabilising, service access etc.  
The range of products includes reinforced, insitu  
concrete blocks.

**HYPOFORS VOF** Velperweg 76, Postbus 9300,  
Arnhem, 6800 SB The Netherlands Tel: +31-85-664593,  
Telex: +44-45204, Fax: +31-85-662070. Hypofors is a

## BANK PROTECTION, RIVER TRAINING AND CANALS

prefab, flexible, 5m wide reinforced bituminous liner. The membranes are manufactured on rolls in lengths up to 80m. Because of its sturdiness, dimensional stability and easy maintenance, Hypofors is highly suitable for the repair of damaged concrete lined irrigation canals.

**NETLON LTD** Kelly St Blackburn Lancashire BB2 4PJ UK Tel: +44-254-62431, Telex: 63313, Fax: +44-254-680008, Contact: . Tensar Mat is an effective and permanent method of controlling the erosion of wet or dry slopes, and Tensar or Netlon gabions provided effective and non-corrodible erosion control structures. Netlon drainage pipes have high flow capacities and provide fast and effective irrigation and drainage. Netlon drainage nets are high profile structures used in the construction of lagoons and similar structures.

**OFFICINE MACCAFERRI SpA** P O Box 396, Via Begli-Agresti No 6 Bologna 40123 Italy Tel: +39-51-23-4503, Telex: +510649, Fax: +39-51-236507, Contact: . Maccaferri gabions, reno mattresses and rockfall netting for training and hydraulic protection structures, soil protection and soil conservation. Stabilisation of roads, railroads and airports. Protection of residential and industrial installations, linings of dams and water courses. Lake and coastal protection works.

**SOCIETE D'AMENAGEMENT URBAIN ET RURAL** Challenger 1, Avenue Eugene Freyssinet, 78064 Saint Quentin Yvelines Cedex. Tel: +33-1-30-60-22-60, Telex: +689292 SAUR F, Fax: +33-1-30-60-27-89. SAUR is capable of collection, processing and recycling of solid wastes; utilities operator; design engineer and contractor for water pumping, sewage treatment and solid wastes recycling plants.

**SHORCO TRENCH SYSTEMS LIMITED** Cross Green Way Leeds LS9 0SE UK Tel: +44-532-497497, Telex: 556135. Shorco have a full range of trench shoring products capable of providing quick, safe and effective shoring in even the most difficult ground conditions. Complementing their trenching products Shorco also offer a full range of inflatable pipe stoppers suitable for both water and air testing of pipes from 200mm to 1800mm diameter.

**TERRA AQUA GABIONS** 4930 Energy Way PO Box 7546 Reno Nevada 89510 USA Tel: +1-702-329-6262, Fax: +1-702-329-7530, Contact: Gary R Osendorf. Manufacturer of twisted wire gabions used for retaining walls, bank protection, river training, weirs and revetments. Twisted wire for gabions is also an excellent method of containment for rock fall protection on steep cut slopes.

### Dams and Reservoirs

**ANGLE-RING CO LTD** Bloomfield Rd Tipton West Midlands DY4 9EH UK Tel: +44-21-557-7241, Telex: 335513, Fax: +44-21-557-5523, Contact: Mr W J S Gover. Curved steel sections open up new scope for economic shaft and cofferdam design. Universal columns curved about the major axis form high modulus curved walls and shaft rings.

**CAMECO** P O Box 2077 Lelystad 8203 AB The Nether-

lands Tel: +31-3200-32255, Telex: 47141, Fax: +31-3200-31995, Contact: Mr Sollie. Land reclamation and levelling, laser controlled, dam building and irrigation.

**E C BAKER & SONS INC** Box 85 Sigel I L. 62462 U S A Tel: 1-217-884-2020. Contact: Bernard Baker. Destratifiers for lakes, ponds or reservoirs to improve water quality and to reduce the cost of chemicals needed to treat finished water.

**GALLIFORD SPECIALIST SERVICES LTD** P O Box 33, Milton Malsor Northampton NN7 3AD UK Tel: +44-604-858031, Fax: +44-604-858561, Contact: John Husbands. Undertake specialist repairs to water towers, underground reservoirs and general water retaining structures, ie concrete repairs, crack sealing, internal lining and external waterproofing, joint renewal and epoxy paint applications.

**GERSAR** 4 Rue Galilie Paris F75116 France Tel: +33-1-472-36064, Telex: +613-525, Fax: +33-1-47-209590. Gersar is an international engineering company which pools the technical capabilities of the French regional development companies, gathering 2,500 people including 1,400 engineers and technicians.

**HANY & CIE AG** Bergstrasse 103 Meilen CH-8706 Switzerland Tel: +41-1-925-11-31, Telex: 875540, Fax: +41-1-923-62-45, Contact: Mr Reinhardt Muller. Suppliers of equipment for dam construction, grouting equipment and grouting systems.

**HYPOFORS VOF** Veiperweg 76, Postbus 9300, Arnhem 6800 SB The Netherlands Tel: +31-85-664593, Telex: +44-45204, Fax: +31-85-662070 Hypofors is a prefab, flexible, 5m wide reinforced bituminous liner. Because of the simple jointing of the sheets with hot blown bitumen and its reliability, Hypofors has been selected for the impermeabilisation of many large water reservoirs in various parts of the world. Due to the high coefficient of friction of its sandy surface - even on steeper slopes - a stable protective covering can be easily installed upon the membrane.

**KROELLIANT CRANES A/S** Nordkranvej 2 Lyngø DK 3540 Denmark Tel: +45-2-187-400, Telex: 42175 Kroll DK, Fax: +45-2-188807, Contact: Ms Birte. Kroell Giant Cranes A/S is a world leader in the manufacture of tower cranes with long reach and high capacity specially suited for dam construction, pumping and power station construction. Capacities from 200 tons metre and upwards.

**NIEDERBERG CHEMIE** Post Box 1163 Neukirchen-Vluyn D-4133 West Germany Tel: +49-2845-8080, Telex: 8121138. Carbofol pioneers new approaches to hydraulic engineering construction. The technologies rendered possible by Carbofol linings eliminate the possibility of water loss through seepage while at the same time reducing installation costs.

**OCV CONTROL VALVES** 7400 East 42 Place, Tulsa, OK 74145 USA. Tel: +1-918-627-1942, Telex: +810-845-2227, Fax: +1-918-622-8916. OCV manufactures and markets internationally a complete line of automatic, hydraulically operated, diaphragm actuated, pilot controlled valves. The Float Controlled Series 8000 is widely

# W A T E R - S E W A G E - S O L I D W A S T E S



## Private management of public utilities

SAUR is an international group which provides vital services to the infrastructure of its communities.

Operating in North America, Great Britain, Spain, Africa and France, SAUR's 5,000 skilled employees are committed to improving the quality of life of its customers in those communities.

## A company of the Bouygues Group

SAUR

Challenger -1, Avenue Eugène Freyssinet  
78064 St Quentin-en-Yvelines cedex - France

Tél. : (1) 30.60.22.60 -Tlc : (1) 30.60.27.89 - Tlx : 689 292 SAUR F

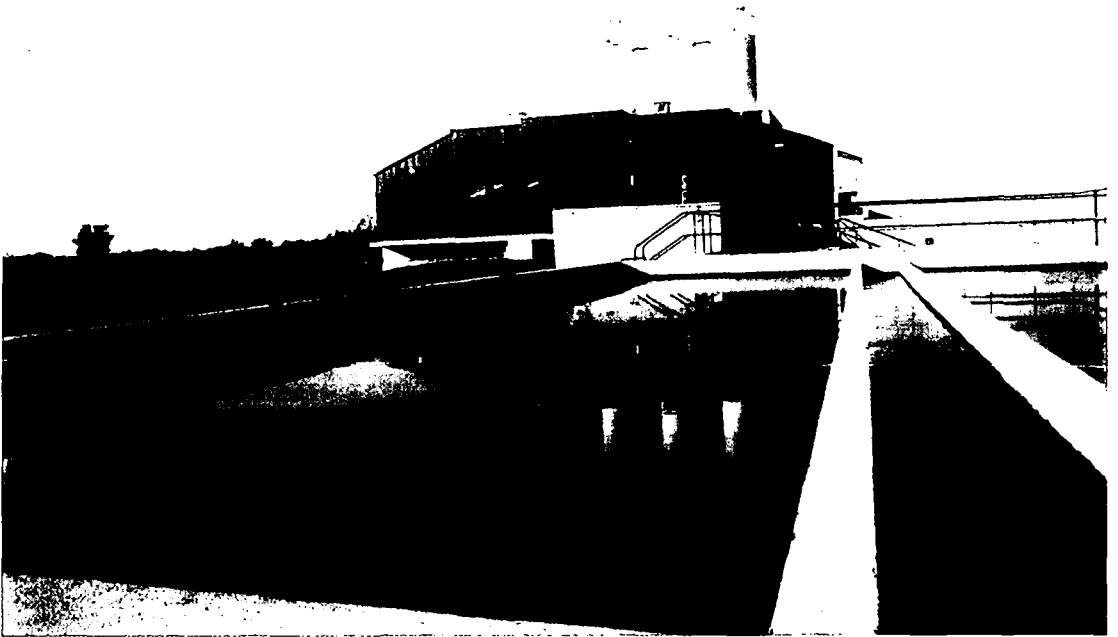

**Clean water is the key to life  
and every living thing depends on it**

**We collect it**

**We purify it**

**We distribute it**

**to guarantee a healthy environment for the future**

**That's why we're in business**

## DAMS AND RESERVOIRS

used both for on-site and remote control of reservoir levels.

**OFFICINE MACCAFERRI SpA** PO Box 396, Via Begli-Agresti No 6 Bologna 40123 Italy Tel: 39-51-23-4503, Telex: 510649, Fax: 39-51-236507. Maccaferri gabions, reno mattresses and rockfall netting for training and hydraulic protection structures, soil protection and soil conservation. Stabilisation of roads, railroads and airports. Protection of residential and industrial installations, linings of dams and water courses. Lake and coastal protection works. Rockfall and security netting.

**RUND-STAHL-BAU GESELLSCHAFT M b H** Am Brand 8 Bregenz A-6900 Austria Tel: +43-557-25-5-98, Telex: 57-400. Rund-Stahl-Bau is engaged in the production and sale of special formwork for the construction of cylindrical and funnel-shaped buildings, such as water towers, reservoirs etc.

**SINCO-SLOPE INDICATOR CO LTD** Southerham House, Southerham Lewes East Sussex BN8 6JN UK Tel: +44-273-474475, Fax: +44-273-474479, Contact: Mr Scott. Manufacturers and suppliers of dam instrumentation, inclinometers, piezometers, pressure cells, settlement gauges, extensometers, data acquisition systems and vibration monitors.

**SOIL INSTRUMENTS LTD** Bell Lane Uckfield Sussex TN22 1QL UK Tel: +44-825-5044, Telex: 95123 solin, Fax: +44-825-61740, Contact: Mr Morrison. Soil Instruments Limited is a leading manufacturer of geotechnical instrumentation with over 25 years experience of major dam and tunnelling projects. A wide range of monitoring instrumentation is available for performance and stability evaluation of soil, rock and concrete structures.

**TORQUATO DRILLING ACCESSORIES** 215 Susquehanna St, Old Forge PA 18518 USA Tel: +1-717-457-8565, Telex: +467061 Torquato CI, Fax: +1-717-457-8595. Torquato Drilling Accessories offer a full line of diamond core bits for grouting projects often relating to dams. These high quality diamond core bits are suitable for many types of rock formation and are available for all sizes and types of core barrels.

**TREVI SPA** 5819 Via Dismano Cesena 47023 Italy Tel: +39-547-331811, Telex: 550687, Fax: +39-547-317395, Contact: Mr Maremi. Foundation engineering specialists, boring and grouting for dams and reservoirs.

### Flexible Linings and Geotextiles

**AGRU ALOIS GRUBER & SOHN OHG** Grunburger Strasse 41 Bad Hall A-4540 Austria Tel: , Fax: 43-7258-21-72-74. Gruber a Agru sealing systems of polyethylene (HPPe) are used for the bottom and top sealing of domestic and special waste tips, industrial sludge pits, water reservoirs etc. Production is in extruded widths of 5m and thicknesses of 1.5 to 5mm, standard length 100m. Welding together of lengths is performed on the site by the heated-wedge method, producing a double weld with test channel. Agru sealing systems are fully weather-resistant and rotproof and thanks to their physical, chemical and biological properties ensure

reliable sealing of refuse dumps and full ground water protection.

**AKZO-FIBRES AND POLYMERS DIVISION CIVIL ENGINEERING AND INDUSTRIAL SYSTEMS P O** Box 9300 Arnham S B 6800 The Netherlands Tel: +31-85-66-4593, Telex: 45-204, Fax: +31-85-663727, Contact: Ms De Wit. Civil Engineering & Industrial Systems Division of Akzo is active in agriculture, the building industry, environmental protection, erosion control, geotechnics, hydraulic engineering and industry. The activities range from consulting during the design stage to assisting with the realization of projects.

**ALBERS B V** Nude 37b Postbus 44 Wageningen 6700 AA The Netherlands Tel: 31-8370-204-64, Telex: 45793, Fax: . Contact: Mr Wildenbeest. Alligator lining membranes are durable, flexible and impermeable. Albers b v use most up to date technologies in the prefabrication and installation of these membranes. By virtue of a professional approach, sound engineering and the know-how of experienced personnel. Albers b v are capable of providing an economical solution to practically any sealing problem.

**ALLEN PLASTICS (SITE LINING) LTD** Edison Rd Church Fields Industrial Estate Salisbury Wiltshire SP2 7NU UK Tel: +44-722-28873, Fax: +44-722-26799, Contact: M J Crossman. Allen Plastics (site lining) supply and install lining membranes for all types of liquid retaining projects. They are able to fabricate large sections of flexible linings in their factory, transport them to any site, joint by welding, to produce any size.

**AMOCO FABRICS** Kostverlorenhof 2 1183 HE Amstelveen The Netherlands Tel: +31-20-43-89-01, Telex: 14577, Fax: +31-20-45-98-87, Contact: Mr Van Wijk. Manufacturers of a full range of woven and non-woven geotextiles for use in waterworks construction and reinforcement applications.

**ANAPLAST LTD** Lundholm Rd Stevenston Ayrshire KA20 3NQ UK Tel: +44-294-605111, Telex: 778185, Fax: +44-294-601125, Contact: Bill Ingalls. Manufacturers of heavy duty polythene sheeting for reservoirs.

**BRITISH VISQUEEN LTD** Yarm Rd Stockton on Tees Cleveland TS18 3RD UK Tel: +44-642-672288, Telex: 58509, Fax: +44-642-677599, Contact: Mr Langford. Manufacturers of reservoir linings and geomembranes (including politarp).

**BURKE RUBBER COMPANY** 2250 South Tenth St San Jose California 95112 USA Tel: +1-800-669-7010, Fax: +1-408-280-0699, Contact: Larry R Schader. Burke Rubber Company is the world's leading and oldest manufacturer and supplier of flexible membrane liners and floating covers made with Dupont Hypalon® CSPE. Applications for Burke liners and covers are found in each of the following industries: potable water, wastewater, sewage treatment, chemical, oil and gas, mining, pulp and paper utilities and methane production facilities. Burke provides complete engineering and design assistance in the selection and specification of the proper material construction and details for installation.

**BUTEK LTD** 11 Radford Crescent Billericay Essex CM12

# Hypofors

## reinforced waterproofing bituminous membrane

Economical and reliable material for hydraulic engineering purposes

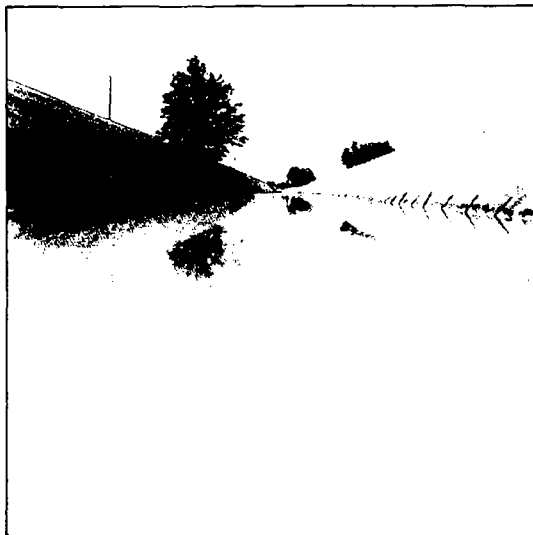
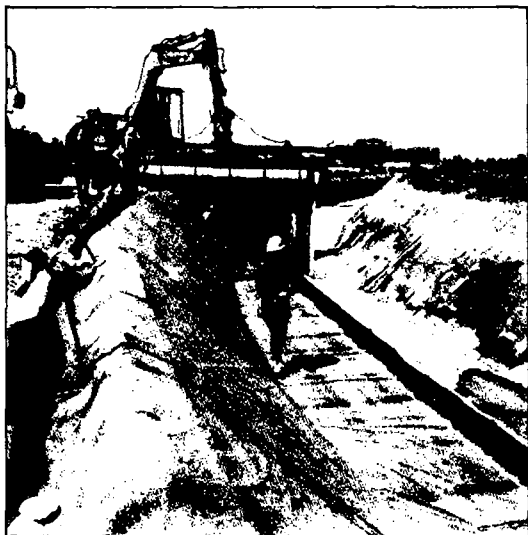

Hypofors, to avoid risks of leakage, for durability, ready and safe installation with minimum manpower. Hypofors is supplied in 5 m. wide rolls and is made up of several layers warranting optimum sealing. The material is strong, flexible and is in general resistant to inorganic chemicals (salts, acids, bases) and

organic compounds dissolved in water. Hypofors is successfully used in water reservoirs, waste water basins, waterways, municipal and industrial waste sites. The effectiveness of Hypofors has been amply confirmed in a large number of projects at home and abroad.

### Hypofors is used for:

**Waterways lining**

**Water storage**

**Waste storage**

**Other uses:**

**Shipping canals**

Drinking water

Industrial waste

Waterproofing

**Irrigation canals**

Industrial water

Municipal waste

concrete structures

Waste water

Dam lining

Tank parks

# Hypofors<sup>®</sup>

For further details please contact Hypofors vof  
Postbus 306, 6800 AH Arnhem - the Netherlands  
Phone 085 - 66 45 93/ 66 31 03, Telex 45 204 enka nl

# ASPRELON sealing strips

## the method to store and treat fluids safely



To contain process effluent in the event of break down of biological treatment unit. Surface 3.600 m<sup>2</sup>

ASPRELON<sup>®</sup> GE sealing strips are physiologically undoubtful, and are admissible for the lining of drinking water reservoirs according to ASTM, AFNOR and DIN.



Biological waste water treatment plant. Surface 5.120 m<sup>2</sup>

ASPRELON<sup>®</sup> GE sealing strips of **DUPONT** HYPALON<sup>®</sup>, are especially developed, and guarantee a maximum of service life and profitability.



Holding pond of fresh water for treatment of oil and brine. Surface 11.000 m<sup>2</sup>

ASPRELON<sup>®</sup> GE sealing strips of **DUPONT** HYPALON<sup>®</sup> are resistant against a lot of chemicals, oils and greases; are immune against all kinds of climatic influences, even against ozone; retain their flexibility and perforation strength under extremely high or low temperatures; are not affected by micro-organisms or soil chemicals and avoid the growth of mould, fungus or bacteria.

Please contact us. Being the manufacturer and supplier of ASPRELON<sup>®</sup>, we are pleased to help you solving your problems.

### CHEMOTECHNIK GMBH

Bautenschutz · D-8711 Markt Einersheim

Tel. 0 93 26/14 01 · Telex 17.932680

Telefax 09 326/14 02 · Teletex 93 26 80 D





## FLEXIBLE LININGS AND GEOTEXTILES

ODW UK Tel: +44-277-653281, Telex: 99270, Fax: +44-277-657921, Contact: John Coulson. Fabrication and installation of synthetic rubber and plastic membranes for water storage, oil pollution, effluent, lagoons, reservoir roofs and other specialised applications. Also manufacture water tanks.

**CSR HUMES PTY LTD** PO Box 31, World Trade Centre, Melbourne, Victoria. 3005, Australia Tel: +61-3611 3311, Telex: +38015, Fax: +61-3614 6347. Humepipe Systems, steel reinforced concrete ranging in size from 100mm to 3,600mm, are produced a wide variety of applications such as stormwater drainage, road culverts, sewerage and irrigation. Precast concrete products are available for a wide variety of applications both urban and rural. Humes Plastiline protects concrete pipes and structures from corrosion and renovation systems; these include Humes Duraliner and Spray Applied Linings (SAL). For soil stabilisation, they offer a range of ProPex Geotextiles or engineering fabrics for road construction, railway and drainage projects. Humes Concrete Is Australia's leading producer of concrete and a significant contributor to the nation's construction. Ever expanding, Hume has become involved with the Advance Australia Award winning Envirocycle, a compact and inexpensive alternative to domestic sewerage, septic tank and pump out systems.

**E C C NV** Terbekehofdreef 50/52 Wilrijk 2610 Belgium Tel: +32-3-828-9495, Telex: 73332 E.C.C., Fax: +32-3-830-2769, Contact: Mr Decleric. Synthetic resins - epoxy, acrylic and polyurethane based, geomembranes - bentonite and HDPE, special techniques for watertightness, solidification of waste sediments, hydroseeding and other environmental techniques.

**ESMERY CARON** 20 Avenue du Maine Paris 75015 France Tel: +331-45-44-24-90, Fax: 2002070, Contact: Mr Saintot. Manufacturers of geotextiles and geomembranes.

**FOSS EUROPE LIMITED** Marbury Whitchurch Shropshire SY13 4LN UK Tel: +44-948-5406, Fax: +44-948-5406, Contact: Christopher Ayton. Foss Mfg Co Inc USA Telex # 95-3053 Foss Geomat®-manufactured nonwoven needlepunched geotextiles for use in wide variety of applications, including geomembrane protection. Thick and permeable, Geomat® provides an excellent filter media for lateral water flow and gasses in addition to cushioning of flexible membrane liners. Produced by Foss Mfg Co Inc, USA.

**GUNDLE LINING SYSTEMS INC** 19103 Gundle Rd Houston Texas 77073 USA Tel: +1-713-443-8564, Fax: +1-713-875-6016, Contact: Sara Barber. Leading worldwide manufacturer and installer of high density polyethylene (HDPE) lining systems. Applications including solid waste landfills, hazardous waste landfills, head leach mining, tanks, ponds, reservoirs, tunnels and canals. Over 46,000,000 square meters of experience.

**HYPOFORS VOF** Velperweg 76, Postbus 9300, Arnhem, 6800 SB The Netherlands Tel: +31-85-664593, Telex: +44-45204, Fax: +31-85-662070. Hypofors is a prefab, flexible, 5m wide reinforced bituminous liner. A thin bilaterally drawn polyester film incorporated in the membrane prevents penetration of roots and plants.

The type of reinforcement (non woven, fabric) determines the mechanical properties. The composition of the bituminous mass can be chosen to fulfil the local requirements of the project.

**ICI FIBRES GEOTEXTILE GROUP** Pontypool Gwent NP4 0YD UK Tel: +44-4955-57722, Telex: 498 208 ICI FPP, Fax: +44-495-76-2772, Contact: Mr Oldfield. Manufacturers of geotextiles for the construction industry including filters, laminated filter drains and high strength products under the trade names Terram, Filtram and paraproducts.

**LOCHER & CIE AG** Pelikan-Platz 5 Zurich 1 CH-8022 Switzerland Tel: +41-1-221-56-00, Telex: +813-399, Fax: +41-1-221-24-59, Contact: . For restoration of lakes, reservoirs, rivers - the Swiss lake system - mountain creek from lake bottom waters.

**MECAROUTE** 36 Rue de Silly Boulogne-Billancourt 92100 France Tel: +33-1-4604-3300, Telex: 200080, Fax: +33-1-4604-2350, Contact: Armoria. Products for hydraulic works, embankment, civil engineering and road works, geotextiles (woven and not woven), manufacturers of bags and geotextiles clothes, geomembranes (bitumen and polymer), geosynthetics and biodegradable textiles.

**MEMPERTECH MARKETING** 2019 W County Rd C Roseville MN 55113 USA Tel: +1-612-631-1145. Distributor of components to manufacturers of membrane processing equipment of all sizes. Included are RO membrane elements, pumps, housings, pre-treatment and post-treatment equipment.

**MONARFLEX LIMITED** Lyon Way, St. Albans, Herts, AL4 0LQ UK Tel: +44-727-30116, Telex: +826542 MNFLX G, Fax: +44-72- 68045. Monarflex Geomembrane Lining System has been installed throughout the world for a wide variety of applications which include: sealing old leaking reservoirs, root zone sewage treatment, slurry lagoons, methane gas barriers, water landscaping and water containment. Monarflex have a worldwide supply and installation service and have completed huge projects in many countries of the world. As manufacturer and installer, Monarflex offer sole responsibility on all contracts undertaken by their own installation engineers.

**NAUE - FASERTECHNIK GMBH** Gewerbestrasse 2 Espelkamp D-4992 West Germany Tel: +49-5743-410, Telex: 972178, Fax: +49-5743-4133, Contact: Mr K Johannsen. Manufacturers of a complete range of geotextiles, especially non-woven types.

**NORTH AMERICAN GREEN** P O Box 66 Inglefield IN 47618 USA Tel: +1-812-867-6632, Fax: +1-812-867-6632, Contact: Mr Niemieier. Manufacturers of a variety of erosion control blankets. The blankets have been certified by laboratory testing and field evaluations to quantify erosion control effectiveness. The blankets are constructed of all natural materials.

**OFFICINE MACCAFERRI SpA** PO Box 396, Via Begli-Agresti No 6 Bologna 40123 Italy Tel: +39-51-23-4503, Telex: +510649, Fax: +39-51-236507. Maccaferri gabions, reno mattresses and rockfall netting for training

and hydraulic protection structures, soil protection and soil conservation. Stabilisation of roads, railroads and airports. Protection of residential and industrial installations, linings of dams and water courses. Lake and coastal protection works. Rockfall and security netting.

**PRESTO PRODUCTS INC** P O Box 2399 Appleton WI 54913 USA Tel: +1-414-739-9471, Telex: 887187, Fax: +1-414-738-1496, Contact: Gary Bach. The geosystems division of Presto Manufacture have two primary systems - geoweb and geoblock. Geoweb applications include erosion control, low water crossings, shoreline protection, retaining walls, spillways and pavement construction.

**PURO, BELGIUM** Leuvensesteenweg, 613 Zaventem 1930 Belgium Tel: +32-2759-59-45, Fax: +32-2759-77-79. After years of research and development, PURO succeeded in constructing a membrane, suitable for every watercombination delivered by waterplants. Not only that, but the material used is special bacteria resistant. Therefore it is no longer necessary to send the membrane back to the factory for cleaning. Half an hour of flushing per week, by means of the built-in flushing system, is sufficient to keep the membrane clean and operational for many years.

**REEMAY INC** PO Box 511 Industrial Rd Old Hickory TN 37138 USA Tel: +1-615-847-7132, Fax: +1-615-847-7068, Contact: Bill Hawkins. Manufacturer of nonwoven spunbonded polyester and polypropylene fabrics for agricultural, apparel, furniture and bedding, filtration, geotextiles and construction fabrics applications.

**S ROBB & SON** Unit 3c Cromwell Business Park New Rd St Ives Cambs PE17 4BG UK Tel: +44-480-62150, Contact: Mr R Whitby. Suppliers and installers of flexible liners for water storage and landfill sites, also offering an advisory service prior to installation. Work includes ornamental ponds and lakes, storage lagoons and reservoirs in sizes from garden ponds up to a 35 acres.

**SCHLEGEL LINING TECHNOLOGY GmBh** Bredowstrasse 33 Hamburg 74 D-2000 West Germany Tel: +49-40-73329-0, Telex: 216-37-48 SLT D. For many years Schlegel Lining Technology has been known as the manufacturer and installer of a highly qualified liner - the Schlegel sheet. Schlegel sheet was developed to meet the exacting requirements of large area sealing applications such as waste disposals, water reservoirs, canal linings ect. Schlegel sheet, being manufactured by a purpose designed patented process in rolls 10 metres wide, and depending on thickness, up to 200 metres long, has become the key element of present day waste disposal.

**SWISS SILK ZURICH** Grutlistrasse 68 Zurich CH-8027 Switzerland Tel: +01-288-91-11, Telex: 815-507, Fax: +01-288-93-93. Products: Synthetic filter belts, vacuum filter belts, fabrics for filter-presses, discfilter. Fabrics for micro screening and injection moulding of irrigation filters.

**TAURUS HUNGARIAN RUBBER WORKS** P O Box 25, Kerepesi u 19 Budapest VIII H-1440 Hungary Tel: +36-1-141040, Telex: +225312 225313, Fax: +36-1-188754.

The Taurus waterproofing system is ideal for lining canals, all reservoirs, earth dams, engineering structures, water towers etc.

**VCO GEOTEXTILES** Bellevue 1 Gent B-9218 Belgium Tel: +32-91-30-90-50, Telex: +11450, Fax: +32-91-30-26-42. A wide range of woven and non-woven Geotextiles in polypropylene, polythene, polyethylene and polyester. Weights range from 90 to 1800 grammes per square metre.

**WHITE CROSS RUBBER PRODUCTS LTD** White Cross Lancaster LA1 4XH UK Tel: +44-524-62555, Telex: 65451, Contact: Mr V Williams. Manufacturers of rubber sheeting which may be fabricated for the lining of pits, pools and reservoirs.

### Flood Protection

**B M FLOW REGULATORS LTD** 4-6 Bridge St Tadcaster North Yorkshire LS24 9AL UK Tel: +44-937-832778, Telex: 57697 yorxev bm, Fax: +44-937-834413, Contact: Mr Peter Hastewell. Stainless steel flow regulators for flood control. Installed in sewers etc to control the flow. Vortex flow pattern enables large outlet areas to be used thus eliminating the risk of blockages.

**CONCRETE ARMOR SYSTEMS** 3 Garmany Place Yonkers NY 10710 USA Tel: +1914-779-5858, Contact: Ray O'Neill. Research and development of concrete shapes for bank stabilization and flood walls. Designed products for river & coastal protective works.

**GERSAR** 4 Rue Galilie Paris F 75116 France Tel: +33-1-472-36064, Telex: +613-525, Fax: +33-1-47-209590. Gersar is an international engineering company which pools the technical capabilities of the French regional development companies, gathering 2,500 people, including 1,400 engineers and technicians. Hydro agricultural developments, (water resources, dams, large supply systems, irrigation and drainage networks) navigation and flood warning.

**OY E SARLIN AB** Po Box 750 Helsinki 10 00101 Finland Tel: +358-0-535022, Telex: 121894, Fax: +358-0-5633989, Contact: Mr Saaremi. Sarlin is a manufacturer of submersible pumps for sewerage systems, raw water intake, dewatering, irrigation and flood control. Pumps are easy to install and maintain.

**ACCUSONIC DIVISION FERRANT ORE INC** PO Box 709 Falmouth Massachusetts 02541 USA Tel: +1-617-548-5800, Telex: 6817399, Fax: +1-617-540-3835, Contact: Diane Ward. Accusonic offers a variety of flow measurement systems and services all based on the highly accurate multiple parallel path ultrasonic technique. Both permanent and portable systems are available to meet virtually all flow measurement requirements.

**BADGER METER INC** Box 23099, 4545 W Brown Deer Rd Milwaukee WI 53223-0099 USA Tel: +1-414-355-0400, Fax: . Manufacturer of flow meters and systems for flow measurement and control used in water conditioning and water treatment applications. (WT)



Since the early 1970s, the Monarflex Geomembrane Lining System has been recognised as a market leader within the water industry.

Monarflex have installed liners on both large and small projects in many countries of the world, one of which is the 175 million litre reservoir to serve Otte Village in Nigeria. Built during the International Water and Sanitation Decade, as part of the Kwara State Water Supply Project, the reservoir forms an off-stream storage facility to one of the treatment plants — installed by the main contractor Bewater Shellabear (Nigeria) Limited.

The total contract involves water supply to over 50 villages from artesian bore holes, impounding reservoirs and off stream storage. This then goes through treatment plants and via pipe work to supply tanks and stand-pipes. The off stream storage concept involves building a large reservoir close to a river. The reservoir is filled during the wet season to provide storage over the dry months.



51,000m<sup>2</sup> of Monarflex '500' Geomembrane, in 36 prewelded sections was delivered to site along with 100,000m<sup>2</sup> of Polyfelt Geotextile, which provided a protective layer above and below the membrane. The 36 sections were installed by a Monarflex team of two, under the direction of an engineer, in just 13 days. Local labour was used for section positioning, the main contractor provided unloading and handling equipment.

The backfill was 500mm of laterite and was hauled in with dump trucks and spread by two D6s. Monarflex '500' Geomembrane was specified following its successful use on other similar projects.

Monarflex '500' Geomembrane is a low density reinforced polyethylene which offers excellent flexibility and a high degree of chemical and UV resistance. It can be supplied in 4-metre standard roll widths with the option of specially prewelded sections configured to required shapes up to 1,500m<sup>2</sup>, which can then be welded together on site.

For further information on Monarflex Geomembrane Lining System, please contact us at:

# **Monarflex**

MONARFLEX LTD Lyon Way, St. Albans, Herts AL4 0LQ  
Tel: 0727-30116 Fax: (0727) 68045 Telex: 826542 MNFLX G

## FLOOD PROTECTION

**BARFLO LTD** 56 Cavendish Place Eastbourne East Sussex BN21 3RN UK Tel: +44-323-27877, Fax: +44-323-411952, Contact: Mr Saunders. Barflo supply equipment for water conservation and control. Also distributors of PVC and polyethylene piping. Barflo is a subsidiary of "Wolsey Centres Ltd".

**K BIESINGER GmbH** Neckarsteinacher Strasse 74 Hirschhorn 6932 West Germany Tel: +4-6272-2037, Telex: 466808, Contact: Mr Thurnwald. Biesinger supply water meters for houses, flats and rooms.

**BUSH BEACH ENGINEERING LTD** Stanley Green Trading Estate, Earl Rd Cheadle Hulme Cheshire SK9 3RL UK Tel: +44-61-485-8151, Telex: 667-548, Fax: +44-61-488-4048, Contact: Mr John Moss. Flow measuring products including orifice plate and Venturi sensors, complete metering runs and flow transmitters and totalisers, temperature sensors, transmitters and indicators for monitoring pumps and machinery.

**C W COX INC** P O Box 3214 South El Monte CA 91733 USA Tel: +1-818-443-5090, Contact: John Morgan. Insertion and inline water flow instruments for test or permanent installation. Full diameter pitot tubes or center sampling rotameter-style meters. Scaled in gpm/in<sup>2</sup> of flow area. Inches of water, gallons per minute and litres per mite.

**CARLON METER CO** 715 Robbins Rd Grand Haven MI 49417 USA Tel: +1-616-842-0420, Contact: Jim O'Brien. Manufacture water meters for the municipal, commercial and industrial market place. Also electronic control for treatment of water.

**CHEYLINE-INSTRUMENTS INC** 800 Campbell St Cornwall ONT K6H 6L7 Canada Tel: +1-613-938-8956, Telex: 05811520, Fax: +1-613-938-4857, Contact: Mr Higginson. Manufacture non-contacting flow and level instrumentation. The products include doppler type flow meters which work from outside a pipe, open channel flow meters, liquid level indicators and pump controllers.

**CONTROLOTRON CORP** 155 Plant Avenue Hauppauge NY 11788 USA Tel: +1-516-231-3600, Telex: 961449, Fax: +1-516-231-3334, Contact: Tony Dove. Clamp on ultrasonic flow meters for potable water, incoming waste water, sewage treatment lines, pipelines and other liquid applications.

**W S DARLEY & CO** 2000 Anson Drive Melrose Park IL 60160 USA Tel: +1-312-345-8050, Fax: +1-312-345-8993, Contact: Paul C Darley. Manufacture a complete line of portable pumps, flow testing equipment, leak locators, dipping needles, pitots and offer a complete municipal supplies catalogue.

**DATAMATIC INC** 2121 North Glenville Drive Richardson Texas 75082 USA Tel: +1-214-234-4491, Telex: 6502721938, Fax: +1-214-234-1134, Contact: Mr Larry Parchment. Vendors of meter reading systems for utilities throughout the world.

**DOMINION BRIDGE SULZER INC** 555 Notre Dame St Lachine Quebec Canada Tel: +1-514-634-3551, Telex: 05-821583, Fax: +1-514-636-8588, Contact: Claude Pa-

try. Manufacturers of penstocks and gates. Part of the AMCA International group.

**DSK SYSTEMS LTD** Highfield Rd Walton-on-Thames Surrey KT12 2TS UK Tel: +44-932-223102, Telex: 946240, Contact: May Spelles. Automatic level and flow control for rivers and estuaries. Turnkey system applicable to all level/flow control problems. Data archiving, easy control by unskilled operators, modular and expandable and fault tolerant.

**ELIN-UNION AG FUÜR ELEKTRISCHE INDUSTRIE** POB 5, Penzinger Strasse 76 Wien A-1141 Austria Tel: +43-1-829000, Telex: 1-12763. Elin's line-up of water supply equipment embraces devices for water flow measurement and equipment for testing and calibrating these. The emphasis here is upon vane water meters. Elin are interested mainly in the export of domestic water meters.

**FLEXIBLE-DRIVES (GILMANS) LTD** Kineton Industrial Estate, Southan Leamington Spa CV33 0DS UK Tel: +44-926-813818, Telex: 31451, Contact: Mike Neville. Portable valve actuators for underground mains distribution and supply powered by petrol, diesel or electricity. Also penstocks, sluice gates etc.

**FLOSONICS INC** PO Box 390 Umatilla Oregon 97882 USA Tel: +1-503-567-1966, Contact: Terry R Henderson. Flosonics Inc specializes in acoustic flow measurement for a variety of fluids in pipelines from 0.5" to 35ft in diameter. Trained personnel operate state-of-the-art equipment for accurate flow measurement and are capable of complete water system analysis, including pumping performance analysis.

**FLOW RESEARCH CORPORATION** P O Box 27871 Houston Texas 77227 USA Tel: +1-713-623-2143, Telex: 762649, Contact: Bill Smith. Manufacture flow meters for liquid flow in various applications. Also three non-contact meters measuring flow from outside pipe.

**HEEL GmbH & CO MESSTECHNIK KG** Jaeoerstrasse 4 - 12 Postfach 17 45 Kempten D-8960 West Germany Tel: +49-831-20-59-02, Fax: +49-831-2-05-9105, Contact: Herbert Friedrich. Hydrometric instruments, current meters.

**INVENTRON** 23630 Industrial Park Drive Farmington Hill MI 48024 USA Tel: +1-313-473-9250, Fax: +1-313-473-9255, Contact: Gregory Marynba. Offers a complete line of ultrasonic flow measuring systems for non-contact measurement in flumes, weirs and other open channels. Micro-processor based controller provides direct readout of flow rate.

**JANSEN VENNEBOER B V** P O Box 12 AA Wijhe 8130 The Netherlands Tel: +31-5702-2525, Telex: 49418, Fax: +31-5702-3618. Design, production and installation of mechanical construction for hydraulic works. Products include: archimedean screws, penstocks, sluice gates, radial gates, regulating and measuring weirs, weedscreens, automatic raking installations, Volanta handpumps, low-head water turbines (upto 1000 kW).

**WARREN JONES ENGINEERING LTD** 120-124 Churchill Rd Bicester Oxon OX6 7XD UK Tel: +44-869-

## FLOOD PROTECTION

246691, Telex: 83194, Fax: +44-869-253340, Contact: John Corris. Manufacturers of ultra-sonic level measurement equipment, sewage treatment monitoring equipment, and portable open-channel flow recorders.

**KENT METERS LTD** Pondwicks Rd Luton Bedfordshire LU1 3LJ UK Tel: +44-582-402020, Telex: 825367, Fax: +44-582-36657, Contact: Mr Harris. Kent Meters is one of the world's largest manufacturers of domestic and bulk water meters with a reputation for innovative design and advanced technology. The Kent range includes volumetric, multi jet and single jet domestic water meters.

**KEY INSTRUMENTS INC** 250 Andrews Rd Trevoze PA 19047 USA Tel: +1-215-357-0893, Fax: +1-215-357-9239, Contact: Joe Papiernik. More than 60 standard 10:1 scales for air and water in SAE or metric indicate flow from 5cm<S3> to 23 gpm or tailored to specific OEM requirements for most gas or liquid applications.

**KRACHT PUMPEN - UND MOTORENFABRIK GmbH & CO KG** P O Box 1420/40 Werdohl D-5980 West Germany Tel: +49-2392-540, Fax: +49-2392/54209. Kracht is a highly regarded manufacturer of complete hydraulic systems and controls for the following: navigation locks, flood barriers, penstocks in tidal and inland waterways etc.

**NBA ENVIRONMENTAL SYSTEMS** Invincible Rd Farnborough Hampshire GU14 7QU UK Tel: +44-252-514335, Telex: 858510, Fax: +44-252-521912, Contact: Mr Gittings. With over 22 years experience in environmental monitoring, products include: water level and quality measuring instruments and clean or dirty water flow meters, for open channel and closed conduit application.

**NUSONICS INC** 11391 E Techimsett St Tulsa OK 74116-1602 USA Tel: +1-918-438-1010, Telex: 49592, Fax: +1-918-438-6420, Contact: Ranson. Line of transit-time flow meters provide accuracy + 1% no moving parts, no pressure loss.

**OCV CONTROL VALVES** 7400 East 42 Place Tulsa, OK 74145 USA Tel: +1-918-627-1942, Telex: 910-845-2227, Fax: +1-918-622-8916. OCV manufactures and markets internationally markets a complete line of automatic, hydraulically operated, pilot controlled valves. Its Series 120 Rate of Flow valves are in widespread use in applications where it is necessary to maintain a constant rate of flow regardless of fluctuations in upstream or downstream pressure.

**PERFLOW-INSTRUMENTS LTD** Unit 3 Chapman Park, High Rd London NW10 2DY UK Tel: +44-1-451-4577, Telex: 923620, Fax: +44-1-451-6788, Contact: Terry Gluck. Flow measurement equipment mainly of orifice plate and local indicator type. Remote reading electronic indication and control is an available option. Small variable area flow meters are also supplied. Materials are rigid plastic and stainless steel.

**POLYSONICS** 3221 Marquart Houston TX 77027 USA Tel: +1-713-623-2134, Fax: +1-713-623-6988, Contact: Bill Smith. Manufacturers of ultra sonic, non-contact flow meters for liquid flow measurement.

**QUADRINA LTD** Flint Rd Letchworth Herts SG6 1HS UK Tel: +44-462-673486, Telex: 826726, Fax: +44-462-674666, Contact: Stuart Atkins. Manufacturers of flow measurement instrumentation and associated control and display systems. Specialists in the supply of portable flow monitoring equipment for distribution analysis and waste water detection and permanent flow metering installations.

**SARASOTA AUTOMATION LTD** Kingsworthy Winchester Hants SO23 7QA UK Tel: +44-962-883200, Telex: 47189, Fax: +44-962-885530, Contact: Derek O'Garr. Sarasota produce flow and level gauges for rivers and sewers using ultrasonic and electromagnetic techniques. Sherpa loggers and viewlog software are used in water distribution to monitor flow and pressure in a network.

**SEMPERIT (INDUSTRIAL PRODUCTS DIVISION)** Modecenterstrasse 22 A-1031 Wien Vienna Austria Tel: +43-222-7800-587, Telex: 131889, Fax: +43-222-7800-606, Contact: Mr Hans Pruszinsky. Semperit produce gate and lock seals made of high-grade polymers in the most varied designs and is agreed as an enterprise with great technical expertise, capable of offering or working out solutions that meet the requirements of the hydraulic steelwork engineers.

**SPECTRASCAN LTD** 42 New Brighton Rd, Emsworth, Hants, PO10 7QR UK Tel: +44-243-379121, Telex: +9312102018, Fax: +44-243-371471. Spectrascan's comprehensive range of equipment for the Supply and Distribution Manager is well described in their special catalogue (available free by telephone request). This includes mechanical and electromagnetic insertion probes for use in large pipes, and sensor units to fit a wide range of Woltmann or Helix type flow meters. As well as tough reliable displays, loggers etc, fully compatible with these sensors, the company can even supply sophisticated microprocessor controllers adjusting flow dependent on the conditions.

**STROUD INSTRUMENTS LTD** Locking Hill Stroud Gloucestershire GL5 1QN UK Tel: +44-4536-5433, Telex: 43621, Fax: +44-4536-4256, Contact: Mr G A Davis. Design, manufacture and sale of flow measurement equipment and process instrumentation including GRP flume liners, signal converters, trip amplifiers, isolators, linearisers, integrators, summators, square root extractors, and power supplies.

**TUBAFOR INTERNATIONAL** 39, Champs Elysées, Paris, 75008, France Tel: +33-1-42-25-93-42, Telex: +280888, Fax: +33-1-45-63-84-08. Hydrometric instruments, electric contact meters, water level indicators, water level recorders - float, bubbler gauge, pressure transducer; borehole water samplers, solid state memory recorders, logging equipment.

**J M VOITH GmbH** PO Box 1940, St Poltner Strasse 43 Heidenheim D-7920 West Germany Tel: +49-7321-370, Telex: +714-79920, Fax: +49-7321-373000, Contact: . Hydraulic, pneumatic and electronic measuring and control systems.

**WESTINGHOUSE OCEANIC DIV** Box 1488 Annapolis MD 21404 USA Tel: +1-301-260-5491, Fax: +1-301-

# FLOOD PROTECTION

260-5393, Contact: Pete Cernik. Transit-time leading edge flowmeters-LEFMTM. Available systems include single, two and four paths for pipes to 40ft in diameter.

**ZWAG ZSCHOKKE WARTMANN AG** Dottingen CH-5312 Switzerland Tel: +41-56-40-91-01, Telex: 825120, Fax: +41-56-453739, Contact: Herr Brauer. Design, fabrication and installation of hydraulic steel structures and equipment such as all kinds of gates, stoplogs, trashtracks, penstocks etc. All over the world.

## Recreational Use of Water

**AQUA CONTROL INC** 320 Lasalle Rd Lasalle IL 61301 USA Tel: +1-815-223-6303, Contact: Willis Dane. Aqua controls makes a variety of aerators and decorative fountains which can improve conditions of many lakes. Units of 1/2 to 3 Hp, in several voltages and in single and 3-phase are available. They are light and easy to install and offer lake owners an economical opportunity to improve their lakes.

**INVARMEX UK LTD** 74a Cropwell Rd Radcliffe On Trent Nottinghamshire NG12 2JG UK Tel: +44-602-332974/334455, Fax: +44-602-333388. Invarmex manufacture, distribute and export equipment for outdoor parks and swimming pool leisure complexes. Products include filters, pumps and circulation fittings, flumes, slides pool covers and water fun equipment eg. mushrooms, jets etc. Also fountains and fittings.

**KAY PARK-RECREATION CORP** Hwy 218 South Janesville Iowa 50647 USA Tel: +1-319-987-2313, Fax: +1-319-987-2161, Contact: Carl M Howe. Kay Park pedal cruisers come in two and four passenger models - heavy fiberglass construction provides durability and lustrous finish. These units have proven history in rental boats, and can pay for themselves in a single rental season. Solid foam filled pontoons give unsinkable flotation and safety. Contact Kay Park Recreation Corp for more information.

**WESTMOOR LTD** 3452 N Knox Avenue Chicago IL 60641 USA Tel: +1-312-282-2237, Fax: +1-312-282-4954. Manufacture rotary vane, positive displacement air blowers used for aeration. Products include pumps and pump units plus aeration kits. Aeration systems by Westmoor are used in waste water facilities, lake management and aquaculture, where conventional blowers are unable to overcome the static pressure of greater than 3ft of water.

## Water Transportation and Export

**DUNLOP LTD GRG DIVISION** Cambridge St Manchester M60 1PD UK Tel: +44-61-236-2131, Telex: 667225, Fax: +44-61-236-1599, Contact: Mr Bennett. Manufacturers of high quality collapsible containers, flexible tanks for storage and transportation of fluids. Sizes range from 225 to 225,000 litres capacity.

**NORTHUMBRIAN WATER** PO Box 4, Regent Centre Newcastle-upon-Tyne NE3 3PX UK Tel: +44-91-284-3151, Telex: 537419, Contact: George House. Huge volumes of treated drinking water and high-grade irri-

gation and industrial water - from the UK'S largest water resource - Kielder Water Reservoir. Shipped via the international deep water facility at Teesport.

**PRONAL S A** Roubaix Cedex 1 BP25-59051 France Tel: +33-20-24-1819, Fax: +33-20-27-23-10, Contact: Mr Gerard Naltas. Pronal is a family-owned company specialising in the manufacture of technical inflatable products made of rubber-coated fabric, eg flexible tanks for storage and transport of liquids such as water or petroleum products, lifting bag, inflatable stoppers for pipes and various products for the industry.

**WESTERN TRAILERS** 22 The Green, Stoke Gifford Bristol BS12 6PD UK Tel: +44-272-694273, Telex: 444389. Western Trailers of Bristol, England are manufacturers and suppliers of all types of tankers, trailers and tanks. Customers include many foreign government bodies and charities whose work is to provide potable water in difficult environments.

## Rainfall, Instruments etc

**DETECTRONIC LTD** Systems House, Edge Nook Lane, Shadsworth Blackburn BB1 2QB UK Tel: +44-254-54583, Telex: 635091 Albion G, Fax: +44-254-680604, Contact: Mr Woods. Manufacture a comprehensive range of specialised systems for many applications including: sewer flow and rainfall measurement and analysis, flow measurement and control of sewage treatment works, industrial process and effluent measurement, level measurement and control, pump protection using non-invasive flow detection.

**OBSERMET (UK) LTD** Unit 3, Springwood Court, Springwood Industrial Estate, Rayne Rd Braintree Essex CM7 7QX UK Tel: +44-376-23521, Telex: 946240 CWEASY, Fax: +44-376-45780, Contact: Mr Mayes. Obsermet have developed a wide range of measuring, monitoring and recording instruments for use in irrigation, hydrology and meteorology. In addition to water level, rainfall, windspeed, wind direction sensing and recording systems, Obsermet have developed a range of fixed and mobile solar-powered weather stations.

**R W MUNRO LTD** Gilbert House, 406 Roding Lane South Woodford Green Essex IG8 8EY UK Tel: , Telex: +44-1-551-4565, Fax: +44-1-591-7000, Contact: Mr Pressland. 24130 Manufacturers and worldwide suppliers of meteorological equipment, rain gauges, water-level recorders, barometers, thermometers and barographs.

**SMAIL SONS AND CO LTD** Unit 1, St Andrews Rd Glasgow G41 1PP UK Tel: +44-41-429-4429, Telex: 777360 SMAIL G, Fax: +44-41-429-2949, Contact: Mr Wheelars. Sole representative in UK for Obsermet and Thies meteorological equipment and Sphor hydrographical instruments. Range covers wind, temperature, humidity, pressure, sunshine, rainfall, water level, display, recording/logging and transmitting.

## Land Drainage

**AKZO-INDUSTRIAL SYSTEMS** PO Box 306 SB Arnhem The Netherlands Tel: +31-85-664600, Telex:

## LAND DRAINAGE

45204, Fax: +31-85-664838, Contact: Mr Voskamp. Manufacturers of soil reinforcement fabrics and pre-fabricated end drains, erosion prevention products and drainage material.

**ARCO INDUSTRIES INC** 322 Riley Rd Houston Texas 77047 USA Tel: +1-713-227-8710, Telex: 775017, Fax: +1-713-433-5655, Contact: Garth Cook. Manufacturers of off-highway vehicles, drilling equipment.

**BIG 'O' INCORPORATED** P O Box 970 Exeter Ontario N0M 1S0 Canada Tel: +1-519-235-0870, Telex: 064-5659, Fax: +1-519-235-2144, Contact: Mr Ron Chanyi.

**CSR HUMES PTY LTD** PO Box 31, World Trade Centre, Melbourne, Victoria. 3005, Australia Tel: +61-3611 3311, Telex: +38015, Fax: +61-3614 6347. Humepipe Systems, steel reinforced concrete ranging in size from 100mm to 3,600mm, are produced for a wide variety of applications such as stormwater drainage, road culverts, sewerage and irrigation. Precast concrete products are available for a wide variety of applications both urban and rural. Humes Plastiline protects concrete pipes and structures from corrosion and renovation systems; these include Humes Duraliner and Spray Applied Linings (SAL). For soil stabilisation, they offer a range of ProTex Geotextiles or engineering fabrics for road construction, railway and drainage projects. Humes Concrete Is Australia's leading producer of concrete and a significant contributor to the nation's construction. Ever expanding, Hume has become involved with the Advance Australia Award winning Envirocycle, a compact and inexpensive alternative to domestic sewerage, septic tank and pump out systems.

**FLYGT AB** Box 1309 S-171 25 SOLNA, Sweden. Tel: +46-8-733 6500, Telex: +43887 flygtab s, Fax: +46-8-295816, Contact: Anderz Öhringe. Flygt is the world's leading manufacturer of submersible heavy-duty pumps for contaminated and abrasive liquids. The annual sales for 1988 was approx SEK 2.3 billion. With over 1,250,000 installations in more than 100 countries throughout the world, Flygt submersible products encompass an awesome range of pumps, mixers and hydro turbine generators for small scale hydro electric power stations. The main office is situated in Solna, just outside Stockholm, with manufacturing facilities are in Lindas. Flygt has subsidiaries in 16 countries and 3,400 employees of which 1,500 are in Sweden.

**GERSAR** 4 Rue Galilie Paris F 75116 France Tel: +33-1-472-36064, Telex: +613-525, Fax: +33-1-47-209590. Gersar is an international engineering company which pools the technical capabilities of the French regional development companies, gathering 2,500 people, including 1,400 engineers and technicians. Hydro agricultural developments, (water resources, dams, large supply systems, irrigation and drainage networks) navigation and flood warning.

**GRUNDFOS INTERNATIONAL A/S** P D Jensensvej 7, Bjerringbro 8850 Denmark Tel: +45-6-68-14-00, Telex: +60731 gfos dk, Fax: +45-6-68-44-72. Where land drainage cannot be effected through gravity, Grundfos pumps types SP - BP can be installed. Grade of stainless steel according to application. Capacity range: Q: 0 - 280 cbm/h, H: up to 500 metres.

**NETLON LTD** Kelly St Blackburn Lancashire BB2 4PJ UK Tel: +44-254-62431, Telex: 63313, Fax: +44-254-680008. Tensar Mat is an effective and permanent method of controlling the erosion of wet or dry slopes, and Tensar or Netlon gabions provide effective and non-corrodible erosion control structures. Netlon drainage pipes have high flow capacities and provide fast and effective irrigation and drainage. Netlon drainage nets are high profile structures used in the construction of lagoons and similar structures.

**PRIESTMAN LTD** Hedon Rd Hull HV9 5PA UK Tel: +44-482-75111, Telex: 52120, Fax: +44-482-702065, Contact: Margaret Turnbull. Specialist manufacturers of land drainage equipment including variable counterbalance earth moving machines, hydraulic excavators, draglines, grabs and grab dredgers.

**VANDEZANDE** Esenweg 142 Diksmuide 8160 Belgium Tel: +32-51-50-01-17, Telex: 81649, Fax: +32-51-504-117, Contact: Mr Vandezande. Manufacturers of screw pumps for sewage and effluent. Also for land drainage.

**VOPO POMPEN- & MACHINEFABRIEK BV** De Volger 2 De Rijk NL 1483 GA The Netherlands Tel: +31-2997-1312, Fax: +31-2997-3358. Surface water pumps, built for continuous operation, maintenance free. Large capacity for low heads. Widely used for drainage and irrigation jobs. Capacity 40 - 1000 M<sup>3</sup>/hour.

## DEVELOPING WORLD WATER

**E**ntries ending in WT are taken from Water Technology Magazine's Planning and Purchasing Handbook. The subscription address is: Water Technology Magazine, 13 Century Hill Dr, Latham, NY 12110, USA. Telephone (518) 783-1281. Entries ending in IAWPRC are reproduced from the 1987-88 Yearbook of the International Association on Water Pollution Research & Control (IAWPRC) with the Association's consent. IAWPRC, 1 Queen Anne's Gate, London SW1H 9BT, England.

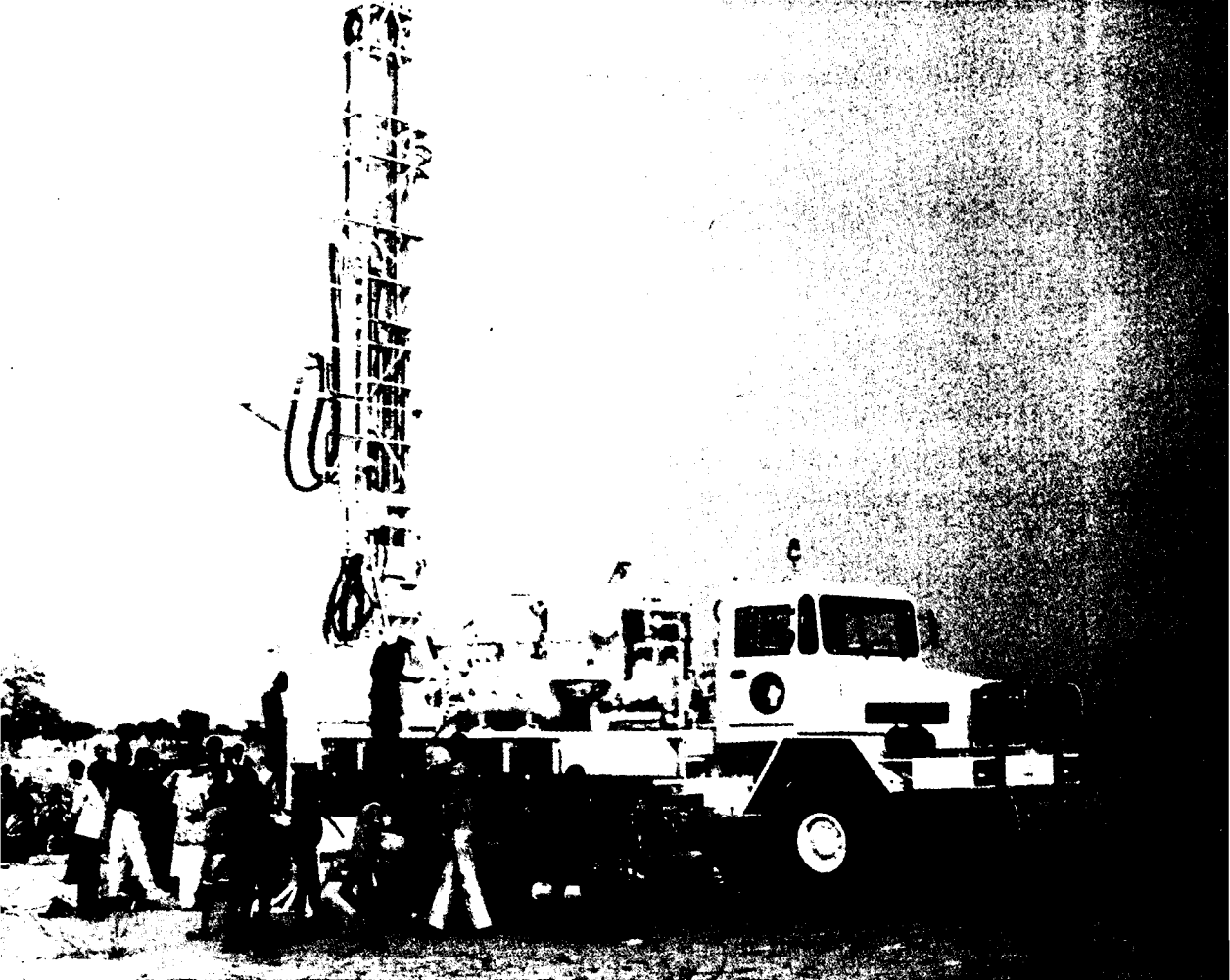

## The D25KW from Tamrock Driltech

It can save you money in the short run as well as in the long run.

Since the D25KW is assembled on a sub-frame, it can be mounted on any carrier that meets required specifications. Even a trailer. For International customers, this can mean big savings. If you purchase the carrier in the country of final destination, you can eliminate import duties on the single most costly drilling rig component.

For economical operation, the D25KW is powered by a 400 hp fuel efficient XL series diesel engine. By developing rated horsepower at 1800 rpm, this engine can reduce fuel consumption by as much as 9% when compared to competitive engines running at 2100 rpm. In addition, engine life before overhaul should increase by 20 to 30 percent.

With 30,000 lbs. of holdback and 51,400 inch lbs. of torque, the D25KW gives you performance as well as economy. An 840 cfm/350 psi compressor is standard.

The D25KW from Tamrock Driltech. Everything you always wanted on a drill. Including your choice of carrier.



P.O. Box 338  
Alachua, Florida 32615 USA  
(904) 462-4100 • TELEX 56-8441  
FAX (904) 462-3247

P.O. Box 249  
SF 33101 Tampere, Finland  
TEL +358-31-2414111 • TELEX 22616  
TELEFAX +358-31-123241



•Groundwater•

# CONTEMPORARY DEVELOPMENTS IN WELL DRILLING

by  
W. S. Moffat

**Cable tool percussion drilling rigs have not changed in their essentials for many years and it is doubtful if they will in the future.**

They provide a slow but sure method of drilling almost any formation and the rigs are simple to maintain and of lower initial cost than most rotary machines. Changes have been concentrated in the rotary and DTH fields. Small, mobile, light weight and manoeuvrable rigs able to handle continuous flight augers; water, mud and air flush rotary; and DTH have been developed. These are especially useful in Developing Countries where access to drilling sites may be difficult or impossible for the more traditional larger rigs. These include, among others, the HE 20LR Land Rover mounted, the Dando 110 and the Aquadrill 60. The Aquadrill can be dismantled into hand portable sections and so can reach all sites.

The problems of overburden drilling with DTH equipment which originally could only be accomplished by using dual purpose rigs has been solved by the introduction of the eccentric bit. This can be inserted through casing and then expanded to drill a hole large enough to allow the casing to follow. When hard rock is reached, the bit is contracted and can be withdrawn through the casing. These have been developed as Odex, Simcas and Bulroc drills.

Drilling muds have moved away from the once tra-

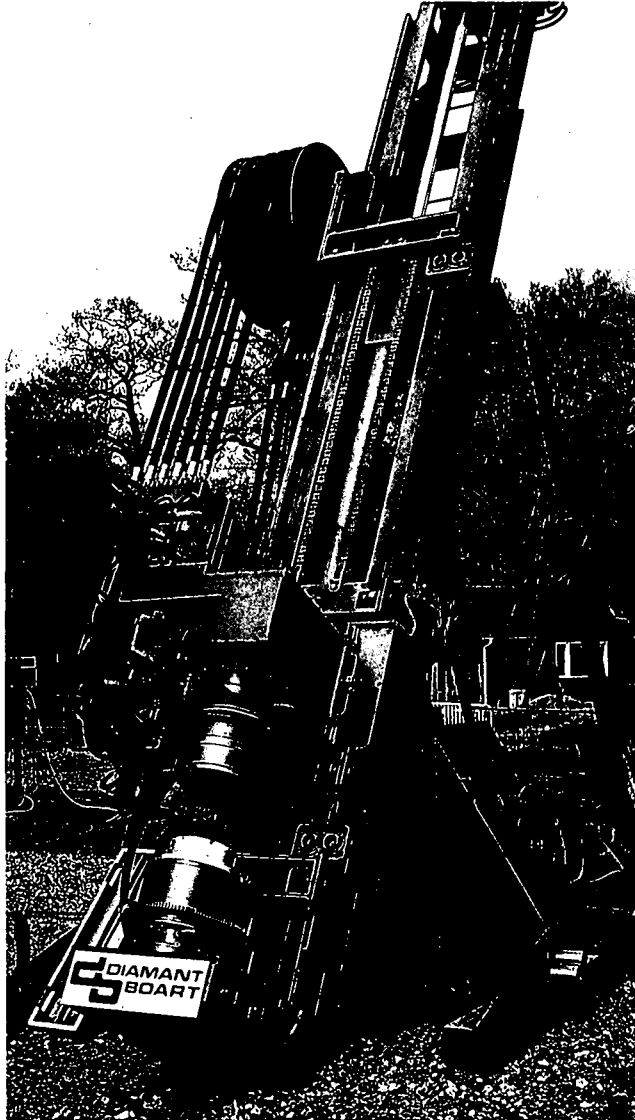

*Diamant Boart automatic drill left and control panel right.*

ditional bentonite and the associated difficulties and time consuming development in order to ensure that all mud was removed to enable the borehole to attain its maximum yield. Polymer muds based on a variety of chemicals and natural gums which are much easier to remove during development are under constant devel-

## GROUNDWATER

opment, much of it as a spinoff from the oil industry.

Foaming agents injected into the air supply of air flush drills allows the volume of air required to lift the cuttings to be reduced without any loss of hole clearing ability. This enables smaller compressors to be used, an important factor when access is difficult. Foam also allows DTH rigs to penetrate thin bands of clay without the usual clay balling occurring and consequent poor hole cleaning. New and more efficient foaming agents are frequently appearing on the market.

On the simple low cost front of water well construction, Silsoe Collage has developed a small hand held jetting system capable of producing a 200 mm hole to 20 m or greater depth in unconsolidated formations. This is especially useful in small scale irrigation.

At the expensive end of the market automatic drilling control is being experimented with by Diamand Board among others. Sensors monitor all important drilling parameters such as speed of rotation, weight of the bit, volume of mud circulation and penetration rate. These are all fed into a microprocessor which suggest whether the most economic values are being used and applies a shut down if any damage is being done to the equipment. At present its cost will probably preclude its early use in water well work.

Reverse circulation methods are being used to con-

struct large diameter gravel packed wells in suitable unconsolidated formations in Bangladesh and Pakistan. This method produces a very high footage rate but the water flow must never be allowed to stop since hole stability is dependant upon maintaining a water head above the normal ground water level.

In well completion geotextiles are being used to produce screens which in some cases eliminate the need for the use of a gravel pack. The geotextile in the form of a stocking is pulled over a pvc or similar pipe with holes or slots. The geotextile consists of a sandwich of two outer coarse protective layers surrounding the fine filter fabric. A range of mesh sizes are available for the filter fabric to suit most sand aquifer gradings.

Geophysical logging equipment is becoming less expensive and the sondes smaller in diameter. This enables many boreholes to be logged using a caliper, resistivity, self potential, gamma and water conductivity and temperature probes. The equipment is often man portable so even the most remote sites can be logged. Borehole television cameras are also smaller and frequently produce colour images. A television survey is almost essential when contemplating borehole rehabilitation since the tape produced allows concentrated study of the lining and screen as well as any corrosion or incrustation products.



# PHOTOVOLTAIC ENERGY — FROM OUTER SPACE TO PLANET EARTH

by  
Poul Erik Mortensen and Keld Madsen, Both  
of Grundfos International

Originally designed as a highly sophisticated energy source for satellites, photovoltaic (PV) solar modules have since proven to offer important potential for solving basic needs in the rural environment of developing countries.

The first earth-bound applications to benefit from this new and inexhaustible energy were telecommunication and signalling systems in remote areas. Then, of course, the big consumer hit — the solar driven pocket calculators.

Recently, however, more and more attention have been directed toward the opportunities that such free and reliable energy represent in relation to reliable inter alia cooling/freezing of vaccines and to water pumping, two fields that play an instrumental role in rural health and development schemes in Third World countries.

In 1988, the world production of crystalline modules reached some 20Mwp (Mega watt peak) with an approximate application split, as follows: 30% for commercial and industrial (remote) applications; 20% for the consumer market and special projects; 50% for Third World application (mainly within aid programmes) — including electrification, communication, cooling, and water pumping.

The current trend implies that the latter category has got the highest growth potential, with water pumping as perhaps the most promising application.

## PV SOLAR PUMPING SYSTEMS

The introduction of photovoltaic solar driven pumping systems (in short, PV pumping systems) goes back only some twenty years to when the first pilot units were used as promotional gifts to governments in Africa and other areas.

Unfortunately, most of these first generation systems were truly experimental in both a manufacturing and an application sense, resulting in frequent or even permanent breakdowns and non-fulfilment of recipient expectations.

Looking back, it is easy to establish that this move was in fact premature and may well have retarded the acceptance and breakthrough of subsequent generations by a good number of years. In fact, many potential users of PV pumping systems still today refer to the poor start made by the technology when expressing general scepticism about the suitability of such systems.

The combined UNDP/World Bank initiative at the end of the 1970s and beginning of the 1980s to mount a global laboratory and field test programmes of PV

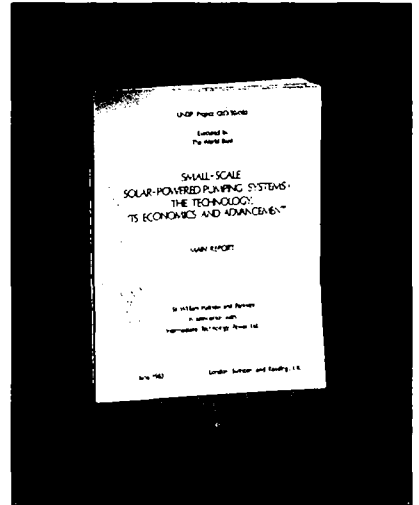

*The World Bank UNDP Project GLO/90/003 includes comparative test results and evaluations of 12 selected and prequalified PV pumping systems.*

pumping systems offered the key to remedy the somewhat tarnished reputation of such systems. Through in-depth monitoring in a controlled and highly accepted forum it would be possible to assess the real potential of PV pumping systems.

Of more than 25 companies applying for prequalification, twelve manufacturers and system suppliers finally were selected. The conclusion of this global test suggested that a handful of companies did in fact possess systems which already were, or with a few minor modifications could become, an interesting option in the general context of solving rural water supply problems in developing countries.

In the intervening years these companies have supplied what is believed to be some 2,000 systems for pumping underground water. Systems which have mainly been delivered on an individual basis or as

## GROUNDWATER – PHOTOVOLTAIC ENERGY

packages of 2-5 systems for pilot schemes and almost exclusively financed by NGOs and PVOs or by private users (e.g. farmers), organisations and people who could well be characterised as the true pioneers in the utilization of PV for water pumping.

During this period many governments and aid agencies (both bi-lateral and multi-lateral) voiced some interest but at the same time expressed concern about the feasibility and viability of such systems as compared to the more traditional pumping systems available.

### NO LONGER JUST EXPERIMENTAL

As shown by successful national programmes in, for example Mali, Morocco and Kenya, PV pumping systems have, however, been accepted not only as a plausible alternative but indeed as an attractive option in the palette of rural water supply systems.

The positive experience has had a sort of snowball effect, and today many official bi-lateral aid agencies such as the Canadian CIDA, the Danish DANDIDA, and the West German GTZ/KfW have incorporated PV pumping systems in their projects. Examples of international donor organisations employing PV pumping systems are the two United Nations agencies Unicef and UNHCR (High Commission for Refugees), who both have used this method to ensure a basic water supply in remote rural areas.

And very importantly, the systems are no longer being used purely as demonstration or test units. This is best proved through a recent launch of a very big regional PV water pumping project by the European Development Fund in Brussels. A project which when fully implemented (probably by 1993/94) will involve more than 1,300 such pumping systems in nine different countries in the Sahel region in Africa.

But there are also many examples of PV pumping breakthroughs outside the African continent. One of these is Jordan.

### CASE STORY: JORDAN

The annual daily average of solar radiation on a horizontal plane in Jordan is 5.5 kWh/m<sup>2</sup>/day. The average of solar radiation intensity during the winter season is about 3 kWh/m<sup>2</sup>/day and exceeds 6 kWh/m<sup>2</sup>/day during the remainder of the year.

Of a population of 2.3 million as little as three percent occupy as much as 41% of the 92,000 km<sup>2</sup> territory of Jordan.

The population and animals (mainly camels) in these rural and desert areas without any power grid obtain their water from wells with diesel-driven pumps. This pumping method involves high running costs (fuel, labour and lubrication), maintenance problems and pollution. In Jordan only some 70% of all diesel-driven pumps are operating at any given time. Furthermore, most of the diesel engines have four or six cylinders with HP-outputs of 40-90 which — designed for peak performance — represent several times the necessary output required for normal water requirements, which again results in poor efficiency and relatively high pumping costs.

In 1985 it was decided to try PV pumping systems as an alternative to diesel, and, backed by West German

funding, the Jordan Water Authority and the Royal Scientific Society (RSS) of Jordan selected eight sites for test units.

One of the first sites was Al-Umari, 50 km from Azraq and 5 km from the Saudi border.

Until that moment, the Al-Umari well had been operated by means of diesel-driven pumps which by tradition had a relatively short life (2 to 5 years) and required frequent maintenance.

In the three years that have passed since installation of the PV pumping system at Al-Umari, there has been no interruption of the water supply. As a result of this, the number of daily users of this well has risen from some 300 people during peak season in 1985 to almost 2,000 (plus numerous camels) during peak season of 1988.

The installation has become known as a reliable all-year-round water source, and people come up from 70 -80 km away to collect water.

The fact that there has been no break-down in supply has significantly relieved the burden of the National Water Authority who is responsible for maintenance and who, when diesel engines were in use, had to allocate funds not only for maintenance but also for daily operation of the systems (for fuel, lubrication and new batteries).

In many other countries the authorities would quite naturally turn to the daily users of the system to cover such costs, but in Jordan and most Arabic countries beduins are by law granted the free use of water resources.

Consequently, the only private contribution to cost recovery at the Al-Umari installation comes from a nearby forwarding and clearing agency with 60 employees paying some 10 Piastre (approximately \$0.22 US) per cubic metre of water, which is obviously not enough to cover operating expenses.

Although a PV pumping unit needs no permanent pump attendant, it was decided to keep the previous diesel pump watchman at the installation for the mere sake of ensuring a fair distribution of the water and to avoid people from using tankers to collect water.

Though installed at a later date, the remaining five PV test units show the same promising results and the Royal Scientific Society concludes that:

(a) The reliability and suitability of PV systems are much higher than that of diesel systems, especially in those areas where the annual average of solar radiation exceeds 4.5 kWh/m<sup>2</sup>/day.

(b) For Jordan and countries with similar conditions, an economic study showed that up to a hydraulic equivalent of 5.950 m<sup>4</sup>/day (corresponding to 70 m head and 85 m<sup>3</sup>/day), the water pumped by the PV system is less costly than that of diesel systems (see following page).

Based on the successful PV tests, Jordan was just recently donated another 15 systems by the German Ministry for Research and Technology (BMFT), systems which are to be installed during 1989 and 1990.

Also, the Royal Energy Centre of the RSS is today sharing its experience with PV systems with Iraq and Egypt, countries which are also about to launch their own test programmes.

# GROUNDWATER – PHOTOVOLTAIC ENERGY

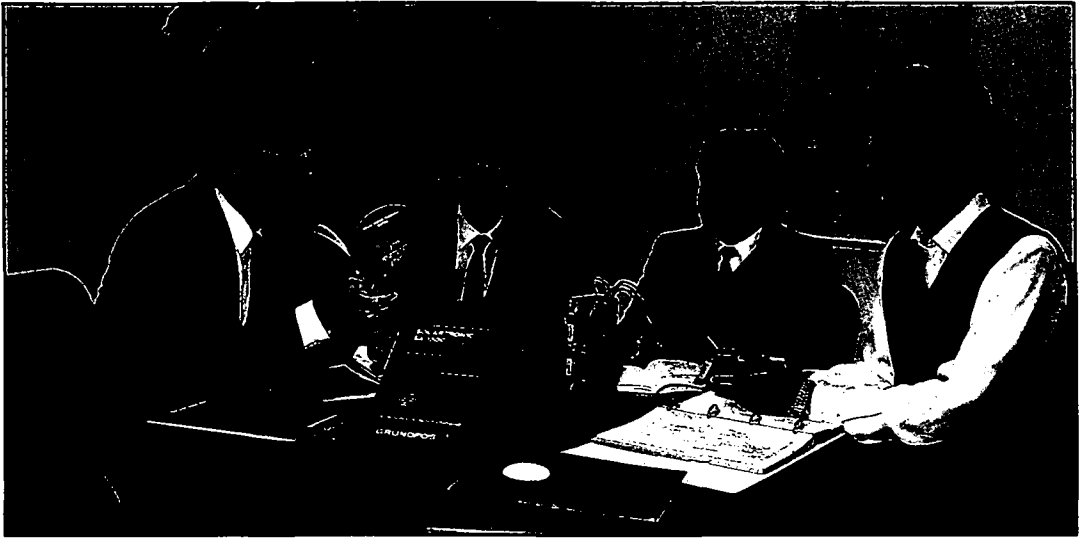

*Dr.Sc.Tech. Marwan Mahmoud, Solar Energy Research Centre at the Royal Scientific Society, Jordan, discussing PV pumping with the contributors and PV engineer H. Amdisen, Grundfos Int. A/S, Denmark.*

## ELIGIBILITY OF PV PUMPING SYSTEMS

It is very important to stress that VP pumping systems are not the solution to all rural water supply pumping problems.

To begin with, physical and climatic conditions are of utmost importance. As a rule of thumb, the average monthly radiation concerned should be no less than 4 kWh/m<sup>2</sup>/day. If radiation value is below this limit, the costs of water pumped tend to be high in comparison with other pumping methods.

Nevertheless, there are several examples of PV being the only feasible energy source even in remote areas with radiation values below the 4 kWh/m<sup>2</sup>/day. One of the reasons for this may be the lack or total

area to be served. In schemes of, say, 300 to 2,000 daily users (plus possible livestock) within a confined area, the combination of output required and savings related to actual drilling costs (one PV pumping installation may equal ten handpump installations) may out even manual driven pumping systems, which may be the case also where pumping depths exceed the performance limit of manual systems. At present PV systems are capable of supplying water from depths of more than 100 metres.

Obviously, the feasibility of PV pumping systems against other pumping methods has to be assessed on an ad hoc and life-cycle cost basis. However, studies performed by professional organisations such as the Scandia National Laboratories (Mexico), the Meridian Corporation (USA), IT Power (UK), and Norconsult (Norway), are much in line with the Jordanian observations and certify that a mix of actual field conditions often make PV pumping systems the most satisfactory solution, a picture which is becoming increasingly true as PV module costs continue to drop.

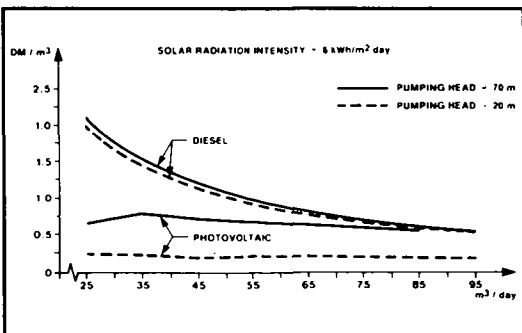

*The figure shows specific water costs of PV and diesel powered pumping systems in Jordan.*

*Source: M. Mahmoud, RSS, Jordan and E. Unlig, West Germany.*

absence of national institutional capacity to ensure necessary basic service using more conventional types of pumping systems.

Other parameters which may speak in favour of utilizing PV pumping systems include uncertain availability of fuel and the concentration of population within the

## PROFILE OF CONTRIBUTORS:

### *Poul Erik Mortensen*

*Works with GRUNDFOS International a/s, in Bjerringbro, Denmark, where he is Product Line Manager for Solar Pumping Systems and Hand Pumps. He has been engaged in photovoltaic pumping activities since the beginning of the 1980s with much of his time spend under field conditions.*

### *Keld Fensten Madsen*

*Works with GRUNDFOS International a/s, in Bjerringbro, Denmark, where he is Regional Marketing Manager — Overseas Region, and Liaison Manager, responsible for group relations with international aid and development financing institutions.*

# Manufacturers of wellscreens

Our company was founded in the 1880's starting off as a waterwell drilling company. Drilling still forms part of our activity. Gradually we moved into the manufacture of screens (timber) and accessories and became a supplier of drilling materials. Seeing the trend towards the use of plastics in many industries and the advantages such as corrosion resistance, light weight for easy handling and cost against other materials, we took the decision in 1955 to manufacture PVC well screens and casing. From small beginnings, a modern



factory has been built. Based on our experience as to the needs of the drilling industry and that of 30 years of manufacture, we now have our own PVC blending plant, pipe extrusion units, automated cutting, slotting and threading machinery. Additional ultra modern computerised equipment is currently being installed to cut costs further to cater for the needs of export markets. Export now constitutes already almost 30% of annual output. Screen and casing diameters range from 35 to 400 mm (1.1/4" to 16") in standard and thick-walled series with plain or ribbed surfaces and gravel pre-packs. Manufacture is strictly to DIN 4925 standards, others are possible. Our total inhouse manufacturing capacity ensures high quality, absolute quality control and, above all, greater flexibility.



STUWA

Konrad Stükerjürgen KG, Hemmersweg 80, D-4835 Rietberg 2, West-Germany,  
Phone: 00 49/52 47/22 70 Telex: 938 561 stue d

# pumpenboese

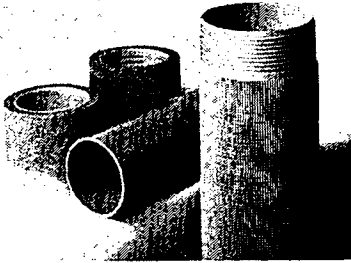

## pb Well Screens

pumpenboese — a well-known and leading West German manufacturer of products for water well construction — produces a comprehensive range of well screens and casings:

- UPVC well screens and casings 1 1/4" - 16" dia. in plain pipe quality
- UPVC well screens and casings 1 1/2" - 8" dia. in ribbed pipe quality
- UPVC well screens and casings according to new German Standard DIN 4925/1-111, 1 1/2" - 16" dia.
- CPVC well screens and casings for high ground pressures and high temperatures (chlorinated polyvinyl chloride), 1 1/4" - 16" dia. in light green colour
- UPVC gravel packed well screens 1 1/4" - 16" dia. in different granulations of pure quartz gravel
- UPVC dewatering well screens and casings for shallow wells up to 20 meters of depth in dia. from 6" - 16"
- UPVC drive well points 1 1/2" and 2" dia. of high impact strength
- bridge slotted well screens of low carbon steel and galvanised quality in dia. from 6" - 16"
- steel drive well points in dia. of 1 1/4", 1 1/2" and 2", galvanised, with meshes and protective brass coat
- pb Double Wall Screen  
This is a new type of well screen and the innovative construction represents a large advantage in both well design and economy

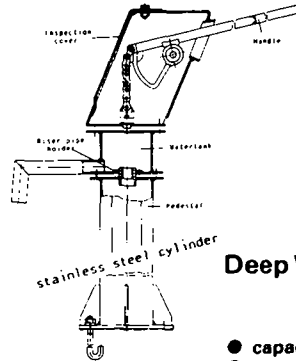

## Deep Well Handpump

- capacity up to 1200 l/h
- operable up to a level of 55m
- suitable for boreholes of 3 inch
- pump fully galvanised
- pb-riser pipes made of stainless steel
- deep well cylinder pb 2.5 made of stainless steel
- flange or tripod execution
- easy to install
- easy to operate and maintain
- delivery ex stock
- very competitive prices
- excellent proven quality
- made in Germany

# pb



- Submersible pumps with a capacity up to 800 m<sup>3</sup>/h and a pump head of 300m.  
4" and 6" pumps are made of stainless steel and noryl.  
8" and 14" pumps are made of gray cast iron or bronze.
- Deep well turbine pumps with a capacity up to 2000m<sup>3</sup>/h and a pump head of 200m.  
These pumps are made of gray cast or bronze. They are driven either by a diesel engine or by an electric motor.
- Centrifugal pumps with a capacity up to 80m<sup>3</sup>/h and a pump head of 230m.  
These pumps are made of gray cast iron and stainless steel respectively bronze and stainless steel.
- Pressure systems with a capacity up to 80m<sup>3</sup>/m and a pump head of 230m.  
These systems will be constructed according to the requirements of the customer and the special requirements of the projects.
- Horizontal norm pumps with a capacity up to 500m<sup>3</sup>/h and a pump head of 100m, either driven by a diesel-engine or an electric motor.  
These pumps are made of gray cast iron or bronze.

*Special pump executions can be supplied on request.*

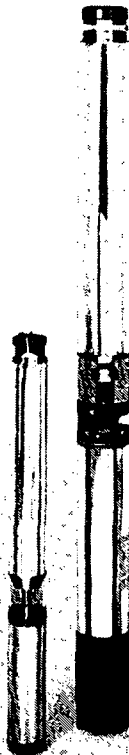
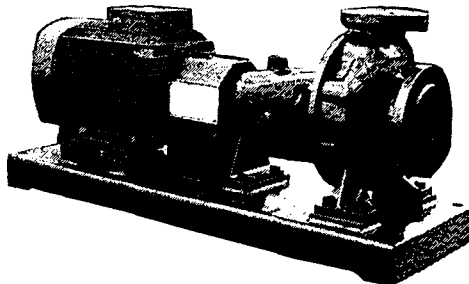

Telefax: 5 13 985-92

pumpenboese kg · Raiffeisenstraße 2 · D-3006 Burgwedel 1

Tel: 051 39/80 88-0 · Telex 17 51398590, 91, -92-93 · P.O. BOX 1250 · Federal Republic of Germany



## Remote Sensing and Site Investigation

**ADVANCED ENERGY TECHNOLOGY-GEOTRONICS** 10317 McKalla Place Austin Texas 78758 USA Tel: +1-512-837-7564, Telex: 910-874-1373, Contact: Mr Cheevers. Manufacturers of controlled source audio magnetotellurics (CSAMT).

**AEW-PLAN-GmbH** P O Box 30 01 06 Graeffstrasse 5 K ln D-5000 West Germany Tel: +49-221-5740-22-0, Telex: 8-885-295, Fax: +49-221-5740-211, Contact: Mr Gerard Van Wissen. Hydrological and hydrogeological investigations, groundwater modelling, water management planning and hydraulic engineering. Feasibility studies, design, construction supervision and management for water supply and waste water disposal systems.

**AGRAR UND HYDROTECHNIK GmbH** PO Box 10 01 32, Huyssenallee 66-68 Essen 1 D-4300 West Germany Tel: +49-201-2016-0, Telex: 857 557 aht d, Fax: +49-201-2016-211, Contact: Mr Gerard Van Wissen. Hydrological and hydrogeological investigations, groundwater modelling, water management planning, hydraulic engineering. Feasibility studies, design, construction supervision and management for water supply, waste water disposal, irrigation and drainage.

**ALTA GEOPHYSICS** P O Box 363, Univeristy of Birmingham Birmingham B15 2TT UK Tel: +44-21-414-6141, Telex: 338938, Fax: +44-21-414-3952, Contact: Geoff Marsden. Specialists in high quality geophysical investigation for water engineering, extractive minerals and petroleum industries. ALTA has considerable experience in the UK conducting surveys for most water authorities. Work has also been carried out in Europe, Middle East, Africa and Indonesia.

**CONDRILL AB** Sveavagen 83 113 50 Stockholm Sweden Tel: +468349560, Telex: +12336, Fax: +468316762

**FRASTE S.p.A** Zona Industriale, 37054, Nogara, Verona, Italy Tel: +39-44-288300, Telex: +481872, Fax: +39-44-288426. FRASTE S.p.A. produces a complete range of hydraulic machines for soil investigation. All models are suitable for coring, sampling, engineering as well as for direct mud flushing, air/foam circulation and down hole hammer. A new line of modular machines has recently been developed for remote operation from the power pack, help-service and special interventions. Standard mounting on crawler, trailer and skid.

**NEOTRONICS LTD** Parsonage Rd, Takeley Bishops Stortford Herts CM22 6PU UK Tel: +44-279-870182, Telex: 817126, Fax: +44-279-870377, Contact: Caren Frost. For confined space entry and continuous monitoring of

# FIVE ACES

## For Water Exploration

Holding five aces puts you in a class apart—a pat hand.

Ground water occurs in fractured rock, in porous rock and in alluvial formations—sometimes shallow and sometimes very deep.

Successful water explorers must have a broad range of geophysical methods at their fingertips—broad enough to master whatever geological conditions they encounter.

ABEM is a leading supplier of ground water exploration equipment.

ABEM's comprehensive line of instruments ensures excellent coverage. Fieldworthy, easy-to-use, top-quality instruments for VLF, EM, resistivity, seismic and magnetic surveys—plus interpretation software.

You too can hold a pat hand. Find out how!

*Fill in the coupon today and mail:*

<b>TO ABEM AB, P.O. Box 20086, S-161 02 Bromma, Sweden</b>	
YES! I'm interested in ABEM's line of water exploration instruments. Send more information about:	
<input type="checkbox"/> WADI VLF	Name _____
<input type="checkbox"/> EMAC Slingram	Company _____
<input type="checkbox"/> GEM magnetometers	Address _____
<input type="checkbox"/> Terrameter SAS 300 B	_____
<input type="checkbox"/> Terraloc seismograph	Telephone _____
	Telex: _____ Fax: _____



**ABEM AB**

Postal address	Street address	Telephone	Telex
Box 20086	Hammgatan 27	08-764 60 60	13079
S-161 02 Bromma	Sundbyberg	Telex	ABEM S
Sweden	Sweden	08-28 11 09	

asphyxiants, toxic and flammable gases. Neotronics compact EXOTOX multi-gas and NEOTOX pocket-size personal monitors offer protection against the hazardous environments encountered in the water industry. Extensive intrinsic safety approvals apply.

**R-V ASSOCIATES** 281 Main St Falmouth MA 02540 USA Tel: +1-617-540-0561, Telex: , Fax: +1-617-540-7719, Contact: Warren Witman. We manufacture ground water flow meters which give the rate and direction of ground water flow and this data is important to define the optimum zones of contribution for installing water wells.

**ROBERTSON GEOLOGGING LTD** Deganwy Conwy Gwynedd LL31 9PX UK Tel: +44-492-82323, Telex: 617171, Fax: +44-492-82322 Robertson Geologging Ltd is a major British designer, manufacturer and service operator of slim-hole digital geophysical borehole logging equipment for the world's coal, mineral and water industries.

**SOIL MECHANICS LTD** Glossop House, Hogwood Lane, Finchampstead Wokingham RG11 4QW U K Tel: +44-734-328888, Telex: 847253, Fax: +44-734-328383, Contact: Mr Craig. Site investigation, hydrogeology, hydrography and oceanography, land and marine geophysics, foundation engineering and geotechnics.

**WUIDART ENGINEERING** Ivel Rd Shefford Beds ST17 5JU UK Tel: +44-462-811812, Telex: 825480, Fax: +44-462-814191, Contact: Roy Wilkes. Borehole logging and sampling.

### Geophysical Equipment

**ABEM A B P O** Box 20086 Bromma S-16102 Sweden Tel: +46-8-767-60-60, Telex: 13079, Fax: +46-8-28-11-09. ABEM instruments are being used world wide to find suitable well locations, to determine the depth to water and measure its salinity. The Terrameter does water prospecting by the resistivity method, and SASLOG 200 is a low cost complement for well logging purposes. ABEM Wadi is a light weight instrument for water exploration based on the VLF principle. Other instruments from ABEM for water includes Terraloc seismographs and EMAC Slingrams.

**ATLAS COPCO ENERGY AB** S-105 23 Stockholm Sweden Tel: +46-8-743-80-00, Telex: 14090 copco s, Fax: +46-8-716-59-75. Atlas Copco Energy has specialized equipment for seismic investigations and resistivity or electro-magnetic surveys. The equipment is easy to learn and to use and has proved to be a vital tool for selecting the best possible sites for water wells.

**BORETECH DIVISION OF CCV** 5748 E Shields Avenue Fresno CA 93727 USA Tel: +1-209-291-0383, Fax: +1-209-291-0463, Contact: C M Salisbury. Manufacturer of downhole CCD TV cameras for vertical and horizontal shafts. (ie, water wells and sewer pipes).

**DIAMANT BOART CRAELIUS NV** Avenue du Pont de Luttre 74 Brussels 1190 Belgium Tel: +32-2-348-3211, Telex: 21266, Fax: +32-2-348-3609, Contact: Michael

Leroy. Manufacturers and suppliers of Diamond Drilling and Multipurpose Rotary rigs and all associated in the hole tools, including Diamond Products. Concrete drills and saws, grouting and guniting equipment, geophysical and borehole instrumentation.

**DRILL-AID LTD** Drill-Aid House, Galley Hill Trading Estate Swanscombe Kent DA10 0LQ UK Tel: +44-322-846-823, Telex: 297114, Fax: +44-322-846-923, Contact: Mr Higgins. Manufacturers and suppliers of drilling fluids, in particular drilling foams and synthetic polymers. Also consultants to the drilling industry world-wide.

**EOTVOS L. GEOPHYSICAL INSTITUTE OF HUNGARY (ELGI)** POB 35, Budapest H-1440 Hungary, Tel: +36-1-635010, Telex: +226194, Director: Dr. Pal Muller. ELGI H. ELGI is a pioneer in all branches of applied geophysics. The Institute deals with relevant areas such as research and development in methodology and instrument design and data processing. More than 25 percent of its staff of approximately 900 are include geophysicists, geologists, electronic engineers and computer experts. ELGI's is actively involved in prospecting for ground water, coal, bauxite and other hard materials. Environmental protection and engineering geophysics are among their other varied and extensive projects. ELGI also produces portable seismographs, resistivity and induced polarization instruments, electromagnetic systems and complete well logging stations.

**FRASTE S.p.A** Zona Industriale, 37054, Nogara, Verona, Italy Tel: +39-44-288300, Telex: +481872, Fax: +39-44-288426. FRASTE S.p.A. produces a complete range of hydraulic machines for soil investigation. All models are suitable for coring, sampling, engineering as well as for direct mud flushing, air/foam circulation and down hole hammer. A new line of modular machines has recently been developed for remote operation from the power pack, help-service and special interventions. Standard mounting on crawler, trailer and skid.

**GISCO - GEOPHYSICAL INSTRUMENT & SUPPLY** 4665 Joliet St Denver CO 80239 USA Tel: +1-303-371-1940, Telex: +45769, Contact: H W Siegel. Gisco offers a complete line of geophysical equipment and instrumentation including magnetometers, electromagnetic, magnetotelluric, gravity meters, resistivity, induced polarization systems, seismographs, borehole logging units, spectrometers, hydrological field and lab test equipment. Write for detailed 190 page catalog.

**GROUNDWATER TECHNOLOGY/OIL RECOVERY SYSTEMS INC** 1420 Providence Highway Norwood MA 02062 USA Tel: +1-617-769-7600. Groundwater clean-up, services and equipment.

**INTERNATIONAL DRILLING SERVICES LTD** Cliff House, 61 Sheffield Rd, Dronfield Sheffield SH18 6CF UK Tel: +44-246-411111, Telex: 547622, Fax: +44-246-410097, Contact: Mr Bacon. IDS manufacture a wide range of down hole drilling equipment and associated drilling fluid chemicals.

**SLOPE INDICATOR CO LTD** Southerham House,

# WELL DEVELOPMENT IS CRITICAL

by R. L. Schreurs

Groundwater is the largest source of fresh water in storage on our planet. In arid and semi-arid regions, construction of efficient water wells is fundamental to any program of social and economic progress. Fractures or solution openings in consolidated aquifers provide pathways for groundwater flow, whereas water flows through the interstitial openings (pores) of unconsolidated aquifers such as sand and gravel.

In order to support the loose sand and gravel, it is necessary to use some type of well screen. The correct well screen should be installed to insure maximum quantity of water, free of sand. Its function is so important that the well screen is sometimes called the heart of the well.

Well development may be defined as any process used to increase the water transmitting capacity of the aquifer and eliminate the damaging effects of drilling procedures. It is accomplished by removing the fine material through the well screen openings. These fines consist of any clay or silt introduced during the drilling process, as well as the finer part of the aquifer directly around the well screen.

In a naturally developed well, a hydraulically graded filter is produced in the sand and gravel around the screen. The coarsest, most uniform material is next to the screen; the finer, less uniform material at some distance outside the screen. Such a filter has a high capacity for transmitting water, while effectively restraining any movement of the sand particles once the development process is completed.

Sometimes it is advantageous to drill a larger bore hole and graded coarse sand or fine gravel is placed around the well screen. So as to have an efficient well, filter pack wells must be developed to repair the damage done to the aquifer by the drilling procedures.

Figure 1. Effective development action requires movement of water in both directions through screen openings. Reversing flow helps break down bridging of particles. Movement in only one direction, as when pumping from the well, does not produce the proper development effect.

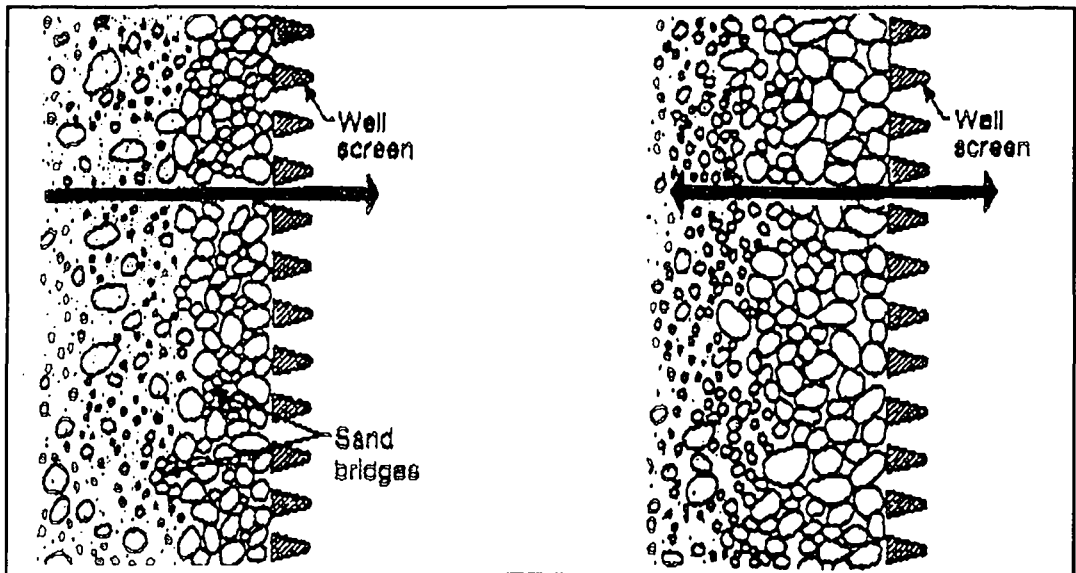

## GROUNDWATER

Well development brings about increased capacity, stabilization of the aquifer to prevent sand pumping, and increased service life for the well. Space does not permit a detailed explanation of the methods used by well drillers to produce the desired results, but the methods are all based on establishing velocities of flow greater than those produced by the expected rate of pumping from the completed well, and combining this with vigorous reversal of flow, or surging, to prevent sand grains from bridging against each other. (Fig. 1)

A question that normally arises at this point concerns the reasons why the screen openings do not become clogged with the sand grains during development. Unless the openings of a screen are specially designed, they will clog badly during the development process and greatly limit the effectiveness of the screen. A sand grain cannot plug off a continuous slot because it can make contact only at two points, but it can lodge solidly in a round or square opening.

It is important that the slot openings widen abruptly toward the inside of the screen, because sand grains that pass the V-shaped slot will enter the screen without clogging and be removed during the development procedure; whereas sand grains are apt to become jammed in square wire mesh or round drilled holes and clog the openings.

Another matter of great importance in the design of the well screen is the number, size, and distribution of the screen openings. Obviously, there must be sufficient total area of intake opening so that the velocity of the water as it enters the well screen will be low enough to avoid head losses that reduce the yield of the well. There are claims and counter claims about the required or desired per cent of open area. Common sense tells us the best well screen is none at all.

An ideal well in sand and gravel would be an open hole that would not collapse. The next best would be a screening device that had as much as or more open area than the porosity of the aquifer. Thus the ideal well screen installed in sand and gravel would have 25 to 40 per cent open area.

If a screen manufacturer does not list the amount of open area for various screen, it can be calculated. If slotted pipe is covered by one or more layers of mesh, each layer reduces the effective open area of

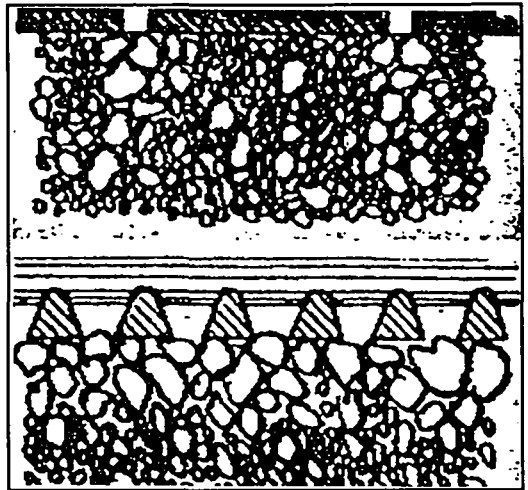

Figure 2 Only isolated developed packets result outside perforated pipe. continuous envelope can be developed around V-slot well screen.

the layers it covers. Assuming a coarse outer layer has 50 per cent open area and the pipe base has 20 per cent open area, the resulting effective open area is  $0.50 \times 0.40 \times 0.50 \times 0.20$  or only 2 per cent.

The open area must be properly distributed in order for all portions of the aquifer around the screen to be effectively developed. A slotted pipe with blank areas between the slots cannot produce uniform development, but a screen with closely pitched, continuous V-slot can facilitate uniform development. (Fig. 2) The screen slot openings must provide a direct, horizontal course for the surging action of the water during the development procedure, and there must be complete exposure of the aquifer around the well screen. These are essential to permit effective development and are cardinal principles in well screen construction.

*Driscoll, Fletcher, Groundwater and Wells, 2nd Edition, 1988*

*R. L. Schreurs is a professional geologist who worked 9 years for the U.S. Geological Survey and 32 years for Johnson Filtration Systems, St Paul, Minnesota, 4 years of which were in England. He has lectured on groundwater development at several universities and is a consultant on design of production, recharge, and dewatering wells and gas production and storage wells. His work has resulted in extensive travel in North and South America, Europe, Africa, and Asia.*



# EÖTVÖS L. GEOPHYSICAL INSTITUTE OF HUNGARY

THE OLDEST INSTITUTION FOR APPLIED GEOPHYSICS  
OFFERS THE LATEST ACHIEVEMENTS FOR  
GROUND-WATER PROSPECTING  
and  
ENVIRONMENTAL PROTECTION

The most often occurring demands:

- local geophysical measurements for the water supply of small communities by a few wells
- regional geophysical mapping to determine hydrological conditions for irrigation, regional agricultural development,
- large-scale exploration for the water supply of towns, extended areas i.e. regional waterworks,
- determination of bank storage of river terraces, planning of bank filtered well systems,
- ▣ thermal water exploration for use as an energy source, agricultural use or community utilization,
- ▣ cold and warm karst water prospecting,
- ▣ water engineering problems, water construction works



*The Maxi-Probe electromagnetic sounding and mapping system – produced under licence by Geoprobe Ltd. Canada – is an ideal tool for shallow depths, especially in areas where seismic results are poor or unobtainable*

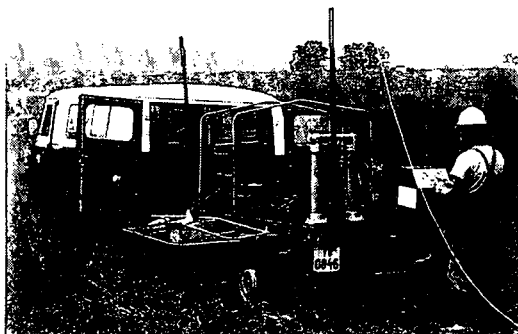

*ELGI has a vast experience in solving problems of environmental protection such as control of surface waters, reservoir construction, industrial and communal waste disposal, protection of surface and ground water, etc. ELGI's penetrolgger provides in-situ information – up to a maximum depth of 30 m - on the strength, sand/shale ratio and density without costly drilling.*



*Field work with ELGI's 24-channel portable seismograph*

**ELGI offers contracts with co-operating partners to participate in the whole complex process of exploration–drilling–production.**

**For further information ask for our booklets on instruments and applications. Let us know your problem and we will select the appropriate method and the best instrument for your purpose.**

*Our address: ELGI POB 35. Budapest,  
H-1440. HUNGARY  
Telex: 22-6194 elgi h*

Southerham Lewes East Sussex BN8 6JN UK Tel: +44-273-474475, Telex: , Fax: +44-273-474479, Contact: Mr Scott. Slope Indicator Co is the world's largest manufacturer of instrumentation for civil engineering works. The product range includes geotechnical, geophysical and structural monitoring systems.

**STROJEXPORT FTC** Commercial Group 69 Vaclavske nam 56 Prague 1 Czechoslovakia Tel: +42-2131, Telex: 122-604, Fax: +42-2269569. The export of geological drilling services by Strojexport, Foreign Trade Corporation, is carried out by five research institutes and nine enterprises with over 120,000 specialists in the following fields: basic geological survey, prospecting for ore deposits, prospecting for coal, crude oil and natural gas deposits, prospecting for non-metallic deposits, engineering-geology survey, hydrogeology applied geophysics, geochemical prospecting, laboratory methods and technological research.

**TERRONICS LIMITED** Willingham Rd Market Rasen Lincolnshire LN8 3DX UK Tel: +44-673-843000, Fax: +44-673-843038, Contact: T S Langdale-Smith. Specialist supplier of instruments for ground geophysical exploration. Advice on instruments and their application (including training). Sale and hire of systems. Data processing and report production. Complete support allows our clients to get on with their job acquiring geophysical data.

**THE DRILL SURE GROUP** Froebel House, 21 Church St Warwick CV34 4AB UK Tel: +44-926-496126, Telex: 311796 Drilsu G, Fax: +44-926-490001, Contact: Mr Slack. Thermoplastic borehole lining systems, PVC casing and screen systems, stainless steel range of well screens, drilling foam, biodegradable polymer and organic polymer.

### Casings and Screens

**AL-SAHL TRADING CO** PO Box 15261 Al-Ain Abu Dhabi United Arab Emirates Tel: +971-3-643121, Telex: 33543, Fax: +971-3-66153, Contact: Samir Moh'd. A leading trading company in the UAE undertaking water well drilling and dealing in chemicals for water well drilling, casings, screens and pipes etc.

**ATLANTIC SCREEN INC** 118 Broadkill Rd Milton Delaware 19968 USA Tel: +1-302-684-3197, Fax: +1-302-684-0643, Contact: Mr Lawson. Atlantic Screen handles and manufactures a complete line for monitoring well installations and have created a screen suitable for underground storage tanks called The Tank Inspector. It comes in lengths and sizes according to Tank Diameters. Other accessories are available to accommodate the Tank Inspector, such as filter wrap, manhole covers, locking caps, centralizers, silica sand and bentonite etc. Bailers made of teflon, PVC, stainless steel and acrylic with stainless steel wire covered with teflon or poly cord round out our line.

**BOODE B V** P O Box 27 AA Zevenhuizen ZH 2760 The Netherlands Tel: +31-1802-2744, Telex: 26642 Boode nl. Water well casing systems. Water well screen systems: standard range vertical slots, B & BR (ribbed) (din 4925)

range horizontal slots, type "2000" continuous slots and BOODEPAC dual wall screen. Wellpoints for dewatering, dewatering equipment, casing/screen accessories, drilling fluids, water well consultancy, pumps and hand pumps.

**BOODE UK LTD** 39 Bute Close, Hinckley, Leicester, LE10 0SJ UK Tel: +44-455-611317, Fax: +44-455-610971. BOODE-World leaders in manufacture of PVC water well casing and well screen systems. Range of products include standard smooth casing and screens, fully ribbed screens, TYPE-2000 continuous slot screens and wellpoints for dewatering projects. In addition, BOODE supply a full range of ancillary equipment relating to water well construction.

**CLAYTON SON & CO LTD** Moor End Works, Hunslet Leeds West Yorkshire LS10 2BH UK Tel: +44-532-705226, Fax: +44-532-760372, Contact: Mr R H Thomson. Welded steel pumps, 450mm diameter and over. All UK standards API-511 (monogram authorized, all coatings). Well casing tubes, surge and contact vessels, floating roof digestors and gas holders.

**CONDRILL AB** Sveavagen 83 113 50 Stockholm Sweden Tel: +468349560, Telex: +12336, Fax: +468316762

**COOK SCREEN DIV** 4848 Franklin Avenue Cincinnati OH 45212 USA Tel: +1-412-247-3400, Telex: TWX 81461-2002, Fax: +1-412-247-3400, Contact: Larry Vesel. Manufacture low carbon steel and stainless steel water well screens from 1" pipe size to 44". The screen is made of wedgwire providing continuous slots and 2-point contact to prevent plugging which provides particle free water.

**COSMOPLAST INDUSTRIAL CO** PO Box 6032 Sharjah United Arab Emirates Tel: +971-6-351264, Telex: 68578, Fax: +971-6-371917, Contact: Mr Grant. Cosmoplast Industrial Co (W. L. L.) is the Middle East's only manufacturer of uPVC well casing and screen, Durawell, in a size range from 1. 1/2" to 14". The company also produces pipes in LDPE and uPVC to most international standards and a range of moulded items.

**DEMCO** Unit 16, Anker Mill, Attleborough Rd Nuneaton Warwickshire CV11 4JJ UK Tel: +44-203-388205, Telex: 311743, Fax: +44-203-370664, Contact: Mr Park. Manufacturers of plastic casings, and screens for water well and borehole applications. Special purpose drilling rigs for collector well schemes. Drilling project management service.

**DRILLQUIP LTD** Hazell Way, off Bermuda Rd Nuneaton Warwickshire CV10 7QG UK Tel: +44-203-348328, Telex: 31390, Fax: +44-203-348329, Contact: Bill Deeming. Manufacturers of water well drilling equipment, also seismic and exploratory PVC casing/screen. Rock bits, hole openers, steel casing, friction welded drill pipe, suts, collars and drag bits.

**EFIMEX sa SITINDUSTRIE GROUP** 8, Rue du 31 Decembre, 1207-Geneva, Switzerland Tel: +41227366610, Telex: +289392 EPST, Fax: +41227366610. EFIMEX is dedicated to oil and water well equipment

# DRILLING EQUIPMENT



## HYDROMETRIC INSTRUMENTS

- Electric contact meters
- Water level indicators
- Water level recorders:
  - Float
  - Bubbler gauge
  - Pressure transducer
- Current meters
- Borehole water samplers
- Solid state memory recorders
- Logging equipment

## WATER WELL SCREENS AND CASINGS

### LOW CARBON, GALVANIZED AND STAINLESS STEEL

- Bridge slotted screen
- Continuous slot screen
- Oblong and round hole screen
- Welded and seamless pipes

#### CONNECTIONS:

Bevelled end socket or threaded joint

#### PERFORATED PLATES

PVC FLUSH THREADED PIPES  
AND SCREENS

## DRILLING SUPPLIES

- Drill rods
- Rock bits:
  - New - Rerun - Retipped
- Down the hole hammers
  - button bits
- Drilling fluids:
  - foam and muds
- Testing equipment:
  - mud balance,
  - marsh funnel kits
- Thread compounds

# GROUPE TUBAFOR

## TUBAFOR

B.P. 96  
59393 WATTRELOS CEDEX  
FRANCE

## TUBAFOR INTERNATIONAL

39, Champs-Élysées - 75008 PARIS  
Tel. (33) 1.42.25.93.42 - Telex 280.888  
Fax: (33) 1.45.63.84.08

## STI FORGE

Z.I. de Quincieux  
69650 ST GERMAIN AU MONT D'OR - FRANCE

## TUBAFOR MAROC

Km 4, route de Casablanca  
RABAT  
MAROC

# Helping to make the desert green

## Durawell PVC Well Casing and Screen

Cosmoplast DURAWELL wellcasing and screen, designed and produced for economical and efficient development of new water wells in the Gulf region, is now available worldwide.

Supplied in sizes from 4 to 14 inch diameter to international standards or in special heavy duty series to reach depths of 1000 feet, DURAWELL is vital in the needs of the developing world.

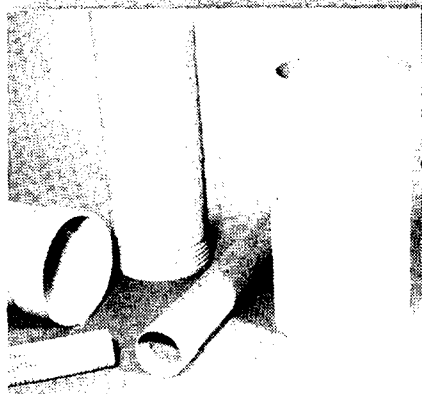
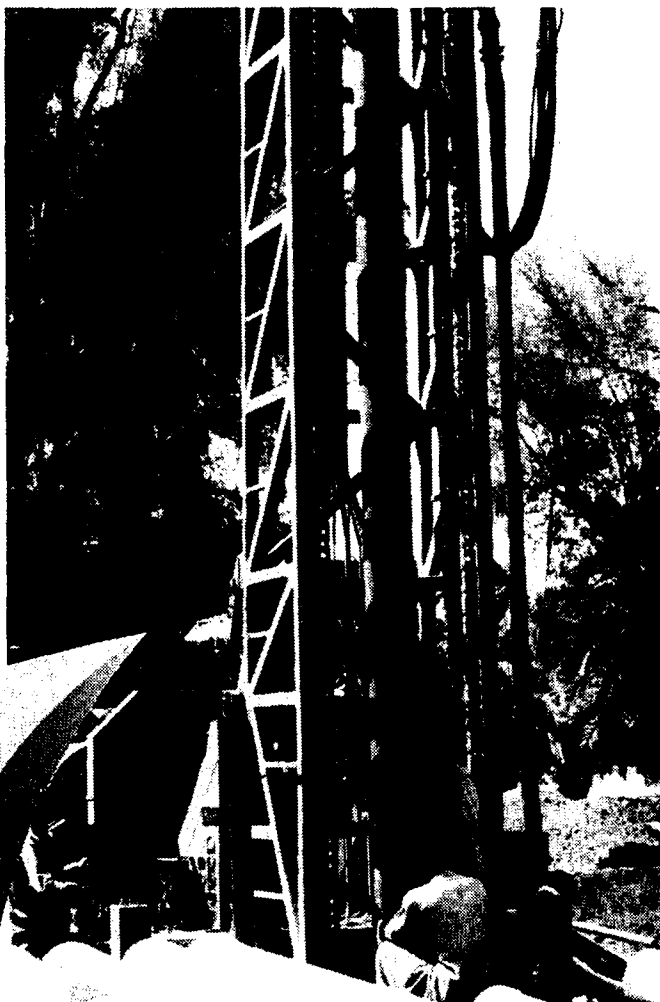

Write to us for  
special detailed catalogues  
on PVC pipe, polyethylene pipe  
& well casing

*We know plastics,  
you know us!*

**COSMOPLAST  
INDUSTRIAL CO. (W.L.L.)**

PO Box 6032, Sharjah, United Arab Emirates  
Telephone: 331264, Telex: 68578 COPOL EM, Telefax: 331917



# EFIMEX SA

**a competitive company  
dedicated to  
oil & water wells equipments**

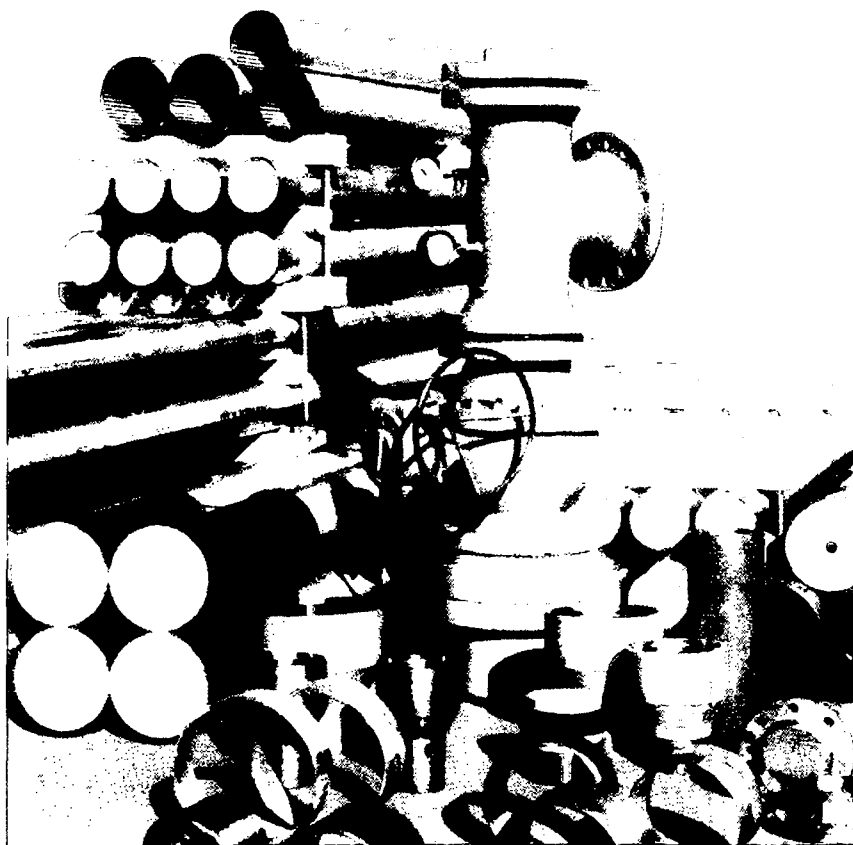

**A LEADER IN MANUFACTURING AND DEVELOPING THE EXTRA RESISTANT PIPE BASE SCREEN ON K 55 or 304 L OR 316 L PIPE BASE.**

**A LEADER IN PIPE THREADING CASING, LINERS, COLUMN PIPES, RISER PIPES FOR PUMPS IN STAINLESS STEEL OR LOW CARBON STEEL WITH API THREADS OR WITH OUR PREMIUM CPNG THREAD FOR STAINLESS STEEL COLUMNS.**

**A COMPETITIVE SOURCE FOR BRIDGE SLOTTED SCREEN IN STAINLESS STEEL, FLANGED PIPES, DRILLING TOOLS & ACCESSORIES.**

**EFIMEX SA**

8, RUE DU 31-DÉCEMBRE - CH 1207 GENÈVE  
TÉLÉPHONE (22) 736 66 10 - TÉLEX 413 489 EFST

## HAGUSTA GMBH

**is specialist for water well equipment, rubber and epoxy linings,  
and special well screens for mining applications.**

The HAGUSTA GMBH was founded in 1936 as a subsidiary of a nationally and internationally leading company specialising in underground construction work, in particular in the field of water well construction. In 1974 Hagusta became independent and since then has been a family-owned company. Independence means flexibility: we can adapt ourselves to our customers' individual requirements, one of the strengths of a medium-sized company with about 90 employees. Hagusta personnel of many years' standing guarantee quality, efficiency, reliability and experience, and our sales engineers will give our customers expert advice. Our facilities and plant conform to the latest technology, therefore our work is workmanlike and conforms to the latest technology including precision handwork manufacture in associated technological fields. Finally, the Hagusta management, which is dynamic in thought and action, guarantees permanent progress coupled with best quality.

Hagusta's own patents and developments such as, for example, hard-rubber-coating, gravel-packed well screens with hot binding, non-swelling agent, Hagusta oil-liner, epoxide resin powder coating with our quality Hagulit, testify to the high standard of engineering knowledge of the personnel of Hagusta.

Hagusta is active in the field of corrosion protection for the chemical and galvanic industry, of power station emission protection, protection of the environment, the tapping of water sources and protection of water treatment plants by linings and coatings of hard and soft rubber, as well as powder coatings on containers, troughs, well screens, pipe connections, valves, fittings and casings.

Especially the Hagusta programme for water well equipment covers the complete range of needs. The delivery programme for well installation material extends from the extension pipe through bottomplate, well heads, installation devices, well screens, adaptors of all kinds, riser and conveyor pipes with connections, packers, sump pipes, lining pipes, casings to the centerings and specially manufactured items.

You can obtain from Hagusta screwed connections in accordance with DIN, API, and to your own requirements, also flanged connections in DIN and in accordance with other existing standards.

The correct choice of the material depends upon the particular requirements. We can supply you with steel pipes with rubber or epoxy coatings, hot galvanized, pipes of stainless steel as well as screens and casings.

Hagusta also rubberizes and coats steel parts supplied by customers. In special engineering applications you can also count on our advice in the solution of your problems: by continuous testing and further development the personnel of our laboratory ensure that our customers receive the optimum corrosion protection for their particular engineering application.

Close collaboration with the large scale industry and notably institutions help us to put technical developments into practice. Our work is based on the nationally and internationally leading governing technical publications.

Since our company was founded, Hagusta has been manufacturing well screens. The electrophoretic rubber coating of well screens was a Hagusta development. The Hagusta well screens, as well as in rubber as in epoxy coating, have proved themselves in innumerable well piping systems, eg the Frankfurt Town Waterworks, Lisbon Waterworks, Zurich Waterworks, Hoechst Chemie, BASF Ludwigshafen, dewatering of the lignit-mine for Rheinbraun Cologne and for the fourth harbour entrance in Wilhelmshaven.

Since 1936, considerably more than 100 thermal and mineral wells, and since very recently more than 35 geothermic wells of up to 1866 metres in depth, have been equipped with rubber-coated Hagusta tubes, and in spite of the highly aggressive nature of the waters all of the sources are in excellent condition.

The use of well screens with a prepacked gravel ensures the delivery of water, free of sand. After evaluation of the sieve analysis of the ground formations of the aquifer, the appropriate grain size for the gravel packing has to be determined. The development of powder-coating of well screens, casings, riser pipes ASO with Hagulit by the whirl sintering process was carried out in conjunction with the firm Hoechst AG. The Hagulit coating has a high resistance to abrasion. The adhesion to steel and iron, as well as the corrosion protection, is excellent. The minimum film thickness is 300  $\mu$ . This is ensured by continuous check measurements during manufacture and guarantees also that the material is free from pores. The Hagulit coating conforms with the KTW — recommendations for drinking water and the EG regulations for mineral waters. Corrosion protection by linings means the lining or jacketing of steel containers, steel pipes and steel items of equipment by the 'tailoring' of foil or panels in a thickness of 1.0 to 6.0 mm, and by powder coating with a film thickness of at least 300 to 800  $\mu$ .

Depending on the technical circumstances and loads associated with the application, hard rubber, soft rubber or plastic foil panels are used for this purpose, these being firmly bonded to the steel components by adhesion systems and/or vulcanization. In the case of powder coating an exceptionally good homogeneity of the coating is achieved by the whirl sintering process. Powder-coating is carried out by various methods, depending on the loading and geometry of the parts.

You see, HAGUSTA GMBH works for water supply and treatment; for HAGUSTA GMBH is your good partner in the field of water supply and treatment, waste water treatment and flue gas desulphurization; plant construction and electroplating.

**MORE THAN 50 YEARS  
OF EXPERIENCE**

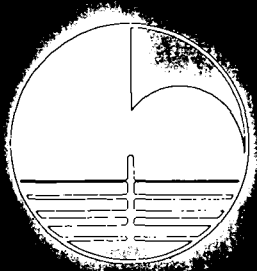

**HAGUSTA**

since 1974 as part of the StIndustrie group it constitutes a major manufacturing source for: - stainless steel longwelded tubulars with threaded connectors - seamless lowcarbon tubulars per api standards, diameter range is 3 1/2" to 9 5/8" - wire wrapped rodbase screens - pipe based screen with carbon or stainless steel pipe base with wrapped on screen jacket - bridge slotted screens in stainless steel.

**HAGUSTA GMBH** P'OB 11 61 Schwarzwaldstrasse 7 Renchen D-7592 West Germany Tel: +49-7843-702-0, Telex: 784313 hagu, Fax: +49-7843-79-24. Founded in 1936 as a manufacturer of rubber lined tubes. Production line covers a wide range of products for water wells: casings and screens, riser pipes as well as gange pipes and well heads with tread - and flange connections acc to all standards, made of stainless or carbon steel, with whirl-sintered epoxy coating HAGULIT.

**HOUSTON WELL SCREEN EUROPE BV** Slachthuiskade 24-26 Almelo CV 7602 The Netherlands Tel: +31-5490-51515, Telex: 30603. Major worldwide manufacturer of profile wire screens for liquid/solid separation in water treatment, water well and general processing sectors. Our product design offers efficient dewatering characteristics, minimum pressure differentials and a strong all-welded construction with precision aperture control from 50 microns to 10mm.

**HOUSTON WELL SCREEN INTERNATIONAL** 61 Sheffield Rd Dronfield Sheffield S18 6GF UK Tel: +44-246-290132, Telex: 547-798 hws, Fax: +44-246-290133, Contact: Mr Phil Cranston. World leaders in the manufacture of wedge wire stainless steel water well screens with factories located in UK, Holland, Singapore and the USA. Incorporating advanced design and technological parameters to ensure quality products at competitive prices.

**HYDROCONSULT** P O Box 1245 Kreuztal D-5910 West Germany Tel: +49-2732-21085, Telex: 875524, Fax: +49-2732-25408. Manufacturers of water well equipment made from steel and special steel qualities according to German and international standards, such as: casings and screens, riser pipes, lowering pipes, well heads, pipe fittings and perforated sheets.

**JOHNSON FILTRATION SYSTEMS** Johnson House, Browells Lane Feltham Middlesex TW13 7EQ UK Tel: +44-1-251-4424, Telex: 935479, Fax: +44-1-890-1533. Johnson Filtration Systems is the new name of Johnson Wellscreens, changed to reflect the broader activities of the company today. Johnson remains the foremost global producer of waterwell screens and well accessories. For eight decades the company has been active in the ground water industry and possess a formidable record of technology and achievement. Call Johnson, no project is too big or too small.

**JOHNSON FILTRATION SYSTEMS INC** PO Box 64118 St Paul MN 55164 USA Tel: +1-612-636-3900, Telex: 297451, Fax: +1-612-636-3132, Contact: Mr E D Broeders. Supply water well screens, environmental monitor screens and water treatment screens.

**KONRAD STÜKERJÜRGEN** Hemmersweg 80 Rietberg 2 D-4835 West Germany Tel: +49-52244-2270,

Telex: 933561. Messrs Konrad StükerjRügen looks back to more than 100 years in the drilling industry. Starting as water well drillers, they became suppliers too, and since 1955 manufacture: PVC casing, PVC screens, PVC dewatering spears and accessories. The modern factory includes its own PVC blending plant, pipe extrusion units, automated cutting, slotting and thread cutting machinery.

**KONRAD STUKERJURGEN KG** Postfach 1210, Hammersweg 80, 4835 Rietberg 2-Varensell Telex: +933561, Fax: +49-5244-2270. PVC wellscreens, casing, and rising mains, STUWA well screens, casings centralizers, and wellheads, all made from high grade PVC.

**LAYNE & BOWLER INC** PO Box 8097 1993 Chelsea Avenue Memphis TN 38108 USA Tel: +1-901-278-3800. Possessing a history that stretches back 93 years, Layne & Bowler is known throughout the world for its expertise in the design, manufacture and installation of vertical turbine pumps up to 30,000 GPM capacity. Products: vertical well pumps, short coupled service pumps, in-line pumps, submersible pumps, volatile liquid pumps and well screen.

**PB PUMPENOESE KG** P O Box 1250 Burgwedel 1 -/ Hannover D-3006 West Germany Tel: +49-5139-80880, Telex: 17-04151398592. PB Pumpenboese KG produce a range of well screens and casings, submersible pumps, handpumps, dewatering equipment as well as hydrometric instruments and auxiliary drilling equipment.

**PUMPENBOESE KG** Raiffeisenstr 2, Postfach 12 50, D-3006 Burgwedel 1 Tel: +05139808847, Fax: +05139808838. UPVC well screens and casings, CPVC well screens and casings for high ground pressures and high temperatures, UPVC gravel packed well screens, submersible pumps to 475 KW power and an output up to 2200m<sup>3</sup>/h, deep well turbine pumps, booster pumps and centrifugal pumps, Irrigation and high pressure systems, Jet pumps and pressure tanks.

**SOVEMA** BP 7151 Lyon Cedex 7 69353 France Tel: +33-78586105, Telex: 300448, Fax: +33-72-73-47-74, Contact: M Collignon. Manufacturer of borehole equipment, screens, casings, drilling tools, piping, tubing, fittings and accessories and pumps.

**SURESCREEN MANUFACTURING CO PTY LTD** 88 Brickyard Rd Geebung Brisbane Queensland 4034 Australia Tel: +61-7-265-5555, Telex: 41215 SMC. Surescreen manufactures welded wedge wire screens in stainless steel, galvanised steel and other metals. The screens are supplied in: cylindrical form as water well screens, filter elements and strainers, flat and curved form as screening surfaces for the separation of solids from liquids, and trommel screens. A complete in house manufacture ensures high quality, fast deliveries and the ability to solve application problems.

**THE DRILL SURE GROUP** Froebel House, 21 Church St Warwick CV34 4AB UK Tel: +44-926-496126, Telex: 311796 Drilsu G, Fax: +44-926-490001, Contact: Mr Slack. Thermoplastic borehole lining systems, PVC casing and screen systems, stainless steel range of well screens, drilling foam, biodegradable polymer and organic polymer.

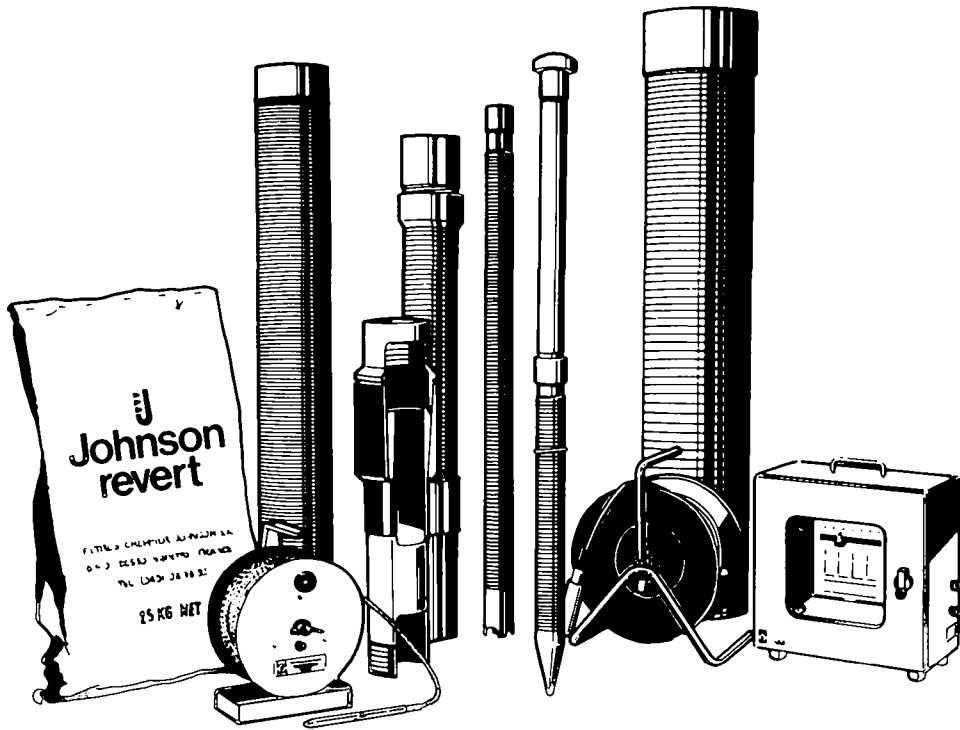

## Johnson: The Worldwide Manufacturer And Supplier Of Water Well Equipment

- Well screens, casing and accessories for:
  - dewatering
  - water wells
  - geothermal wells
  - oil and gas wells
- ▣ Self-destroying drilling mud and foam
- ▣ Gravel pack
- Equipment and chemicals for well development and rehabilitation
- Water level measuring instruments
- ▣ Borehole investigation
- ▣ Technical assistance

### **J** Johnson Filtration Systems

U.S.A. Johnson Filtration Systems Inc. □ P.O. Box 64118 □ St. Paul, MN 55164 □ 1-612-636-3900 □ 1-800-VEF-WIRE □ Telex: 29-7451  
□ Fax: 1-612-636-0889

U.K. Johnson Filtration Systems Ltd. □ Johnson House □ Browell's Lane - Feltham □ Middlesex TW13 7 EQ □ Tel: 01-751-44-24  
□ Telex: 935479 □ Fax: 01-890-1533

AUSTRALIA Johnson Filtration Systems Pty. Ltd. □ 96 Bath Road - Kirrawee, N.S.W. 2232 □ Tel: Sydney 2-521 3444 □ Telex: 25 371  
□ Fax: 2-521-3947

FRANCE Johnson Filtration Systems S.A. □ Z.I. Avelles-Er-Chatellerault □ 86530 Naintre, France □ Tel: 49-93-68-92 □ Telex: 791.124 F  
□ Fax: 49-93-68-75

**TUBAFOR INTERNATIONAL** 39 Champs Élysées Paris 75008 France Tel: +33-1-42259342, Telex: 280888 F, Fax: +33-1-45638408, Contact: . Water Well casings and screens: Steel, Stainless Steel and PVC.

**VAN REEKUM MATERIALS B V P O** Box 98 Apeldoorn AB 7300 The Netherlands Tel: +31-55-213283, Telex: 36316 vrmap. Hand and footpumps suitable for depths of up to 100 metres, cylinders and riser/rod combinations of corrosion resistant materials. Survey and construction equipment for hand drilled wells, complete with casing, tripod and hand winches. PVC casing and screens for shallow and deep wells, with several types of connections. Soil sampling equipment and acoustic sounding line measurement system. Well-pointing materials with cardan quick couplings.

### Handpumps

**AQUARIUS WATER PURIFICATION LTD** Unit 12, Craven Court, Winwick Quay Warrington Cheshire UK Tel: +44-925-445144, Telex: AQUA 627151, Fax: +44-925-413524. Aquarius 150, portable water pumping unit for streams, wells and rivers etc.

**AQUASERVICE** Cunard Building, Water St Liverpool L3 1HR UK Tel: +44-51-236-0421, Telex: +628512, Fax: +44-51-227-4759. The Aquamont deep well handpump, developed to established design principles, has completed the stringent CATR test programme.

**ATLAS COPCO ENERGY AB** S-105 23 Stockholm Sweden Tel: +46-8-743-80-00, Telex: 14090 copco s, Fax: +46-8-716-59-75. Atlas Copco Energy handpumps combined with SW-riser pipes can be installed and service can be made without special lifting equipment. Few moving parts assure a long period of use before any service is required. This is village level operation and maintenance.

**AUTOMETRIC PUMPS LTD** Turkey Court, Ashford Rd Maidstone Kent UK Tel: +44-622-677650, Telex: 965-633, Contact: Roger Burt. Producers of small pumps and sizes up to 2" BSP. The range includes centrifugal, gear, turbine, hand and vacuum pumps. We also handle a large range of pumps of other manufacture.

**BECKSON INDUSTRIAL PRODUCTS INC** PO Box 468 Guilford CT 06437 USA Tel: +1-203-453-3033, Telex: , Fax: +1-203-453-1302, Contact: Michael C Brady. Beckson manufactures a variety of industrial hand pumps. They are lightweight, of high impact pvc, and are excellent for water as well as chemical transfer. Manufacture the only UL listed chemical hand pump on the market and have adapters for most drums.

**BOODE B V P O** Box 27 AA Zevenhuizen ZH 2760 The Netherlands Tel: +31-1802-2744, Telex: 26642 Boode nl. Water well casing systems. Water well screen systems: standard range vertical slots, B & BR (ribbed) (din 4925) range horizontal slots, type "2000" continuous slots and BOODEPAC dual wall screen. Wellpoints for dewatering, dewatering equipment, casing/screen accessories, drilling fluids, water well consultancy, pumps and hand pumps.

**CAPITAL ENGINEERING SERVICES** Unit D4, Mail-mech Industrial Estate, 83 Copeth Cope Rd Beckenham Kent UK Tel: +44-1-658-2243, Contact: Ms Nield. Capital Engineering produce a full range of pumps, both manually operated and mechanical, ranging from 1/2 horse power to 1000s of horse power for drawing water from wells and bore holes etc.

**COLLEY NOCKOLDS LTD** 37 Bowater Rd London SE18 5TF UK Tel: +44-1-855-6593, Fax: +44-1-854-8421, Contact: Mr Parry. Distributors of a wide range of both motorised and hand operated transfer pumps.

**CONSALLEN GROUP SALES** 23 Oakwood Hill Industrial Estate Loughton Essex UK Tel: +44-1-508-5006, Telex: 393334, Contact: D V Allen. Manufacture hand pumps.

**CROWN - PACIFIC INTERNATIONAL** 18001 South Mitchell Irvine CA 92714 USA Tel: +1714-660-1798, Telex: 18100, Fax: +1714-660-9229, Contact: Mr Richard Mahoney. Suppliers of pumps and related equipment.

**DEMPSTER INDUSTRIES INC** 711 South Sixth St Beatrice NB 68310 USA Tel: +1-402-223-4026, Telex: 701447, Fax: +1-402-228-4389, Contact: Dean Kilgore. Manufacturers of pumps, water pumping windmills, hand pumps, (including the Mark II pump), pump cylinders and pump rods.

**DEPLECHIN POMPES SA** Ave de Maire 28 Tournai B-7500 Belgium Tel: +32-69-228152, Telex: 57399, Fax: +32-69-212764, Contact: Mr Malisart. Hand-operated pumps for deep wells also export industrial pumps. Specialise in special pumps and accessories in small quantities to clients requirements. Also pumps for all kinds of industry-chemicals, food etc.

**DUBA S A** Kasteeldreef 1 Wetteren 9200 Belgium Tel: +32-91-693496, Fax: +32-91-695752, Contact: Jacques De Backer. Company specialized in rural water supply. Manufacture and distribution of deepwell handpumps, pumps for solar (photovoltaic) energy, all kinds of irrigation pumps as well as reciprocating pumps for water boosters and small scale distribution.

**EBARA CORPORATION** 11-1 Haneda Asahicho Ohta-Ku Tokyo 144 Japan Tel: +81-3-743-67-16, Telex: EBARA TYO 322988, Fax: +81-3-745-3576, Contact: Mr R D Jones. EBARA is probably one of the largest specialist pump companies in the world 4000 employees manufacturing in Japan, Indonesia and Singapore a comprehensive range of pumps for all applications.

**EMW-SWEDE PUMP** Oringvagen 1 445 00 Hunkedal Sweden Tel: +46-52-712820, Fax: +46-52-411279. EMW SWEDE PUMP is selling and producing quality hand pumps and tube-clamps for standpipe installations. We provide highest swedish quality and use only first class material.

**FLUXINOS ITALIA SRL** Via Genova 8, 58100 Italy Tel: +39-564451272, Telex: 322458 Ikrane I, Fax: +39-564454237. Pulsa System water oscillation or spring rebound inertia hand pumps, the world's best pumping technology, presented and studied world wide for their scientific and technological interest, have revolutioni-

# BOODE

## WATER WELL SCREEN AND CASING

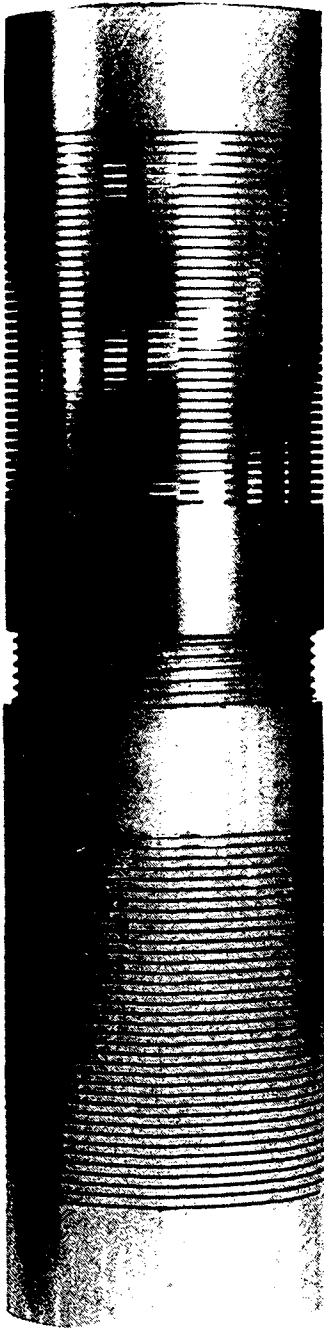

- Standard range screen
- B + BR screen (DIN 4925)
- Type 2000 screen
- Boodepac dual wall screen
- Wellpoints for dewatering
- Various types of casing

shown here is a new BOODE development ribbed screen "2000" with the following advantages:

- maximum open area up to 50%
- extends well life
- superior open area
- excellent for smaller water bearing beds
- allowing high flow capacity thus reducing the well inlet resistance, hence increasing well life
- flush coupled screwed joints
- ⊙ complete range of slotwidths
- light in weight, non corrosive, completely suitable for potable water, non-toxic, non-taint
- last but not least:  
available at a very favourable price

in addition to the above there is available the standard range of **BOODE** uPVC casing and screen systems which are supplied with variable types of connections and slotwidths

dual wall pre-gravel packed screens can be supplied in preference to other types of external only gravel coated screens

low cost handpumps for deep and shallow wells

drilling equipment

full range of water well drilling ancillary equipment

**main office:**  
P.O. Box 27  
2760 AA Zevenhuizen  
Holland  
tel. 01802 - 2744  
Telex 26642  
Fax 01802 - 3090

**U.K. office:**  
39 Bute Close  
Hinckley  
Leics. LE10 OSJ  
Tel. 0455 - 611317  
Fax 0455 - 610971

# BOODE

# PULSA SOLAR

Solar and hand operated pump

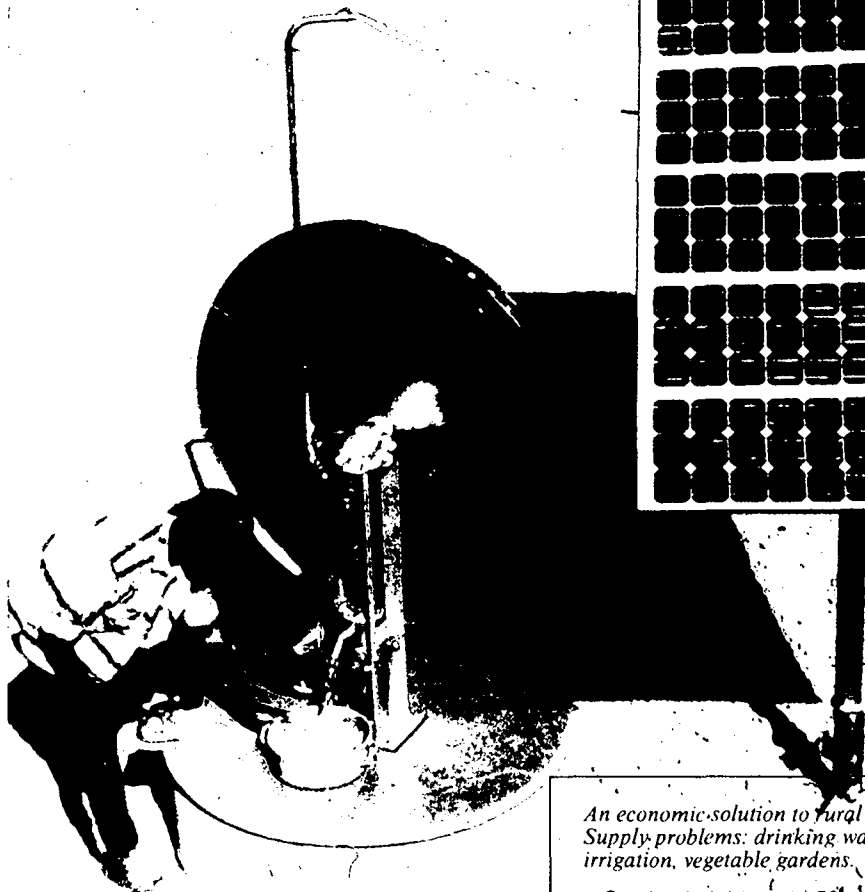

## FLUXINOS

*italia srl*

Via Genova, 8  
58100 Grosseto (Italy)  
Tel. 0564 - 45.1272  
Telex 50 04 33  
Telefax 0564 - 45 42 37

*An economic solution to rural water  
Supply problems: drinking water, small  
irrigation, vegetable gardens.*

- Suction height: up to 50mt.
- Capacity: up to 8M3/day
- No battery storage or inverters
- No moving parts below ground level
- Photovoltaic arrays: 300W
- Novel «Sunflower» three point manual tracking system
- All high quality corrosion resistant materials.



## HANDPUMPS

sed rural water supply in developing countries. Post-VLOM and Post-Plastic, they have no working parts below ground level, are entirely in stainless steel and rust and abrasion resistant, with one single length of flexible polyethylene feed pipe per pump, working vertically and/or horizontally, up to three pumps in on 110mm internal diameter bore-hole, from an actual water level of up 80m+. Single level systematic preventive maintenance with itinerant artisan able to handle on his own up to 500 installations. Global long term (10 year cycle) cost 0.405 US\$ per person per year, with cost per cubic meter of water pumped US\$ 0.0385. All parts including those subject to wear and tear guaranteed against breakdown for 12 months irrespective of the intensity of use.

**FORDWATER PUMPING SUPPLIES LTD** 49-53 Stratford Rd Birmingham West Midlands B11 1RQ UK Tel: +44-21-772-8336, Telex: 335807, Contact: Brian Powell. Supply and maintain all types of pumps.

**GRUNDFOS INTERNATIONAL A/S P D** Jensensvej 7 Bjerringbro 8850 Denmark Tel: +45-6-68-14-00, Telex: 60731 gfos dk, Fax: +45-6-68-44-72. Grundfos deep well hand pump GH1 250-180, a perfect solution for water supplies in villages in the 3rd world. The all stainless steel cylinder, rods and riser pipes make it a perfect solution.

**INSTRUMENTATION NORTHWEST INC** 14972 NE 31st Circle Redmond WA 98052 USA Tel: +1-206-885-3729, Fax: +1-206-867-0404, Contact: Robert W Landick. Instrumentation Northwest Inc produces a 1.66" diameter piston pump which may be utilized in a variety of applications. Pumping rates of 5 GPM may be achieved to depths of 500'. Hand operation is possible to depths of 100'.

**JANSEN VENNEBOER B V P O** Box 12 AA Wijhe 8130 The Netherlands Tel: +31-5702-2525, Telex: 49418, Fax: +31-5702-3618. Design, production and installation of mechanical construction for hydraulic works. Products include: archimedean screws, penstocks, sluice gates, radial gates, regulating and measuring weirs, weedcreens, automatic raking installations, Volanta handpumps and low-head water turbines (up to 1000 kW).

**JLC PUMPS & ENGINEERING CO LTD** Oxgate Farm Works, Coles Green Rd London NW2 7EX UK Tel: +44-1-452-4081, Telex: 82317, Contact: Mr Catton. All types of pumps for all purposes.

**JOBSON BECKWITH LTD** Treadway House, 26-30 Cubitt St London WC1X 0LR UK Tel: +44-1-833-0395, Telex: 940-96319, Fax: +44-1-837-5673, Contact: Mr D Goodson. Jobson Beckwith manufacture/distribute a range of positive displacement pumps for handling viscous liquids. Centrifugal, hand and flexible impeller pumps are also available, as is installation.

**MERRILL PUMPS AND ENGINEERING CO LTD** Chapel Works, Sheffield Rd, Sheepbridge Chesterfield Derbys S41 9EH UK Tel: +44-246-450518, Fax: +44-246-455-552, Contact: Mr Crispin. Manufacturers of hand pumps for bore holes in the developing world. Also irrigation pumps.

**MONARCH INDUSTRIES** PO Box 429 Winnipeg Man R3C 3E4 Canada Tel: +1-204-786-7921, Fax: +1-204-889-9120, Contact: Paul Fontaine. Manufacturer of hand pumps, end suction and self-priming frame mount, electric motor driven and engine driven pumps.

**MONO PUMPS LTD** Cromwell Rd, Bredbury Stockport SK6 2RF UK Tel: +44-61-494-6999, Telex: 668762 MONO G, Fax: +44-61-494-5802. Manufacturers of borehole pumps, hand driven to VLOM design, for rural water supplies - depths to 90 metres, and diesel, electric and solar driven, depths to 300 metres, flows to 100 m<sup>3</sup>/hr.

**F E MYERS CO** 400 Orange St Ashland Ohio 44805-2285 USA Tel: +1-419-289-1144, Telex: 987443, Fax: +1-419-289-6658, Contact: Mr Gary Lindekamt. Manufacturers of a complete range of pumps for all aspects of the water industry.

**PB PUMPENOESE KG** P O Box 1250 Burgwedel 1 -/ Hannover D-3006 West Germany Tel: +49-5139-80880, Telex: 17-04151398592. PB Pumpenboese KG produce a range of well screens and casings, submersible pumps, handpumps, dewatering equipment as well as hydrometric instruments and auxiliary drilling equipment.

**PUMPING SERVICE (GB) LTD** Whitehouse St, Jack Lane, Hunslet Leeds LS10 1AP UK Tel: +44-532-446111, Telex: 557445, Fax: +44-532-465649, Contact: Mr Fox. Distributors for most of the leading British pump manufacturers. Around 2,000 pumps of various sizes and types in stock at any time, covering all applications.

**ROACH PUMPS LTD** 62 Southwark Bridge Rd London SE1 0AS UK Tel: +44-1-928-7102, Telex: 596691, Fax: +44-1-928-8254, Contact: Mr T Roach. With nearly 30 years experience in the handpump industry, whatever your manual pump requirement is, Roach Pumps can make you the right offer with the best possible unit.

**ROBBINS & MYERS CANADA LTD** 17 Woodyatt Drive Brantford N3T 5N6 Canada Tel: +1-519-752-5447, Telex: 06181131, Fax: +1-519-752-3243, Contact: Mr Murray Locke. Produce progressing cavity pumps for industrial and municipal applications and hand pumps which use the progressing cavity principle.

**SCANDINAVIAN CLINICS** PO BOX 511 Stockholm S-101 26 Sweden Tel: +46-8-114560, Telex: 8106113. The Swedpump System idea behind the development of this pump was to use modern technology and materials with special features in order to develop a more durable, trouble free, sanitary and inexpensive hand pump, requiring maintenance within the limitations of local capabilities, which can also be assembled or manufactured locally.

**TORRENT PUMP INDUSTRIES** P O Box 51066 Kifisia GR-145 10 Greece Tel: +30-1-8161712/8161702, Telex: 215870, Fax: +30-1-8161018. Handpumps and deep well vertical pumps with lineshaft accessories.

**VAMMALAN KONEPAJA INC** P O Box 54 Vammala SF-38201 Finland Tel: +358-32-12667, Telex: 22661 mine sf, Fax: +358-32-43134. Vammalan Konepaja Inc is the largest handpump manufacturer in Finland, the com-

# Swede Pump

*the simple and reliable handpump  
for rural villages*

## This is our Working Horse

and now we introduce the  
**NEW** pipe coupling  
**JLT-TUBE CLAMP**  
**WORLD UNIQUE DESIGN**  
for e.g. stand pipe installations

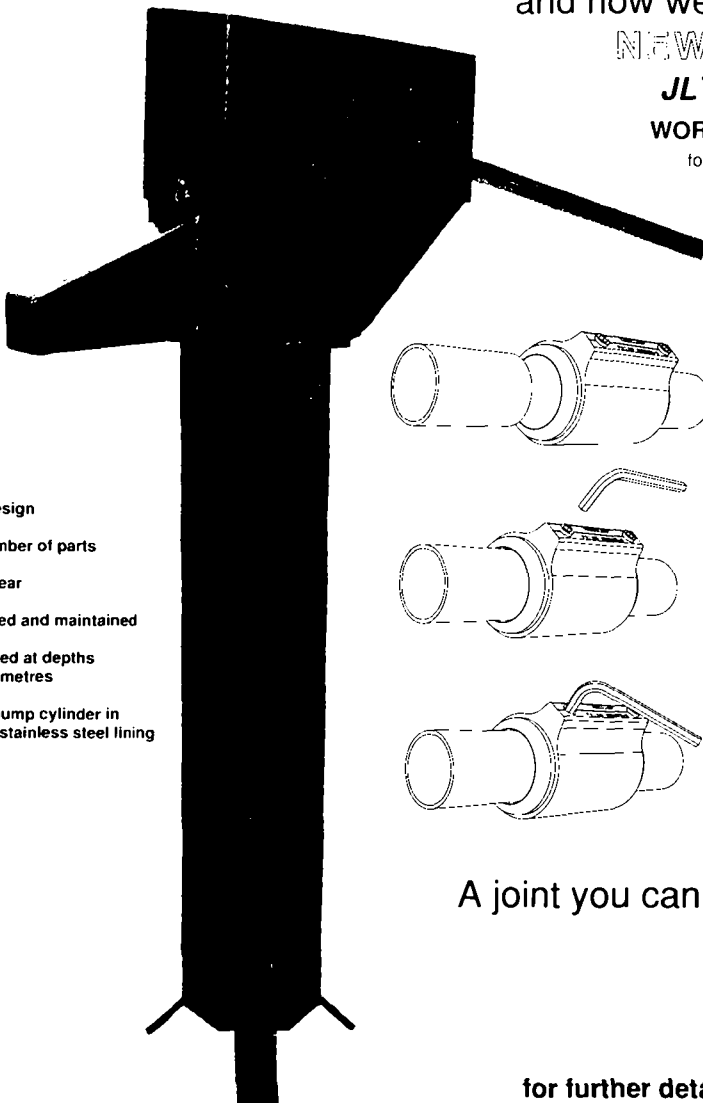

- Simplified design
- Reduced number of parts
- Minimised wear
- easily installed and maintained
- easily operated at depths down to 100 metres
- heavy duty pump cylinder in acetale, with stainless steel lining

- extremely simple
- joints flat ends without threads or flanges
- total independence of pipe standard lengths
- strong grip, using a minimum of force
- no loose parts

**A pump you can  
trust for years**

**A joint you can trust for years**

**for further details, please contact**  
EMW-Swede Pump  
Box 81 S-455 00 Munkedel SWEDEN  
Phone: 46-524 12820  
Fax: 46-524 11279

pany was established in 1919. NIRA AF-85 was the best low-lift handpump at the world bank's testing programme, successfully used in most of the Eastern African countries. NIRA AF-85 simplicity and reliability: village women in Kenya are responsible of maintenance, maintenance costs are less than 20% of the 'old generation' handpumps.

**VAN REEKUM MATERIALS B V P O** Box 98 Apeldoorn AB 7300 The Netherlands Tel: +31-55-213283, Telex: 36316 vrmap. Hand and footpumps suitable for depths of up to 100 metres, cylinders and riser/rod combinations of corrosion resistant materials. Survey and construction equipment for hand drilled wells, complete with casing, tripod and hand winches. PVC casing and screens for shallow and deep wells, with several types of connections. Soil sampling equipment and acoustic sounding line measurement system. Well-pointing materials with cardan quick couplings.

**WATERRA PUMPS LTD** Suite 14-15, 25 Adelaide St East Toronto Ontario Canada Tel: +1-416-362-4900, Telex: 06-217544, Fax: +1-416-362-5042, Contact: Mr Bob Nadon. Manufacturers and distributors of sampling pumps both manual and powered.

### Deep Well Pumps, Pump Tests and Groundwater Sampling

**A/S DEEP WELL PUMPS LTD P O** Box 1013 Lademoen Trondheim N-7001 Norway Tel: +47-7-514922, Telex: 75705 PUMPS N. A/S Deep Well Pumps Ltd has developed a deep well pump which is able to operate in small diameter boreholes that are cheaper and quicker to drill. The pump system is divided into two parts, a well pump down in the drilling hole and a pressure pump with tap-point at the surface. The connection between tap-point and well pump is tubes. The tap-point can be situated away from the well hole in order to avoid waste water mingling with the well water. All types of energy can be adapted for pump operation.

**AMERICAN SIGMA INC** One Elizabeth St Middleport NY 14105 USA Tel: +1-716-735-3616, Fax: +1-716-735-3711. Geoguard groundwater sampling systems include both portable and dedicated systems with a wide range of downwell components including bailers, gas-drive pumps, bladder pumps and the unique two-stage pump. Geoguard equipment meets the latest EPA standards assuring the integrity of every sample.

**ARKANA EUROPE P O** Box 286 AG-Diemen 1110 The Netherlands Tel: +31-20-998537, Telex: 13399. Conrad drilling equipment for soil investigation, placer exploration (onshore and offshore) and water well drilling. Drill supplies in general. Hydraulically driven irrigation and deep well pumps. Auger pumping stations for irrigation, windmills, hydraulics powerpacks, winches (hydraulic and mechanical) etc. High pressure piston pumps for drilling chemicals (mud, foam etc) sewerage cleaning, diamond drilling, agricultural spraying etc. Diesel driven diaphragm pumps for very dirty water.

**BARNES BOWSER (PUMPS) LTD** 75 Tupwood Lane

Caterham Surrey CR3 6DD UK Tel: +44-883-43619, Contact: Mr W Stevens. Barnes Bowser manufacture self-priming single stage pumps from 1.5 inch - 6 inch bore and mixed flow pumps (non self priming) upto 12 inch bore. These products have their application in drawing water from wells and bore holes.

**BIZZI & TEDESCHI SNC** Via Brodolini 35A Campagne RE 42040 Italy Tel: +39-522-677209-67257, Fax: +39-522-677633, Contact: Daniele Bizzi. Manufacturers of submersible electropumps for 4" - 6" - 8" wells.

**BOODE B V P O** Box 27 AA Zevenhuizen ZH 2760 The Netherlands Tel: +31-1802-2744, Telex: 26642 Boode nl. Water well casing systems. Water well screen systems: standard range vertical slots, B & BR (ribbed) (din 4925) range horizontal slots, type "2000" continuous slots and BOODEPAC dual wall screen. Wellpoints for dewatering, dewatering equipment, casing/screen accessories, drilling fluids, water well consultancy, pumps and hand pumps.

**CONDRILL AB** Sveavagen 83 113 50 Stockholm Sweden Tel: +46-8-349560, Telex: +12336, Fax: +46-8-316762

**C W COX INC P O** Box 3214 South El Monte CA 91733 USA Tel: +1-818-443-5090, Contact: John Morgan. Insertion flowmeters for pump testing, electric well sounders and bottom sounders for water level testing and basement levels. Full diameter pitot tubes or center sampling rotameter-style meters. Software packages for pump efficiency tests.

**CAPRARI SpA** Emilia Ovest 900 MO 41100 Italy Tel: +39-59-330-533, Telex: , Fax: +39-59-338153, Contact: Cludia. Leading European manufacturers of: electric submersible pumps for 4" to 14" wells, deep well turbine pumps, vertical and horizontal electric monobloc pumps, single and multistage centrifugal pumps and P. T. O. pumps.

**DIEDRICH DRILLING EQUIPMENT INC** PO Box 1670 Laporte IN 46350 USA Tel: +1-219-326-7788, Fax: +1-219-324-5962, Contact: Mr Harry Ward. Manufacture drilling equipment and tools for engineering, soil testing etc. Main application is for monitor well drilling, for testing the purity of water.

**DUBA S A** Kasteeldreef 1 Wetteren 9200 Belgium Tel: +32-91-693496, Fax: +32-91-695752, Contact: Jacques De Backer. Company specialized in rural water supply. Manufacture and distribution of deepwell handpumps, pumps for solar (photovoltaic) energy, all kinds of irrigation pumps.

**EFIMEX sa SITINDUSTRIE GROUP** 8, Rue du 31 Decembre, 1207-Geneva, Switzerland Tel: +41-22-7366610, Telex: +289392 EFST, Fax: +41-22-7366610. EFIMEX is dedicated to oil and water well equipment since 1974 as part of the SITindustrie group it constitutes a major manufacturing source for: - pump riser pipes in stainless steel, carbon steel supplied with flanges or threaded connectors - well heads in stainless steel - stainless steel fittings, tees and elbows.

**EMMANUEL N. KAZIS SA** PO Box 51066, /GR-145 10

# NIRA AF-85

## THE NEW GENERATION SHALLOW WELL HANDPUMP



Top ranking in the World Bank lab and field tests. A true VLOM handpump. Popular with users. Very easy to operate.

THE VILLAGERS CAN DO IT: In Kenya the village women are responsible for the NIRA AF-85 maintenance.

- All downhole components are plastic.
- Max. depth 20 m.
- No need for regular maintenance
- Tools for installation and maintenance less than \$ 30.

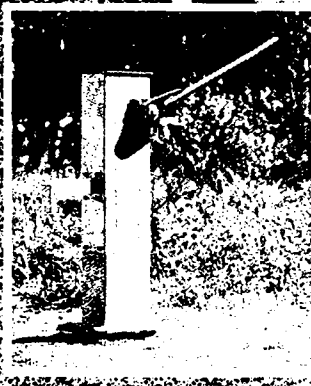

**AF-84** A reliable handpump for deep wells, max. depth 65 m. Successfully laboratory tested. Risers: galvanized steel, HD polyethylene or stainless steel. Several cylinder options.

High quality NIRA products are manufactured by:



**VAMMALAN  
KONEPAJA INC.**

P.O. BOX 54  
SF-38201 VAMMALA,  
FINLAND

Telephone (+ 358)-32-126 67  
Telefax (+ 358)-32-431 34  
Telex 22661 nira sf

Handpumps for more than 50 years.

## DEEP WELL PUMPS, PUMP TESTS AND GROUNDWATER SAMPLING

Kifissia, Greece Tel: +30-1816712/8161702, Telex: 215870 EMKAGR, Fax: +30-8161018. Manufacturing all types of pumps: "Torrent" Deep well vertical pumps with linesshaft, "Torrent" submersible electric pumps, "Torrent" mixed and axial flow vertical pumps, Centrifugal surface pumps, "STA-RITE/KAZIS" submersible pumps, power panels, pump accessories, handpumps, special purpose pumps.

**EMW-SWEDE PUMP** Oringvagen 1 445 00 Hunkedal Sweden Tel: +46-527-12820, Fax: +4652411279. EMW SWEDE PUMP is selling and producing quality hand pumps and tube-clamps for standpipe installations. We provide highest swedish quality and use only first class material.

**FLUXINOS ITALIA SRL** Via Genova 8, 58100 Italy Tel: +56-445-1272, Telex: 322458 Ikrane I, Fax: +56-445-4237. Pula System water oscillation or spring rebound inertia hand pumps, the world's best pumping technology, presented and studied world wide for their scientific and technological interest, have revolutionised rural water supply in developing countries. Post-VLOM and Post-Plastic, they have no working parts below ground level, are entirely in stainless steel and rust and abrasion resistant, with one single length of flexible polyethylene feed pipe per pump, working vertically and/or horizontally, up to three pumps in on 110mm internal diameter bore-hole, from an actual water level of up to 80m+. Single level systematic preventive maintenance with itinerant artisan able to handle on his own up to 500 installations. Global long term (10 year cycle) cost 0.405 US\$ per person per year, with cost per cubic meter of water pumped US\$ 0.0385. All parts including those subject to wear and tear guaranteed against breakdown for 12 months irrespective of the intensity of use.

**FORDWATER PUMPING SUPPLIES LTD** 49-53 Stratford Rd Birmingham West Midlands B11 1RQ UK Tel: +44-21-772-8336, Telex: 335807, Contact: Brian Powell. Supply and maintain all types of pumps.

**FRANKLIN ELECTRIC** Blufon IN 46714 USA Tel: +1-219-824-2900, Telex: 232-493, Fax: +1-219-824-2909, Contact: Mr Schach. Franklin is the world's leading manufacturer of submersible motors for deep well pumps and a leading manufacturer of electric motors for centrifugal pumps, with a maximum rating of 3 hp.

**FULTZ PUMPS INC** PO Box 550 Lewistown PA 17044 USA Tel: +1-717-248-2300, Contact: Mona Macknair. Manufacture a ground water sampling pump.

**GEOTECH ENVIRONMENTAL EQUIPMENT INC** 1441 West 46th Avenue, Unit 17 Denver CO 80211 USA Tel: +1-303-433-7101. Geotech Environmental Equipment Inc is a progressive international manufacturing company, dedicated to providing high quality equipment for the collection and filtration of water samples. In addition to our standard product line, we welcome the challenge of custom manufacturing equipment to suit your needs. Our policy is to design and manufacture the best monitoring equipment at the most competitive prices.

**GISCO - GEOPHYSICAL INSTRUMENT & SUPPLY** 4665 Joliet St Denver CO 80239 USA Tel: +1-303-371-

1940, Telex: +45769, Contact: H W Siegel. Gisco offers a complete line of geophysical equipment and instrumentation including magnetometers, electromagnetic, magnetotelluric, gravity meters, resistivity, induced polarization systems, seismographs, borehole logging units, spectrometers, hydrological field and lab test equipment. Write for detailed 190 page catalog.

**GRUNDFOS INTERNATIONAL A/S** P D Jensensvej 7 Bjerringbro 8850 Denmark Tel: +45-6-68-14-00, Telex: 60731 gfos dk, Fax: +45-6-68-44-72. Grundfos stainless steel submersible pumps and turbine pumps types SP and BP designed for general water supply, irrigation and industrial applications. Capacity range: Q up to 280 cbm/h. H up to 500 m.

**HAYWARD TYLER LTD** 24 Crawley Green Rd Luton Beds LU1 3LW UK Tel: +44-582-31144, Telex: 82158, Fax: +44-582-452198, Contact: Pat Clements. Borehole submersible pumps for water supply and irrigation.

**HOVAL FARRAR LTD** Northgate Newark Nottinghamshire NG24 1JN UK Tel: +44-636-72711, Telex: 37164, Fax: +44-636-73532, Contact: Peter Neers. Birral Pumps manufactured in Switzerland from the highest quality materials to exacting standards. Birral can design and build to specific requirements or supply standard pumps from its large stocks. The range is from small water circulating pumps to deep well submersibles to pressure boosting and water feed pumps, sewage pumps, control systems and special designs.

**INTERSIGMA** Export and Import Corporation of Sigma Concern, 111 87 Praha 1, Vaclavske nam. 60, POB 1111, Czechoslovakia. Exports and Imports: pumps, pumping equipment, irrigation equipment, industrial valves, complete water management plants, pumping stations, sewage water purifying plants, water treatment plants, pumps, valves and pipings for nuclear power generation, industrial pipings, plants for manufacture of pumps and valves.

**INSTRUMENTATION NORTHWEST INC** 14972 NE 31st Circle Redmond WA 98052 USA Tel: +1-206-885-3729, Telex: , Fax: +1-206-867-0404, Contact: Robert W Landick. Instrumentation Northwest Inc produces a rod actuated piston pump with an overall O D of 1.66". The Hydrostar pump may be used in a variety of applications at depths to 500+ feet. All components are warrantied for a period of 2 years.

**LAYNE & BOWLER INC** PO Box 8097 1993 Chelsea Avenue Memphis TN 38108 USA Tel: +1-901-278-3800. Possessing a history that stretches back 93 years, Layne & Bowler is known throughout the world for its expertise in the design, manufacture and installation of vertical turbine pumps up to 30,000 GPM capacity. Products: vertical well pumps, short coupled service pumps, in-line pumps, submersible pumps, volatile liquid pumps and well screen.

**LAYNE-WESTERN CO INC** 721 West Illinois Avenue Aurora IL 60506 USA Tel: +1-312-897-6941. With 28 offices located throughout the US, Layne-Western Company is recognized as the leader in the field of water technology. Fully capable of providing practically every vital service needed by water users, municipal, indus-

# SULZER—Your Partner for Advanced Pump Technology

Sulzer can draw on more than 125 years experience of engineering large storage and water transport pumps, to guarantee optimal combination of components. One of the principal design objectives is that of minimum weight with maximum efficiency.

Whether for a community water supply of a few litres per second, or a water transport system for a large city of thousands of litres per second, whether components or turnkey installations are to be supplied, Sulzer can propose the most economical answer. Sulzer pumps include standard types for small and medium-sized installations as well as special designs for major schemes. They comprise horizontal and vertical, single and multi-stage pumps for dry or wet installation. Water desalination, treatment, supplies, disposal and transportation is a wide field of activity in which Sulzer has been gathering experience and putting it to good use for decades.

## Production and Assembly

Manufacture is carried out for the most part in eight foreign Sulzer companies, whose product ranges are matched to the particular local market requirements and conditions. Quality guidelines are laid down centrally, the pumps are produced with modern facilities — machining is done on the limit gauge system, so that spare parts may be interchanged regardless of where they were made. Sulzer pump factories incorporate test beds in which even the biggest pumps can be tested under conditions representing actual service.

## Quality Assurance and Control Organization

To ensure that quality is built into every Sulzer pump, every production facility has its own quality assurance section supervised from the central quality assurance and control organization. Unrestricted interchangeability of parts and entire subassemblies is ensured, regardless of their place of manufacture.

## Research and Development

In-house laboratories are available for the study of

fluid dynamics and vibration analysis in addition to physical, chemical and metallurgical research.

## Customer Support

Besides supplying pumps, Sulzer can provide competent support in the following areas which are of critical importance to the proper functioning of an installation:

- Averting water hammer problems by using proper precautions;
- Optimal choice of materials to withstand erosion, corrosion and abrasion;
- Determining the optimal geometries for the suction and discharge branches;
- Calculation of forces and movements on foundations, pipelines and machines;
- Calculation of torsion critical pump set vibrations;
- Supply of complete installations, in particular electromechanical and mechanical components such as motors, pipework, guide valves, valves and compressed air vessels;
- Optimization of pump installations by automatic speed control.

## Why choose Sulzer Pump Division as your Partner?

Because Sulzer:

- Pioneers research in pump and plant engineering;
- Offers quality assurance and control up to the highest levels;
- Offers a wide range of pumps;
- Can tailor pumps to meet your specific needs;
- Gives expert support in every aspect of pump technology;
- Has a sound financial background;
- Has customer support network and manufacturing facilities worldwide.

Ask for a personal call by our representative, or detailed documentation. We shall be pleased to serve you! Sulzer Brothers Limited, CH-8401 Winterthur, Switzerland. Telephone 052-81 11 22. Telegrams Gebsulzer Winterthur. Telex 896 060 G.

## SULZER in Water Technology

	Water Transport	Water Supply	Irrigation	Water Treatment	
				Drinking and Process Water	Wastewater Treatment
				Municipal	Industrial
Pumping	●	●	●	●	●
Clarification, Separation				●	●
Aeration				●	●
Biological treatment				●	●
Filtration				●	●
Reverse osmosis (desalination)				●	●
Sludge treatment				●	●

Pumping station, fitted with high-pressure pumps, supplying Caracas (Venezuela) with drinking water.

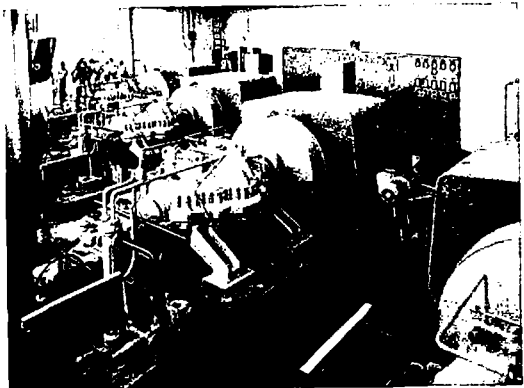

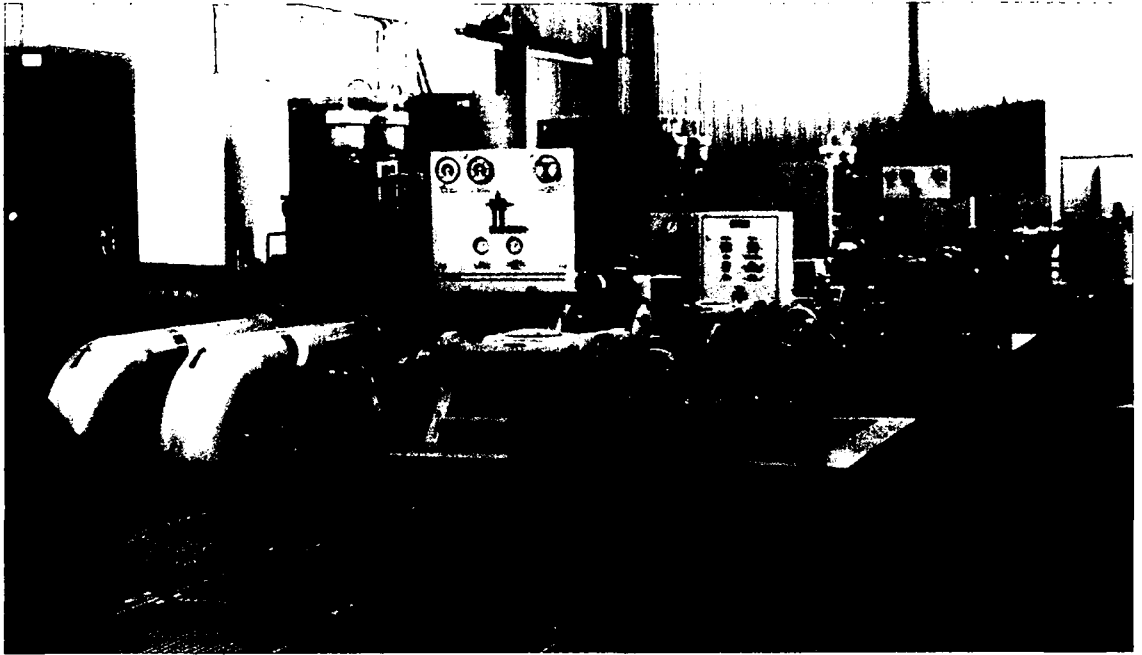

Water transmission system for Mecca and Taif, Saudi Arabia. Pumping station with the installation of eight type HPDM high-pressure water transport pumps.

# Sulzer Pump Technology for the Highest Water Transmission System in the Middle East

Sulzer has supplied 28 high-pressure water transport pumps with total installed power of 54 MW for a 150 km long water transmission system in Saudi Arabia. This system transports water from a desalination plant on the Red Sea up to the altitude of 1650 m above sea level and supplies the cities of Mecca and Taif with drinking water.

These horizontal, double-flow, volute-casing pumps feature long service life, reliability in operation, maximum efficiency and high quality standard. They

embody the extensive experience of the Sulzer Pump Division and the proven service of these pumps in Europe, South and Central America, the Middle East and other parts of the world.

This solid background was an essential factor in their selection for a significant contribution to the development of Saudi Arabia's water supply systems.

So why not ask Sulzer to partner your next project, too?

## **SULZER®**

Represented in more than 120 countries

---

Sulzer Brothers Limited, Pump Division, CH-8401 Winterthur, Switzerland  
Telephone 052-81 11 22, Telex 896 060 40

PU 41e

trial and agricultural. Services: complete hydrological engineering investigation, industrial and irrigation supply systems, drill and maintain water wells, install and service deep well pumping equipment, sell and install water and waste water treatment equipment for municipal authorities.

**MAPE SA** 14 Boulevard Du Marechal-Juin Nantes F-44100 France Tel: +33-40-43-34-11, Telex: 711436, Fax: +33-40-43-50-11, Contact: Mr Champs. Manufacture pumping units for water production.

**MERRILL PUMPS & ENGINEERING CO LTD** Chapel Works, Sheffield Rd, Sheepbridge Chesterfield Derbyshire UK Tel: +44-246-450518, Telex: 54/7771HIPGMC, Contact: Mr Stan Ellis. Merrill Pumps range includes deep well pumping equipment for manual pumping of drinking water in remote areas. This equipment has been designed for long life, and if installed correctly will have no maintenance problems, with an estimated life of five years.

**MID-SOUTH PUMP CO** PO Box 16785 Memphis TN 38186 USA Tel: +1-901-345-7204, Fax: +1-901-345-3129. Shipping: 1555 Three Place Memphis TN 38116 United States of America We manufacture Jacuzzi and Delta lineshaft and submersible turbines. Custom engineered to your specifications and available with oil or water lubrication. Standard construction 416SS bowl shaft, cast iron bowls with vitreous enamel lining, bronze closed and semi-open impellers and special designed bearings. Certified test available. Large inventory and can ship world-wide without delay.

**F E MYERS CO** 400 Orange St Ashland Ohio 44805-2285 USA Tel: +1-419-289-1144, Telex: 987443, Fax: +1-419-289-6658, Contact: Mr Gary Lindekamt. Manufacturers of a complete range of pumps for all aspects of the water industry.

**NEI - APE LTD LEE-HOWL (A DIVISION OF BELLISS & MORCROM)** Icknield Square Birmingham B16 0QL UK Tel: +44-21-454-3531, Telex: 337507, Fax: +44-21-455-8607, Contact: Dawn Lamb. Pump range includes submersible turbine borehole pumps, mixed flow bowl pumps, split casing water pumps, drywell and submersible sewage and solids handling pumps. Capacities 10 l/s to 350 l/s.

**NORTON PERFORMANCE PLASTICS** Chesterton Works, Loomer Rd Newcastle Staffs ST5 7HR UK Tel: +44-782-563726, Telex: 36389, Fax: +44-782-562455, Contact: Sue Hinson. Norton Performance Plastics are the world's leading manufacturers of fluoroplastic, elastomeric and thermoplastic materials and products, offering new developments and expertise in pipe bearing, vessel and ground water monitoring.

**OCV CONTROL VALVES** 7400 East 42 Place Tulsa Oklahoma 74145 USA Tel: +1-918-627-1942, Telex: 910-845-2227, Fax: +1-918-622-8916. OCV manufactures and internationally markets a complete line of automatic, hydraulically operated, pilot controlled valves. To prevent line shock to piping and components during start-up and shut-down of the pump, OCV offers the series 125 for the control of booster pumps and the series 126 for deep well pumps.

**PEERLESS PUMP LTD** Ferry Lane Brentwood Middlesex TW8 0AL UK Tel: +44-1-560-3922, Contact: Pat Clements. Borehole submersible pumps for water supply and irrigation.

**POMPE PORCELLI ELVIO & FIGLI SNC** SS 148 KM 82,500 B Go S Donato Sabaudia (LT) 04010 Italy Tel: +39-773-50392-3, Fax: +39-773-50393, Contact: Mrs S Battini. Range of pumps from deep well vertical and horizontal pumps, electric submersible, centrifugal and trolleyed pumps.

**PUMPING SERVICE (GB) LTD** Whitehouse St, Jack Lane, Hunslet Leeds LS10 1AD UK Tel: +44-532-446111, Telex: 557445, Fax: +44-532-465649, Contact: Mr Fox. Distributors for most of the leading British pump manufacturers. Around 2,000 pumps of various sizes and types in stock at any time, covering all applications.

**SCANDINAVIAN CLINICS** PO BOX 511 Stockholm S-101 26 Sweden Tel: +46-8-114560, Telex: 8106113. The Swedpump System idea behind the development of this pump was to use modern technology and materials with special features in order to develop a more durable, trouble free, sanitary and inexpensive hand pump, requiring maintenance within the limitations of local capabilities, which can also be assembled or manufactured locally.

**SEBA HYDROMETRIE GmbH** Dessestr 5 Kaufbeuren-Neugablonz D-8950 West Germany Tel: +49-8341-62026, Fax: +49-8341-62029, Contact: Wolfgang Zasche. Seba Hydrometrie is a manufacturer of hydrological, meteorological and sewage measuring instruments. The instruments are installed in more than 90 countries worldwide. Range of production: water sampling equipment: 2"- and 4"- mechanical samplers, 2" submersible pump with 12 l/min capacity, water level recorders and control systems, current meters/winchies, data loggers and transmission systems and all kind of meteorological sensors.

**SULZER BROTHERS LIMITED** Pump Division 8401 Winterthur Switzerland Tel: +41-52-81-11-22, Telex: 896-060-40, Fax: +41-52-23-42-83. The Sulzer pump division with its headquarters in Winterthur has a labour force of 3350 and pump-manufacturing facilities in ten overseas countries. Joint ventures have been formed in India and Venezuela to improve the company's position in the process pump sector. Sulzer pumps are also manufactured under licence in Italy, Japan, in the People's Republic of China, Yugoslavia and South Korea. Joint ventures are in India and Venezuela. The Sulzer pump division with sales offices and agencies in 83 countries is active all over the world and manufactures pumps for the most diverse requirements in the energy, oil, HPI and water technology sectors as well as for general industries like pulp and paper, sugar, chemical, etc. Over many years, Sulzer has established an extensive manufacturing pump programme for liquid transport application. Currently, this programme includes pumps for large flows of water over long distances with high heads, drinking water supply pumps, irrigation and drainage pumps, and effluent transport pumps.

**SYKES PUMPS LTD** Gallions Rd, Charlton London



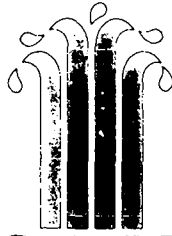

**CONDRIILL**

## **Not only a drilling company...**

In co-operation with Sweden's most reputable consulting engineers, geologists, geophysicists and hydrogeologists CONDRIILL can provide the full range of services needed to complete any water supply scheme on a turn-key basis:

### **Exploration and Appraisal**

In addition to the drilling, a number of different services are offered: geological, geophysical, seismic and aerial.

### **Development drilling, logging and well testing**

### **Pumps, Pipe-lines and Irrigation**

CONDRIILL supplies and installs pumping equipment, pipe-lines and irrigation systems.

**Contact CONDRIILL for any water project!**

CONDRIILL AB, SVEAVÄGEN 83, S-113 50 STOCKHOLM, SWEDEN. TELEPHONE: 08-34 95 60.  
CABLE: CONDRIIL STOCKHOLM. TELEX: 12336 CONDRIIL. TELEFAX: 08-31 27 62



*Exports and imports:  
pumps, pumping equipment,  
irrigation equipment, industrial  
valves, complete water management  
plants, pumping stations, sewage  
water purifying plants, water  
treatment plants, pumps, valves and  
pipings for nuclear power  
generation, industrial  
pipings, plants for manufacture  
of pumps and valves.*



Export and Import Corporation of Sigma Concern,  
111 87 Praha 1, Václavské nám. 60  
P.O.B. 1111  
Czechoslovakia

# The Modern Approach to Water Exploration

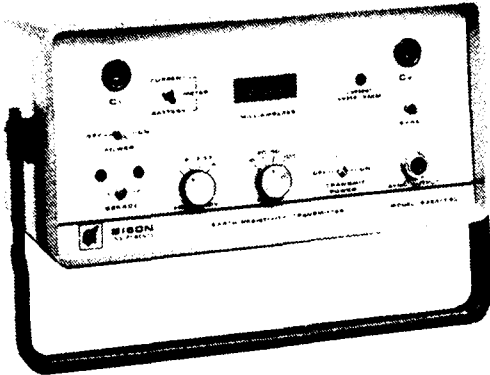

Now there's a more effective method to aid you in siting your water well drills. The Bison Model 2390 Signal Enhancement Earth Resistivity System is a sophisticated electronic instrument that helps you locate ground water and determine the degree of salinity contamination.

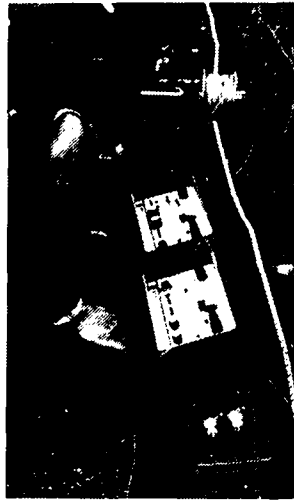

With its advanced new

Bison signal enhancement system, the Model 2390 can explore several times deeper than conventional resistivity systems of similar transmitter power, and with greater accuracy. It is completely self-contained and portable, with built-in operating controls and rechargeable power supply.

Send now for more information about locating water the fast, easy way. Or contact an authorized dealer.



**BISON** INSTRUMENTS Inc.

5708 W. 36th St. • Minneapolis, MN 55416  
Telephone: (612) 926-1846 • Telex: 29-0208

- Signal Processing Seismographs • Signal Enhancement Seismographs
- Earth Resistivity Systems • Soil Strain Gauges • Digital Recorders
- Magnetic Susceptibility Systems • Crosshole Shearwave Systems

SE7 7AP UK Tel: +44-1-858-8121, Telex: 896324, Fax: +44-1-853-4786, Contact: Mr Sharpe. Sykes Pumps are specialists in the provision of self-priming diesel and electro submersible pumps for ground water, slurry, sludge and storm water control. From 33 depots nationwide, Sykes provide a first class hire, sales and maintenance service.

**THOMPSONS KELLY & LEWIS LIMITED** PO Box 160 Springvale Victoria 3171 Australia Tel: +61-3-562-0744, Fax: +61-3-562-0885, Contact: Ruedi Birmele. Thompsons, Kelly & Lewis is Australia's leading manufacturer and supplier of vertical multistage pumps of lineshaft and submersible design for use in boreholes, water wells and rural use in general. These pumps offer a compact installation and maintenance free materials are used throughout. Flow rates to 300 L/s and heads to 300 m.

**THOR INTERNATIONAL INC** 13751 Lake City Way NE, 201 Seattle WA 98125 USA Tel: +1-206-361-8467, Fax: +1-206-367-1721, Contact: Peter Thordauson. Ground water monitoring instruments for level/flow/temperature, electronic transducers, data loggers, multiplexers, pocket computer and hand held read out. Data loggers have a memory of 32,000 readouts. Please contact for further information.

**TORRENT PUMP INDUSTRIES P O** Box 51066 Kifisia GR-14510 Greece Tel: +30-1-8161712/8161702, Telex: 215870, Fax: +30-1-8161018. Handpumps and deep well vertical pumps with lineshaft accessories.

**WEIR PUMPS LTD** Newlands Rd, Catchcart Glasgow G44 4EX UK Tel: +44-41-637-7141, Telex: 77161, Contact: Mr Inker. For water supply and sewage treatment: abstraction pumps, borehole pumps (shaft driven and submersible), pipeline and other distribution pumps, water treatment system pumps, sewage pumps, submersible sewage and land drainage pumps, complete pumping systems and controls, contract management, surge assessment of pumping systems, including the supply and setting to work of the necessary equipment, comprehensive facilities for model testing of pump sums and complete intake systems.

**YSI INCORPORATED** YSI Scientific Ltd, Lysons Avenue, Ash Vale Aldershot Hampshire GU12 5QR UK Tel: +44-252-513006, Telex: 858210 INSTCOG, Fax: +44-252-511855. YSI dissolved oxygen and conductivity instruments monitor wastewater treatment and provide environmental control and enforcement. Other YSI systems help maintain pure water supplies by measuring temperature, pH, conductivity and ORP in surface water and groundwater as it's pumped from test wells. YSI instruments assure healthy crops of fish and shellfish in hatcheries and on fish farms.

### Alternative Energy Pumps (Wind, Solar)

**A/S DEEP WELL PUMPS LTD** P O Box 1013 Lademøen Trondheim N-7001 Norway Tel: +47-7-514922, Telex: 75705 PUMPS N. A/S Deep Well Pumps Ltd has

developed a deep well pump which is able to operate in small diameter boreholes that are cheaper and quicker to drill. The pump system is divided into two parts, a well pump down in the drilling hole and a pressure pump with tap-point at the surface. The connection between tap-point and well pump is tubes. The tap-point can be situated away from the well hole in order to avoid waste water mingling with the well water. All types of energy can be adapted for pump operation.

**ABACHEM ENGINEERING LTD** Jessop Way Newark Notts NG24 2ER UK Tel: +44-636-76483, Contact: Mr Parrott. Manufacture windpumps for domestic, irrigation and drainage systems, up to 120 metre head and maximum capacity of 8,700 litres per hour.

**AEG AKTIENGESSELLSCHAFT** Steinhüft Hamburg 11 D-2000 West Germany Tel: +49-40-36-16-1, Telex: 211868. Solar powered pump equipment for irrigation, drinking water and desalination systems. Examples of solar pump systems operated in Argentina, China (PR), Gambia and Kenya.

**AERMOTOR WINDMILL CORPORATION** Box 5110, 3015 N Bryant Boulevard San Angelo Texas 76902 USA Tel: +1-915-658-2795, Fax: +1-915-942-9377, Contact: Mr Lane. Aermotor Windmills are 100 years old. We manufacture wind-powered motors with multi-blade steel wheels to pump water up to 304. 80 meters and produce up to 208. 18 liters per minute.

**JOHN BLAKE LTD** PO Box 43, Royal Works Accrington Lancs BB5 5LP UK Tel: +44-254-354419, Fax: +44-254-382899, Contact: Mr Nicholson. Manufacturers of the well known Lake Hydrain self acting water pump requiring no power other than running water.

**CONDRILL AB** Sveavagen 83 113 50 Stockholm Sweden Tel: +46-8-349560, Telex: +12336, Fax: +46-8-316762

**DEMPSTER INDUSTRIES INC** 711 South Sixth St Beatrice NB 68310 USA Tel: +1-402-223-4026, Telex: 701447, Fax: +1-402-228-4389, Contact: Dean Kilgore. Manufacturers of pumps, water pumping windmills, hand pumps, (including the Mark II pump), pump cylinders and pump rods.

**DUBA S A** Kasteeldreef 1 Wetteren 9200 Belgium Tel: +32-91-693496, Fax: +32-91-695752, Contact: Jacques De Blacker. Company specializes in rural water supply. Manufacture and distribution of deepwell handpumps, pumps for solar (photovoltaic) energy, all kinds of irrigation pumps as well as reciprocating pumps for water boosters and small scale distribution.

**FLUXINOS ITALIA SRL** Via Genova 8, 58100 Italy Tel: +56-4451272, Telex: 322458 Ikrane I, Fax: +56-4454237. Revolutionary Pulsa System water oscillation or spring rebound inertia deep well solar and/or hand pumps for rural water supply, microirrigation and animal watering for boreholes from 65mm internal diameter and for water levels of up to 50m. Above-ground direct current motor coupled directly to a 300Wp solar array with novel "Sunflower" three point manual tracking system and total elimination of inverters and battery storage systems. No moving parts below ground

# Naps Solar Powered Water Pumping Systems

Naps-Neste Advanced Power Systems, is one of the leading solar system groups in the world, with offices in all the nordic countries, inclusive Hellas, UK, Austria and Kenya.

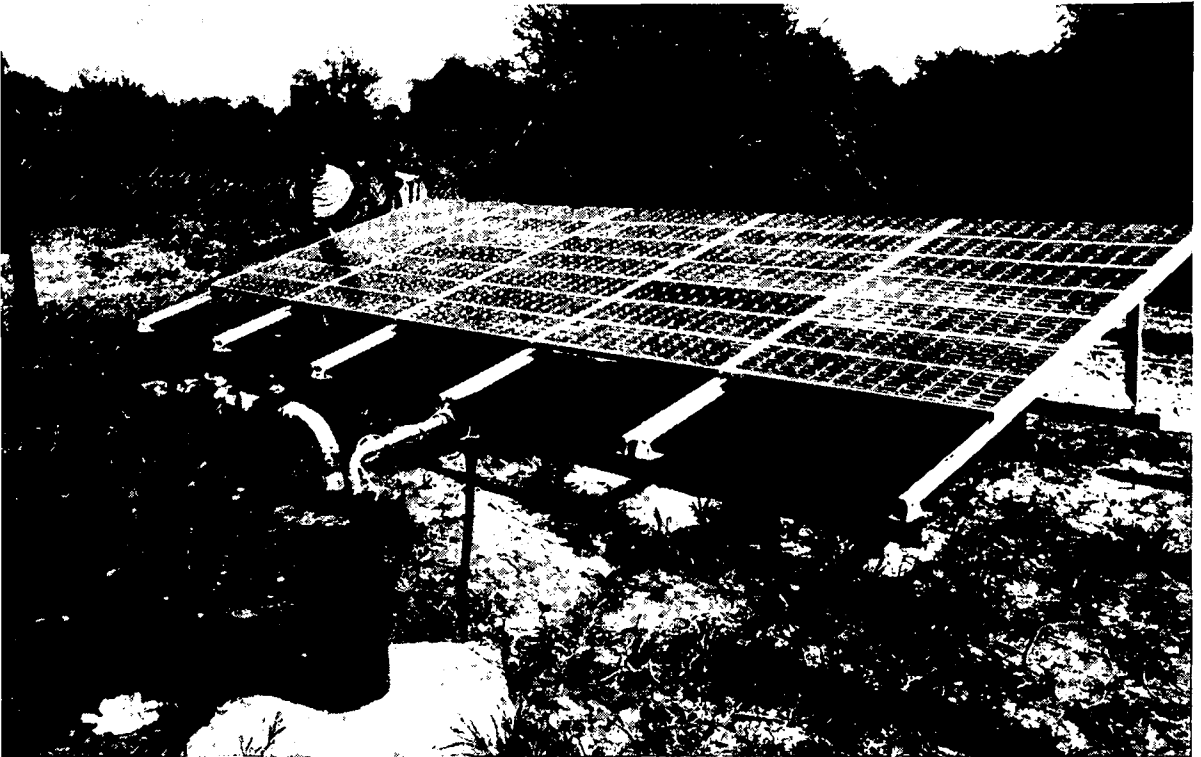

Our product range covers solar powered floating and submersible pumps, which can supply water up to 260 cubic meter a day and lift from a depth of 120 meter.

Naps means quality, reliability and service, and only the best products in the world, approved by Naps, are available in our pumping program.

Personell, with long experience, from projects and installations all over the world, will be at your service.

## **NAPS-FINNLAND**

Ralssitie, SF-01510 Vantaa  
Finland  
Tel.int: +358 0 8 70 16 11  
Fax.int: +358 0 82 63 01

## **NAPS-SWEDEN**

Stensetravegen 3, S-127  
35 Skerholmen, Sweden  
Tel.int: +46 8 97 95 65  
Fax.int: +46 8 46 32 05

## **NAPS-NORWAY**

P.O.Box 22 Grefsen  
N-0409 Oslo 4, Norway  
Tel.int: +47 2 15 61 10  
Fax.int: +47 2 22 02 54

## **NAPS-DENMARK**

Tisetvej 74, DK-8320, Mårslet  
Denmark  
Tel.int: +45 6 92 82 02  
Fax.int: +45 6 92 63 33

## **NAPS-AUSTRIA**

Postfach 10  
A-8055 Graz/Puntigam, Austria  
Tel.int: +43 316 2 91 59 30  
Fax.int: +43 316 29 15 93 42

## **NAPS-GREECE**

P.O.Box 3328  
GR-10210 Athens, Greece  
Tel.int: +30 1 6 84 30 13  
Fax.int: +30 1 6 83 42 90

## **NAPS-UK**

P.O.Box 83, Abingdon, Oxon  
OX14 2TB, England  
Tel.int: +44 235 2 97 49  
Fax.int: +44 235 55 34 50

## **NAPS-KENYA**

P.O.Box 19553, Nairobi  
Kenya  
Tel.int: +254 2 56 10 96  
Fax.int: +254 2 56 10 98

# GRUNDFOS SOLAR SOLVE A DOWN-TO

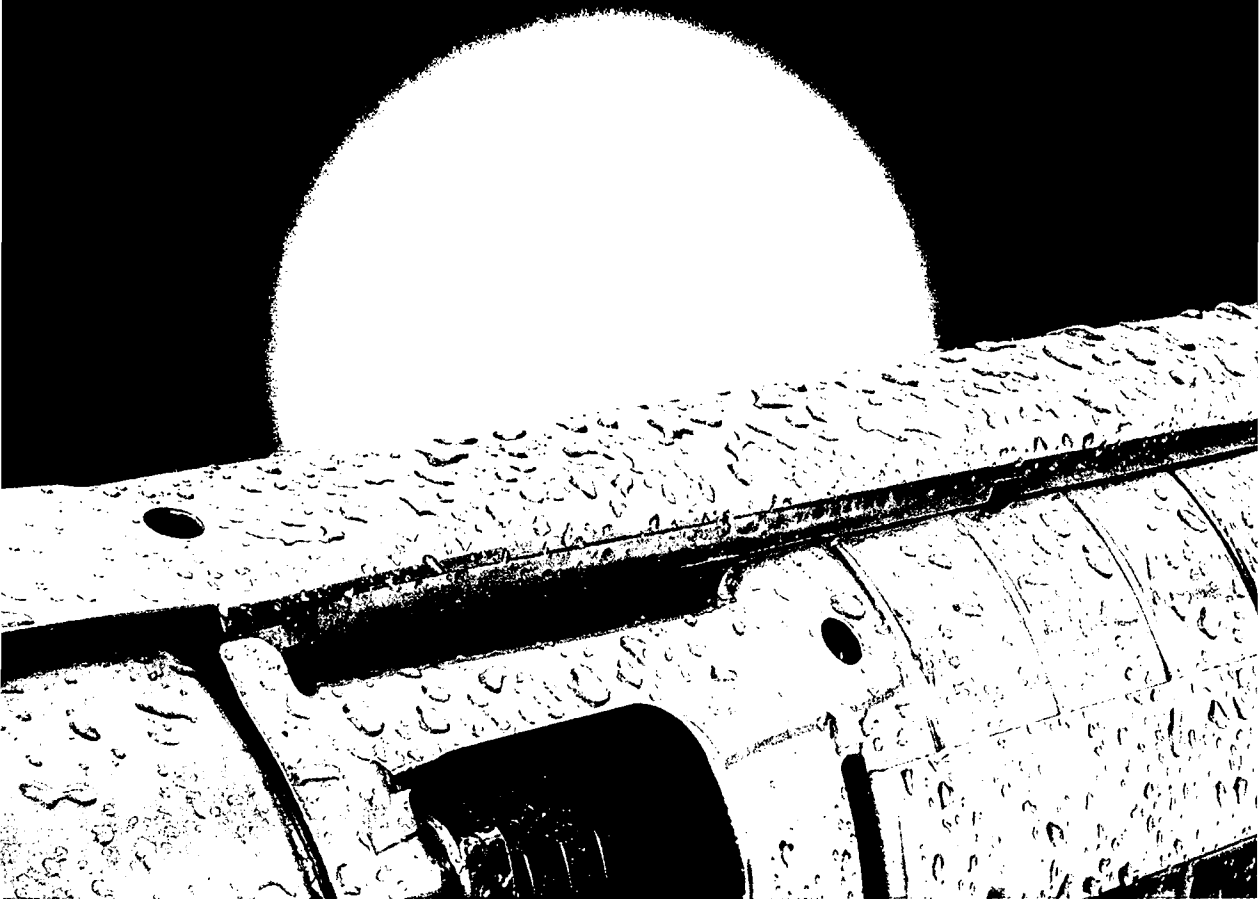

It's a familiar scenario throughout the developing world. No river, no other source of surface water to grow crops

and sustain life. No inexpensive source of electricity, either, to pump water from the depths.

But Grundfos has found a way to help supply water to even the driest areas. Our solar pumping systems can lift

great quantities of water from deep aquifers. For example, during periods of peak radiation, a Grundfos solar system can pump 27 cubic meters of water a day from a depth of 40 meters. The solar power, of course, is free and inexhaustible.

Use of a pumped storage system ensures a consistent water supply, day and night, for human consumption and other essential needs, like small-scale irrigation and livestock watering.

The only moving part in our solar pumping system is the submersible motor/pump unit. All of its exposed parts

# PUMPS -EARTH PROBLEM

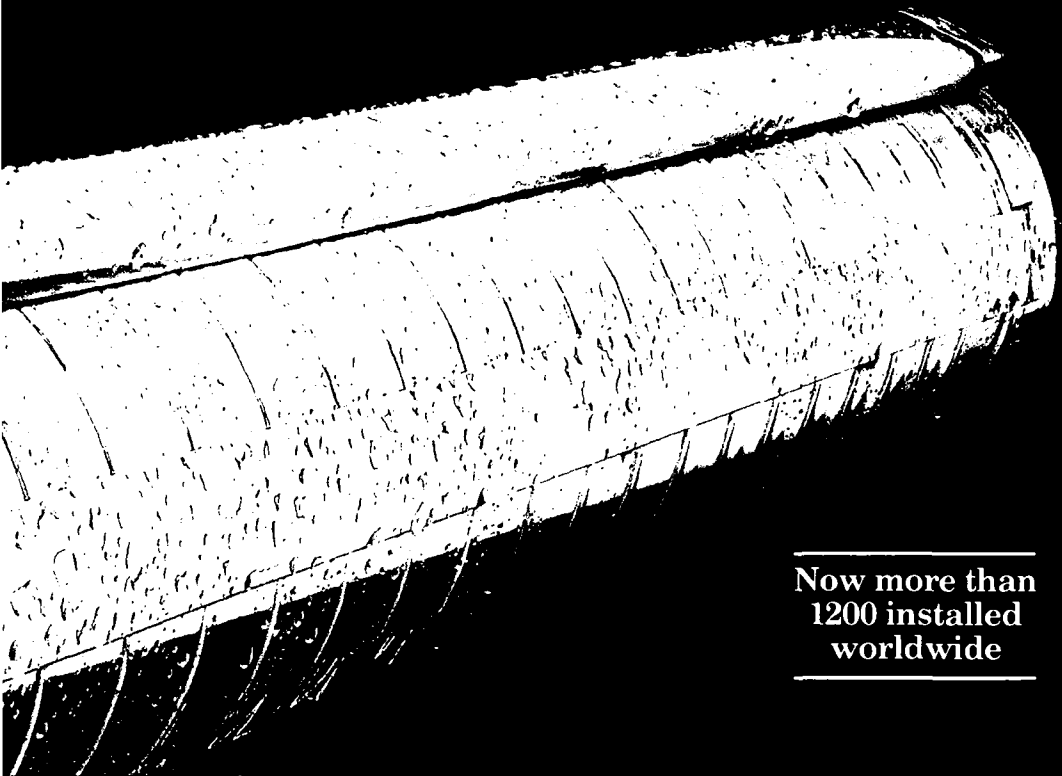

Now more than  
1200 installed  
worldwide

are made of stainless steel, and its reliability has been proven in countless applications.

Nor are there any storage batteries to worry about. The photovoltaic solar panels work tirelessly converting light radiation to electricity.

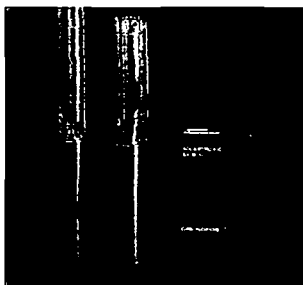

To find out more about harnessing the power of the sun to pump water, see your nearest Grundfos representative.



**GRUNDFOS®**  
You can't name a better pump

*Founded in 1945 in Denmark, Grundfos today has production, sales and service facilities worldwide. The company manufactures a wide range of pumps for heating systems, industrial applications, irrigation plants, and urban and rural water supply.*

# Siemens Solar GmbH

Worldwide within the Siemens Group responsible for photovoltaic systems.



Solar powered irrigation plant Pfalzwerke, Germany.

Solar Modules  
Components  
Systems Engineering  
Plant Technology

Siemens Solar GmbH  
Buchenallee 3  
D-5060 Bergisch Gladbach 1  
FRG

Tel. (022 04) 4 06-0  
Fax (022 04) 4 06-66  
Telex 8 84 891 ssol



## ALTERNATIVE ENERGY PUMPS (WIND, SOLAR)

level, entirely in stainless steel and rust and abrasion resistant, with one single length of flexible polyethylene feed pipe. Vertical and/or horizontal operation. Single level systematic preventive maintenance with itinerant artisan able to handle on his own up to 500 installations. Global long term (10 year cycle) maintenance cost 0.405 US\$ per person per year, with cost per cubic meter of water pumped US\$ 0.0385. All parts including those subject to wear and tear guaranteed against breakdown for 12 months irrespective of the intensity of use. Highly competitive from an economic point of view even for small villages. Hydraulic limit of installation 25 litres/minute.

**FLYGT AB** Box 1309 S-171 25 SOLNA, Sweden. Tel: +46-8-733 6500, Telex: +43887 flygtab s, Fax: +46-8-295816, Contact: Anderz Öhringe. Flygt is the world's leading manufacturer of submersible heavy-duty pumps for contaminated and abrasive liquids. The annual sales for 1988 was approx SEK 2.3 billion. With over 1,250,000 installations in more than 100 countries throughout the world, Flygt submersible products encompass an awesome range of pumps, mixers and hydro turbine generators for small scale hydro electric power stations. The main office is situated in Solna, just outside Stockholm, with manufacturing facilities are in Lindas. Flygt has subsidiaries in 16 countries and 3,400 employees of which 1,500 are in Sweden.

**GRUNDFOS INTERNATIONAL A/S P D** Jensensvej 7 Bjerringbro 8850 Denmark Tel: +45-6-68-14-00, Telex: 60731 gfos dk, Fax: +45-6-68-44-72. The standard Grundfos submersible pumps have proven to be reliable as to both solar and wind powered pumping systems. Today more than 1,000 Grundfos solar pumps are installed in the 3rd world.

**IT DEVELOPMENT TECHNIQUES LTD** Myson House, Railway Terrace Rugby Warwickshire CV21 3HT UK Tel: +44-788-70126. IT Development Techniques is able to offer to suitable licensees the design of the IT windpump - a rugged heavy duty windpump ideal for small scale local manufacture and marketing. The pump is available with 6 or 7.5 metre rotor diameters.

**MONO PUMPS LTD** Cromwell Rd, Bredbury Stockport SK6 2RF UK Tel: +44-61-494-6999, Telex: 668762 MONO G, Fax: +44-61-494-5802. Manufacturers of borehole pumps, hand driven to VLOM design, for rural water supplies - depths to 90 metres and diesel, electric and solar driven, depths to 300 metres, flows to 100 m<sup>3</sup>/hr.

**NAPS - NORWAY** P O Box 22 Rolf Wickströmsvei 15 N-0486 Oslo 4 Grefsen 0409 Norway Tel: +47-2-15-61-10, Telex: 79932 Naps-N, Fax: +42-2-22-00-54. Naps - Neste advanced power system is a part of Neste Corporation, which is the largest industrial enterprise in Finland. Naps provides design, development, engineering and marketing of autonomous advanced power systems including solarpower, windpower and hybridpower systems. Solar - and windpowered water pumping and water purification systems are an important section in the Naps basic need product programme.

**SIEMENS SOLAR GmbH** Buchenallee 3 Bergisch Gladbach 1 D-50660 West Germany Tel: +49-2204-4060, Telex:

884891 sso, Fax: +49-2204-40666. Converting light directly into electric power we use the greatest energy resource we have: the sun. With our solar-powered pumping systems we solve the general problem of the need for water - for irrigation and other general purposes - at low costs in many parts of the world.

## Drilling and Drilling Equipment

**AB SANDVIK ROCK TOOLS** S-811 81 Sandviken, Sweden Tel: +46-26-20000, Telex: +47000 SANDVIK S, Fax: +46-26-275905. AB SANDVIK ROCK TOOLS: World leader in the field of carbide-tipped rockdrilling tools for mining, tunnelling, civil engineering, oil drilling and coalmining.

**ARMSTRONG MACHINE COMPANY** 604 7th Street, Pocahontas, Iowa, 50574, USA Tel: +1-712-335-4131, Fax: +1-712-335-4565. We are a small family business run by Sharon Porter, her husband, Cliff, and daughter Michelle, we have three men in the shop and a secretary in the office. We manufacture spare parts for mud pumps used on drilling rigs. We have the fluid end parts as well as gear end parts. We buy, sell, and rebuild mud pumps.

**ATLAS COPCO ENERGY AB** S-105 23 Stockholm, Sweden Tel: +46-8-7169080, Telex: +14090 copco s, Fax: +46-8-7165975. Atlas Copco Energy manufactures and markets a complete programme for all types of well drilling. - Individual components and complete systems, - Tailor made rigs designed for the customer's specific requirements and systems, - A complete product range from survey to supply or clean water, - All equipment needed for a functioning worksite, - Training as one product - it can be the difference between success or failure in a customer's project.

**CONDRIIL AB** Sveavägen 83 113 50 Stockholm Sweden Tel: +46-8-349560, Telex: +12336, Fax: +46-8-316762.

**DEEPROCK INC** Anderson Road, Opelika, Alabama, 36801, USA Tel: +1-205-749-3377, Telex: +593461, Fax: +1-205-749-5601. DeepRock Manufacturing is a manufacturer of small highly portable water well and borehole drilling equipment. Equipment ranges from a small tripod drilling machine for small residential wells to a mechanical rig with very low maintenance for extremely remote locations to larger more powerful top-head rotary hydraulic drilling rigs. Various configurations provide for rotary mud drilling, rotary air drilling, down the hole hammer drilling and augering. Many models can be either skid, trailer, truck or track mounted.

**FRASTE S.p.A** Zona Industriale, 37054, Nogara, Verona, Italy Tel: +39-44-288300, Telex: +481872, Fax: +39-44-288426. FRASTE S.p.A. production include five basic models of hydraulic rotary drilling rigs for water wells. Power installed ranges from 75hp to 500hp, pull down from 5 tons to 25 tons, torque up to 1650gm. All units are suitable for mud-air drilling and two models for direct/reverse circulation. Large selection of components and accessories is available as well as standard mounting on truck, etc.

Armstrong Machine Company manufactures parts for mud pumps used for drilling oil and water wells. We are a small, family-operated company. When doing business with us, you are talking to the people who can help you with your problems and fill your order!

## Mud Pump Spare Parts

- Liners
- Piston Rubber
- Valves
- Head Gaskets
- Junk Ring
- Rods
- Rod Packing
- Valve Seats
- Valve Cover Gaskets
- Lantern Ring
- Pistons
- Liner Packing
- Valve Inserts
- Valve Springs

## Gear End Parts

- Eccentric Gears
- Bearings
- Cross Head Pins
- Eccentric Bushings
- Pinion Gears
- Cross Head Bushings

## Rebuilt Mud Pumps

- 10 - Gardner-Denver, several sizes
- 6 - Oil Well, several sizes
- 3 - Gaso, several sizes

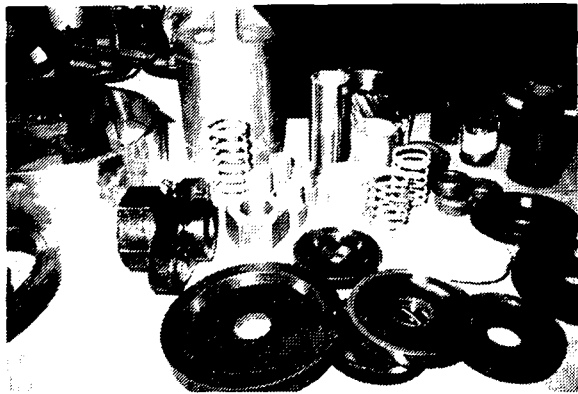
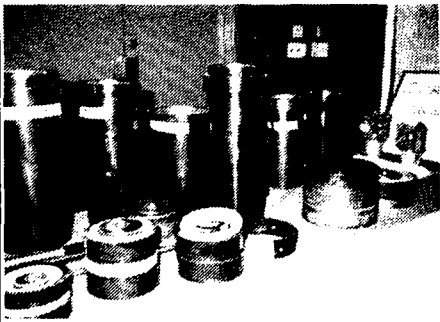

# ARMSTRONG MACHINE COMPANY



302 NW 13th Street  
Pocahontas, Iowa 50574 USA

24-hour telephone: 712-335-4131

24-hour FAX: 712-335-4565

**Atlas Copco**

## All you need for a water project from one supplier.

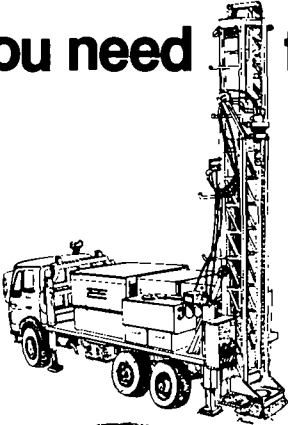

We can offer you a complete product range for water exploitation. Our experience of water projects all over the world assures you of the right equipment for your specific needs.

Choose from a comprehensive range of component based AQUADRILL rigs, with operational depths from 100 to 2,000 meters, and select the exact rig that meets *your* specific requirements.



Whether you need a truck, trailer or skid mounted compressor we can deliver, and for efficient percussive hard rock drilling a range of high performance compressors from 25 Bar to 70 Bar (boosted) is available.

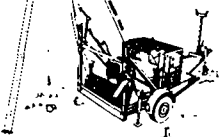

When its necessary to test the yield of existing wells, the AQUATEST unit is ideally suited for test pumping.

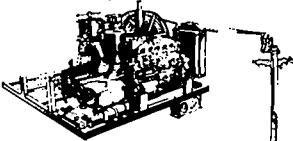

For effective hydraulic refracturing, the AQUASPLIT unit is the answer for dry or low yield wells.

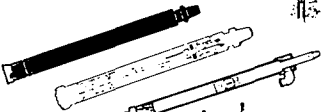

A complete range of percussive and rotary drilling accessories are available.

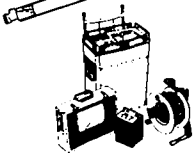

Resistivity, seismic and logging instruments to assist you in the location of areas of expected high yield.

---

# Atlas Copco Energy AB

S-10523 Stockholm, Sweden, Telephone +46 (0)8743 80 00,  
Telex 14090 copco s, Telefax +46 (0)8716 5975

# DRILLING MACHINES

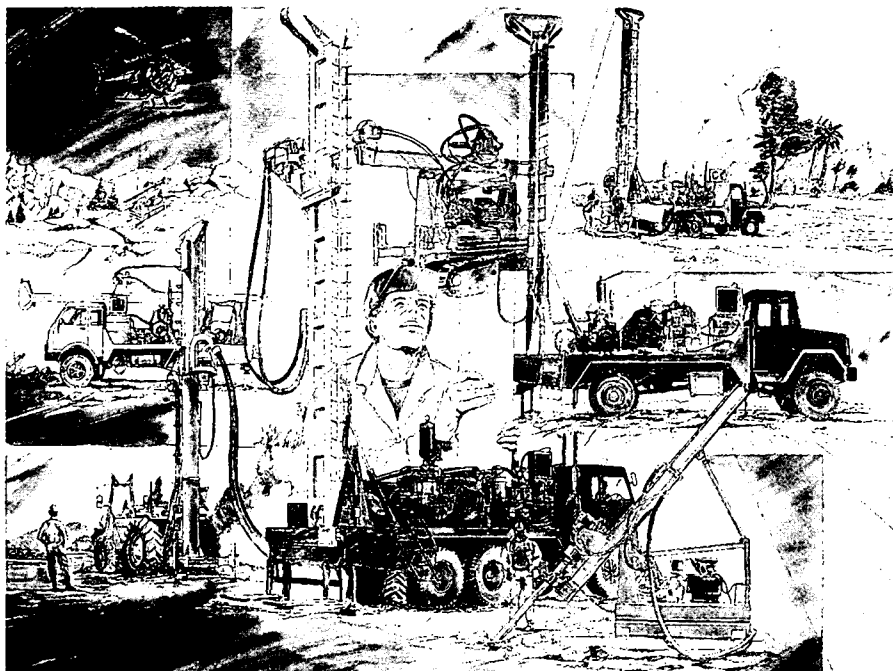

**FRASTE**

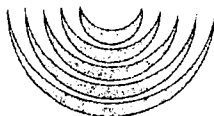

FRASTE's production  
includes mobile water wells drilling rigs  
and drilling machines for soil exploration, coring,  
geotechnical works, civil works  
and special works.  
All FRASTE's drill units are fully hydraulically driven.

**FRASTE S.p.A. - ZONA INDUSTRIALE - 37054 NOGARA (VR) - ITALIA**  
**TEL. 0442/88300 R.A. - TELEX 481872 FRASTE I**  
**TELEFAX 0442-88426**



# Easy to Operate Drilling Machines

## LOW COST

Why use a huge, expensive rig to drill a large diameter hole hundreds of feet deep, then put a hand pump on the well? We offer a range of smaller drilling machines that cost just a fraction of most rigs on the market today. You've probably noticed other manufacturer's machines getting smaller in size, but not in price. Do yourself a favor and check us out.

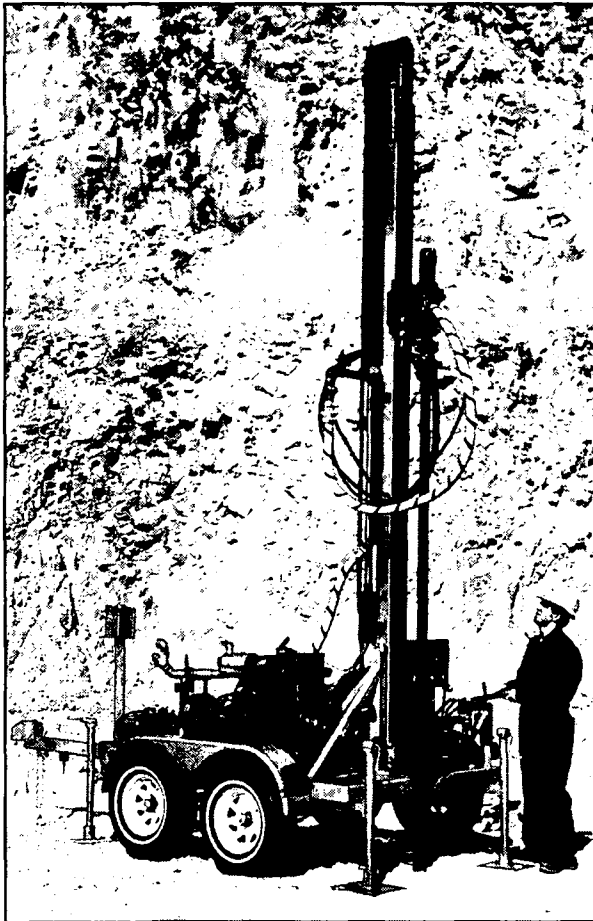

## SIMPLE

Each of our 9 models are designed for fast training of new drill crews. In less than 3 hours, a new operator knows his way around the rig.

## PORTABLE

Your rig can be free-standing or trailer-mounted, skid or truck-mounted. 2 models are self-propelled on a track drive you attach at the drill site. What configuration would best suit your application? We have augering rigs, mud-rotary, and air-rotary for hard rock drilling with down hole hammers.

Write, FAX, or phone for complete information today! And if you give us information about your application, we'll respond with a custom pro-forma quotation.

**DeepRock Manufacturing Company**  
3049 Anderson Road, P.O. Box 1  
Opelika, Alabama 36803-0001 U.S.A.  
Telephone (205) 749-3377  
Telex 593461 DeepRock Opel, FAX (205) 749-5601

© 1989 DeepRock  
**DeepRock**

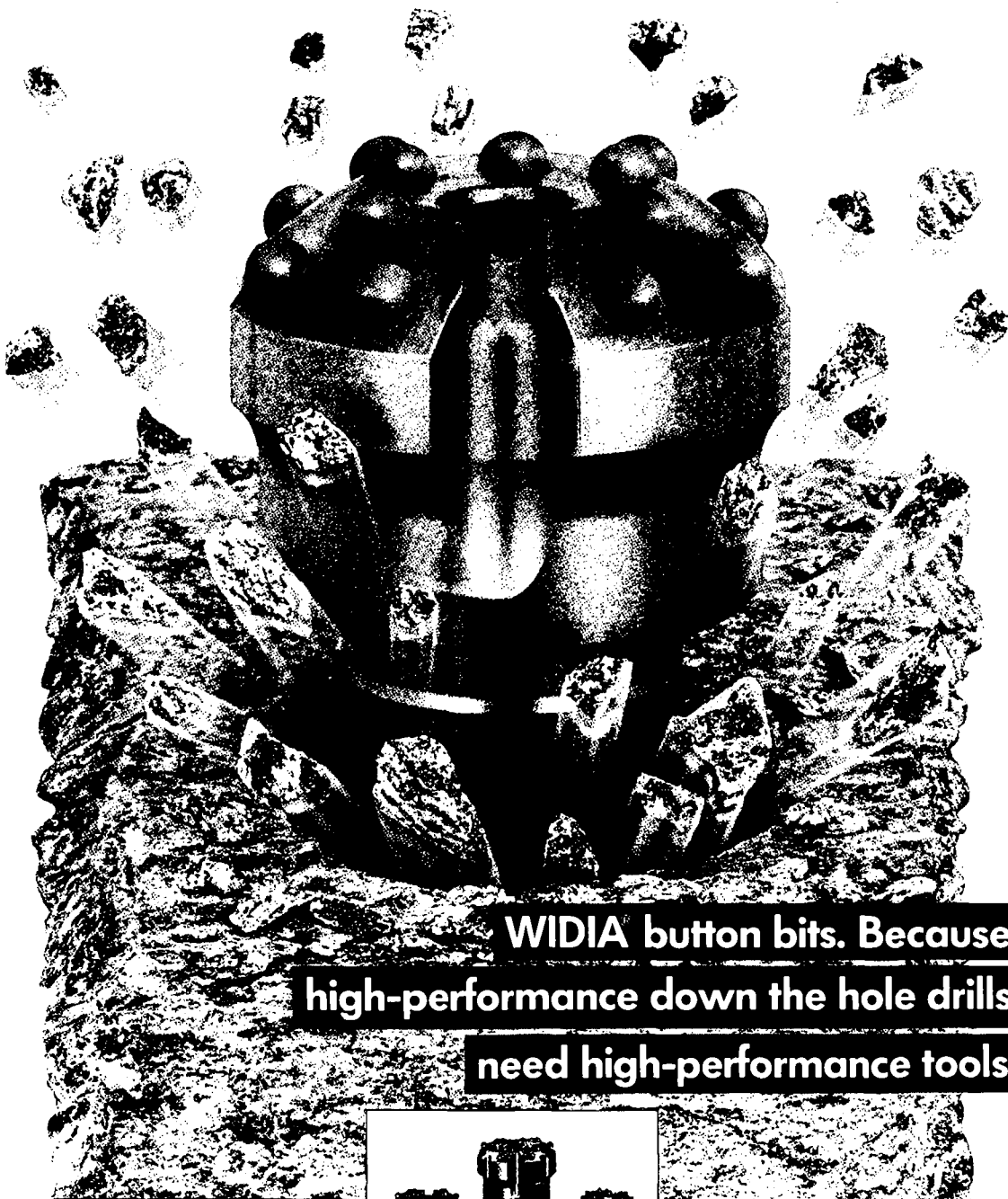

**WIDIA button bits. Because  
high-performance down the hole drills  
need high-performance tools.**

Button bits by KRUPP WIDIA are in successful service around the world. This comprehensive line is thoroughly convincing, with exemplary drilling performance at the end of all types of down the hole drills. Sophisticated engineering, a special-alloy body material and hard-wearing, virtually fracture-proof WIDIA carbide buttons insure maximum tool life even with the roughest use.

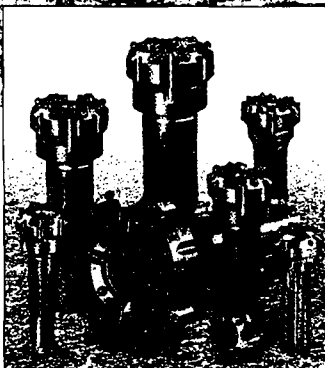

The best thing would be to test the performance of WIDIA button bits for yourself. You can get ahead only with a good tool - and you can be sure of that with KRUPP WIDIA.

KRUPP WIDIA GMBH, Tool Engineering  
P.O. Box 102161, D-4300 Essen 1  
Tel. (02 01) 7 25-0, Telex 8 5718-14  
Telefax (02 01) 7 25-30 35



**KRUPP WIDIA**  
**Tool Engineering**

# THE ANSWERS ARE GETTING BETTER

DROUGHT is dreaded no matter where you live. A drought knows no borders, it can occur in highly industrialised nations such as the UK, as well as in zones of the Earth known for their aridity such as Ethiopia or the Sudan. Even in some places more renowned in world folklore as interminably wet, such as the UK, the rain can fail to come. Some years ago in the southern part of the UK drought was an inconvenience for several weeks. In more scorched areas, even though clouds form, rain may not fall for years. Here drought is a matter of life or death.

No matter where it may occur, drought is a most poignant reminder of our complete dependence on water. Water is essential for the continuation of even the simplest forms of life; survival without it is measured in hours. The human race will cease to run without this simple chemical combination of oxygen and hydrogen, for not only do our bodies need constant supplies but so also does the food we eat.

Answers to the questions of cause and planned prevention of these natural disasters still elude the researchers and meteorologists in this technological age. Mankind can and does apply the knowledge it has and utilizes the best of technology to minimize the impact and effect on the areas most in need.

It was known to the most primitive man that water was always beneath his feet. All he had to do was dig to find it; sometimes only shallow pits had to be made, at other times deep shafts were sunk to seek out the available water. It is in the science of prospecting and shaft or borehole sinking that the help of the engineer and technologist can best be enlisted to produce the maximum effect.

By cruel fate, the areas least able to confront the drought nightmare with skills and engineering are those with the most serious intrinsic problem. Ingersoll-Rand, in its search for manageable, affordable technology applicable to these less sophisticated areas, has spent many man hours in development, and even more in field evaluation of their Reska series of water well drilling rigs and its peripheral accessories.

Reska division's research in the afflicted areas indicated almost all needs for a waterwell could be met by a borehole of 8 in (20 cm) in diameter or less and usually a maximum depth of 1500 ft (470 m) sufficed. Other factors which had to be worked into the rig concept and its design seemed to contradict each other; it had to give low purchase, running and operations costs; be reliable, field maintainable, usable by low skill crews, highly productive, adaptable, be available for local chassis mounting and so forth.

Eventually the series R25 and R32 rigs were finalised by the Ingersoll-Rand designers. This

new concept offered official bodies such as the UN and many African water authorities wide spectrum flexibility. These machines are now making a positive contribution to the eradication of the blight of drought in remote and rural areas.

Options and standard features alike make the R25 and 32 a unique machine in its class; swing out rotary heads enable rapid use and placement of longer or locally produced casings. The Reska, available for track or truck mounting, has a 2 in swivel on the rotary head which enables mud or air drilling modes; the option to use existing mud pumps and compressors or specify self-contained on-board units, is typical of the rig's flexibility.

Reska units are all hydraulic in operation, air only being used for flushing or DH hammer drive, the key hydraulic controls for bit pressure and rotation speed being positioned for ease of use by the hole. All controls are conceived for rapid assimilation and ease of operator training. For the waterless communities each extra hole produced per day by this rig means life, if not true luxury. Higher productivity rates are achieved through attention to details, for example speed of drill pipe addition or tripping out of hole is helped by the all-hydraulic fork chuck. Items such as this, usually found on the larger rigs, also make for more drilling time on these most compact and simple machines.

An experienced driller will tell you that remote areas in the Sudan or Mozambique are not places where he would choose to use an underengineered unit; typical of Ingersoll-Rand, Reska engineering is of a high standard with more than a good helping of ruggedness. This approach has been adopted to reduce the overall costs of ownership.

There are lower cost rigs around, Ingersoll-Rand would not deny that fact, but when you add up the cost of buying the rig in the first place, the reduced maintenance input, plus the operating costs, which in the case of Reska may well be dramatically lower than other machines, the results would indicate a lower cost per hole per year. In the overall cost of drilling, life expectancy of equipment should not be overlooked, since every extra year of life offers, in the true sense, a real discount off the purchase price. In a well built rig, such as the Reska R25 or 32, this can easily equal 10 or 20 per cent and in stretched economies every dollar saved produces more waterwells.

Ingersoll-Rand recognises that to compromise on quality is false economy in the long run. Ingersoll-Rand believes that its Reska rigs, built with the high levels of integrity as they are, are as positive a step towards removing the tragedy of drought that today's limited technology can, in reality, offer. Who knows which tomorrow will eventually offer a permanent solution to drought, one of today's most pressing problems. □

## DRILLING AND DRILLING EQUIPMENT

**GRUNDFOS INTERNATIONAL A/S** P D Jensensvej 7 Bjerringbro 8850 Denmark Tel: +45-6-68-14-00, Telex: 60731 gfos dk, Fax: +45-6-68-44-72. The construction of Grundfos stainless steel deep well pumps, turbines and submersibles types BP and SP make these pumps very suitable to well drillers for test pumping.

**INGERSOLL-RAND COMPANY** 200 Chestnut Ridge Road, Woodcliffe Lake, New Jersey 07576 USA Tel: +1-201-573-0123, Fax: +1-201-573-3448. Ingersoll-Rand Company, a leader in supplying drilling equipment, parts and accessories to the worldwide waterwell drilling industry, has more than 500 manufacturing, sales and service locations throughout the world. The company offers the broadest range of waterwell drilling equipment available, including rotary drill rigs, downhole drills and bits. Specialised parts distribution and service departments ensure unmatched performance throughout the life of the equipment.

**KRÜPP WIDIA GmbH** Münchener Strabe 90 D-4300 Essen I West Germany Tel: +49-201-725-0, Telex: 85718-14, Fax: +49-201-725-3035. Widia equipment for precision drilling include: button bits for down the hole drills, rotary bits, point attack picks, stoneworking tools and tips and buttons of Widia hardmetal.

**PEETERS B V B A G** Vandenhevelstraat 131 Ramsel-Herselt 3140 Belgium Tel: +32-16-562026, Telex: 21-874, Fax: +32-16-562025. In less than 30 years, PEETERS became one of the leading water well drillers in Belgium. In our rather small country, we have to face an enormous variation in geological structure of the underground. From this experience, PEETERS has developed a range of drilling equipment.

**SCHRAMM INC** 800 F Virginia Avenue West Chester PA 19380 USA Tel: +1-215-696-2500, Telex: 83-5455, Fax: +1-215-696-6950. Schramm Inc, a leading manufacturer of drilling rigs and related equipment, has been serving the drilling industry since 1955. We offer a complete line of truck mounted drill rigs designed for water well drilling. Schramm Inc manufactures six models of top head drive rotadrills for air rotary, DTH, mud rotary or combination air/mud drilling to 24 inch diameter and 5,000 foot depth.

**SOILMEC** Via Dismano 5819, 47023, Cesena, Italy Tel: +39-54-7331933, Telex: +550104, Fax: +39-54-7319204. Soilmec of Trevigroup, is the company manufacturing equipment for the production of underground resources. It develops standard projects and new ideas mainly looking on the operational problems that day after day contractor faces. The result of this continual research is a product of great reliability, perfectly suited to the techniques required for the work and constructed with modern technology.

**STROJEXPORT PTC** Commercial group 69, Vaclavske nam 56, Prague 1, Czechoslovakia Tel: +42-2-131, Telex: +122604, Fax: +42-2-269569. The export of geological drilling services by Strojexport, Foreign Trade Corporation, is carried out by five research institutes and nine enterprises with over twenty thousand specialists in the following fields: Basic geological survey, Prospecting for ore deposits, Prospection for coal, crude oil and natural gas deposits, Prospection for non-metallic

deposits, Engineering-geology survey, Hydrogeology, Applied geophysics, Geochemical prospection, Laboratory methods and technological research. Please contact direct for further information.

**TAMPELLA LTD TAMROCK** PO Box 279, 33101 Tampere, Finland Tel: +358-31-2414111, Fax: +358-31-132152. Tamrock Driteltech manufactures and markets drills for water well drilling, mineral exploration, geothermal well drilling, and shallow oil and gas drilling. Each of these operations have specific drill rig requirements based on hole size and hole depth and Tamrock has the right drill for almost any applications. The company is based in Alachua, Florida with sales and service locations around the world.

**TORQUATO DRILLING ACCESSORIES** 215 Susquehann Street, Old Forge, Pennsylvania 18518 USA Tel: +1-717-457-8565, Telex: +467061 TORQUATO CI, Fax: +1-717-457-8595. Torquato Drilling Accessories supplies a complete line of drilling bits for Water Well Drilling including Rotary Bits, DTH Bits, Carbide Drag Bits and Diamond Bits. Our line of high quality products is used by drilling contractors worldwide for ground water development projects as well as for exploration programs.

**TUBAFOR INTERNATIONAL** 39 Champs Elysees, Paris, 75008, France Tel: +33-1-42259342, Telex: +280888, Fax: +33-1-45638408. Tools, Rock Bits, Down the hole hammers and bits, Muds, Foam, Testing Equipment.

**WEAVER AND HURT** Station Lane, Old Whittington, Chesterfield, Derbyshire S41 9QS UK Tel: +44-246-450608, Telex: +547020, Fax: +44-246-454621. Manufacturers of down-the-hole hammer drills in both valued and valueless versions from 1" to 8" diameter. Reverse Circulation hammers for uncontaminated sample recovery. An overburden drilling system which is simple to use, reliable and cost effective. An extensive range of Button Bits to suit all types of D.T.H. hammers and a wide range of accessories. Service throughout the world.

**WIRTH GmbH** Maschinen-und Bohrgerate-Fabrik, PO Box 1327, Kolner Str. 71-78, 5140 Erkelenz 1, Federal Republic of Germany Tel: +49-243-1830, Telex: +8329836, Fax: +49-243-183267. WIRTH manufacture all hydraulic water well drilling rigs mounted on truck or trailer including all drilling equipment for air lift circulation, rotary direct circulation, down the hole drilling. Please contact direct for further information.

DRILLING WORLD  
**WATER**

Entries ending in WT are taken from Water Technology Magazine's Planning and Purchasing Handbook. The subscription address is Water Technology Magazine, 13 Century Hill Dr, Latham, NY 12110, USA. Telephone (518) 783 1281. Entries ending in IAWPRC are reproduced from the 1987 88 Yearbook of the International Association on Water Pollution Research & Control (IAWPRC) with the Association's consent. IAWPRC, 1 Queen Anne's Gate, London SW1H 9BT, England





# PEETERS

*PEETERS is a leading drilling company in BELGIUM,  
with over 30 years experience in water-drilling.*

*In addition to being a **DRILLING CONTRACTOR**  
PEETERS has the same high reputation as a **MANUFACTURER** of water well drilling rigs.  
All PEETERS rigs are **DESIGNED BY ITS OWN ENGINEERING STAFF**,  
based on extensive field experience in Belgium and abroad.*

*As an all-round company, PEETERS is able to offer  
**HIGH QUALITY DRILLING RIGS AND EQUIPMENT**,  
together with **EXTENSIVE TRAINING** for your drilling operators  
and technical assistance or **FOLLOW-UP**.*

*PEETERS' aims are **QUALITY**,  
On-the-spot Training · Transfer of Know-how and Technology · Cooperation and Partnership.  
Together with Governments, Development Organisations (N.G.O.) and International Agencies,  
PEETERS intends to make every effort to ensure  
the success of the WATER decade.*

**G. VANDENHEUVELSTRAAT 131, B-3140 RAMSEL-HERSELT - BELGIUM**

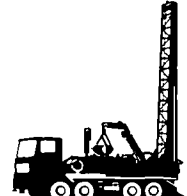
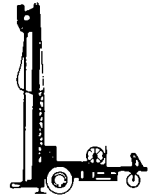
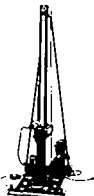
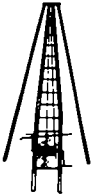

*PEETERS' rigs  
are operating in*

**BELGIUM  
GREECE  
MOROCCO  
NIGER  
SAUDI ARABIA  
ZAIRE**

**PEETERS  
TELEPHONE  
016 / 56.20.26**

**TELEX  
21874**

**TELEFAX  
016 / 56.20.25**

**BELGIUM**

Sandvik Coromant rock drilling tools

# TUBEX. The easiest way through overburden.

## Lined, non-collapsing holes anywhere you want them

If you still think collapsing holes make overburden drilling a complex stage of your operation, then it's time to change to TUBEX – the simplest and most reliable way to line your holes through gravel, boulders, clay, silt, sand and any type of overburden mixtures.

The TUBEX bit – with its eccentric reamer – allows you to continuously stabilize your overburden holes with low-cost casing tubes while simultaneously drilling the hole deeper. Once you've experienced the TUBEX method in action, you'll be fully convinced of its unique potential.

Regardless of where and how you intend to use it.

## Suits most rigs and hammers

TUBEX equipment for further drilling of 76 mm to 215 mm holes is available for virtually all types of drill rigs, and it features guide devices and shank adapters for most makes of top and DTH-hammers.

The TUBEX method has already gained worldwide approval for applications in anchoring, grouting, mineral prospecting and water-well drilling. Through depths of 100 metres, and more, if required.

TUBEX has been equally well acclaimed in horizontal applications such as pipe and cable laying through embankments.

## Marketed worldwide exclusively by Sandvik

TUBEX equipment is marketed and serviced exclusively by the worldwide Sandvik organization, with

some 160 Sandvik companies in 50 countries and representatives in 50 others.

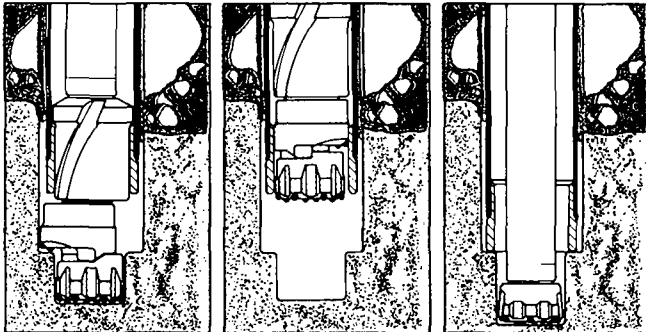

1. The TUBEX method is based on a pilot bit and an eccentric reamer. The reamer makes a hole sufficiently large for a casing tube to slide down behind the reamer. Cuttings are flushed upwards inside the casing.
2. When drilling has reached a few feet into bedrock, the drill string is rotated in the opposite direction, whereby the reamer is folded in. The drill string with the TUBEX bit is then taken up inside the casing tubes.
3. Feed force from the rig is diverted to the casing tube to push it into its final position. After changing to a conventional DTH bit, the drill string is lowered into the casing and drilling can resume.

**SANDVIK**  
Rock Tools

AB Sandvik Rock Tools S-811 81 Sandviken Sweden  
Tel +46 26 26 20 00 Telex 47000 SANDVIK S  
memo=sertlx Telefax +46 26 27 59 05

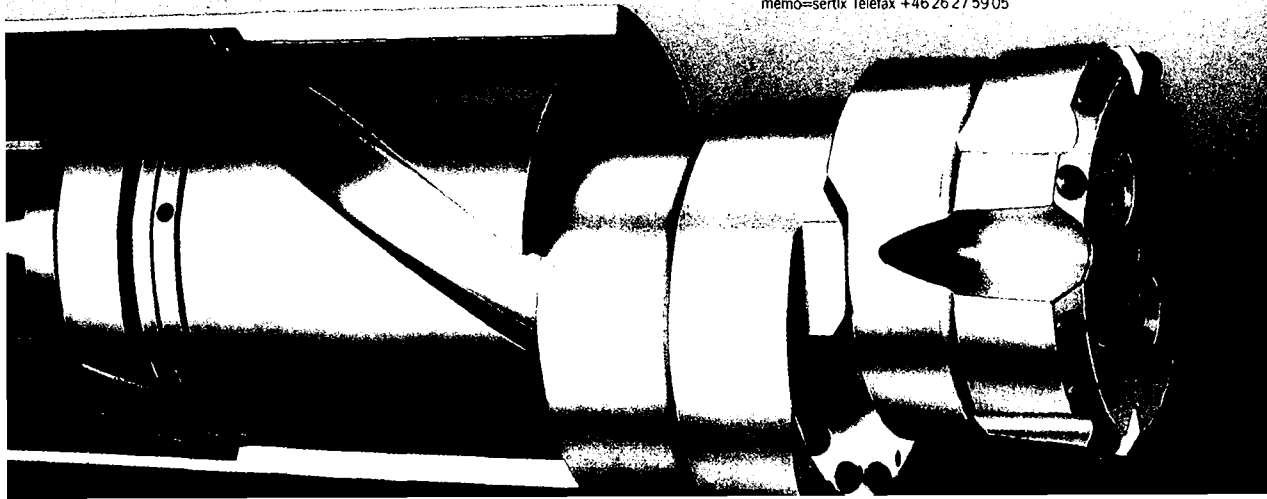



# SCHRAMM ROTADRILLS

*Helping Develop Water Resources Worldwide*

With over 30 years of field proven performance, Schramm, Inc. top head drive Rotadrills are helping produce water in 43 countries around the world.

For international customers, the T660H Rotadrill provides a wide range of capabilities in a powerful, yet maneuverable, package. Subframe design allows for mounting on locally built and serviced trucks. High ambient cooling and heavy duty components provide for reliability in the most remote areas and difficult drilling conditions.

Schramm, Inc. manufactures an extensive line of air and mud circulation drill rigs with capacities up to 1500 meters (500 ft.) depth and 500 mm (20 in.) diameter hole size. Schramm products are sold and serviced by a worldwide network of qualified distributors.

## THE T660H ROTADRILL

- 900 cfm @ 350 psi (25.4 m<sup>3</sup>/min. @ 24.6 kg/cm<sup>2</sup>)
- Turbocharged and aftercooled deck engine
- 9 meter (30 ft.) top head travel
- 18,000 kg, (40,000 lb.) hoisting capacity



## SCHRAMM, INC.

800 E. Virginia Ave.  
West Chester, PA 19380 — U.S.A.  
Phone: (215) 696-2500  
Fax: (215) 696-6950  
Easylink: 62764336  
Telex: 83-5455

# STROJEXPORT PRAGUE AND THE WORLD OF GEOTHERMAL ENERGY

IN DECEMBER last year Strojexport finished drilling works of a Geothermal project in Lund, near the city of Malmö in southern Sweden.

The contract between the Swedish company ASEA STAL Geonergy Lund and STROJEXPORT Prague was signed on 18th July 1985 and the drilling works started on 31st August 1985 on the site of Hansagarden. It was necessary to arrange the transport of drilling rig and equipment weighing in total about 460 tons.

The project for applying geothermal energy for district heating of the city of Lund resulted from the analysis and evaluation of geothermal resources in the south of the Scandinavian massif. The project started in 1980-81, when Lundsenergieverk together with the City council of Lund marked out as a main target the decrease of crude oil as a main source for the district heating of Lund.

The first stage of the Geothermal project was completed in 1983, when the first two wells had been drilled (one production and one injection). After finishing the second stage in 1984 with two production and two injection wells, the whole system was connected to a heat pump with an output of 20MW.

In order to achieve full efficiency with the geothermal energy system, the main supplier – ASEA STAL Geonergy Lund, in co-operation with the specialists from the Institute of Technology in Lund, decided to apply for the first time in the world the method applied to directional wells with an angle of 40 to 45 degrees, in drilling shallow wells of around 750 metres.

Strojexport Prague's offer for the particular project, which has been prepared together with the Czechoslovak drilling company Moravské naftové doly Hodonín, succeeded against those of several western companies like Preussag, DST, thanks to its excellent drilling equipment (mobile rig IDECO – SBS – DIR 706 with the capacity of 115 hook load) and precise preparation.

It is proud to state, that the third stage of the Geothermal project has been fulfilled in proposed time schedule in 110 days after the commencement of drilling works.

Two production wells on the site Hansagarden (one straight and one deviated with an angle of 23 degrees), and three injection wells on the site of Värpinge (one straight and two deviated wells with angles of 41 and 45 degrees) have been drilled. This difficult task has been covered by Strojexport's professional, skilled staff.

The project is a tremendous success. It is the first and only project in the whole world based on low temperature geothermal resources including large heat pumps technology. After installing the second heat pump in March 1986 with the output of 28MW, the consumption of crude oil decreased together from 100 per cent in 1980 to 15 per cent in 1986. Geothermal energy now contributes 40 per cent of the total energy demand for the city of Lund. □

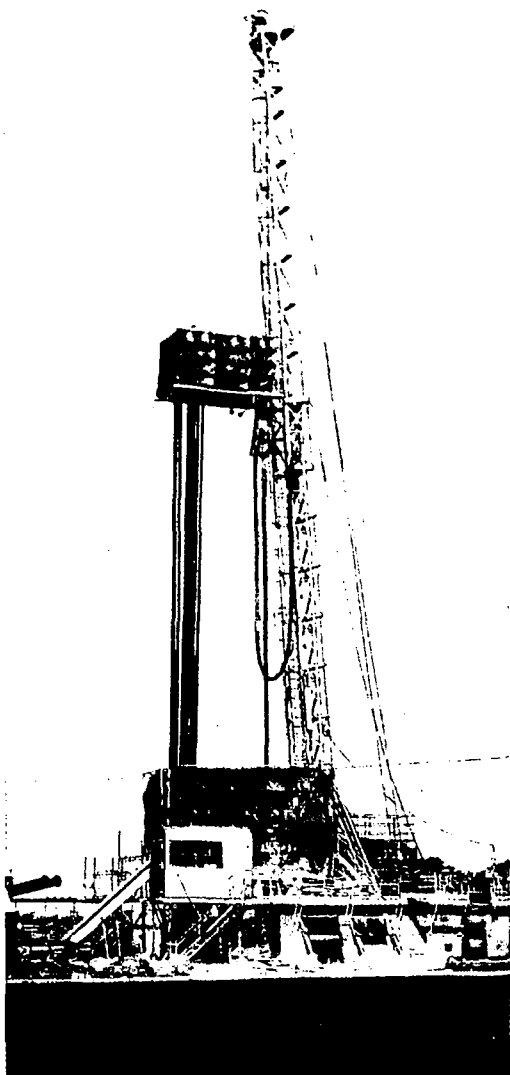

*Drilling works of geothermal project in Lund, Sweden.*

# WATER IS LIFE



**Contact STROJEXPORT for any water project!**

With years of field proven performance, Strojexport is helping to find and produce water in many countries around the World.

For international customers we provide a full range of services needed to complete any water supply scheme on a turn-key basis:

- ☆ Exploration and Appraisal
- ☆ Development drilling
- ☆ Well testing
- ☆ Pipe-lines and Irrigation systems



**STROJEXPORT**  
PRAHA - CZECHOSLOVAKIA

Strojexport FTC, Václavské nám.56, 113 26 Praha 1, Czechoslovakia,  
Phone: 2131, Telex: 122604, Telefax: 4222323084.

*Mechanical and hydraulic rotary rigs  
expressly made to produce drilling  
water from shallow and deep formations.*

---

**From 10 to 70 tons  
Rigs to drill  
on any ground  
with any drilling  
system.**



Fast positioning on any ground.  
Powered either by deck engine or  
by truck engine. Has mounted on

chassis mud pump for jet bit drilling  
and air compressor for DTH ham-  
mer drilling.

***Highly specialized equipment for all  
foundation engineering technologies***

**SOILMEC**



Via Dismano, 5819  
47023 CESENA - ITALY  
Tel. 0547-319111/331933  
Telefax 0547-319204  
Tx 550104 SMEC I

# All hydraulic water well drilling rigs

WIRTH multitechnique, top drive drilling rigs  
for drilling by ● air lift reverse circulation

- rotary direct circulation
- down the hole drilling

mounted on truck or trailer including all drilling  
equipment

Drilling rigs B-serie: hook load 3200-125000 daN  
torque 275-7400 daNm

Please ask for leaflet B 147 "drilling rigs"



# WIRTH

WIRTH Maschinen- und Bohrgeräte-Fabrik GmbH · ☒ 13 27/13 29 · D-5140 Erkelenz · ☎ (02431) 830 · ☒ 8 329 860

# **Bulroc**

## **Down-the-hole equipment**

The range of Bulroc hammer drills are designed to give high performance, low cost drilling and are manufactured in both standard and valveless versions.

A wide range of down-the-hole accessories supplement the Bulroc hammers and spares are always available "off the shelf" for minimum downtime, maximum efficiency.

For expert advice, assured service, contact Weaver and Hurt, the Down-the-Hole drilling equipment specialists.

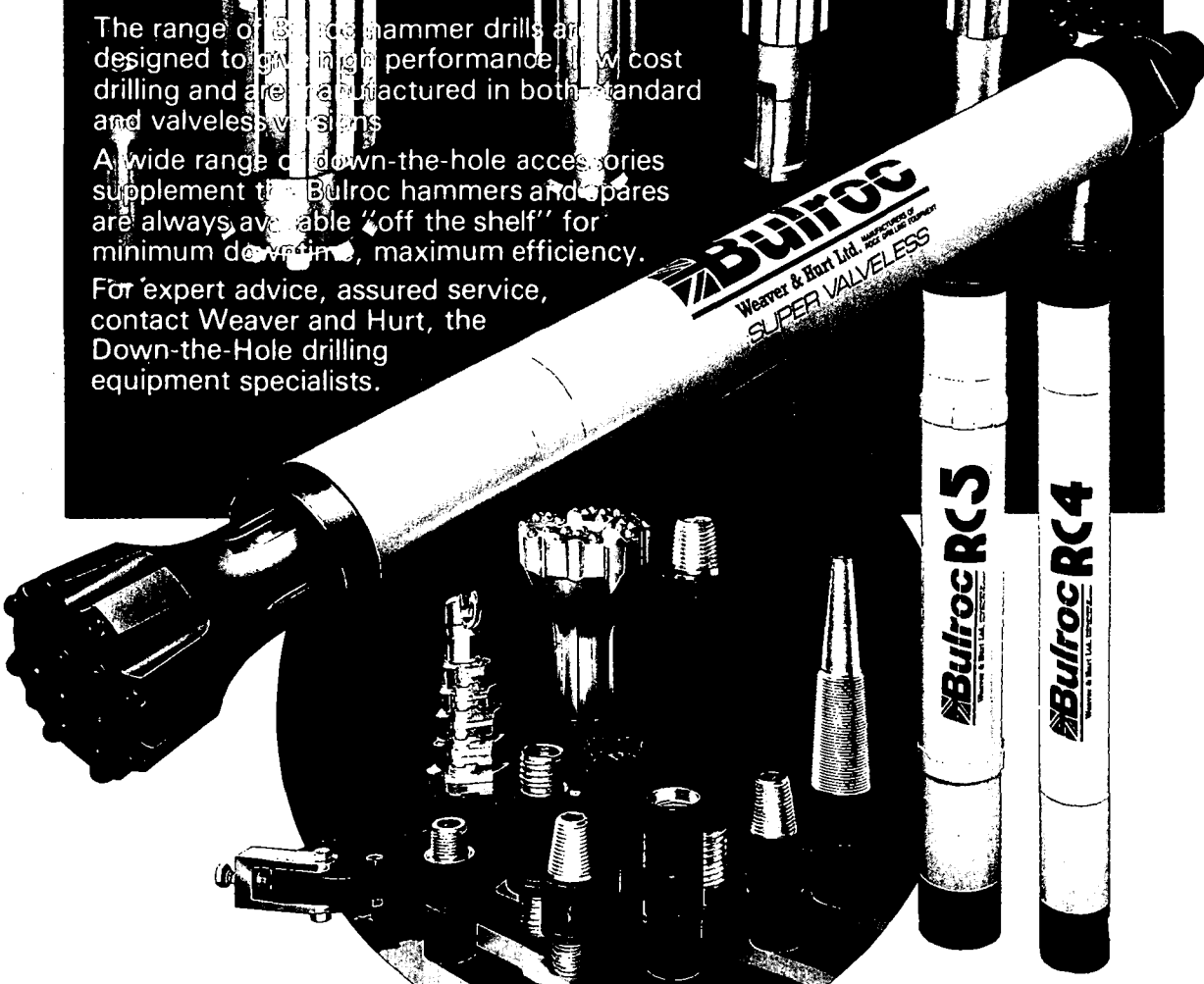

### **WEAVER & HURT LTD.**

Station Lane, Old Whittington, Chesterfield, Derbyshire S41 9QX, England.  
Tel: (0246) 450608 (3 lines) Telex: 547020 WEAVRTG Fax: (0246) 454621





**Water Distribution  
& Sewerage**

# PUBLIC WATER SUPPLY FOR URBAN SLUMS

by

Andrew Cotton, WEDC

**The objective of water supply for low-income urban communities is to provide an accessible, reliable water supply of sufficient quantity and quality.**

## Aims and Objectives

The provision of an adequate water supply has long been understood to be a basic human need which relates to the health and well being of a community. Traditional sources of water in urban areas provide an inadequate quantity which is highly polluted and the only access to water of reasonable quality may be through purchasing at inflated prices from water vendors or the houses of private individuals.

It is important to consider the likely benefits of water supply. These can be defined as:

1. Health: there will be certain minimum or primary levels of service to ensure adequate standards of public health. This can be viewed as a basic need for which the capital cost is the responsibility of the government or municipal authority. The operation and maintenance costs should be recovered.

2. Convenience: any level of service beyond the primary level serves the convenience of the user. It is reasonable that the user and not the government pays the full economic cost for these benefits.

By definition, most of the inhabitants of urban slums are in the lowest income group, and the planning of the water supply must reflect the provision of primary level service while giving individual users the opportunity to pay for higher levels of service if they wish.

There are several issues which impinge on the benefits to be gained from improved water supply.

*Health Impact* — it is important to realise that there is a complex relationship between the environmental conditions in which people live, their awareness of basic hygiene practices and their health. Water is but

one component.

*Water Quantity* — people need water principally for drinking, cooking, bathing and laundry. The bodily requirement for an adult is normally less than eight litres per day. The presence of many common illnesses such as diarrhoeas, dysenteries, enteric fevers, infectious skin and eye diseases and certain louse-borne infections can be reduced by improvements in personal and domestic hygiene. The availability of a sufficient quantity of water for bathing and laundry is thus of great importance, whereas the quality of this water is

*Women in India maintaining a hand pump*



## WATER DISTRIBUTION & SEWERAGE

*Traditional water source -  
high polluted*

not especially important.

**Water Quality** — while the provision of bacteriologically pure water is a desirable long term goal, it is not a prerequisite for improving existing supplies. For example, there would be little point shutting off public standposts because the water suffered low level bacterial contamination if people were then driven to use a filthy stream or canal.

**Reliability** — the water resources and distribution systems of many towns and cities are inadequate to meet the required demand. One result of this is water rationing and intermittent supplies. Household storage of water is a means used by many people to overcome the problems of an erratic water supply; water is collected whenever the supply is on and stored in tanks or smaller containers for subsequent use.

### **Case Study**

The case study used to illustrate some of these issues is at Amba Nagar in Hyderabad, India, which is one of the slums to be improved through the Slum Improvement Programme of the Municipal Corporation of Hyderabad, funded by the Overseas Development Administration of the UK. There are approximately 300 families in the slum.

There is a serious regional shortage of water in the city of Hyderabad and water rationing is a feature of its life. To obtain the optimum use of water from the city distribution system requires an individual house connection with considerable storage capacity in the dwelling. This is not affordable by the inhabitants of Amba Nagar, although "informal" storage is practiced by most households using any container they can lay their hands on.

The vast majority of low income people are unlikely to be able to afford a water supply, be it a tap or a well, on their property; they will collect their water from public supply points

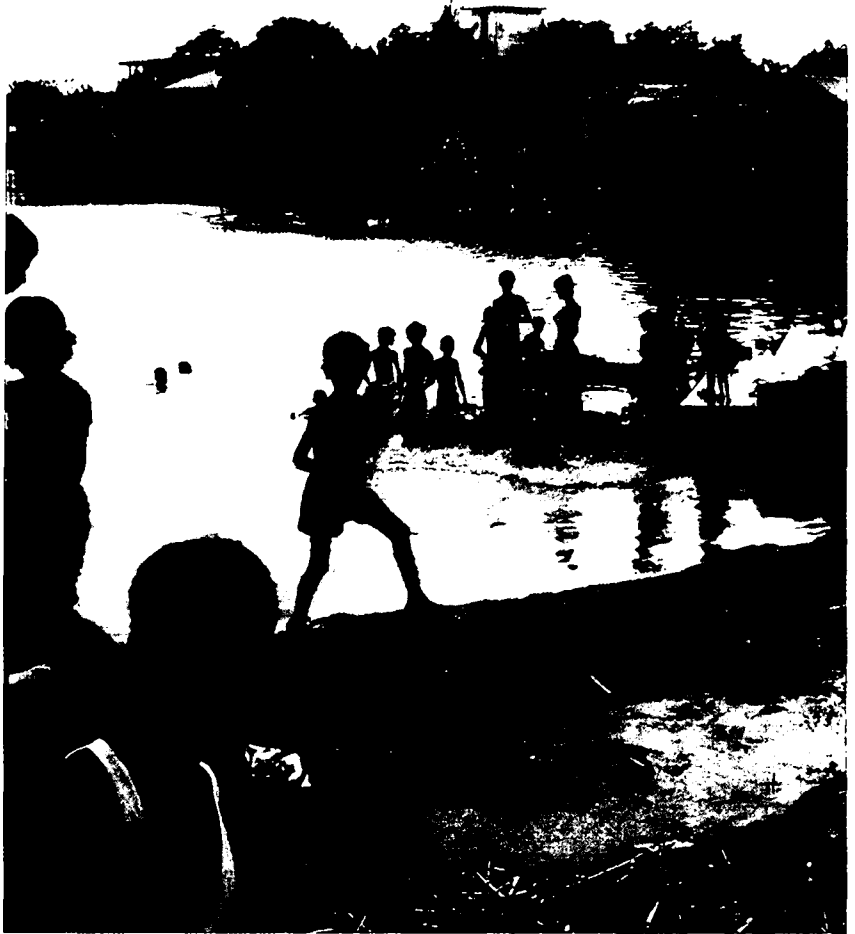

To provide a reasonable water supply, it is necessary to investigate all possible sources and from the options available design a supply system which will meet their basic needs. There are several options available in Amba Nagar.

**Traditional Sources** — in the worst cases, people may be using surface water sources such as nearby ponds and ditches for washing and bathing. These sources are likely to be highly contaminated and should be abandoned at all costs.

**Piped Water Supply** — extensions to the distribution system could be made in order to provide additional standposts. However, because of water shortages, standposts cannot supply all of the requirements. On average, water is supplied for about two hours per day at relatively low pressure, which yields a flow of about 0.25 litre per second from a tap. Assuming a water demand

of 50 litres per person per day (for all purposes), this would imply that one tap was needed for every 36 people, or six houses. Such a large number of standposts is unlikely to be cost effective and it is unlikely that all of the water demand can be satisfied from public standposts.

**Groundwater** — a number of shallow wells and two handpumps exist on the site. If the groundwater is of good quality, there is no reason why it should not provide for all water requirements. However, unprotected shallow wells and springs are prone to pollution by dirty water, mud and excreta which result from human and animal activity around the well. One of the best means of protecting and abstracting groundwater is to drill a narrow diameter well in which is placed a handpump to raise the water.

During the monsoon season the water table is within one or two metres of ground level and it is possible that the groundwater may be contaminated by seepage from open drains, sewers and pit latrines. However, groundwater could be used to satisfy the water demand for washing and bathing.

### **Proposal For Amba Nagar**

It is proposed to extend the distribution system in order to use public standposts to provide sufficient water for drinking and cooking purposes. Assuming this to amount to about ten litres per person per day would allow one tap to supply 240 people or 60 households. This value has to be modified in practice to cope with the layout of the slum to prevent some people being unreasonably far away from the standposts.

Existing shallow wells should be improved, with the addition of several new boreholes with handpumps to provide water for bathing and laundry.

Improvements to household storage of water must also be considered.

These improvements, although limited in scope, should provide health benefits. It is reasonable that the capital costs of the distribution system, boreholes and wells are funded by the municipality.

The cost of household storage improvements which can be considered to be a convenience benefit, should be paid for by the user. Any householders who wish to invest in the added convenience of a house connection can do so providing that they pay the full cost of the connection and water meter.

### **Implementation, Operation and Maintenance**

The Slum Improvement Programme in Hyderabad aims to integrate housing and infrastructure provision with socio-economic and health inputs aimed at poverty alleviation through community development. While the socio-economic programmes and, to a lesser extent, shelter provisions, have had a sound community development base, infrastructure provision has tended to be implemented separately. However, this multi-faceted approach has achieved much publicity in recent years and has been promoted as a successful model for slum improvement.

The proposals for improvements to the water supply need to be implemented with the full co-operation of the community. It is not practical to provide all of the water demand through public standposts and the com-



*Public standpost inadequately drained*

munity must be consulted on the final number and locations of the standposts. This must take into consideration the location of the groundwater sources. Failure to involve the community at this stage of the planning is likely to lead to problems in operation and maintenance.

As far as is possible, the standposts should serve an easily identifiable group of households. This engenders a feeling of "ownership" and minor maintenance difficulties are more likely to be repaired or reported when the user community is easily identifiable.

In slums which are being redeveloped the use of the "cluster" concept of housing development is a good way of creating small, identifiable groups of householders. It may also be possible to levy a user charge for the standposts in such circumstances.

Advice on efficient and appropriate means of storing water should be a part of the general hygiene and health education which forms a part of the overall slum improvement programme.

### **Conclusion**

Improvements to water supplies in urban slums should consider the optimum use of the available resources. In the case of Amba Nagar in Hyderabad, India, this involves the improvement of groundwater sources, the extension of the piped distribution system with additional public standposts and improvements to household storage of water.

Implementation should involve the community from the planning stage with the aim of engendering a sense of community ownership of the service provided. •

## Corrosion and Scale Protection and Control

**ACI PLASTIC COATINGS LTD** Woodbridge Industrial Estate, Guildford, Surrey, GU1 1BG, UK, Tel: +44-483-31155, Telex: 859237, Fax: +44-483-33534, Contact: Karen Stewart. Thermoplastic, low maintenance protective coatings for pipework, fittings, resistant to most corrosive environments and soil conditions. Coatings applied in thicknesses from 0.10 - 0.250 inches.

**ALLIANCE GROUP INC** P O Box 17849, Milwaukee, WI, 53217, USA, Tel: +1-414-332-8440. Supplier of scale and corrosion inhibitors for steam boilers, condensate return lines, open recirculation systems, potable water and closed chill and hot water systems. (WT)

**AQUA MAGNETICS INTERNATIONAL INC** 1010A Park Court, Safety Harbor, FL, 34695, USA, Tel: +1-813-726-8888, 1-800-328-2843. Manufactures and distributes worldwide a complete line of non-chemical Power Units™ for scale control and scale removal in pipes and other thermodynamic equipment. These products are attached to the outside of the pipes. (WT)

**BASCO LTD** Cathodic Protection House, Harding Lane, Fair Oak, Eastleigh, Hants, SO5 7GL, UK, Tel: +44-703-694266, Telex: 47354, Fax: +44-703-693001, Contact: Mr Field. Cathodic protection, engineering and materials for all buried and immersed plants, and monolithic pipeline isolating joints.

**BAYROL CHEMISCHE FABRIK** Lochhamer Str 29, Martinsried, 8033, West Germany, Tel: +49-89-85-7010, Telex: +524695, Fax: +49-89-85-701777, Contact: Mr Utz Heyn. Cleaning and disinfection in the production sectors of the brewing, food and beverage industries, as well as the use of technical enzymes. Industrial water treatment. Swimming pool and whirlpool care for the public and private sectors. Sauna care, special chemicals as starting materials for the processing industry.

**BELZONA MOLECULAR LTD** Claro Rd, Harrogate, N Yorks, HG1 4AY, UK, Tel: +44-423-67641, Telex: 629497, Fax: +44-423-505967, Contact: Mrs Cooper. Maintenance product and services for the repair and refurbishment of pumps, valves and associated equipment. Accepted supplier of coatings and systems for protection against corrosion and chemical attack on concrete.

**BK LADENBURG** Dr Albert-Reimann-Strasse 2, Ladenburg, D 6802, West Germany, Tel: +49-6203-77-4307, Fax: +49-6203-1-2818, Contact: Ferdinand Puhe. Water treated with our Albaphos® and Mikrophos® is of top drinking water quality. Albaphos and Mikrophos counteract incrustations and corrosion in optimal manner.

**BRANCHEMCO INC** 8286 Western Way Cir C/2, Jacksonville, FL, 32216-8389, USA. Manufactures corrosion inhibitors, scale dispersants and biocides for boiler, cooling and domestic water. (WT)

**CANUSA DIV OF SHAW PIPE** 1442 Cake Front Circle Suite 100, The Woodlands, TX, 77380, USA, Tel: +1-713-367-8866. Manufactures line of heat shrinkage polyolefin sleeves designed to protect DI tanks from corrosion. Tank caps and accessory items are also available.

**CATHODIC PROTECTION CO LTD** Venture Way, Grantham, Lincs, NG31 7XS, UK, Tel: +44-476-590666, Telex: 377525, Fax: +44-476-70605, Contact: Ian Bunch. Specialises in the survey, design, manufacture and commissioning of sacrificial and impressed current cathodic protection systems. Engineers are qualified to undertake CP surveys on site. In addition, manufacture an electrolytic anti-fouling device to control marine growth in water intakes.

**CENTRAL PLASTICS COMPANY** P O Box 3129, Shawnee, OK, 74801, USA, Tel: +1-405-273-6302, Telex: 910-830-6980, Fax: +1-405-273-5993, Contact: Bob Shafer. Designer, manufacturer of polyethylene related products: butt, socket, sidewall fitting piping systems and fusion equipment, electrofusion fittings/equipment, transition fittings. Also cathodic protection products including: insulated unions and flange insulation kits.

**CHEMICAL TESTING CORP** 35 Commerce Rd, Stamford, CT, 06902, USA, Tel: +1-203-357-9800. Water treatment for prevention of scale and corrosion in boiler and cooling systems combined with testing service and reports.

**CIBA-GEIGY INDUSTRIAL CHEMICALS** Tenax Rd, Trafford Park, Manchester, UK, Tel: +44-61-872-2323, Fax: +44-61-873-7271. The water treatment business of Ciba-Geigy Industrial Chemicals research, develop, manufacture and sell water-soluble polymers for use as scale inhibitors. Other speciality chemicals include corrosion inhibitors and biocides, unique to Ciba-Geigy.

**COLEBRAND LTD** 20 Warwick St Regent St, London, W1R 6BE, UK, Tel: +44-1-439-9191, Telex: 261495, Fax: +44-1-734-3358, Contact: Mr T Bullock. Protection of steel and concrete on land or under water, against corrosion or chemical attack using epoxy and polyurethane products. Epoxy coatings and mortars approved by WRC for contact with potable water.

**CORRPRO COMPANIES INC** P O Box 1179, Medina, OH, 44258, USA, Tel: +1-216-723-5082, Telex: 887227, Fax: +1-216-725-3290, Contact: S Dale. Complete corrosion engineering services for effective and economical corrosion control program. Specific service include: corrosion surveys, design, energizing and infection programmes for all type of cathodic protection systems, and computerized corrosion information management systems.

**CSR HUMES PTY LTD** PO Box 31, World Trade Centre, Melbourne, Victoria. 3005, Australia Tel: +61-3-611 3311, Telex: +38015, Fax: +61-3-614 6347. Humepipe Systems, precast structural concrete products, protective linings, soil stabilisation products: Humes Concrete is Australia's leading producer of concrete pipe and precast concrete products and, as such, is a significant contributor to the construction of the nation's irrigation, sewerage and drainage reticulation systems. As

## CORROSION AND SCALE PROTECTION AND CONTROL

well, Humes Concrete products are utilised in major transport infrastructure works, rural and domestic applications. The Advance Australia Award winning Eurocycle, a compact domestic wastewater treatment plant, an inexpensive alternative to sewerage, septic tank and pump-out systems.

**DRAGON CORROSION INTERNATIONAL** Quarry St Nantgarw, Cardiff, CF4 7SY, UK, Tel: +44-443-841188, Fax: +44-443-841111, Contact: Mr Lamb. Cathodic protection corrosion control and inspection services.

**THE B F GOODRICH CO/SPECIALITY POLYMERS & CHEMICAL DIVISION** 6100 Oak Tree Boulevard, Cleveland, OH, 44131, USA. Manufacturer of deposit control additives and corrosion inhibitors used as components of water treatment formulations for cooling, boiler and process water applications. (WT)

**HARCO TECHNOLOGIES CORP** 1090 Enterprise Drive, Medina, OH, 44256, USA, Tel: +1-216-725-6681, Telex: 196184, Fax: +1-216-723-0244, Contact: Cindy Hendershot. Provide cathodic protection for submerged or buried metallic structures. Also engineering, materials, design, installation and service.

**HERBERTS HEAVY DUTY COATINGS** Freshwater Rd, Dagenham, Essex, RM8 1RU, UK, Tel: +44-1-590-6030, Telex: 24317, Fax: +44-1-599-3527, Contact: Mr Hall. Technical specification and application checking service for new construction and maintenance, with a comprehensive range of coating systems for the protection of steel and concrete from corrosion, and fire.

**IMPALLOY LTD** Alloys House, Willenhall Lane, Bloxwich, Walsall, WS3 2XW, UK, Tel: +44-922-408444, Telex: 338270, Fax: +44-922-710043, Contact: Tracy Inson. Designers and suppliers of cathodic protection and electrolytic anti-fouling equipment.

**JEROME INSTRUMENT CORP** Old High School highway 89A, Jerome, AZ, 86331, USA, Tel: +1-602-634-4263. Manufacturer of Gold Film Hydrogen Sulfide and Mercury Instrumentation. Hazardous waste and corrosion control monitoring, water purity testing.

**KEMTUNE INC** P O Box 11325 S Calhoun St, Fort Wayne, IN, 46857, USA, Tel: +1-219-456-3596, Telex: 232639, Fax: +1-219-456-3598, Contact: Gloria Sander-son. Kemtune manufacture and distribute non-chemical water treatment equipment for limescale and corrosion control in boilers, cooling towers, heat pumps, heat exchangers, water heaters and many other applications worldwide.

**KING LEE CHEMICAL CO.** PO Box 146, Del Mar, California, 92014, USA Tel: +1-619-693-1358, Fax: +1-619-693-1358. King Lee offers advanced chemicals for the economical, safe, and efficient control/prevention of corrosion and scale in piping systems and water treatment equipment. Products offered are available in powder and liquid formulations. They are added at low dosage levels for optimum protection. Products are safe to ship, handle, and store for extended periods of time without loss of performance. Distributor enquiries are welcome.

**LIFESOURCE WATER SYSTEMS** 5235 South Fair Oaks, Pasaadena, California, 91105, USA, Tel: +1-818-792-9996, Contact: Carole Zepp. Suppliers of a bi-polar energy cell - no magnets or metal bars, salt free, chemical free and eliminates scale and corrosion. Natural minerals remain, reduced evaporation when applied in irrigation, soap and chemical use reduced dramatically, water boils faster. Actual chemical bond broken apart.

**LITHGOW-SAEKAPHEN LTD** Buckley, Clwyd, CH7 3PQ, U.K, Tel: +44-244-542501, Telex: 61367 calsak, Fax: +44-244-548738, Contact: Maureen Druce. Manufacturers of anti-abrasive and anti-corrosive coatings and linings. Metal and concrete refurbishment specialists.

**MAINLINING SERVICE INC** P O Box 96 555 Pound Rd, Elma, New York, 14059, USA, Tel: +1-716-652-3700, Fax: +1-716-652-9234, Contact: A G Perkins. Water main cleaning and/or cement lining of water mains in place by the originators of the centrifugal (Perkins) pipe lining process. Range of capability from 4" to over 12 feet diameter - over 40 years experience in equipment design, manufacture and field use.

**MET-PRO CORPORATION** P O Box 144, 160 Cassell Rd, Harleysville, PA, 19438, USA, Tel: +1-215-723-6751, Telex: +244-903, Fax: +1-215-723-6758. Stiles-Kem Division manufactures water treatment chemicals for the control of scale and corrosion.

**MICROPAX LTD** Southgate Chambers, 37/39 Southgate St, Winchester, Hants, SO23 9E1, UK, Tel: +44-962-733242, Telex: 477152, Fax: +44-962-62288, Contact: Mr Hudson. Cathodic protection services allied to sacrificial anode and impressed current systems, including: consultancy, design, survey, inspection, installation, maintenance and material supply. Distributors for insulating joints, anodes, reference electrodes, monitoring systems etc.

**NUTEK** PO Box 1, Amston, CT, 06231, USA, Tel: +1-203-537-2387, Telex: 710-420-0430, Contact: Mr Demoholla. Produce chemicals for scale and corrosion inhibition and removal. Able to remove calcium sulphate, barium sulphate, iron oxides and most difficult scales.

**PFIZER INC** 235 East 42nd St, New York, NY, 10017, USA, Tel: +1-212-573-2531, Telex: 420440, Fax: +1-212-573-1166, Contact: Mr Roy Dickinson. Pfizer Inc markets "Flocon 100" the leading antiscalant for reverse osmosis systems as well as the "Floclean" family of RO cleaning compounds. Pfizer also provides water analysis services, membrane flow-testing and autopsy services. In addition, Pfizer offers a computer program to help designers and engineers determine optimum operating conditions and Flocon dosage.

**PFIZER WATER TREATMENT PRODUCTS** 235 East 42nd St, New York, NY, 10017, USA, Tel: +1-212-573-2531, Fax: +1-212-573-7851. Pfizer Water Treatment Products Group, a unit of the Pfizer Inc Pharmaceutical Corporation, manufactures the FLOCON line of antiscalants specifically designed to inhibit scale formation in reverse osmosis desalination units. Pfizer also sells and distributes the FLOCLEAN cleaners for reverse

# CORROSION AND SCALE PROTECTION AND CONTROL

osmosis membranes and provides a variety of services to the industry including water analysis, membrane autopsies and computerized dosing programs.

**PRODORITE LTD** Leabrook, Wednesbury, W Midlands, WS10 7LT, UK, Tel: +44-21-536-1821, Contact: Miss Dickins. Prodorite are recognised as the foremost company in Britain, specialising in the formulation and manufacture of a formidable range of anti-corrosive, abrasion-resistant protective systems, aimed specifically at the developing world water market.

**PSG CORROSION ENGINEERING INC** 7807 Conroy Court, Suite 110, San Diego, CA, 92111-1293, USA, Tel: +1-619-565-6580, Contact: Mike Crossley. Designs sacrificial and impressed current cathodic protection systems for mitigating pipeline, tank and treatment plant corrosion, internal-external corrosion and investigation and coating specifications.

**SALAMANDER ENGINEERING LTD** Unit 1A, Reddicap Trading Estate, Sutton Coldfield, W Midlands, B75 7BU, UK, Tel: +44-21-378-4508, Telex: 3351676, Contact: Mike Pickavance. Manufacturers of 'Scalemaster' - a simple and easily fitted unit which inhibits scale formation, with no running or maintenance costs.

**SCHILLING-CHEMIE GMBH** P O Box 11 36, Freiberg, D-7149, West Germany, Tel: +49-7141-703-0, Fax: +49-7141-703178. Acitol chemicals and decalcification pumps for the removal of scale, corrosion and organic deposits in industrial water systems.

**SIEMENS SOLAR GmBH** Buchenallee 3, Bergisch Gladbach 1, D-5060, West Germany, Tel: +49-2204-4060, Telex: 884891 sso, Fax: +44-2204-40666. Converting light directly into electric energy enables the use of solar powered cathodic protection even in remote areas. In competition with other energy sources - diesel, distant power lines etc - solar power has proved itself time and again to be the best solution due to its numerous advantages.

**STILES-KEM DIV MET-PRO CORP** 3301 S Sheridan Rd, Zion, IL, 60099, USA, Tel: +1-312-746-8334. Manufacture water treatment chemicals for control of scale, red water and corrosion in municipal, industrial, commercial and domestic water systems to prolong life of water using equipment and distribution systems.

**SUPERIOR WATER SERVICES INC** 4509 Pine St, Smyrna, GA, 30080, USA, Tel: +1-404-433-0805. Provides corrosion and scale inhibition and algae control to cooling towers, boilers, closed systems and domestic water systems. (WT)

**THE PQ CORP** PO Box 840, Valley Forge, PA, 19482, USA, Tel: +1-215-293-7305, Fax: +1-215-688-3835, Contact: Nancy White. Supply sodium silicates for the stabilization of dissolved iron and manganese and inhibition of corrosion in water storage and distribution systems. Also used as coagulant aids for raw and wastewater treatment.

**THE WISEMAN GROUP** P O Box 58, High St, Ingatestone, Essex, UK, Tel: +44-277-353330. The Wise-

man Group develop and manufacture chemical products for the international plumbing industry. Their principal brands are Everflux and Fingertip self-cleaning plumbing fluxes and the Radtect range of anti-corrosion water treatments.

**UNIVERSAL PIPE COATERS LTD** Manby Rd, Immingham, South Humberside, DN40 3FF, UK, Tel: +44-469-72311, Contact: Mr Harwood. Applicator of anti-corrosion coatings to mild steel pipes of all diameters, and the application of concrete weight coating for offshore lines, in accordance with the latest industry standards and specifications.

**UNIVERSAL SOLUTIONS INC** 12416 N 28th Drive Ste 18-252, Phoenix, AZ, 85029, USA, Tel: +1-602-371-0797. Manufacturing water treatment and scale removing chemicals. Custom design of chemicals.

**WATER EQUIPMENT TECHNOLOGIES INC** 832 Pike Rd, W Palm Beach, FL, 33411, USA, Tel: +1-407-684-6300, Contact: George T Karmbis. Manufacturers of water filtration and reverse osmosis products from 12 gallons to 250,000 gallons per day.

**WAYNE CONSULTANTS INC** N16 W22040 Jericho Drive, Waukesha, WI, 53186, USA, Tel: +1-414-547-5300. Marketing full line of proprietary chemicals to prevent scale and corrosion in industrial boilers and cooling towers.

**WESTERN ENVIRONMENTAL MGT** PO Box 1807, Carlsbad, NM, 88220, USA, Tel: +1-505-885-5709. An industrial water treatment company that custom blends chemical products designed to ensure maximum scale and corrosion inhibition is maintained within boiler and cooling water systems. The programs established have proven to reduce scale accumulations (WT)

**WINN & COALES (DENSO) LTD** Denso House, Chapel Rd, West Norwood, London, SE27 0TR, UK, Tel: +44-1-670-7511, Telex: 946175, Fax: +44-1-761-2456, Contact: Sue Duncan. Comprehensive range of anti-corrosion tapes, mastics and coatings for pipeline, pipe fittings, tanks and steelwork in all environments. Sealants for precast concrete pipe joints.

## Location and Inspection

## Underground Services

**ALPER SYSTEMS LTD** Cambridge Science Park, Milton Rd, Cambridge, CB4 4FQ, UK, Tel: +44-223-862464, Fax: +223-861324, Contact: Mrs Julie Buck. Alper Systems Limited specialises in computerised mapping and geographical information systems. "Alper Records" captures, displays and interrogates mains and sewer data overlaid onto a maintained vector or raster scanned map background.

**CHICAGO STEEL TAPE CO** 450 C I P S St P O Box 359, Watseka, IL, 60970, USA, Tel: +1-815-432-5237, Fax: +1-815-432-2417, Contact: Ash Puri. Chicago Steel Tape manufactures ferrous metal locators. Its two units, the

## LOCATION AND INSPECTION UNDERGROUND SERVICES

ft-50 Pin Finder and the ft-60 Ferro Trak, are unsurpassed in locating buried ferrous metals like septic tanks, cast-iron pipes, manhole covers, valve boxes etc.

**CSR-HUMES PTY LTD** PO Box 31, World Trade Centre, Melbourne Vic. 3005, Australia Tel: +61-3-6113311, Telex: +38015, Fax: +61-3-6146347. Hume-pipe Systems, precast structural concrete products, protective linings, soil stabilisation products: Humes Concrete is Australia's leading producer of concrete pipe and precast concrete products and, as such, is a significant contributor to the construction of the nation's irrigation, sewerage and drainage reticulation systems. As well, Humes Concrete products are utilised in major transport infrastructure works, rural and domestic applications. The Advance Australia Award winning Eurocycle, a compact domestic wastewater treatment plant, an inexpensive alternative to sewerage, septic tank and pump-out systems.

**GOLDAK / UDSEC** 547 West Arden Avenue, Glendale, CA, 91203, USA, Tel: +1-818-240-2666, Fax: +1-818-244-6818, Contact: Mr Mark Mulcahey. Designer, developers and manufacturers of portable electric detection instruments since 1933. Specialized instruments for the water industry include pipe locators, valve locators, leak detectors and pipe tracers for sewer pipe, both cast iron and non-metallic. Locators also have the capability of locating Septic tanks and tracing telephone and electrical cables.

**HEATH CONSULTANTS INC** P O Box CS-200, 100 Tosca Drive, Dept AWWA, Stoughton, Mass, 02072-1591, USA, Tel: +1-617-344-1400, Telex: 924486, Fax: +1-617-341-4359, Contact: Jane Lyons. Leakage detection - manufacture of equipment and training. Also pipe and cable locators.

**INSIGHT VISION SYSTEMS LTD** Unit 1, Merebrook, Hanley Rd, Danemoor, Malvern, Worcestershire, W13 6NP, UK, Tel: +44-684-310001, Telex: 334480, Fax: +44-684-310510, Contact: Mr Saunders. Designers and manufacturers of closed circuit television systems for inspection of pipes in hostile environments.

**JERMAN WATERWORKS SUPPLY CO** 165 Sussex St, Hackensack, NJ, 07601, USA, Tel: +1-201-487-7444, Fax: +1-201-487-3953. We offer international service on waterworks specialties including but not limited to pipe, fittings, valves, meters, locators, leak detectors, fire sprinklers equipment, flanges, pressure regulators, backflow preventers, fluid controls etc.

**McCULLOUGH/LEAKTEK INC** 1165 Park Avenue, Murfreesboro, TN, 37130, USA, Tel: +1-615-890-9030, Contact: Grady Looney. Full service offering: water distribution system analysis (water audits), meter testing, leak detection surveys, C factor tests, pipe location, underwater pipe inspection and leak location, sub-surface mapping. Services provided for municipalities, manufacturers, colleges, contractors, apartments, condominiums, government installations. All work guaranteed.

**METROTECH CORPORATION** 670 National Avenue,

Mt View, CA, 94061, USA, Tel: +1-415-940-4900, Telex: +6502726454MCI UW, Fax: +1-415-962-9527, Contact: Pei Hsien Fang. Metrotech Corporation designs, manufactures and sells advanced electronic underground utility locating instruments: pipe and cable (including fiber optic) locators and tracers, 50/60Hz, iron and steel, valve box/pedestal and water leak locators.

**PALMER ENVIRONMENTAL SERVICES** 6 Knightwood Court, Capton Hall Industrial Estate, Great Yarmouth, Norfolk, NR31 0NG, UK, Tel: +44-493-600563, Telex: 975313, Fax: +44-493-653427, Contact: Sonja Taylor. Manufacturers of a leak noise correlator - for the detection of leaks in underground water pipes. Also offer pipe & cable location equipment and a leak detection, mapping and consultancy service.

**PROTOVALE OXFORD LTD** Unit 511, Rectory Lane, Kingston Bagpuize, Abingdon, Oxon, UK, Tel: +44-865-821277, Fax: +44-865-820573, Contact: Monica Farrow. Manufacture metal detectors, their application in this field being for the location of stop box covers etc which have been obscured along pipelines. Although the company's interests are mainly based in the UK and Europe, they would be interested in any inquiries from further afield.

**RADIO DETECTION LTD** Western Drive, Hengrove Park Industrial Estate, Bristol, Avon, BS14 0AZ, UK, Tel: +44-272-839581, Telex: 44806, Fax: +44-272-891505, Contact: Nick Frost. Radio Detection specialise in "information from underground", supplying hand held equipment for the detection of underground pipes and cables.

**SCHONSTEDT INSTRUMENT CO** 1775 Wiehle Avenue, Reston, Virginia, 22090, USA, Tel: +1-703-471-1050, Telex: 710-833-9880, Fax: +1-703-471-1795, Contact: Mr Osman. Offer magnetic and cable locators that will detect ferrous metallic objects under the ground as well as underground metallic utilities.

**SEBA DYNATRONIC** Industriestrasse 6, Baunch, D-8611, West Germany, Tel: +49-9544-680, Fax: +49-9544-2273, Contact: Theo Wiedemann. Instruments for leak detection, water loss analysis, cable fault location and consultancy. Especially: locators for metallic and non metallic pipes, leak detectors, correlators, pressure and flow meters.

**TELESPEC LTD** Tannery House, Tannery Lane, Send, Woking, Surrey, GU23 7HB, UK, Tel: +44-483-222061, Telex: 859270, Fax: +44-483-223329, Contact: Mr Kernick. Telespec offer a new quality "look see" system for inspection of all types of pipework, sewers and bore holes. The equipment is available with 10 view heads with remote control focus, waterproof to 250m and able to inspect 80-1000mm pipes.

**TINKER & RASOR** P O Box 281, San Gabriel, CA, 91778, USA, Tel: +1-818-287-5259, Fax: +1-818-287-0132, Contact: Rick Claridge. Tinker & Rasor manufactures leak detectors and Detectron Model 505-Gofer pipe and cable locators. When it comes to tracing distance, depth penetration and sensitivity, the Model 505-Gofer rivals all other pipe and cable locators on the market.



## LAYING OF PIPES (INCLUDING TRENCH EXCAVATION)

### Laying Of Pipes (Including Trench Excavation)

**A F TRENCHERS LIMITED** Gosbecks Rd, Colchester, CO2 9JS, UK, Tel: +44-206-44411, Telex: 987562, Contact: Mr Baker. Manufacturers of continuous line trenchers for excavating from 50-450mm wide up to 1.45m deep. Self-wincing, wheel-driven, track laying and tractor mounted types available.

**AVENT E W LTD** Porte Marsh Rd, Calne, Wilts, SN11 9BW, UK, Tel: +44-249-816420, Telex: 444355, Contact: Mrs Creasey. Specialists in pipeline installation world wide.

**BERGSOE ANTI CORROSION (BAC) AB** Box 214, Landskrona, S-261 23, Sweden, Tel: +46-418-161-65, Fax: +46-418-27722, Contact: Jan Persson. B A C supply and install pipelines and storage tanks - structures in soil and water, also cables, piles and sheet piling, as well as water towers and water treatment plants.

**BODDINGTONS LTD** Unit 10, Dunmow Industrial Estate, Chelmsford Rd, Gt Dunmow, Essex, CM6 1HF, UK, Tel: +44-371-5101, Telex: 81233 Bodton G, Fax: +44-371-4906, Contact: Ms Sadie Carmichael. Boddingtons Warning Tapes are laid above a buried water pipe, sewer pipe or irrigation pipe, so as to warn other excavators of the buried service. Detectable Warning Tapes with a tracer foil are used where plastic pipelines are concerned. Boddingtons electrical products specialize in energy monitoring equipment notably power factor correction control relays and maximum demand load shedding equipment.

**CAMECO INDUSTRIES B V P O** Box 2077, Lelystad, AB, 8203, The Netherlands, Tel: +31-3200-32255, Telex: 47141 camec nl. Cameco Industries B V, manufacturer and supplier of Agritraco heavy duty implements, Cameco laser controlled land levelling systems and heavy duty construction tractors, Gomaco canal lining machines, trimmer and concrete equipment, Spectra Laserplane laser machine control and survey systems, Physics design and survey hardware and software.

**CONDRILL AB** Sveavagen 83 113 50 Stockholm Sweden Tel: +46-8-349560, Telex: +12336, Fax: +46-8-316762

**DUAL MANUFACTURING COMPANY** 1000 West Cherukee, Sioux Falls, South Dakota, 57117 5041, USA, Tel: +1-605-336-3860, Telex: 437040, Contact: Mr Hanson. Three models of backhoes, digging from 7'6" to 12'9". Two models of trenchers for hydrostatic or Deer driven tractors.

**ESSENER HOCHDRUK - ROHRLEITUNGSBAU P O** Box 120124, Essen 12, D-4300, West Germany, Tel: +49-201-349-25, Fax: +49-201-351423. Supply, construction and complete engineering of pipeline systems of all sizes and for all media, including pertaining facilities such as pumping and compressor stations, termi-

nals, telecom and SCADA systems and all utilities. Further, complete interconnecting piping systems for industrial plants etc.

**ESSIG (UK) LTD** Unit 5, Mill Hall Business Estate, Aylesford, Maidstone, Kent, ME20 7JZ, UK, Tel: 44-622-76562/3, Telex: 966102 ESSIG G, Contact: Gary Pierce. Impact boring equipment (moles). Bore sizes from 45mm to 1.5 metres can be obtained with our wide range of machines. Pipe punching machines, cast iron crackers, salt glase crackers and venturi water pump.

**GRESSBACH WINDEN - UND MASCHINENBAU GMBH** P O Box 6, Obernburg, D-8753, West Germany, Tel: +49-6022-3-10-47, Telex: 4-188-132 gres d, Fax: +49-6022-3-10-50. Gressbach Winden - und Maschinenbau GmbH was founded in 1816. Manufacturing and marketing of WIMAG equipment- lifting gear and construction equipment, especially for underground engineering, pipe handling equipment, cranes and special constructions.

**HYDRO ENGINEERING SDN BHD** 15A Jalan Bachang Batu 2 1/4 off Jalan Ipoh, Kuala Lumpur, 51200, Malaysia, Tel: +60-3-2987814 & 2920935, Fax: +60-2432223, Contact: James F C Chong. Established in 1981, Hydro is involved in pipe-laying for local authorities and public work department agencies in Malaysia. Currently expanding and hope to have dealings in overseas markets.

**JOHNSTON ARMALINE** Johnston House, Hatchlands Rd, Redhill, Surrey, RH1 1BG, UK, Tel: +44-737-242466, Fax: +44-737-249730, Contact: Mrs Joyce Read. Provide specialist staff and equipment to contractors for pipejacking. Also have considerable expertise in a variety of sewer lining techniques, including installation of small diameter pipes and connections by remote control.

**J MASTENBROEK & CO LTD** 83 Swineshead Rd, Wyberton Fen, Boston, Lincs, PE21 7JC, UK, Tel: +44-205-65459, Telex: 377296, Fax: +44-205-310016, Contact: Miss Lindy Mastenbroek. Manufacture trenching machines and equipment for laying pipes and cables. Also ditch maintenance equipment.

**PEART** Onward Works, Manchester Rd, Hyde, Cheshire, SK14 1BB, UK, Tel: +44-61-368-3545, Telex: 666801, Fax: +44-61-367-8218, Contact: Mr Roy Richardson. Specialists in under-pressure drilling to enable branch connections and additional service lines to water pipelines. Leak repair clamps, pipe cutting machines, boring machines and equipment for welding plastic pipes.

**PIPE EQUIPMENT LTD** Old Coal, Wharf Frome Rd, Bradford on Avon, Wilts, BA15 1LE, UK, Tel: +44-2216-4056, Telex: 449807, Fax: +44-37-387666, Contact: Steve Kent. Manufacturers and hirers of trailers for coiled PE from 63mm to 180mm, pipe pushing machines up to 630mm, pressure tight towing heads, test ends, pipe rollers and other PE handling products.

**T T UK LIMITED - GRUNDOMAT** 10 Windsor Rd, Bedford, MK42 9SU, UK, Tel: +44-243-42566, Telex:



RO >VINILPLASTIKA<, plastic materials industry, was founded in 1955 and since that time has developed into one of the leading producers in SFR Yugoslavia in the field of manufacturing and processing of plastic materials on the PVC-basis.

*Therefore we should like to inform about the range of our products which runs as follows:*

- PVC powder of high K-vaule in mass calendring, injection moulding and extrusion
- PVC granulates and injection moulding mixes
- Electrical insulation granulates
- Footwear industry granulates
- PVC mixes for blown foodstuffs, pharmaceutical and cosmetic industry packaging
- Piping and fittings for home sewage disposal and for street drains
- Water supply piping and fittings for operating pressure of 6 and 10 bars
- Power cable protection pipe
- Piping and other units for laying of telephone and telegraph cables
- Pressure piping and fittings for home water supply installations
- Construction industry section: blinds, staircase sections, handrails expansion strips etc.
- Furniture industry sections
- Automobile industry sections
- Soft piping and sections for varied applications
- Plasticised fabrics for protective clothing and tarpaulins
- Wayterproofing sheeting for road and building construction
- Semi-round and square gutters, drain pipes and fittings.

With possible future contacts we shall supply more commercial and technical information on our products and other particulars which might be of interest.



**RO vinilplastika** n. sol. o.

INDUSTRIJA PLASTICNIH MASA 57001 ZADAR PUT MURVICE 14-16, GAZENICA b.b  
Tel: (057) 25-322, Telex 27120, YU VNP ZD, 27171 YU VNP ZD



## OUR TECHNOLOGY IS WITHIN YOUR GRASP

► Around the world, Humes Concrete is the leader in water and sewerage spun-pipe technology. After all, Humes created the process. And that's a concrete fact. Now, if you'd like to share Humes technology and manufacture such products as Humepipe and Plastiline Pipe, use Humes Plastiline for the protection of in situ concrete structures, manufacture the unique wedge ring watertight manhole system, or handle under licence the Envirocycle waste water treatment system ... the solution is simple. ◀

SIMPLE SOLUTIONS IN CONCRETE

**HUMES CONCRETE**

A unit of CSR Limited

ALL AUSTRALIAN



Contact: **HUMES CONCRETE**, World Trade Centre, P.O. Box 31, Melbourne, Victoria, Australia 3005.  
Telephone: (Access code) 61 3 611 3311. Fax: (Access code) 61 3 614 6397

# HEPWORTH DEVELOPMENTS BOOST INTERNATIONAL SERVICE FOR CLAY AND PLASTICS SYSTEMS

Hepworth Building Products, part of the £600 million turnover UK-based Hepworth Group, has recently been formed to co-ordinate divisional activities in clay and plastics plumbing, drainage and pressure pipes. The move provides a single source for vitrified clay and plastics materials for all aspects of the water supply and drainage industries. It is thought that the company now can provide the widest product range available from any single manufacturer. From January 1, 1989 the company has established Hepworth Building Products International to provide a further enhanced service in overseas world markets.

Explains Ken Thompson, director and general manager of Hepworth Building Products International: "A number of construction projects call for the use both of plastics plumbing and drainage products and of clay drainage systems. By combining these operations at Hepworth, we can, therefore, reduce customers' administration time, provide a single sales contact, and offer enhanced technical and delivery services." With Hepworth Building Products offering plastics rainwater, soil, waste and underground drainage systems, water pressure pipe and a polybutylene plumbing system, as well as clay drainage systems from 100 mm to 1,000 mm, the range now available is sufficient to meet every plumbing, drainage and water supply requirement.

Customers, too, benefit from Hepworth's innovative approach which has led to the introduction of some of the industry's most advanced systems. The SuplerSleve vitrified clay system, for example, is among the most advanced in the world. It is manufactured using revolutionary methods of clay preparation and fired in roller kilns to provide high levels of strength and accuracy, features which are vital in many world markets.

In the plastics arena, Hepworth has firmly established itself as a leader in the development and marketing of advanced plumbing systems, with its high technology polybutylene Acorn range. Acorn makes it possible to achieve major savings in the installation time required to complete hot and cold water services and central heating systems.

Plumbing, using systems like Acorn, is already very well established in many world markets and looks set to bring about a revolution in the specification of water distribution systems. Breadth of range and innovation, however, are by no means the only attributions of the new organisation. The company sets considerable store by the quality of technical support service offered, not only from the UK headquarters, but by subsidiary companies in the Middle East, including Hepworth Plastics Gulf in Dubai, Delta in Saudi Arabia and Hepworth Building Products International in Bahrain. The company maintains large stockholdings in Saudi Arabia, the United Arab Emirates and Bahrain.

The unique combination of range, UK manufacturing expertise and local stockholding has helped Hepworth Building Products International already secure major orders for plastics systems for use in Dubai Municipality sewerage schemes. The company's vitrified clay products are long established in Middle Eastern markets where their resistance to the aggressive soil and effluent conditions, found in hot climates, makes them particularly attractive to specifiers.

Hepworth Building Products International's operation stretches around the world. Whilst the majority of the company's drainage and pressure pipe systems are sourced from the UK, manufacturing agreements for indigenous

manufacture of the Acorn polybutylene plumbing system have been concluded with Spain, New Zealand and Korea. Expansion into further Far East markets is planned.

Whether supply is from the UK, from one of its own overseas stockholding bases, or through a network of distributors and manufacturers worldwide, delivery is a prime concern. This factor has led Hepworth Building Products International to establish its own in-house shipping department and support services. Communication lines are, therefore, kept as short as possible, helping the company to meet specified customer requirements.

Says Ken Thompson: "Under the new banner, we expect to build rapidly on our existing business base, by providing improved service in all areas, and to extend the availability of Hepworth expertise to new territories."

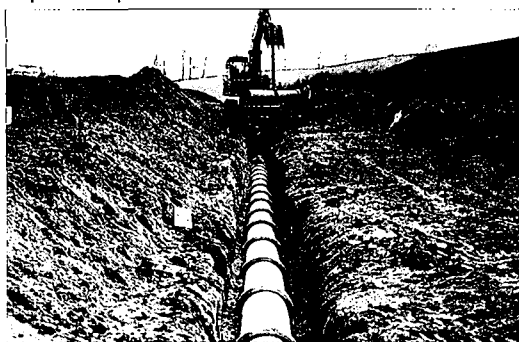

**READER RESPONSES:** To assist in responding to readers enquiries, where appropriate, please quote the story reference below if possible on any documentation sent to us.

**REFERENCE:** HBP 3

**REPLIES TO:** Hepworth Building Products International, Edlington, Doncaster, S.Yorkshire DN12 1BY Telephone: 0709 866500 Fax 0709 860004

**ISSUED ON BEHALF OF:** Hepworth Building Products International, Edlington, Doncaster, S.Yorkshire DN12 1BY Telephone: 0709 866500 Fax 0709 860004

**FOR FURTHER INFORMATION CONTACT:** Mike Farrington, Golley Slater Public Relations, 7 Hill Street, Bristol BS1 5PU. Telephone: (0272) 211131.

April 7 1989

## HEPWORTH BUILDING PRODUCTS

A Division of Hepworth Plc

# ILVA NEW ITALIAN STYLE FOR NEW ITALIAN STEEL

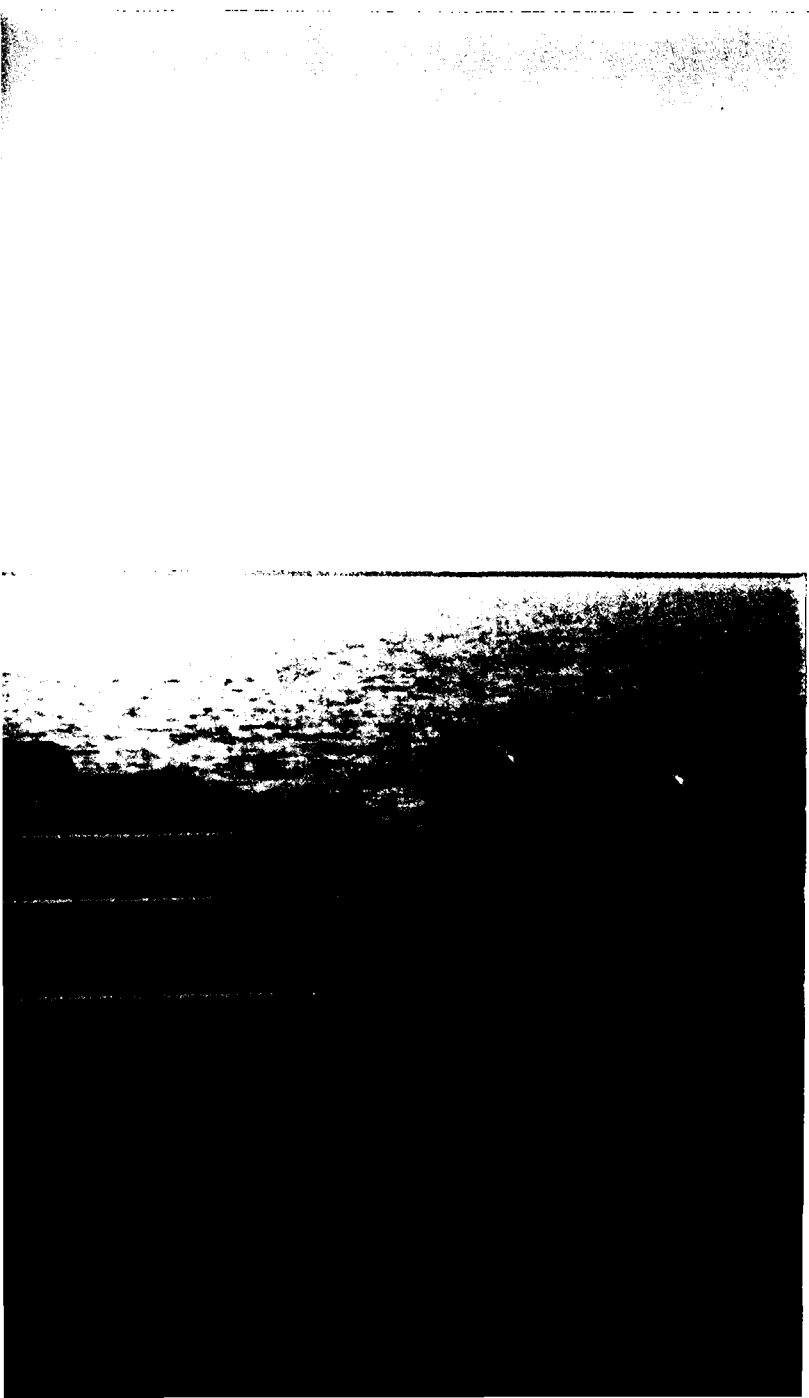

ILVA steel pipes are used in the construction of pipelines, penstocks, water mains; in the oil, petrochemical and structural applications.

The Taranto pipe mills (formerly ITALSIDER) manufacture DSAW pipes in diameters 18" to 56" and spirally welded pipes up to 108" OD. The Dalmine facilities produce seamless and welded pipes in diameters 1/2" to 36".

ILVA steel pipes are manufactured employing the most advanced technologies, thorough inspections and an exclusive quality assurance program.

All over the world, ILVA steel pipes are employed in drilling and transportation of oil, gas and other fluids. ILVA steel pipes, new name, long experience.



4, Via Corsica - 16128 GENOVA - Italy  
P.O. BOX 1727  
Phone (10) 551.81 - telex 270461 Itasid I

# WIMAG

## NUMBER ONE IN PIPELAYING PERFORMANCE!

WIMAG OFFERS THE TOTAL EQUIPMENT PACKAGE FOR THE SAFE AND ECONOMICAL HANDLING OF PIPES.

A FEW ITEMS FROM OUR PRODUCT RANGE

PIPE SUSPENSION GRAB

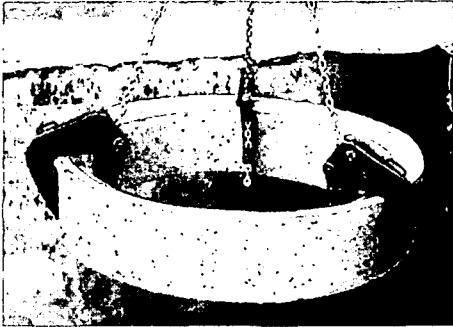

ROUND GRAB



PIPE LAYING DEVICE

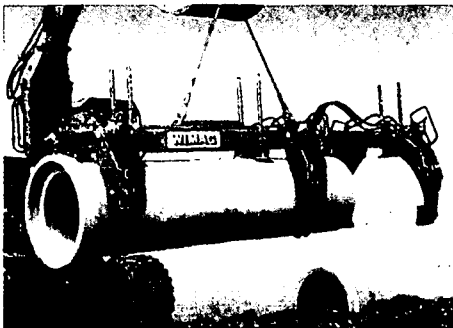

PIPE LAYING HOOK

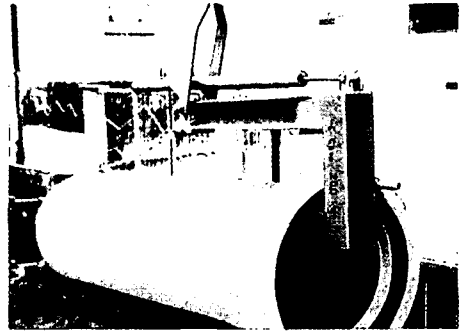

PIPE PULLER

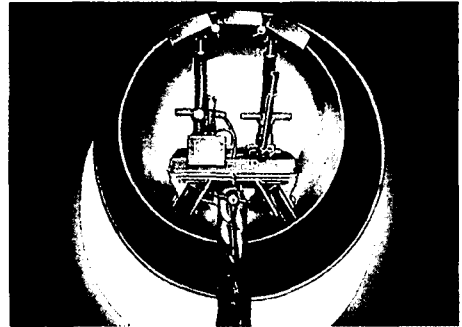

GANTRY CRANE

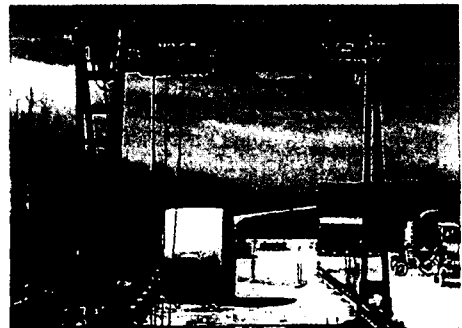

CONTACT US TODAY FOR DETAILED INFORMATION.

# Gressbach GmbH

Brueckenstrasse 5

D-8753 Obernburg 2 / W.-Germany · P.O. Box 60

Phone: (06022) 31047 · Telex: 4 188 132 gres d



## LAYING OF PIPES (INCLUDING TRENCH EXCAVATION)

825280 T T UKG, Fax: +44-234-52184, Contact: Martin McInnes. Manufacturers of "Grundomat" sub soil displacement hammers for trenchless installation of water pipe, 20mm up to 1400mm diameter, with no surface disruption, and "Grundocrack" insitu size for size or upsized mains replacement.

**TAMPELLA LTD TAMROCK** PO Box 279, 33101 Tampere, Finland Tel: +358-31-2414111, Fax: +358-31-132152. Tamrock surface designs and manufactures equipment needed in the drilling of rock or soil.

**THRUSTBORE CONSTRUCTION** 10 Park St, Lincoln, LN1 1UG, UK, Tel: +44-522-26188, Fax: +44-522-513764, Contact: Mr P Frost. Privately owned company specialising in the fields of pipe jacking, auger boring and segmental tunneling works.

**TROUVAY AND CAUVIN LTD** Aquis House, 117-121 New Zealand Avenue, Walton-On-Thames, Surrey, KT12 1QU, UK, Tel: +44-932-245131, Telex: 924261, Fax: +44-932-245080, Contact: Mr Buchanan. Trenching machines.

**VAN OORD GROEP N V P O** Box 151 Oude Haven, 3984 KT Odijk, 3984 ZG Odijk, The Netherlands, Tel: 31-3405-97211, Telex: 47566 oord nl, Fax: 31-3405-67553, Contact: Mr Mitchell. Van Oord Groep N V consists of the following divisions: Van Oord-Utrecht B V, Van Oord-International B V and Dredging VO2 B V for all types of dredging works. ACZ Marine Contractors B V for coastal protection and offshore-related works, and Van Eijk Bedrijven Gouda B V for pipe - and cable laying works. The group operates worldwide.

**VERMEER EQUIPMENT (UK) LTD** Blandford Heights, Blandford Forum, Dorset, DT11 7TE, UK, Tel: +44-258-54226, Telex: 417171, Fax: +44-258-59337, Contact: Mr EJ Catchpole. Vermeer trenchers, from the rubber-tyred 35hp V-430 up to the tracked 665hp T-1450, are used throughout the world for putting pipes into a wide range of ground conditions, including solid rock.

**VISSER & SMIT HANAB B V** PO Box 305, Papendrecht, 3350 AH, The Netherlands, Tel: +31-78-417222, Fax: +31-78-155163, Contact: Martin Visser. Construction of networks for domestic gas and water supply, construction of transmission pipelines for gas, water, oil and products. River crossings, horizontally drilled crossings, installation of power and instrumentation cables.

**WESTON SHIPLEY & WESTON "KUT OUT" LTD** Premier Works, Western Rd, Leicester, LE3 0BJ, UK, Tel: +44-533-549350, Fax: +44-533-555381, Contact: Mr Berry. Manufacturers of "KUT OUT" portable pipe cutting machines for cutting and bevelling all types of mains 3inch - 60inch diameter.

### Leak Detection and Control

**A1 INDUSTRIAL** London Rd, Pampisford, Cambridge, CB2 4EF, UK, Tel: +44-223-834420, Telex: 817536 Alcamp G, Fax: +44-223-8315050, Contact: John Sur-

man. Manufacture and market a wide range of leak detection instruments. The Leakgun 110 is specifically designed to locate leaks in underground pipelines and cables.

**CHERNE INDUSTRIES INC.** 5701 South County Road 18, Minneapolis, Minnesota, 55436, USA Tel: +1-612-933-5501, Fax: +1-612-938-6601. Cherne Industries manufactures and distributes products for the plugging, testing and repair of plumbing through municipal size pipeline. Specifically the company makes both Mechanical and Pneumatic pipeline plugs, by-pass plugs, plug accessory items, pipeline air-testing equipment, manhole vacuum testing equipment, plastic pipe deflection gauges, large diameter joint testing and sealing equipment and portable grouting equipment. Many of the two dozen styles of pipeline plugs are available in Chemical or Petroleum resistant materials. Cherne Industries has been manufacturing products for the Plumbing and Municipal pipeline industries for 36 years and is recognised as the leader in air-testing and pneumatic plugs.

**CONDRIILL AB** Sveavagen 83 113 50 Stockholm Sweden Tel: +46-8-349560, Telex: +12336, Fax: +46-8-316762

**DELTA TECHNICAL SERVICES LTD** Asser House, Airport Service Rd, Portsmouth, Hants, PO3 5RA, United Kingdom, Tel: +44-705-697321, Telex: 86477, Contact: David Wheatcroft. Delta Technical Services supply battery powered data collection equipment for leakage and network studies.

**DOWTY SEALS LTD** Ashchurch Tewkesbury Glos GL20 8JS UK Tel: +44-684-299111, Telex: +43163, Fax: +44-684-297947, Contact: . A company with over 40 years' experience in the design of materials and seals for the water industry and for use in high pressure IHC fluid hydraulics. A wide range of WRC approved and FDA/BGA recognised materials are available.

**GOLDAK / U D S E C** 547 West Arden Avenue, Glendale, CA, 91203, USA, Tel: +1-818-240-2666, Fax: +1-818-244-6818, Contact: Mark Mulcahey. Designers, developers and manufacturers of portable electric detection instruments since 1933. Specialized instruments for the water industry include pipe locators, valve locators, leak detectors and pipe tracers for sewer pipe, both cast iron and non-metallic. Locators also have the capability of locating septic tanks and tracing telephone and electrical cables.

**JERMAN WATERWORKS SUPPLY CO** 165 Sussex St, Hackensack, NJ, 07601, USA, Tel: +1-201-487-7444, Fax: +1-201-487-3953. We offer international service on waterworks specialties including but not limited to pipe, fittings, valves, meters, locators, leak detectors, fire sprinklers equipment, flanges, pressure regulators, backflow preventers, fluid controls etc.

**McCULLOUGH/LEAKTEK INC** 1165 Park Avenue, Murfreesboro, TN, 37130, USA, Tel: +1-615-890-9030, Contact: Grady Looney. Full service offering: water distribution system analysis (water audits), meter testing, leak detection surveys, C factor tests, pipe location,

**FIELD REPLACEABLE SLEEVE  
MUNI-BALL® PLUGS**



By-Pass Design allows for continuous flow while downstream repairs are made. Sleeves can be field replaced in minutes. Tapered plug ends allow plugs to be pulled through pipeline easily. Available in sizes 4" to 18". Natural rubber or Buna 'N sleeves available.

**REPLACEABLE SLEEVE MULTI-SIZE  
MUNI-BALL® PLUGS**

These large (12" to 36") plugs feature a by-pass design which allows uninterrupted flow through a detour hose while pipeline repairs are made downstream. A factory replaceable sleeve means a long life for this versatile plug.

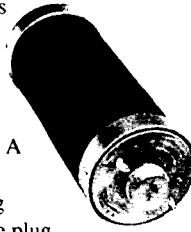

**PORTABLE WATERPROOFING SYSTEM**

Effectively stops groundwater from invading manholes

Fast and economical. When sealant flows into leaking area the groundwater stops automatically. Can be used with the Large Diameter Joint Tester.



**LARGE DIAMETER JOINT TESTER**

Made of 3-piece aluminum channel, any size of joint tester will fit down a 24" manhole. Easy to assemble and use. Joint testers roll on wheels to test joint after joint quickly. Water Test Kit and Sealing Sleeve Conversion Kit available.

Available in metric sizes.



24" - 120"

STANDARD PRODUCT

**LARGE MULTI-SIZE PLUGS**

Three plugs (15" to 60") expand to cover a wide range of large pipeline inside diameters. Reinforced with polycord these natural rubber plugs are designed to insure a positive seal in any pipe within the sealing range of the plug.



**LARGE SINGLE-SIZE TEST-BALL®  
AND MUNI-BALL® PLUGS**

Designed to be lightweight and able to fit down any manhole. Vinyl-coated polyester body with two rubber sealing rings. Size range available 24" to 72" and in By-Pass or (Non) By-Pass designs.

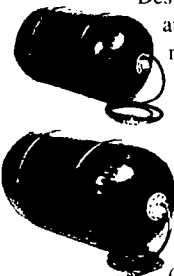

# SERVING THE INDUSTRY IN OVER 40 COUNTRIES

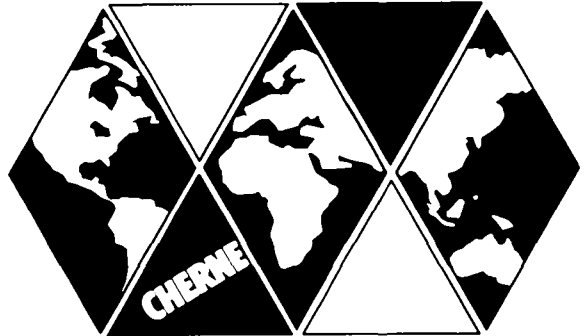

## CHERNE INDUSTRIES PLUMBING & MUNICIPAL PRODUCTS

Over the past thirty-five years Cherne Industries has been the leader in pipeline testing, plugging and sealing technology. We have always met the expectations of our customers with our superior design, high quality and unmatched service.

**CONTACT US  
FOR THE NAME OF YOUR CLOSEST DISTRIBUTOR.**

**CHERNE INDUSTRIES, INC.**  
5701 South County Road 18  
Minneapolis, MN 55436 USA  
Telephone: (612) 933-5501  
Telefax: (612) 936-6601  
Telex: 291147



## LEAK DETECTION AND CONTROL

underwater pipe inspection and leak location, sub-surface mapping. Services provided for municipalities, manufacturers, colleges, contractors, apartments, condominiums, government installations.

**METROTECH CORPORATION** 670 National Avenue, Mt View, CA, 94061, USA, Tel: +1-415-940-4900, Telex: +6502726454MCI UW, Fax: +1-415-962-9527, Contact: Pei Hsien Fang. Metrotech Corporation designs, manufactures and sells advanced electronic underground utility locating instruments: pipe and cable (including fiber optic) locators and tracers, 50/60Hz, iron and steel, valve box/pedestal and water leak locators.

**MILLER PIPELINE CORPORATION** PO Box 34141, Indianapolis, IN, 46234, USA, Tel: +1-317-293-0278, Fax: +1-317-293-8502, Contact: Henry Tops. Manufacturers of internal pipe seals (the WEKO seal, the AMEX-10 seal) and the 32-400 lining system, for resolving leakage and corrosion and red water problems. Also manufacture vacuum excavation equipment.

**PALMER ENVIRONMENTAL SERVICES** 6 Knightwood Court, Capton Hall Industrial Estate, Great Yarmouth, Norfolk, NR31 0NG, UK, Tel: +44-493-600563, Telex: 975313, Fax: +44-493-653427, Contact: Sonja Taylor. Manufacturers of a leak noise correlator - for the detection of leaks in underground water pipes. Also offer pipe & cable location equipment and a leak detection, mapping and consultancy service.

**POLLULERT SYSTEMS** 3029 E Washington St, P O Box 706, Indianapolis, IN, 46206, USA, Tel: +1-317-261-1442, Fax: +1-317-261-1581, Contact: Judy Spray. The Pollulert fluid/vapor system has been designed and developed by Emhart/Mallory to monitor leaks of storage tank systems. Pollulert probes can be used in a wide range of applications including monitoring wells, double-wall tank annular spaces, manway sumps and piping trenches. They require no calibration.

**RETEN ACOUSTICS LTD** 47 Church Rd, Newport, Gwent, NP9 7EL, United Kingdom, Tel: +44-633-59910, Telex: 498037, Fax: +44-633-244012, Contact: Mr K Roy. Electric manufacturing company producing leak detection equipment employing the correlation principle, data loggers and CCTV systems. Also leak location and distribution system surveying.

**SEBA DYNATRONIC** Industriestrasse 6, Baunach, D-8611, Germany, Tel: +49-9544-680, Fax: +49-9544-2273, Contact: Theo Wiedemann. Instruments for leak detection, water loss analysis, cable fault location and consultancy. Especially: locators for metallic and non metallic pipes, leak detectors, correlators, pressure and flow meters.

**SEBA ROHRNETZ UBERPRUFUNGS GESELLSCHAFT mbH** A-9020 Klagenfurt, Sonnengasse 13, Austria, Tel: +43-4222/41670-41671/41672, Telex: +42082. Seba are specialised in the detection of leaks in water supply systems. In 1977 a process was developed with the aid of which both the locality and the size of leak can be determined. The "Water Loss Analysis ©" is in use in Austria, West Germany and many other countries.

**SPECTRASCAN LTD** 42 New Brighton Rd, Emsworth, Hants, PO10 7QR UK Tel: +44-243-379121, Telex: +9312102018, Fax: +44-243-371471. Spectrascan specialises in providing the equipment, software, and if requested, operational advice, best suited to running an efficient policy on leakage detection and the control of unaccounted-for water. Their special catalogue (available free by telephone request) includes detailed descriptions of sensors, displays, loggers etc, designed for the purpose, including mechanical and electromagnetic insertion probes for measuring flows in large pipes. Leak Noise Correlators can also be supplied, completing a truly comprehensive service.

**SUBTRONIC LTD** Butlers Leap, Rugby, CV21 3RQ, United Kingdom, Tel: +44-788-540640, Telex: 312242, Fax: +44-788-536606, Contact: Stewart Clewsy. Provide a service for the evaluation and detection of water leakage, and the mapping of water networks. Also supply the equipment and training necessary for such undertakings.

**TINKER & RASOR** P O Box 281, San Gabriel, CA, 91778, USA, Tel: +1-818-287-5259, Fax: +1-818-287-0132, Contact: Rick Claridge. Tinker & Rasor manufactures leak detectors and Detectron Model 505-Gofer pipe and cable locators. When it comes to tracing distance, depth penetration and sensitivity, the Model 505-Gofer rivals all other pipe and cable locators on the market.

**WEST COAST LOCATORS** Box 1810, San Jose, CA, 95109, USA, Tel: +1-408-294-9368, Contact: Frank Zamira. Pipe locating and leak detection specializing in detecting and surveying leaks on fluid and gas lines, locating underground utilities such as water, gas, sewer, electrical, telecommunication cable, and pressure-testing new and existing line.

### Fittings For Pipes

**B V MACHINEFABRIEK EN IJZERGIEKERIJ V/H Rogier**, Nerinx, Richter Wattweg 3, Postbus 40, Bergen op Zoom, 4600 AA, The Netherlands, Tel: +31-6140-33050, Telex: 78228, Fax: +31-1640-575-36, Contact: Mr Vastianan. Manufacturer of cast iron fittings for water and gas pipelines to be used for cast iron, asbestos-cement and PVC pipes. Also couplings for pipelines.

**HAKOHAV LTD** 16 Hasat St, Holon, 58855, Israel, Tel: +972-3-800447, Fax: +972-3-806514, Contact: Mosseri Isaac. Manufacturer of wafer type butterfly valves, strainers and non return valves. Import and sales of all kind of valves from DN50 and up.

**HYDRONAMIC ENGINEERING CORP** PO Box 1736, 186 Viking Avenue, Brea, CA, 92622, USA, Tel: +1-714-990-0583. Manufacturer specializing in flow control components for home RO systems. Also check valves, pressure relief valves, flow restrictors and complete flow control units. (WT)

**KOMPOTEK** Jillerbackel 1-7, Ban Hagen, 1242, Sweden, Tel: +46-8-749-1860, Telex: 13T05, Fax: +46-8-661-90, Contact: Kurt Anderson. Valves and automatic



# MILNES

## PIPE FITTINGS

Milnes group of companies offer an extensive range of pipe fittings to satisfy the requirements of the pipeline industry. Milnes fittings usage is extensive into the fields of irrigation water supply, gas reticulation, mining, sewerage and the chemical and manufacturing industries.

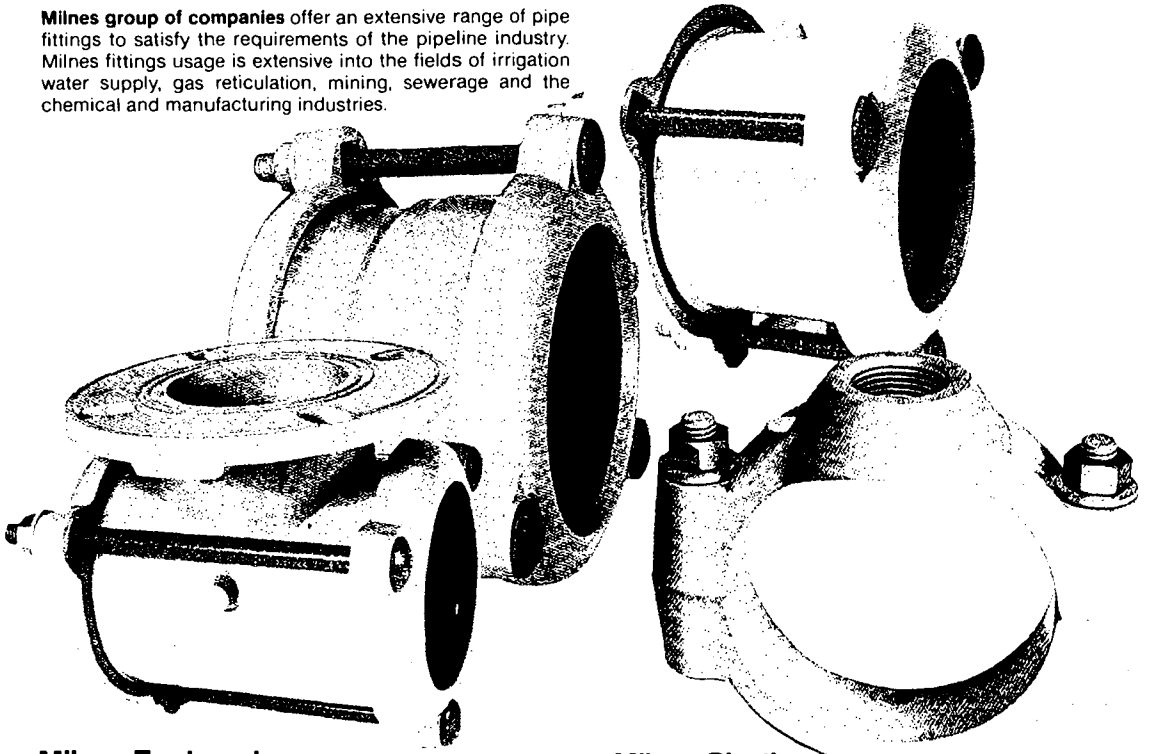

### Milnes Engineering

Providing a range of over 300 standard mechanical pipe fittings in non-ferrous materials such as hard epoxy coated aluminium, bronze gunmetal for high corrosion resistance applications. Fittings which include tapping saddles, joiners, expansion joints, tees, crosses, transition couplings, repair joints, all form a part of a large range of available fittings.

### Milnes Plastics

Specialising in the manufacture of a complete range of polyethylene pipe fittings including flanges, tees, bends and reducers from 25mm to 1000mm. Milnes also offer a comprehensive range of butt fusion machines specially designed to suit both harsh field conditions and factory fusion. Fittings and fusion equipment can be manufactured to suit special requirements.

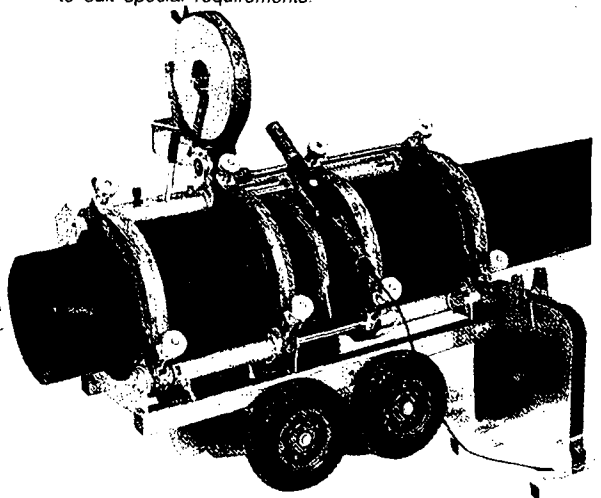

### AUSTRALIA

MILNES PLASTICS, MELBOURNE  
32 Klauer Street,  
Seaford, Victoria, 3198.  
Ph: (03) 786 2411, Fax: (03) 786 2230

MILNES ENGINEERING, BENDIGO  
Marong Road,  
Bendigo, Victoria, 3550.  
Ph: (054) 41 3022, Fax: (054) 41 3302

MILNES PTY. LTD., SYDNEY  
49 Heathcote Road,  
Moorebank, N.S.W. 2170.  
Ph: (02) 601 1233, Fax: (02) 600 7840

CANADA  
MILNES FUSIONMASTER,  
ONTARIO: Fax: 1-416 847 9183  
**NEW ZEALAND**  
MILNES NEW ZEALAND  
AUCKLAND

All our production is designed  
and realized in order to guarantee  
the safety and easiness of use  
in the irrigation field, drinking water  
and chemical products supplying



**ESSE BI PLASTIC** s.r.l.

Production of P.P. and P.V.C.  
pipe fittings for irrigation  
and the building industry

Via La Forma, 1  
60020 Sirolo (AN)-Italy  
Tel. 071/7360014-5  
Telex: 560606 HARRAI  
Fax: 071/936787

## FITTINGS FOR PIPES

products which consist of electro pneumatic actuator and all electric actuators.

**MARLEY WERK GESELLSCHAFT mbH** A-4053 Haid/Anselden, Industriestrasse 15, P O Box 57, Austria, Tel: +43-7229/30-01, Telex: +02-1939 marley a. For water supply and disposal purposes Marley offer a complete pipe range - PVC and PE pressure pipes, an HT pipe system of propylene of permanent 100 degrees heat resistance for waste water disposal and various pipe systems for house and road sewers complete with various PVC fittings. Marley also turn out special custom-made pipes for water handling, channels for nursery-garden irrigation and gutters for carrying away rainwater from roofs, complete with all the necessary fittings.

**MIDDLE EAST TUBE CO LTD** P O Box 788, Haifa, 31007, Israel, Tel: +972-4-910467, Contact: R Freund. Makers of steel pipes. Akko plant: water and gas pipes 1/2" - 4" galvanized and black, line pipe 3" - 6", seamless pipe 1/2" - 4". Ramla plant: line pipe 6" - 20" longitudinal h. f. weld, 20" - 80" spiral DSA welded. Corrosion protection: concrete lining, cement mortar coating, bituminous and tape coating, bends, branches and shapes, lined and coated.

**NUOVO PIGNONE** Via Tiburtinamk 12.7 00131 Rome Italy is one of the leading designs and manufactures of machinery and equipment for gas, water, petroleum and petrochemical industries. Nuovo Pignone's main products are: Reciprocating and centrifugal compressors, Gas and steam turbines, Centrifugal pumps, Ball

valves and valve actuators, Fabricated equipment, Control and safety valves, Process computers, Automation and remote control system.

**PACIFIC INTERNATIONAL PIPE & ENGINEERING INC** PO Box 11305, Portland, Oregon, 97211, USA, Tel: +1-503-285-8391, Fax: +1-503-286-0603, Contact: Mr Jack Williams. Manufacturers of concrete pipes from 4" to 144" for gravity sewers. Pacific International also manufacture box culverts, catch basins and manholes.

**PERMA-PIPE** 7720 North LeHigh Avenue, Niles, Illinois, 60648, USA, Tel: +1-312-966-2150, Telex: 9102408792, Fax: +1-312-966-8563, Contact: Mr Fati Elgendy. Manufacturers of heated and cooled fluid lines for new communities.

**PLASTIC CONSTRUCTION (FABRICATIONS) LTD** Evelyn Rd, Sparkhill, Birmingham, West Midlands, B11 3JJ, UK, Tel: +44-21-773-4951, Telex: 336747, Fax: +44-21-772-3588, Contact: Cath Hancox. Plastic Constructions offer pumping station wet well extraction systems, fume scrubbers and fans, FRP pipework for pressure mains and sea water intakes and corrosion resistant plant equipment.

**POLYTUBES (1977) LTD** PO Box 3814 Stn D, 12160 160 St, Edmonton, Alta, T5H 4J8, Canada, Tel: +1-403-452-8375, Fax: +1-403-452-8397, Contact: L M McCaffery. Polytubes (1977) Ltd has been in the polyethylene tubing and pipe business for 36 years. We manufacture tubing and pipe from 1/4" to 6" diameters in low, medium and high densities. We also specialise in custom extrusions.

## PIPE LUBRICATION

Don't take our word for it - ask the people who depend on it.

Bentley's range of pipe jointing, lubricants and sealing compounds have been formulated to meet the needs of the discriminating engineer and the cost conscious Water Authority.



Leading suppliers to Water Authorities and many pipe manufacturers throughout the world, including Europe, the Middle East and Africa.

**VINOLEO 77/14** Pipe jointing lubricant for plastic.

**VINOLEO 80/2** Pipe jointing lubricant for ductile iron, asbestos cement, and plastic.

**VINOLEO 80/9** Pipe jointing lubricant for plastic.

**WRC MEDLUBE** Bactericidal pipe jointing lubricant.

**VINOLEO WT 90** Tap and valve lubricant.

**HYLOSIL** Silicone sealing compound.

Further information from:

**ISAAC BENTLEY & CO LTD.**

Hylo House, Cale Lane  
New Springs, Wigan WN2 1JR  
Tel: Wigan (0942) 824242 (10 lines)  
Telex: 67230  
Fax: (0942) 826653 (1 line)



*Market  
Leadership*

 Viking Johnson Limited have a world of experience and are recognized as market leaders in pipe jointing.

Viking Johnson keep pipelines flowing with a range of couplings and fittings that give not only security against leaking pipes and joints, but security of supply on time and in the right place ....

.... wherever you are.



**Viking Johnson  
Limited**

T H R O U G H  
I N N O V A T I O N

PO Box 13, 46-48 Wilbury Way, Hitchin, Hertfordshire SG4 0UD, UK.  
Tel: (0462) 422622 Telex: 825026 VICTLC G Fax: (0462) 422072  
International Tel: +44 462 422622 International Fax: +44 462 422072

# Meet Our Company of Performers

## Typical Water Distribution System

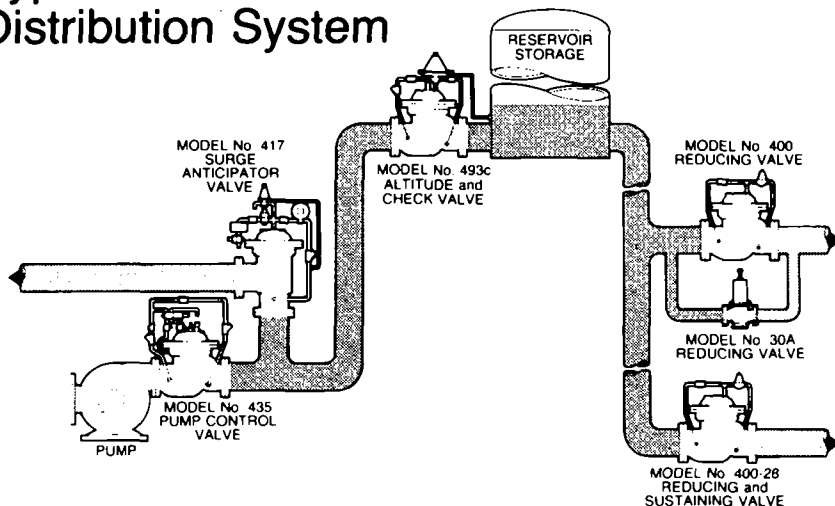

## Bailey Control Valves and Strainers

Bailey manufactures pilot and direct operated piston or diaphragm valves (up to 36").

- Pressure reducing
- Pressure relief
- Liquid level
- Pump surge control
- Remote control
- Solenoid shut-off
- High inlet pressure
- Severe throttling conditions

Other products available:

Backflow prevention devices and "Y" strainers.



A Division of CMB Industries

*Control Valves and Polyjets*

*For more information contact Bailey, A division of CMB Industries;*

P.O. Box 8070 • Fresno, CA 93747 USA • (209) 252-0791

Telex: 33-7616 CMB FSO • Fax: (209) 453-9030

# PEGLER. BRINGING BRITISH ENGINEERING EXCELLENCE TO THE WORLD

Over the last 60 years, Pegler International have earned a reputation for quality craftsmanship, superior product reliability and a service that's second to none.

Today, our comprehensive product range is available in

over 100 countries worldwide.

And, thanks to a policy of continued investment in new technology and improved production techniques, we can maintain, and even better, the standards you've come to expect from Pegler International.



**PEGLER**  
**INTERNATIONAL**

St. Catherine's Avenue, Doncaster, South Yorkshire, England.  
Telephone: 0302 855656. Telex: 547166. Fax: 0302 67661



**LUXURY**  
**DANUM**  
**POLO**  
TAPS & MIXERS

**FORGED BRASS**  
**ENGINEERS**  
**VALVES**  
GATE VALVES

**RADIATOR**  
**TERRIER**  
**BELMONT**  
VALVES

**BRASSWORK**  
**YELLOW**  
**METAL**  
BRASSWORK

**HEATING**  
**SUNVIC**  
CONTROLS

**TAPS**  
**STANDARD**  
**CHROME**  
TAPS

**GUNMETAL**  
**ENGINEERS**  
**VALVES**  
GATE VALVES

**COMPRESSION**  
**PRESTEX**  
FITTINGS

# MORE EFFECTIVE PROTECTION DEVICES ARE NEEDED TO MEET WORLDWIDE DEMAND FOR UNPOLLUTED DRINKING WATER

**The passing of each year sees an increasing demand worldwide for higher quality, less polluted drinking water supplies.**

The problems of pollution exist not only in the heavier industrialised regions of the world but also in the lesser developed rural and agricultural areas. The nature and causes of the pollution may be different but the effects can be equally damaging to the health of the people.

Many international bodies, such as the United Nation's World Health Organisation, and national agencies and organisations concerned with health, water distribution, water supplies etc. are constantly striving to improve the present situation. Numerous forms of legislation have been introduced to combat pollution, but ultimately the onus

rests on the water distribution organisations and agencies to implement effective protection devices and controls wherever possible.

Pollution and contamination of drinking water is very often caused by pressure variation in the water supply which results in backflow or backsiphonage, particularly where there are a high number of cross-connections within the water supply circuits.

Over the years, considerable design and development work has been undertaken to provide an effective answer to the problems, even so, there can never be any one universal solution as each water circuit exhibits its own particular characteristics.

However, a range of non-return valves has been developed to meet specific applications where design, construction and internal closing systems enable the requirements of the installations to be most closely matched. These valves have been designed to give extremely good operating characteristics such as low headlosses, *minimum hammer*, tight sealing, quiet operation, robustness and reliability. Most importantly, they offer a high degree of protection against pollution and contamination from waste water returns.

These valves are ideally suited to meet a wide variety of day-to-day applications throughout the world, including domestic and mains water distribution, pumping and irrigation and numerous industrial processing requirements.

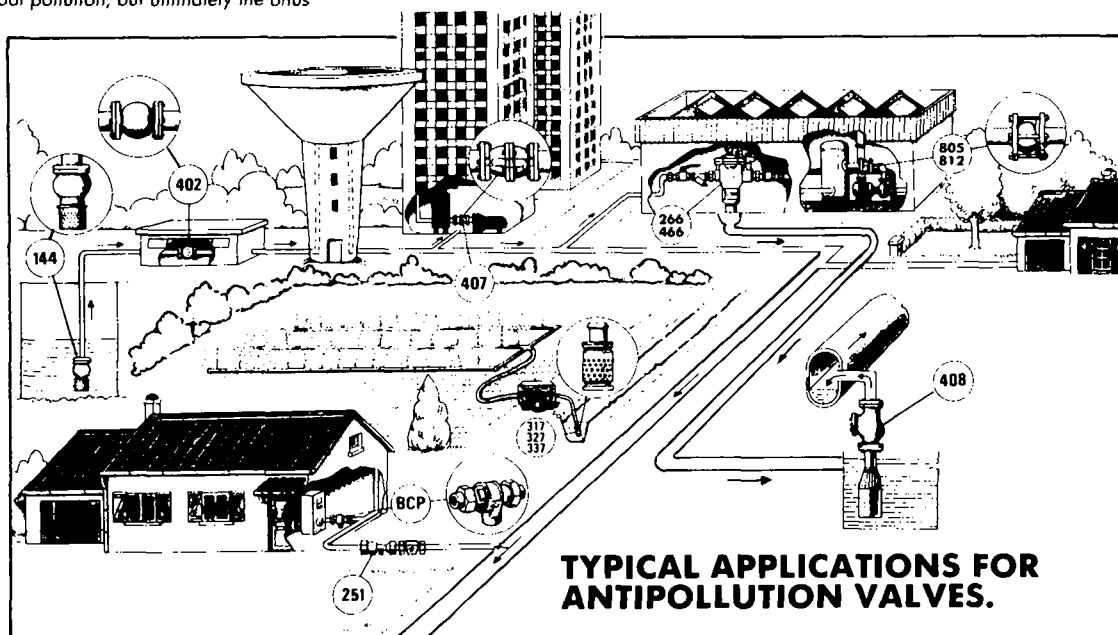

**TYPICAL APPLICATIONS FOR ANTIPOLLUTION VALVES.**

## VALVE DESIGN – INTERNAL CLOSING SYSTEMS

The type of internal closing system employed is a critical design feature of any valve and particularly so in the case of non-return check valves. There are a number of basic valve families which can be considered to be applicable to the water/sanitary field. These are based on the direction of the displacement of the closing system in relation to the flow of water.

### 1. Non-parallel linear displacement

This family incorporates perpendicular displacement valves with straight flap and oblique displacement valves with oblique flap.

### 2. Angular displacement

This type incorporates such as lift valves and butterfly valves where the closing system is hinged or pivoted.



### 3. Deformable closing systems

These types of valve incorporate a flexible membrane as the closing system which is particularly suitable for pumping duties.



### 4. Parallel linear displacement

This family incorporates valves with 'guided' internal closing systems which are generally preferred for areas of greater pollution risk due to the positive closing and sealing characteristics of this particular design. A wide range of anti-pollution check valves also incorporate this type of system.



## BACKFLOW PREVENTERS

In areas of extreme high risk the more conventional types of check valve are not suitable for prevention of pollution. SOCLA have therefore developed a series of Backflow Prevention systems and vacuum breakers which can replace the more conventional and traditional break tank.

The Backflow Preventers incorporate two check valves with a relief valve. They operate on the variation of three decreasing pressures created by the headlosses of the two check valves. Any reversal of pressure from backflow and/or back siphonage is sensed by a membrane actuating a relief valve which will drain polluted water to atmosphere.

**Regardless of location, the implementation of effective controls will enable pollution and contamination of drinking water supplies to be eradicated to the overall benefit of mankind.**

Author: Mr. Jacques Chaise  
Marketing Director **SOCLA, France**



# POSITIVELY THE BEST PROTECTION AGAINST BACKFLOW

SOCLA has specialised in the development of check valves, backflow preventers and foot valves for over 60 years. During this time numerous valves have been manufactured and installed in water supply and distribution systems worldwide. Available in sizes from 1/4" to 32" diameter, SOCLA valves offer the very best protection against backflow.

## BALL CHECK VALVES



Ideal for handling sandy and waste/polluted water. Ball ensures positive sealing and low headloss. Available in sizes from 1" to 3" and 50mm to 350mm diameter.

## CHECK VALVES

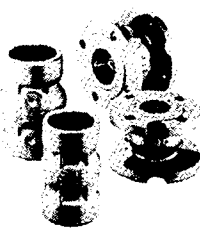

Applications include water distribution, irrigation, pumping, water processing, river and sea installations. These valves offer excellent hydraulic performances with minimum hammer. Sizes 50mm to 350mm diameter.

## MINIMUM SPACE



The SOCLA range of Water check valves are ideal for pumping, irrigation, water treatment and distribution. Controlled opening and compact construction. Sizes 15mm to 600mm diameter.

## FOOT VALVES WITH STRAINER

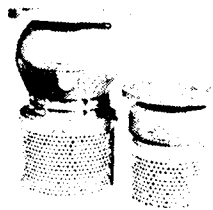

Particularly suitable for pumping applications, these valves provide perfect sealing with low headlosses. Compact and robust they are available in sizes 50mm to 800mm diameter.

## NEW CONTROL VALVES

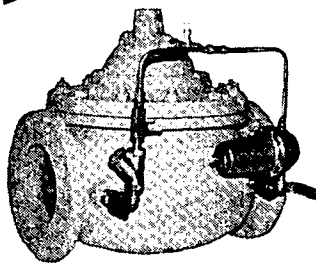

Designed for controlling and maintaining pressure and flow. Particularly suitable for automatically controlling pumps, water surge, tank level, upstream or downstream pressure. Ten basic styles to choose from. Available in sizes 80mm to 300mm.

## NEW GENERATION BACKFLOW PREVENTER

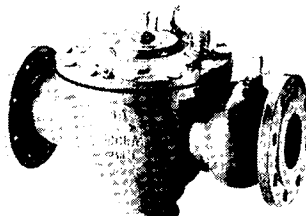

Reduced pressure backflow preventers for total protection of drinking water supplies. Particularly suitable for preventing cross connection pollution in pressure systems. Sizes 3/4" to 2" (Types 2266/2660) and 65mm to 250mm (Type 4660).

# SOCLA<sup>®</sup>



**SOCLA SA FRANCE**  
1, Rue Paul Sabater - BP300  
71107 Chalons s/Saone Cedex  
FRANCE  
Tel: (33) 85 46 30 34  
Fax: (33) 85 41 49 31  
Telex: 800259 SOCLA CHALN

**SOCLA (UK)**  
Station Road Industrial Estate  
Stokesley, Middlesbrough,  
Cleveland TS9 7AB  
UNITED KINGDOM  
Tel: (0642) 712304  
Fax: (0642) 710907  
Telex: 587371

**SOCLA GmbH**  
Hommelsheimstrasse 23  
D6308 Rheinbach-Flerzheim  
WEST GERMANY  
Tel: (02225) 604142  
Fax: (02225) 12318  
Telex: 8869507

**SOCLA ITALIA srl**  
Via dei Fontanili, 13  
20141 Milano  
ITALY  
Tel: (02) 8463403  
(02) 8435825  
Fax: (02) 8467764

**FLOMATIC CORPORATION**  
Mill Lane  
PO Box 100, North Hoosick  
New York 12133  
U.S.A.  
Tel: (518) 6867381  
Fax: (518) 6865670  
Telex: 145359

More than 40 years experience is the background of the wide range of AVK products.

Today the AVK products are produced by a staff of highly skilled workers at factories in Denmark, the United Kingdom and the Kingdom of Saudi Arabia.

The main product of the AVK range is the AVK gate valve. The basis of the AVK gate valve today is a safe and rugged construction which was introduced in 1982 after one and a half years investigations and development.

From this construction the AVK gate valve is produced according to various standards, with various connections, and in various variants. Through routines executed in the AVK production as specified in the AVK Quality Manual, the high quality of the AVK gate valves are secured.

To underline the high quality of the AVK gate valves, *all* valves are subject to a 100% pressure test before leaving the factory.

The AVK products are distributed through a network of subsidiaries, dealers and agents throughout the world.

Where no distributor is appointed, sales are taken care of by AVK/Scan-Wass Group A/s.

AVK/Scan-Wass Group A/s has built up contacts and has obtained several sole agencies of products, which are not in the standard AVK program and which enables AVK/Scan-Wass Group A/s to supply a total package for the water and gas distribution systems.

*If you have a need -  
AVK will fulfill it!*

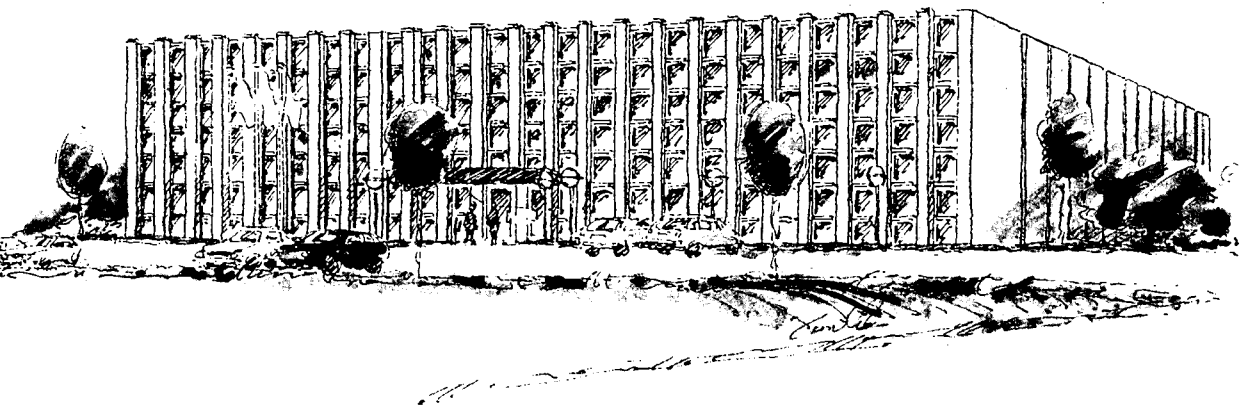

# AVK

## HIGH QUALITY VALVES

- wherever you are  
in the world

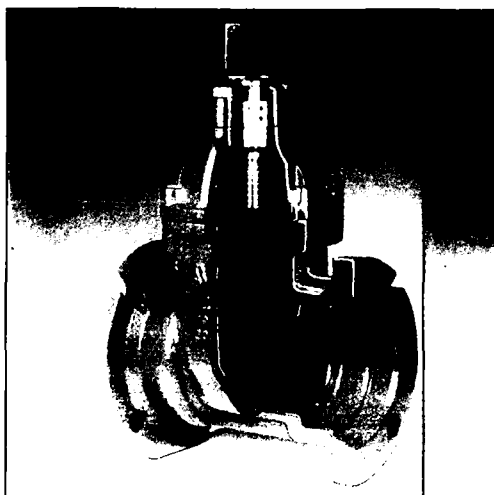

AVK series 25  
acc. to AWWA C-509

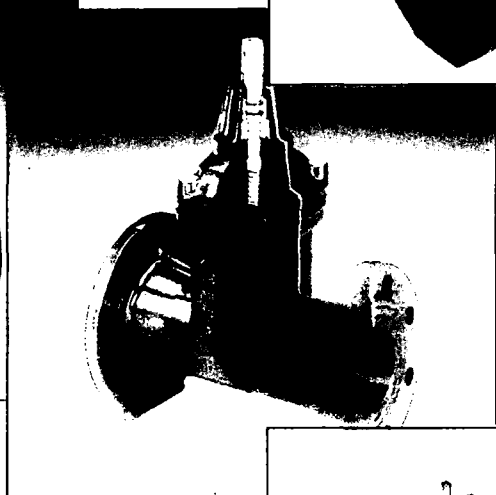

AVK series 20  
acc. to  
DIN 3352 part 4

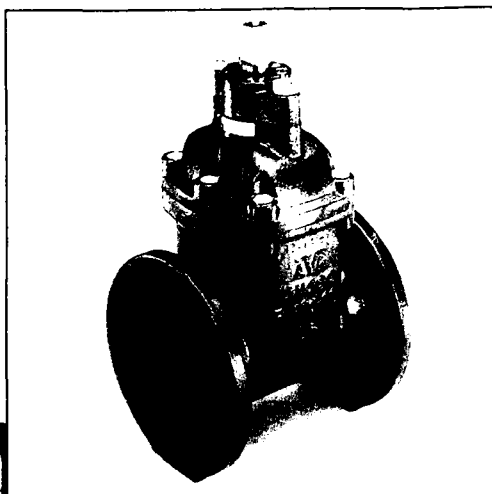

AVK series 21  
acc. to  
BS 5163

HIGH QUALITY SECURES  
A LONG AND MAINTENANCE -  
FREE LIFE

A wide range of valves with  
various different pipe-connections,  
accessories, and complementary  
products.

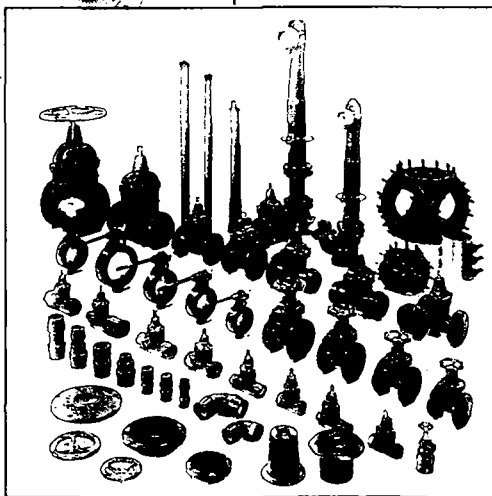

# AVK

## SCAN-WASS GROUP A/S

AVK/Scan-Wass Group A/S  
Bizonvej 1 · Skovby  
DK-8464 Galten

Tel. + 45 6 94 60 66  
Telex 64572 avksw dk  
Telefax + 45 6 94 62 38

# In the world of valves, this is the only kind we make.

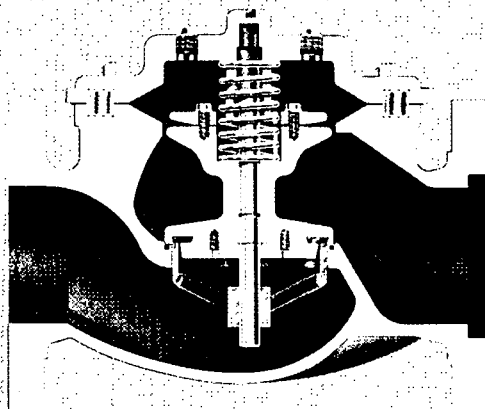

## But we make a world of different models.

Fully automatic, line pressure operated,  
diaphragm actuated, pilot controlled.

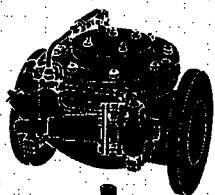

Pressure  
Reducing  
Series 127

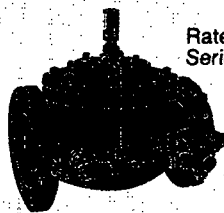

Rate of Flow  
Series 120G

Float Controlled  
Series 8000  
& 8100

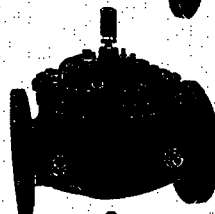
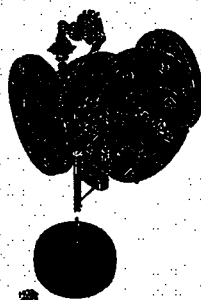

Diaphragm  
Check  
Series 94

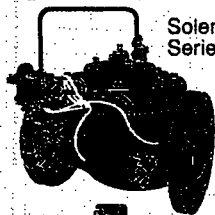

Solenoid Controlled  
Series 115

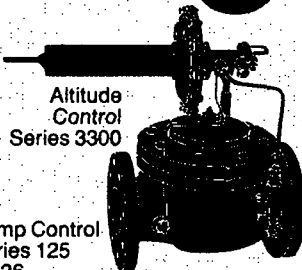

Altitude  
Control  
Series 3300

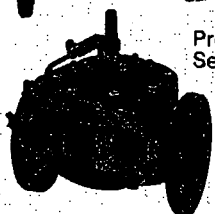

Pressure Relief  
Series 108, Fire  
Pump Relief  
108FC & Surge  
Anticipation  
Series 118

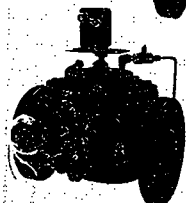

Pump Control  
Series 125  
& 126

Available in sizes 1 1/4" - 16", 32mm-400mm

# OCV Control Valves

7400 East 42nd Place/Tulsa, Oklahoma 74145-4788 U.S.A.  
Phone 918 627-1942/TWX 910-845-2227/FAX 918 622-8916

**"SEGEV"-Model S-030(\*)**

**A.R.I. Automatic Air Release Valve**

*Description*

The "SEGEV" automatic air release valve releases air from lines in which air flows under pressure. This revolutionary valve is the development based on many years of experience. The automatic air release valve is the first of its kind in the world. Due to its compact and lightweight structure, it has the ability to release large quantities of air.

**"BARAK"-Model B-010(\*)**

**A.R.I. Combined Air Release Valve**

*Description*

The "BARAK" combined air release valve is a revolutionary product. It is the result of a long and intensive research and development process. The valve is made of high quality plastic materials and is designed to operate under highly pressurized conditions. It is a compact and lightweight device that can be easily installed in any pipe system. The valve is designed to release air from lines in which air flows under pressure. It is a revolutionary product that has many advantages over other air release valves. The valve is made of high quality plastic materials and is designed to operate under highly pressurized conditions. It is a compact and lightweight device that can be easily installed in any pipe system. (\*Patented)

**"REGEV"-Model R-020**

**A.R.I. Check Valve**

*Description*

The "REGEV" check valve allows flow in only one direction and is made of high quality plastic materials. It can operate under highly pressurized conditions.



**ARI** Kfar Charuv  
Water Supply Accessories

OFFICE: 12 SHEFA TAL st. TEL AVIV 67013 ISRAEL  
TEL 972 3 253-1402

FACTORY: KIBBUTZ KFAR CHARUV  
RAMAT HAGOLAN 12950

TEL 06 763390, 763653 TELEX 6731 ARI IL FAX 972-6-763402

# A new standard in pipe joining

## Universal use

- Joins pipes of the same or different materials
- Suitable for pressure or suction pipelines
- No leakage of liquid or gaseous media or solids
- Repairs pipe damage rapidly and reliably
- Standardized joining and sealing principle for all materials and pipe diameters

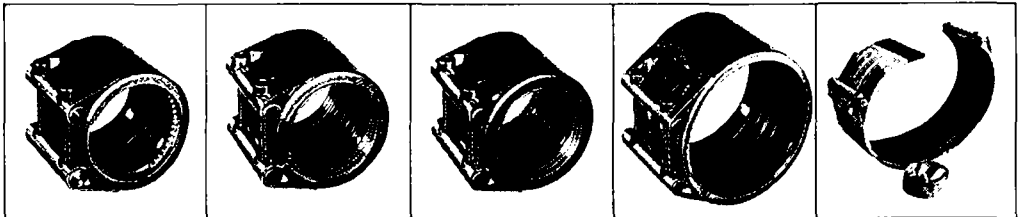

### STRAUB METAL GRIP

- Axial-restraint pipe joints
- For all metal pipes
- Up to 16 bar
- 38 to 355.6 mm dia.

### STRAUB PLAST GRIP

- Axial-restraint pipe joints
- For all plastic pipes
- 16 bar
- 63 to 160 mm dia.

### STRAUB COMBI GRIP

- Axial-restraint pipe joints
- For transitions from plastic to metal pipes
- 16 bar
- 75 to 160 mm dia.

### STRAUB FLEX

- Pipe joints not subjected to tensile forces
- For all pipe materials
- Up to 40 bar
- 48.3 to 2.000 mm dia.

### STRAUB REP

- Repair clamp for all pipe materials
- Up to 16 bar
- 48.3 to 1.200 mm dia.

## Reliable

- Progressive sealing and gripping force
- Waterhammer and shockproof
- Vibration proof
- Long-life, low-stressed seal
- Pressure-resistant and no leaking even with inaccurate pipe butt joint
- Installation without fire or explosion hazard

## Trouble free and maintenance free

- Stress-free pipe joint. Misalignment up to 2° on any side
- No leakage, even when longitudinal expansion takes place (FLEX)
- High chemical resistance of seal
- Damps waterhammer, vibration and structure-borne noise
- Resistant to corrosion

## Economical

- Simple and rapid installation – cut pipes to length, ease on coupling, pull pipe ends together and tighten 2 screws
- No costly aligning and fitting work
- Direct installation without preassembly
- No machining of pipe ends
- Ready-to-use pipe coupling – no other tools and setting-up times
- Easy servicing – removable and reusable

## Space and weight saving

- Compact design for space-saving pipe installation
- Smaller diameter insulation, smaller through-holes
- Screw lock position can be selected, single-point closure
- Low weight – handy

**straub** 

The Pipe Joint

For further details please contact us!

Straub Kupplungen AG, CH7323 Wangs / Switzerland Tel. 085 20191 Tx 85 55 45 strw ch Fax 085 27266

# plastic pipe fittings and valves

clunio pubblicità



A complete range whose quality is accepted worldwide.  
Our products are a sure and easy solution for irrigation, potable water supply,  
chemical fluid handling, or any pipe installation problem.



*ASTORE S.p.A.  
16141 GENOVA - ITALY  
Passo Ponte Carrega, 42 r.*

*Tel. 010/862300-861890-865767- 858503-850277  
Telex 286507 ASTORE I  
Fax 010/864318*

135 years  
of  
experience  
to lead  
the future

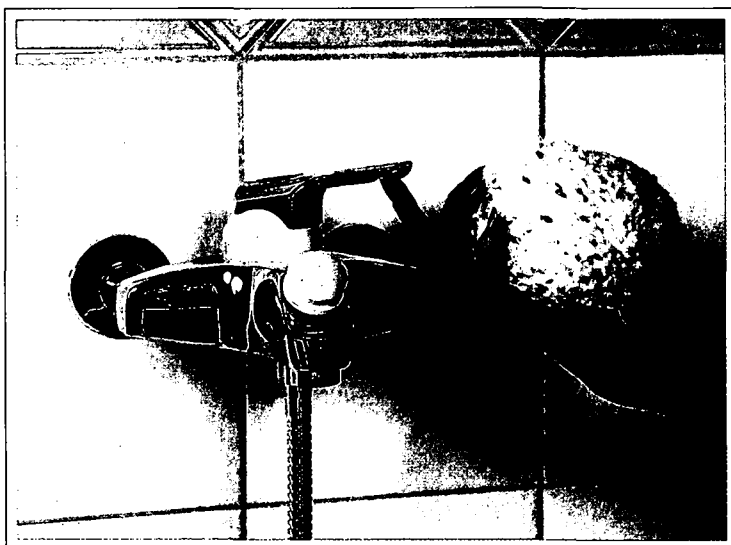
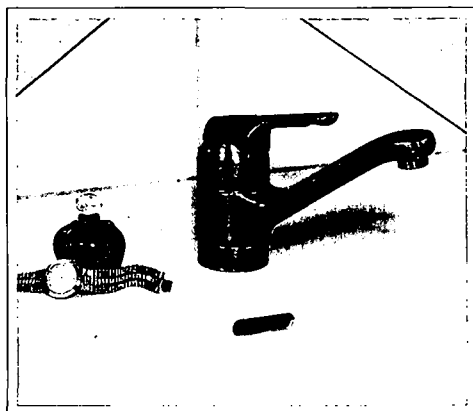

KUGLER products  
for modern and quality  
conscious people.  
The standard  
you always dreamed of.

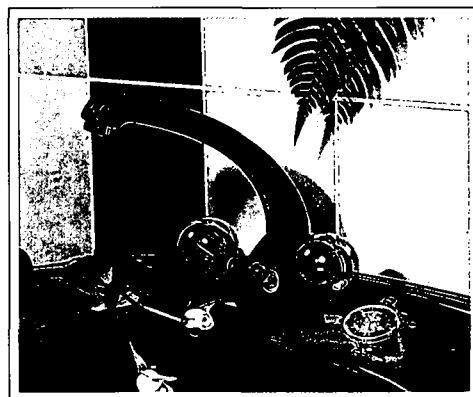

**KUGLER**

FONDERIE ET ROBINETTERIE S.A.

Case postale 240  
CH-1211 GENÈVE 8  
Tél. (022) 21 83 33  
Télex 422 658

**kugler**



## FITTINGS FOR PIPES

**PREMABERG LTD** Premaberg House, 22-24 High St, Halstead, Essex, CO9 2AP, UK, Tel: +44-787-475651, Telex: 987806, Fax: +44-787-474309, Contact: Vivian Maile. Equipment and services for pipeline maintenance including underpressure connections and pipeline plugging, leak repair clamps, portable pipe cutters, pipeline cleaning pigs and pressure testing.

**PRESTON INDUSTRIAL PLASTICS** Aqueduct St, Preston, Lancashire, UK, Tel: +44-772-555224, Fax: +44-772-59473, Contact: Mr McWilliam. Suppliers of all types of plastic pipes, fittings and building, engineering and fabrication materials to government and local authorities, utilities, and building and civil engineers. Specialist fabricators of chemical pressure vessels etc.

**PRICE BROTHERS CO** PO Box 825, Dayton, OH, 45401, USA, Tel: +1-513-226-8700, Telex: 155197, Fax: +1-513-226-8765, Contact: William Brown. Pre-stressed concrete pipe technology and related engineering services.

**REED MANUFACTURING CO INC** PO Box 1321, Erie, Pennsylvania, 16512-1321, USA, Tel: +1-814-452-3691, Telex: 75-2220, Fax: +1-814-455-1697, Contact: Mr John Schroder. Specialists in pipetools and pipe cutters particularly for the water industry. Can supply large diameter pipe cutters for water mains and distribution lines. Equipment compatible for use with a wide range of materials including cast-iron.

**SHERMAN INTERNATIONAL INC** 2131 Magnolia Avenue South, PO Box 1926, Birmingham, Alabama, 35201, USA, Tel: +1-205-252-6900, Telex: 5016012966, Fax: +1-205-322-4356, Contact: Clare Rutland. Manufacturers of concrete pipes for the water industry.

**SOCIETE DES TUYAUX BONNA** 91, Rue De Faubourg, Saint-Honore, Paris, 7536508, France, Tel: +33-266-9209, Fax: +33-142-660153, Contact: Mme Hallereau. Bonna is a leading company in the production of large diameter pressure and non pressure concrete pipes (prestressed or reinforced) for potable water, waste water, industrial water and irrigation.

### Pumping Stations

**A/S DE SMITHSKE** Tagholm 1, PO Box 205, DK-9400 Norresundby Denmark Tel: +45-9-8178111, Telex: 69620 desmi dk, Fax: +45-9-8175494. A/S De Smithske is a modern production and sales enterprise with a considerable technical know-how and with modern production and administration facilities. During the past years an intensive product development has resulted in new DESMI products within our entire range of centrifugal pumps and transmissions for the industrial and agricultural sectors. Please contact direct for further details.

# SAVE WATER REGULATE FUTURE RESOURCES

Water conservation has never been as important as it is today.

Too much waste – especially in developing countries – can literally mean the difference between life and death.

That's why it is encouraging to know that you can help maximise water conservation and run a highly efficient water distribution system thanks to IMI Bailey Birkett.

Our Class T and Class E pressure regulators have been specifically designed to ensure you get the right pressure at the right place at the right time, every single time. Without fail!

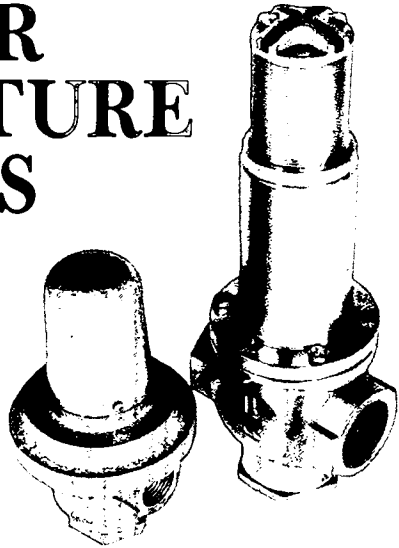

**IMI Bailey  
Birkett Ltd**

AN INVESTMENT IN PEACE OF MIND

**CLASS T AND CLASS E**

Manchester Office: Sharp Street, Worsley,  
Manchester M28 5NA, England.  
Telephone: 061-790 7741  
Fax: 061-799 4335 Telex: 669029.

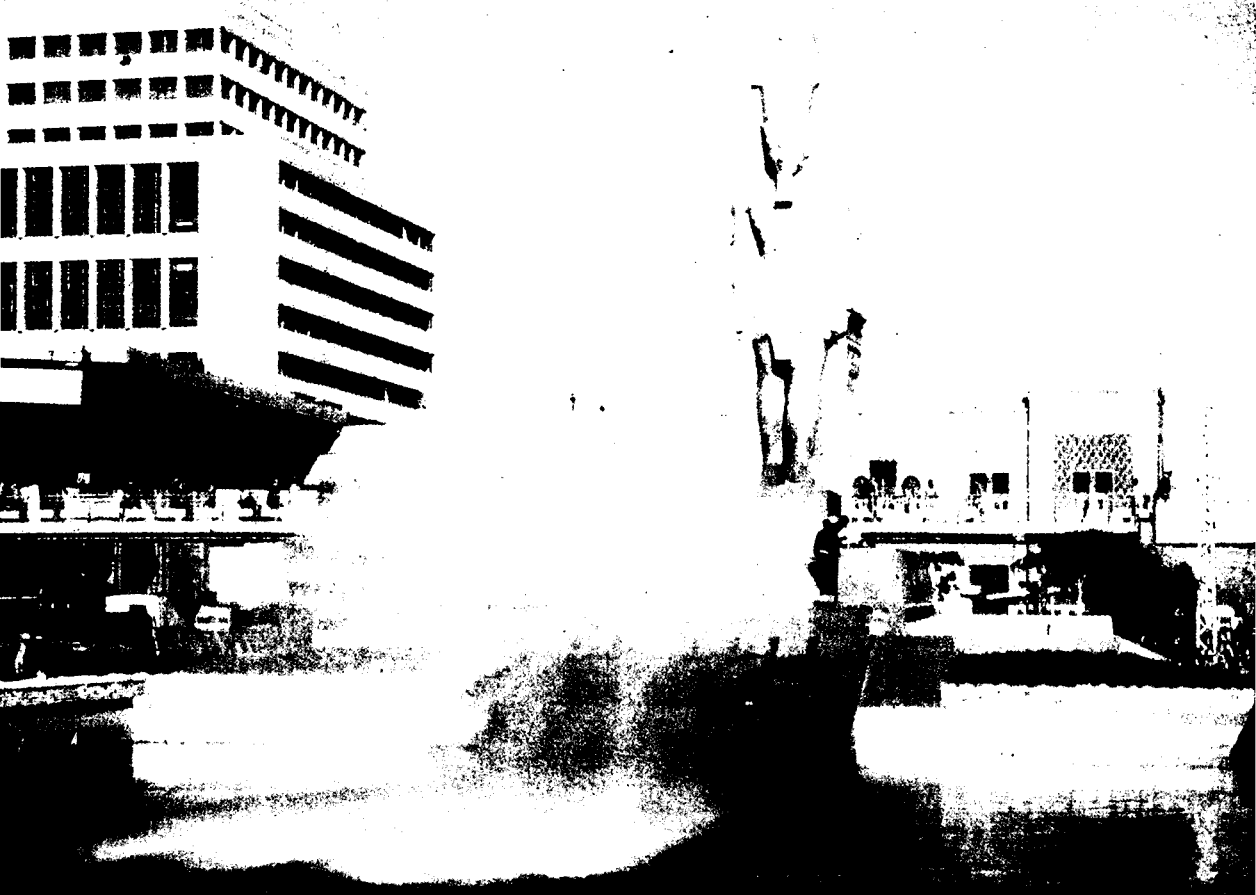

## WATER IS LIFE. OUR TECHNOLOGY CONTROLS WATER TO ENHANCE LIFE.

By 1988, Western Cairo's potable water distribution network, which is operated by the General Organization for Greater Cairo Water Supply (GOGCWS), will be monitored by a Nuovo Pignone supervision and remote control system.

This will make it possible to obtain real-time readings of the water flow rate, which is evaluated at 3,500,000 m<sup>3</sup> per

day, to receive quality and chemical-physical test data, to supervise the facilities' electric consumption and to monitor network equipment.

The turnkey project includes engineer-

**NuovoPignone**

Eni Group

00131 Roma, Italy - Via Tiburtina Km. 12,7  
Phone (+39 6) 4123456 - 4123634 - Telex 610250.

ing, supplying and commissioning the instruments, data transmission system and despatching centre, and fully meets GOGCWS's requirements.

This project is financed by a grant and is the result of the excellent relationship between the Egyptian and Italian governments and of the collaboration between Nuovo Pignone and GOGCWS.



ASSIR ACQUEDUCT (SAUDI ARABIA)  
8 MAINLINE PUMPS, EACH DRIVEN BY A  
10,000-HP VARIABLE-SPEED MOTOR.

## Water in the desert is not a mirage: it's technology.

Water is a precious element. And there are places, such as desert areas, where finding it and treating it effectively with the right technology, is of primary importance. Nuovo Pignone, accustomed to facing technological challenges successfully all over the world, can bring the same expertise to the water sector. In fact Nuovo Pignone is helping to solve the problem of a vital water supply for Assir, in Saudi Arabia. There, its pumps, using a technology perfected to meet rigorous oil pipeline specifications, will move one million cubic metres of water a day. The efficiency of the Assir desalination plant and aqueduct will be guaranteed by a real time computerized control system also supplied by Nuovo Pignone, whose Automation Systems Division has special experience in public utilities control. Nuovo Pignone: water in the desert is no longer a mirage.

**NuovoPignone**  
Eni Group

# In the Blazing Heat

COLD WATER IS WHAT YOU'LL NEED

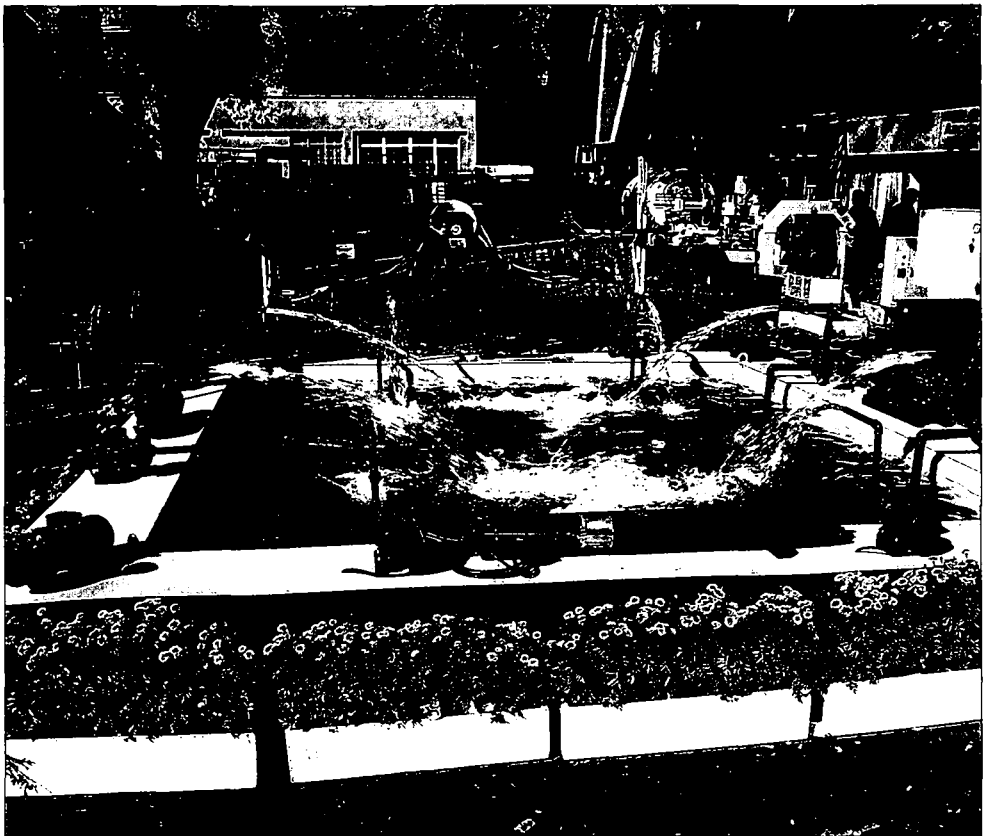

The Wide Range of 'Vida' Pumps Offer You:

- **Reliability**
- **Durability**
- **Easy Maintenance**

Exporter:

AGROMACHINAIMPEX  
1, St. Lepoev St.  
SOFIA, BULGARIA  
Tel. 23 03 91 Telex 022 563

# Pump Industry

- Vertical Turbine Pumps
- Submersible Pumps
- Centrifugal Pumps
- Mixt Flow Pumps

P.O. BOX 51066-145-10 KIFISSIA  
ATHENS · GREECE  
TEL: 8161712-8161702  
TLX: 215870 EMKA  
TELEFAX: 8161018



## PUMPING STATIONS

**ACME ENGINEERING COMPANY INC** P O Box 513, Cordele, Georgia, 31035, USA, Tel: +1-912-273-5587, Fax: +1-912-273-5124, Contact: Buddy Brake. We design, manufacture and install hydraulic trash rakes for pumping plants and hydroelectric plants.

**AGROMACHINAIMPEX** 1st Stoyan Lepoev Str. Bulgaria Tel: +211882, Telex: +22563. Agromachinaimpex FTO for Import, Export and Inland Trade with tractors, farming machines and equipment, dealing with engineering, technical attendance and service. The Export List of Agromachinaimpex Foreign Trade Organisation covers 16 pump families, produced each in many modifications, a reach range of irrigation equipments and drip irrigation.

**ARKANA EUROPE** P O Box 286, AG-Diemen, 1110, The Netherlands, Tel: +31-20-998537, Telex: 13399. Conrad drilling equipment for soil investigation, placer exploration (onshore and offshore) and water well drilling. Drill supplies in general. Hydraulically driven irrigation and deep well pumps. Auger pumping stations for irrigation, windmills, hydraulics powerpacks, winches (hydraulic and mechanical) etc. High pressure piston pumps for drilling chemicals (mud, foam etc), sewerage cleaning, diamond drilling and agricultural spraying etc. Diesel driven diaphragm pumps for very dirty water (ideal for contractors), for dewatering and pumping water from well points etc. Please contact direct for further information.

**BAILEY DIV OF CMB IND** P O Box 8070, Fresno, CA, 93747, USA, Tel: +209-252-0791, Telex: 33-7616 CMB FSO, Fax: +209-453-9030. Bailey, a division of CMB Industries has more than 60 years of control valve manufacturing experience. Bailey's pump control valve, Model 435 for Booster Pump Service (2" - 16") is designed to eliminate surges created when booster pumps are started and stopped. The Model 435W for Deep Well Service (2" - 16") is designed to eliminate surges caused by starting and stopping deep well pumps. The Model 435-30 (2" - 16") combines pump control function with pressure reducing capability. These pump control valves are available in a variety of materials and end connections which offer superior regulating ability.

**BIWATER PUMPS** Millers Rd, Warwick, CV34 5AN, UK, Tel: +44-926-411740, Telex: 317473, Fax: +44-926-410740, Contact: Mr Chatterton. Manufacturers of pumps - both solids - handling sewage pumps and submersive waste water pumps. Build pumps into complete pumping stations including mechanical and electrical. Manufacturers of compatible control panels.

**CONDRILL AB** Sveavagen 83 113 50 Stockholm Sweden Tel: +46-8-349560, Telex: +12336, Fax: +46-8-316762

**DAVEY PRODUCTS PTY LTD** 118 Atkinson St, Oakleigh, Victoria, 3166, Australia, Tel: +61-3-568-1655, Telex: AA139654, Fax: +61-3-568-4551. Manufacturers and marketers of pressure systems, end suction pumps - domestic, commercial and farm, swimming pool filters and pumps, spa bath pumps, engine driven pumps and pressure tanks.

**FLYGT AB** Box 1309 S-171 25 SOI.NA, Sweden. Tel: +46-8-733 6500, Telex: +43887 flygtab s, Fax: +46-8-295816, Contact: Anderz Öhringe. Flygt is the world's leading manufacturer of submersible heavy-duty pumps for contaminated and abrasive liquids. The annual sales for 1988 was approx SEK 2.3 billion. With over 1,250,000 installations in more than 100 countries throughout the world, Flygt submersible products encompass an awesome range of pumps, mixers and hydro turbine generators for small scale hydro electric power stations. The main office is situated in Solna, just outside Stockholm, with manufacturing facilities are in Lindas. Flygt has subsidiaries in 16 countries and 3,400 employees of which 1,500 are in Sweden.

**GANZ-MAVAG LOCOMOTIVE & RAILWAY CARRIAGE MANUFACTURERS, MECHANICAL ENGINEERS** P O Box 136, Budapest VIII, Konyves Kalman krt 76, Budapest, H-1967, Hungary, Tel: +36-137-020, 335-950, Telex: 22-5575, 22-5576. Water turbines (Francis, Kaplan and Pelton types), water turbine stations, pumps and pumping stations.

**INTERSIGMA EXPORT AND IMPORT CORPORATION OF SIGMA CONCERN** P O Box 111, Praha 1, Vaclavske nam 60, 111 87, Czechoslovakia. Exports: pumps, pumping equipment, irrigation equipment, industrial valves, complete water management plants, pumping stations, sewage water purifying plants, water treatment plants and industrial pipings.

**KSB INTERNATIONAL S A** PO Box 225, Frankenthal (pfalz), D-7610, West Germany, Tel: +49-6233-863159, Telex: 465211, Fax: +49-6233-862577, Contact: Mr Gerlach. Builders of pumps, pump stations and water supply systems for supplying drinking and raw water to homes, farms and industry. Also systems for the conveyance and removal of water.

**MACHINEFABRIEK LANDUSTRIE BV** P O Box 199, AD Sneek, NL-8600, The Netherlands, Tel: +31-5150-11411, Telex: 46145, Fax: +31-5150-12398, Contact: Mr Bosner. Manufacturer and supplier of pumping stations for drainage, irrigation and sewage and sewage treatment stations.

**MASCHINENFABRIK ANDRITZ AG** POB 24, Statteggerstrasse 18, Graz-Andritz, A-8045, Austria, Tel: +43-316-602-0, Telex: +03-1313. Pumps and complete pumping stations for irrigation and drainage, industrial water supply plants, cooling water pumps for thermal power stations, sewage pumps and process pumps. All the pumps designs have been based on models subjected to detailed scrutiny of characteristics, efficiency and cavitation.

**METALNA Machine Builders, Steel Fabricators and Erectors** Zagrobska 20, G2001 Maribor, Yugoslavia, P O B 200 Tel: +3862412511/411272,413272, Telex: +33115 Yu motmb, Fax: +412030.

**NUOVO PIGNONE** Via Tiburtinakm 12.7 00131 Rome Italy is one of the leading designs and manufactures of machinery and equipment for gas, water, petroleum and petrochemical industries. Nuovo Pignone's main products are: Reciprocating and centrifugal compres-



**Vacuum Pumps, Compressors**  
and packaged systems for handling dry and saturated gases.

**Heat exchangers**  
computer-optimized design for cooling or heating of process liquids and gases.

**Centrifugal pumps**  
standard suction and selfpriming. In all types, sizes and materials for the widest range of applications.

**Systems Engineering**  
Engineered systems for power generation, chemical, municipal and other major industry sectors, incorporating SIHI, Halberg and Berkefeld Filter products.

# SIHI - Expertise and products second to none.

A SIHI policy of continuous research and development, coupled with rigorous quality control and precision manufacturing techniques has established a standard of excellence that is recognized as world class.

The worldwide network of SIHI representatives and manufacturing plants ensure that customers get the maximum benefit from our state-of-the-art technology.

**Liquid Pumping, Gas Handling, Heat Transfer, Systems Engineering**

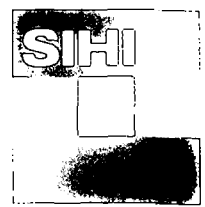

**Germany**  
SIHI GmbH & Co KG, Itzehoe  
**ALBERG**  
Maschinenbau GmbH  
Ludwigshafen  
**SIHI-HALBERG**  
Antriebsges mbH, Itzehoe

**Berkefeld Filter**  
Anlagenbau GmbH, Celle  
**France**  
S A des Pompes SIHI, Trappes  
**Netherlands**  
SIHI-MATERS B V, Beverwijk  
**Belgium/Luxembourg**  
S A Pompes SIHI  
Grool-Bijgaarden  
(Brussel)

**Great Britain**  
SIHI-Ryaland Pumps Ltd  
Altrincham  
**Austria**  
SIHI-HALBERG  
Pumpen-Vertriebsgesell-  
schaft mbH, Wien  
**Switzerland**  
Puripenbau  
Schaffhausen AG, Schaffhausen

**Italy**  
SIHI-IDROMECCANICA S.p.A.  
Cologno Monzese (Milano)  
**Spain**  
M I B S A  
Pozuelo de Aarcon (Madrid)  
**Canada**  
SIHI Pumps Ltd, Guelph/Ontario  
**U.S.A.**  
SIHI Pumps Inc., Grand Island/N.Y.

**Australia**  
SIHI AUSTRALIA Pty Ltd  
Ringwood, Victoria  
  
Representatives  
all over the world  
  
For further information  
SIHI HALBERG - Abt VMP  
Postfach 2106 25  
D-6700 Ludwigshafen

## PUMPING STATIONS

sors, Gas and steam turbines Centrifugal pumps, Ball valves and valve actuators, Fabricated equipment, Control and safety valves, Process computers, Automation and remote control system. Please contact for further details.

**SIGMA CONCERN** Vaclavske Nam 60, 111 87 Praha 1, Czechoslovakia. Manufacture the SPS range of mobile seasonal pumping stations for delivering water to spray irrigation systems. Output ranges from 70 litres to 100 litres per second at a delivery head of 60 to 100 metres.

**SIHI - HALBERG** Halbergstr 1, Ludwigshafen/Rh 1, 6700, West Germany, Tel: +49-621-56120, Telex: 4-64-833 halu d, Fax: +49-621-5612209. Pumping stations, pumps irrigation, water supply pumps and water work pumps.

**SPP GROUP LTD** Thield Cross, Reading, Berks, RG3 7SP, UK, Tel: +44-734-323123, Telex: 848189, Fax: +44-734-323302, Contact: Mr Saddler. SPP Projects works with consultants, contractors and water authorities on the design, manufacture and implementation of large turnkey pumping installations in the environmental sector. SPP Projects are able to undertake all types of complete pumping stations for water supply, sewage and drainage schemes.

**STUBENRUSS IRRIGATION SAS** V Castellano 4, Bressanone, BZ, I-39042, Italy, Tel: +39-472-35775, Telex: 400477, Fax: +39-472-34355. 6

**WORTHINGTON PUMPING SYSTEMS DIV OF DRESSER (UK) LTD** Canterbury House, Sydenham Rd, Croydon, Surrey, CR9 3JK, UK, Tel: +44-1-688-7733, Telex: 24657, Fax: +44-1-680-1807, Contact: John Green. Undertake turnkey mechanical and electrical projects. Also package pumping plant, manufacturing in 20 centres worldwide. Full erection, commissioning, maintenance and staff training.

### Renovation, Lining and Replacement of Pipes

**BORDEN (UK) LTD** North Baddesley, Southampton, SO52 97B, UK, Tel: +44-703-732131, Telex: 47212, Fax: +44-703-738656, Contact: Mr Isaacson. Suppliers of resin grouts for soil consolidation and ground water control, also epoxide resin systems for coatings, linings, concrete repair and adhesive applications.

**BTR SILVERTOWN LTD** Horninglow Rd, Burton-on-Trent, Staffordshire, DE13 0SN, UK, Tel: +44-283-510510, Telex: 34419, Fax: +44-283-510052, Contact: Mr Watson. Manufacturers of lined pipes, pumps, purpose mouldings and pipe repair kits. The company has water board approval for pipe seals.

**CSR HUMES PTY LTD** PO Box 31, World Trade Centre, Melbourne, Victoria. 3005, Australia Tel: +61-3-611-3311, Telex: +38015, Fax: +61-3-614-6347. Humespipe Systems, precast structural concrete products, protective linings, soil stabilisation products: Humes Con-

crete is Australia's leading producer of concrete pipe and precast concrete products and, as such, is a significant contributor to the construction of the nation's irrigation, sewerage and drainage reticulation systems. As well, Humes Concrete products are utilised in major transport infrastructure works, rural and domestic applications. The Advance Australia Award winning Eurocycle, a compact domestic wastewater treatment plant, an inexpensive alternative to sewerage, septic tank and pump-out systems.

**THEFFORD METER BOX COMPANY INC** Wabash, Indiana, 46992-0443, USA, +1-219-563-3171/219-563-8441, Tel: +1-219-563-0167, Fax: 023-2654 FORD WASH. The Ford Meter Box Company Inc manufactures the industry's most complete line of water works brass valves and fittings, meter setting and testing equipment and main line pipe repair products.

**FOSROC LTD** Stafford Park 4, Telford, Shropshire, UK, Tel: +44-952-290221, Fax: +44-952-290031, Contact: Mr Smith. Manufacturers of a range of epoxy resin coatings for potable water and sewage.

**GALLIFORD PIPELINE SERVICES LTD** PO Box 33, Milton Malsor, Northampton, Northants, NN7 3AD, UK, Tel: +44-604-858031, Fax: +44-604-858561, Contact: John Husbands. Galliford Pipeline Services undertake water main rehabilitation i. e. scraping existing mains and relining with cement mortar or epoxy resin. Also general mainlaying including pipe bursting, size for size and sliplining.

**HEITKAMP INC** PO Box 730, 99 Callender Rd, Watertown, CN, 06795, USA, Tel: +1-203-274-5468, Fax: +1-203-274-5619, Contact: Mr Benedict Ebner. Specialists in cleaning and cement mortar lining of pipelines - rehabilitation and new installations.

**INSITUFORM GROUP LIMITED** 15 Commercial Arcade, St Peter Port, Guernsey, CI, UK, Tel: +44-481-710971, Telex: 4191431 INSITU G, Fax: +44-481-710626. Insituform is a patented, cost effective, structurally sound process providing an innovative solution to pipeline reconstruction. The unique system strengthens and can increase flow in the original pipe. It is chemically and corrosion resistant and will considerably extend pipe life without costly excavation and down time, environmentally acceptable, world wide success.

**INTERNATIONAL PIPING SERVICES COMPANY** 2900 s 21st Avenue, Broadview, Illinois, 60153, USA, Tel: +1-312-343-1333, Telex: 240054 xpor ur, Fax: +1-312-343-1435, Contact: Mr Pierce. Products, services and equipment for the alteration and repair of pipeline systems without interruption of service. Please contact direct for further information.

**JOHNSTON ARMALINE** Johnston House, Hatchlands Rd, Redhill, Surrey, RH1 1BC, UK, Tel: +44-737-242466, Fax: +44-737-249730, Contact: Mrs Joyce Read. Provide specialist staff and equipment to contractors for pipejacking. Also have considerable expertise in a variety of sewer lining techniques, including installation of small diameter pipes and connections by remote control. Please contact direct for further information.





## It's now possible to repair the pipes without even waking the baby

No-one takes kindly to having their roads dug up. But when it's discovered that the disruption may have been unnecessary, letters of complaint can start arriving.

Now Insituform offers a solution that eliminates environmental hazards - the dirt, dust and noise as well as the need for excavation.

The Insituform Process is simplicity itself. A flexible, soft tube, tailored to the shape of the damaged pipe, is impregnated with a suitable resin. It is then everted under water pressure through the existing pipe, and the resin cured to form a hard 'pipe within a pipe'.

At once the structural strength of the original pipe is greatly increased. The gaps in the broken sections are successfully bridged.

And the flow capacity enhanced.

Small wonder then that clients in 46 countries have selected the Insituform Process to reconstruct over 3,000 kilometres of pipeline since 1971.

V  
I  
D  
E  
O

For a video cassette or further information, please write to the Marketing Department, Insituform Group Ltd., Commercial Arcade, St. Peter Port, Guernsey, Channel Islands. Telephone: 0481 710971. Telecopier: 0481 713931.

**INSITUFORM®**

PIPELINES RECONSTRUCTED WITHOUT DIGGING

# Perfect Pipe Reconstruction ...worldwide, reliable, fast

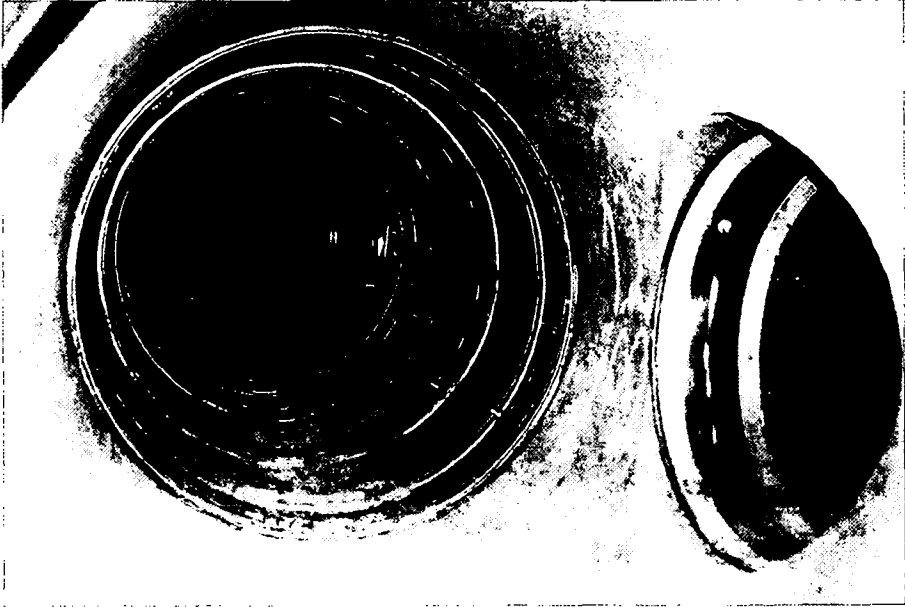

with **AMEX® -10-Reconstruction and Sealing System** for accessible  
**Water- and Gas Pipelines**  
and **AMEX® 32-400**  
**Foilrelining for all diameters**

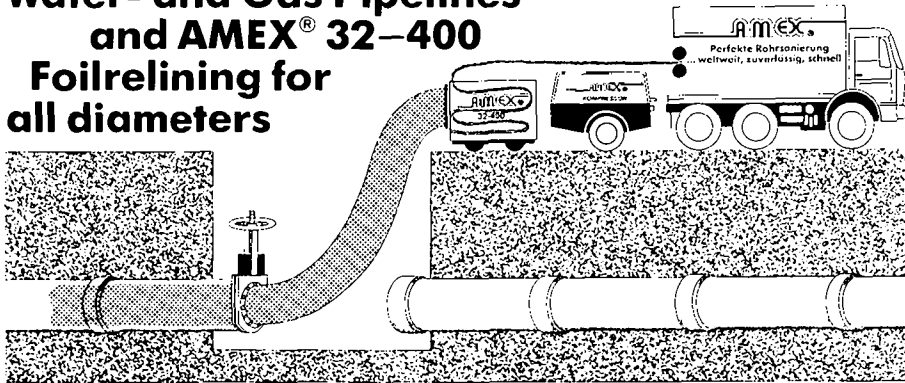

## AMEX®

AMEX Gesellschaft für  
Rohrleitungsbauteile und  
Anlagentechnik mbH

Administration:  
Taubertstraße 6-8  
1000 Berlin 33  
Telephone: 030/8259087/88  
Telex: 184154 amex d  
Telefax: 030/8259089

Manufacturing Plant:  
Reichenberger Straße 144  
1000 Berlin 36  
Telephone: 030/6127081

## RENOVATION, LINING AND REPLACEMENT OF PIPES

**KEY AND KRAMER** Adriaan Van Heelsraat 19, Maassbuis, CA, 3143, The Netherlands, Tel: +31-1899-15411, Telex: 22603, Fax: +31-1899-15002, Contact: Beitsma. Established in the Netherlands for more than 50 years, have become one of the largest pipe coating contractors in the world. During this time the company has built a solid reputation. Able to supply in accordance to the international Standards, every coating suitable to all applications of the water industry from potable water to sewage.

**LONG PRODUCTS LTD** Harbour Rd, Rye, East Sussex, TN31 7TE, UK, Tel: +44-797-223561, Telex: 95497, Fax: +44-797-224530, Contact: Mr Bunch. Specialises in the manufacture and supply of cold-applied liquid coatings, pipe wrapping tapes and self-adhesive waterproof membranes for the protection of steel and concrete structures. All are manufactured to international specifications and we have worldwide representation.

**MAINLINING SERVICE INC** P O Box 96 555 Pound Road, Elma, New York, 14059, USA, Tel: +1-716-652-3700, Fax: +1-716-652-9234, Contact: A G Perkins. Water main cleaning and/or cement lining of water mains in place by the originators of the centrifugal (Perkins) pipe lining process. Range of capability from 4" to over 12 feet diameter - over 40 years experience in equipment design, manufacture and field use.

**MARGLASS LTD**, Sherborne, Dorset, DT9 3RB, UK, Tel: +44-935-813722, Telex: 46233, Fax: +44-935-816284, Contact: Mr Johnson. Manufacturers of high strength woven glass fibre fabrics and sarims for the reinforcement of anti-corrosion coating systems for pipes, ductings and water resistant membranes. Supplied wide width or slit and suitably primed with coal tar, bitumen or polymer as required.

**MERCOL DESCALING CO LTD** Carr Vale, Bolsover, Chesterfield, S44 6JD, UK, Tel: +44-246-822521, Contact: Mr Miller. Insitu scraping and relining with epoxy resin of cast iron water mains.

**METRIX ENGINEERING** Blagdon St, Sheffield, S2 5QS, UK, Tel: +44-742-767921, Telex: 547621, Contact: R Smith. Metrix produce pressure grouting equipment for the installation and repair of sewage systems.

**MORE FLOW SERVICES EUROPE BV** PO Box 4, Voorburg, AA-2270, The Netherlands, Tel: +31-70-694171, Telex: 32457, Fax: +31-70-872013, Contact: Mrs Mirjam Leijdekkers. More Flow Services is a pipeline cleaning company with international experience in cleaning water, oil, gas, industrial, and sewage pipelines on long distances without any interruption. Reducing till 25%, T-sections and 90 degrees-bends give no problems.

**NUTEK** PO Box 1 Route 85, Amston, CT, 06231, USA, Tel: +1-203-537-2387, Telex: 710-420-0430, Contact: Mr Demoholla. Produce chemicals for scale and corrosion inhibition and removal. Able to remove calcium sulphate, barium sulphate, iron oxides and most difficult scales.

**PEART** Onward Works, Manchester Rd, Hyde, Chesh-

ire, SK14 1BB, UK, Tel: +44-61-368-3545, Telex: 666801, Fax: +44-61-367-8218, Contact: Mr Roy Richardson. Specialists in under-pressure drilling to enable branch connections and additional service lines to water pipelines. Leak repair clamps, pipe cutting machines, boring machines and equipment for welding plastic pipes.

**PLENTY LTD** Ham Bridge Rd, Newbury, Berkshire, RG14 5TR, UK, Tel: +44-635-42363, Telex: 848023, Fax: +44-635-49758, Contact: Andy Colquhoun. Manufacture and design of filters, mixers, pumps, pipe cleaning equipment and electro chlorinators. Representation worldwide.

**PLUM CREEK MFG** PO Box 2, Ainsworth, NB, 69210, USA, Tel: +1-402-387-0347, Fax: +1-402-387-0431, Contact: Russ Barry. Manufacture a self-cleaning intake screen for pumps and pumping bay inlets.

**PRESS CONSTRUCTION LTD** PO Box 35, Swindon, Wilts, SN1 3AU, UK, Tel: +44-793-28221, Telex: 444419, Fax: +44-793-614929, Contact: Mr Burnett. Civil engineering contractors with total capability to manage and operate systems from water supply through to sewage treatment. Also specialists in distribution works, pipeline cleaning services and pipe replacement systems.

**SERVICISED LTD** Ajax Avenue, Slough, Berks, SL1 4BH, UK, Tel: +44-753-33771, Telex: 846966, Fax: +44-753-691623, Contact: Chris Von Paffel. Expansion jointing and structural waterproofing. Pipeline protection systems.

**SLD PRESSURE JETTING LTD** Unit 15, First Avenue, Drum Industrial Estate, Chester-Le-Street, County Durham, DH2 1AF, UK, Tel: +44-91-4106111, Telex: 373266, Fax: +44-91-4107000, Contact: M J Donaldson. Contracting, hire and sales of high pressure water jetting. Extensive experience in removal of pipeline lining materials and cleaning of pipework drains, sewers and water treatment work.

**SPINIELLO CONSTRUCTION COMPANY** 2414 F, 223rd St, Long Beach, CA, 90810, USA, Tel: +1-213-835-2111, Contact: Wayne Hardwell. Undertake pipeline reconditioning, clean pipelines and cement mortarline to pipe.

**SRECO** 3217 Carter Avenue, Marina Del Rey, CA, 90292, USA, Tel: +1-213-301-9009, Fax: +1-213-301-6232, Contact: Patrick Crane. Sewer cleaning equipment - mechanical sewer rodding machines for removal of roots, grease and other obstructions from sewer pipes, bucket machines for removal of debris, water jet sewer machines, hand operated sewer cleaning equipment, all types of tools.

**TATE PIPELINING PROCESSES** Oldham St, Denton, Manchester, M34 2SR, UK, Tel: +44-61-320-6197, Telex: 669328, Fax: +44-61-320-6825, Contact: Mr Rendall. Privately owned civil engineering company, founded in 1934 specialising in the inner cement mortar lining of pipelines covering a diameter range of 75mm to 3000mm.

**WAILES DOVE BITUMASTIC PLC** Wedgeley Rd,



**ANALYSIS - DESIGN - MANUFACTURE  
CONTROL SYSTEMS AND PANELS**

**PUMP FAILURE Can Cause Excessive Transient Pressures  
USE SURGE SUPPRESSION  
SERVICES AND EQUIPMENT**

by  
**QUIETFLO  
ENGINEERING  
LIMITED**

---

***Specialists in  
Surge Suppression for  
Water Pumping  
and Sewerage  
Installations.***

---

***In extensive use in many  
parts of the World.***

---

**Send for Technical Literature to:-**

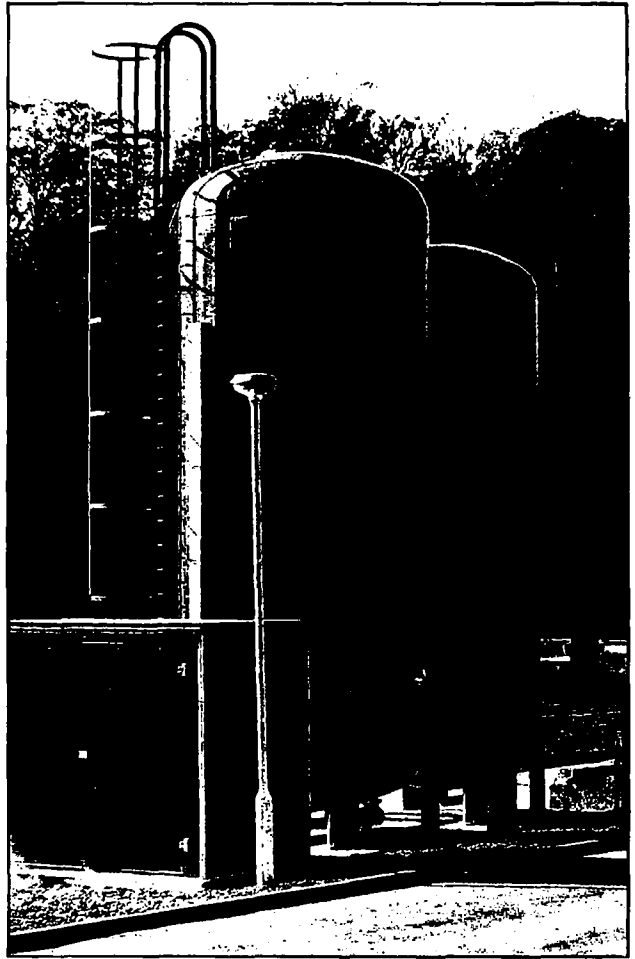

**QUIETFLO  
ENGINEERING  
LIMITED**

**TROUT ROAD, WEST DRAYTON, MIDDLESEX, UB7 7TP,  
ENGLAND. Tel: West Drayton 443341 Telex 935730**

**BOMBAY NEW YORK MILAN DUBLIN FREDERIKSBERG (D. K.) AGENTS WORLDWIDE  
Also: NOISE CONTROL - SEPARATORS - STEAM DRUMS AND CONSULTANCY SERVICE**

# RENOVATION, LINING AND REPLACEMENT OF PIPES

Hebburn, Tyne And Wear, UK, Tel: +44-91-483-2321, Telex: 53545, Fax: +44-91-483-6124, Contact: Neil Ormond. Members of the BTP Group. Suppliers of protective coatings for use in the water and allied industries, including a specialist coating which does not support legionella.

**WARDS FLEXIBLE ROD CO LTD** Finchley Avenue, Mildenhall, Bury St Edmunds, Suffolk, IP28 7BQ, UK, Tel: +44-638-713800, Telex: 81389, Fax: +44-638-716863, Contact: Mr E J Baxter. Manufacturers of drain and sewer maintenance and cleaning equipment, including rod rotating and jetting machines, pipe tracers, winches and ancillary equipment. Markets in UK and in 67 countries worldwide.

## Surge Protection

**BAILEY DIVISION OF CMB IND** P O Box 8070, Fresno, CA, 93747, USA, Tel: +1-209-252-0791, Telex: 33-7616 CMB FSO, Fax: +1-209-453-9030. Bailey, a division of CMB Industries has more than 60 years of control valve manufacturing experience. Bailey's Model 415 Surge Anticipator Valve with power failure feature (2" - 16") is designed to eliminate surge damage. When a power failure occurs, the valve opens at a pre-determined rate and closes slowly after the initial shock waves have been eliminated. The Bailey Model 416 Surge Anticipator Valve with power failure and high pressure relief features (2" - 16") opens rapidly in the event of a high pressure condition and closes slowly upon restoration of normal pressure conditions.

**COOKSON & ZINN LTD** Station Rd Works, Hadleigh, Suffolk, IP7 5PN, UK, Tel: +44-473-823061, Telex: 98613, Fax: +44-473-824164, Contact: Mr Bodri. Manufacturers of storage tanks, process, pressure and surge vessels and associated pipework, all in carbon or stainless steel to BS 799, 2594, 2654, 5500 and API 620, API 650, designed and fabricated within the parameters of BS 5750.

**FLUID KINETICS LTD** PO Box 119, Amersham, Bucks, HP6 6DD, UK, Tel: +44-494-433737, Fax: +44-494-433817, Contact: Peter Goss. Specialists in surge analysis and control for water and sewage pumping schemes. Designers and manufacturers of silencers for blowers and compressors.

**NORTHERN RUBBER CO LTD** Victoria Works, Retford, Nottinghamshire, DN22 6HH, UK, Tel: +44-777-706731, Telex: 56417, Fax: +44-777-709739, Contact: D G Boyall. Specialist fabricators of surge arrestor bags - hand built and inflated to control surges in water pressure. Also diaphragms, seals, washers and other precision mouldings.

**OCV CONTROL VALVES** 7400 East 42 Place, Tulsa, Oklahoma, 74145, USA, Tel: +1-918-627-1942, Telex: 910-845-2227, Fax: +1-918-622-8916. OCV manufactures and internationally markets a complete line of automatic, hydraulically operated, diaphragm actuated, pilot controlled valves. The series 118 surge anticipation valve acts to correct a common problem in pipeline systems by anticipating high pressure waves and relieving

pressure within the system before such waves can form.

**QUIETFLO ENGINEERING LIMITED** Trout Rd, West Drayton, Middlesex, UB7 7TP, UK, Tel: +44-895-443341, Telex: 935730, Fax: +44-895-422230. Design and supply of surge control equipment and services for the alleviation of pressure transients in potable or sewage rising mains. Surge analysis, specification, design and supply are available as a self contained package complete with control panel and compressors, skid mounted and export packed if required. Surge control equipment can also be produced to the design of independent consultants.

**RICHARD GROSVENOR & CO LTD** 21 Woodthorpe Rd, Ashford, Middx, TW15 2RP, UK, Tel: +44-7842-41021, Fax: 892322, Contact: Mr J T Lyddon. Manufacturer of industrial and marine electrically driven reciprocating pumps in a range of materials to suit many liquids. Packaged pump and tank sets also made with a range of accessories. All pumps available with variable output.

**TELEMATIC SYSTEMS LTD** Alban Park, St Albans, AL4 0XY, UK, Tel: +44-727-33147, Telex: 261083, Fax: +44-727-50687, Contact: Mr Clarke. Telematic was formed five years ago to design and manufacture surge protection equipment. The range of equipment will protect electronic equipment, including telemetry from the effects of noise, lightning and NEMP.

**VERNON MORRIS & CO LTD** Chester Rd, Bretton, Chester, CH4 0DH, UK, Tel: +44-244-660794, Telex: 01556CARIBAGI, Fax: +44-244-314635, Contact: Mr Stockton. Manufacturers and distributors of mechanical and electronic flow gauges, pressure recorders, flow and pressure test kits, back flow prevention devices, sand pipes, valve keys, and waterwork fittings etc.

## Tanks (including Pressure Vessels) and Water Towers

**AC PLASTIC INDUSTRIES LTD** Prospect Works, 216 Sydenham Rd, Croydon, CR0 2EB, UK, Tel: +44-1-689-1555, Telex: 296747 ACPLIG, Fax: +44-1-689-1561, Contact: Mr D Hudec. A C Plastic Industries Ltd manufacture Aquastow Hot Press Moulded GRP sectional cold water storage tanks for installations inside and outside worldwide. Approvals include Singapore Institute of Standards and Industrial Research, Water Research Centre and Loss Prevention Council.

**ACTION MFG & SUPPLY CO** 1226 S E 9th Terrace, Cape Coral, FL, 33904, USA. Manufacture aerators and water conditioning equipment and all types of filters. Distributor of pumps and pressure tanks.

**ALAMO WATER REFINERS INC** 1415 Jerry St, San Antonio, TX, 78201, USA, Tel: +1-512-734-7771. Manufactures and wholesales water softeners, iron removal filters, aerators/degasifiers, sediment filters, taste and odor filters, chlorinators, iodine feed systems, pH neutralizing systems, etc. (WT)

# HOW AMTROL KEEPS THE WATER FLOWING

Ground water sources account for 98 per cent of the world's potable supply. Which is precisely the reason Amtrol's line of water resource equipment plays such an important role, for agricultural, drinking water, and other urgent third world needs.

Our wide range of well system products, for instance, can help guarantee uninterrupted water delivery far longer than with conventional equipment.

## **Abundant water service**

Examples: Amtrol's broad offering of diaphragm-type well-pressure tanks, pump and well components and accessories enables the professional to provide abundant water service through extended operating life. Essential in remote areas where repair and service facilities are often lacking.

It's hardly a surprise that Amtrol should lead the way in helping to insure continuous supplies of potable water. After all, Amtrol introduced the world's first pre-pressurized diaphragm expansion tank nearly half a century ago. It's a concept that's revolutionized water delivery systems everywhere.

## **No more old-fashioned tanks**

Today, our Well-X-Trol<sup>®</sup> diaphragm-type tank is a perfect illustration. It replaces the old-fashioned water tank and provides more economical, longer-lasting service. Indeed, Well-X-Trol is easily the most popular, best known name in water system control (see opposite page).

## **Contamination-free**

But Amtrol doesn't stop with helping to get water out of the ground. We also make equipment to insure the quality of water, regardless of source. Filtration systems by Amtrol, for instance, are being used to provide contamination-free water for drinking, bathing, and commercial uses, in both "point-of-use" and "point-of-entry" applications.

And as new contaminants are identified Amtrol's researchers will keep pace designing proper treatment products and applications to keep water free of pestilence and disease.

Amtrol is also in the forefront of some other

water-related technologies. We're the leading supplier of engineered storage systems that store treated water and deliver it under pressure at the tap.

Indeed, Amtrol's Reverse Osmosis storage vessels can be found in most of the under-the-counter RO point-of-use drinking water systems in the United States and in a growing number of other countries.

## **Low cost hot water**

To provide low cost supplies of hot water, Amtrol pioneered the first "heat pipe" combustion system ever used in direct-fired water heaters. All made possible through Amtrol's use of space-age technology and an innovative use of new materials.

Called the Super Hot Water Maker, this advanced system provides abundant hot water at low fuel consumption.

To bring advanced technologies to water system professionals worldwide, Amtrol has introduced some bold new steps in technical education. Our Center for Education and Technical Development, housed in its own newly constructed facility at Amtrol's corporate headquarters, utilizes the latest audio visual teaching programs and professional technical educators to foster a better understanding of our products and their wide range of applications.

## **Upgrading skills**

In the field, Amtrol's educational staff works closely with industry associations. Here, Amtrol helps to upgrade the technical skills of engineers and contractors in the design and operation of life-support heating, plumbing, water treatment, and water supply systems. A critical requirement in the success of water system programs for emerging nations.

## **Amtrol fact file:**

International headquarters are based in Warwick, Rhode Island. Sales currently exceed \$150,000,000, with employment in excess of 1000. The company maintains licensing agreements in Malaysia, Japan, Europe and the United Kingdom, and works with export/import firms throughout the world.



## After you've discovered water who's going to keep it flowing?

Amtrol can help.

Our Well-X-Trol® pre-pressurized diaphragm expansion tank does what no other tank can do. Keep pump starts to a minimum. So your well water project keeps on working long after you've headed back home.

For information, contact Amtrol, International Headquarters,  
1400 Division Road, West  
Warwick, Rhode Island, U.S.A.  
02893. Tel: (401) 884-6300  
TLX: 92-7716 AMTROL WRWK



**AMTROL** INC.  
WEST WARWICK, R.I. 02893



## TANKS (INCLUDING PRESSURE VESSELS) AND WATER TOWERS

**ALBION CONCRETE PRODUCTS** Sales Office, Llan-gadog, Dyfed, SA19 9LT, UK, Tel: +44-550-777327, Fax: +44-550-777328, Contact: Ian Reese. Albion Concrete modular kits to provide wells, catchpits, storage tanks, water troughs, cesspits, septic tanks, full sewage treatment plants, all complete with sewage pumps, high pressure water pumps electrical systems etc, also concrete pipes, box culverts and bridges.

**AMERICAN GRANBY INC** 1111 Vine St, Liverpool, New York, 13088, USA, Tel: +1-315-451-1100, Telex: 646222, Fax: +1-315-451-6928, Contact: Ms Arelli Schermerhorn. Manufacturers of a range of over 60,000 products for the water industry worldwide including tanks, fittings, valves and accessories.

**AMTROL INC** 1400 Division Rd, West Warwick, RI, 02893, USA. Amtrol Inc manufactures and distributes a complete line of diaphragm pre-pressurized well storage tanks under the Well-X-Trol label. As originators of the first diaphragm well tank, Amtrol is the world's largest producer of pre-pressurized storage vessels for use in private residential, commercial, institutional and community ground water well systems. It also leads the field in application technology providing full service to those involved in design and installation of water systems.

**ATLANTIC SCREEN INC** 118 Broadkill Rd, Milton, Delaware, 19968, USA, Tel: +1-302-684-3197, Fax: +1-302-684-0643, Contact: Mr Lawson. Atlantic Screen handles and manufactures a complete line for monitoring well installations, and have created a screen suitable for underground storage tanks called the Tank Inspector. It comes in lengths and sizes according to tank diameters. Other accessories are available to accommodate the Tank Inspector, such as filter wrap, man-hole covers, locking caps, centralizers, silica sand and bentonite etc. Bailers made of Teflon, PVC, stainless steel and acrylic with stainless steel wire covered Teflon or poly cord round out our line.

**BERGSOE ANTI CORROSION (BAC) AB** Box 214, Landskrona, S-261 23, Sweden, Tel: +46-418-161-65, Fax: +46-418-27722, Contact: Jan Persson. B A C supply and install pipelines and storage tanks - structures in soil and water, also cables, piles and sheet pilings, as well as water towers and water treatment plants.

**BOATMAN PLASTICS LTD** Great Hales St, Market Drayton, Shropshire, TF9 2AA, UK, Tel: +44-630-57286, Telex: 35484, Fax: +44-630-5545, Contact: Mrs Edwards. Manufacturers of cold water tanks, chemical tanks, sectional and semi-sectional tanks, and 1 piece tanks etc. Special sizes made to customers requirements.

**BOYTHORPE LTD** Weaverthorpe, Malton, N Yorks, YO17 8EZ, UK, Tel: +44-9443-331, Telex: 57773, Fax: +44-9443-441, Contact: Mr Marsh. Manufacture and install circular vitreous enamel tanks and associated equipment, used for many processes in the water industry, including aeration, settlement, digestion, thickening, chemical contact or just storage.

**BRAITHWAITE ENGINEERS LTD** Neptune Works, Newport, Gwent, NP9 2UY, UK, Tel: +44-633-62141,

Telex: 498237, Fax: +44-633-50631, Contact: Mr Leslie Morgan. Suppliers of the famous Braithwaite press steel tank plus a wide range of other types of liquid storage tanks including welded, butyl-lined, glass-lined and grp tanks.

**BTR PERMALI RP LTD** Bristol Rd, Gloucester, GL1 5TT, UK, Tel: +44-452-28671, Telex: 43683, Fax: +44-452-507409, Contact: Mr Hawkins. The hydroglas modular water storage system consists of strong, lightweight frp panels with external "corsetry" where required. FRP does not corrode, needs no painting and once installed, requires virtually no maintenance.

**BURNHAM PLASTIC PRODUCTS** Unit A, Mildmay Industrial Estate, Foundry Lane, Burnham-on-Crouch, Essex, CM0 8SH, UK, Tel: +44-621-782911, Contact: John Beard. Manufacturers and suppliers of GRP products including access covers in 22 sizes, scumboards, weir plates, storage tanks and tank covers, diffusion drums and cabinets and kiosks for instrument housing.

**BUTEK LTD** 11 Radford Crescent, Billericay, Essex, CM12 0DW, UK, Tel: +44-277-653281, Telex: 99270, Fax: +44-277-657921, Contact: John Coulson. Fabrication and installation of synthetic rubber and plastic membranes for water storage, oil pollution, effluent, lagoons, reservoir roofs and other specialised applications. Also manufacture water tanks.

**CAMBRIAN-PLASTICS LTD** Litchard Industrial Estate, Bridgend, Mid Glamorgan, UK, Tel: +44-656-57482, Fax: +44-656-767127, Contact: Mrs Hek. Tanks, pipes and cylindrical products.

**CANBAR INC** P O Box 280 1 Canbar St, Waterloo, Ontario, N2J 4A7, Canada, Tel: +1-519-886-2880, Telex: 069-55255, Fax: +1-519-886-5546, Contact: Mr James Smith. Manufacturers of tanks and pipelines from wood, fibreglass and moulded polyethylene, of wood stave penstocks and pipelines for irrigation supply and hydro-power installations and chemical storage tanks for the water treatment industry.

**CHEM-TAINER INDUSTRIES** 361 Neptune Avenue, N Babylon, NY, 11704, USA, Tel: +1-516-661-8300, Fax: +1-516-661-8209, Contact: Tony Lamb. Manufacturer of one-piece moulded polyethylene tanks. Capacity 2 gallons to 9,000 gallons. All materials food grade.

**CONCEPTS IN FIBREGLASS** 6207 S McIntosh Rd, Sarasota, FL, 33583, USA, Tel: +1-813-924-9846, Fax: +1-813-378-4518, Contact: Bill Kazey. Custom fibreglass fabricator and manufacturer of indoor and outdoor aerators, commercial brine tanks, reverse osmosis storage tanks for the water treatment industry.

**COOKSON & ZINN LTD** Station Rd Works, Hadleigh, Suffolk, IP7 5PN, UK, Tel: +44-473-823061, Telex: 98613, Fax: +44-473-824164, Contact: Mr Bodri. Manufacturers of storage tanks, process, pressure and surge vessels and associated pipework, all in carbon or stainless steel to BS 799, 2594, 2654, 5500 and API 620, API 650, designed and fabricated within the parameters of BS 5750.

**DAVEY PRODUCTS PTY LTD** 118 Atkinson St,



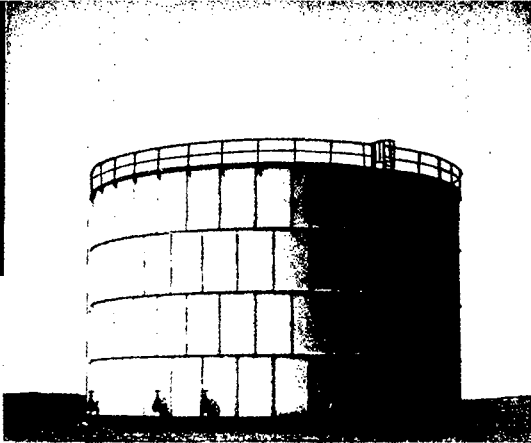

## Whatever Your Water or Wastewater Storage Needs.

### GROUND WATER STORAGE

- 2,150 cubic meters water storage United Arab Emirates
- Ground water tank capacities up to 7,900 cubic meters
- Synthetic gaskets on all TecTank tanks do not deteriorate, ensuring a tight seal

### TANK ON STRUCTURES

- 380 cubic meters potable water storage on 15 meter structure - Liberia
- TecTank's engineers design tanks and structures for appropriate seismic and wind conditions
- Superior API 12B joint design gives all tanks a dependable seal

### WATER STANDPIPE

- 27 meters high, 460 cubic meters capacity - Canada
- Standpipe designs up to 36 meters high
- Integral coated steel bottom reduces foundation costs

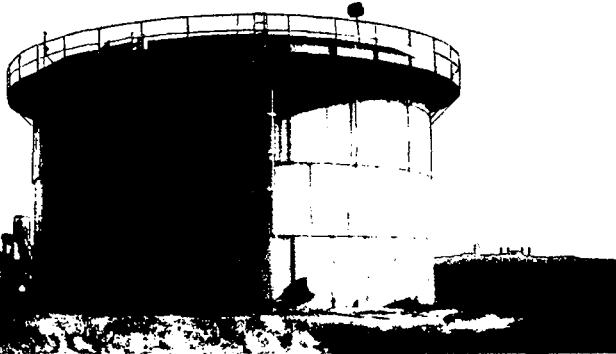
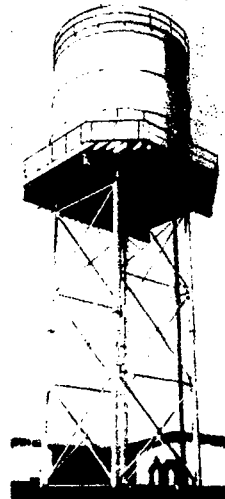

### WASTE TREATMENT TANK

- 1,240 capacity cubic meters - United States
- Low maintenance, factory coatings provide ultimate protection
- Easy bolt together assembly using local crews



Peabody TecTank's bolted steel tanks are the long-lasting, economical approach to water storage. Our international network of agents provides specification and pricing assistance for your projects.

In-house engineers design your water storage and waste treatment tanks to API, AWWA and other standards. Each of your tanks is custom-manufactured for its specific application.

Our baked on coatings give the highest protection in a system that can be easily maintained in the field.

With tanks in over 60 countries, Peabody TecTank offers prompt service on the selection, purchase and erection of water storage tanks worldwide. For more information, send for our free brochure.



**Putting More Into Storage**

## The International Experts Are at Peabody TecTank.

P.O. Box 996  
Parsons, Kansas 67357 USA  
Phone 316-421-0200  
FAX 316-421-9122

Peabody TecTank

## TANKS (INCLUDING PRESSURE VESSELS) AND WATER TOWERS

Oakleigh, Victoria, 3166, Australia, Tel: +61-3-568-1655, Telex: AA139654, Fax: +61-3-568-4551. Manufacturers and marketers of pressure systems, end suction pumps - domestic, commercial and farm, swimming pool filters and pumps, spa bath pumps, engine driven pumps and pressure tanks.

**DE JONG GORREDIJK B V** P O Box 15, Gorredijk, AA, 8400, The Netherlands, Tel: +31-5133-1541, Fax: +31-5133-1555. De Jong Gorredijk B V manufacture stainless steel products, such as hotwater storage tanks, filtertanks, pressure-vessels and transport containers, with a capacity of 1 - 1000 litres (wall-thickness up to 3 mm). Manufacture serial-wise and completely according to customers wishes.

**EMCO ENGINEERING INC** 25 North St, Canton, MA, 02021, USA, Tel: +1-617-828-7340, Telex: 924326, Fax: +1-617-828-1714, Contact: Charvel Bechir. The Emco group of companies is an international organization incorporated in the state of Massachusetts, in 1974, specializing in the manufacture of water and waste treatment equipment, including: reverse osmosis, brackish and sea-water desalting plants, ultrafiltration systems, sewage treatment systems, water softeners, reclamation systems, deionization lime treatment, swimming pool equipment and water storage tanks.

**ERMCO INC** 1570 Fairview Avenue, St Louis, MO, 63132, USA, Tel: +1-314-423-7711, Fax: +1-314-421-5904, Contact: John Kisling. Manufacturers of commercial, industrial water conditioning equipment. Industrial water softeners, pressure filter, dealtalizers and special tanks.

**FIBAFLO REINFORCED PLASTICS LTD** Holton Heath Industrial Estate, Holton Heath, Poole, Dorset, UK, Tel: +44-202-624141, Telex: 41175, Contact: Martin Ashby. Produce pipes, tubes and vessels in filament wound grp for the water, oil and chemical industry. Sizes from 25mm to 2. 5m diameter.

**FLEXCON INDUSTRIES** 300 Pond St, Randolph, MA, 02368, USA, Tel: +1-617-986-2424. Manufacturer of deep drawn steel and stainless steel diaphragm tanks for reverse osmosis systems, water wells and hydronic heating systems.

**FRANKLIN HODGE INDUSTRIES LTD** Ramsden Rd Rotherwas, Industrial Estate, Hereford, HR2 6LR, UK, Tel: +44-432-269605, Telex: 35593, Fax: +44-432-277454, Contact: Tina Prosser. Franklin Hodge Industries Ltd is one of the worlds leading companies in the manufacture and installation of storage tanks for water and other liquids.

**GALLIFORD SPECIALIST SERVICES LTD** P O Box 33, Milton Malsor, Northampton, NN7 3AD, UK, Tel: +44-604-858031, Fax: +44-604-858561, Contact: John Husbards. Undertake specialist repairs to water towers, underground reservoirs and general water retaining structures, ie concrete repairs, crack sealing, internal lining & external waterproofing, joint renewal and epoxy paint applications.

**GOODWIN TANKS LTD** Pontefract St, Ascot Drive

Industrial Estate, Derby, DE2 8JD, UK, Tel: +44-332-363112, Fax: +44-332-290-397, Contact: Mr Peter Goodwin. Suppliers of glass coated (vitreous enamelled) sectional steel cylindrical storage tanks for the containment of potable water and sewage processing.

**H & H PRECISION PRODUCTS THERM-O-DISC INC** 1320 S Main St, Mansfield, OH, 44907, USA, Tel: +1-419-756-2131. Manufacturer of bubblers, carafe filters, water valves, flow controls, tank assemblies and custom OEM products.

**HARRINGTON INDUSTRIAL PLASTICS** 14480 Yorba, Chino, CA, 91710, USA, Tel: +1-714-597-8641. Specializes in ultrapure and corrosion resistant plastic liquid handling. Pipe fittings, valves, pumps, tanks, filters and instrumentation.

**HENDERSON BARWICK INC** 150 California Avenue, Brockville Ontario K6V 5W1 Canada Tel: +1-613-342-8471, Telex: +066-36539, Fax: +1-613-342-4432. Custom-made tanks, tubing, ducts, special cabinets, mixers, conveyors and pressure vessels of all kinds. Chiefly in stainless steel, aluminium, copper and many special alloys including titanium, hastelloy and all nickel alloys.

**JACK F HOLT & ASSOCIATES** Odessa, TX, 79762, USA, +1-915-366-5295. Specialize in the BYOB drinking water connection, design RO systems (from 200-10,000 gpd) pre-treatment, storage tanks, delivery and post-treatment equipment. Complete water store, the design, construction and marketing services.

**K AND M PLASTICS INC** Elk Grove Village, Illinois, 60007, USA, Tel: +1-312-439-3311, Contact: Brenda Williams. We are a manufacturer of brine tanks and brine cabinets. We are also a distributor for the park international mineral tanks.

**KVK A-8551** Wies, Austria, Tel: +43-3465/25-13, Telex: 034342. The firm KVK has been engaged for years in the production of large capacity tanks for acids, lyes and waste water. In line with pollution control requirements it has developed a compact neutralisation plant for the treatment of used waters and acids.

**MATT-SON INC** 28 W 005 Industrial Avenue, Barrington, IL, 60010, USA, Tel: +1-312-628-8766. Supplier, manufacturer and distributor of plastic components. Fiberglass tanks, resins and filtration media, brine tanks and accessories, cartridges and filter housings, pipe and pipe fittings and a wide variety of third faucet components including UV equipment. (WT)

**MID AMERICA WATER TREATMENT INC INT'L** 2045 Lake St, Hanover Park, IL, 60103, USA, Tel: +1-312-289-6400. Manufacturer of a complete line of residential and commercial water conditioning equipment including softeners, filters, chemicals, chemical feed pumps, RO systems and a complete line of component parts, pressure vessels, resin, valves, brine tanks, feeder tanks, filter housings, cartridges and carbon. (WT)

**MONARCH WATER SYSTEMS** 245 N Valley Rd, Xenia, OH, 45385, USA, Tel: +1-513-426-7000. Manufac-

# Franklin Hodge

**SPECIALISTS IN LIQUID STORAGE THROUGHOUT THE WORLD**



445,500-litre aluminium Liquitainer for a fire protection system.



726,000 litre capacity tank storing process water for a power station. The shell is marine alloy of aluminium.



Drinking water storage for ships' bunkering in the Far East. Total capacity 726,000 litres.

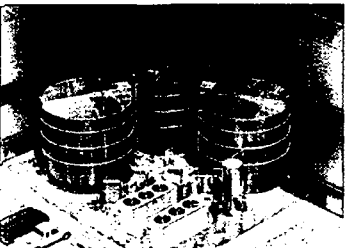

Liquichill thermally-insulated tanks storing water for an air conditioning system. Total capacity 840,000 litres.

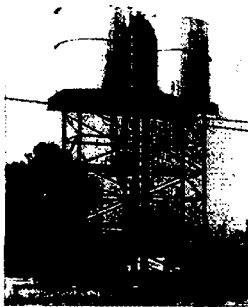

Elevated tanks for storing drinking water. Each tank capacity 130,000 litres.

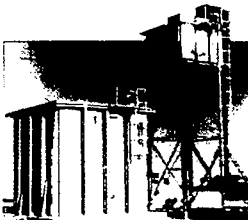

Drinking water storage on a remote construction site, one tank elevated, the other at ground level.



Butyl lining being installed in a Liquidrum tank.



Temporary fire water storage.

Franklin Hodge are acknowledged world experts in producing and supplying tanks and reservoirs for storing water on both external and internal sites principally for drinking, fire protection, and industrial processes.

They are simple to transport and construct, are very flexible in design, require minimal long-term maintenance, and because of their inherent reliability are especially suitable for remote regions.

We have perfected a butyl rubber lining system which is extremely tough and offers three major benefits. Firstly the risk of leakages is virtually eliminated, secondly there is no need to seal tank shells, and lastly it reduces water contamination and conforms to worldwide regulations for drinking water storage. Used in the majority of installations, the lining is particularly easy to handle on site. It can also be supplied separately for use in existing tanks and reservoirs.

Where there is a need to keep liquids either cool in hot weather or avoid freezing in cold conditions, tanks with built-in thermal insulation can be supplied. The inner surface is coated with high density polyurethane which is then covered by a butyl lining.

Aluminium is recommended for the majority of tank shells with other materials available depending on requirements, and as there are only a few limitations on configuration, it is possible to design and install where access is difficult or restricted.

We can also supply covers, towers, ladders, pipework etc. and maintain a comprehensive and very experienced design and technical service, able to advise on whatever the problems.

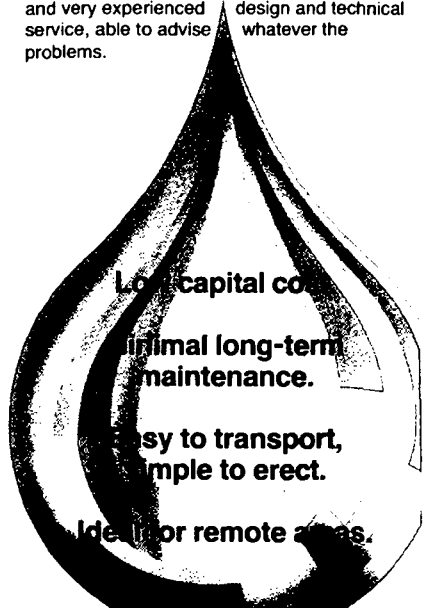

**Low capital cost**

**Minimal long-term maintenance.**

**Easy to transport, simple to erect.**

**Ideal for remote areas.**

**FRANKLIN HODGE INDUSTRIES LIMITED,  
RAMSDEN ROAD,  
ROTHERWAS INDUSTRIAL ESTATE,  
HEREFORD HR2 6LR, ENGLAND.  
TELEPHONE: (0432) 269605 TELEX: 35593  
FAX: (0432) 277454**

## TANKS (INCLUDING PRESSURE VESSELS) AND WATER TOWERS

tures pressure vessel equipment including filters with many media from different applications, ion exchange softeners, dealkalizers and demineralizers. Uses standard parts which can be obtained and serviced locally. (WT)

**MONARFLEX LTD** Lyon Way, St Albans, Hertfordshire, AL4 0LQ, UK, Tel: +44-727-30116, Telex: 826542, Contact: Mr D A Bignell. Low-density (reinforced) polyethylene membrane manufacturers and installers for liquid containment, i. e. pollution control, within applications such as reservoirs, slurry lagoons, river diversions, ponds etc.

**MORGAN MARINE LTD**, Llandybie, Dyfed, SA18 3JA, UK, Tel: +44-269-850437, Telex: 48300, Fax: +44-269-850-656, Contact: Mike Cousins. GRP buildings, switchgear and sub-station building, pumping stations, treatment buildings, kiosks, cabinets, sound proof buildings and enclosures, tanks, structural and cladding panels, large span circular and rectangular covers and reservoir access covers.

**MOTHERWELL NAYLER PETROSEALS** 149 Glasgow Rd, Wishaw, ML2 7QQ, UK, Tel: +44-698-355711, Fax: +44-698-69774. Tank covering is neatly achieved by the Coveral Dome. Using geodesic design principles the dome can contain odours, exclude light, protect from weather etc, while presenting a pleasing visual aspect.

**NALGE COMPANY** P O Box 20365, Rochester, NY, 14602-0365, USA, Tel: +1-716-585-8800. Manufacture chemically and corrosion resistant plastic tanks, 2 gal to 22,000 gal, blowers and tubing. All used in water and waste treatment.

**NEI THOMPSON HORSELEY-BRIDGE** PO Box 5, Tipton, West Midlands, DY4 7LY, UK, Tel: +44-21-557-1104, Telex: 337359, Fax: +44-21-520-7841, Contact: Mr Hayes. NEI Thompson Horseley Bridge supply sectional water storage tanks manufactured in grp and steel together with a range of large capacity ellipsoidal tanks on towers.

**NORTHANTS AFORM LTD** Pound Lane Thatcham, Nr Newbury, Berkshire, RG13 4TQ, UK, Tel: +44-635-63040, Fax: +44-635-71950, Contact: Mr Williams. Manufacturers of glass re-inforced covers for water tanks, and component parts for packaged effluent treatment and anaerobic digester systems.

**PAKO PLASTICS** 5370 W Highway 12, Maple Plain, MN, 55359, USA. Manufacture rotational molded nylon tanks for water conditioning.

**PARK INTERNATIONAL CORP** 1401 Freeman Avenue, Long Beach, CA, 90804, USA, Tel: +1-213-494-7002. Manufactures thermo plastic/fiberglass pressure vessels for water conditioning industry. 49 sizes from. 18 to 37. 6 cu ft, capacity 150 psi operating, NSF/UL approved. Tanks are suitable for all water treatment applications. Accessories include manifolds and distribution systems.

**PEABODY TECTANK INC** P O Box 996, Parsons, K S, 67357, USA, Tel: +1-316-421-0200, Telex: 910-740-1988,

Fax: +1-316-421-9122. Peabody TecTank Inc, manufactures bolted steel tanks for export worldwide. Liquid storage tanks and standpipes for water and wastewater storage are produced with the best interior and exterior coatings in the industry. Technical and budget assistance is available, and tanks are designed to API, AWWA and customer-specified standards. Erection and construction is completed with factory crews or supervision of customer supplied labour.

**PITT DES MOINES INC** 1015 Tuttle St, Des Moines, Iowa, USA, Tel: +1-515-244-6000, Telex: 86-6434, Fax: +1-515-244-2576, Contact: Mr Biber. Manufacturers of elevated and flat-bottomed storage tanks. Please contact direct for further information.

**PRONAL S A** Roubaix, Cedex 1, BP 25-59051, France, Tel: +33-20-24-18-19, Fax: +33-20-27-23-10, Contact: Mr Gerard Naltas. Pronal is a family-owned company specialising in the manufacture of technical inflatable products made of rubber-coated fabric eg flexible tanks for storage and transport of liquids such as water or petroleum products, lifting bag, inflatable stoppers, etc.

**QUICK TANKS INC** 545 N Krueger St, Kendallville, IN, 46755, USA, Tel: +1-219-347-3850. Manufacturer of galvanized and lined non-code steel pressure tanks for water storage and treatment. (WT)

**REVL CORP** P O Box 1357, Loveland, CO, 80539-1357, USA, Tel: +1-303-663-1903. Complete service company which engineers, designs, manufactures and markets pressure vessels for water purification and liquid separation applications. Revul pressure vessels are fully engineered to meet the operation and maintenance needs of the system.

**RUND-STAHL-BAU GESSELLSCHAFT M b H**, Am Brand 8, Bregenz, A-6900, Austria, Tel: +43-5574-25-598, Telex: 57-400. Rund-Stahl-Bau is engaged in the production and sale of special formwork for the construction of cylindrical and funnel-shaped buildings, such as water towers, reservoirs, silos, sewage clarification plants, sludge digestion towers, fermentation gas plants etc. The complete system incorporates working, supporting and safety frames.

**STRUCTURAL FIBERS DIVISION OF ESSEF CORPORATION** Industrial Parkway, Chardon, OH, 44024, USA, Tel: +1-216-286-4116, Telex: 980481, Fax: +1-216-286-6759, Contact: Mr Doug Horner. Manufacturers of fibreglass pressure vessels for water treatment, conditioning and filtration, well system pressure tanks for storage of well water, chemical storage tanks for water treatment industry.

**SUPERIOR WATER SYSTEMS INC** 13529 S Normandie Avenue, Gardena, CA, 90249, USA, Tel: +1-213-770-8920. Manufacturer of water softener and carbon filters, resin, RO units, tanks and valves.

**SWHIFT SYSTEMS INC** 5600 Jacobson Rd, Sandpoint, ID, 83864, USA, Tel: +1-208-265-4250. Manufacture stainless steel tank both pressure and non-pressure, for water purification industry and for hot water storage application.

# TANKS (INCLUDING PRESSURE VESSELS) AND WATER TOWERS

**THE CEMENT GUN GROUP LTD** Restoration House 61-65 Stafford Rd, Wallington, Surrey, SM6 9AP, UK, Tel: +44-1-669-4011, Telex: 946707, Fax: +44-1-669-0208, Contact: Mr Thompson. Sprayed concrete repairs and overall protective and decorative treatments to reinforced concrete structures, including water towers mostly applying proprietary materials.

**VULCAN TANKS LTD** Cotes Park Lane, Cotes Park Industrial Estate, Alfreton, Derbys, UK, Tel: +44-773-835321, Telex: 377311, Fax: +44-773-836578, Contact: Len Robins. Vulcan Tanks Ltd are manufacturers and installers of cylindrical sectional steel tanks for the bulk storage of most liquids including water, trade effluent and sewage. Also manufacture ancillary equipment. Due to the tanks being of sectional construction they are ideal for shipping overseas. Please contact direct for further information.

**WALTHAM CHEMICAL PUMP CORP (WALCHEM)** P O Box 565, 1396 Main St, Waltham, Massachusetts, USA, Tel: +1-617-899-8604, Telex: 923478, Fax: +1-617-647-9507, Contact: Richard Jewett. Manufacturers and suppliers of positive displacement metering pumps, fluid control systems and thermoplastic moulded tanks up to 5000 gallons.

**FRED WATKINS (ENGINEERING) LTD** Sling Engineering Works, Nr Coleford, Glos, GL16 8JD, UK, Tel: +44-594-32271, Telex: 437125, Fax: +44-594-35064, Contact: Mr Roberts. New and unused pipework from half-inch to 40 inches. Storage tanks for all liquids. Also valves and fittings and steam boilers.

**WENDLAND MFG CO** P O Box 808, 601 W 11th, San Angelo, TX, 76902, USA, Tel: +1-615-655-6778, Fax: +1-915-655-0325, Contact: Richard Salmon. Manufacturers and suppliers of overground and underground water storage vessels.

**WESSELS CO** 1625E Euclid Avenue, Detroit, MI, 48211, USA, Tel: +1-313-875-5000, Fax: +1-313-875-5004, Contact: Robert Zimmerman. Manufacturers and distributors of pressure vessels for water filtration, also supply RO storage tanks.

**WHALE TANKERS LTD** Ravenshaw Lane, Solihull, West Midlands, B91 2SU, UK, Tel: +44-21-704-3191, Telex: 336182, Fax: +44-21-705-3053, Contact: Alec Paris. Tankers - gravity or vacuum filled, gully empiers and jetters in capacities up to 5000 gallons for municipal and industrial waste handling and drainage system maintenance.

**XERXES CORP** 1210 N Tustin Avenue, Anaheim, CA, 92807, USA, Tel: +1-714-630-0012. Manufacturer of FRP tanks (above ground and underground), pipe, duct and custom engineered products. Please contact direct for further information.

**ZILMET** Via Del Santo, Limena, Padova, 242-35010, Italy, Tel: +39-49-767617, Telex: 430181, Fax: +39-49767-321, Contact: Valentina. Expansion vessels for heating systems and boilers, stainless steel expansion vessels, interchangeable membrane pressure tanks, plate-dismantle heat exchangers, chaplets for foundry/radiator.

## Drainage

### (Including Drainage of Buildings)

**A/S DE SMITHSKE** Tagholm 1, PO Box 205, DK-9400 Norresundby Denmark Tel: +45-9-8178111, Telex: 69620 desmi dk, Fax: +45-9-8175494. A/S De Smithske is a modern production and sales enterprise with a considerable technical know-how and with modern production and administration facilities. During the past years an intensive product development has resulted in new DESMI products within our entire range of centrifugal pumps and transmissions for the industrial and agricultural sectors.

**ARC PIPES** Mells Rd, Mells, Frome, Somerset, BA11 3PD, UK, Tel: +44-373-812791, Telex: 44393, Fax: +44-373-812442, Contact: Mr Edmondson. Arc Pipes is the largest manufacturer of pre-cast concrete drainage products in the U K. 10 works situated throughout the country linked by the latest computer technology, which provides comprehensive and efficient nation wide service.

**B M FLOW REGULATORS LTD** 4-6 Bridge St, Tadcaster, North Yorkshire, LS24 9AL, UK, Tel: +44-937-832778, Telex: 57697, Fax: +44-937-834413, Contact: Mr Peter Hastewell. Stainless steel flow regulators for flood control. Installed in sewers etc to control the flow. Vortex flow pattern enables large outlet areas to be used thus eliminating the risk of blockages.

**BIG 'O' INCORPORATED** P O Box 970, Exeter, Ontario, N0M 1S0, Canada, Tel: +1-519-235-0870, Telex: 064-5659, Fax: +1-519-235-2144, Contact: Mr R Chanyi.

**CHERNE INDUSTRIES INC** 5701 South County Rd 18, Minneapolis, Minnesota, 55436, USA, Tel: +1-612-933-5501, Fax: +1-612-938-6601. Cherne Industries manufacturers and distributes products for the plugging, testing and repair of plumbing through municipal size pipeline. Specifically the company makes both mechanical and pneumatic pipeline plugs, by-pass plugs, plug accessory items, pipeline air-testing equipment, man-hole vacuum testing equipment, plastic pipe deflection gauges, large diameter joint testing and sealing equipment and portable grouting equipment.

**CSR HUMES PTY LTD** PO Box 31, World Trade Centre, Melbourne, Victoria. 3005, Australia Tel: +61-3-611-3311, Telex: +38015, Fax: +61-3-614-6347. Humespipe Systems, precast structural concrete products, protective linings, soil stabilisation products: Humes Concrete is Australia's leading producer of concrete pipe and precast concrete products and, as such, is a significant contributor to the construction of the nation's irrigation, sewerage and drainage reticulation systems. As well, Humes Concrete products are utilised in major transport infrastructure works, rural and domestic applications. The Advance Australia Award winning Eurocycle, a compact domestic wastewater treatment plant, an inexpensive alternative to sewerage, septic tank and pump-out systems. Please contact direct for further information.

## DRAINAGE (INCLUDING DRAINAGE OF BUILDINGS)

**DOVER ENGINEERING** Bridge St, Dover, Kent, CT16 2LE, UK, Tel: +44-304-203545, Telex: 965171, Fax: +44-304-215001, Contact: Mr Dave Harvey. Dover Engineering works is a world leader in the design, manufacture and distribution of specialized access covers and frames and drainage gratings which have particular application in the water industry.

**EAST JORDAN IRON WORKS INC** P O Box 439, 301 Spring St, East Jordan, Michigan, 49727, USA, Tel: +1-616-536-2261, Fax: +1-616-536-7058, Contact: Thomas M Teske. East Jordan Iron Works Inc, produces quality castings in grey and ductile iron. In the water distribution and sewerage business, East Jordan Iron Works manufactures municipal castings including manhole frames and covers, "Watertite" units, curb (kerb) inlets, inlet gratings, valves and fire hydrants.

**FLYGT AB** Box 1309 S-171 25 SOLNA, Sweden. Tel: +46-8-733 6500, Telex: +43887 flygtab s, Fax: +46-8-295816, Contact: Anderz Öhringe. Flygt is the world's leading manufacturer of submersible heavy-duty pumps for contaminated and abrasive liquids. The annual sales for 1988 was approx SEK 2.3 billion. With over 1,250,000 installations in more than 100 countries throughout the world, Flygt submersible products encompass an awesome range of pumps, mixers and hydro turbine generators for small scale hydro electric power stations. The main office is situated in Solna, just outside Stockholm, with manufacturing facilities are in Lindas. Flygt has subsidiaries in 16 countries and 3,400 employees of which 1,500 are in Sweden. Please contact direct for further information.

**GPK - PRODUCTS INC** PO Box 2872, Fargo, North Dakota, 58108, USA, Tel: +1-701-293-7890, Fax: +1-701-293-6153, Contact: Mr Spencer. Manufacturers of PVC sewer and drainage fittings in both gasket joint and cement joint types.

**GRUNDFOS INTERNATIONAL A/S** P D Jensensvej 7, Bjerringbro, 8850, Denmark, Tel: +45-6-68-14-00, Telex: 60731 gfos dk, Fax: +45-6-68-44-72. Grundfos domestic drainage pumps model KP suitable for clean and slightly dirty water are used for drainage, groundwater lowering, dewatering, emptying pools etc. Capacity: Q: 0 - 20 cbm/h. H: 0 - 8 m.

**HEPWORTH BUILDING PRODUCTS LTD** Hazlehead, Stocksbridge, Sheffield, S30 5HG, United Kingdom, Tel: 44-226-763561, Telex: 54294, Fax: 44-226-764827. Hepworth Building Products Ltd is the UK's leading drainage pipe specialist, offering comprehensive ranges of both vitrified clay and plastics systems from a single source. Clay products include Supersleve and Hepsel as well as the NUVIT range for trenchless applications. The plastics gravity drainage range includes Severdrain and Ultra-Rib. The drainage ranges are complemented by high fracture toughness pvc-u pressure pipe.

**HEPWORTH BUILDING PRODUCTS (INTERNATIONAL)** Pollard Moor Works, Padiham, Burnley, Lancashire, BB12 7JK, UK, Tel: +44-282-72533, Fax: +44-282-74888, Contact: Mr Thompson. Director and General Manager 0709-863551. Manufacturers and suppliers

of water pressure pipe, plastic drainage, plumbing systems and vitrified drainage systems.

**HOMA PUMPENFABRIK GMBH** P O Box 2020, Industriestrasse 1, N-Seelscheid 2, D-5206, West Germany, Tel: +49-22-47/7020, Telex: 889-448. A wide range of small surface water and cellar drainage pumps from 0.2 to 1.1 kW power input, fountain and self-priming garden pumps, bigger surface water and contractors' pumps upto 10kW.

**KSB INTERNATIONAL S A** PO Box 225, Frankenthal (pfalz), D-7610, West Germany, Tel: +49-6233-863159, Telex: 465211, Fax: +49-6233-862577, Contact: Mr Gerlach. Builders of pumps, pump stations and water supply systems for supplying drinking and raw water to homes, farms and industry. Also systems for the conveyance and removal of water.

**MACHINEFABRIEK LANDUSTRIE BV** PO Box 199, A D Sneek, NL-8600, The Netherlands, Tel: +31-5150-11411, Telex: 46145, Fax: +31-5150-12398, Contact: Mr Bosner. Manufacturer and supplier of pumping stations for drainage, irrigation and sewage and sewage treatment stations.

**MARLEY EXTRUSIONS LTD** Dickley Lane, Lenham, Maidstone, Kent, UK, Tel: +44-622-858888, Telex: 965578, Fax: +44-622-858725, Contact: Mike Boakes. Produce a comprehensive range of rainwater systems, soil waste overflow and underground drainage. Product ranges are continually expanded as new products are designed and developed to meet market needs. Marley Extrusions has been assessed by BSI and achieved registration to BS5750 quality systems - an endorsement of their technical expertise and product quality.

**NAYLOR BROS (CLAYWARE) LTD** Clough Green, Cawthorne, Barnsley, S75 4AD, UK, Tel: +44-226-790591, Telex: 547787, Fax: +44-226-790531, Contact: H Rose. Manufacturers of vitrified clay drainage materials.

**POLYPIPE (ULSTER) LTD** Unit 49, Seagoe Industrial Estate, Portadown, N Ireland, Tel: +44-762-338370, Telex: 747951, Fax: +44-762-332800, Contact: Mr Trevor Turnbull. All above and below ground drainage systems.

**SPUN CONCRETE LTD** Lichfield Rd Branston, Nr Burton on Trent, Staffs, DE13 3HF, UK, Tel: +44-283-712666, Telex: 341592, Contact: Mrs Kimberley. Manufacturer of precast concrete products for tunnel linings, sewers, drainage systems etc.

**T SEVERN (FIBREGLASS PRODUCTS) LTD** Woodside Mills, Halifax Rd, Elland, W Yorks, HX5 0SH, UK, Tel: +44-422-777464, Contact: Mr Severn. Manufacture grease interceptors, guttering and water tanks.

**WEDNESBURY TUBE** Oxford St, Bilston, W Midlands, WV14 7DS, UK, Tel: +44-902-41133, Telex: 339046, Fax: +44-902-405838, Contact: Lynn Wills. Wednesbury Copper Tube for water, gas, heating, sanitation and engineering purposes. Manufactured to various international specifications, available in soft, half hard (bendable) and hard tempers, coils and straight lengths.

## Plumbing - Water In Buildings

**B S S** Fleet House, Lee Circle, Leicester, LE1 3QQ, UK, Tel: +44-533-23232, Telex: 342761, Contact: Duncan McKay. A national company supplying pipeline and mechanical services equipment through a network of over thirty depots throughout the U K. Each depot maintains comprehensive stocks to provide a local service for the day-to-day requirements of industries.

**CLEAVER-BROOKS (DIV OF AQUA-CHEM INC)** PO Box 421 Milwaukee Wisconsin 53201 USA Tel: +1-414-962-0100, Telex: +026714, Fax: +1-414-961-2715, Contact: . Manufacture large watertube boilers, fire-tube boilers, smaller commercial boilers and associated boiler room equipment. Also design system applications combining technologies of incineration, waste fuel recovery, heat recovery and energy generation.

**EMMANUEL N. KAZIS SA** PO Box 51066, /GR-145 10 Kifissia, Greece Tel: +30-81-61712/81-61702, Telex: 215870 EMKAGR, Fax: +30-81-61018. Manufacturing "Torrent-Cal" Boilers: For house heating - oil or gas fuel, working with high efficiency and low temperatures. Sections are made of high quality cast-iron.

**ENVIROVAC INC** 1260 Turret Drive, Rockford, IL, 61111, USA, Tel: +1-815-654-8300, Fax: +1-815-654-8306, Contact: Janice Eubank. Evac vacuum toilet systems utilize only 3 pints of water per flush. These systems also feature small diameter piping, upward flush capability and no slope requirement for piping. They are installed in commercial buildings, ships, airplanes, trains, marinas and construction sites etc.

**FEBCO DIVISION OF CMB IND P O** Box 8070, Fresno, CA, 93747, USA, Tel: +209-252-0791, Telex: 33-7616 CMB FSO, Fax: +209-453-9030. Febco, Division of CMB Industries has more than a quarter of a century in backflow prevention valve manufacture offering the widest line of approved backflow preventers in the industry. Superior quality bronze bodies in 3/4" - 2" and ductile iron bodies 2 1/2" - 10", Febco offers design features to reduce maintenance and provide reliable operation. The Model 825Y Reduced Pressure Assembly and Model 805Y Double Check Assembly 3/4" - 2" are easily serviced and provide superior protection in backflow prevention. The 2 1/2" - 10" units include stainless steel check assemblies to reduce corrosion and resulting maintenance costs.

**GOLDAK / UDSEC** 547 West Arden Avenue, Glendale, CA, 91203, USA, Tel: +1-818-240-2666, Fax: +1-818-244-6818, Contact: Mr Mark Mulcahey. Designer, developers, and manufacturers of portable electric detection instruments since 1933. Specialized instruments for the water industry include pipe locators, valve locators, leak detectors and pipe tracers for sewer pipe, both cast iron and non-metallic. Locators also have the capability of locating Septic tanks and tracing telephone and electrical cables.

**HALSEY TAYLOR CO** Rt 75 East Freeport IL 61032 USA Tel: +1-815-235-0066, Fax: , Contact: . Manufac-

turer of "drinking type" water coolers which can be retrofitted with a variety of filtration systems.

**HAUSERS WATER CONDITIONING SERVICES** 309 S Wayne St, Manchester, Iowa, 52057, USA, Tel: +1-319-927-3716. Nationwide distributors of QEST plumbing systems-Ametek filtration products and Epco ultraviolet sterile faucets.

**HEPWORTH BUILDING PRODUCTS LTD** Hazlehead, Stocksbridge, Sheffield, S30 5HG, UK, Tel: +44-226-763561, Telex: 54294, Fax: +44-226-764827. Hepworth Building Products Ltd is the UK's leading drainage pipe specialist, offering comprehensive ranges of both vitrified clay and plastic systems from a single source. Clay products include Supersleve and Hepsal as well as the NUVIT range for trenchless applications. The plastics gravity drainage range includes Sewer-drain and Ultra-Rib. The drainage ranges are complemented by high fracture toughness pvc-u pressure pipes.

**HEPWORTH BUILDING PRODUCTS (INTERNATIONAL)** Pollard Moor Works, Padiham, Burnley, Lancashire, BB12 7JK, UK, Tel: +44-282-72533, Fax: +44-282-74888, Contact: Mr Thompson. Director and General Manager 0709-863351 Manufacturers and suppliers of water pressure pipe, plastic drainage, plumbing systems and vitrified drainage systems.

**IDEAL HORIZONS INC** PO Box 1707, Rutland, Vermont 05701 1707 USA Tel: +1-802-773-4346, Fax: +1-802-773-2538. Ideal Horizons manufacture stainless steel ultra-violet disinfection equipment. Our modular systems allow for versatility over a wide range of applications and flow rates. These systems are engineered for durability and performance.

**IMI YORKSHIRE COPPER TUBE LTD** East Lancashire Rd, Kirby, Liverpool, L33 7TU, UK, Tel: +44-51-546-2700, Telex: 628153, Fax: +44-51-546-5881, Contact: Mrs F Bacon. IMI Yorkshire Copper Tube Limited, a complete range of fully kitemarked copper tube for construction and engineering applications including tables X, Y, Z and pencil-slim minibore, Table W. Also a range of plastic, preinsulated copper tube in all qualities.

**IMI YORKSHIRE FITTINGS LTD** PO Box 166, Leeds, LS1 1RD, UK, Tel: +44-532-701104, Telex: 556699 yorsit, Fax: +44-532-715275, Contact: Mr Holden. Design and manufacture of non-ferrous capillary and compression pipe fittings and central heating components for domestic and industrial use.

**INDUSTRIAL COMBUSTION (DIV OF AQUA-CHEM INC)** 351 21st St Monroe Wisconsin 53566-2798 USA Tel: +1-608-325-3141. Offer the broadest range of forced-draft gas and oil burners, packaged for easy installation. IC burners are meeting steam and hot water generation needs in commercial, industrial and institutional applications throughout the world.

**INTERNATIONAL WATER SYSTEMS** 1069 Evans Avenue, Akron, OH, 44305, USA, Tel: +1-216-633-1114, Contact: Richard Stonebur. Manufacturer of complete line of water treatment equipment. Distribute plumbing and waterwell supplies, extensive application and

## PLUMBING - WATER IN BUILDINGS

design capabilities for domestic, commercial and industrial requirements. One of the largest suppliers to independent water conditioning dealers and assemblers providing full line of products incorporating latest technology.

**MILLER PIPELINE CORPORATION** PO Box 34141, Indianapolis, IN, 46234, USA, Tel: +1-317-293-0278, Fax: +1-317-293-8502, Contact: Henry Tops. Manufacturers of internal pipe seals (the WEKO seal, the AMEX-10 seal) and the 32-400 lining system, for resolving leakage and corrosion and red water problems. Also manufacture vacuum excavating equipment.

**PEGLER INTERNATIONAL** St Catherine's Avenue, Doncaster, South Yorkshire, DN4 8DF, UK, Tel: +44-302-855656, Telex: 547166 BELDON G, Fax: +44-302-367661. Pegler International are one of Europe's largest brassfounders. The 21 acre (8 hectare) factory has been awarded the coveted British Standards Institute BS 5750 quality assured certification. Our extensive range of over 3000 plumbing and related products includes brass and bronze gate, globe and check valves, a comprehensive range of taps and mixers, floatvalves, bibcocks and stopcocks and compression fittings. Our range is manufactured to the relevant British Standard and carries the British Standard kite mark. The products undergo a rigorous quality control procedure throughout every stage of manufacture.

**SAFE-T-SERVE** P O Box 126, 1620 Gramercy Torrance CA USA Tel: +1-213-618-0160. Manufacture Safe-T-Serve drinking water system. Demand initiated RO appliance that rests and cleanses the membrane to extend its life and maintain high efficiency. Complete self-contained system provides easy installation and fits into the most confined area in vertical or horizontal position.

**SERVAPURE CO** 1101 Columbus Avenue, Bay City, MI, 48708, USA, Tel: +1-517-892-7745. Manufacture and sale of water vending machines using DI, RO or both. Manufacture and sale of DI regeneration equipment.

**SOCLA S A FRANCE** 1 Rue Paul Sabatier - BP300, 71107 Chalon s/Saone, Cedex, France, Tel: +33-85-46-30-34, Telex: 800259 SOCLA CHALN, Fax: +3-85-41-49-31. Socla can provide a broad range of check valves in a variety of metal finishes including brass, cast iron and stainless steel, for use in numerous internal plumbing applications.

**STA-RITE INDUSTRIES** 175 Wright St, Delazan, Wisconsin, 53115, USA, Tel: +1-414-728-5551, Telex: 4970245, Fax: +1-414-728-4461, Contact: Mr Bruce Lindhorst. Major suppliers of residential water systems and commercial irrigation type pumps to anywhere in the world. Branches in Australia, Canada, England, Germany and Japan.

**THOMAS DUDLEY** PO Box 28, Birmingham New Rd, Dudley, West Midlands, DY1 4SN, UK, Tel: +44-21-557-5411, Telex: 337357, Fax: +44-21-557-5345, Contact: Mandy Hill. Thomas Dudley Ltd, tronfounders and plastic injection moulders, produce WC cisterns and components, plus a comprehensive range of building and civil engineering castings. Please contact direct for further information.

**TUBEMAKERS PIPE CENTRE** 285 Lavarack Avenue Eagle Farm, Queensland, 4007, Australia, Tel: +61-7-260-1533, Fax: +61-7-260-1498, Contact: Gordon Ferguson. Tubemakers Pipe Centre is part of the merchandising division of Tubemakers of Australia Ltd, the largest pipe manufacturers in Australia. Specialising in the pipe and reticulation market, we currently service the Pacific area.

# SAVE WATER REGULATE FUTURE RESOURCES

Water conservation has never been as important as it is today.

Too much waste - especially in developing countries - can literally mean the difference between life and death.

That's why it is encouraging to know that you can help maximise water conservation and run a highly efficient water distribution system thanks to IMI Bailey Birkett.

Our Class T and Class E pressure regulators have been specifically designed to ensure you get the right pressure at the right place at the right time, every single time. Without fail!

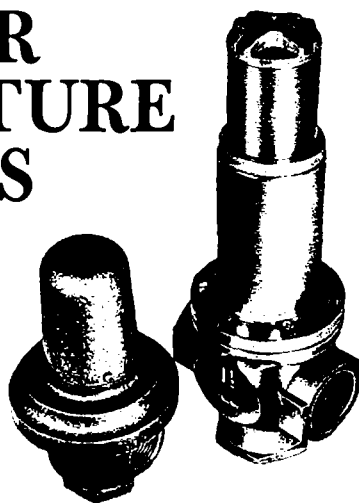

**IMI Bailey  
Birkett Ltd**

AN INVESTMENT IN PEACE OF MIND

**CLASS T AND CLASS E**

Manchester Office: Sharp Street, Worsley,  
Manchester M28 5NA, England.  
Telephone: 061-790 7741  
Fax: 061-799 4335 Telex: 669029.



# ILVA NEW ITALIAN STYLE FOR NEW ITALIAN STEEL



ILVA steel pipes are used in the construction of pipelines, penstocks, water mains; in the oil, petrochemical and structural applications.

The Taranto pipe mills (formerly ITALSIDER) manufacture DSAW pipes in diameters 18" to 56" and spirally welded pipes up to 108" OD. The Dalmine facilities produce seamless and welded pipes in diameters 1/2" to 36".

ILVA steel pipes are manufactured employing the most advanced technologies, thorough inspections and an exclusive quality assurance program.

All over the world, ILVA steel pipes are employed in drilling and transportation of oil, gas and other fluids. ILVA steel pipes, new name, long experience.



4, Via Corsica - 16128 GENOVA - Italy  
P.O. BOX 1727  
Phone (101) 551.81 - telex 270461 Itasid I



**SINCE 1949  
THE STANDARD BY WHICH  
ALL OTHERS ARE JUDGED**

**AQUAFINE<sup>®</sup> Corporation, the World  
Leader in Ultraviolet Disinfection**

*Manufacturer of:*

- Ultraviolet Disinfection Equipment for Water
- Ultraviolet Disinfection Equipment for Liquid Sweeteners
- Ultraviolet Equipment for the Destruction of Ozone
- Ultraviolet Equipment for the Reduction of Total Organic Carbon (T.O.C.)
- SampleTech<sup>™</sup> - Aseptic Liquid Sampling Device



**Aquafine<sup>®</sup> Corporation**

25230 West Ave. Stanford  
Valencia, CA 91355 U.S.A.

805-257-4770 • 800-423-3015 (outside California) • TELEX: 651398 • FAX: 805-257-2489

Available Worldwide - Contact Aquafine for the name of your local Aquafine Branch Office, Original Equipment Manufacturer or Authorized Distributor

***YOUR PARTNER IN SUCCESS***

er Treatment

# KINGDOM OF SAUDI ARABIA

## SALINE WATER

### CONVERSION CORPORATION

SWCC has been entrusted to provide fresh water from desalination of sea water. It started its operation as SWCO (Saline Water Conversion Office) under the Ministry of Agriculture and Water in 1965 with its increasing responsibilities to provide water SWCO was changed to an independent corporation in 1974. Then an elaborate plan was developed to construct the dual purpose plants as well as the single purpose plants on both east and west coast of the Kingdom to meet the water demands of the increasing population, and water short regions.

So far SWCC has constructed 24 plants, 18 in the western region from Haql on the Gulf of Aqaba in the north to the tiny Farasan island in the south, and 6 plants on the east coast from Al-Khafji to Al-Khobar. These plants are producing 547 MGD of water and 4079 MW of power.

There are 3 desalination plants under construction with a total desalinating capacity of 17.7 MGD. By the end of 1989 the total production of water is expected to reach a capacity of 565 MGD and 4079 MW of power.

Almost all of these plants use the Multi-stage Flash Process for desalination, although other processes like Reverse Osmosis and Re-heat are also used. SWCC has under construction the largest sea water desalination facility using the R.O. process with a capacity of 56.800M<sup>3</sup>/day on the west coast at the Jeddah plant site.

In addition to the desalination and power plants SWCC is providing water to inland regions by means of pipelines. One of the major pipeline systems is from Al-Jubail to Riyadh (690m above sea level). It is a dual

pipeline of 60" diameter and a length of 466km and pumping capacity of 830,000m<sup>3</sup>/day. It is one of the biggest high pressure pipeline systems of the world. A third pipeline from Al-Jubail is under construction to provide water to 106 towns and villages. It is a single line of 60" diameter and 384km length from Al-Jubail to Riyadh. From Riyadh it is a dual pipeline of 380km with a capacity of 415,000m<sup>3</sup>/day part of which is 48" diameter in steel and part concrete with 1.6m diameter. A pipe-line from Yanbu plant serves Madinah Munawwara. It is 176km long and 32" diameter steel pipeline passing through the Sarawat mountain range at the height of 864m above sea level. Another pipeline from the same plant serves the city of Yanbu and is 50km long made of asbestos cement. The Shoaiba plant serves Makkah and Taif. It is a dual line of 56" diameter and 96km long up to Makkah and single line of 41km and 42" diameter up to Taif 1745m above sea level made of carbon steel lined with cement. Assir plant serves the areas of Abha 2297m above sea level and Jizan with a 215km long pipeline of 42" diameter. While several other pipelines are under planning to provide water to Hail and Tabuk. This network of pipelines will provide water to these inland regions.

As SWCC is giving great importance to the training of personnel, a Research, Development and Training Center is in operation at the Al-Jubail plant site with a total area of 35,000m<sup>2</sup>. This research and training facility will be able to train 700 personnel per year in different trades used at the desalination and power plants and perform applied research to solve problems at existing desalination plants and develop new processes for desalination.

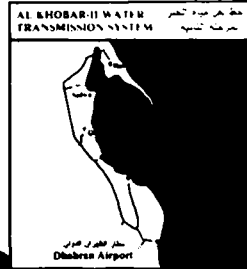
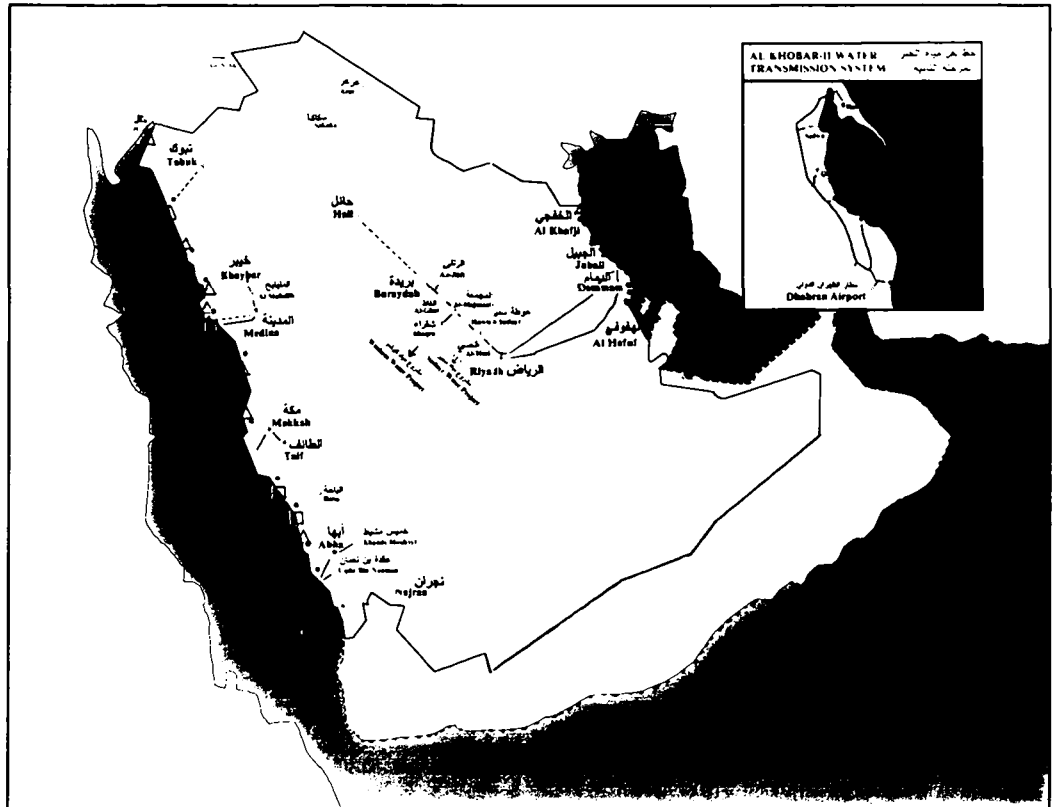

Existing Desal. Plants Along The Red Sea					JEDDAH					Existing Desal. Plants Along The Gulf					
<b>HAQL</b>					Phase I (RO)					<b>AL KHAFJI</b>					
Installed Capacity Cu.M./Day Megawatts					Phase II (MSF)										
Process (No. of Units)					Reverse Osmosis										
Year of Operation					Phase III (MSP)										
Phase I	{MSF}	{1}	882	-	1979	Phase I	{MSF}	{11}	530	-	1972	<b>AL JUBAIL</b>			
Phase II	{R.O.}		6590	-	1988	Phase II	{MSF}	{2}	22727	-	1985				
<b>DUBA</b>					Phase IV (MSF)					Rush units {MSF}					
Phase I	{MSF}	{11}	230	-	1968	<b>TAIF</b>					<b>AL BIRK</b>				
Phase II	{MSF}	{1}	550	-	1978	<b>MAKKAH</b>									
Phase III	{R.O.}		3788	-	1989	Phase I {MSF}					<b>AL KHOBAR</b>				
<b>AL WAJH</b>					Phase I {RO}					Phase I {MSF}					
Phase I	{MSF}	{1}	230	-	1968	<b>ASSIR</b>					Phase I {MSF}				
Phase II	{MSF}	{1}	550	-	1978	Phase I {RO}					Phase II {MSF}				
<b>UMM LAJJ</b>					<b>FARASAN</b>					Phase I {MSF}					
Phase I	{MSF}	{1}	550	-	1974	Phase I {MSF}					Phase II {MSF}				
Phase II	{R.O.}		3788	-	1986	<b>AL-LEETH</b>					Existing Plants <input checked="" type="checkbox"/>				
Two Units (REHEAT)			910	-	1981	Phase I (Planned)					Planned Plants <input type="checkbox"/>				
<b>YANBU</b>					<b>QUNFUDA</b>					Existing Pipelines _____					
<b>MEDINA</b>					Phase I {MSF}					Planned Pipelines -----					
Phase I	{MSF}	{5}	107954	{5}250	1980	Phase I (Planned)					MSF – Multistage Flash				
Phase II (Planned)			90900	105	-	Phase I (Planned)					R.O. – Reverse Osmosis				
<b>RABIGH</b>					Phase I {MSF}										
Phase I	{MSF}	{2}	1288	-	1980										

# SULZER SUPPLIES WORLD'S LARGEST SEWAGE PUMPING STATION

Sulzer (UK) Pumps of Leeds recently completed delivery of eight large capacity pump-sets for the Ameria pumping station in Cairo. These form one part of Stage 1 of the Greater Cairo Wastewater Project.

Cairo is the largest city in Africa and the Middle East. Its population had grown over the last 30 years from 2 million to over 10 million and is forecast to reach 14 million by the end of the century. But unfortunately the city's wastewater facilities had not grown with it. Sewers had become blocked with deposits of sand and silt; existing pumping stations broke down with increasing frequency as the ageing plant became more difficult to maintain. By the 1970's sewage was causing regular problems in Cairo and drastic measures had to be taken.

Therefore in 1977 the Egyptian Government commissioned British consultants to prepare plans which resulted in the Greater Cairo Wastewater Project. This is the largest wastewater project of its kind in the world, costing over £2000 million.

Today rehabilitation of the existing system has been successfully completed and the immediate problems have been largely eliminated. Now the new collection and conveyancing works are underway.

The project is divided into two separate schemes, relating to the east and west banks of the Nile. The east bank works mainly consist of 4 km of culverts and 12 km of tunnels together with the major pumping station at Ameria, 5 miles north west of Cairo, and a treatment plant at Gabal el Asfar.

Sulzer's contract, worth £2.8 million, forms part of the Ameria pumping station. This is believed to be the largest sewage pumping station in the world and has the capacity to handle the total effluent from ten million people. It consists of two pumphouses, one of which contains Sulzer's eight centrifugal pumps with volute casings.

The contract for the pumps was awarded by GEC Electrical Projects of Rugby who are the main contractors for the mechanical and electrical works.

The pumping station is to be built into a circular caisson some 44.5 m in diameter and 32 m deep, plus a 25 m high superstructure building. The Sulzer pumps are located in an annular pump well, eccentrically located in

relation to the caisson, so as to give a tapered sump, itself divided into two compartments. Flow to the station is via a distribution chamber incorporating a blanked off connection to serve a second and similar station in the future.

The pumps will each deliver up to 3600 litres of untreated sewage per second, against a head of 22 metres, requiring an installed electrical capacity of some 8 megawatts. Each pump is fitted with a 21 metre drive shaft as well as drive motors, delivery pipework, electrically operated suction sluice, valves and associated steelwork. In addition Sulzer has provided submersible drainage pumps, ancillaries and spares. Altogether these weigh some 1500 tonnes. The motors are GEC slip ring motors rated at 975 kW at 295 rpm.

The engineering consultants for the project are AMBRIC, which is a joint venture between UK and US consultants. The British consultants are Binnie & Partners (Overseas) and John Taylor and Sons. The American consultants are Camp Dresser & McKee and Black and Veatch International.

So far, all the culverts and tunnels on the east bank scheme have been completed and the caisson for the pumping station at Ameria is now being sunk by the main contractor, Christiani & Nielson.

Ground conditions and the proximity of existing buildings have necessitated the adoption of special construction methods for caisson sinking.

In addition the station will include a collector (screw) pumping station, a standby generator house, electrical substations and switchgear rooms, administration and workshop buildings, equipment for the workshop, service roads and a site conveyancing system comprising chambers, interconnecting channels, culverts and pipework.

Sulzer's ability to supply technically advanced pumps of this size is based upon 125 years of experience and multi-million pounds spent on development. It can supply a wide range of pumps for even the smallest schemes as well as those designed for the largest.

**If you would like to know more then contact Sulzer (UK) Pumps Ltd at Manor Mill Lane, Leeds, LS11 8BR. Tel: 0532 701244.**

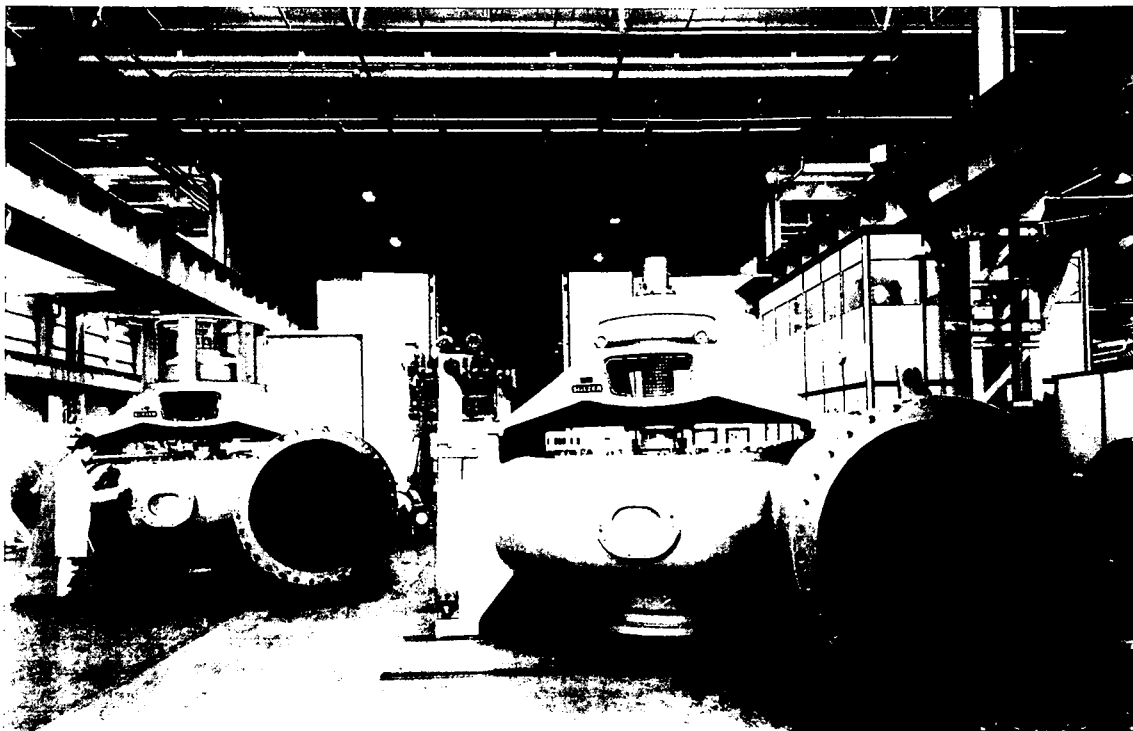

Sulzer pumps for unscreened sewage in the assembly hall of Sulzer (UK) Pumps Ltd at Leeds, Great Britain

# Sulzer Pump Technology for the biggest-ever Sewerage Scheme

Sulzer have supplied 1500 tonnes of pumping plant for the Ameria Pumping Station, heart of the Greater Cairo Wastewater Project. Eight pumps with 8 MW installed power are capable of raising 29 cubic metres of unscreened sewage per second against a head of 22 metres.

Sulzer were chosen for reliability, the hallmark of a world leader, a tradition maintained for over 130 years by a continuous programme of research and development in the engineering and hydraulic disciplines.

So why not ask Sulzer to partner your next project?

## **SULZER®**

Represented in more than 120 countries

---

Sulzer Brothers Limited, Pump Division, CH-8401 Winterthur, Switzerland  
Telephone 052-81 11 22, Telex 896 060 40

PU 38e

# WATER TREATMENT DESIGN FOR RELIABILITY

by

Adrian Coad

What do we want from a water treatment plant? Do we want sophistication and complexity to show to the occasional visitor?

*Most vertical-flow clarifiers cannot cope with river silt. This one had been causing problems and so has been emptied for cleaning.*

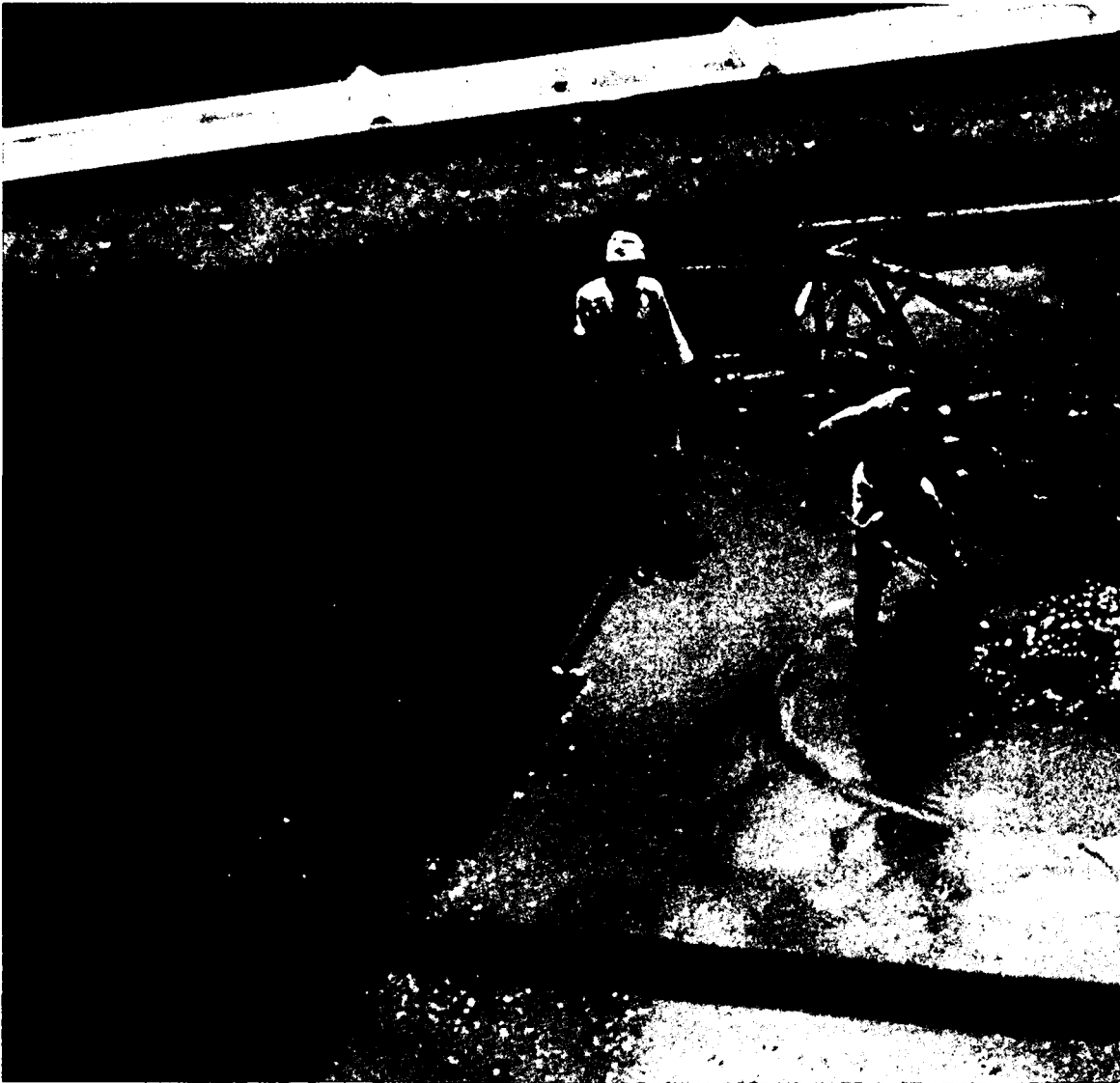



## WATER TREATMENT

Do we want impressive statistics concerning the theoretical capacity of our water industry? Or do we want a continuous supply of safe and acceptable water for all the inhabitants of the town it is built to serve?

By what criteria should we select the processes to be used for treating water? The lowest construction tender? The most convenient financial package? The highest claimed efficiency? The most modern technology? Are there other criteria?

In many parts of the world there are treatment works that are not operating well. Water keeps passing through them, but often at a much lower rate than anticipated, or the quality of the treated water is much worse than had been hoped for. Do we ask ourselves how the plants got into this stage and what could have been done at the design stage to prevent such a deterioration?

Who do we blame when we see a plant in a poor condition? It is easy to blame the operator. (And, if the operator is always blamed there is more chance that he will not report — or will even try to hide — the problems he is facing so that the service to the community suffers.) It may be that the operator has not been given the necessary training and understanding to enable him to manage the plant in a satisfactory way. But often the problems and shortcomings can be traced back to the design stage.

### Criteria for process selection and design

The first selection of criterion that comes to mind is cost — usually construction cost. However, we should also consider the costs of operating and maintaining the plant. Costs should always be split into local currency costs and foreign exchange requirements, especially in countries where large foreign debts are imposing a considerable strain on the national economy.

Some designs may be chosen because they are accompanied by a **convenient financial package**. While this consideration may simplify some short-term issues, relying on this criterion may lead to long-term problems of an economical and technical nature.

Non-technical decision-makers must be educated by engineers to understand the importance of technical considerations, and to understand that systems that are economical in one country may be an extravagance or a failure in another. Often **experience** can be used to show certain types of technology are too expensive or unreliable under local conditions. Records of operating costs, production and quality levels must be used to show the suitability of existing technology in simple terms.

There is no doubt that, in some situations, **prestige** is a factor that affects design choices. Some people seem to think that it is necessary to have the most modern technology for the sake of the honour of the nation. Apparently, decision-makers fail to understand that the honour and well-being of the nation is better served by a water supply undertaking that can provide good quality water **reliably**, than by one that uses the latest high technology but provides an unreliable supply. Tens of thousands will know how reliable a supply is, but only a handful of visitors to the plant will see the sophisticated equipment. Surely it is better to consider the larger number.

Engineers sometimes forget that much of the latest technology in industrialised countries has been developed for the purpose of *minimising the labour force* because of high wage rates. Therefore, this technology is irrelevant where wage rates are low. If modern technology is required, the engineer is advised to look at interesting developments made recently in Brazil and elsewhere in South America, where the emphasis has been on reliability and economy. If visitors and politicians must be impressed, then let them be impressed by the quality of the architecture of the *buildings* on the treatment plant site and let the technology of the actual treatment process be chosen for its reliability.

### All equipment goes wrong sooner or later

Motors burn out, bearings become worn. It is, therefore, advisable to minimise the number of motors in the treat-



## WATER TREATMENT

ment plant by installing hydraulic mixing and flocculation, etc. This is especially important where spare parts take months to come from overseas. Complex flow and pressure measuring equipment needs maintenance; there are often simpler alternatives. In many situations, manual operation of valves is preferable to mechanical actuators.

Plants abstracting from rivers are sure to have problems of deposition of heavy silt, so the design should take this into account. Vertical-flow clarifiers should not be specified unless they are specially adapted to handle such silt or they are preceded by a sedimentation stage. Pressure filters should be avoided wherever possible because the essential inspection of the sand beds in such filters is difficult and often omitted.

There is often a choice between installing more mechanical and electrical equipment or doing more excavation and using more concrete. In the countries where the mechanical equipment is manufactured it is usually reasonable to rely more on this equipment; elsewhere the alternative of more on-site construction should be studied carefully.

### In conclusion

Around the world there are many water treatment plants that have failed in their task of providing safe water 365 days a year. A few of the reasons for such failures have been discussed in this short article. Much more could be written on this subject. The writer would be very interested to receive letters from readers in response to these observations. •



*A properly-designed baffle flocculator of this type can provide a good treatment with little to go wrong.*

*This was once a filter bed of clean sand. Clearly the washing system has not been adequate. Did such things ever happen with the old system of rotating rakes?*

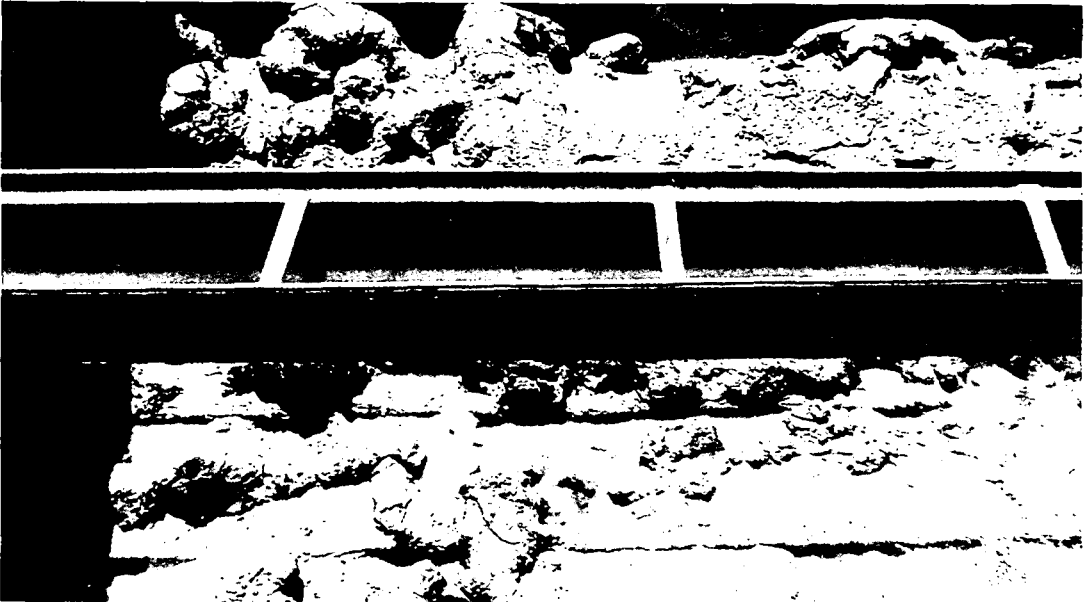

## Chemicals for Water Treatment

**ALDEX CHEMICAL CO LTD** 630 Laurent St Granby Quebec J2G 8V1 Canada Tel: +1-514-372-8844. Manufactures and markets cation exchange resins for water treatment. (WT)

**ALDOUS AND STAMP LTD** 86-90 Avenue Rd Beckenham BR3 4SA UK Tel: +44-1-659-1833/4/5, Telex: 896691, Fax: +44-1-676-9676, Contact: Mr Aldous. Aldous and Stamp are specialist manufacturers and suppliers of chemicals and equipment for the treatment of water used in residential, commercial, industrial and heating/ventilating applications. Services include laboratory analysis, advice on treatment methods, design and supply of plant.

**ALLIED COLLOIDS LTD** P O Box 38, Low Moor Bradford W Yorks BD12 0JZ UK Tel: +44-274-671267, Telex: 51646, Fax: +44-274-606499, Contact: Graham Dawson. Suppliers of high efficiency chemicals specifically designed for solids/liquid separation processes within the potable water, sewage and industrial waste water fields. The unit processes which can benefit both technically and economically from the application of these products include sedimentation, flotation, thickening and dewatering.

**AMERICAN INTERNATIONAL CHEMICAL INC** 27 Strathmore Rd Natick MA 01760 USA Tel: +1-617-655-5805. Suppliers of chemicals for the water and waste water treatment industries: potassium permanganate, sodium fluoride, sodium hexametaphosphate, copper sulfate, sodium chlorite and more. (WT)

**AMERICAN NORIT CO INC** 420 Agmac Avenue Jacksonville FL 32205 USA Tel: +1-904-783-6406. Manufacturer of a wide range of activated carbons designed to deodorize, decolorize, clarify or purify water, waste water or process stream. A wide variety of unique pore size carbons are available to solve tough treatment problems. (WT)

**ANGUS CHEMICAL CO** 2211 Sanders Rd Northbrook IL 60062 USA Tel: +1-312-498-6700. Primary commercial manufacturer and worldwide marketer of nitroparaffins and their derivatives.

**APPLIED BIOCHEMISTS INC** 5300 West County Line Rd Mequon WI 53092 USA Tel: +1-414-242-5870, Telex: 9102763618, Contact: Ruth Gifford. Manufacture water treatment products, primarily algacides for use in surface water, cooling towers and swimming pools. Also other treatment chemicals including clarifiers.

**APPLIED CHEMICALS (S) PTE LTD** 8 Fourth Lokyang Rd Jukong 2262 Singapore Tel: +65-265-2888, Fax: +65-265-6474. World-wide organisation specialising in supply of all types of water treatment chemicals. Experienced and fully qualified representatives available to ensure the correct chemicals are used for every job.

**ATOCHEM GROUPE ELF AQUITAINE** La Defense 5

Paris La Defense La Defense 5, Cedex 24 92091 France Tel: +16-1-334-7000, Telex: ATO 620-953 F. The main chemical subsidiary of the ELF Aquitaine group, Atochem is involved in water treatment and recycling, one of its specializations. Atochem can provide the appropriate chemicals for each stage of the water purification process.

**B K LADENBURG** Dr Albert-Reimann-Strasse 2 Ladenburg D 6802 West Germany Tel: +49-6203-77-4307, Fax: +49-6203-1-2818, Contact: Ferdinand Puhe. The ALBBAPHIOS® products offer a customized solution with full account taken of economical and technical considerations. BK Ladenburg products feature state-of-the-art technology with quality assurance through continuous monitoring using modern analysis systems.

**BARNEBEY-CHENEY CO** P O Box 2526 Columbus OH 43216-2526 USA Tel: +1-614-258-9501. Producer of premium grade coconut and coal-base activated carbons for the water treatment industry. Custom tailored to your requirements including mesh size, surface area, acid washing, special packaging and custom reactivation. (WT)

**BAYROL CHEMISCHE FABRIK** Lochhamer Str 29 Martinsried 8033 West Germany Tel: +49-89-85-7010, Telex: +524695, Fax: +49-89-85-701777, Contact: Mr Utz Heyn. Cleaning and disinfection in the production sectors of the brewing, food and beverage industries, as well as the use of technical enzymes. Special chemicals as starting materials for the processing industry.

**BIO-LAB INC** P O Box 1489 Decatur GA 30031 USA Tel: +1-404-378-1753. Water treatment division specialty chemicals for water treatment, pool and spa and animal health.

**BOLIDEN WATER TREATMENT** P O Box 902 Helsingborg S-25109 Sweden Tel: +46-42-171000, Telex: 72185 BOLIDVS, Contact: Mrs Linkvist. Produce aluminium sulphate for drinking water and AVR for sewage. Also supply equipment for sewage water treatment plants and drinking water.

**THE BOOTS COMPANY PLC** Nottingham NG2 3AA UK Tel: +44-602-592584/592891, Telex: +378431, Fax: +44-602-483889/506111. Boots MicroCheck manufacture and market a range of products for antimicrobial technology for industry. These include environmentally safe award winning biocides, Myacide AS, Myacide SI, dipslides and a rapid detection kit for legionella pneumophila serogroup 1 (Pontiac).

**BRANCHEMCO INC** 8286 Western Way Circle C/2 Jacksonville FL 32256 USA Tel: +1-904-737-0984. Manufacture water treatment chemicals, supplies and equipment.

**BRENCO INTERNATIONAL** 30 Kirkham Industrial Court St Louis Missouri 63119 USA Tel: +314-968-0404, Fax: +314-968-2465, Contact: John S Brennan. Brenco International manufactures, produces and distributes, on a worldwide basis, a complete line of chemicals used in the water treatment industry for the prevention of rust, corrosion and scale.

# CHLORINE DIOXIDE FOR WATER TREATMENT

THE interest in using chlorine dioxide for water treatment has been increasing over the past twenty years.

It is successfully applied around the world for many water treatment problems.

Its fields of application are:

- drinking water;
- waste water;
- industrial water.

As regards drinking water, chlorine dioxide is widely applied for the following uses, where it is more efficient than chlorine:

- organic oxidation;
- disinfection;
- taste and odour control;
- colour removal;
- oxidation of iron and manganese.

In waste water treatment, chlorine dioxide is used for disinfection.

In industrial water treatment, it is a very efficient biocide.

Always used in aqueous solutions, chlorine dioxide is made on site by means of a generator. There are two ways to produce it from sodium chlorite:

1. Aqueous sodium chlorite solution + chlorine (either as a gas or in solution).
2. Aqueous sodium chlorite solution + hydrochloric acid.

The generators available on the market produce chlorine dioxide safely. They are also very flexible and can be monitored to take care of a wide range of treatment requirements.

## DRINKING WATER

### PRE-TREATMENT

Even at high pH, removal of organic pollution and algae is achieved with chlorine dioxide.

But unlike chlorine, it does not form trihalomethane compounds (THMs), believed to be carcinogenic.

The preoxidation of raw water with chlorine dioxide gives a good control of the THMs. In addition, even in combination with free chlorine, THMs are reduced. The prior action of chlorine dioxide removes the THM's precursors (humic substances). So, chlorine applied at the following stage does not form THMs.

Besides, chlorine dioxide does not react with ammonia and its derivatives as chlorine does. It does not form chloramines.

There is no over-consumption of oxidising agents. The use of chlorine dioxide for preoxidation enhances coagulation-flocculation efficiency.

### DISINFECTION

Chlorine dioxide is well known as a very strong bactericide and viricide agent.

As a bactericide it is effective against E.Coli and

B-anthracoïdes within a pH range from 6 to 10 whereas chlorine is inactive in alkaline solutions.

As a viricide, it is more effective than chlorine against enterovirus, adenovirus, reovirus, etc.

The sterilisation with chlorine dioxide gives a longer persistent protection than chlorine.

### ODOUR AND TASTE CONTROL

Chlorine dioxide does not react with phenolic compounds. Chlorine in presence of phenolics gives chlorophenols which are responsible for odours and unpleasant taste.

For control of musty, fishy or earthy taste and odours, chlorine dioxide demonstrates the greatest removal power.

### IRON AND MANGANESE REMOVAL

Oxidation of manganese: chlorine dioxide oxidises soluble manganese to insoluble manganese dioxide. It acts more quickly than chlorine or permanganate.

Oxidation of iron: chlorine dioxide rapidly oxidises iron (II) to iron (III) which precipitates as iron hydroxides.

Besides all the applications described above, chlorine dioxide can solve the problems of coloured water.

### WASTE WATER DISINFECTION

As a bactericide, the contact time for a complete treatment is five times lower with chlorine dioxide than with chlorine.

It is mainly applied in protected areas like lagoons, bays and lakes.

### INDUSTRIAL WATER

For this application, chlorine dioxide is used as a biocide. It has two main advantages:

1. It allows for a very large and non-specific action against micro-organisms. It is non-selective.
2. Its efficiency for remains the same at alkaline pHs.

Its applications for industrial water are:

- in cooling water systems (anti-fouling treatment);
- in the paper industry (anti-slime treatment);
- in oil field water floods (injection water treatment).

Atochem has developed over the years an expertise in water treatment chemicals.

The technicians of our research and application laboratories are at your service to help solve your water treatment problems. For further information please apply to:

**Atochem, La Défense 10 - Cedex 42**

**92091 Paris La Défense (France)**

**Tél: (1) 49 00 80 80. Tx: ATO 611922 F**

□

# WATER TREATMENT.

- WAC® basic aluminum polychloride sulfate.
- Sodium chlorite for chlorine dioxide.
- Hydrogen peroxide.
- Ferric chloride.
- Sodium hydroxide.
- Descaling agents BS.
- LIOZAN® activated hydrazine hydrate for boilers.
- Chlorine
- Sodium Hypochlorite

**ATO**  
groupe elf aquitaine

La Defense 10 - Cedex 42  
92091 Paris - La Defense (France)  
Tel 33 (1) 49 00 80 80 - Telex: ATO 61 1922F  
Fax 33 (1) 49 00 74 47 / 33 (1) 49 00 83 96

## LEGIONELLA - RAPID DETECTION, EFFECTIVE CONTROL

BY BOOTS MICROCHECK

Reported deaths from Legionnaires' disease show that worldwide incidence is on the increase. Why is it on the increase and what is being done to control this problem? These are important questions being asked by governments, health ministries, doctors and the public.

The answer to the first question lies in the increasing number of office complexes and hotels around the world which afford the luxury of air conditioning.

Recirculating water found in cooling towers, air conditioning units and air washers, provides an excellent breeding ground for many types of bacteria. Not only can these bacteria cause havoc with pipework both by corrosion and blockage but they can also be a potential health hazard to workers and the general public.

When air and water are mixed in an untreated air conditioning system, the resulting vapour and water droplets may contain bacterially produced toxins and tiny particles of biomass (biological material). This contamination can cause skin irritation, headaches, bronchial constriction, sore eyes, an increase in body temperature and flu-like symptoms. These are the classical symptoms of "Sick Building Syndrome" — an indoor air pollution related illness. Under conditions where the droplets are infected with the bacterium *Legionella pneumophila*, the well documented Legionnaires' Disease may be contracted.

Our second question was "What is being done to control the outbreaks of Legionnaires' Disease?" Fighting and monitoring the Legionella bacteria has now become a specialised business, employing correspondingly specialised chemicals and monitoring techniques.

Extensive field trial results must be available to back up laboratory claims on the efficacy of any biocide used to prevent the growth of *Legionella pneumophila*. Unfortunately, many of the biocides used in cooling systems do not have detailed field trial data on their use in systems infected with Legionella species. Information relating to their ability to penetrate biofilms is also essential as these biofilms can protect sessile Legionella from non-penetrating biocides. This is especially important since most reinfections by Legionella into recirculating cooling systems originate from slime layers or biofilms within the system. Consequently, a biocide with a proven ability to penetrate and kill biofilms containing Legionella, is vital if the organism is to be effectively controlled.

An independent report (1) recently presented to the Cooling Tower Institute examined in detail the microbiocidal efficiency of BNPD (2-bromo-2-nitropropane-1, 3-diol) against *Legionella pneumophila*. Extensive field work was carried out on the use of BNPD to control *Legionella pneumophila* and Legionella-like organisms in evaporative condensers and air washers in hospitals in southern Ontario. The results showed conclusive evidence that BNPD used at the correct dose rates was capable of not only killing

*Legionella pneumophila* already colonised in these systems, but also protecting the system from reinfection. Further work carried out using a Robbins device showed that BNPD was capable of penetrating biofilms of *Legionella pneumophila* and killing the sessile bacteria. The conclusions in this independent report were as follows:

1. Preliminary field studies reported in this paper supported other laboratory and field data which demonstrate the effectiveness of BNPD in controlling populations of *Legionella pneumophila* in cooling systems.
2. The activity of BNPD is not adversely affected by alkaline pH, high hardness or elevated temperature in cooling water.
3. The ability of BNPD to penetrate and kill heavy biofilms of *Legionella pneumophila* demonstrates its effectiveness as both a biopentrant and a biocide.
4. BNPD applied in the Robbins device eliminated all viable planktonic *Legionella pneumophila* in six hours in simulated cooling water.
5. Conditions present in the Robbins device were designed to simulate those in the field which would account for the good correlation between laboratory and field data.

BNPD (2-bromo-2-nitropropane-1, 3-diol) is supplied to the world water treatment industry by Boots MicroCheck, part of the Boots Company PLC, the U.K. pharmaceutical company, under the trade name Myacide AS. As a further aid in the control of Legionella, a rapid assay system called the Legionella Rapid Assay (LRA) has been developed for the detection of *Legionella pneumophila*. This is also available from Boots MicroCheck.

The LRA enables water samples to be easily analysed for the virulent Pontiac strain (similar to MAb 2.) of *Legionella pneumophila* serogroup 1. This test can be performed well within a working day by a competent technician in a modestly equipped laboratory. In addition to rapid testing, the multi-test manifold allows up to five samples to be tested simultaneously.

Backing the Legionella Rapid Assay (LRA test kit), Boots MicroCheck has a team of technically trained staff. Also the microbiology and chemistry laboratories offer a contract service based on a range of rapid, simple and cheap ways of detecting microbial problems. Boots MicroCheck with their well equipped contract laboratory have years of experience dealing with microbial problems in the water treatment industry. If you would like any advice concerning biocides or detection systems our staff will be more than happy to help you.

(1) Reference - Cooling Tower Institute. 1987 Annual Meeting. Technical Paper No. 87-18. Microbiocidal Efficacy of BNPD against *Legionella pneumophila*.

**Boots Microcheck (Industrial Systems),**  
The Boots Company PLC, Beeston, Nottingham. NG2 3AA  
Tel: 0602 592584 Fax: 0602 483889

# BOOTS MICROCHECK BIOCIDES AND DETECTION SYSTEMS



**SLIME** - Bacterial slime thrives in untreated cooling towers and heat exchangers causing corrosion, blockages, reduced efficiency and a health hazard. Myacide AS can provide a simple, safe and cost effective means of controlling industrial biofouling and reducing potential health hazards.

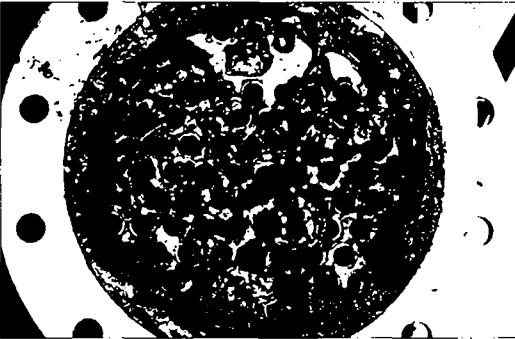

**DETECTION** - Cooling towers must be monitored regularly for microbial growth and potential health hazards. The Legionella Rapid Assay kit gives results for *Legionella pneumophila* SG1 (Pontiac) within a day.

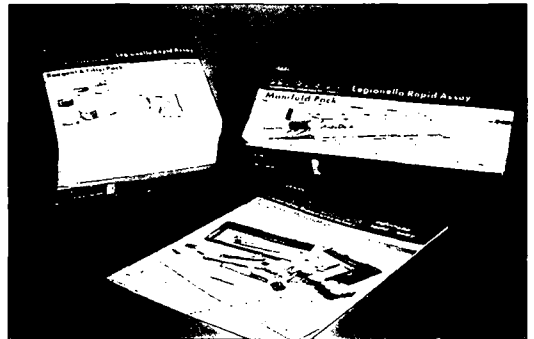

**Myacide AS**

- ★ BROAD SPECTRUM ANTIBACTERIAL ACTIVITY
- ★ COST EFFECTIVE
- ★ SAFE TO USE
- ★ EASY TO FORMULATE
- ★ EXCELLENT COMPATIBILITY
- ★ ENVIRONMENTALLY ACCEPTABLE

**AN ACTIVE INGREDIENT IN BIOCIDAL FORMULATIONS**

**A BIOCIDAL AND PRESERVATIVE FOR INDUSTRIAL FLUIDS**

**CONTROL** - Myacide AS is a safe, effective, broad spectrum water treatment biocide with proven efficacy against *Legionella pneumophila*.

## CHEMICALS FOR WATER TREATMENT

**BURMAH TECHNICAL SERVICES INC** 408 Auburn Avenue Pontiac MI 48058 USA Tel: +1-313-334-4747. Water treatment chemicals-manufacture and direct sales.

**CALABRIAN CHEMICALS CORP** 1445 North Loop, West Suite 800 Houston TX 77008 USA Tel: +1-713-880-9981, Telex: 283909, Fax: +1-713-880-8113, Contact: Mr Mclemore. A diversified corporation with manufacturing facilities located in Texas, a trading organisation in New Jersey and offices and agents worldwide. Provide chemicals for dechlorination, algae control, odour and taste control and corrosion protection.

**CALGON CARBON CORP** PO Box 717 Pittsburgh PA 15230 USA Tel: +1-412-787-6814. One of the world's largest manufacturers of granular activated carbon, specializing in supply to point-of-use water treatment OFMs. Produces a broad range of carbon products based on activity properties and physical characteristics. (WT)

**CARUS CHEMICAL CO** 1500 Eighth St La Salle IL 61301 USA Tel: +1-815-223-1500. Manufacturer of potassium permanganate, chemical for water treatment, air pollution control and wastewater treatment.

**CARMEUSE SA** Rue du Chateau, 13, Seilles, 5210 Belgium Tel: +32-85-825009, Telex: +59608, Fax: +32-85-826302. CARMEUSE is a producer of calcium carbonate, calcium oxide and calcium hydroxide, in Belgium, the Netherlands and France. In the water treatment area, the calcic products are used for: Flocculation of impure water, Remineralisation of drinking water, Softening of industrial and portable waters, PH correction of drinking waters and industrial waters, Residual mud conditioning before dewatering, Disinfection and Pasteurisation of residual muds, Dephosphatation of waters. As some of the lime qualities are very pure, Carmeuse lime is often used in the area of drinking water treatment. Due to its excellent geographical position, close to the harbour of Antwerp and Rotterdam, Carmeuse exports large quantities of lime to all countries of the world, especially to Africa and the Middle East.

**CHEMICAL TESTING CORP** 35 Commerce Rd Stamford CT 06902 USA Tel: +1-203-357-9800. Manufactures water conditioning chemicals and equipment for boilers and cooling systems. (WT)

**CHEMISCHE FABRIK KALK GMBH** Postfach 91 01 57, Kalker Hauptstr 22 Cologne 91 D-5000 W Germany Tel: +49-221-82961, Telex: 8873355, Fax: +49-221-8296-299, Contact: Mrs Keiling. Chemicals for purification.

**CHEMPROHA CHEMICAL DISTRIBUTORS** P O Box 35 Zwijndrecht 3330 AA The Netherlands Tel: +31-1804-23488, Fax: +31-1804-27322, Contact: Mr Van Pveer. As a distributor of chemicals, with locations in the Netherlands, Hong Kong and Puerto Rico, Chemproha buys, transports and sells chemicals around the globe. Within our product range we handle a line of water treatment chemicals for surface and waste waters as well as for swimming pools, such as flocculating agents, pH-control products and water conditioning chemicals.

**CHEMVIRON CARBON** Boulevard de la Woluwe 60 bte 7 Brussels 1200 Belgium Tel: +32-2-773-02-11, Telex: 22481, Fax: +32-2-770-93-94, Contact: Mr R A Davies. Advanced technology based on uses of activated carbon for environmental control, product quality enhancement and improvement of industrial processes is Chemviron Carbon's business. From brewers and food processors to oil refiners and computer manufacturers, Chemviron Carbon people and technology are helping thousands of customers make better products more efficiently, and millions of people are breathing cleaner air and drinking purer water because of Chemviron Carbon products.

**CONTINENTAL PRODUCTS OF TEXAS** Box 3627 Odessa TX 79760 USA Tel: +1-800-592-4684, Fax: +1-915-337-4685, Contact: Joe A Wallin. Speciality chemicals for industrial water, process and pipeline corrosion and fouling problems. Excellent cooling tower, boiler, closed system, amine, glycol and produced water corrosion inhibitors. Biocides for cooling tower and production. Pipeline corrosion inhibitors oil and water soluble, proven and effective.

**DIAMOND CRYSTAL SALT CO** 916 S Riverside Drive St Clair MI 48079 USA Tel: +1-313-329-2211. Produces and markets a full line of salt products for a variety of uses, including water treatment. (WT)

**DIVERSEY FAR EAST PTY LTD** 113 Neythal Rd Jurong 2262 Singapore Tel: +65-265-1988, Fax: +65-264-3450, Contact: J M Arrol. Diversey (FE) Pty Ltd is one of many Diversey companies worldwide. Specialising in water treatment of boilers, chillers and swimming pools. Capabilities of full laboratory service plus in-field day to day back up give us a flexible system of backup to suit all requirements.

**DOW CHEMICAL USA** 2040 Willard H Dow Center Midland MI 48674 USA Tel: +1-517-636-1000. Manufactures a full line of ion exchange resins for water treatment as well as other specialized applications. (WT)

**DR BRUNO LANGE GMBH** Willstaetter 11 Dusseldorf 99 4000 W GERMANY Tel: +49-211-503-061, Telex: 8588757, Fax: +49-211-500-97143, Contact: Mr Waters. Dr Bruno Lange GmbH is one of Europe's leading producers of photometers and reagents for waste water, drinking water and quality control.

**DRACOR WATER SYSTEMS** PO Box 2993, 3643 Hillsborough Rd Durham NC 27705 USA Tel: +1-919-383-9421, Contact: Jim Berry. Filtration, reverse osmosis, ultra filtration, ultra violet purification, deionization and ion exchange resins for laboratories and critical industrial applications.

**E I DU PONT DE NEMOURS & CO INC** Room N-2522-2, 1007 Market St Wilmington DE 19898 USA Tel: +1-302-774-1000, Telex: 835420 AA, Fax: +1-302-774-9560, Contact: Mr D H Andriadias. Permasep permeators for water desalination and chemicals for water treatment.

**EES CORP** 12850 Bournewood Drive Sugar Land Texas 77478 USA Tel: +1-713-240-6770, Telex: 795459, Fax: +1-



## **BK Ladenburg**



Optimization –  
rationalization –  
development  
of products  
and processes

**Product systems  
for water treatment**

## **Water is our element**

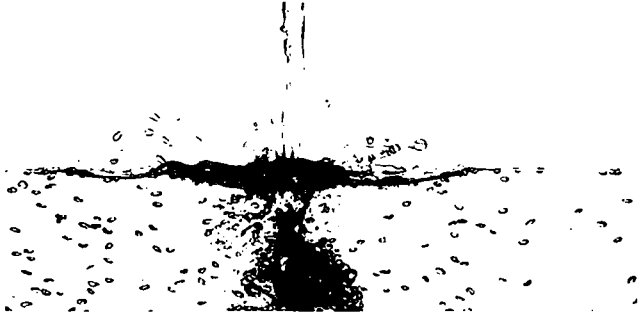
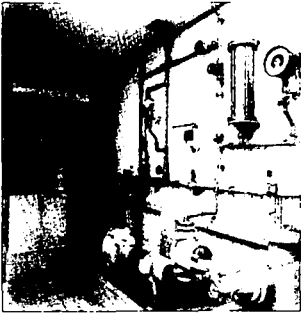

ALBAPHOS® and MIKROPHOS® brands are outstanding for treatment of drinking- and cooling water to prevent deposits and corrosion problems.

ALBAPHOS® – types are also used in seawater desalination plants to protect against membran blocking and scaling.

LABUCID® – biocides counteract the microbiological growth.

LABUFLOC® – flocculants are organic water-soluble polymers in liquid and powder form for waste-water purification.

Benckiser-Knapsack GmbH  
Dr.-Albert-Reimann-Str. 2  
6802 Ladenburg  
West Germany  
Telephone: (062 03) 7 70  
Telex: 463 061 bkla d  
Fax: (062 03) 12818

**Without question, Aqua-Chem is one of the most respected names in seawater desalting. Our task is to use our enormous knowledge and resources in technology, engineering and production to help solve our customers' problems in all the markets we serve.**

Aqua-Chem has supplied over 6,000 distilling systems worldwide. The Water Technologies Division, whose products carry the Aqua-Chem name and logo, traces its history to World War II and the manufacture of transportable battlefield distilling plants for the purification of salt and brackish water.

Since then, Aqua-Chem seawater evaporators and reverse osmosis systems have been serving municipalities, industries, offshore oil rigs, oil refineries, resorts and other commercial establishments. Installations range in size from multi-million gallon a day municipal desalting plants to 3,000 gallon a day units on offshore drilling rigs. In 36 countries, over 10,000 Aqua-Chem desalting plants have been supplied to economically convert seawater into fresh water.

Efficient, economical Aqua-Chem equipment has proven reliable in many installations and applications. We offer a complete range of Multi-Stage Flash, Multiple Effect Spray-Film, Mechanical Vapor Compression, Thermocompression and Reverse Osmosis Systems. We can provide the exact system or any combination to get your job done.

Aqua-Chem's vapor compression plants are the standard in water supply systems for offshore drilling platforms and the bottled water industry, and are adapted to provide ultra-high purity water for the pharmaceutical industry. Aqua-Chem has developed a reverse osmosis system to purify virtually any kind of polluted water, including that contaminated with nuclear, biological or chemical warfare agents.

Although water desalting remains a significant portion of our business, other applications have grown in importance and volume. Aqua-Chem systems for fluid conservation, water recovery and pollution control are installed worldwide in chemical and process industries. Aqua-Chem's capability in separations is increasingly being used to solve difficult water recovery and reuse problems.

Our capabilities range from shop assembled prepackaged systems to complete turnkey projects. Aqua-Chem has the management, technical and financial resources to provide proper and timely execution of major projects throughout the world. Operator training and service support are provided to insure continued operation and reliability of our plants.

The Water Technologies Division of Aqua-Chem takes special pride in its industry leading resources, most notably its more than 250 employees and 60 agents and licensees worldwide. The company maintains a large manufacturing facility and a worldwide staff of engineers to ensure customer satisfaction from design through installation and startup. Aqua-Chem expends great effort to insure that the product is designed and produced with the highest possible quality. It's all part of our philosophy of doing things right.

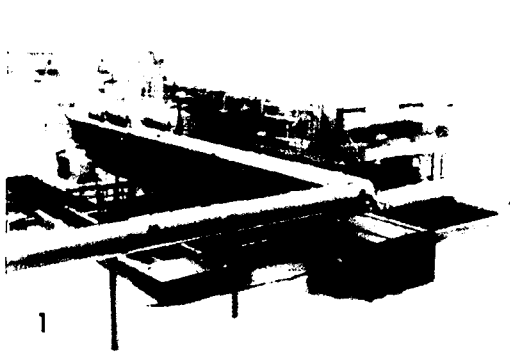

1

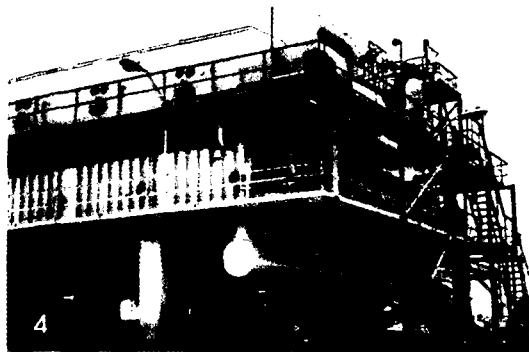

4

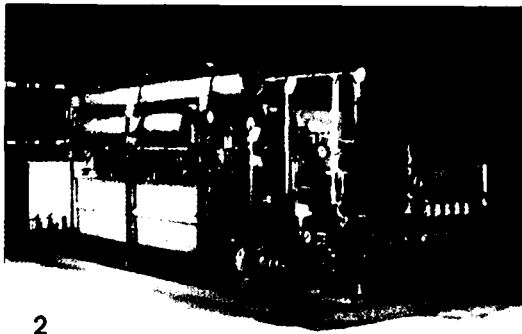

2

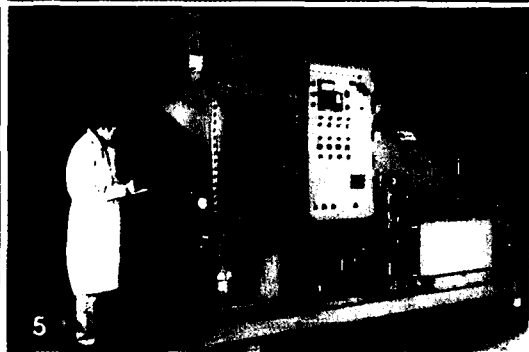

5

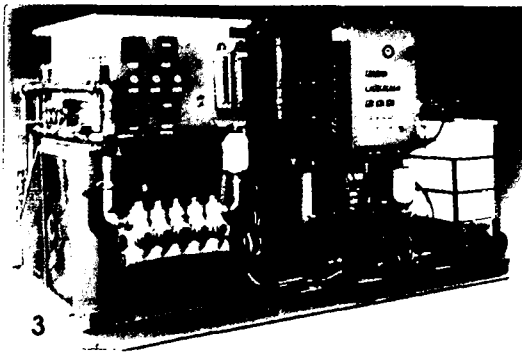

3

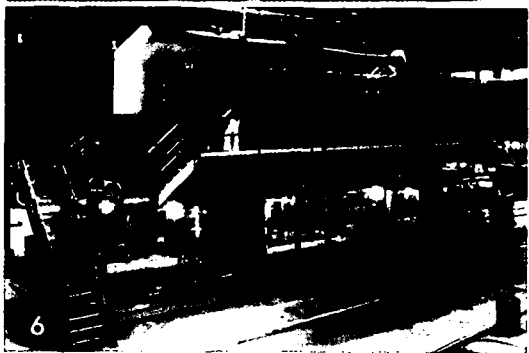

6

1. Potable and process water for a mining corporation and a South American community is supplied by a 720,000 GPD multi-stage flash seawater desalination plant.

2. Two 30,000 GPD seawater reverse osmosis desalination plants are installed at a resort island off Venezuela.

3. At a military station on Bermuda, drinking water is provided by a 40,000 GPD brackish water reverse osmosis plant.

4. One of two 1.6 MGD multi-stage flash evaporators produces potable water from seawater for the island of Aruba.

5. This vapor compression watermaker supplies over 800 GPH of distilled water for a Hong Kong bottled water company.

6. A multiple effect thermal compression desalination plant provides 250,000 GPD of water for process use in a middle eastern refinery

## aqua-chem, inc

Water Technologies Division  
210 W. CAPITOL DRIVE  
P.O. BOX 421  
MILWAUKEE WISCONSIN 53201  
414-961-5060 · FAX: 414-961-2723  
TELEX: 26679 AQM MIL



# ALUKER OF HUNGARY - YOUR IDEAL SUPPLIER OF ALUMINIUM SULPHATE

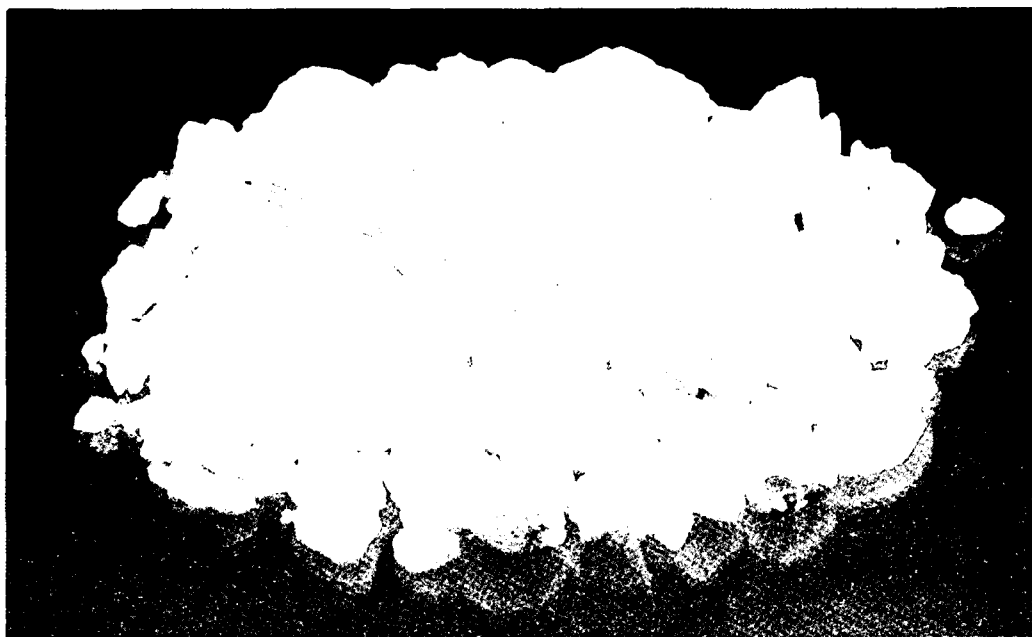

granulated  
 $Al_2/SO_{4/3} \cdot 13.5-14.5H_2O$

## Chemical composition:

Al <sub>2</sub> O <sub>3</sub> :	17-18%
Basicity:	0.0-0.5%
Fe:	0.005-0.007%
Insoluble residue:	0.04-0.07%
Grain fraction:	0-3mm, 3-8mm, 8-40mm
Packing:	5 ply paper bag & polyethylene bag

## Fields of application:

- WATER PURIFICATION
- SEWAGE PURIFICATION



Manufactured by:

**HUNGALU MOTIM WORKS**

Hungary - 9201. Mosonmagyaróvár  
P.O.Box: 75.

Exported by:

**HUNGALU TRADING CO. ALUKER**

Hungary - 1388 Budapest P.O.Box: 63

## CHEMICALS FOR WATER TREATMENT

713-240-6762. The Aquaward® calcium hypochlorite water disinfection tablet contains 70 percent available chlorine, the highest strength commercially available. These large, 2.625 inch diameter, 145 gram tablets are also the safest form of chlorine. The tablets are dispersed in one of EES tablet feeders which are capable of disinfecting up to 500,000 gallons per day. Disinfection is accomplished without moving parts.

**ELECTROCATALYTIC LTD** Norman Way, Severn Bridge Industrial Estate Portskewett, Newport Gwent NP6 4YN UK Tel: +44-291-423833, Telex: 497870. The "Pacpuri" on-site electrochlorination system is designed for the safe, hygienic production of sodium hypochlorite for potable water sterilisation. The packages include salt saturator and hypochlorite storage tanks, the brine injection pumps, a water softener, an electrolytic generator assembly, and a controlled power supply and system control panel. It is a development of the company's well proven "Chloropac" electrochlorination system with over 1300 installations worldwide since the early 1970s.

**ELLIS AND EVERARD (CHEMICALS) LTD** Caspian House, 61 East Parade Bradford West Yorkshire BD1 5EP UK Tel: +44-274-392411, Telex: 44737, Contact: Mr Cooper. Stockists and distributors of industrial and water treatment chemicals for many leading chemical manufacturers, branches throughout the UK plus an export division.

**FIBREDYNE INC** 190 Crosby Rd Dover NH 03820 USA Tel: +1-603-749-1610, Fax: +1-603-749-2699, Contact: Alice Bussierra. Manufacture disposable water filter cartridges.

**FOSPUR LTD** Alfreton Industrial Estate Somercotes Derbyshire DE55 4LR UK Tel: +44-773-604321/6, Telex: 377150, Fax: +44-773-606901, Contact: Mr Coleman. Manufacture and supply water treatment chemicals and equipment. Specialists in all forms of water and effluent treatment in industrial and domestic fields.

**GOLDCREST CHEMICAL LTD** Armitage Bridge Mills, Armitage Bridge Huddersfield West Yorks HD4 7NR UK Tel: +44-484-666606, Telex: 517243, Contact: Mr Smalley. Manufacturers and suppliers of chemicals and equipment for water, sewage and effluent treatment. The product range includes inorganics, synthetic polymers, starch derivatives and enzymes plus equipment for their efficient application.

**W R GRACE & CO, DEARBORN DIV** 300 Genesee St Lake Zurich IL 60047 USA Tel: +1-312-438-8241, Telex: 2-2428, Fax: +1-312-540-1588, Contact: Jeff Schummel. Leader in development of solutions for industrial water treatment problems. For 100 years has provided products and services to meet industry's boiling water, cooling water and waste water treatment needs.

**GRACE DEARBORN LTD** Widnes Cheshire WA8 8UD UK Tel: +4451-424-5351, Fax: +4451-423-2722, Contact: Michael R Cooke. Suppliers of speciality chemicals and consultancy for treatment of steam raising plants, cooling water systems, air conditioning plants and waste water treatment.

**GTC GRAND TRADE CONSULTING B V P O** Box 600 Gorinchem AP 4200 The Netherlands Tel: +31-1830-35133, Telex: 24055 gtc nl. Pumping systems for various purposes, flexible water reservoirs in all dimensions, reservoirs for trailer and pick-up, chemicals for the purification of drinking water, cleaning chemicals for piping systems and reservoirs, waterwell drilling and geotechnical services.

**GUARDIAN CHEMICAL SPECIALALITIES PO** Box 1743, 1225 W Princess St York PA 17405 USA Tel: +1-717-848-2570, Contact: Bruce Ketrick. Develop and market products and consultation services for industrial influent to effluent water treatment requirements. This includes clarification, pre-treatment equipment, boiler water chemical treatment, cooling water chemical treatment, fuel additives.

**HYDRO-X A/S** Tylstrupven 50 PB 30 Hjallerup DK-9320 Denmark Tel: +45-98-282111, Contact: Ole Kristensen. The product Hydro-X, forms the nucleus of the activities of the company and solves problems such as scale and corrosion, but automatic dosing equipment, analysing equipment and automatic blow-down systems are also furnished by Hydro-X A/S. The company exports through agents to Europe, Eastern Bloc countries, Africa and the Middle- and Far east. Hydro-X maintains an efficient agent-training programme to provide competent advice on all aspects of boiler-water treatment.

**HYDROFLO INC** 15 W Aylesbury Rd Timonium MD 21093 USA Tel: +1-301-561-1123. Manufactures a complete line of residential, commercial and industrial water treatment products. Patents pending on the NFA15 automatic neutralizer and Maryland State Health Department approved NSR844MP automatic household nitrate removal unit.

**INTEROX CHEMICALS LTD** PO Box 7 Warrington Cheshire WA4 6HB UK Tel: +44-925-51277, Telex: 82221, Contact: Mr Rogers. Chemical manufacture with water, sewage, industrial effluent, gas scrubbing and disinfection as speciality areas.

**INVERSAND CO** PO Box 45 226 Atlantic Avenue Clayton NJ 08312 USA Tel: +1-609-881-2345. Manufacturer of manganese greensand. Distributor of sand, gravel, anthracite, GAC and ion exchange resins for water treatment.

**JOSHUA GREAVES & SON LTD** PO Box 2, Garden St, Ramsbottom Nr Bury Lancs UK Tel: +44-706-824191, Telex: 635265, Contact: J W Greaves. Joshua Greaves & Son Ltd manufacture a complete range of fluid mixers and offer chemicals for use in the water and sewage industry.

**K & K - GREEFF CHEMICALS LTD** Suffolk House, George St Croydon CR9 3QL UK Tel: +44-1-686-0544, Telex: 28386, Fax: 44-1-686-4792, Contact: Mr Owen. Suppliers of calcium hypochlorite for industrial water treatment and specialised chlorination equipment for potable water.

**KING-LEE CHEMICAL CO** P O Box 9740 San Diego

## CHEMICALS FOR WATER TREATMENT

CA 92109 USA Tel: +1-619-463-7967. King Lee offers a complete line of chemicals for Water Treatment. Including polymers/focculant aids for turbidity reduction; corrosion prevention; and scale control additives. Products are used in support of process water pretreatment. Products offer economical water treatment for boilers, cooling towers, desalination equipment, piping systems, and general process water quality improvement. DISTRIBUTOR INQUIRIES ARE WELCOME!

**KJELL WATER CONSULTANTS INC** PO Box 834 Beloit Wisconsin 53511 USA Tel: +1-608-755-0422, Fax: +1-608-755-0538, Contact: Kevin Ripp. Kjell Water Consultants produces a liquid linear chain polyphosphate additive for potable water, to prevent internal pipe scale and corrosion. The product Aqua Mag inhibits "rusty water" from iron, "black water" from manganese, and helps remove scale tuberculation from the water lines. The laboratory will appropriately dose the Aqua Mag with proper feed equipment to protect your water system from these problems.

**KRONOS TITAN-GmbH** PO Box 100720, D-5090 Leverkusen 1, West Germany Tel: +49-21-43560, Telex: +8510823, Fax +49-21-4356481. KRONOS Water Treatment Chemicals based on iron salts for the treatment of drinking water, process water and cooling water; for purification of industrial and municipal water water; for dewatering of sewage sludge; and for the pretreatment for seawater desalination by RO and odour control for water water collection system. Many years of successful experience in water treatment and waste water purification qualify KRONOS TITAN-GmbH for a leading position in this field. KRONOS-TITAN GmbH is a subsidiary of NL Chemicals, Inc., Hightstown/USA a company with an annual turnover of over 1,000 million US-\$. KRONOS Water treatment chemicals are sold worldwide and produced in Leverkusen and Nordenham, West Germany, and in Fredrikstad, Norway.

**MAGICHEM INC** 2080 E Lunt Avenue Elk Grove Village IL 60007 USA Tel: +1-312-437-9400. Distributors of liquid polyphosphate water treatment additives for control of hydrogen sulphide odor, corrosion problems plus sequestering iron.

**MELCHEMIE HOLLAND BV** Jansbuicnsgel 20 Arnhem The Netherlands Tel: +31-85451251, Telex: 4501945523, Fax: +31-85-425-093. Dry Chlorine Products (calciumhypochlorite and other disinfectants), flocculants (aluminium sulphate, ferrous sulphate, polyelectrolytes), pH regulating agents (hydrated lime, sodiumcarbonate and sodiumbcarbonate), sanuril 115, aquaward (easy chlorination system), melquick (effervescent chlorine tablets) and swimming pool chemicals.

**MENCO CHEMICAL** 442 Boston Post Rd Waterford CT 06385 USA Tel: +1-203-442-5628, Contact: John Menzies. Manufacturer of complete line of boiler cooling and process water treatment chemicals.

**MID AMERICA WATER TREATMENT INC INT'L** 2045 Lake St Hanover Park IL 60103 USA Tel: +1-312-289-6400. Manufacturer of a complete line of residential

and commercial water conditioning equipment including softeners, filters, chemicals, chemical feed pumps, RO systems and a complete line of component parts, pressure vessels, resin, valves, brine tanks, feeder tanks, filter housings, cartridges and carbon. (WT)

**MITCO WATER LABORATORIES INC** P O Box 1435 Winter Haven FL 33882-1435 USA Tel: +1-813-967-4456. Chemicals, equipment and service for treatment of commercial and industrial cooling tower, boiler and potable water systems. Ion exchange, reverse osmosis and filtration process water purification equipment. Full service analytical laboratory.

**MOGUL DIV, DEXTER CORP** P O Box 200 Chagrin Falls O H 44022 USA. Full service water treatment speciality chemical company.

**MOLRY-CHIMIE SA** 56 Rue De Maubeuge Paris F-75009 France Tel: +33-1-42-80-08-66, Telex: 660551, Fax: +33-1-42-80-64-12, Contact: M Rabaneau. Chemicals and equipment for water purification softeners, filters, demineralization and neutralization etc.

**PHYSICHEM TECHNOLOGIES INC** 13706 Research Boulevard J216 Austin TX 78750 USA. Complete source for speciality water treatment chemicals, ion exchange resins, feed equipment, testing supplies and consulting services. Products and services designed to control corrosion and deposition as well as wastewater streams.

**THE PQ CORP** PO Box 840 Valley Forge PA 19482 USA Tel: +1-215-293-7305, Fax: +1-215-688-3835, Contact: Nancy White. Supply sodium silicates for the stabilization of dissolved iron and manganese and inhibition of corrosion in water storage and distribution systems. Also used as coagulant aids for raw and wastewater treatment.

**PREUSSAG AG** P O Box 6009 Kunststoffe und Armaturen Peine D-3150 West Germany Tel: +49-5171-4030, Telex: 92670. PVC SBF casing and screens for water wells, including PVC SBF precoated screens, PVC SBF NORIP pipes for monitoring wells, PVC SBF SIKO riser pipes, SBF handpumps KARDIA and TURNI, SBF drilling muds and additives, SBF DEPO pipes for dewatering or degasification of waste disposal sites, Chlorine for water treatment, SEBA Hydrogeological Equipment.

**PURITE LTD** Unit E, Bandet Way, Thame Industrial Estate Thame Oxon OX9 3SJ UK Tel: +44-844-217141, Telex: 837561, Contact: Mr Lund. Manufacturers of reverse osmosis units, desalination and reverse osmosis units and cleaning chemicals, deionisation equipment, various filtration units and test kits.

**PUROLITE CO DIV OF BRO TECH CORP** 150 Monument Rd Bala Cynwyd PA 19047 USA Tel: +1-215-668-9090. Manufacturer of a complete line of ion exchange resins.

**PUROLITE INTERNATIONAL** Cowbridge Rd Pontyclun Mid Glamorgan CF7 8YL UK Tel: +44-443-229-334, Telex: 498440, Fax: +44-443-222336, Contact: Mr John Evans. Manufacture ion exchange resins for water treatment and effluent treatment.

# VARION®

## **Ion Exchange Resins**

for

- conventional water treatment
- decontamination of radio-active waste
- household water treatment

**VARION KS VARION KS-N  
VARION AD VARION AT VARION AT-N**

and

other special cation and anion exchange resins

**Manufacturer:**

**NITROKÉMIA IPARTELEPEK  
8184 Füzfőgyártelep, Hungary**



**Export:**

**CHEMOLIMPEX  
Hungarian Trading Company for Chemicals  
H-1805 Budapest P.O.B. 121. Hungary**

# VARION®

## CHEMICALS FOR WATER TREATMENT

**QUANTUM CHEMICAL CORP EMERY DIV** 11501 Northlake Drive Cincinnati OH 45249 USA Tel: +1-513-530-7300. Ozone technology including design and equipment supply.

**QUES INDUSTRIES INC** PO Box 02590 Cleveland OH 44102 USA Tel: +1-216-961-7445. Manufactures water treatment chemicals: boiler water treatments, cooling water treatments, iron sequestrants, resin cleaners and biological cultures for grease trap and septic systems. (WT)

**RESINTECH** PO Box 966 Cherry Hill NJ 08003 USA Tel: +1-609-429-6620, Contact: Mike Gottlieb. Manufacturer of ion exchange resins. (WT)

**RO/CO CHEMICAL SYSTEMS INC** 4004 Volta Avenue Brentwood MD 20722 USA Tel: +1-301-779-2400. Distributor of water treatment chemicals, services and related chemical feed and control equipment.

**ROHM AND HAAS COMPANY** Independence Mall West Philadelphia PA 19105 USA Tel: +1-215-592-3154, Telex: 845247, Fax: +1-215-592-3377, Contact: Mr Flor. Multinational chemical company, manufacturer of ion exchange resin and absorbents for water treatment.

**S E E** Rue de la Science 5 Brussels B 1040 Belgium Tel: +32-2-230-9314, Telex: 25 237, Fax: +32-2-230-7613, Contact: Ms Shcotte. Water treatment plants: drinking water, waste water, water for industry, swimming pool water. Chemical products for water conditioning. Prefabricated units for the production of drinking water and waste water treatment.

**SCHAEFER CHEMICAL PRODUCTS CO** 3000 Carrollton Rd Saginaw MI 48604 USA Tel: +1-517-753-1877. Manufacture water treatment chemical products.

**SCHILLING-CHEMIE GMBH** P O Box 11 36 Freiberg D-7149 West Germany Tel: +49-7141-703-0, Fax: +49-7141-703178. Varidos chemicals, control-equipments and pre-treatment plants for water treatment in cooling water, boiler water, heating water and drinking water.

**SORB-TECH INC** 1442 Lake Front Circle #190 The Woodlands TX 77380 USA Tel: +1-713-292-1726. Sale and application of activated carbon.

**STILES-KEM DIV MET-PRO CORP** 3301 S Sheridan Rd Zion IL 60099 USA Tel: +1-312-746-8334. Manufacture water treatment chemicals for control of scale, red water and corrosion in municipal, industrial, commercial and domestic water systems to prolong life of water using equipment and distribution systems.

**STRANCO LTD** Commercial Rd Eastbourne Sussex BN21 3XE UK Tel: +44-323-37011, Fax: +44-323-646035, Contact: Mr Judd. STRANCO'S industrial division manufactures polyelectrolyte preparation plant for the sewage and wastewater industries.

**SUREX SP PRODUCTS LTD** Units 10 7 11 Airport Trading Estate Biggin Hill Kent TN16 3BW UK Tel: +44-959-76000, Fax: +44-959-71000, Contact: Derek Acca. Suppliers of water treatment chemicals, dosing sys-

tems and control filtration specialists to swimming pool, aquatic and all water treatment markets - national and international.

**SUTCLIFFE SPEAKMAN CARBON LTD** Guest St Leigh Lancs WN7 2HE UK Tel: +44-942-672101, Telex: 67555, Fax: +44-942-677136, Contact: Colin Moore. Sutcliffe Speakman Carbons manufacture activated carbon from coal and coconutshells for a wide range of applications including water/effluent treatment, sewerage odour control and air filtration. Impregnated carbons are also available.

**SYBRON CHEMICALS INC** PO Box 66, Birmingham Rd Birmingham NJ 08011 USA Tel: +1-609-893-1100. Highly specialized in the manufacture of ion exchange resins for application in the following fields: household water softening, nitrate removal, water treatment (both industrial and commercial), the sugar industry, pharmaceutical, power stations, electronic industry, waste water treatment, paper mills, high pressure boilers and recovery of precious metals. (WT)

**TEAM ASSOCIATES** 1025 Brown Avenue Toledo OH 43607 USA Tel: +1-419-255-7737. Manufactures water treatment chemicals for boilers, cooling towers, chill water systems and heat exchangers. (WT)

**TENNESSEE CHEMICALS COMPANY** 3400 Beechtree Rd NE, Suite 401 Atlanta GA 30326 USA Tel: +1-404-233-6811, Telex: 981036, Fax: +1-404-239-6701, Contact: Mr Leon Babb. Manufacture and market chemicals for water treatment and purification.

**TOMCO EQUIPMENT CO** 3340 Rosebud Rd Loganville GA 30249 USA Tel: +1-404-979-8000, Telex: 804227, Fax: +1-404-985-9179, Contact: Chuck Hyde. Supplies both liquid carbon dioxide and submerged combustion recarbonation systems. Our knowledge of CO<sub>2</sub>-related equipment goes into every system we supply to our customers.

**UNIVERSAL SOLUTIONS INC** 12416 N 28th Drive Ste 18-252 Phoenix AZ 85029 USA Tel: +1-602-371-0797. Manufacturing water treatment and scale removing chemicals. Custom design of chemicals.

**WALTRON LTD** P O Box 1070 50 Tannery Rd Whitehouse NJ 08888 USA Tel: +1-201-534-5100. Manufacturer of water treatment chemicals for boilers and cooling towers, heating and cooling systems, potable water and transportation equipment.

**WATCON INC** 2215 S Main South Bend IN 46613 USA Tel: +1-219-287-3397, Contact: George Resnik. Water treatment surveys, testing, chemicals, equipment for industrial, commercial, municipal and institutional requirements.

**WATER CONDITIONING CANADA LTD** 580 Park St Regina Saskatchewan S4N 5A9 Canada Tel: +1-306-545-6990, Telex: 071-2718. The manufacture and distribution of residential, commercial and industrial water treatment equipment. Water softening, iron and sediment filtration, reverse osmosis and distillation as well as purification products.



# **KRONOS<sup>®</sup>** **Water Treatment** **Chemicals** based on iron salts

for the treatment of  
water, waste water and  
sludge.

Especially:

- pretreatment  
for seawater  
desalination by RO;
- odour control for  
waste water  
collection systems.

KRONOSTITAN-GMBH  
P.O. Box 10 07 20  
D-5090 Leverkusen  
West Germany  
Tel. 00 49/214-35 60  
Tx. 8 510 823

**N**  **Chemicals**

## CHEMICALS FOR WATER TREATMENT

**THE WISEMAN GROUP** P O Box 58, High St Ingatestone Essex UK Tel: +44-277-353330. The Wiseman Group develop and manufacture chemical products for the international plumbing industry. Their principal brands are Everflux and Fingertip self-cleaning plumbing fluxes and the Radtect anti-corrosion treatments.

### Desalination and Water Softening

**A AND C WATER DISTRIBUTORS INC** 420 W Route 34 Plano IL 60545 USA Tel: +1-312-552-8200, Contact: John Malovrich. Manufacture water treatment equipment, specializing in softeners, reverse osmosis aerators, filters. Labelled/unlabelled equipment.

**AL KAWTHER INDUSTRIES LTD** PO BOX 7771, JEDDAH 21472 Tel: +96626360644, Telex: +602907 KAWTHER SJ, Fax: +96626374337. Al-Kawther provides a wide range of consultancy, design and operation maintenance services as well as supplying: Packaged water/waste-water treatment plants, Filters and Sterilisers, Custom built water/waster-water treatment plants.

**A W C INC** 330 E Hwy 14 Tyler MN 56178 USA Tel: +1-507-247-5436. Manufacturer of a complete line of residential and commercial water softeners. Distributor for Aquathin Corp. (WT)

**AITON & COMPANY LTD** Stoves Rd Derby DE2 4BG UK Tel: +44-332-291122, Telex: 37444, Fax: +44-332-291123, Contact: Mr Shed. Aiton manufacture desalination equipment which employs a system of mechanised evaporation. The company is also involved in the fabrication of thick wall piping, for application in steam turbine power plant.

**ALAMO WATER REFINERS INC** 1415 Jerry St San Antonio TX 78201 USA Tel: +1-512-734-7771. Manufactures and wholesales water softeners, iron removal filters, aerators/degasifiers, sediment filters, taste and odor filters, chlorinators, iodine feed systems, pH neutralizing systems, etc. (WT)

**ALL PURPOSE MACHINES AND PLANT LTD** 55 Seven Oaks Avenue, Heaton Moore Stockport Cheshire SK4 4AU UK Tel: +44-61-432-1877, Contact: N P Lister. Designers and manufacturers of mechanical handling and process plants. Reclamation of oil and solvents, distribution plants, steel fabrications, hydraulic lift tables and desalination plant.

**ALPHA WATER CONDITIONING CO** 403 W Main St Fountain City IN 47341 USA Tel: +1-317-847-2561, Contact: Mr Roark. All kinds of water conditioning equipment for domestic, commercial and industrial purposes. Purification, chemical feed pumps and all types of filter media, built to customer specification.

**AMERICAN AQUA** 2500 Interplex Drive Treose P A 19047 USA Contact: . Manufacturer of high quality RO membrane elements in both CTA and TFC membrane. 2 x 12" elements available as well as 2. 5" x 14", 2. 5" x 21" and 2. 5" x 40" in TFC membrane.

**AMERICAN SALT CO** 3142 Broadway Kansas City M O 64111 USA Tel: +1-816-753-7100. Manufactures full line of water softener salt.

**APPLIED WATER ENGINEERING (AWE) INC** 2759 South 300 West "C" Salt Lake City UT 84115 USA Tel: +1-801-486-7774, Contact: Steve Carr. Applied Water Engineering Inc (AWE) manufactures reverse osmosis water purification systems with outputs from 22. 5 litres per day and above. Applications include laboratory, medical, dialysis, spot rinse and drinking.

**AQUA-CHEM INC** 210 W. Capitol Drive/PO Box 421, Milwaukee, Wisconsin 53201, USA Tel: +4149615060, Telex: +26679AQM MIL., Fax: +4149612723. A pioneer in design and manufacture of desalination equipment since 1942. Packaged, field-erected and turnkey systems available in multi-stage flash, multiple effect, vapor compression and reverse osmosis. Size ranges from 100 cubic meters/day to 6000 cubic meters/day. Authorised service, parts, start-up capabilities and agents network available worldwide.

**AQUA PRODUCTS INTERNATIONAL LTD DIV OF RAYTEC WATERGROUP** 500 W Oklahoma Avenue Milwaukee WI 53207 USA Tel: +1-414-747-3700, Contact: Mike Colburn. Manufacture residential and commercial reverse osmosis water treatment systems.

**AQUA-FLO INC** 6244 Frankford Avenue Baltimore MD 21206 USA Tel: +1-301-485-7600, Fax: +1-301-488-2036. Acid treatment, clogged water line, stuck valves and algae growth are eliminated with high energy ionic induction chamber. You can descale your pipes while reducing chemical costs. As water passes through the device, hard water minerals are polarised, ions repel each other instead of clinging together and the minerals can flow through the system.

**AQUAMATCH INC** 23011 Moulton Parkway Ste G-5 Laguna Hills CA 92653 USA Tel: +1-714-472-8166. Manufacturer of reverse osmosis systems, water filtration, water softening and deionization systems for point of use, commercial and industrial markets. Can be supplied as systems or components. (WT)

**AQUANOVA BV** Glashaven 10C Rotterdam 3011 XH The Netherlands Tel: +31-10-414-5365, Telex: 21367, Fax: +31-10-412-2424, Contact: Mr Aafges. Manufacturers of sea-water desalinators.

**AQUAPUR BV** Nottenbootsterstraat 1 Postbus 336 Vlaardingen 3130 AH The Netherlands Tel: +31-10-435-3711/10-435-3622, Telex: 25452, Fax: +31-10-435-0433, Contact: Mr Looman. Aquapur BV a well known Dutch company in the field of water treatment, supplies a wide range of equipment for the industry, including small drinking water plants, demineralisation plants, softening plants, reverse osmosis plants, filtration plants, etc. The trade-department of Aquapur is the exclusive distributor for HACH-water analysis equipment, LUTZ-barrelpumps, CFG-prominent dosing pumps and supplies all kind of filters, ion exchange resins and filter fittings.

**AQUASOLAR** Gutenbergstrabe 1 3014 Laatzen 1 POB

---

# CHEMICAL SOLUTIONS FOR CRITICAL WATER TREATMENT REQUIREMENTS

---

KING LEE CHEMICAL COMPANY offers versatile chemical solutions to many water treatment, water distribution, and wastewater treatment problems.

- Scale Control/Descaling for Reverse Osmosis and Distillation Process Equipment
  - Corrosion and Scale Control for Distribution Systems
  - Microbiological Control for Reverse Osmosis and Cooling Towers
  - Turbidity Reduction Polymers and Flocculant Aids for Water Systems
  - Microbiological Boosters for Wastewater Treatment
- 

## Reverse Osmosis and Distillation

Insuring the supply of potable and industrial water when relying on reverse osmosis or distillation processes can be safely and economically accomplished when using KING LEE's advanced chemical products. Scale and equipment fouling can be prevented/controlled with the **Pre-Treat 110** line of dispersants and antiscalants. These highly effective chemical agents are used at economically low dosage levels. They offer the highest level of performance available.

Restoring equipment performance due to efficiency losses, requires KING LEE's specialty line of distillation descalers or reverse osmosis membrane cleaners. This high quality product line, **KL SERIES** and **DIAMITE** cleaners is recognized world-wide for safe and effective cleaning performance. Silica, hardness, microbiological, heavy metals and other causes for system performance losses are no match for the cleaning power of KING LEE's, **KL SERIES** and **DIAMITE** cleaners.

## Corrosion and Scale Control

Water distribution piping, cooling towers, cooling systems, and other water processing equipment lose efficiency when scale deposits build-up on surfaces in contact with process water. KING LEE's **PRE-TREAT** line of scale and corrosion inhibitors offer economical solutions to these problems. used at low dosage levels, **PRE-TREAT** products can handle the toughest scale and corrosion applications.

For more information, write or FAX, and ask for specific product technical brochures. For answers to specific applications, please include description of the situation and we will analyse the problem.

P.O. Box 146, Del Mar, CA 92014, U.S.A.  
Phone: (619) 693-1358  
FAX: (619) 693-1358, or (214) 548-0782

## Microbiological Control Agents

Equipment performance losses for reverse osmosis systems and cooling towers are often caused by the growth and accumulation of biomass on membrane and heat transfer surfaces. Removal of this biomass can be safely and economically accomplished with KING LEE's **ANTIMICROBIAL DIAMITE** cleaners. The prevention of microbiological growth can be safely and effectively performed when using KING LEE's **MICROTREAT** line of disinfectants.

## Turbidity Reduction

King Lee offers a complete line of cationic, anionic and non-ionic polymers and floc aids, for the efficient reduction of suspended solids in high turbidity water. When turbidity reduction is necessary consider KING LEE's **KL-FLOC** line of economical chemicals.

## Microbiological Boosters for Waste Water

Efficient digestion of municipal waste without the liberation of offensive odors, such as hydrogen sulfide, can be economically achieved by using KING LEE's enzyme activators. **KL-ZYME**. These highly efficient enzymes increase the overall efficiency of biological wastewater treatment systems. **KL-ZYME** boosts the activity of microbiological organisms used for wastewater treatment. This allows for more complete reduction of organic wastes without the creation of undesirable odors.

**KING LEE**  
Chemical Company

## DESALINATION AND WATER SOFTENING

110112 West Germany Tel: +49-51-18236914 Fax: +49-51-18236550. Solar desalination plants to produce potable water or/and water for irrigation. The plants can be constructed for a water production rate from 20 litre/day up to 1700 litre/day. In the water range of 20 up to 1000 litre/day we suggest to use the small plant type "SIM". And over 1000 litre/day we suggest to use the plant type "SME". In addition the desalination plants can be integrated in a Greenhouse. Complete constructed from AQUASOLAR too. This enables to produce high quality food beside water production. Solar Heater "SOLADUR" with a hot water tank to produce hot water by solar energy. No electric power for pumps are required!

**AQUATHIN CORPORATION** 2800 W Cypress Creek Rd Ft Lauderdale FL 33309 USA Tel: +1-305-977-7997. Manufacturing and marketing of water purification systems, utilizing combination of reverse osmosis plus deionization for salt free, mineral free, toxic pollutant free and bacteria free drinking water.

**AROCON CORPORATION** 2681 Dow Avenue Unit F Tustin CA 92680 USA Tel: +1-714-731-4555, Telex: 6971411, Contact: Sammy Garouny. We design and manufacture reverse osmosis systems to treat brackish and sea water.

**ART - ANTRIEBS - UND REGELTECHNIK GmbH** Redtenbachergasse 19 Steyr A-4400 Austria Tel: +43-7252-24-1-52. Water containing calcium destroys both pipes and appliances, and phosphates and lyes pollute the environment. A solution to such problems is provided by the "Decaltron" water softener, which operates on the ion-exchange principle and with its low salt and water consumption contributes considerably towards keeping the environment clean. The softeners are of compact design and make use of cheap industrial-grade sodium chloride.

**ARTESIAN-WATER CONDITIONING INC** 4900 NW 15th St Margate FL 33063 USA Tel: +1-313-742-7122, Contact: Jack Stead. All types of industrial commercial and residential water treatment specifically water softening iron removal, case and odour control. All types of contaminate and bacterial removal.

**ATLANTIC FILTER CORPORATION** 3112 45th St F9 West Palm Beach FL 33409 USA +1-305-683-0101 Fax: 704553, Contact: Peter Wareham. Manufacturer and distributor of a complete line of water treatment and purification equipment. Reverse-osmosis a speciality. In business 32 years, giving professional advice. Member of the water quality association.

**ATLAS-DANMARK/NIREX ENGINEERING** 20 Metalbuen Ballerup DK 2750 Denmark Tel: +45-2-97-73-11, Telex: 35115, Fax: +45-2-97-42-74, Contact: Gitte Jensen. Atlas-Danmark/Nirex Engineering is a member of the Alfa-Laval group. The company markets a full range of the Nirex plate type water makers together with the Atlas-Danmark range of water makers.

**AUTOTROL CORP** 3730 N Glen Pk Rd Milwaukee WI 53209 USA Tel: +1-414-228-9100, Telex: 26-9538, Fax: +1-414-228-8729, Contact: Tom Husman. Autotrol is an

innovative leader in the development and manufacture of water treatment equipment including softener, filter, and deionization controls, water meter/controllers, dry pellet chlorination systems and hydraulically operated feed pumps.

**BEST-WATER CONDITIONING INC** 3603 N Muskingum Avenue Odessa TX 79762 USA Tel: +1-915-366-5295. Manufactures and assembles reverse osmosis systems, a repressurization unit, post-carbon filtration and an ultraviolet disinfection unit built all-in-one on an open steel frame. The product water tank is also available to set next to the water equipment (WT)

**BK LADENBURG** Dr Albert-Reimann-Strasse 2 Ladenburg D 6802 West Germany Tel: +49-6203-77-4307, Fax: +49-6203-1-2818, Contact: Ferdinand Puhe. B K Ladenburg (Benckiser-Knapsack GmbH) - a fifty/fifty joint venture of Hoechst AG and Benckiser GmbH - has been successful for over twenty years in international markets. The Albaphos® 100-line are speciality products for the prevention of scale formation and incrustation in seawater desalination and cooling water systems.

**BRINECELL MANUFACTURING CORPORATION** 2109 West 2300 South, Salt Lake City, Utah 84119, USA, Tel: +1-801-973-6400, Fax: +1-801-973-6463. This well-established US manufacturer markets its multi-patented water treatment, Brinecells. The equipment operates using salt (NaCl) as the source of sewage treatment. Electrolysis of the water and salt liberates nascent ozone, nascent chlorine and their respective hydroxyl/free radicals. Produced simultaneously and working synergistically, these agents have proven to destroy PCB's and all oxidizable organics while sterilising and decoloring the effluent, leaving it safe and legal to dispose of. Brinecells recirculate the effluent from 200 litres per minute to as high as 8m<sup>3</sup> per minute using from 1 to 8 KWH. Maintenance requires only a five minute acid wash daily (per unit) and each has its own built-in acid-washer. Plain 35 percent HCl is recirculated through the cells and reused rather than consumed. Four models are available.

**BSC EXPORTS LTD** Lodge View, Dickens St Blackburn BB1 1RN UK Tel: +44-254-65384, Telex: 63474, Fax: +44-254-681759, Contact: Vincent Peterson. Suppliers of reverse osmosis systems and drinking water systems.

**C'TREAT-OFFSHORE WATERMAKERS** Suite 180 1442 Lake Front Circle The Woodlands TX 77380 USA Tel: +1-713-292-3193, Contact: Scott Campbell. C'Treat Offshore Watermakers supplies reverse osmosis desalination equipment principally for off-shore drilling rigs, production platforms and land based brackish water systems. C'Treat's primary objective is to build off shore watermakers in a simple, reliable and economical way to operate.

**CAIRD & RAYNER-BRAVAC LTD** Otterspool Way, Watford By-Pass Watford Herts WD2 8HL UK Tel: +44-923-226295, Telex: +922614, Fax: +44-923-226514. Established in 1889, Caird & Rayner-Bravac specialise in desalination and water treatment systems for brackish

## DESALINATION AND WATER SOFTENING

and seawater. The production programme offers a complete "in house" manufactured system designed to clients specifications, for on-shore and off-shore projects.

**CAMA F MAYER KG** PO Box 1154 Taunusstein 1 6204 West Germany Tel: +49-6128-3031, Fax: +49-16-108-3035, Contact: Dr Bingel. Suppliers of water softening plant, drinking water treatment plant and equipment for demineralisation and desalinisation of water.

**CANADOCHLY WATER CONDITIONING CO INC** Box 131 East Prospect PA 17317 USA Tel: +1-717-252-2369. Manufacturer of water softeners, filters and iodine feeders.

**CARESS INC** 1107 Columbus Avenue Grand Haven MI 49417 USA Tel: +1-616-842-8850, Telex: 228409 CHAL MCHYGVEN, Fax: +1-616-842-6511, Contact: Charles R Chadel. Manufacturers of quality water softeners, filters, di and r/o systems for residential, commercial and industrial applications.

**CARGILL INC, SALT DIVISION** Box 5621 Minneapolis MN 55440 USA Tel: +1-612-475-6579. Produces and markets a complete line of water softener salt products. Bulk and package sales, rock, pellet and brine blocks. (WT)

**CENTRAL COAST WATER SYSTEMS** 6855 Morro Rd Atascadero CA 93422 USA. Water softening and purification equipment to remove bad taste, contamination, sulfur, iron and hardness.

**CHALLENGER WATER INTERNATIONAL** 133 Newport Drive San Marcos CA 92069 USA Tel: +1-619-471-2282, Fax: +1-619-471-2046, Contact: Pat Webb. Manufacture reverse osmosis equipment both domestic and commercial. Also sell reverse osmosis component parts to the OEM industry.

**CHARGER WATER CONDITIONING** 19500 Mannheim Rd Mokena IL 60448 USA Tel: +1-312-479-1114. Manufacturer/supplier of softeners, filters and components to water conditioning dealers.

**CHEMICAL ENGINEERING CORP** PO Box 266, US Route 335 Churubusco IN 46723 USA Tel: +1-219-693-2141, Fax: +1-219-693-3956, Contact: Joanna Ewing. Manufacture water softeners and filters. Also sell under-the-sink water treatment for drinking water. Handle commercial units for larger areas like hotels.

**CHEMLAB-INSTRUMENTS LTD** Hornminster House 129 Upminster Rd Hornchurch Essex RM11 3XJ UK Tel: +44-4024-57011, Telex: 8951347, Contact: Jeff Cox. Chemlab Instruments is an acknowledged leader in the field of water analysis, sterilisation and laboratory purification. Products include peristaltic pumps, reverse osmosis, multichannel analysers, monitors, sterilisers, flow injection and laboratory equipment.

**CHRIST HOLLAND BV** Energieweg 5 Zoeterwoude NA NI-2382 The Netherlands Tel: +31-71-899218, Telex: 39443, Fax: +31-71-897429, Contact: Mr Reisbter. Christ Holland BV, develops and constructs water treatment

systems for softening, demineralisation, desalination, ultra-filtration and ultra-pure water systems for industrial and potable purposes. Christ Holland BV, is a daughter-company of Christ AG, Aesch, Switzerland.

**COSTER ENGINEERING P O** Box 3407, Airport Rd Mankato MN 56002 USA Tel: +1-507-625-6621. Manufacturer of reverse osmosis equipment for municipal, industrial, farm and home applications. (WT)

**COTTEN INDUSTRIES** 275 Schoolheimer Rd Canastota New York 13032 USA Tel: +1-315-363-8084, Contact: Mr Jack Cotten. Manufacturers and suppliers of a complete line of water conditioners for softening, filtration, UV sterilisation. The company also produces reverse osmosis and demineralisation equipment.

**CULLIGAN INTERNATIONAL CO** Blenheim Rd, Cressex Industrial Estate High Wycombe Bucks HP12 3RS UK Tel: +44-494-36-484, Telex: 83-146, Fax: +44-494-23833, Contact: Mr William. Water may be available - but is not always safe to drink. Culligan, the world's largest supplier of water treatment equipment, can solve your water problems.

**CWC INDUSTRIES INC** 2686 Lisbon Rd Cleveland OH 44104 USA Tel: +1-216-721-4747. Manufacture water treatment compounds, water softeners, environmental testing and consultation.

**D W SYSTEMS INC** 42066 Avenida Alvarado, Ste P Temecula CA 92390 USA Tel: +1-714-676-7600. Engaged in design, engineering, consulting and manufacturing of systems and components for reverse osmosis, ultra-filtration and ultra-pure water applications. Components include 2 1/2" and 4" low pressure vessel housings and filter canister housings. (WT)

**DARCO WATER SYSTEMS INC P O** Box 2993 3643 Hillsborough Rd Durham NC 27705 USA Tel: +1-919-383-9421. Filtration, reverse osmosis, ultra filtration, ultraviolet purification, deionization and ion exchange resins for laboratories and industrial applications.

**DDS FILTRATION P O** Box 149 Nakskov DK-4900 Denmark Tel: +45-53-92-27-99, Telex: 47558 ddsfil dk, Fax: +45-53-92-31-11. DDS Filtration develops, manufactures and markets membranes and turnkey reverse osmosis plants. Both plate and frame as well as spiral wound systems are sold for a wide range of applications within the water treatment industry. Especially, DDS Filtration

**DESALINATION SYSTEMS INCORPORATED** 1238 Simpson Way Escondido California 92025 USA Tel: +1-619-746-8141, Telex: 697890, Fax: +1-619-747-8253, Contact: Mr Micolaisen. Major manufacturer/supplier of reverse osmosis and ultrafiltration membranes and spiral-wound elements to the OEM market.

**DOWNEY WELDING & MFG CO INC P O** Box 279 Downey CA 90241 USA Tel: +1-213-923-9616. Manufacturer of both domestic and commercial water softeners. (WT)

**DRACOR WATER SYSTEMS P O** Box 2993, 3643

# Al Kawther of Saudi Arabia

Al Kawther have recently been awarded two contracts, worth over 10 million SR, which were won against international competition for industrial water projects in the Kingdom of Saudi Arabia.

The projects are for the Saudi Pharmaceutical industries and medical appliances corporation (SPIMACO) & the Saudi Arabian Ductile Iron Pipe Factory (SADIP), for Amiantit in Dammam.

The water treatment plant for the Spimaco factory consists of an R.O. facility, demineralization, a high purity filtration and recycle plant. A feature of the design is the high quality material specified to meet the pharmaceutical industry requirements. Al Kawther have been contracted to design, supply, install and commission all the mechanical and electrical equipment associated with the water treatment.

Sadip Factory on the other hand includes an R.O. plant to provide all the make up water requirements for the factory from the cooling circuits to the melting and casting machines. A significant feature of the process design is that water recycling has been used extensively on both the cement lining and varnishing lines incorporating clarification and dissolved air floatation techniques. These circuits have been incorporated into the design to reduce the factory water consumption and to protect the local environment from waste water pollution.

It is believed that this is one of the first projects of this type in Saudi Arabia.

Al Kawther total capability to offer locally manufactured products to the Saudi Arabian, as well as the Middle East market has therefore been enhanced further through a major investment program at its Jeddah facility with the recent putting on stream of a dishing machine, press cutters and rolling machinery.

This expansion has paid off for Al Kawther as it can now offer complete system designs and manufacturing of sewage and water

treatment plants. Projects undertaken in 1988 totalled in excess of 45 million Saudi Riyals and included plants for Makkah water bottling plant, King Fahd Armed Forces Hospital in Jeddah, Sana'a Air Base in North Yemen, National Guard housing complex in Makkah, private palace in Bahrain, Medina Airport, Al Kharj Airbase, Taif and Khamis Mushayt Air bases, Gulf Hospital in Dammam, in addition to many smaller treatment plants.

For the future, Al Kawther is looking to establish a product list of water and sewage equipment which can be locally manufactured to the requirement of any contractor or water treatment company who is working in Saudi Arabia and the Middle East. The cost advantage being the saving on shipping and import duties into 600 countries would be levied.

The faith and trust shown in Al Kawther by the Saudi Government agencies has been proven by their calling on Al Kawther to complete projects undertaken by foreign companies who were unable to fulfil their commitments.

Al Kawther in JV with its sister company Mawarid Construction have built two sea water desalination plants on a turnkey basis in excess of 150 million Saudi Riyals last year. Currently both plants are under commissioning.

The operation and maintenance division of Al Kawther has also been in an expansionary mood and has taken several O&M contracts recently. Currently the division is finalizing negotiations on projects which would be worth in excess of 100 million Saudi Riyals over the next three years.

These achievements encouraged Al Kawther to seek new markets and the company has embarked upon a program of opening offices in North Yemen, UAE, Oman, Egypt, Iraq, Bahrain and Kuwait to lay a strong foundation for the company's future into the 1990's and into the 21st century.

## The Water/Wastewater Engineers



Containerised  
Mobile  
Reverse  
Osmosis  
Plants  
by  
Al Kawther

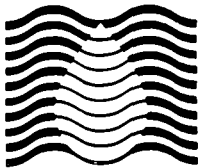

# **AL KAWTHER**

## **Ind. Ltd**

### **THE WATER/WASTEWATER ENGINEERS**

Al Kawther provides a wide range of consultancy, design and Operation & Maintenance services as well as supplying:

- **Packaged water/wastewater treatment plants**
- **Filters and sterilizers**
- **Custom built water/wastewater treatment plants**

**Factory and Main Branch**  
Jeddah 21472  
P.O. Box 7771  
Tel: (2) 6360644  
Tlx: 602907 KAWTHR SJ  
Fax: (2) 6374337

**Riyadh Branch**  
Riyadh 11495  
P.O. Box 2220  
Tel: (1) 4766715  
Tlx: 404955 KAWTHR SJ  
Fax: (1) 4787652

**Al-Khobar Branch**  
Al-Khobar 31952  
P.O. Box 20362  
Tel: (3) 8953577  
Tlx: 872078 KAWTHR SJ  
Fax: (3) 8953085

**International Offices (Tel.)**  
Cairo 3483427  
Bahrain 245109  
Sana'a 206842  
Kuwait 4733944  
Oman 562477

## DESALINATION AND WATER SOFTENING

Hillsborough Rd Durham NC 27705 USA Tel: +1-919-383-9421, Contact: Mr Jim Berry. Filtration, reverse osmosis, ultra filtration, ultra violet purification, deionization and ion exchange resins for laboratories and critical industrial applications.

**DSS ENGINEERS INC** 150 South Pine Island Rd Plantation Florida USA Tel: +1-305-476-1800, Telex: 212710, Fax: +1-305-476-1850, Contact: Mr Morin. Furnish engineering services for all types of desalination processes, mostly thermal and membrane types.

**E I DU PONT DE NEMOURS & CO INC** Room N-2522-2, 1007 Market St Wilmington DE 19898 USA Tel: +1-302-774-1000, Telex: 835420 AA, Fax: +1-302-774-9560, Contact: Mr D H Andriadas. Permasep permeators for water desalination and chemicals for water treatment.

**DUKTRAD INTERNATIONAL PVBA** Am-bachtanlaan 32 Louvre 3030 Belgium Tel: +32-1620-5224, Fax: +32-1620-5254, Contact: Derek Canass. The European sales office of Ameplast filament wound pressure vessels for softening, deionization or filtration plants. The tank range goes from 24" up to 55" and comes with a complete program of tailor-made accessories.

**ELGIN WATER CONDITIONERS INC** 1640 N Lafox South Elgin IL 60177 USA Tel: +1-312-741-8777. Supplies water softener systems for residential, commercial and industrial applications. Service capabilities include industrial rebuilding and systems automation. (WT)

**ENVIROGARD PRODUCTS LTD** P O Box 64, 301 Major Mackenzie Drive Richmond Hill Ontario L4C 4X9 Canada Tel: +1-416-884-9388, Telex: 06986766, Fax: +1-416-884-8296, Contact: Scott McDonald. Manufacturer of in-line water filter and sterilizers for domestic or commercial application. Units employ disposable or clearable/reusable cartridge.

**ENVIROGENICS SYSTEMS COMPANY** 9255 Telstar Avenue El-Monte California 91731 USA Tel: +1-818-573-9220, Telex: WU1698706, Fax: +1-818-572-8272, Contact: Herman Narea. Envirogenics Systems Company is a world leader of water systems with over sixty years experience in design and construction of water processing throughout the world. Currently more than 190 plants in 23 countries are either in operation or under construction. These plants have a capacity of more than 190 million GPD of desalted water. These installations include reverse osmosis systems, multi stage flash desalination plants and vertical tube evaporators all utilizing Envirogenics Systems technology.

**ENVIRONMENTAL PRODUCTS** 2131 S Tamiami Trail Venice FL 34293 USA Tel: +1-813-493-0301. An original equipment manufacturer of complete reverse osmosis units and components. (WT)

**ERIE MANUFACTURING CO** 4000 S 13th St Milwaukee WI 53221 USA Tel: +1-414-483-0524, Telex: 2-6867, Fax: +1-414-483-6610, Contact: Lee Veischer. Manufacturers of automatic water softener and filters control valves. These valves are available with electro/mechanical and electronic timers.

**ERMCO INC** 1570 Fairview Avenue St Louis MO 63132 USA Tel: +1-314-423-7711, Fax: +1-314-421-5904, Contact: John Kislign. Manufacturers of commercial, industrial water conditioning equipment. Industrial water softeners, pressure filter, dealtalizers and special tanks.

**ESMIL ENGINEERING & CONTRACTING** P O Box 7811 Amsterdam 1008AA The Netherlands Tel: +31-20-5411-054, Telex: 10295, Fax: +31-20-4444-36, Contact: Mr Tielrooy. Esmil designs and supplies equipment for desalination of sea-and brackish water, acts as buying agent for any equipment and spares and gives technical courses in our training centre.

**EXCALIBUR EXTRUSIONS INC** 110 E Crowther Avenue Placentia CA 92670 USA Tel: +1-714-528-8834, Fax: +1-714-524-7453, Contact: Glen Baldwin. Water tubes for desalination and reverse osmosis. Materials include PVC, CPVC, ABS, styrene and NORYL. Brinewells, wye strainers, plastic pipe, nipples and fittings. Materials include PVC, CPVC, polypropylene and polyethylene.

**FABRICA TURBINE E CALDAIE** FTC Legnano SRL, Piazza Monumento 12, Legnan, (Milan) 20025, Italy Tel: +0331522111, Telex: +330661/314385 F TOSI, Fax: +0331593321. Fabbrica Turbine E Caldaie - FTC Legnano SRL (Franco Tosi Group) represents a wealth of know-how and experience in the fields of generation, conversion, utilisation and recovery of energy in its various forms, as well as in other areas such as sea water desalination, ship propulsion and in general industrial plants, where equipment produced by the company finds a field of application.

**FILMTEC CORPORATION** 7200 Ohms Lane Minneapolis MN 55435 USA. Manufactures thin-film composite RO membranes for use in home tap water purification, desalination and industrial water purification.

**FLECK CONTROLS** 20580 Enterprise Avenue Brookfield WI 53005 USA Tel: +1-414-784-4490. Manufacture water softener components.

**FLOWMATIC SYSTEMS INC** 9470 Ulmerton Rd #4B Largo FL 34641 USA Tel: +1-813-586-2656. Manufactures and sells to OEM's in the RO industry, including automatic shut-off valves, check valves, flow restrictors, membrane housings, in-line filter housings and carbon filters. (WT)

**FLUID SEPARATIONS CORP** 14090 Horizon Boulevard El Paso TX 79927 USA Tel: +1-915-852-1007, Contact: Sal Reutena. Manufactures commercial and industrial water treatment systems including reverse osmosis, ultrafiltration, separate bed DI, mixed bed DI and nitrogen blanket systems.

**GREAT LAKES INTERNATIONAL** 1905 Kearney Avenue Racine WI 53403 USA Tel: +1-414-634-2386, Telex: 262043, Fax: +1-414-634-6259, Contact: Anne Mulready. Full line supplier and manufacturer of RO systems, water chillers, inline filterS and water processing systems. Also manufacture and market complete line of plastic components, tubing, pipe and other related accessories.



## DESALINATION AND WATER SOFTENING

**GREAT LAKES SOFT WATER CO** 3501 Dixon St Stevens Point WI 54481 USA Tel: +1-715-344-9272. Water conditioning equipment for homes and businesses.

**GREAT WESTERN PRODUCTS** 16591 Milliken Avenue Irvine CA 92714 USA Tel: +1-714-863-9077. Manufacturer of airgaps for both inline and standpipes for installation of automatic water softeners. (WT)

**GRUNDFOS INTERNATIONAL A/S** P D Jensensvej 7 Bjerringbro 8850 Denmark Tel: +45-6-68-14-00, Telex: 60731 gfos dk, Fax: +45-6-68-44-72. Grundfos all stainless steel booster modules (with energy saving turbines as optional) for high pressure applications in e.g. reverse osmosis plants. Pressure up to 70 bars. Flow rates to 100 cbm/h.

**HAGER & ELSASSER GMBH** P O B 800540 Stuttgart 80 7000 West Germany Tel: +49-711-7866-0, Fax: +49-711-7866-202, Contact: Mr Rau. Water treatment plants for treatment of fresh water (sea and bralish-water, ultra-pure water for electronical and pharmaceutical industry, boiler feed water) and waste-water (metal-working industry, textile industry, power plants and sewage water).

**HALCO PRODUCTS** 100 N Gordon Elk Grove I L 60007-1193 USA Tel: +1-312-956-1600. Manufacture under-sink RO units as well as design and build total package ultrapure water systems. Total package RO units and UF for special applications available.

**HELLENBRAND WATER CONDITIONERS INC** PO Box 187, 509 W Main Waunakee WI 53597-1197 USA Tel: +1-608-849-5717. Manufactures and distributes residential and commercial water conditioners including softeners, iron filters, sediment filters, taste and odor filters and pH neutralizing filters. (WT)

**HERO REVERSE OSMOSIS SYSTEMS INC** 3112 45th St West Palm Beach FL 33402 USA Tel: +1-305-683-0100. Manufacture of RO systems for home, business and industry.

**HESONWERK** Pettenbacher Strasse 66 Vorchdor A-4655 Austria Tel: +43-7614/8301, Telex: 24466 heson a. Apart from turning out various steel and plastic articles Hesonwerk specialize in the planning, production and installation of water treatment and waste water purification and recycling plants.

**HILMAR BECKER GESELLSCHAFT mbH & CO KG** A-4020 Linz Franzosenhausweg 50 Austria Tel: +43-732/83-0-01-0, Telex: 021507 becker a. The sphere of operations of Hilmar Becker comprises the production, servicing and sale of water treatment plants and heating, ventilating and air conditioning equipment. The HB production shops turn out filtering, de-ironing, decacidifying and softening plants, and plants for partial and full desalination and for reverse osmosis.

**HOME REVERSE OSMOSIS SYSTEMS** 380 N 35th Rd LaSalle IL 61301 USA Tel: +1-815-224-2450. Manufacturing, assembling and wholesaling reverse osmosis drinking water systems for home. Wholesaling of component parts for RO equipment.

**THE HOTSY COPR** 21 Inverness Way E Englewood CO 80112 USA. Manufactures 15 models of corrosion resistant pumps for use in reverse osmosis systems. One-15 gpm, up to 3000 psi. Pumps available in pulley belt or direct drive configurations. (WT)

**HUNGERFORD AND TERRY INC** P O Box 45 Clayton NJ 08312 USA Tel: +1-609-881-3200, Telex: 510-686-6580, Fax: +1-609-881-6859, Contact: Ken Sayell. Manufacturer of water treatment equipment for commercial and industrial applications including pressure filters, softeners, ion remove filters and special application ion exchange.

**HYDRANAUTICS** P O Box 3690 Santa Barbara CA 93130 USA Tel: +1-805-964-0765. Manufacturer of RO systems and elements.

**HYDRO-FLOW FILTRATION SYSTEMS INC** 4085 E La Palma Avenue, Unit F Anaheim CA 92807 USA. Manufacturer of disposable inline carbon filters and phosphate feeders for use in RO filtration, beverage dispensers and ice machines. (WT)

**HYDROTECHNIK GmbH** P O Box 14 Salzburg A-5033 Austria Tel: +43-662-224-720/285310, Telex: 633-821, Contact: Miss Imza. HYDROTECHNIK AUSTRIA have come to hold a worldwide leading position in the field of desalination beside its other activities in the area of water treatment. HYDROCOMPACT HC-RO Reverse Osmosis Plants can economically provide portable water in quantities from 0,3 m<sup>3</sup>/hr up to 60 m<sup>3</sup>/hr as single unit using brackish or seawater. If larger capacities are required, several units could be operated in parallel or alternatively a conventional type Reverse-Osmosis-plant may be installed. Depending on the capacity, HC-RO-Systems are available either as skid mounted or containerised version. By means of a computer program, the optimum operating conditions can be selected. These plants require very little energy. One of many advantages of the HC-RO plants is the minimal installation period as these systems are prefabricated and tested on leakfree operation in Austria before delivery.

**HYDROTECHNOLOGY INC** 24844 Anza Drive Valencia CA 91355 USA Tel: +1-805-257-1777. Manufactures Hydropure® residential reverse osmosis drinking water appliances. A truly unique design aimed at longevity, serviceability and user satisfaction. (WT)

**IMB Mathias-Brüggen** Strasse 17 Cologne 30 Bikendorf D-5000 West Germany Tel: +49-221-58-8040, Fax: +49-221-588-0488. Water treatment systems from raw water filtration up to highly sophisticated systems for micro and ultra-filtration, reverse osmosis plants, desalination and decarbonisation by ion-exchange technologies.

**IMI PLC** P O Box 216, Witton Birmingham B6 7BA UK Tel: +44-21-356-4848, Telex: 336771 IMIKYN, Fax: +44-21-356-3526, Contact: Liz Wood. A decentralised organisation, internationally known in five main product areas - building products, fluid control, special engineering, drinks dispensers and refined and wrought metal. Suppliers of titanium and copper tubing to desalination plants.

# Hydrocompact – Now Computer-Controlled

The water supply situation in the Arab region varies from country to country – some areas can draw on river water, others are dependent on ground water reserves or even have to treat sea water.

Hydrotechnik never fails to solve the problem of drinking water treatment.

After more than 20 years experience in the field of water treatment, clarification and desalination technology, Hydrotechnik Ges.m.b.H., Salzburg, has come to hold a leading position in the international market.

Well-known all over the world, the Austrian company offers a range of products ideally suited for countries suffering from a scarcity of water.

Far from becoming complacent, however, Hydrotechnik is continually developing new solutions for problems associated with its three main fields of activity – Water Purification, Water Treatment and Desalination, either by combining carefully planned design with special equipment, or by using their Compact Water Treatment Plants.

After making detailed market investigations, Hydrotechnik established a specialised department for the design and manufacture of these Compact Water Treatment Plants which are sold under the brand name of Hydrocompact.

These prefabricated units are complete water treatment and desalination plants for the production of drinking water. Manufactured to standards of perfection in Austria, from components delivered only by companies of international reputation, the plants are carefully tested by skilled workers at every stage of assembly.

The first export order for a large-scale project in Iraq in 1972 proved to be a milestone in the Hydrotechnik success story. The planning, delivery and installation of two drinking water treatment plants in Iraq, completed in a record time of 14 months, and the delivery of 40 Hydrocompact units to the Water Works of Baghdad followed soon. Continuing its successful development, the company also secured an order for 100 compact drinking water treatment plants for Egypt as well as several projects in Saudi Arabia.

Hydrotechnik was again at the focus of

attention, when the Kuwaiti Minister of Electricity and Water Supply, Dr. Homoid Al Rqobah, opened the second and third units of a seawater desalination plant in June 1988. Each of these units supplies 250,000 gallons of drinking water a day. The first unit had been opened in Juvenile after no more than four months of construction time, the second and third units supply water to the Sabah and Sina Hospitals.

In all, Hydrotechnik delivered 13 mobile, containerized units for the supply of  $13 \times 1.1$  million litres of drinking water from brackish water. The total order volume amounts to approximately AS 75 million.

On the occasion of the ceremonial opening of the plant, representatives of Kuwaiti authorities again referred to the short construction time and the versatility of the mobile units. The containerized Hydrocompact desalination plants work on the basis of the reverse osmosis principle. They incorporate Austrian know-how and are manufactured entirely in Austria. Hydrotechnik specialists are available to install the units anywhere in record time.

Water purification, water treatment and desalination – Hydrotechnik is continuously at work to develop new solutions in its three main fields of activity, either in the form of conventional systems or in the form of compact plants. The most recent version of Hydrocompact, which incorporates experience and know-how gained over the years, is computer-controlled and can be equipped with an “energy recovery system”, which is another interesting innovation.

Hydrotechnik plants are not only good looking, but they also guarantee reliable operation, as well as quick and easy installation anywhere in the world, for instance in North Africa and the Arab Gulf states, where many of these plants have already been delivered. They are producing continuously drinking water for thousands of people.

In order to remain in regular contact with its customers, Hydrotechnik has set up worldwide agencies. Branch offices with a staff of qualified experts operate in Cairo, Baghdad, Istanbul, Bangkok, Las Palmas and Kuwait.

HYDROTECHNIK GES.M.B.H.  
P.O. BOX 14  
A-5033 SALZBURG AUSTRIA

  
**HYDROTECHNIK**  
AUSTRIA

PHONE (662) 28 5 31-0  
TELEX 633821 HYDR A  
TELEFAX (662) 28 5 31-10



With a production range based on 20 years of fruitful research and development, Hydrotechnik has become leading specialist in the field of water treatment and desalination technology. Apart from work on major conventional treatment plants erected (inter alia in the Middle East), Hydrotechnik has developed HYDROCOMPACT® water treatment fully containerized prefabricated mobile system, including the delivery and start-up service and thus ideal for water supply in urban, rural, industrial and remote areas.



Delivery programme:

- water treatment plants for communities and industries
- Reverse Osmosis desalination plants for brackish and seawater
- waste water treatment plants for industries and municipalities
- HYDROCOMPACT® - containerized package water treatment, sewage treatment and Reverse Osmosis desalination plants
- waste heat recovery systems, e. g. in pulp and paper mills
- membrane systems for water reuse and recovery of valuable substances

*„The Watermakers“*

## DESALINATION AND WATER SOFTENING

**ING HARTWIG KARRER GROSSBANLAGEN - UND APPARATEBAU** Gewerbestrasse 7 Uttendorf A-5261 Austria Tel: +43-7724-6292, Telex: 27468 karrer a. Karrer plan, produce, install and service: plants for the treatment of surface water (river and reservoir water) for drinking. Full desalination plants (reverse osmosis and/or ion exchange, for hospitals of dialysis quality). Fermentation gas plants for solid waste utilisation (agriculture, abattoirs etc) and waste water purification.

**INTERNATIONAL SALT CO** Abington Executive Park Clarks Summit PA 18411 USA Tel: +1-717-587-5131. Manufacture a full line of salt products for water softeners - home, farm and industrial use.

**INTERNATIONAL SEA EQUIPMENT** 13263 72nd Avenue Surrey BC V3W 25N Canada Tel: +1-604-594-8666, Contact: Ihab Rauf. Design and manufacture of water desalination plants up to 25,000 cum/day (6.6MG/day), using mainly R O technology, undertakes plant operation and management and offers a unique project financing package.

**IONICS INCORPORATED** 65 Grove St Watertown MA 02172 USA Tel: +1-617-926-2500, Telex: 922403, Fax: +1-617-926-4304, Contact: Mr Vanwely. Total capability company operating in all fields of water and waste. Specialists in desalination of brackish and sea-water, primarily using membrane processors such as EDR and RO. All regular water treatment facilities.

**IPG PLANUNG UND INDUSTRIELLE PRODUKTION VON ELEKTRO - UND KÜTETECHNISCHEN** Feuerwerksanstalt 584 Wiener Neustadt Postfach 65 A-2700 Austria Tel: +43-2622/53-95, Telex: 16505 ipg a. Today there is no longer any need to choose between a tubular and plate heat exchanger for the best solution to a particular problem. The IPG Hybrid Heat Exchanger combines both methods in an ideal way. The heat exchanger parts are resistant to extreme temperatures (-200 degrees to 1,200 degrees C) and to pressures of 80 bar. Their application ranges from plant construction in general to salt water desalination plants in particular.

**JAY TECHNICAL SERVICES** 85 Gloucester Rd Croydon Surrey CR0 2DN UK Tel: +44-1-689-6755, Telex: 934715, Fax: +44-1-689-8158, Contact: Susan Jones. Manufacturers and design consultants of water treatment plant, including base exchange softeners, demineralisation and dealkalisation plant - supply, delivery and installation.

**JENCONS (SCIENTIFIC) LTD** Cherrycourt Way, Industrial Estate, Stanbridge Rd Leighton Buzzard Beds LU7 8UA UK Tel: +44-525-372010, Telex: 82164, Fax: +44-525-379547, Contact: Mr Beeson. For customers in laboratories requiring distilled water Jencons manufacture a range of 13 instruments giving a wide choice of units delivery between 3 and 8 litres per hour of high quality water, single or double distilled. An illustrated brochure in full colour is available on request. A 300 page catalogue covering a wide range of laboratory instruments is also available.

**K E WATERSOFTENERS LTD** 11 Oak Rd Harold

Wood Essex RM3 0PH UK Tel: +44-4023-42185/40562, Contact: Mr Hare. Manufacturers of watersofteners for base exchange. Suppliers of resins, pressure vessels, control valves and water meters. Facilities for installation of equipment. Salt suppliers.

**KELCO WATER ENGINEERING INC** 228 S Clark Drive, Ste 102 Tempe AZ 85281 USA Tel: +1-602-829-1115. Custom engineered commercial reverse osmosis systems ranging from 250 gpd to 2 million gpd. High recovery rate industrial reverse osmosis systems in single and double pass configurations. State-of-the-art computer assisted design systems engineer RO systems for longevity, optimum performance and specific ion rejection. (WT)

**KINETICO INC** 10845 Kinsman Rd Newbury OH 44065 USA Tel: +1-216-564-9111. Pioneer in manufacturing fully automatic, non electric, twin tank, demand water processing equipment. Offers systems for residential and commercial softening and for industrial softening, deionization and metals recovery. (WT)

**KING INDUSTRIES INT'L** 1961 McGaw Avenue Irvine CA 92714 USA Tel: +1-714-863-0713. Manufacturer of residential and commercial water conditioners, reverse osmosis systems and distributor of Royal Cleaning products. Line of soaps for use in soft water. (WT)

**KING LEE CHEMICAL CO.** PO Box 146, Del Mar, California, 92014, USA Tel: +619-6931358, Fax: +619-6931358. King Lee is world pioneer and leading supplier for performance chemicals used when processing water with Reverse Osmosis and prevent scale formation within process equipment. In addition highly effective cleaners are available for restoring equipment performance. All products offered are safe, effective and economical to use. DISTRIBUTOR INQUIRIES ARE WELCOME!

**KISCO BOILER & ENGINEERING CO** 303 W Marquette Avenue Oak Creek WI 53154 U S A Tel: +1-414-764-5700. Manufacturer of commercial and industrial softeners, filters, dealkalizers, condensate polishers, deionization equipment and steel pressure vessels. (WT)

**KISS INT'L** 520 S Andreasen Drive Escondido CA 92025 USA Tel: +1-619-480-4606. Manufacturer of a complete line of under the counter reverse osmosis systems. Product line consists of six different systems, as well as a complete commercial line. (WT)

**KRAFTANLAGEN HEIDELBERG** PO Box 103420 Britsplel 7 Heidelberg 1 D-6900 West Germany Tel: +49-6221-394-1, Telex: +0461-831. Revos, the mobile seawater desalination plant from Kraftanlagen, eliminates impurities normally found in seawater. The resulting potable water corresponds to the physical/chemical and hygienic parameters of the regulations and standards set by the World Health Organisation.

**KRUDICO INC** Highway 71 East Lake View IA 51450 USA Tel: +1-712-657-2628. Manufactures pellet chlorinators, dry pellet chlorinators, chlorine pellets, water softeners, iron filters, carbon filters and related products. (WT)

## DESALINATION AND WATER SOFTENING

**LABCONCO CORP** 8811 Prospect Kansas City MO 64132 USA Tel: +1-816-333-8811. The company's water purification systems create ultrapure water through reverse osmosis. Available in freestanding, undercounter and benchtop models, the units deliver RO treated water quickly and efficiently. (WT)

**LAYTON MFG** P O Box 4458 Santa Ana CA 92702 USA Tel: +1-714-953-6300. Manufactures portable exchange stainless steel units to customer specifications and stainless automatic softeners to customer specifications. (WT)

**MARINCO SRL** Via Crispi No 13 Bareggio Milan 20010 Italy Tel: +39-2-902-76451, Telex: 331554 SALAI, Fax: +39-2-902-7118, Contact: Carlo Cavicchi. Manufacturer of reverse osmosis desalinators for production of sweet drinking water from brackish water and sea water. Capacity from 20 gallons per day up to 100,000 gallons per day.

**MARLO INC** PO Box 4070, 2227 South St Racine WI 53404 USA Tel: +1-414-681-1300. Sodium zeolite softeners, dissolved solids reduction systems, hot zeolite systems, ion exchange resins, alkalinity reduction systems, filtration media, nitrate removal systems, conventional pressure filters, chemical feed pumps, condensate filters and polishers. (WT)

**MASTER WATER CONDITIONING CORP** 224 Shoemaker Rd Pottstown PA 19464 USA Tel: +1-215-323-8358, Fax: +1-215-323-5526, Contact: Mr Karl Christ. Manufacturers of water softeners, filters, deionizers, reverse osmosis systems and ultraviolet purifiers.

**MECHANICAL EQUIPMENT CO INC** 861 Carondelet St New Orleans LA 70130 USA Tel: +1-504-523-7271, Telex: 460165, Contact: Patsy Sezio. MECO is a leader in the engineering and manufacture of packaged water desalination equipment for land-based, marine, pharmaceutical, defense and offshore applications plus a variety of ancillary equipment such as heat exchangers, filters, pure steam generators, sample collectors etc.

**MECOLA MILIEUTECHNIEK BV** Corn Drebbeel Straat Wijchen BI 6603 The Netherlands Tel: +31-8894-12176, Telex: 48769, Fax: +31-8894-21451, Contact: Mr Jonge. Sewage water treatment equipment, reverse osmosis equipment, pyrolyses, piping erection and welding, dissolved air flotation and radiation shielding.

**MEDRO SYSTEMS INC** 416 E Industrial Boulevard McKinney TX 75069-7323 USA Tel: +1-214-542-8200. Manufactures RO systems and water purification equipment for medical, commercial and industrial markets.

**MEMBRANE PRODUCTS INC** 12791 Dean St Santa Ana CA 92708 USA Tel: +1-714-832-7049. Manufacturer of reverse osmosis membrane elements for use in residential and commercial water systems. Manufactures custom sizes of spiral wrapped membrane elements with both cellulose acetate blend reverse osmosis membrane or with the customer's reverse (WT)

**MID AMERICA WATER TREATMENT** 901 W Lake St Addison IL 60101 USA Tel: +1-312-289-6400, Contact: Robert Colluzzi. Water treatment components for

industrial, commercial and residential use, which includes all kinds of filters, reverse osmosis, drinking water, control valves and different types media.

**MISSION MEMBRANES** 1107 W Mission Avenue Escondido CA 92025 USA Tel: +1-416-562-4195. An operating division of Desalination Systems Inc, a widely recognized leader in the reverse osmosis water filtration field. No matter what kind of home or lab RO system the company can supply high quality, long-life cartridges to meet virtually any size (WT)

**MMD CH-4707** Deitingen Switzerland Tel: +41-65-431151, Fax: +41-65-44-32-03, Contact: Mr Keburz. Distributors for Desalination Systems Inc.

**MORTON SALT DIV MORTON-THIOKOL INC** 110 N Wacker Drive Chicago IL 60606 USA Tel: +1-312-807-2000. Producers of salt for water softening (residential, commercial, industrial and municipal). Manufacturers of resin cleaners.

**MULTI-PURE** 9200 Deering Avenue Chatsworth CA 91351 USA Tel: +1-805-252-0349. Manufacturer and supplier of activated carbon block filters.

**NATIONAL HYDRO INC** 1115 S 21st Avenue Phoenix AZ 85009 USA. Manufacture water softeners and filters.

**NEI THOMPSON LTD KENNICOTT** P O Box 100 Etingshall Wolverhampton West Midlands UK Tel: +44-902-353353, Fax: +44-902-403500, Contact: Mrs P M Grainger. Founded in 1902, Kennicott is a major UK based contractor of water treatment plant and gas generation systems. The company specialises in plant for the production of high purity water for boiler feed, process and potable applications and systems for the on-site generation of sodium hypochlorite and hydrogen.

**NIMBUS WATER SYSTEMS INC** PO Box 3263, 2316 Vineyard Avenue Escondido CA 92025 USA Tel: +1-619-743-3734. Manufactures a full line of drinking water systems including portable, under-the-counter, cooler conversion and light commercial, ranging from three-400 gpd. Also a leading supplier of spiral wound membranes and auxiliary RO components and equipment. (WT)

**OCEA PRODUCTS INC** PO Box 2159 Pascagoula MS 39567 USA Tel: +1-601-769-7150, Contact: Larry Iacobella. Manufacturer of residential and commercial RO systems. Subcontractor of custom RO systems for private labeling. Training of distributors for sales, service and installation. (WT)

**OSMO MEMBRANE SYSTEMS DIV OSMONICS INC** 5951 Clearwater Drive Minnetonka MN 55343 USA Tel: +1-612-933-2277. Reverse osmosis and ultrafiltration machines and replacement membrane elements for the most economical purification of tap water, well water and brackish water eliminate up to 97 per cent of dissolved salts. (WT)

**OSMOSIS TECHNOLOGY INC** 6925 Aragon Circle

## DESALINATION AND WATER SOFTENING

---

#24 Buena Park CA 90620 USA Tel: +1-714-670-9303, Telex: 499-8515, Fax: +1-714-670-9323. Manufacturer of reverse osmosis membranes and related products and residential and semi-commercial applications. Choice of blend or CTA membranes at competitive prices. (WT)

**PAYNE MANUFACTURING CO INC** 1900 Petra Lane Unit E Placentia CA 92670 USA Tel: +1-714-777-1093, Fax: +1-714-514-8780, Contact: Mr Tony Branson. Manufacturers of OEM reverse osmosis purification systems and all component parts.

**PCI OZONE CORP** 1 Fairfield Crescent West Caldwell NJ 07006 USA Tel: +1-201-575-7052, Telex: 244067, Fax: +1-201-575-8941. PCI Ozone Corp provides ozone systems for use in water and wastewater treatment, odor control and chemical processes. Ozone in the presence of polluting compounds reacts rapidly to form environmentally safe byproducts. This process is particularly effective as a treatment for both potable water and wastewater disinfection.

**PENFIELD LIQUID TREATMENT SYSTEMS** 8 West St Plantsville CT 06479 USA Tel: +1-203-621-9141, Fax: +1-203-621-2380, Contact: Mr Schultz. Manufacturers of filtration, softening, ion exchange, reverse osmosis and water filtration equipment.

**PERMASEP PRODUCTS** 50-52 Rte Dez Acacias Geneva 24 CH-1211 Switzerland Tel: +41-22-37-93-40, Fax: +41-22-379109, Contact: Tony Salt. "Permassep" permeators for reverse osmosis water desalination were introduced by Du Pont in 1969. Since that time, they have been used in thousands of installations in dozens of countries around the world for desalination of brackish water and seawater, and for treatment of waste effluents. Today, Du Pont offers the broadest line of reverse osmosis permeators available in the world. "Permassep" permeators come in four product types, according to the type of water to be treated.

**PFIZER INC** 235 East 42nd St New York NY 10017 USA Tel: +1-212-573-2531, Telex: 420440, Fax: +1-212-573-1166, Contact: Mr Roy Dickinson. Pfizer Inc markets "Flocon 100" the leading antiscalant for reverse osmosis systems as well as the "Floclean" family of RO cleaning compounds. Pfizer also provides water analysis services, membrane flow-testing and autopsy services. In addition, Pfizer offers a computer program to help designers and engineers determine optimum operating conditions and Flocon dosage.

**ING K THF6POÜRNER GESELLSCHAFT mbH** Hamburgerstrasse 9 Austria +43-222/56-16-41 Fax: 13-6864. Among the many services offered by Pürner in various plant construction sectors - chemical, petrochemical, energy supply, environmental technology, food processing, mechanical engineering etc. - plants for the treatment of water from desalination facilities occupy a special position. Pürner offer consulting, feasibility studies, site analysis, raw materials, labour and pilot plant analysis, licence and know-how transfer, basic and detailed planning, delivery, erection and technical assistance in plant operation.

**PREUSSAG ANLAGENBAU** PO Box 1320, Heinrich-

Hertz-Strasse 23 Hemmingen 1 D-3005 West Germany Tel: +49-511-4206-0, Telex: 923523, Fax: +49-511-4206-359.

**PURE WATER PRODUCTS INC** 1121 East Tonto Phoenix AZ 85034 USA Tel: +1-602-263-8899. Manufacture RO equipment for home and commercial applications.

**PURIFICATION PRODUCTS CO** 820 Los Vallecitos, Ste G San Marcos CA 92069 USA Tel: +1-619-471-2991, Telex: 251761, Fax: +1-619-471-2046, Contact: Mr O'Hair. Manufacturers of reverse osmosis, membrane element for point-of-use and point-of-entry water purification.

**PURITAN WATER CONDITIONING INC** 216 Lafayette Avenue Crawfordsville Ind 47933 USA Tel: +1-317-362-6340. Manufacture water softeners for use in the home and business.

**PURITE LTD** Unit E, Bandet Way, Thame Industrial Estate Thame Oxon OX9 3SJ UK Tel: +44-844-217141, Telex: 837561, Contact: Mr Lund. Manufacturers of reverse osmosis units, desalination and reverse osmosis units and cleaning chemicals, deionisation equipment, various filtration units and test kits.

**PURWATER INT'L CUNO INC** 3633 Pomona Boulevard Pomona CA 91768 USA Tel: +1-714-594-4433. Product line includes reverse osmosis membranes, through which water is forced to remove dissolved salts and chemical contaminants. (WT)

**RADIANT INDUSTRIES CORP** 1227 Rockaway Avenue Brooklyn NY 11236 USA Tel: +1-718-649-5577, Contact: Mr George Adams. Manufacture a complete line of water conditioning equipment for domestic and commercial applications.

**RBC WATER EQUIPMENT MANUFACTURERS PO** Box 16105, 4635 N Black Canyon Highway, Ste 206 Box 6 Phoenix AZ 85011 USA Tel: +1-602-242-8559. A full line manufacturer, assembler and distributor of water softeners, reverse osmosis, purification equipment, disinfection, filtration, water reuse, distillation and filtration equipment for residential and commercial systems. (WT)

**REGENERATION SYSTEMS P O** Box 388 Albion MI 49224 USA Tel: +1-517-629-2033. Design and build all types of equipment for regeneration of water softeners, filters and DI portable exchange tanks.

**ROHM AND HAAS FRANCE S A** La Tour de Lyon, 185 Rue de Bercy Paris Cedex 12 75579 France Tel: +33-1-40-02-54-00, Fax: +33-43-45-09-06, Contact: Jacky Victot. Ion exchange resins, ultrafiltration and reverse osmosis complement each other ideally in water treatment. The Amberlite, Imac and Duolite have long been recognised as the trade names of the pioneers in the ion exchange industry. Our experts continue to lead the field in customer satisfaction with quality products and knowledgeable technical service. Romicon, with its unique hollow fiber membranes, broaden the range of water processing available to Rohm and Haas for water purification.

# A COMPLETE RANGE OF USES TO SOLVE A COMPLETE RANGE OF PROBLEMS



**HOUSES** Initially designed for use in houses for which complete water treatment systems of this size have not previously been available at a low enough cost. **APARTMENTS** One Aquarius 150 should be able to provide sufficient pure, clean water for a block of 6-8 apartments.



**OFFICES** To protect workers and the business from the consequences of employees drinking water from a polluted source. **HOTELS** to provide safe, pure drinking water for guests is a worldwide problem for Hoteliers.



**HOSPITALS** for general use and sterile environments where ultrapure water is always needed. **BUSINESSES** Many industrial processes (laundries etc.) must have a continuous supply of clean water, food processing must have pure water.

## Small Versatile Portable

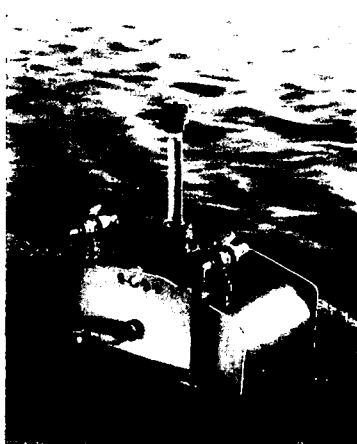

Practically anybody with a problem of dirty or impure water will have a use for the **AQUARIUS 150.**

**RELIEF WORKERS, EMERGENCY SITUATIONS** Famine relief, natural disasters, earthquakes, etc., all have the supply of pure, safe drinking water as a major problem

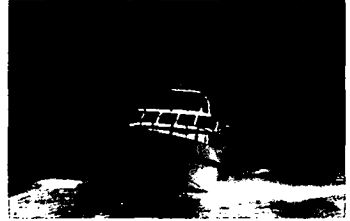

**BOATS** Inland waterway boats will be able to meet all their needs including drinking water from the water they sail in. **RAILWAYS** Can be used on trains for passenger drinking water, irrespective of the pick up source.



**DEVELOPING COUNTRIES** Village water supplies can be cleaned and purified by the AQUARIUS 150 thus eliminating at source most waterborn diseases. **MILITARY FORCES** on the move can now always be sure of the safety of drinking water, no matter where they are.



**RECYCLING** Water conservation, recycling waste water according to specification and source.

**WHATEVER YOUR WATER PURIFICATION PROBLEM  
THE AQUARIUS 150 IS THE ANSWER**



**AQUARIUS WATER PURIFICATION LTD.**

No.12 Craven Court, Winwick Quay, Warrington. WA2 8QU.  
Tel: 0925 445144 Fax: 0925 413524 Telex: AQUA 627151

## DESALINATION AND WATER SOFTENING

**RUSTRAP MFG CO** 111 Howard St E Edgerton MI 56128 USA Tel: +1-507-442-3451, Fax: +1-507-442-3775, Contact: Mr Roger Pool. Manufacturer of dual inline water filters, RV softeners and complete line of both commercial and residential water softeners.

**SALINE WATER CONVERSION CORPORATION (SWCC)** Prince Mohammed Bin Abdulaziz St P O Box 5968 Olaya Riyadh 11432 Saudi Arabia Tel: +966-1-463-1111, Telex: 400097 TAHLEA SJ, Fax: +966-1-463-1952. Saline Water Conversion Corporation is a government agency responsible for the desalination of seawater. It produces 572 mgd of water and 4079 mW of power from desalination and power plants located on red sea and Arabian Gulf coasts. Therefore a world leader in the field of desalination. There are six pipelines with a total length of 2274 kms supplying water to inland regions.

**SASAKURA ENGINEERING CO** 2 Grove House, Foundry Lane Horsham Sussex UK Tel: +44-403-50692, Telex: 87144. Manufacturers and suppliers of all types of desalination plants including multi-stage lash, thermo-compression, mechanical vapour compression.

**SAXTON MFG CO** 16782 Milliken Avenue Irvine CA 92714 USA Tel: +1-714-863-0606. Manufacturer of domestic and commercial water softeners and filters for the water conditioning industry. Manufacturer of a complete line of water softeners for hot water application. (WT)

**SEA RECOVERY CORP** PO Box 349 San Pedro CA 90733 USA Tel: +1-213-519-7801. Manufacturer of a complete line of reverse osmosis desalinators, from basic systems to turnkey operations. Ranges from 100 US gpd (. 38 M3) to 100,000 US gpd (380 M3). Systems available for virtually any use from sea water, brackish water or purified feed sources. (WT)

**SETEC** P O Box 90, Rouwkooplaan 14 Voorschoten 2251 AB The Netherlands Tel: +31-1717-4940, Telex: 39091, Fax: +31-1717-8180, Contact: Mr Schroeder. Design and supply water treatment systems and membrane separation treatment systems, (microfiltration, ultrafiltration, reverse osmosis, electro-dialysis, pervaporation and gas separation).

**SOBEA** P O Box 414, 62 Renen Nanterre 92004 France Tel: +33-1-47-24-22-66, Telex: +203978. Produce and install water treatment units for the purification of waste water by filtration.

**SPRINGSOFT INT'L INC** 2390 United Lane Elk Grove IL 60007 USA Contact: . Manufacturer of a complete line of residential and commercial water softeners. A complete line of filters, chemical feeders, distillers, reverse osmosis systems and deionization equipment is stocked for immediate delivery. (WT)

**STA-RITE INDUSTRIES** 1875 Dewey Avenue Benton Harbor MI 49022 USA Tel: +1-616-925-8812. Manufacture and assemble quality water softeners and filters for residential and commercial water treatment market.

**SUPERIOR WATER SYSTEMS INC** 13529 S Norman-

die Avenue Gardena CA 90249 USA Tel: +1-213-770-8920. Manufacturer of water softener and carbon filters, resin, RO units, tanks and valves.

**SYBRON CHEMICALS INC** PO Box 66, Birmingham Rd Birmingham NY 08011 USA Tel: +1-609-894-8211, Fax: +1-609-894-8641, Contact: Frank Duniono. Sybron Chemicals Inc manufactures and markets ion exchange resins under the Ionic brand name for water softening, demineralization and waste treatment, they also manufacture a complete line of biochem engineered bacteria for waste treatment.

**TAPROBE CO** P O Box 267 Wasco IL 60183-0267 USA Contact: . Manufacturer of RO product water checker (tester) for user to determine when to change module.

**TARI GESELLSCHAFT mbH** A-5280 Braunau/Inn Peter-Rosegger-Weg 12 Austria Tel: +43-7722/32-64, Telex: 027-75524. Tari GesmbH are engaged in water technology. Their products are used for water treatment, in particular drinking and service water from rivers, brackish and karst waters, for ultraviolet irradiation, reverse osmosis, full desalination and decarbonisation. For water treatment the firm produces ozonizing equipment. Tari undertake the planning, production and installation of various facilities, including small and large size swimming-pool systems using mechanical and chemical water treatment.

**U-MARC INC** 1017 Dover Court Libertyville IL 60048 USA Tel: +1-312-680-3687. Manufacture reverse osmosis equipment.

**UNION PUMP CO** 4600 W Dickman Rd Battle Creek MI 49015 USA Tel: +1-616-966-4600. Supplier of pumps for both brackish and saltwater RO applications.

**UOP FLUID SYSTEMS** 48 Leicester Square London WC2H 7LW UK Tel: +44-1-839-7022, Telex: 21506 UOP INT G, Fax: +44-1-930-6412, Contact: Mr Michael Stefanic. Spiral wound, reverse osmosis membrane elements and pressure vessels. Applications include desalination, wastewater treatment, ultrapure water production.

**UOP FLUID SYSTEMS** 10054 Old Grove Rd San Diego CA 92131 USA Tel: +1-619-695-3840, Telex: 188906, Fax: +1-619-695-2176, Contact: Mr Randy Truby. Spiral wound, reverse osmosis membrane elements and pressure vessels. Applications include desalination, wastewater treatment and ultrapure water production.

**VOEST ALPINE MONTAGE GESELLSCHAFT mbH** Dieselstrasse 2 Wels A-4600 Austria Tel: +43-7242/81-7-51, Telex: 02-5512. Voest Alpine Montage GesmbH, an affiliate of Voest Alpine AG, Linz, specialize among other things in water treatment plants, embracing filtering and softening plants, plants for part and full desalination, cooling and drinking water conditioning plants, seawater desalination plants (applying the VAM multi-effect process) and water supply projects using large-capacity tankers.

**WAB WASTE AND WATER TREATMENT** Leberstrabe 118a, A-1110 Vienna, Austria Tel: +02227435600,



# West Germany / Interface

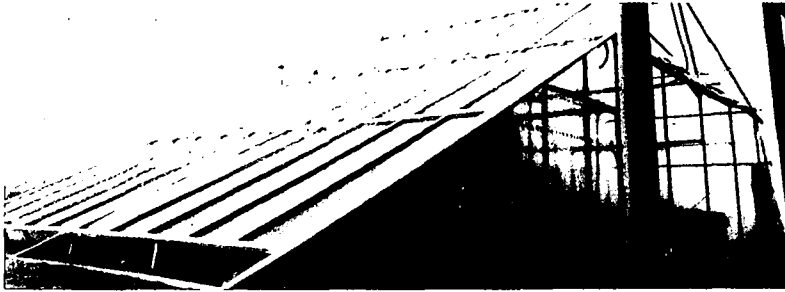

## Solar still adopts ancient salt production art

A 200-year-old thorn bush provides the heart of a new prototype solar still desalinator now on trial in West Germany and shortly to be replicated in the Sfax/Tunisia.

Thornbushes were used for salt production in the Middle Ages and have been 'rediscovered' by Aquasolar GmbH, a company on the outskirts of Hannover, better known for its solar absorbers and water heaters.

The Aquasolar SME technology involved in the stills is very simple, with the only energy-consuming device a small pump to take the feed water to the roof of the structure

for heating before it falls through an evaporation chamber. Designer Walter Gräf says that the thermal energy consumption can be as little as 0.233kWh for one litre of water.

The solar multiple condensation evaporation cycle, where 'multiple effect' refers to the number of condensations possible with a certain energy input, works at atmospheric pressure using air as the transport system. Two types of system are possible — one with a closed air cycle and one with a closed water cycle.

In the first system, the raw salt water is preheated in a condenser, taking heat from a

closed cycle of humid air and simultaneously causing the moisture in the air to condense and form the distillate. The water is then pumped under solar flat plate collectors in the structure's roof, where it is heated to 75°C.

From here, part of the flow goes to feed a heat storage vessel, which is used to heat the air flow during the night, if 24-hour operation is required, while part is fed in drip form through the top of a cooling tower or evaporation chamber. Natural convection leads an upward airflow through this chamber, which helps to evaporate the falling hot water.

This state is where the thorn trees come in — providing a large surface on which to trap the drops and also causing drops to break into spray. This increase of surface area also improves evaporation. The calcium sulphate, gypsum and other deposits remain on the leaves as the water evaporates.

The heated air then carries the evaporated water to the sea-water-cooled condenser, from which it is piped away as product water. Brine falling to the bottom of the chamber is removed as waste.

At 75°C, the air in circulation contains 0.39kg of water for every kg of air; at 30°C, this proportion has been reduced to 0.028kg/kg air. The advantage of this installation, says Aquasolar, is that lowering of temperature is best used directly by the sea.

The closed-water circulation system has a continuous flow of cold outside air coming into it, which is heated and loaded with moisture as it passes upwards through the falling hot water in the evaporator chamber.

After condensation, the 0.03kg of water remaining in each kg of air is given off to the

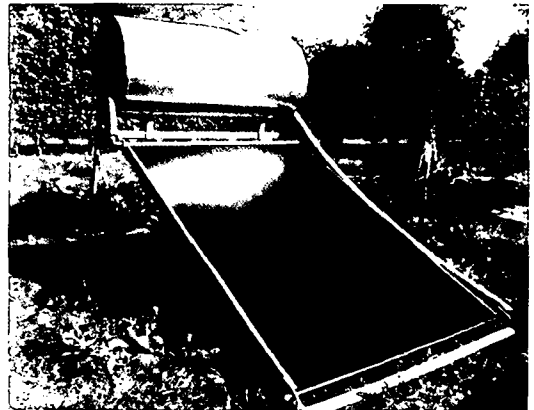
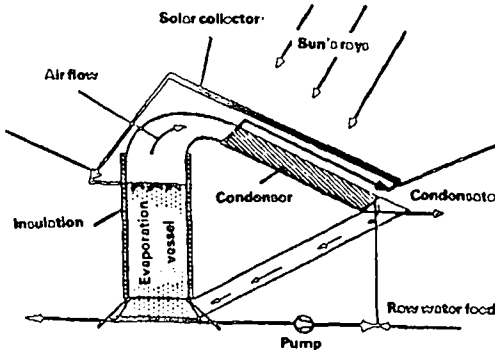

Soladur - Waterheating System for southern countries, with horizontal 100 l tank, swimming pool collectors  
 - solar heating system for domestic use  
 - solar desalination of sea or brackish water

surrounding area. If this area can be constructed as a greenhouse, it will keep the greenhouse irrigated and, when the temperature falls further at night, the water will condense on the greenhouse windows providing additional source of distillation.

The incoming cold air also provides a cooling source for the circulating water before it re-enters the condenser.

One item of maintenance in the Aquasolar SME plant is a two-yearly thrashing of the thorn bushes to remove the

incrusted carbonates and gypsum. The bushes can be reused in this way about five times, says Walter Gräf.

Aquasolar also produces a more conventional solar still, the SIM plant, where the water is evaporated directly by the heat of the Sun and cooled by a condenser through which the incoming sea water is pumped. A portable plant, SIP-12, is also available, which works off static water pressure and requires no pump.

## aquasolar

The cheapest way to produce fresh water from the sea

PO. BOX 110 112 · D-3014 LAATZEN



## Wülfing und Hauck

Kunststoffverarbeitung

Ernst-Abbe-Strasse 2

Tel: 05605 2044

Fax: (05605) 7131 Telex: 99685

## DESALINATION AND WATER SOFTENING

Telex: +132291, Fax: +022274356032. Desalination and Water softening, Disinfection, Municipal water treatment, Package and Portable water treatment, Mechanical and Biological waste water treatment, Sludge treatment and dewatering, General equipment and process, Specialised equipment and processes.

**WATER CONDITIONING CANADA LTD** 580 Park St Regina Saskatchewan S4N 5A9 Canada Tel: +1-306-545-6990, Telex: 071-2718. The manufacture and distribution of residential, commercial and industrial water treatment equipment. Water softening, iron and sediment filtration, reverse osmosis and distillation as well as purification products.

**WATER EQUIPMENT TECHNOLOGIES INC** 832 Pike Rd W Palm Beach FL 33411 USA Tel: +1-407-684-6300, Contact: George T Karmbis. Manufacturers of water filtration and reverse osmosis products from 12 gallons to 250,000 gallons per day.

**WATER FACTORY SYSTEMS** 345 McCormick Avenue Costa Mesa CA 92626 USA Tel: +1-714-544-1722. Manufactures an extensive line of residential, office, commercial and industrial reverse osmosis systems. Drinking water appliances include the latest technological innovations combined with rigid quality control, factory testing and medical sanitizing of each system.

**WATER MAINTENANCE SERVICES INC** 8 South 335 Madison St Willowbrook IL 60521 USA Tel: +1-312-654-8675. Water treatment system and services. Specializing in cooling tower and boiler treatment, reverse osmosis, demineralization, full laboratory.

**WATER RESOURCES INT'L** 2310 W Sherman St Phoenix AZ 85009 USA Tel: +1-602-268-2580. Manufacturer of a complete line of residential and commercial water conditioning equipment, reverse osmosis and all other filtering systems. Has complete line of soap products for soft water. Sales and marketing support available. (WT)

**WATERMAKERS INC** 1927 S Federal Highway Ft Lauderdale FL 33316 USA Tel: +1-305-467-8920. Provide high quality ro machine.

**WEIR WESTGARTH LTD** 80 Peach St Wokingham Berkshire RG11 1XH UK Tel: +44-734-792201, Telex: 849971, Fax: +44-734-775276, Contact: Mr John Colburn. Weir has a range of desalination plants capable of producing water for drinking and industrial use from sea or brackish water supplies. Packaged thermal compression distillers and reverse osmosis plants are available up to 3000 m<sup>3</sup>/day with multistage flash distillers and engineered RO plants capable of satisfying municipal water requirements.

**WESTERN ENVIRONMENTAL MGT** PO Box 1807 Carlsbad NM 88220 USA Tel: +1-505-885-5709. An industrial water treatment company that custom blends chemical products designed to ensure maximum scale and corrosion inhibition is maintained within boiler and cooling water systems. The programs established have proven to reduce scale accumulations (WT)

**WESTLAND WATER SYSTEMS INC** 1900 Petra Lane, Unit E Placentia CA 92670 USA Tel: +1-714-993-2524. Manufacturer of reverse osmosis water treatment systems and component parts for residential and commercial use. (WT)

**WETCO INC** 2661 Western St Las Vegas NV 89109 USA Tel: +1-702-735-6902. Manufacture reverse osmosis equipment for home drinking water systems. Cast-in-place triacetate membranes need no drain or pre-filter. Handles chlorinated or non-chlorinated water, resistant to bacteria and high pH.

**WM R HAGUE INC** 4343 S Hamilton Rd Groveport OH 43125 USA Tel: +1-614-836-2195. Manufacturers of water conditioners, filters, reverse osmosis systems.

**WOOD BROTHERS IND INC** PO Box 4426, 4021 N 48 St Lincoln NE 68504 USA Tel: +1-402-467-1236, Contact: Edward Wood. A range of water softening products for both commercial and domestic applications. Iron filters, carbon filters, reverse osmosis equipment etc also available.

**XENTEX INC** 14902 W 117th St Olathe KS 66062 USA Tel: +1-913-764-3800, Fax: +1-913-764-1743. Supplier to capital construction projects, water stills for hospitals and laboratories, water demineralizers and water softeners. Equipment for wastewater projects such as liquid solid separators, filtration equipment, water recycle equipment, pond and pit plastic liners etc.

### Disinfection

**A R SYSTEMS INC** 111 Terminal St Hopewell VA 23860 USA Tel: +1-804-541-8802. Manufacturers and distributes all types and sizes of RO systems, water softeners, iron removers and charcoal filters. (WT)

**ACTINI-FRANCE** PO Box 80 Thonon 74202 France Tel: +33-50711-800, Telex: 385615, Fax: +33-50718682, Contact: Mr Patrick de Stoutz. Manufacturers of equipment for water sterilisation by ultra-violet rays. Complete range of water treatment equipment and filters.

**ALANTIC ULTRAVIOLET CORP** 250 North Fehr Way Bay Shore NY 11706 USA Tel: +1-516-586-5900, Telex: 645158, Fax: +1-516-595-2609, Contact: Anne Wysokki. Manufacturer of ultraviolet water purifiers and ultraviolet/germicidal lamps.

**AMERICAN OZONE (A SUBSIDIARY OF VECTOR CORP)** 675 44th St Marion IA 52302 USA Tel: +1-319-377-8263, Telex: 9105251630, Fax: +1-319-377-5574, Contact: Mr Jerry Zahratinia. Manufacturer of ozone-based water treatment systems and corona discharge. Ozone generators for point of use/point of entry applications.

**AMERICAN ULTRAVIOLET CO** 271 Commerce st Chatham NJ 07054 USA Tel: +1-201-635-8355, Telex: 139266, Fax: +1-201-665-9523, Contact: Mr Stines. We manufacture germicidal ultraviolet water purifiers. Models are available from 1 gallon per minute.

## DISINFECTION

**APPLIED OZONE TECHNOLOGIES INC** 7900 Fruitville Rd Sarasota FL 34240 USA Tel: +1-813-694-1328/813-377-9097, Contact: H H Morgan Jnr. Manufacturers of ozone generating equipment, water purification equipment and chlorination equipment.

**AQUA SYSTEMS OF FLORIDA** 3302 Aviation Boulevard Vero Beach FL 32960 USA Tel: +1-305-567-1120. Manufacturers & distributors of ozonegenerators and packaged P/C systems for problem water supplies. Fully automatic ozone and GAC systems are offered.

**AQUAFINE (UK) LTD** 20 Park St Princes Risborough Bucks HP17 9AH UK Tel: +44-844-46024, Telex: 837268, Fax: +44-844-2027, Contact: Mr Steinbock. Since its inception in 1949, Aquafine has become the world's leading manufacturer of ultraviolet sterilization equipment for liquids. Aquafine ultraviolet sterilizers provide bacteria-free water completely unchanged in pH, colour, taste, odour and temperature.

**AQUAFINE CORPORATION** 25230 West Avenue Stanford Valencia CA 91355 USA Tel: +1-805-257-4770, Telex: 651398, Fax: +1-805-257-2489. 1989 marks the 40th anniversary of Aquafine Corporation. Since its inception in 1949 Aquafine has devoted itself to manufacturing the highest quality ultraviolet disinfection equipment for fluids and backing that equipment with the finest level of personalized service imaginable. This devotion to quality of product and service has been a major factor in Aquafine's rise to the position of the world's leading manufacturer of ultraviolet disinfection equipment. Whether the need is for a compact UV

device for laboratory use, or a large custom-built system for disinfecting the potable water for an entire town, Aquafine is ready and able to fill the requirements. Aquafine UV disinfection equipment is available for almost any application from local distributors worldwide. To discuss your specific needs or to obtain the name of your nearest Aquafine representative, call, telex, fax or write Aquafine today.

**BERSON MILIEUTECHNIEK** P/O Box 90 De Huufkes 23 5674 TL Nuenen AB 5670 The Netherlands Tel: +31-40-85-29-19, Telex: 519111, Fax: +31-40-83-57-55. Berson Milieutechniek is specialised in the design and production of UV water sterilisers, UV air sterilisers, UV oxidation units, electrolytic chlorinators. The large UV water sterilisation programme comprises installations working with low-pressure UV lamps (small capacities) as well as high-pressure UV lamps (large capacities), in different versions for many types of liquids.

**BEST-WATER CONDITIONING INC** 3603 N Muskingum Avenue Odessa TX 79762 USA Tel: +1-915-366-5295. Manufactures and assembles reverse osmosis systems, a repressurization unit, post-carbon filtration and an ultraviolet disinfection unit built all-in-one on an open steel frame. The product water tank is also available to set next to the water equipment package. (WT)

**THE BOOTS COMPANY PLC** Nottingham NG2 3AA UK Tel: +44-602-592584/592891, Telex: +378431, Fax: +44-602-483889/506111. Boots MicroCheck have a specialist marketing team looking at active ingredients for



WATER IS LIFE

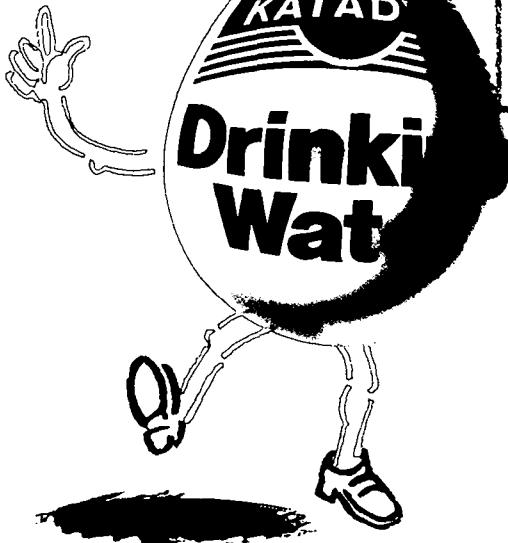

### **Katadyn Multus®**

Ultraviolet radiation

### **Katadyn®-Filter**

Microfiltration

### **Electro-Katadyn®**

Silver ion method

### **Micropur®**

Tablets, powder and liquid

### **Katadyn Products Inc. Water Purification**

Industriestrasse 27  
CH-8304 Wallisellen / Switzerland

Telephone 01/830 36 77  
Telex 826 267 kdyn ch  
Telefax 01/830 79 42

## DISINFECTION

disinfection. These are marketed to disinfectant formulators. Included in this range are dipslides for surface hygiene monitoring.

**CAPITAL CONTROLS CO INC** P O Box 211 Colmar PA 18915 USA Tel: +1-215-882-2901. Manufacturer and distributor of equipment and systems for water disinfection and analysis.

**CAPITAL CONTROLS LTD** Units 37+38, Sittingbourne Ind Park, Crown Quay Lane Sittingbourne Kent ME10 3JG UK Tel: +44-795-76241, Telex: 965636, Fax: +44-795-79052, Contact: Mr Martin. Equipment for chlorination and related processes for water treatment.

**CHEMCON INC** 36 Mann St South Attleboro MA 02703 USA Tel: +1-617-761-6300, Telex: 951402, Fax: +1-617-761-6304, Contact: Charles Wilson. Chemon manufactures a broad line of non-hydraulic and hydraulic diaphragm metering pumps, related automatic controls and accessories. Also offer complete systems, ei pH control, liquid chlorination systems, polymer preparation systems, etc.

**CHLORINATORS INC** 733 NE Dixie Highway Jensen Beach FL 34957 USA Tel: +1-407-334-8070, Telex: 350341, Fax: +1-407-334-7304, Contact: Joe Perz. Regal gas chlorinators have up to 60 percent fewer parts, reducing potential for problems and costly repairs commonly associated with more complex gas chlorinators. Feed rates up to 500 lbs/day (10kg/hr).

**CHRIST HOLLAND BV** Energieweg 5 Zoeterwoude NA NL-2382 The Netherlands Tel: +31-71-899218, Telex: 39443, Fax: +31-71-897429, Contact: Mr Reisbter. Christ Holland BV, develops and constructs water treatment systems for softening, demineralisation, desalination, ultra-filtration and ultra-pure water systems for industrial and potable purposes. Christ Holland BV, is a daughter-company of Christ AG, Aesch, Switzerland.

**CLEAN WATER SYSTEMS, DIV OF C G ROMARY AND SON INC** 4959 Dunman Avenue Woodland Hills CA 91364 USA Tel: +1-818-340-3020. Manufacturer of ultraviolet water treatment units/systems for industrial and consumer applications. Also manufactures and supplies electronics, including solid state ballasts and True UV sensing, monitor and control systems. (WT)

**CONTAMINATION CONTROL LTD** Box 14-621 Auckland New Zealand Tel: +64-9-579135, Fax: +64-9-5277654, Contact: S C Warne. Manufacturer and exporter of ultra-violet water sterilisers and other water treatment products.

**COTTEN INDUSTRIES** 275 Schoolheimer Rd Canastota New York 13032 USA Tel: +1-315-363-8084, Contact: Mr Jack Cotten. Manufacturers and suppliers of a complete line of water conditioners for softening, filtration, UV sterilisation. The company also produces reverse osmosis and demineralisation equipment.

**DDS FILTRATION** PO Box 149 Nakskov DK-4900 Denmark Tel: +45-53-92-27-99, Telex: 47558 ddsfil dk, Fax: +45-53-92-31-11. DDS Filtration develops, manufactures and markets membranes and turnkey reverse

osmosis plants. Both plate and frame as well as spiral wound systems are sold for a wide range of applications within the water treatment industry, especially DDS Filtration.

**DRACOR WATER SYSTEMS** P O Box 2993, 3643 Hillsborough Rd Durham NC 27705 USA Tel: +1-919-383-9421, Contact: Jim Berry. Filtration, reverse osmosis, ultra filtration, ultra violet purification, deionization and ion exchange resins for laboratories and critical industrial applications.

**EES CORP** 12850 Bournewood Drive, Sugarland, Texas, 77478, USA Tel: +1-713-240-6770, Telex: +795459, Fax: +1-713-240-6762. In addition to Aquaward<sup>®</sup> Systems to disinfect water using a one-piece chlorinator and 70 percent calcium hypochlorite, Aquaward<sup>®</sup> tablets, EES also offers Sanilec<sup>®</sup> Systems for larger disinfection requirements. Sanilec<sup>®</sup> Systems generate sodium hypochlorite from seawater or brine and electricity. Customised systems can be supplied and designed to meet specific needs or 'Pre-Engineered' units are available off-the-shelf. Sanilec<sup>®</sup> Systems are operating world-wide.

**ELECTRO CATALYTIC** Norman Way, Sevenbridge Industrial Estate, Portstewart Newport Gwent NP6 4YN UK Tel: +44-291-423833, Telex: 497870, Fax: +44-291-423836, Contact: Mr Doug Young. Electrochlorination equipment for water disinfection. Packaged systems producing from one gram per hour to 100 kilos per hour from quality salt and electricity.

**ENVIRO PURE MILIEU TECH** PO Box 66008 Den Haag GA 2506 The Netherlands Tel: +31-70-55-3615, Telex: 33168, Fax: +31-70-55-3563, Contact: Mr Van Dyke. Supply water sterilization equipment with ultra-violet units and manufacture complete potable water production sets from 500 litres per hour and upward. If required, a small generator is supplied for remote areas.

**GRIFFIN TECHNICS INC** Box 330 178 Route 46 Lodi NY 07644 USA Tel: +1-201-778-2131, Telex: 133411, Fax: +1-201-778-2357, Contact: G Lesznik. Manufactures and designs ozone-generating systems for potable water treatment, waste water disinfection and speciality chemical applications.

**HANOVIA DIV CANRAD INC** 100 Chestnut St Newark NJ 07105 USA Tel: +1-201-589-4300, Telex: 13-8531, Fax: +1-201-589-4430, Contact: Mr Tom Tavanion. Manufacturer of low, medium pressure lamps and their associated equipment for ultraviolet sterilizers and photochemical chlorination reactors.

**HANOVIA LTD** 145 Farnham Slough Berks SL1 4XB UK Tel: +44-753-31351, Telex: 848123, Fax: +44-753-825-206, Contact: Mr Warne. Manufactures of ultra-violet water disinfection systems suitable for domestic, industrial and municipal use. Systems to treat up to 100 mega litres per day are now available and in operation.

**HOÜLZLI KG** A-4863 Seewalchen am Attersee Ginzkeyweg 12 Austria Tel: +43-7662/22-03, Telex: 02656/122 hgse a. Houilzli KG specializes in the production of ultraviolet water sterilizing facilities for

# TOMORROW'S TECHNOLOGY FOR TODAY'S ENVIRONMENT

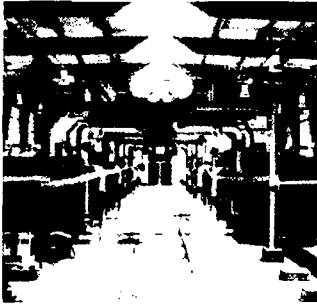

## **SANILEC® Systems-**

Customized equipment that generates sodium hypochlorite from seawater or brine, with applications in cooling water, wastewater and drinking water. The largest system produces the equivalent of 26 tons per day of chlorine as sodium hypochlorite.

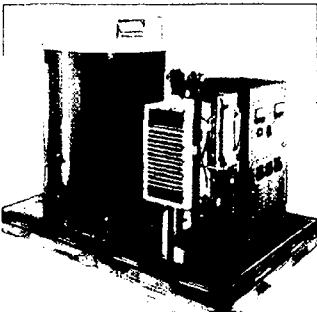

## **Pre-Engineered SANILEC®**

Standard "off-the-shelf" units to produce up to 60 (27Kg), 120 (54Kg), or 240 (108Kg) pounds per day of sodium hypochlorite from seawater, or 20 (9Kg) 50 (23Kg), or 100 (45Kg) pounds per day of sodium hypochlorite from salt (brine). The units are used for swimming pools, laundries, cooling water, wastewater and drinking water treatment.



## **AQUAWARD®/ SANURIL®**

Units designed to disinfect drinking water with AQUAWARD tablets of 70% hypochlorite or wastewater with tablets of SANURIL 115, a blend of 70% hypochlorite and 1, 3, 4 and 6 tetrachloroglycoluril (TCGU). The Model 200 tablet feeder is designed for processing up to 1500 gpd (6 cubic meters), Model 100 for up to 10,000 gpd (38 cubic meters) and Model 1000/1001 for up to 50,000 gpd (189 cubic meters). Units have been installed in parallel to treat higher flows.

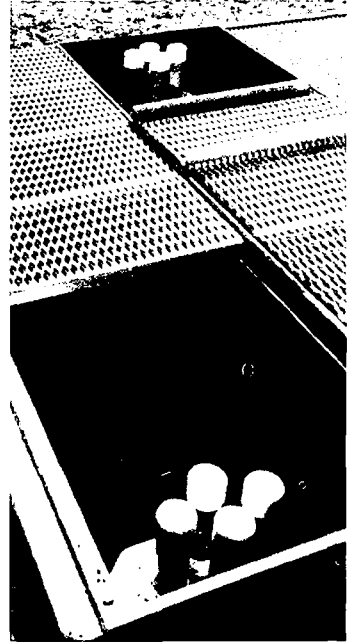

## **D-CHLOR™ Systems-**

The various tablet feeders can be used to dose D-CHLOR tablets to remove chlorine in cooling water or wastewater for flows up to 500,000 gpd (1890 cubic meters/day).

For more information, write for a FREE brochure or contact us for your nearest EES Corporation representative.

*Wastewater Treatment...  
Our problem not yours.*



## **EES Corporation**

A subsidiary of ELTECH Systems Corporation

12850 Bournewood Drive  
Sugar Land, Texas 77478  
(713) 240-6770  
Telex: 795459  
FAX: (713) 240-6762

## DISINFECTION

drinking and service water. Registered under the name Uvaudes®, they are constantly tested and improved with the assistance of Austrian hygiene institutes and bear the Austrian quality label and the quality mark of the Austrian Association for Hygiene, Microbiology and Preventive Medicine.

**HYDRO INSTRUMENTS INC** P O Box 615 Quakertown PA 18951 USA Tel: +1-215-538-1367, Telex: 6711643 Hydrouw, Contact: John Sealets. Hydro Instruments Inc manufactures the world's most rugged and durable gas chlorinator. The body and parts are machined from solid material, not injection moulded. Capacities range from 4 - 500 lbs per day.

**IDEAL HORIZONS INC** PO Box 1707, Rutland, Vermont 05701 1701 USA Tel: +1-802-773-4346, Fax: +1-802-773-2538. Ideal Horizons manufacture stainless steel ultra-violet disinfection equipment. Our modular systems allow for versatility over a wide range of applications and flow rates. These systems are engineered for durability and performance.

**KATADYEN PRODUCTS INC.** Industriestrasse 27, Wallisellen 8304, Switzerland Tel: +41-18-303677, Telex: +826267 kydn ch, Fax: +41-18-307942. Developing and manufacturing of economical, userfriendly and environmentally compatible methods of water disinfection and preservation.

**KING LEE CHEMICAL CO.** PO Box 146, Del Mar, California, 92014, USA Tel: +6196931358, Fax: +6196931358. King Lee is world pioneer and leading supplier for performance chemicals used when processing water with Reverse Osmosis and prevent scale formation within process equipment. In addition highly effective cleaners are available for restoring equipment performance. All products offered are safe, effective and economical to use. DISTRIBUTOR INQUIRIES ARE WELCOME!

**KRUDICO INC** Highway 71 East Lake View IA 51450 USA Tel: +1-712-657-2628. Manufactures pellet chlorinators, dry pellet chlorinators, chlorine pellets, water softeners, iron filters, carbon filters and related products. (WT)

**LIGHT SOURCES INC** PO Box 569 410 Main St Ansonia CT 06401 USA Tel: +1-203-736-9961, Telex: 643266, Fax: +1-203-736-2879, Contact: Ken Ell. Manufacturers of ultra-violet lamps for waste water, potable water and high purity water treatment.

**MAROLF INC** 15500 49th St North Clearwater FL 33520 USA Tel: +1-813-536-5991. Manufacture of water and wastewater treatment equipment for use in subdivisions and municipalities.

**MASTER WATER CONDITIONING CORP** 224 Shoemaker Rd Pottstown PA 19464 USA Tel: +1-215-323-8358, Fax: +1-215-323-5526, Contact: Mr Karl Christ. Manufacturers of water softeners, filters, deionizers, reverse osmosis systems and ultraviolet purifiers.

**NEI THOMPSON LTD KENNICOTT** PO Box 100 Eppinghall Wolverhampton West Midlands UK Tel:

+44-902-353353, Fax: +44-902-405500, Contact: Mrs P M Grainger. Founded in 1902, Kennicott is a major UK based contractor of water treatment plant and gas generation systems. The company specialises in plant for the production of high purity water for boiler feed, process and potable applications and systems for the on-site generation of sodium hypochlorite and hydrogen.

**OXI GENERATORS INC** 4990 Euclid Rd Va Beach VA 23462 USA Tel: +1-804-497-3128, Fax: +1-804-624-2128, Contact: Donald E Meyers. OXI generators are mixed oxidant gas generators for on-site production of disinfectants for drinking water. Units require only salt, water and 4kwh of electricity per kg of disinfectant gas produced. Sizes available are 0. 5, 1 and 2. 3kg/day.

**OXIDIZERS INC** 4990 Euclid Rd Virginia Beach Virginia 23462 U S A Tel: 1-804-497-3128, Fax: 1-804-624-2128, Contact: Mr Myers. Manufactures self contained, on site, oxidant gas generators that provide safer water treatment than conventional methods at a lower cost. Oxi generators eliminate many problems with disinfected drinking water in remote areas.

**OZONE PURE WATER INC** 2485 15th St Sarasota FL 34237 USA Tel: +1-813-366-2509. Manufactures patented ozone systems to treat well water, central water, swimming pools, spas, cooling towers, sprinklers, RVs and boats without chemicals. Maintenance free, automatic, fully warranted. Corona discharge design. (WT)

**OZOTECH INC** PO Box 866 2401, Oberlin Rd Yreka CA 96097 USA Tel: +1-916-842-4189. Manufactures and markets a line of small ozone generators utilizing a technology developed specifically for residential and small commercial potable water treatment. Because they do not require feed-air drying or cooling, installation is very simple. (WT)

**PLENTY LTD** Ham Bridge Rd Newbury Berkshire RG14 5TR UK Tel: +44-635-42363, Telex: 848023, Fax: +44-635-49758, Contact: Andy Colquhoun. Manufacture and design of filters, mixers, pumps, pipe cleaning equipment and electro chlorinators. Representation worldwide.

**PORTACEL LTD** 10 Tannery Rd Tonbridge Kent TN9 1PP UK Tel: +44-732-364411, Telex: , Fax: +44-732-362575, Contact: Mr Page. Portacel manufactures a comprehensive range of gas chlorination equipment and associated analysing systems. Current range includes the "clyde" chlorinator which offers cost effective, low maintenance and economic chlorination. Portacel is a member of portals water treatment.

**PORTER CHADBURN ENGINEERING LTD** Park Lane Works Bootle Merseyside L30 4UP UK Tel: +44-51-525-4155, Telex: 629576, Fax: +44-51-525-4150, Contact: Graham Freeman. Suppliers of ceramic, ultra-violet, silver ion and cathodyn water treatment systems.

**PURE WATER SYSTEMS INC** 210 Washington Avenue Nutley NJ 07110 USA Tel: +1-201-235-1944. Manufacture ultra-violet water treatment products.

# Ultra-Violet Equipment

Manufacturers of:

- **Ultra-Violet systems**
- **Ozone generators**
- **UV/Ozone combinations**
- **Custom fabricated  
Stainless Steel systems**
- **Multi-pass units**
- **Private labeling**

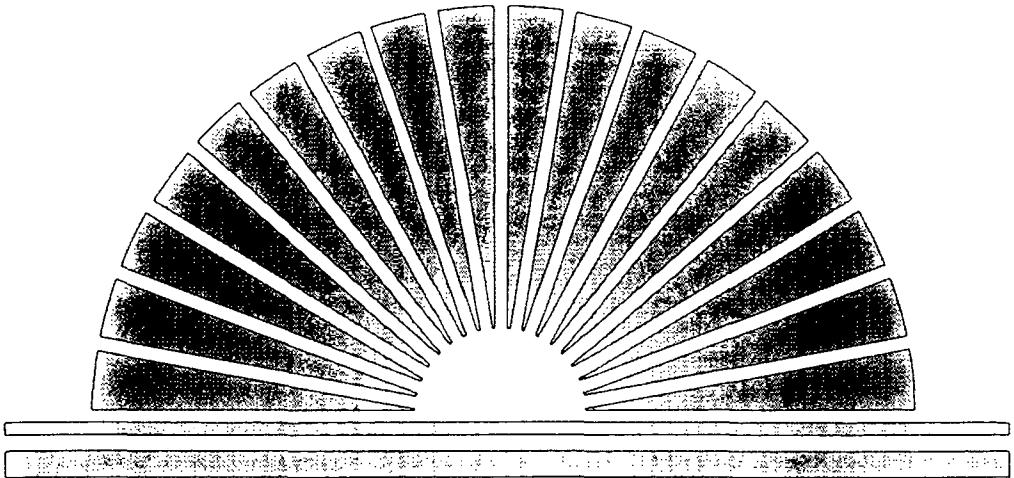

# Ideal Horizons

**Box 1707  
Rutland VT 05701, USA**

**Phone: 802-773-4346  
FAX: 802-773-2538**

Copyright © 1989

**SCIENCO SYSTEMS INC** 3240 N Broadway St Louis MO 63147 USA Tel: +1-314-621-2536, Telex: 442449, Fax: +1-314-621-1952, Contact: Mr Don Mason. Manufacture point of use water treatment equipment, on-site chlorine generators, small and large applications, mobile and fixed package water treatment systems for making potable water from surface, well, brackish and salt water.

**MICHAEL SMITH ENGINEERS** Oaks Rd Woking Surrey GU21 1PH UK Tel: +44-4862-71871, Telex: 859306 MSEWOK, Fax: +44-4862-23110, Contact: Mr Sam Smith. Engineers and distributors for specialised pumping equipment. Pumping systems and packaged dosing systems designed to customer requirements. Chlorination equipment and pumps.

**SORBIOS GmbH** Ackerstrasse 71-76 1000 Berlin 65 W Germany Tel: +49-30-469-4631, Telex: , Fax: +49-30-469-46-46. Ozone generators, monitors, uV photometry, ozone process equipment, laboratory and engineering services, tour partner in ozone technology for water treatment (ultrapure, drinking, swimming pool and sewage water) chemical synthesis and sterilizing processes.

**TARI GESELLSCHAFT mbH** A-5280 Braunau/Inn Peter-Rosegger-Weg 12 Austria Tel: +43-7722/32-64, Telex: 027-75524. Tari GesmbH are engaged in water technology. Their products are used for water treatment, in particular drinking and service water from rivers, brackish and karst waters, for ultraviolet irradiation, reverse osmosis, full desalination and decarbonisation. For water treatment the firm produces ozonizing equipment. Tari undertake the planning, production and installation of various facilities, including small and large size swimming-pool systems using mechanical and chemical water treatment.

**TFI CO/UV SYSTEMS** 4915 Niagara St Commerce City CO 80022 USA Tel: +1-303-288-6823. Custom plastics manufacturing of process equipment, tanks, duct, plating systems, air scrubbers, etc, with PVC, polypro, PE and PVDF. Manufactures UV units for drinking water, cooling towers and waste water treatment. Manufactures and services UV ozonators for industrial water treatment engineering and design of process control systems. (WT)

**TROJAN TECHNOLOGIES INC** 845 Consortium Court London Ontario N6E 2SB Canada Tel: +1-519-685-6660, Telex: 064-7219, Fax: +1-519-681-8355, Contact: Mr Rory Murphy. Manufacturers of ultra-violet disinfection systems for the municipal and waste water markets in pressurised or gravity flow types.

**ULTRAVIOLET TECHNOLOGY INC** 8930 Osage Avenue Sacramento CA 95828 USA Tel: +1-916-383-5111. Manufacture water disinfection systems.

**WALLACE & TIERNAN LTD** Priory Works Tonbridge Kent TN11 0QL UK Tel: +44-732-771777, Telex: 95278, Fax: +44-732-771800, Contact: Mr Miller. A company manufacturing a range of equipment to disinfect water and to provide the addition of chemicals necessary for coagulation etc. The range comprises of equipment designed for simple remote stations as well as the most sophisticated system of controlled addition.

**WATER EQUIPMENT TECHNOLOGIES INC** 832 Pike Rd W Palm Beach FL 33411 USA Tel: +1-407-684-6300, Contact: George T Karmbis. Manufacturers of water filtration and reverse osmosis products from 12 gallons to 250,000 gallons per day.

## Municipal Water Treatment

**ALDOUS AND STAMP LTD** 86-90 Avenue Rd Beckenham BR3 4SA UK Tel: +44-1-659-1833/4/5, Telex: 896691, Fax: +4-1-676-9676, Contact: Mr Aldous. Aldous and Stamp are specialist manufacturers and suppliers of chemicals and equipment for the treatment of water used in residential, commercial, industrial and heating/ventilating applications. Services include laboratory analysis, advice on treatment methods, design and supply of plant.

**AQUA-AEROBIC SYSTEMS INC** P O Box 2026 6306 North Alpine Rd Rockford Illinois 61130-0026 USA Tel: +1-815-654-2501, Telex: , Fax: +1-815-654-2508, Contact: Carol S Zies. Aqua-Aerobic Systems Inc is a designer/manufacturer of equipment used in the biological treatment of water and wastewater. Equipment includes: direct drive aerators, direct drive mixers, automatic backwash filters and sequencing batch reactor (SBR) system.

**AQUASOLAR** Gutenbergstrabe 1 3014 Laatzen 1 POB 110112 West Germany Tel: +49-51-18236914 Fax: +49-51-18236550. Solar desalination plants to produce potable water or/and water for irrigation. The plants can be constructed for a water production rate from 20 litre/day up to 1700 litre/day. In the water range of 20 up to 1000 litre/day we suggest to use the small plant type "SIM". And over 1000 litre/day we suggest to use the plant type "SME". In addition the desalination plants can be integrated in a Greenhouse. Complete constructed from AQUASOLAR too. This enables to produce high quality food beside water production. Solar Heater "SOLADUR" with a hot water tank to produce hot water by solar energy. No electric power for pumps are required!

**N V AQUAVIA S A** Vosselarestraat 73 Nevele B-9840 Belgium Tel: +32-91-71-71-71, Telex: +11477, Fax: +91-71-71-80. Manufacture flotation, filtration (diatomite and sand) and aeration systems. Also install and design, if necessary, mechanical and chemical treatment systems, potable, swimming pool, industrial and municipal treatment.

**BADEN ITALIANA SPA** Via Benaco 117 Bedizzole 25081 Italy Tel: +39-30-674593, Telex: 300853, Contact: Mr Piccoli. Manufacturers of primary water treatment plants including treatments for aqueducts-municipal or rural. Mobile plants using chlorine or ozone, in containers to produce drinking water for smaller communities.

**BAUMEISTER KASTNER** A-8911 Admont Weng 127 Austria Tel: +43-3613/2772. The Admont-based engineering office Kastner (other offices in Graz and Kapfenberg) was founded in 1970 and is engaged in the plan-



## MUNICIPAL WATER TREATMENT

ning, invitation to tender, building supervision and operation of municipal water supply plants, sewage disposal systems, clarification plants and refuse disposal facilities. The company undertakes the execution of complete projects from the planning stage onwards and paying special attention to operating costs.

**CSR HUMES PTY LTD** PO Box 31, World Trade Centre, Melbourne, Victoria. 3005, Australia Tel: +61-3611 3311, Telex: +38015, Fax: +61-3614 6347. Humepipe Systems, precast structural concrete products, protective linings, soil stabilisation products: Humes Concrete is Australia's leading producer of concrete pipe and precast concrete products and, as such, is a significant contributor to the construction of the nation's irrigation, sewerage and drainage reticulation systems. As well, Humes Concrete products are utilised in major transport infrastructure works, rural and domestic applications. The Advance Australia Award winning Eurocycle, a compact domestic wastewater treatment plant, an inexpensive alternative to sewerage, septic tank and pump-out systems.

**DAYTON INDUSTRIAL WATER** 1288 McCook Avenue Dayton OH 45404 USA Tel: +1-513-461-5900. Commercial, industrial and institutional water treatment.

**DDS FILTRATION** PO Box 149 Nakskov DK-4900 Denmark Tel: +45-53-92-27-99, Telex: 47558 ddsfil dk, Fax: +45-53-92-31-11. DDS Filtration develops, manufactures and markets membranes and turnkey reverse osmosis plants. Both plate and frame as well as spiral wound systems are sold for a wide range of applications within the water treatment industry.

**DEGREMONT LAING LTD** Page St London NW7 2ER UK Tel: +44-1-959-3636, Telex: 8958741, Fax: +44-1-906-5164, Contact: Julie Mitchell. Complete range of municipal/industrial water and waste treatment plant. Processes include: Pulsator clarifiers, Aquazur filters, dissolved air flotation, ozone generation - sludge dewatering, desalination plants, turnkey contracts, pressure filters, biological treatment.

**ENVIRO-CARE CO** 5614 W Grand Avenue Chicago IL 60639 USA Tel: +1-312-745-7773, Fax: +1-312-745-8383, Contact: Mr Rodzinski. Flo-screen of revolutionary simplicity in design and operation, stainless steel construction, for intercepting and positively removing debris. Minimum screen opening - 1/8in uses minimum energy and is maintenance free.

**ESSENER HOCHDRUK-ROHRLEITUNGSBAU P O** Box 120124 Essen 12 D-4300 West Germany Tel: +49-201-349-25, Fax: +49-201-351423. Plants for the chemical industry and fertilizer factories including company-developed process and production know-how in the fields of large-scale evaporation and crystallization for the production of salt and potable water from sea water, for the treatment of process solutions for valuable materials recovery and thus for water conservation.

**FLYGT AB** Box 1309 S-171 25 SOLNA, Sweden. Tel: +46-8-733 6500, Telex: +43887 flygtab s, Fax: +46-8-295816, Contact: Anderz Öhringe. Flygt is the world's

leading manufacturer of submersible heavy-duty pumps for contaminated and abrasive liquids. The annual sales for 1988 was approx SEK 2.3 billion. With over 1,250,000 installations in more than 100 countries throughout the world, Flygt submersible products encompass an awesome range of pumps, mixers and hydro turbine generators for small scale hydro electric power stations. The main office is situated in Solna, just outside Stockholm, with manufacturing facilities are in Lindas. Flygt has subsidiaries in 16 countries and 3,400 employees of which 1,500 are in Sweden.

**GRUNDFOS INTERNATIONAL A/S P D** Jensensvej 7 Bjerringbro 8850 Denmark Tel: +45-6-68-14-00, Telex: 60731 gfos dk, Fax: +45-6-68-44-72. Grundfos all stainless steel raw water pumps models BP - SP - CR are widely used in municipal water treatment plants throughout the world. Capacity: Q up to 280 cbm/h. H up to 500 m.

**CSR-HUMES PTY LTD** PO Box 31, World Trade Centre, Melbourne Vic. 3005, Australia Tel: +61-36-113311, Telex: +38015, Fax: +61-36-146347. Humepipe Systems, Precast, Structural Concrete Products, Protective Linings, Soil Stabilisation Products: Humes Concrete is Australia's leading producer of concrete pipe and precast concrete products and, as such, is a significant contributor to the construction of the nation's irrigation, sewerage and drainage reticulation systems. As well, Humes Concrete products are utilised in major transport infrastructure works, rural and domestic applications. Advance Australia Award winning Eurocycle, a compact domestic wastewater treatment plant which is an inexpensive alternative to sewerage, septic tank and pump-out systems.

**HUNGALU TRADING COMPANY** PO Box 63 Budapest 1388 Hungary Tel: +36-1-494750, Telex: 22-54-71, Fax: +36-1-402-723. Granulated aluminium sulphate for water purification and sewage purification.

**HYDRANAUTICS** PO Box 3690 Santa Barbara CA 93130 USA Tel: +1-805-964-0765. Manufactures spiral wound cellulosic and non-cellulosic type membrane products and FRP pressure tubes. Designs complete systems for municipal and industrial water treatment applications. (WT)

**HYDROTECHNIK GmbH** Alpenstrabe 54, PO Box 14, A-5033 Salzburg, Austria Tel: +662285310, Telex: +633821 hydr a, Fax: +6622853110. HYDROTECHNIK AUSTRIA have come to hold worldwide a leading position in the field of water treatment, waste water treatment and water desalination. There are many different application possibilities of their plants, e.g. treatment of surface water (e.g. lakes, rivers) to provide communities, municipalities, camps, etc. with drinking water. Depending on the required capacity, HYDROTECHNIK AUSTRIA provides either conventional plants or their HYDROCOMPACT-Plants, which are completely prefabricated and tested in Austria. Thereof results very short and simple erection work.

**INAQUA ENTERPRISES INC** 6265 E Sawgrass Rd Sarasota FL 34240 USA Tel: +1-813-377-1889, Contact:

# GOING FOR EXCELLENCE IN WATER PROCESSING

DDS FILTRATION is a subsidiary of De Danske Sukkerfabrikker, one of Denmark's largest industrial and commercial concerns, founded in 1872, specialising in the food industry, food machinery and the dairy industry as well as industrial air condition, production of paper, biotechnology and treatment of water.

DDS FILTRATION was the first European company to start research and development in Reverse Osmosis (RO) membranes in 1965 for water processing. Since that time DDS FILTRATION invented the DDS Plate & Frame System for brackish water and adapted the Spiral Wound

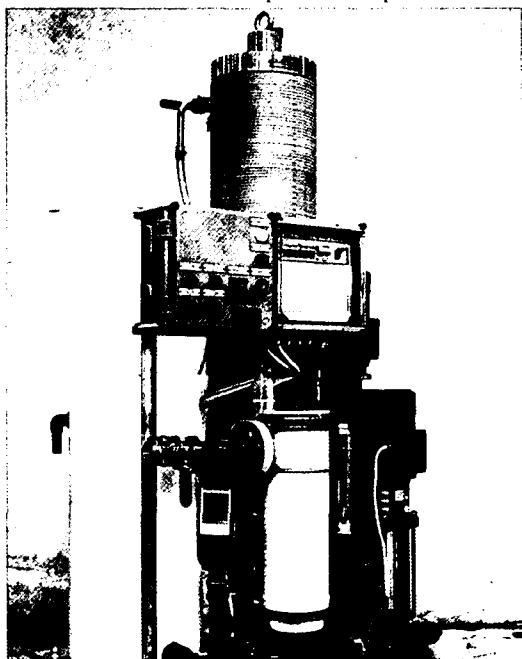

System for sea water. Its techniques have been specially developed and improved over the past 25 years.

The DDS FILTRATION techniques are particularly suited to the Middle East and North Africa because they require minimum service and maintenance and very little manpower. Both techniques can produce water to a higher standard than that prescribed by the World Health Organization which puts a ceiling on total dissolved solids of 500 milligrammes a litre. 'DDS makes what the market needs — simple design, high degree of reliability and a robust system.'

The result is that today DDS has more than 200 plants in operation in the Middle East area. The largest are 3,500 cubic metres a day, operating on brackish water. Other possibilities for using the DDS Membrane Filtration Systems are:

- Drinking water for cities and remote areas
- Water for greenhouses and nurseries
- Water for hospitals, pharmacies and laboratories
- Water for construction camps and military installations
- Waste water treatment for islands and remote communities

DDS uses improved thin film composite membranes with special characteristics — first, salt rejection is 99.5%; second, temperature tolerance is 0-50°C; third, pH-tolerance is 1-13; and last, the high flux means 150 litres per hour per square metre is achievable. Several membranes are available and this gives a possibility to choose a membrane which provides the precise separation characteristics needed to treat the water.

## Two Different Systems

The Plate & Frame System is particularly suited for desalination of brackish water, especially if the calcium or sulphate content is very high. The modules can operate at high pressures and temperatures and are built of stainless steel and highly resistant polymer materials. A simple construction which allows quick membrane exchange.

The Spiral Wound System is a good solution for removing salt and other low molecular weight substances from sea and brackish water. Very saline solutions can be treated, as can waste water and hard water. Due to a simple plant construction the total installation cost of a DDS Spiral Wound plant is very low.

DDS FILTRATION uses special, high-quality components, such as Grundfos stainless steel high pressure pumps and SM0254 Swedish steel for high pressure piping systems. DDS also provides on-the-spot service throughout the Middle East area, and especially the GCC states. DDS distributes and sells off-the-shelf compact plant units with capacities ranging from five cubic metres a day up to 150 cubic metres a day on sea or brackish water.

**DDS FILTRATION** ADVANCED MEMBRANE TECHNOLOGY

Slavangervej 10 P.O. Box 149 DK-4900 Nakskov Denmark  
Telephone +45 53 92 27 99 Telex 47558 dds fil dk Telefax +45 53 92 31 11





## Water desalination systems from DDS Reliability knows no limits

*DDS reverse osmosis system Δ provide pure, healthy water for people, and livestock, and makes agriculture profitable in remote, dry areas.*

**T**he ancient Egyptians had to rely on the whims of the Nile each spring to renew the parched soil along its banks. Today, DDS reverse osmosis systems are providing pure, healthy water throughout the Middle East and North Africa - tough, reliable systems designed to withstand the heat of the day and the chill of the night.

Desalination of the sea and brackish water has been a DDS speciality for over two decades. DDS reverse osmosis facilities supply drinking water, water for livestock, and agriculture - even in remote and isolated areas. DDS plants are quickly and easily erected, and consume very little energy. Chemical pre-treatment of brackish water is often unnecessary. And this means payback time is minimal.

DDS is a fully-integrated, single-responsibility supplier with experienced representatives in the Middle East and North Africa. Wherever you are, DDS is as close as the nearest telephone.

*A DDS Spiral Wound reverse osmosis module - ideal for desalination of sea and brackish water*



**DDS FILTRATION** ADVANCED MEMBRANE TECHNOLOGY

Stavangervej 10 · P.O. Box 149 · DK 4900 Nakskov · Denmark  
Telephone: +45 392 27 99 · Telex 47558 ddsfil dk · Telefax: +45 392 31 11

# MUNICIPAL WATER TREATMENT

Bill Ravey. Manufacturer of commercial industrial and residential water treatment equipment. Also a major distributor of component parts.

**INFILCO DEGREMONT INC** PO Box 29599 Richmond VA 23221 USA Tel: +1-804-281-7600. Manufacture industrial and municipal water and wastewater treatment equipment.

**ION EXCHANGE PRODUCTS INC** 4834 S Halstead St Chicago IL 60609 USA Tel: +1-312-254-1300. Since 1922 has been in the business of supplying quality water treatment equipment for industries, cities, hospitals, laboratories, off-shore and homes. (WT)

**LAYNE-WESTERN CO INC** 721 West Illinois Avenue Aurora IL 60506 USA Tel: +1-312-897-6941. With 28 offices located throughout the US, Layne-Western Company is recognized as the leader in the field of water technology. Fully capable of providing practically every vital service needed by water users, municipal, industrial and agricultural. Services: complete hydrological engineering investigation, industrial and irrigation supply systems, drill and maintain water wells, install and service deep well pumping equipment, sell and install water and waste water treatment equipment for municipal water treatment.

**LYONNAISE DES EAUX** 52 Rue de Lisbonne Paris Cedex 08 75008 France Tel: +33-40-75-70-00, Telex: 643-407, Fax: +33-1-45624270, Contact: Mlle Valenfi. Lyonnaise serve communities in fulfilling long-term needs of municipalities and industry in the field of water supply and management, waste water treatment, drinking water distribution, sanitation and financial engineering.

**MAHON & MCPHILLIPS (STRATFORD) LTD** Holford Way, Witton Birmingham West Midlands B6 7AX UK Tel: +44-21-356-7606, Telex: 334041, Fax: +44-21-356892, Contact: Mr Hatt. Mechanical plant contractors, designers and manufacturers in the field of municipal and industrial water and waste water treatment.

**MICROFLOC PRODUCTS, JOHNSON FILTRATION SYSTEMS INC** P O Box 64118, 1950 Old Highway 8 New Brighton MN 55112 USA Tel: +1-612-636-3900. Water treatment equipment and systems for municipal and industrial applications.

**MID AMERICA WATER TREATMENT** 901 W Lake St Addison IL 60101 USA Tel: +1-312-289-6400, Contact: Robert Colluzzi. Water treatment components for industrial, commercial and residential use, which includes all kinds of filters, reverse osmosis, drinking water, control valves and different types media.

**NRG ENTERPRISES INC.** PO Box 1097, Mercer Island, WA 98040 USA Tel: +2062321274, Telex: +9102507470, Fax: +2062321880. Water filters for the home which require no plumbing to install and no filter change for 5 years. We supply and train distributors in set up and operation.

**OCV CONTROL VALVES** 7400 East 42 Place Tulsa

Oklahoma 74145 USA Tel: +1-918-6924-1942, Telex: 910-845-2227, Fax: +1-918-622-8916. OCV manufactures and internationally markets a complete line of automatic, hydraulically operated, diaphragm actuated, pilot controlled valves. The OCV line of control valves is widely used through private, municipal and military water treating facilities.

**PANNONPLAST WORKS** P O Box 30 Budapest H-1400 Hungary Tel: +36-1-225-849, Telex: , Fax: +36-1-229-228, Contact: Jozsef Lazar. Production, design and supply of plastic tube settler modules for clarifier intensification. The hydraulic load can be increased up to 6-7 m/h. Smaller surface, less construction costs.

**PATERSON CANDY INTERNATIONAL LTD** 21 The Mall, Ealing London W5 2PU UK Tel: +44-1-578-1311, Telex: 27239, Fax: , Contact: S E J Lindsey. Design, process engineering, construction, mechanical/electrical engineering of potable water treatment works from village schemes to major cities worldwide.

**POLAR BEAR WATER DISTILLERS MANUFACTURING CO LTD** PO Box 113, Pickardville, Alberta, Canada TOG 1W0 Tel: +1-403-349-4782, FaxL +1-403-349-5904, Contact: Brian Carpenter. Canada's largest manufacturer of residential, commercial and industrial water distillers. Constructed from quality stainless steel, their units remove more than 99% of all contaminants from any source of food water, with virtually maintenance free option available, Polar Bear also manufactures a stainless steel purified water dispensing system for water profit centers. Backed by excellent warranty, Polar Bear is clearly the best!

**PREUSSAG ANLAGENBAU** PO Box 1320, Heinrich-Hertz-Strasse 23 Hemmingen 1 D-3005 West Germany Tel: +49-511-4206-0, Telex: 923523, Fax: +49-511-4206-359.

**STOCKHAUSEN GmbH** Bakerpfad 25, D4150 Krefeld 1 Fax: +02151391632. Chemische Fabrik Stockhausen has fulfilled the requirements for environmentally acceptable and economical sludge dewatering. The new FLOCTRONIC systems and its components ensure that the metered polymer quantities and mixing power are continuously adapted to the composition of the sludge ingredients. This results in constant, easily filterable sludge flocculation, and a sludge feeding system which is exactly adjusted to the particular throughput rate of the filter press (absorption capacity) at that instant. This prevents too high compaction of the solids layer on the filter cloth, which is particularly important with compressible solids, since a too highly compacted solids layer leads to poor throughput rates, long feeding times and a low dry substance content in the filter cake. This results since high compaction reduces the capillary effect directly on the filter cloth.

**SULZER BROTHERS LIMITED** CH-8401 Winterthur Switzerland Tel: +41-52-81-11-22, Telex: 896-060, Fax: +41-52-23-42-83. Sulzer water treatment and wastewater purification plants meet the special requirements associated with all kinds of municipal and industrial applications. In addition, pumps are supplied for communal and industrial water supply and irrigation

# POLAR BEAR WATER DISTILLER MFG CO LTD IS YOUR SOLUTION TO WATER POLLUTION!

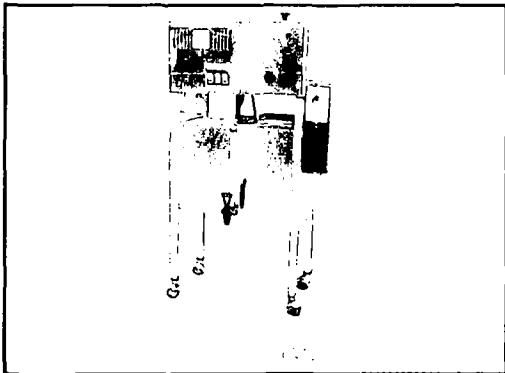

Model 26D-8. Height: 39 $\frac{1}{2}$ in. Width: 20 $\frac{1}{2}$ in. Depth: 13 $\frac{1}{4}$ in. Weight: 53lbs.

Water pollution is a world-wide problem – but POLAR BEAR has the solution! For centuries, distilled water has been the standard for water purity – and continues to be the most reliable purification method known. Distillation kills and removes harmful bacteria, viruses and toxic chemicals. Over twenty years ago, POLAR BEAR recognized the need for clean, pure drinking water – thus beginning their dedication to the water industry. As the demand for pure water grew, POLAR BEAR became Canada's largest manufacturer of point-of-use water distillation equipment. Innovative technology and rigid quality control has made POLAR BEAR a recognized name world-wide. Manufactured from high quality surgical stainless steel, POLAR BEAR water distillers are built to provide a lifetime of pure drinking water. Independent laboratory testing has proven POLAR BEAR water distillers remove greater than 99 per cent of contaminants and toxic chemicals from *any type of feed water*. Backed by an excellent warranty, POLAR BEAR water distillers incorporate many special features – an exclusive energy saving system on all automatic models, automatic start/stop float system, exclusive double-length baffle system, V-shaped boiling tank for easy cleaning and draining, volatile gas release vents, built-in safety system should the distiller overheat, coconut charcoal filters, lighted switches and up-front electrical components for easy servicing. Optional pump kit enables the distilling unit to be installed in a basement or similar location with water pumped to a separate tap at the kitchen sink. POLAR BEAR also manufactures an optional Auto-Drain<sup>®</sup> which automatically drains impurities from the distiller's boiling tank, providing a low-maintenance unit. All models are available in both 110 and 220 volt.

**Residential Water Distillers:** POLAR BEAR manufactures a full product line – both manual fill and automatic units. The manual fill units are available with optional storage tanks and will produce 8 gallons of pure water every 24 hours. Automatic water distillers are connected directly to the home's water line and are available in a range of sizes/production for the small to large families.

**Commercial Water Distillers:** Producing from 12 to 48 gallons of distilled water per day, POLAR BEAR's automatic larger size distillers also have a variety of storage tank sizes. Ideal for offices, restaurants, hospitals or anywhere a larger quantity of pure water is desired (larger sizes also available to 6000 gallons/day).

**Dispensing System:** POLAR BEAR's Purified Water Dispensing System is ideal for water stores, service stations and convenience stores. The double station dispenser features easy-to-read push button controls (1 gallon – 4 litres, 2 $\frac{1}{2}$  gallon – 10 litres, 5 gallon – 20 litres and manual fill) for accurate metering. The unit shuts off automatically once the jug is full and has a spill drain for manual fill operation. An Ultra-Violet treatment system is mounted at the dispenser head with audio and visual burn-out protection. Constructed of the finest stainless steel, this sturdy countertop system may be mounted on a matching stand. Two dispensing units may be assembled back-to-back for a four-station configuration. When combined with POLAR BEAR's commercial Model 180-L, this dispensing system is an ideal turn-key package for water profit centres. Designed for customer operation, the unit does not require extra staff.

Make a wise choice today! Write or call POLAR BEAR WATER DISTILLERS MFG CO LTD for a full information package. Dealer inquiries welcome!

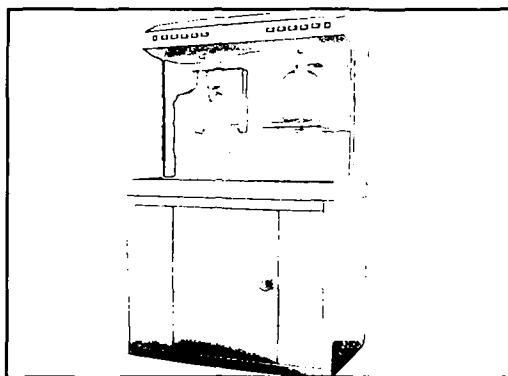

Model PWD-2S – Purified Water Dispensing System.

**POLAR BEAR WATER DISTILLERS MFG CO LTD**  
PO Box 113, Pickardville, Alberta T0G 1W0 Canada  
Telephone: (403) 349-4872 or Fax: (403) 349-5904  
... because we care about the water you drink!

# MUNICIPAL WATER TREATMENT

installations. Furthermore, pumps, decanters and fluid-bed driers required for the treatment of waste waters and sewage sludges.

**SUTCLIFFE SPEAKMAN PLC** Guest St Leigh Lancashire WN7 2HF UK Tel: +44-942-672101, Telex: 67555, Fax: +44-942-677136, Contact: Mr Hugh Buckenham. Manufacturers of shell and coal based activated carbons for the filtration of municipal water, the removal of taste and odour problems in water. Suppliers for hospital, pharmaceutical, brewing and domestic use. Specialist in impregnated carbons.

**WAB WASTE AND WATER TREATMENT** Leberstrabe 118a, A-1110 Vienna, Austria Tel: +02227435600, Telex: +132291, Fax: +022274356032. Desalination and Water softening, Disinfection, Municipal water treatment, Package and Portable water treatment, Mechanical and Biological waste water treatment, Sludge treatment and dewatering, General equipment and process. Specialised equipment and processes.

**WALLACE & TIEMAN DIV PENNWALT CORP** 25 Main St Belleville NJ 07109 USA Tel: +1-201-759-8000. Manufacturer of chlorination and other chemical-feed equipment and systems for treatment of municipal and industrial water and wastewater, includes indicating and transmitting flowmeters, chemical metering pumps, dry chemical feeders and cathodic protection systems for water storage tanks and treatment structures.

**WATER ENGINEERING LTD** Aynho Rd, Adderbury Banbury Oxon OX17 3NL UK Tel: +44-295-810581, Telex: 83655, Fax: +44-295-811997, Contact: John Mee. Design and supply of municipal effluent and water treatment plants worldwide, either on a project management basis or as individual products and process - extending to installation and commissioning.

**WATER TECH INC** 214 N E 83rd St Vancouver WA 98665 USA Tel: +1-206-573-7176, Telex: , Fax: +1-206-573-2662, Contact: Mr Greg Roussett. Water Tech Inc, has hundreds of direct filtration and tube settler type packaged water systems - some in service for 25 years. Our new Pacer™ units are compact and economical with an upflow plastic media coagulation roughing filter, trimedia polishing filter plus an optional coagulant controller. Systems range from 10-1400 gals/min in a single module.

**YIT CORPORATION** Ratamest Arinkatu 12 Helsinki SF-00520 Finland Tel: +358-0-15051, Telex: H121416, Fax: +358-0-1505282, Contact: Mr Nuudineu. YIT Corporation specialises in all types of water and sewage projects ranging from rural water supply schemes to complete turnkey plants including planning, supplies and civil/mechanical/electrical execution on site.

## Package and Portable Treatment Units

**AL KAWTHER INDUSTRIES LTD** PO BOX 7771, JEDDAH 21472 Tel: +96626360644, Telex: +602907

**KAWTHERSJ**, Fax: +96626374337. Al-Kawther provides a wide range of consultancy, design and operation maintenance services as well as supplying: Packaged water/waste-water treatment plants, Filters and Sterilisers, Custom built water/waster-water treatment plants.

**AMICA PRODUCTS (M) SDN BHD** 65-67 Jalan Maharajalela Kuala Lumpur 50150 Peninsular Malaysia Tel: +60-3-2431733, Telex: , Fax: +60-4-627548, Contact: Sam Siew Pak Kheong. Distributor of water filters for domestic use covering the Asian region.

**AQUA CHEM INC** PO Box 421 Milwaukee WI 53201 USA Tel: +1-414-962-0100, Contact: Margi Griffiths. Aqua Chem is a major supplier of packaged water purification equipment for bottled water and pharmaceutical application and sea water desalination around the world.

**AQUAMECH CORPORATION SDN BHD** 5 Jalan Segambut Pusat, Segambut, Kuala Lumpur, 51200, Malaysia, Tel: +60-3-626993062698296262524, Fax: +60-3-6215642, Contact: Mr N Y Wong. A Malaysian incorporated limited company specialising in designing, fabricating and installing package and portable water treatment. Plants most suited, rural development in developing countries using upflow sludge recirculating clarifier, pressure or auto/manual self-wash gravity sand filters and tablets chlorination.

**AQUARIUS WATER PURIFICATION LTD** Unit 12, Craven Court, Winwick Quay, Warrington, Cheshire, UK, Tel: +44-925-445144, Telex: AQUA 627151, Fax: +44-925-413524. A150 portable water purification unit - 150 gallons per hour, manual or electric (mains - battery).

**AQUASOLAR** Gutenbergstrabe 1 3014 Laatzen 1 POB 110112 West Germany Tel: +49-5118236914 Fax: +49-5118236550. Solar desalination plants to produce potable water or/and water for irrigation. The plants can be constructed for a water production rate from 20 litre/day up to 1700 litre/day. In the water range of 20 up to 1000 litre/day we suggest to use the small plant type "SIM". And over 1000 litre/day we suggest to use the plant type "SME". In addition the desalination plants can be integrated in a Greenhouse. Complete constructed from AQUASOLAR too. This enables to produce high quality food beside water production. Solar Heater "SOLADUR" with a hot water tank to produce hot water by solar energy. No electric power for pumps are required!

**AUREPA FAHRZEUGWERKE HEITGER GmbH & CO** 11 Industriestrasse or P O Box 14 80, Hockenheim-Talhaus, D-6832, W Germany, Tel: +49-6205/2006-0, Fax: +49-6205/8324, Contact: Mr W W Pfisterer. Supply of stationary and mobile water purification plants to purify any polluted surface water into drinking water according WHO-standards. Special Multifiltromat system, continuous operation, rinsing of filters with pure water from integrated storage tanks with 5 bar pressure within 180 sec. Using less than 1% of clean water.

**AZTEC ENVIRONMENTAL CONTROL LTD** 8

The new polymers of the trademark  
**PRAESTOL®** are genuine high-tech products.  
They are still more economical and  
ecologically beneficial.



#### The Product

The new **PRAESTOL®** polymers for waste water clarification and sludge dewatering offer

- easy and rapid solubility
- non-ageing solutions due to high stability to hydrolysis
- improved efficiency due to low viscosity
- a sensibly increased dewatering effect
- low dosage in application

#### The Technology

The new **PRAESTOL®** polymers are indispensable for

- effluent clarification and sludge thickening in thickeners and flotation units
- sludge dewatering by centrifuges, sieve belt presses and chamber filter presses

#### The Service

The **Stockhausen Team** guarantees

- an application-orientated advice on the suitable product
- a quick and secure maintenance due to a dense regional service net
- a pre-checking in lab and on the plant
- a concept for an optimum dissolving and dosing equipment
- an optimization of product application for thickening and dewatering of sludges
- a microprocess-controlled sludge dewatering with the new **PRAESTOL®** flocculants



## Stockhausen

Chemische Fabrik Stockhausen GmbH, Div. CV,  
Postfach 570, D-4150 Krefeld 1

Stockhausen Far East Ltd., 6-10 Sun Wui Road,  
134 Chin Hoey Bldg, Causeway Bay, Hong Kong

## PACKAGE AND PORTABLE TREATMENT UNITS

Hawksworth Rd Southmead Industrial Park, Didcot, Oxon, OX11 7HR, UK, Tel: +0235-512000, Fax: +0235-512020. Aztec can design, manufacture and supply a range of plant including sedimentation, flotation, filtration and reverse osmosis desalination treatment equipment.

**BADEN ITALIANA SPA** Via Benaco 117, Bedizzole, 25081, Italy, Tel: +39-30-674593, Telex: 300853, Contact: Mr Piccoli. Manufacturers of primary water treatment plants including treatments for aqueducts-municipal or rural. Mobile plants using chlorine or ozone, in containers to produce drinking water for smaller communities.

**CHEMICAL ENGINEERING CORP** PO Box 266, US Route 335, Churubusco, IN, 46723, USA, Tel: +1-219-693-2141, Fax: +1-219-693-3956, Contact: Joanna Ewing. Manufacture water softeners and filters. Also sell under-the-sink water treatment for drinking water. Handle commercial units for larger areas like hotels.

**CHILTERN WATER TREATMENT CO** Treadaway Tech Centre, Treadaway Hill, Loudwater, High Wycombe, Bucks, HP10 9RS, UK, Tel: +44-6825-27773, Telex: 837139, Fax: +44-494-465489, Contact: Mr David Moreau. Manufacturers and suppliers of a range of packaged water treatment plant and designers and installers of water treatment equipment.

**CHRIST HOLLAND BV** Energieweg 5, Zoeterwoude,

NA, NI-2382, The Netherlands, Tel: +31-71-899218, Telex: 39443, Fax: +31-71-897429, Contact: Mr Reisbter. Christ Holland BV, develops and constructs water treatment systems for softening, demineralisation, desalination, ultra-filtration and ultra-pure water systems for industrial and potable purposes. Christ Holland BV, is a daughter-company of Christ AG, Aesch, Switzerland.

**CLEARWATER SYSTEMS** Riverway Estate, Portsmouth Rd, Guildford, GU3 1LZ, UK, Tel: +44-483-33831, Telex: 859-356, Fax: +44-483-34888, Contact: Richard Jerrard. Clearwater Systems produce water, wastewater and sewerage treatment systems. Our standard products include packaged sewage treatment plants and packaged potable water treatment plants. Exporting to over 30 countries for simple installation on site.

**CONDRILL AB** Sveavagen 83 113 50 Stockholm Sweden Tel: +46-8-349560, Telex: +12336, Fax: +46-8-316762.

**CSR HUMES PTY LTD** PO Box 31, World Trade Centre, Melbourne, Victoria. 3005, Australia Tel: +61-3611 3311, Telex: +38015, Fax: +61-3614 6347. Humepipe Systems, precast structural concrete products, protective linings, soil stabilisation products: Humes Concrete is Australia's leading producer of concrete pipe and precast concrete products and, as such, is a significant contributor to the construction of the nation's irrigation, sewerage and drainage reticulation systems. As

### *A Product of Tomorrow Available Today*

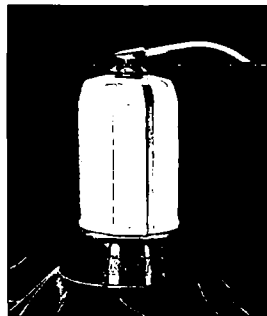

The HURLEY II  
Water Filter System  
for the home

Requires no plumbing to install and no filter change for 5 years because of unique backwash feature. Effectively removes tastes, odors, pipe rust, sediment, organic matter, hydrocarbons and toxic chemicals including chlorine, chlordane, hydroxyl sulfides and THM's. Needs no expensive monthly or quarterly cartridge replacements. Rated "excellent" by Consumer Reports. Lab test results provided on request.

#### **DISTRIBUTORSHIPS AVAILABLE**

Find out how you can share in the opportunity of this tremendous growth industry

Manufactured By:  
Hurley Chicago Co. Inc.  
12621 SO. Laramie Ave.  
Alsip, IL 60658-3225  
Tel: (312) 388-9222  
Fax: (312) 388-9271  
Telex: 289262

Factory Representatives  
N.R.G. Enterprises Inc.  
P.O. Box 1097  
Mercer Island, WA. 98040  
Tel: (206) 232-1274  
Fax: (206) 232-1880  
Telex: 9102507470



# **NATURAL ECOLOGY WATER SCIENCES**

Natural Ecology Water Sciences are Water Consultants and OEM Manufacturers of Reverse Osmosis, Desalination and Ultra-Filtration purification systems. N.E.W.S. Water equipment is custom built for many different and various applications. We assist large or small industries that are commercial and domestic. Capacities available from 16 gallons to over 1,000,000 gallons of purified water per day. Larger capacities are custom built according to what each customer's application and needs are. All water systems utilize current water technology. Materials are American made, FDA approved for low-lead safety and low maintenance costs in water purification. N.E.W.S. will only quote costs when all specifications and requirements are submitted. Our small domestic and commercial home and office units use .3 micron ceramic and carbon filters.

## **Consultant and Manufacturing Applications**

- Salt & Fresh Water Equipment
- Commercial High Capacity Operations
- Resorts, Hotels & Restaurants
- Small to large bottled water systems
- Beverage & Brewery Operations
- Sprinkler Systems (asphalt protection)
- City & Municipal Water Treatment Systems
- Small & large office water systems
- Home & travel water treatment systems
- Commercial Ice Machines
- Portable Water Systems
- Supplier of equipment & replacement parts

## **Natural Ecology Water Sciences**

Att. Mr. Dave Schultz

4451 West Rosecrans Ave

P.O. Box 2398

Hawthorne, California 90251 USA

*Telephone: 213 970 1812 or Fax: 213 676 4873*

## PACKAGE AND PORTABLE TREATMENT UNITS

well, Humes Concrete products are utilised in major transport infrastructure works, rural and domestic applications. The Advance Australia Award winning Eurocycle, a compact domestic wastewater treatment plant, an inexpensive alternative to sewerage, septic tank and pump-out systems.

**ECOLOCHEM INC** PO Box 12775, Norfolk, Virginia, 23502, USA, Tel: +1-804-855-9000, Telex: 240405 ecol ur, Fax: +1-804-855-1478, Contact: Mr Dick Smallwood. Ecolochem provides emergency and supplemental mobile water treatment services including demineralization, filtration, deoxygenisation and softening at flow rates up to 1000 gallons per minute per system, and mobile reverse osmosis trailers also available.

**ENVIRO PURE MILIEU TECH** PO Box 66008, Den Hag, GA, 2506, The Netherlands, Tel: +31-70-55-3615, Telex: 33168, Fax: +31-70-55-3563, Contact: Mr Van Dyke. Supply water sterilization equipment with ultra-violet units and manufacture complete potable water production sets from 500 litres per hour and upward. If required, a small generator is supplied for remote areas.

**GULDAGER SYSTEM** Hejrevang 1-3, Allerød, DK-3450, Denmark, Tel: +45-42-273100, Fax: +45-42-271504, Contact: H Guldager. Production, installation and service of electrolysis systems for the protection against corrosion and scaling in domestic water systems, process water systems and filters for swimming pools, anti-fouling and cathodic protection.

**CSR-HUMES PTY LTD** PO Box 31, World Trade Centre, Melbourne Vic. 3005, Australia Tel: +036113311, Telex: +38015, Fax: +036146347. Humepipe Systems, Precast, Structural Concrete Products, Protective Linings, Soil Stabilisation Products: Humes Concrete is Australia's leading producer of concrete pipe and precast concrete products and, as such, is a significant contributor to the construction of the nation's irrigation, sewerage and drainage reticulation systems. As well, Humes Concrete products are utilised in major transport infrastructure works, rural and domestic applications. Advance Australia Award winning Eurocycle, a compact domestic wastewater treatment plant which is an inexpensive alternative to sewerage, septic tank and pump-out systems.

**HYDROTECHNIK GmbH** P O Box 14, Salzburg, A-5033, Austria, Tel: +43-662-224-720/285310, Telex: 633-821, Contact: Miss Imza. Using the results of research and development accumulated over 20 years, HYDROTECHNIK AUSTRIA has become a leading specialist in the fields of Water Treatment, Sewage Treatment and Desalination technology. Depending on the required capacity, HYDROTECHNIK AUSTRIA provides either conventional plants or their HYDROCOMPACT-plants, which are completely prefabricated and tested in Austria. Thereof results very short and simple erection work. The large number of sold containerised HYDROCOMPACT-plants, mainly to Arab and African countries, has proven their quality. Hundreds of these plants have been producing worldwide continuously drinking for water for thousands of people.

**IDEAL HORIZONS INC** PO Box 1707, Rutland, Ver-

mont 05701 1707 USA Tel: +1-802-773-4346, Fax: +1-802-773-2538. Ideal Horizons manufacture stainless steel ultra-violet disinfection equipment. Our modular systems allow for versatility over a wide range of applications and flow rates. These systems are engineered for durability and performance.

**JOHNSON FILTRATION SYSTEMS** Johnson House, Browells Lane, Feltham, Middlesex, TW13 7EQ, UK, Tel: +44-1-751-4424, Telex: 935479, Fax: +44-1-890-1533. Johnson Filtration Systems produce several ranges of package treatment plant for flows from 2.3 m<sup>3</sup>/hr to 50 ML/DAY, these utilise Johnson Microfloc advanced technology to produce water of high quality at high rates from small units. All tanks are prefabricated and stainless steel is used for the smallest units.

**JOHNSON MICROFLOC** Johnson House, Browells Lane, Feltham, Middlesex, TW13 7EQ, UK, Tel: +44-1-751-4424, Telex: 935479 uselon, Fax: +44-1-890-1533, Contact: Mrs Dicker. Suppliers of advanced technology, High rate, water and wastewater treatment equipment including packaged portable water production systems.

**NEI THOMPSON LTD KENNICOTT** PO Box 100 Etingshall, Wolverhampton, West Midlands, UK, Tel: +44-902-353353, Fax: +44-902-405500, Contact: Mrs P M Grainger. Founded in 1902, Kennicott is a major UK based contractor of water treatment plant and gas generation systems. The company specialises in plant for the production of high purity water for boiler feed, process and potable applications and systems for the on-site generation of sodium hypochlorite and hydrogen.

**POLYMETRICS INC** 101 Nicholson Lane, San Jose, CA, 95134, USA, Tel: +1-408-433-1919. Manufacturer of water purification equipment.

**POTAPAK LTD** 55 Long Acre, London, WC2E 9LJ, UK, Tel: +44-1-836-1016, Telex: 297922, Contact: Mr Curtis. Manufacturers and distributors of packaged water treatment equipment for remote communities of 50 to 2500 people. Enhanced slow sand filtration requiring no chemicals or power for treatment process. Constructed entirely from durable, corrosion free materials.

**PREUSSAG ANLAGENBAU** PO Box 1320, Heinrich-Hertz-Strasse 23, Hemmingen 1, D-3005, West Germany, Tel: +49-511-4206-0, Telex: 923523, Fax: +49-511-4206-359. 5

**REYNOLDS WATER CONDITIONING CO** 12100 Cloverdale, Detroit, MI, 48204, USA, Tel: +1-313-933-3800. One of America's oldest water conditioning companies.

**SCIENCO SYSTEMS INC** 3240 N Broadway, St Louis, MO, 63147, USA, Tel: +1-314-621-2536, Telex: 442449, Fax: +1-314-621-1952, Contact: Mr Don Mason. Manufacture point of use water treatment equipment, on-site chlorine generators, small and large applications, mobile and fixed package water treatment systems for making potable water from surface, well, brackish and salt water.



## The Modern Approach To Water Technology

### Packaged Water Treatment Plant

Aztec's long experience in the water industry has enabled the company to develop a range of small packaged water treatment plants and specialised pilot plants. This gives the company the full capability to offer flotation, filtration, sterilisation and reverse osmosis unit processes for the successful treatment of all waters.

### Instrumentation and Monitoring

Aztec is a major manufacturer and supplier to the UK water industry with its wide range of innovative jar testers, water quality monitors and automatic coagulation systems.

On-line microprocessor controlled instruments are available for aluminium, iron, manganese, phosphate, nitrate, colour, turbidity, pH, conductivity and streaming current. Together with sophisticated control systems, combinations of certain instruments can accurately control and monitor the coagulation process for optimum performance in water treatment.

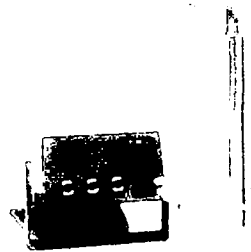
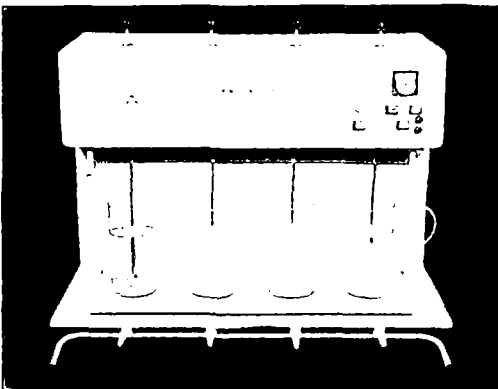

## Aztec Environmental Control Limited

8 Hawksworth Road, Southmead Industrial Park, Didcot, Oxon OX11 7HR, UK  
Telephone (0235) 512000 Fax (0235) 512020

## PACKAGE AND PORTABLE TREATMENT UNITS

**T L B CORPORATION** 150 Willard Avenue, Newington, CT, 06111, USA, Tel: +1-203-233-5109, Fax: +1-203-233-1268, Contact: Thomas E Bond. T L B Corporation is the only prefabricated sewage treatment plant manufacturer that uses 100% noncorrosive materials. This means little maintenance, and longevity of perhaps over 100 years. Potable water treatment packages frequently include flocculation, sedimentation by plate settlers, dual media filtration and sanitizing with either chlorination or ultraviolet.

**WAB WASTE AND WATER TREATMENT** Leberstrabe 118a, A-1110 Vienna, Austria Tel: +43-1-2227435600, Telex: +132291, Fax: +43-1-22274356032. Desalination and Water softening, Disinfection, Municipal water treatment, Package and Portable water treatment, Mechanical and Biological waste water treatment, Sludge treatment and dewatering, General equipment and process, Specialised equipment and processes.

**WESTMOOR LTD** 3452 N Knox Avenue, Chicago, IL, 60641, USA, Tel: +1-312-282-2237, Fax: +1-312-282-4954. Manufacture rotary vane, positive displacement air blowers used for aeration. Products include pumps and pump units plus aeration kits. Aeration systems by Westmoor are used in waste water facilities, lake management and aquaculture, where conventional blowers are unable to overcome the static pressure of greater than 3ft of water.

### Swimming Pool Water Treatment

**APPLIED BIOCHEMISTS INC** 5300 West County Line Rd, Mequon, WI, 53092, USA, Tel: +1-414-242-5870, Telex: 9102763618, Contact: Ruth Gifford. Manufacture water treatment products, primarily algacides for use in surface water, cooling towers and swimming pools. Also other treatment chemicals including clarifiers.

**AQUA ELECTRONICS LTD** Dana Electronics Ltd, Dana Estate, Paddock Wood, Kent, TN12 6LU, UK, Tel: +44-89-283-5555, Telex: 95197 ketlon c, Fax: +44-89-283-2389, Contact: Mrs Linda Barnes. Aqua Electronics Ltd manufactures and supplies compact ozone generators for water purification, ie for swimming pool treatment, drinking water for private houses, small communities and oil rigs etc.

**AQUA PROCESS ENGINEERING LTD** Aqua House, 27 Denison Rd, London, SW19 2DJ, UK, Tel: +44-1-543-3647/8, Telex: 915089 AQUA G, Contact: Mr Clave. Designers of swimming pool filtration systems.

**AQUATEC MARKETING LTD** Unit 1D, Kennetside, Newbury, Berks, RG14 5PX, UK, Tel: +44-635-49141, Fax: +44-635-38681, Contact: Madeline Hall. Aquatech Marketing Limited is an international distributor of swimming pool, spa, whirlpool, water treatment and water engineering equipment. The company's comprehensive product range includes pressure vessels, pumps and irrigation equipment.

**N V AQUAVIA S A** Vosselaerstraat 73, Nevele, B-

9840, Belgium, Tel: +32-91-71-71-71, Telex: +11477, Fax: +91-71-71-80. Manufacture flotation, filtration (diatomite and sand) and aeration systems. Also install and design, if necessary, mechanical and chemical treatment systems, potable, swimming pool, industrial and municipal treatment.

**AZTEC ENVIRONMENTAL CONTROL LTD** 8 Hawksworth Rd, Southmead Industrial Park, Didcot, Oxon, OX11 7HR, UK, Tel: +44-235-512000, Fax: +44-2235-512020. Aztec can supply a range of swimming pool equipment including pumps, filters, pool fittings, chemical test kits and cleaners etc.

**ROBERT R BARTLETT AND SONS** Millbrook Rd, Stover Trading Estate, Yate, Bristol, BS17 5PB, UK, Tel: +44-454-317612, Telex: 445599 RRBSL, Contact: M J Bartlett. Manufacturers and distributors of chemicals and test kits for the treatment of swimming pool water. Publishers of the pool care guide "enjoy your pool".

**BAYROL CHEMISCHE FABRIK** Lochhamer Str 29, Martinsried, 8033, West Germany, Tel: +49-89-85-7010, Telex: +524695, Fax: +49-89-85-701777, Contact: Mr Utz Heyn. Swimming pool and whirlpool care for the public and private sectors and sauna care.

**BIO-LAB INC** P O Box 1489, Decatur, GA, 30031, USA, Tel: +1-404-378-1753. Water treatment division speciality chemicals for water treatment, pool and spa and animal health.

**BS FLOCOR LTD** E5 Stafford Park 15, Telford, TF3 3BB, UK, Tel: +44-952-290350, Telex: 35835, Fax: +44-952-290353. Suppliers of patented Flocor® plastics bio-filtration media for sewage and effluent treatment, MAT Aerators and Cyclomat units for aeration of lagoons, fish farms, lakes and sewage treatment. Also Photozone activated air systems for sterilisation of water.

**CHEMPROHA CHEMICAL DISTRIBUTORS** P O Box 35, Zwijndrecht, 3330 AA, The Netherlands, Tel: +31-1804-23488, Fax: +31-1804-27322, Contact: Mr Van Pveer. As a distributor of chemicals, with locations in the Netherlands, Hong Kong and Puerto Rico, Chemproha buys, transports and sells chemicals around the globe. Within our product range we handle a line of water treatment chemicals for surface and waste waters as well as for swimming pools, such as flocculating agents, pH-control products and water conditioning chemicals.

**D W DAVIES & CO INC** 3200 Phillips Avenue, Racine, WI, 53403, USA, Tel: +1-414-637-6133. Provides a complete line of chemical water treatment for boilers and cooling towers. Also manufactures a complete line of cleaning chemicals, including degreasers, soaps and swimming pool chemicals. (WT)

**DAVEY PRODUCTS PTY LTD** 118 Atkinson St, Oakleigh, Victoria, 3166, Australia, Tel: +61-3-568-1655, Telex: AA139654, Fax: +61-3-568-4551. Manufacturers and marketers of pressure systems, end suction pumps - domestic, commercial and farm, swimming pool filters and pumps, spa bath pumps, engine driven pumps and pressure tanks.

## SWIMMING POOL WATER TREATMENT

**EES CORP** 12850 Bournewood Drive, Sugar Land, Texas, 77478, USA, Tel: +1-713-240-6770, Telex: 795459, Fax: +1-713-240-6762. The "Pre-Engineered" Sanilec<sup>®</sup> "Off-the-Shelf" systems are used around the world to disinfect large (greater than 100,000 gallons) commercial pools. The Sanilec<sup>®</sup> Brine Systems generate sodium hypochlorite from salt, water and electricity. The Sanilec<sup>®</sup> Seawater Systems need only seawater and electricity to generate the sodium hypochlorite directly in to the seawater pool. A Sanilec<sup>®</sup> system eliminates dangerous chlorine gas or other purchased disinfecting chemicals.

**EMCO ENGINEERING INC** 25 North St, Canton, MA, 02021, USA, Tel: +1-617-828-7340, Telex: 924326, Fax: +1-617-828-1714, Contact: Charvel Bechir. The Emco group of companies is an international organization incorporated in the state of Massachusetts, in 1974, specializing in the manufacture of water and waste treatment equipment, including: reverse osmosis, brackish and sea-water desalting plants, ultrafiltration systems, sewage treatment systems, water softeners, reclamation systems, deionization lime treatment, swimming pool equipment and water storage tanks.

**GENERAL FILTER COMPANY** 600 Arrasmith Trail Ames, Iowa, 50010-9761, USA, Tel: +1-515-232-4121, Fax: +1-515-232-2571, Contact: Mr Inouye. The GFC line of diatomite and sand filters for the medium and large pools covers the full range of requirements in swimming pool water conditioning. The Multicell horizontal filter presents many advantages for the larger pools. Backwashing with filtered water may be accomplished directly from the filter itself.

**GULDAGER SYSTEM** Hejrevang 1-3, Allerød, DK-3450, Denmark, Tel: +45-42-273100, Fax: +45-42-271504, Contact: H Guldager. Production, installation and service of electrolysis systems for the protection against corrosion and scaling in domestic water systems, process water systems and filters for swimming pools, anti-fouling and cathodic protection.

**IDEAL HORIZONS INC** PO Box 1707, Rutland, Vermont 05701 1707 USA Tel: +1-802-773-4346, Fax: +1-802-773-2538. Ideal Horizons manufacture stainless steel ultra-violet disinfection equipment. Our modular systems allow for versatility over a wide range of applications and flow rates. These systems are engineered for durability and performance.

**INTEC CORP** 1561 Rustic Hills Drive, Eagan, MN, 55121, U S A, Tel: +1-612-454-1544. Manufacturer of ionization systems for non-chemical swimming pool sanitizing, activated carbon filter media enhancers and non-chemical conditioners and water treatment systems for residential, commercial and industrial applications. Iron nitrite and VOC removal without ion exchange resins. Cooling tower and waste water treatment and H<sub>2</sub>S control.

**INVARMEK UK LTD** 74a Cropwell Rd, Radcliffe On Trent, Nottinghamshire, NG12 2JG, UK, Tel: +44-602-332974/334455, Fax: +44-602-333388. Invarmex manufacture, distribute and export equipment for outdoor parks and swimming pool leisure complexes. Products

include filters, pumps and circulation fittings, flumes, slides pool covers and water fun equipment eg. mushrooms, jets etc. Also fountains and fittings.

**THE MAGIK BOX COMPUTER LTD** Swimming Pool House, Nugent Industrial Park, Cray Avenue, Orpington, Kent, BR5 3RP, UK, Tel: +44-689-30354. The Magik Box reads both the pH and chlorine levels in the pool or spa water, then internally corrects any imbalance sending safe crystal clear water back to the pool. In addition it switches on and off pumps, lights and filters, gives a water temperature readout and has a 'party button' for shock dosing.

**MELCHEMIE HOLLAND BV** Jansbuictnsingel 20, Arnhem, The Netherlands, Tel: +31-85451251, Telex: 4501945523, Fax: +31-85-425-093, Contact: Mrs Overkerk. Dry Chlorine Products (calciumhypochlorite and other disinfectants), flocculants (aluminium sulphate, ferrous sulphate, polyelectrolytes), pH regulating agents (hydrated lime, sodiumcarbonate and sodiumbicarbonate), sanuril 115, aquaward (easy chlorination system), melquick (effervescent chlorine tablets) and swimming pool chemicals.

**OXI GENERATORS INC** 4990 Euclid Rd, Va Beach, VA, 23462, USA, Tel: +1-804-497-3128, Fax: +1-804-624-2128, Contact: Donald E Meyers. OXI mixed oxidant generators keep pools beautiful using only water, salt and electricity. At the same time, the hazards of both dry and liquid treatment systems are reduced.

**SEKO SPA** Via Don Luigi Sturzo 3, Cittaducale, RI, 02015, Italy, Tel: +39-746-62036, Fax: +39-746-62039, Contact: Manrico Bertozzi. Manufacturing of solenoid maturing pumps, peristaltic pumps and dosing systems for applications in: water conditioning, chlorination, swimming pools, water treatment plants, industrial purifications, evaporating towers, surface treatment, detergents, photographic developing, hydro cleaning, agriculture, droplet irrigation, catering drinking water, heating systems, boilers, paper industries, oenology, aquaculture.

**STRANCO LTD** Commercial Rd, Eastbourne, Sussex, BN21 3XE, UK, Tel: +44-323-37011, Fax: +44-323-646035, Contact: Mr Judd. Manufacturers of automatic pH/chlorine control and dosing systems for public swimming pools.

**ERICH STROBL** A-5021 Salzburg, Lastenstrasse 14, POB 49, Austria, Tel: +43-6222/72-1-31/75-3-59, Telex: 633387. Strobl specialize in water handling plants and systems. The line-up includes water treatment plants for swimming-pools, drinking water supply systems and water supply plants for industry. The firm undertakes the planning, production, installation and servicing of water-handling plants.

**SUREX SP PRODUCTS LTD** Units 10 & 11 Airport Trading Estate, Biggin Hill, Kent, TN16 3BW, UK, Tel: +44-959-76000, Fax: +44-959-71000, Contact: Derek Acca. Suppliers of water treatment chemicals, dosing systems and control filtration specialists to swimming pool, aquatic and all water treatment markets - national and international.

## Treatment for Industry and Medicine

**ALDOUS AND STAMP LTD** 86-90 Avenue Rd, Beckenham, BR3 4SA, UK, Tel: +44-1-659-1833/4/5, Telex: 896691, Fax: +44-1-676-9676, Contact: Mr Aldous. Aldous and Stamp are specialist manufacturers and suppliers of chemicals and equipment for the treatment of water used in residential, commercial, industrial and heating/ventilating applications. Services include laboratory analysis, and advice on treatment methods.

**APPLIED WATER ENGINEERING (AWE) INC** 2759 South 300 West "C", Salt Lake City, UT, 84115, USA, Tel: +1-801-486-7774, Contact: Steve Carr. Applied Water Engineering Inc (AWE) manufactures reverse osmosis water purification systems with outputs from 22.5 litres per day and above. Applications include laboratory, medical, dialysis, spot rinse and drinking.

**AQUA CHEM INC** PO Box 421, Milwaukee, WI, 53201, USA, Tel: +1-414-962-0100, Contact: Margi Griffiths. Aqua Chem Inc. is an industry leader in pharmaceutical water-for-injection systems. Our designs provide for high reliability, consistent water quality, extraordinary energy efficiency and strict adherence to CGMP requirements. Packaged pharmaceutical distillation systems are sized from 200 to 1600 gph. Engineered systems available to 6250 gph.

**AQUA FIRE ENERGY CORP** P O Box 356 223 Randolph Avenue, Clifton, N J, 07011, USA, Tel: +1-201-478-0880. Individualized and laboratory controlled boiler water and cooling water treatment services. Ferr-X hi-iron removal, nonchemical, aeration-filtration systems.

**AQUATIC TECHNOLOGY INC** P O Box 479, McLean, VA, 22101, USA, Tel: +1-703-893-1211. Designs and services complete water treatment systems for industrial, commercial and residential applications. Pre-packaged cooling water treatment systems are sized from 50 ton to 100,000 ton units. (WT)

**ARROWHEAD INDUSTRIAL WATER INC** 300 Tri-State International, Suite 320, Lincolnshire, Illinois, 60015, USA, Tel: +1-312-940-1300, Fax: +1-312-940-1385, Contact: Norm Amerher. Suppliers of equipment, technologies and services to provide a higher purity water for industrial applications.

**THE BOOTS COMPANY PLC**, Nottingham, NG2 3AA, UK, Tel: +44-602-592584/592891, Telex: +378431, Fax: +44-602-483889/506111. A revolutionary system for the detection of legionella pneumophila in water systems has recently been launched - legionella rapid assay (LRA). This enables the virulent pontiac strain of legionella pneumophila SGI to be isolated and identified within a working day. LRA can be carried out by a competent technician in a modestly equipped laboratory.

**CALCO LTD** 7011 Barry Avenue, Rosemont, IL, 60018,

USA, Tel: +1-312-296-6615. Manufactures and distributes products for producing ultra pure water.

**CHRIST AG** Hauptstrasse 192, Aesch, CH-4147, Switzerland, Tel: +41-61-78-46-46, Telex: 62458, Fax: +41-61-784485, Contact: Mr Meuli. Christ's processes are used for: the production of ultra pure water for electronic and pharmaceutical industries, the treatment and recycling of waste water from n-fertilizer plants, and for odour abatement of waste air.

**CONDER GROUP PLC** Kingsworthy Court, Winchester, Hants, SO23 7QA, UK, Tel: +44-962-882222, Telex: 47465, Fax: +44-962-885016, Contact: Mike Moore. Clearwater specialise in package sewage and effluent treatment systems for the single dwelling to a complete township. Water treatment extends from simple filtration to plant producing ultra pure water for medical use.

**CONTINENTAL PRODUCTS OF TEXAS** Box 3627, Odessa, TX, 79760, USA, Tel: +1-800-592-4684, Fax: +1-915-337-4685, Contact: Joe A Wallin. Speciality chemicals for industrial water, process and pipeline corrosion and fouling problems. Excellent cooling tower, boiler, closed system, amine, glycol and produced water corrosion inhibitors. Biocides for cooling tower and production. Pipeline corrosion inhibitors oil and water soluble, proven and effective.

**CONTINENTAL WATER SYSTEMS CORP** 5405 Bandera Rd, Suite 117, San Antonio, Texas, 78238, USA, Tel: +1-512-522-6100, Telex: 76-3601, Fax: +1-512-680-5763, Contact: Virginia McElroy. Manufacturers of high purity water systems including reverse osmosis, ultra filtration and deionization.

**COTTEN INDUSTRIES** 275 Schoolheimer Rd, Canastota, New York, 13032, USA, Tel: +1-315-363-8084, Contact: Mr Jack Cotten. Manufacturers and suppliers of a complete line of water conditioners for softening, filtration, UV sterilisation. The company also produces reverse osmosis and demineralisation equipment.

**CRYSTAL FLUID FILTER CO** 865 Grand Boulevard, Westbury, NY, 11590, USA, Tel: +1-516-333-6768. Sediment and odour removal filters, 3 gals to 167 gals per minute. Existing water pressure usually operates units, but pumps can be inserted. Constructed of plastic or SS filter media cartridges.

**CUNO INC** 400 Research Parkway, Meriden, CT, 06450, USA, Tel: +1-203-237-5541, Telex: 221083, Fax: +1-203-238-8716, Contact: Martin Mahard. Cuno Process Filtration manufacturers general filtration and microfiltration products for the chemical, pharmaceutical, cosmetic, food and beverage, automotive and electronic industries. These products consist of membrane, depth, screen and sintered metal types and housings in materials ranging from economical plastics to extremely durable metals.

**D W DAVIES & CO INC** 3200 Phillips Avenue, Racine, WI, 53403, USA, Tel: +1-414-637-6133. Provides a complete line of chemical water treatment for boilers and cooling towers. Also manufactures a complete line

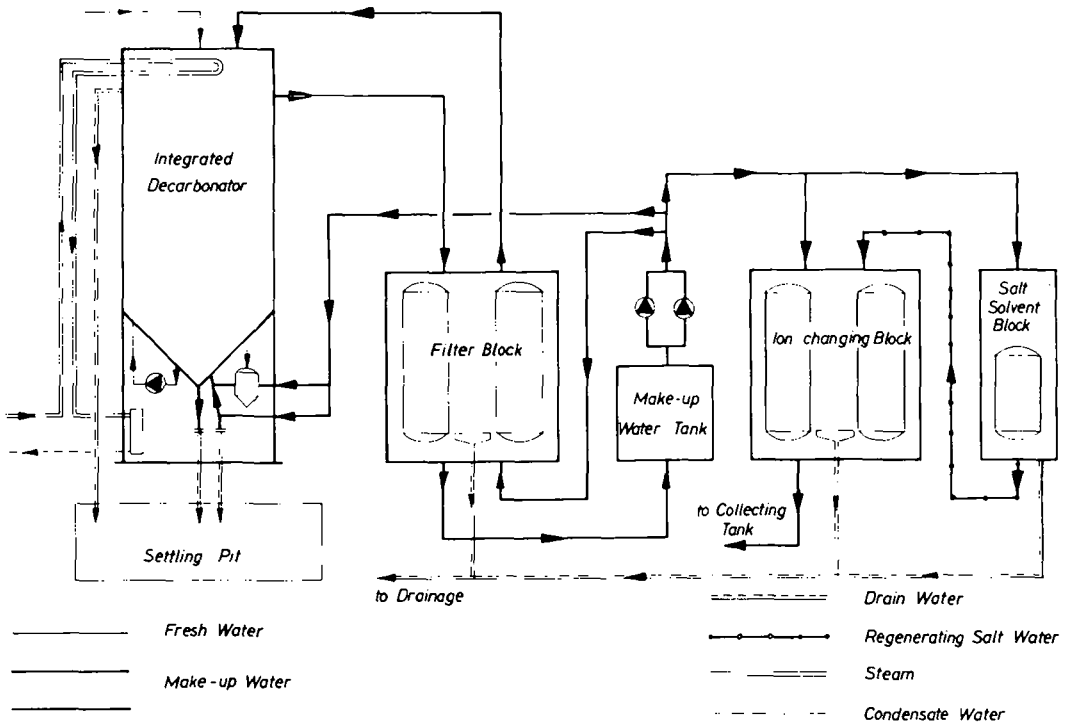

## WATER PURIFICATION — WATER TREATMENT

Due to ever-increasing demand and environmental impurity, the water available to industry and the economy is becoming more and more expensive.

This water must be treated, purified according to the consumer's requirements and depending on water and power resources, must be treated again, the waste water possibly clarified for further utilisation.

Both the requirements of the consumer and the need to protect our environment demand this level of treatment.

Kipszer can offer some of the latest means and equipment for water purification and treatment with an emphasis on maintenance-free running and economical use of resources.

### **CIRCOJET sand-filled tower filter:**

For the filtration of water of large suspended matter content, without primary setting.

Capacity: 15-25m<sup>3</sup>/hour.

### **DEKARBONATOR lime water softener with integrated sludge chamber:**

Its traditional, well-proven lime water units and auxiliary equipment are combined in one unit.

Capacity: 2-100m<sup>3</sup>/hour.

### **Filter equipment with gravel filling:**

Suitable for gravity operation, too, a filter block of continuous operation with the necessary piping and fittings.

Capacity: 2-50m<sup>3</sup>/hour.

### **Ion-exchange water softener:**

NA-ion exchange equipment of continuous operation with the necessary piping and fittings.

Capacity: 2-50m<sup>3</sup>/hour.

### **Thermic degaser:**

Degasing tower of medium pressure, after boiler type, with cascade tray (with so-called rubber spring plate pulveriser at the water inlet) for removal of gases dissolved in water.

Capacity: 2-60m<sup>3</sup>/hour.

### **Feed tank:**

A cylindrical tank in horizontal arrangement for temporary storage of feed and waste waters.

Capacity: 1-25m<sup>3</sup>.

Illustration shows standard coupling method of water softening.

Besides those mentioned above we undertake the production of equipment on the basis of individual projects and undertake settling and mounting of equipment and its piping.



**Industrial Constructing and Contracting Enterprise**  
 Budapest X., Jászberényi út 34-36.

**Letters to:**  
 P.O. Box 28, H-1475 Budapest,  
 Telex: 22-5328.

## TREATMENT FOR INDUSTRY AND MEDICINE

of cleaning chemicals, including degreasers, soaps and swimming pool chemicals. (WT)

**DAYTON INDUSTRIAL WATER** 1288 McCook Avenue, Dayton, OH, 45404, USA, Tel: +1-513-461-5900. Commercial, industrial and institutional water treatment.

**DESALINATION SYSTEMS INCORPORATED** 1238 Simpson Way, Escondido, California, 92025, USA, Tel: +1-619-746-8141, Telex: 697890, Fax: +1-619-747-8253, Contact: Mr Micolaisen. Major manufacturer/supplier of reverse osmosis and ultrafiltration membranes and spiral-wound elements to the OEM market.

**ELGA LTD** High St, Lane End, High Wycombe, Bucks, HP14 3JH, UK, Tel: +44-494-881393, Telex: 83516, Fax: +44-494-881007, Contact: Mark Barber. Elga research, design and manufacture a wide range of water purification equipment and systems for the treatment of potable water, providing high purity water for all laboratory and industrial applications.

**ENCORE DESIGNS LTD** 3929 Bell, Kansas City, MO, 64111, USA, Tel: +1-816-531-8305. Custom applications specialists which develop prototype and custom systems incorporating reverse osmosis, pre-treatment, post-treatment and quality maintenance. Primary design applications include hemo-dialysis, pharmaceutical, laboratories, and refining (WT).

**ERMCO INC** 1570 Fairview Avenue, St Louis, MO, 63132, USA, Tel: +1-314-423-7711, Fax: +1-314-421-5904, Contact: John Kising. Manufacturers of commercial, industrial water conditioning equipment. Industrial water softeners, pressure filter, dealkalizers and special tanks.

**FLUID SEPARATIONS CORP** 14090 Horizon Boulevard, El Paso, TX, 79927, USA, Tel: +1-915-852-1007, Contact: Sal Reutena. Manufacture commercial and industrial water treatment systems including reverse osmosis, ultrafiltration, separate bed DI, mixed bed DI and nitrogen blanket systems.

**W R GRACE & CO, DEARBORN DIV** 300 Genesee St, Lake Zurich, IL, 60047, USA, Tel: +1-312-438-8241, Telex: 2-2428, Fax: +1-312-540-1588, Contact: Jeff Schummel. Leader in development of solutions for industrial water treatment problems. For 100 years has provided products and services to meet industry's boiling water, cooling water and waste water treatment needs.

**GRAVER WATER INTERNATIONAL** 2720 US Highway 22, Union, NJ, 07083, USA, Tel: +1-201-964-2554, Telex: 6853093, Fax: +1-201-964-7770, Contact: Mr Liman. Graver designs and manufactures a complete line of water and waste treatment equipment to fit the needs of industrial corporation and electric generating utilities.

**GUARDIAN CHEMICAL SPECIALALITIES** PO Box 1743, 1225 W Princess St, York, PA, 17405, USA, Tel: +1-717-848-2570, Contact: Bruce Ketrick. Develop and market products and consultation services for industrial influent to effluent water treatment requirements.

This includes clarification, pre-treatment equipment, boiler water chemical treatment, cooling water chemical treatment, fuel additives and waste water programme.

**HÜLZLI**, Seewalchen am Attersee, A-4863, Austria, Tel: +43-7662-2203, Telex: 26480 hoekg a. In the ultraviolet sterilisation plants from Holzli the water to be treated is conveyed through a number of radiation chambers containing specially developed Uvaudes heavy-duty uvemitters designed to kill all germs present in the water without the need for any chemical reactions. This means that no chemicals or reaction vessels are necessary and the plants can be built into any supply line, normal light current being adequate for their operation.

**HAGER & ELSASSER GMBH** P O B 800540, Stuttgart 80, 7000, West Germany, Tel: +49-711-7866-0, Fax: +49-711-7866-202, Contact: Mr Rau. Water treatment plants for treatment of fresh water (sea and bralish-water, ultra-pure-water for electronical and pharmaceutical indusytry, boiler feed water) and waste-water (metal-working industry, textile industry, and power plants.

**HALCO PRODUCTS** 100 N Gordon Elk Grove, IL, 60007-1193, USA, Tel: +1-312-956-1600, Fax: +1-312-956-4595, Contact: Curtis Hale. Manufacture ultra pure water systems for use in semi/conductor and pharmaceutical industries. Engineering for process and design and also turn-key installations.

**HILMAR BECKER GESELLSCHAFT mbH & CO KG** A-4020 Linz, Franzosenhausweg 50, Austria, Tel: +43-732/83-0-01-0, Telex: 021507 becker a. The sphere of operations of Hilmar Becker comprises the production, servicing and sale of water treatment plants and heating, ventilating and air conditioning equipment. The HB production shops turn out filtering, de-ironing, de-acidifying and softening plants, and plants for partial and full desalination and for reverse osmosis.

**HUNGERFORD AND TERRY INC** PO Box 45, Clayton, NJ, 08312, USA, Tel: +1-609-881-3200, Telex: 510-686-6580, Fax: +1-609-881-6859, Contact: Ken Sayell. Manufacturer of water treatment equipment for commercial and industrial applications including pressure filters, softeners, ion remove filters and special application ion exchange.

**HYDRANAUTICS** PO Box 3690, Santa Barbara, CA, 93130, USA, Tel: +1-805-964-0765. Manufactures spiral wound cellulosic and non-cellulosic type membrane products and FRP pressure tubes. Designs complete systems for municipal and industrial water treatment applications. (WT)

**HYDROTECHNIK GmbH** P O Box 14, Salzburg, A-5033, Austria, Tel: +43-662-224-72-0/285310, Telex: 633-821, Contact: Miss Imza. The company's delivery programme includes design, fabrication, erection, installation and commissioning of: water treatment plants, reverse osmosis desalination, plants, sewage and waste water treatment plants for industry and municipalities, containerized package water treatment plants from 10 m<sup>3</sup>/hr up to 250 m<sup>3</sup>/hr, skid-mounted and container-



## TREATMENT FOR INDUSTRY AND MEDICINE

ized package desalination plants for brackish water and seawater, from 0.3 m<sup>3</sup>/hr up to 60 m<sup>3</sup>/hr, containerized package sewage treatment plants, waste heat recovery systems, gas cleaning and treatment systems, membrane systems for gas separation, water refuse and recovery of valuables.

**HYPERFIL INDUSTRIES INC** 1170 Van Horne Way, Anaheim, CA, 92806, USA, Tel: +1-714-630-4381, Fax: +1-714-630-2366, Contact: Gene Gilley. Drinking water specialists in reverse osmosis membranes and technology. Hyperfil manufactures reverse osmosis membranes and related components for water purification in home and commercial applications. Manufacturer of completed RO units, water vending machines, car wash units and key components. Reverse osmosis membranes available for small and large units, chlorinated or non-chlorinated.

**IDEAL HORIZONS INC** PO Box 1707, Rutland, Vermont, 05701-1707, USA, Tel: +1-802-773-4346, Fax: +1-802-773-2538. Ideal Horizons manufactures stainless steel Ultra-Violet disinfection equipment. Our modular systems allow for versatility over a wide range of applications and flow rates, engineered for durability and performance.

**IMB Mathias-Brüggen** Strasse 17, Cologne 30, Biken-dorf, D-5000, West Germany, Tel: +49-221-58-80-40, Fax: +49-221-58-80-488. Production of ultra-pure water for medical and pharmaceutical purposes, eg kidney di-

alysis and cell culture water supply. Water preparation to supply boiler feed water and treatment systems to operate cooling towers of open or closed design.

**KENDALL (Subsidiary of Colgae-Palmolive)** 50 Kerry Place, Norwood, MA, 02062, USA, Tel: +1-617-769-6112, Fax: +1-617-769-3274, Contact: Mr Jim Greene. The Kendall company manufacture a line of poly-sulfane ultra-filtration membranes and membrane cartridges for the ultra-pure water industry, also a line of products for the bio-separation industry.

**LAYNE-WESTERN CO INC** 721 West Illinois Avenue, Aurora, IL, 60506, USA, Tel: +1-312-897-6941. With 28 offices located throughout the US, Layne-Western Company is recognized as the leader in the field of water technology. Fully capable of providing practically every vital service needed by water users, municipal, industrial and agricultural. Services: complete hydrological engineering investigation, industrial and irrigation supply systems, drill and maintain water wells, install and service deep well pumping equipment, sell and install water and waste water treatment equipment.

**MASTER WATER CONDITIONING CORP** 224 Shoemaker Rd, Pottstown, PA, 19464, USA, Tel: +1-215-323-8358, Fax: +1-215-323-5526, Contact: Mr Karl Christ. Manufacturers of water softeners, filters, deionizers, reverse osmosis systems and ultraviolet purifiers.

**MECHANICAL EQUIPMENT CO INC** 861 Caron-

# OSMO® WATER PURIFICATION SYSTEMS

Systems and components for all water purification requirements.

REVERSE OSMOSIS     ULTRAFILTRATION     MICROFILTRATION     DEIONIZATION

standard pre-engineered systems  
 free water analysis service

custom systems to meet any requirement  
 complete application testing service.



OSMO ORION™ - to 1000 gpd (158 lph)

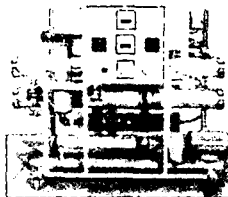

CHF Series - to 100,000 gpd (379 m<sup>3</sup>/d)

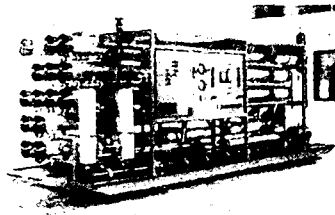

B Series - to 300 gpm (1637 m<sup>3</sup>/d) on one skid

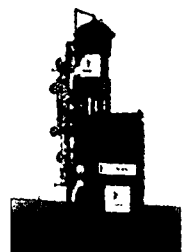

Mixed Bed and Twin Bed DI

**GUARANTEED:** All OSMO equipment is guaranteed by a financially strong Company that is committed to support you after the sale.

**SINGLE SOURCE RESPONSIBILITY:** So whatever your water treatment requirements, come to the Single Source. Osmonics is the only Company that manufactures all the major components of your system: membrane, membrane elements, pumps, prefiltration, DI equipment, complete systems.

One Source. One System. One call.  
**Pure and Simple™**

Call Toll Free: 1-800/351-9008, ext. 201  
(In Minnesota: 612/933-2277)  
TELEX: 29-0847 OSMONICS MTKA  
FAX: 612/933-0141

**OSMONICS**  
5949 Clearwater Drive,  
Minnetonka, Minnesota 55343 USA

## TREATMENT FOR INDUSTRY AND MEDICINE

delet St, New Orleans, Louisiana, 70130, USA, Tel: +1-504-523-7271, Telex: 460165, Contact: Patsy Sezio. MECO is a leader in the engineering and manufacture of packaged water desalination equipment for land-based, marine, pharmaceutical, defense and offshore applications plus a variety of ancillary equipment such as heat exchangers, filters, pure steam generators, sample collectors etc.

**MEDRO SYSTEMS INC** 416 E Industrial Boulevard, McKinney, TX, 75069-7323, USA, Tel: +1-214-542-8200. Manufactures RO systems and water purification equipment for medical, commercial and industrial markets.

**MICROFLOC PRODUCTS, JOHNSON FILTRATION SYSTEMS INC** P O Box 64118, 1950 Old Highway 8, New Brighton, MN, 55112, USA, Tel: +1-612-636-3900. Water treatment equipment and systems for municipal and industrial applications.

**NEI THOMPSON LTD KENNICOTT** PO Box 100 Etingshall, Wolverhampton, West Midlands, UK, Tel: +44-902-353353, Fax: +44-902-405500, Contact: Mrs P M Grainger. Founded in 1902, Kennicott is a major UK based contractor of water treatment plant and gas generation systems. The company specialises in plant for the production of high purity water for boiler feed, process and potable applications and systems for the on-site generation of sodium hypochlorite and hydrogen.

**WALTER NOLD COMPANY INC** 24 Birch Rd, Natick, MA, 017601696, USA, Tel: +1-617-653-1635, Contact: Walter Wold. Walter Nold has researched and discovered a new process for the degasification of fluids - which can degas water, for instance, to boiler water purity.

**OAKITE PRODUCTS INC** 50 Valley Rd, Berkeley Heights, NJ, 07992, USA, Tel: +1-201-464-6900. Development of materials and equipment for industrial water treatment and environmental sanitation.

**OETIKER INC.** 3305 Wilson Street, POB 217j, Marlette, Michigan, 48453-0217, USA Tel: +5176353621, Telex: +5101012489, Fax: +5176352157. OETIKER Miniature Clamps - suitable for clamping hoses, tubes, cables, etc. From 3.3mm to 12.3mm. This line of miniature clamps is available in zinc plate or stainless steel. Ideal for tamper proof connections.

**OSMONICS INC** 5951 Clearwater Drive, Minnetonka, Minnesota, 55343 USA Tel: +1-612-933-2277, Telex: +290847, Fax: +1-612-933-0141. Osmonics manufactures reverse osmosis (RO) and ultrafiltration (UF) from small scale laboratory to full scale production high purity water machines/systems. OSMO® RO and UF systems are wall or skid mounted, completely pretested and ready to install. Osmonics manufactures all of the key components for RO/UF machines including pumps, prefilters and membrane elements for unique single source responsibility.

**OXI GENERATORS INC** 4990 Euclid Rd, Va Beach, VA, 23462, USA, Tel: +1-804-497-3128, Fax: +1-804-624-2128, Contact: Donald E Meyers. OXI generators are

on-site devices for producing mixed oxidant gases for water treatment. Process requires only salt, water and a small amount of electricity. Oxidants are effective for cooling tower algae and slime control, disinfecting solutions for topical applications, taste and odor control and disinfection for water.

**P W T (HOLLAND) BV** Industrieweg 13, Assendelft, 1566, The Netherlands, Tel: +31-75-285651, Telex: 19159, Fax: +31-75-28619. Pielkenrood Water Treatment is specialised in water purification. PWT has a complete range of systems and installations for the treatment of industrial effluent and process and surface water. Our systems are tailor-made and suited to up-grade existing systems.

**PANNONPLAST WORKS** P O Box 30, Budapest, 1400, Hungary, Tel: +36-1-225-849, Telex: 223066 pupkk h, Fax: +36-1-229-228. Production, design and supply of plastic tube settler modules for clarifier intensification. The hydraulic load can be increased up to 6-7 m/h. Smaller surface, less construction costs.

**PURITE LTD** Unit E, Bandet Way, Thame Industrial Estate, Thame, Oxon, OX9 3SJ, UK, Tel: +44-844-217141, Telex: 837561, Contact: Mr Lund. Manufacturers of reverse osmosis units, desalination and reverse osmosis units and cleaning chemicals, deionisation equipment, various filtration units and test kits.

**RYAN HERCO PRODUCTS CORP** 2509 Naomi St, Burbank, CA, 91504, USA, Tel: +1-213-849-1141. Manufacture fluid handling products for industrial water treatment.

**S E E** Rue de la Science, Brussels, B 1040, Belgium, Tel: +32-2-230-9314, Telex: 25-237, Fax: +32-2-230-7613. Water treatment plants: drinking water, waste water, water for industry, swimming pool water. Chemical products for water conditioning. Pre-fabricated units for the production of drinking and waste water treatment.

**SALTECH CORPORATION** P O Box 26872, El Paso, TX, 79926, USA, Tel: +1-915-592-7982. Manufacture industrial water purification equipment.

**SIMMERING-GRAZ-PAUKER AG (SGP)** Brehmstrasse 16, Wien, A1110, Austria, Tel: +43-222-74-69-0, Telex: 131891 sgp s. Simmering-Graz-Pauker supply customised water treatment and flue gas cleaning plants. Applications include steam and industrial power plants and refuse and special refuse incinerators.

**ERICH STROBL** A-5021 Salzburg, Lastenstrasse 14, POB 49, Austria, Tel: +43-6222/72-1-31/75-3-59, Telex: 633387. Strobl specialize in water handling plants and systems. The line-up includes water treatment plants for swimming-pools, drinking water supply systems and water supply plants for industry. The firm undertakes the planning, production, installation and servicing of water-handling plants.

**TECHNIC CENTRAL SYSTEMS INC** 118 No 36th St, Seattle, WA, 98103, USA, Tel: +1-206-633-3080. Manu-

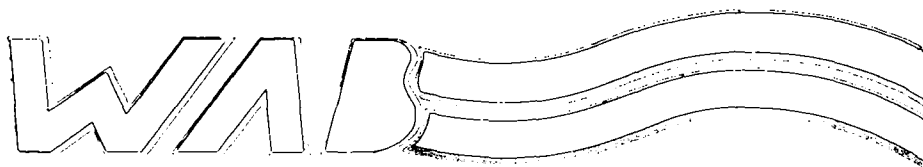

*Water- & Waste Water Treatment*

- ENGINEERING
- DESIGN
- CONSTRUCTION
- MANAGEMENT
- TURNKEY SERVICES

## ***ACTIVITIES ALL OVER THE WORLD***

- DESALINATION AND WATER SOFTENING
- DISINFECTION
- MUNICIPAL WATER TREATMENT
- MECHANICAL + BIOLOGICAL WASTE  
WATER TREATMENT
- SLUDGE TREATMENT + DEWATERING
- GENERAL EQUIPMENT + MAINTENANCE
- SPECIALIZED EQUIPMENT + MAINTENANCE

## TREATMENT FOR INDUSTRY AND MEDICINE

ufacture ultrapure water systems for laboratory, industrial and medical applications.

**WALLACE & TIEMAN DIV PENNWALKT CORP** 25 Main St, Belleville, NJ, 07109, USA, Tel: +1-201-759-8000. Manufacturer of chlorination and other chemical-feed equipment and systems for treatment of municipal and industrial water and wastewater, includes indicating and transmitting flowmeters, chemical metering pumps, dry chemical feeders and cathodic protection systems for water storage tanks and treatment structures.

**WATER CONDITIONING CANADA LTD** 580 Park St, Regina, Saskatchewan, S4N 5A9, Canada, Tel: +1-306-545-6990, Telex: 071-2718. The manufacture and distribution of residential, commercial and industrial water treatment equipment. Water softening, iron and sediment filtration, reverse osmosis and distillation as well as purification products.

**WATER SERVICES CORP/WATERSOFT CO** 111E North St, Waukesha, WI, 5318, USA, Tel: +1-414-547-1862, Fax: +1-414-547-5728, Contact: Julie Watner. Manufacturers of reverse osmosis, iron exchange, filtration and ultra filtration equipment for commercial and industrial use.

**WATER TECH INC** 214 N E 83rd St, Vancouver, WA, 98665, USA, Tel: +1-206-573-7176. Manufacture potable and industrial water treatment packaged plants, also industrial wastewater treatment packaged plants.

**XENTEX INC** 14902 W 117th St, Olathe, KS, 66062, USA, Tel: +1-913-764-3800, Fax: +1-913-764-1743. Supplier to capital construction projects, water stills for hospitals and laboratories, water demineralizers and water softeners. Equipment for wastewater projects such as liquid solid separators, filtration equip, water recycle equip, pond and pit plastic liners etc.

**ZYZA WATER SYSTEMS** 1921 21st Avenue South, Seattle, WA, 98144, USA, Tel: +1-206-328-4915. Manufacturer of high quality water purification devices designed for medical applications.

### General Equipment and Processes

**A R C Derby Unit Sales Office**, Hemington Fields, Shardlow, Derby, DE7 2HP, UK, Tel: +44-332-792266, Telex: 34365, Fax: +44-509-504120, Contact: Mr A Hodson. Naturally rounded quartzite, bagged or loose, for filter support media.

**A W C INC** 330 E Highway 14, Tyler, M N, 56178, USA, Tel: +1-507-247-5436. Manufactures complete line of residential and commercial water conditioning equipment. Distributors for Aquathin purification equipment.

**ACTINI-FRANCE** PO Box 80, Thonon, 74202, France, Tel: +33-50711-800, Telex: 385615, Fax: +33-50718682, Contact: Mr Patrick de Stoutz. Manufacturers of equipment for water sterilisation by ultra-violet rays. Complete range of water treatment equipment and filters.

**ACTION MFG & SUPPLY CO** 1226 S E 9th Terrace, Cape Coral, F L, 33904, USA, Tel: +1-813-574-3443. Manufacture aerators and water conditioning equipment and all types of filters. Distributor of pumps and pressure tanks.

**ADAMS HYDRAULICS LTD** P O Box 15, York, YO1 1XA, UK, Tel: +44-904-622047, Telex: 57664 ADAMS G, Fax: +44-904-611449, Contact: Mr Hopwood. Although over 100 years old, Adams is still an independent company specialising in the manufacture of pumping and treatment machinery and equipment for sewage disposal, water pollution control and industrial processes.

**AIR PRODUCTS & CHEMICALS INC** Allentown, P A, 18195, USA, Tel: +1-215-481-5215. Manufacturer cellulose acetate blend RO membranes cast on polyester cloth support in rolls 40" wide by 650 linear feet. Performance range from 95 to over 98%. NACI rejection at various productivity rates.

**AL KAWTHER INDUSTRIES LTD** P O Box 7771, Jeddah, 21472, Saudi Arabia, Tel: +966-2-6360644, Telex: 602907 KAWTHR SJ, Fax: +966-2-637-4337, Contact: Hussein Mikati. Al Kawther provides a wide range of consultancy, design and O & M services as well as supplying: packaged water/wastewater treatment plants, filters and sterilisers, custom built water/wastewater treatment plants.

**ALAMO WATER REFINERS INC** 1415 Jerry St, San Antonio, TX, 78201, USA, Tel: +1-512-734-7771. Manufactures and wholesales water softeners, iron removal filters, aerators/degasifiers, sediment filters, taste and odor filters, chlorinators, iodine feed systems, pH neutralizing systems, etc. (WT)

**ALBION CONCRETE PRODUCTS** Sales Office, Llan-gadog, Dyfed, SA19 9LT, UK, Tel: +44-550-777327, Fax: +44-550-777328, Contact: Ian Reese. Albion Concrete modular kits to provide wells, catchpits, storage tanks, water troughs, cesspits, septic tanks, full sewage treatment plants, all complete with sewage pumps, high pressure water pumps electrical systems etc. also concrete pipes, box culverts and bridges.

**ALDOUS AND STAMP LTD** 86-90 Avenue Rd, Beckenham, BR3 4SA, UK, Tel: +44-1-659-1833/4/5, Telex: 896691, Fax: +44-1-676-9676, Contact: Mr Aldous. Aldous and Stamp are specialist manufacturers and suppliers of chemicals and equipment for the treatment of water used in residential, commercial, industrial and heating/ventilating applications. Services include laboratory analysis, advice on treatment methods, design and supply of plant.

**ALL PURPOSE MACHINES AND PLANT LTD** 55 Seven Oaks Avenue, Heaton Moore, Stockport, Cheshire, SK4 4AU, UK, Tel: +44-61-432-1877, Contact: N P Lister. Designers and manufactures of mechanical handling and process plants. Reclamation of oil and solvents, distribution plants, steel fabrications, hydraulic lift tables and desalination plant.

**ALLIANCE GROUP INC** P O Box 17849 600 E Keefe,



**HYDRATED LIME  
QUICKLIME  
CALCIUM CARBONATE  
DOLOMITÉ**

**Different grades and sizing for all  
types of applications**

Quality and service has been our main concern for more than a century  
when supplying a very large scale of industries with these versatile materials.

Carrières et Fours  
de la Meuse S.A.  
rue du Château, 13 A  
B-5210 Seilles - Belgium  
Tel. : 32. 85 82 50 09  
Fax : 32. 85 82 63 02

Nekami - Maasgroeven B.V.  
Postbus 436  
NL - 2800 AK Gouda  
Netherlands  
Tel. : 31.18 20 26 264  
Fax : 31.18 20 27 255

Mineraria Sacilese S.p.A  
via Cartiera Vecchia, 15  
I - 33077 Sacile (PN)  
Italy  
Tel. : 39. 434 7239  
Fax : 39. 434 734 764

Sicab S.A.  
Route d'Arras, 215  
F-62320 Bois Bernard  
France  
Tel. : 33. 21 20 10 21  
Fax : 33. 21 75 82 95

**CARMEUSE**  
CHIMIE MINÉRALE

## GENERAL EQUIPMENT AND PROCESSES

Milwaukee, WI, 53217, USA, Tel: +1-414-332-8440. Complete water treatment programs for heating and cooling equipment.

**ALLTECH NV** Provenseweg 64, Poperinge, 8970, Belgium, Tel: +32-57-337201, Fax: +32-57-334732, Contact: Mr Xavier Allaey. Alltech N V is a Belgian workshop specialized in general steel constructions and machinery for water treatment installations. Construction on customer plan and engineering and development as well.

**AMAFILTER** 28 Kwakal Kede, CL, 1823, The Netherlands, Tel: +31-72-15-2414, Telex: +57291, Fax: +31-72-12-5207. Fluid filtration and gas filtration - apart from air mainly in the chemical and food industries. Cartridge filters, back filters, pre-coat filters and self cleaning strainers.

**AMETEK/PLYMOUTH PRODUCTS DIVISION** 502 Indiana Avenue, Sheboygan, WI, 53082-1047, USA, Tel: +1-414-457-9435. Manufactures a very broad line of cartridge filtration equipment for domestic, commercial and industrial use. Filter housings are available in various plastic materials as well as stainless steel, and vary in size from a small ice maker filter to large multiple cartridge units. (WT)

**ANDRITZ-RUTHNER INDUSTRIEANLAGEN AG** A-1121 Wien, POB 84, , Austria, Tel: +43-1-8395010, Telex: 1-31273. Andritz-Ruthner Industrieanlagen AG turn out plants for the steel and chemical industries, disposing of up to 95 per cent of production abroad. Please contact direct for further details.

**APV CHEMICAL MACHINERY** Glenburn Rd, College Milton North, Glasgow, East Kilbride, G74 5BJ, UK, Tel: +44-3552-25461, Telex: 777755 APVOC, Fax: +44-3552-63496, Contact: David Reid. Designers and manufacturers of all types of fluid mixing equipment. Also canned, glandless, leakproof pumps, ceramic lined pumps, metering pumps and dosing sets.

**AQUA CONTROL INC** 320 Lasalle Rd, Lasalle, IL, 61301, USA, Tel: +1-815-223-6303, Contact: Willis Dane. Aqua control makes a variety of aerators and decorative fountains which can improve conditions of many lakes. Units of 1/2 to 3 Hp, in several voltages and in single and 3-phase are available. They are light and easy to install and offer lake owners an economical opportunity to improve their lakes.

**AQUA PROCESS ENGINEERING LTD** Aqua House, 27 Denison Rd, London, SW19 2DJ, UK, Tel: +44-1-543-3647/8, Telex: 915089 Aqua G, Contact: Mr Clave. Engineers in potable water treatment. Specialists in pressure filtration plant refurbishment and site installation.

**AQUA SYSTEMS/EXPORT MANAGEMENT INTERNATIONAL INC** 220E Madison St, Suite 1010, Tampa, FL, 33602, USA, Tel: +1-813-229-7744, Telex: 756211 AQUA UD, Fax: +1-813-229-7157, Contact: Nancy Bunn. Aqua Systems specializes in exporting industrial water-related products (pipes, valves, fittings, water pumps and water treatment equipment) to engineers, contrac-

tors, distributors and national water authorities. We ship direct to your job site.

**AQUA TECH** Ferdinand Porsche Strasse 1, Salzburg, 85020, Austria, Tel: +43-662-77130, Telex: 632618, Fax: +43-662-7713077, Contact: Mr Aberger. Aqua Tech design and manufacture small treatment plants for drinking water, process water and waste water.

**AQUA-GUARD INC** 1119 Beck Avenue, Panama City, FL, 32401, USA, Tel: +1-904-763-4681. Manufacture complete line of fully automatic water treatment and purification equipment for residential and commercial applications.

**AQUAPUR BV** Nottenbootsterstraat 1 Postbus 336, Vlaardingen, 3130 AH, The Netherlands, Tel: +31-10-435-3711/10-435-3622, Telex: 25452, Fax: +31-10-435-0433, Contact: Mr Looman. Aquapur BV, a well known Dutch company in the field of water treatment, supplies a wide range of equipment for the industry, including small drinking water plants demineralisation plants, softening plants, reverse osmosis plants, filtration plants etc. The trade-department of Aquapur is the exclusive distributor for HACH-water analysis equipment, LUTZ-barrelpumps, CFG-prominent dosing pumps and supplies all kind of filters, ion exchange resins and filter fillings. Please contact direct for further details.

**AQUARIUS WATER PURIFICATION LTD** 216-219 Cotton Exchange Building, Old Hall Street, Liverpool, L3 9LA, UK Tel: +0512362208, Telex: +MICMAN 667719, Fax: +0512368124. The AQUARIUS 150 is capable of turning dirty water into clean pure drinking water at the rate of 150 gallons per hour. It will purify through controlled chlorination and remove all dirt, debris, bad taste and smell. Ancillary units will correct pH to safe levels and remove excess iron and other excess minerals. Manufactured in uPVC, small in size and virtually maintenance free the AQUARIUS 150 is suitable for us in a variety of situations including Country Villages, Office/Hotels, Re-cycling Waste Water and relief work. Whatever your water purification problem the AQUARIUS 150 is the answer.

**AQUASTAT** Silverdale Rd, Hayes, Middlesex, UB3 3BB, UK, Tel: +44-1-848-8811, Fax: +44-1-756-0841, Contact: Sue Hudson. Suppliers of water purification equipment and chemicals. Scale and corrosion prevention and water treatment plant.

**AQUATIC TECHNOLOGY INC** P O Box 479, McLean, VA, 22101, USA, Tel: +1-703-893-1211. Designs and services complete water treatment systems for industrial, commercial and residential applications. Pre-packaged cooling water treatment systems are sized from 50 ton to 100,000 ton units. (WT)

**N V AQUAVIA S A** Vosselarestraat 73, Nevele, B-9840, Belgium, Tel: +32-91-71-71-71, Telex: +11477, Fax: +91-71-71-80. Manufacture flotation, filtration (diatomite and sand) and aeration systems. Also install and design, if necessary, mechanical and chemical treatment systems, potable, swimming pool, industrial and municipal treatment.

## GENERAL EQUIPMENT AND PROCESSES

**ARLAT TECHNOLOGY INC** 150 East Drive, Bramalea, Ontario, L6T 1C1, Canada, Tel: +1-416-458-8220, Fax: +1-416-458-8224, Contact: R Larry Madden. Arlat Technology Inc is a Canadian based manufacturer and representative of engineered process equipment for the water and wastewater treatment market. Arlat Technology Inc offers complete engineering and design capabilities along with products such as ultraviolet disinfection systems, ozonation equipment, plate settlers, clarifier mechanisms and static mixers.

**ARMFIBRE LTD** Shortmead St, Biggleswade, Beds, SG18 0BB, UK, Tel: +44-767-312619, Telex: +826322. Manufacture GRP plant components for sewerage and water treatment plants and supply odour control systems. Also manufacture standard ventilation and odour control equipment, based on activated carbon, together with tank covers and other related equipment. Supply a patented by-pass oil/petrol interceptor and conventional single and multi-chamber interceptors.

**ARROWHEAD INDUSTRIAL WATER** 2375 Sanders Rd Northbrook IL 60062 Tel: USA, Fax: +1-312-498-2858. High purity water service company that designs, builds, owns, operates and services high purity water systems.

**ASTRO-PURE WATER PURIFIERS** 4900 NW 15th St, Margate, FL, 33063, Tel: USA, Telex: +1-305-971-9680, Fax: A, Contact: R L Stefl.

**ATLANTIC FILTER CORPORATION** 3112 45th St F9 West Palm Beach, FL, 33409, USA, +1-305-683-0101, Fax: 704553, Contact: Peter Wareham. Manufacturer and distributor of a complete line of water treatment and purification equipment. Reverse-osmosis a speciality. In business 32 years, giving professional advice. Member of the water quality association.

**AUTOTROL FRANCE S A** 167 Rue St Merry, Fontainebleau, 77300, France, Tel: +33-1-64-22-12-98, Telex: 690249, Fax: +33-1-64-226166, Contact: Mr Sanderson. Autotrol France S A distributes components for the water treatment industry, comprising multiport valves for domestic and industrial softeners, filter controls, deionisation equipment and chemical proportional feeders.

**AWE LTD** Cardiff Workshops, Lewis Rd, Cardiff, CF1 5EG, UK, Tel: +44-222-492848, Telex: 497810, Fax: +44-222-491369, Contact: Mr Carney. Consultants, designers and manufacturers of all types of water purification equipment including, clarification, filtration, demineralisation, reverse osmosis, softening and sterilisation.

**B & L CONTROL SERVICE INC** P O Box 399, Saratoga Springs, NY, 12866, USA. Water treatment consultants and manufacturers of treatment products.

**BADGER METER INC** Box 23099, 4545 W Brown Deer Rd, Milwaukee, WI, 53223-0099, USA, Tel: +1-414-355-0400. Manufacturer of flow meters and systems for flow measurement and control used in water conditioning and water treatment applications. (WT)

**BEACON WATER EQUIPMENT CO INC** P O Box

487, Binghamton, NY, 13902, USA, Tel: +1-607-648-5248. Manufacture and sales of complete line of water treatment equipment. Manufacture water conditioning equipment commercial and domestic. Est 1950.

**BECKEL-EDELSTAHL** P O BOX 97, Bad Isch 97, A-4820, Austria, Tel: +43-6132-33-77-0, Telex: 68138. Beckel-Edelstahl supplies stainless steel equipment for water supply and sewage disposal. The line-up embraces: components for tanks, eg pressure doors, feed and delivery pipes (to give uniform spiral or parallel flow), extraction turbines, pipe fittings, etc.

**BENCKISER-KNAPSACK GmbH** Dr.-Albert-Remann-Str. 2 D-6802 Ladenburg Bundesrepublik Deutschland Tel: +49-6203/774289 Fax: +49-620312818. Product systems for water treatment - for drinking water, cooling water, boiler water, autoclave water, waste water and sea water.

**BERGSOE ANTI CORROSION (BAC) AB** Box 214, Landskrona, S-261 23, Sweden, Tel: +46-418-161-65, Fax: +46-418-27722, Contact: Jan Persson. B A C supply and install pipelines and storage tanks - structures in soil and water, also cables, piles and sheet piling, as well as water towers and water treatment plants.

**BESTECH INC** 442 S Dixie Highway East, Pompano Beach, FL, 33060, USA, Tel: +1-305-785-4550. Manufactures silver impregnated activated carbon and point-of-use water treatment systems. Has a full line of EPA-registered silver carbon with several levels of silver content - .026 per cent, .20 per cent, .50 per cent and 1.05 per cent metallic silver. (WT)

**BETZ ENTEC INC** 508 Prudential Rd, Horsham, PA, 19044, USA, Tel: +1-215-674-9200. Specializes in water treatment products and services for boiler, cooling and air conditioning systems.

**BIO TREATMENT LTD** 5 Chiltern Close, Cardiff Industrial Park, Cardiff, CF4 5DL, UK, Tel: +44-222-766-802, Telex: 497244, Fax: +44-222-766945, Contact: Dr John Rees. Service based company offering services in the treatment and reclamation of surface and sub-surface contaminated land, the treatment of ground waters and solid and liquid industrial arisings through the application of biological and chemical engineering.

**BIOMECHANICS ENVIRONMENTAL LTD** 1 Station Rd, Four Ashes, Wolverhampton, WV10 7DQ, UK, Tel: +44-902-791616, Telex: +335684, Fax: +44-902-791772. Specialise in the design, supply, installation and commissioning of plants for waste and water purification and for the treatment of toxic and non-toxic waste embracing the latest technology. Please contact direct for further details.

**BOLIDEN WATER TREATMENT** P O Box 902, Helsingborg, S25109, Sweden, Tel: +46-42-171000, Telex: 72185 BOLIDVS, Contact: Mrs Linkvist. Produce aluminium sulphate for drinking water and AVR for sewage. Also supply equipment for sewage water treatment plants and drinking water.

**BRASWELL WATER QUALITY SYSTEMS INC** 839 S

## GENERAL EQUIPMENT AND PROCESSES

Kingshighway, Cape Girardeau, MO, 63701, USA, Tel: +1-314-334-8873. Manufacturer of water conditioning equipment. Braswell system features meter-initiated counter-current regeneration, one-piece solid state panel, control valve with one internal moving part and 100% pure brine regeneration.

**BRITE-TECH CORPORATION SDN BHD** 12, Jalan 27a, Kawasan 16, SG Rasa Industrial Area, Klang, Selangor Darul Ehsan, 41300, Malaysia, Tel: +60-3-34289883-3424034/5, Fax: +60-3-3424033, Contact: Pang Wee See. Brite-Tech has been established as a company which specialises in total water management. The company provides a complete range of services and products in the field of water treatment, pollution control, process additives and fuel treatment. Its motto is "make water treatment part of productivity."

**CAMA F MAYER KG** PO Box 1154, Taunusstein 1, 6204, West Germany, Tel: +49-6128-3031, Fax: +49-16-108-3035, Contact: Dr Bingel. Supplies of water softening plant, drinking water treatment plant and equipment for demineralisation and desalination of water.

**CAPITAL WATER SOFTENER INC** 2096 Helena St, Madison, WI, 53704, USA, Tel: +1-608-241-1511. Water conditioning and filtering equipment domestic-commercial-industrial.

**CAREY SALT - DIV OF PMI** 1800 Carey Boulevard, Hutchinson, KS, 67504, USA. Manufacturer of water conditioning salt products.

**CARTER INDUSTRIAL PRODUCTS LTD** Bedford Rd, Birmingham, W Midlands, B11 1AY, UK, Tel: +44-21-772-4300, Telex: 339219, Fax: +44-21-772-3672. Manufacturers of industrial water cooling towers, water purification and effluent treatment plants.

**CHILTERN WATER TREATMENT CO** Treadaway Tech Centre, Treadaway Hill, Loudwater, High Wycombe, Bucks, HP10 9RS, UK, Tel: +44-6825-27773, Telex: 837139, Fax: +44-494-465489, Contact: Mr David Moreau. Manufacturers and suppliers of a range of packaged water treatment plant and designers and installers of water treatment equipment.

**CLEARWATER SYSTEMS** Riverway Estate, Portsmouth Rd, Guildford, GU3 1LZ, UK, Tel: +44-483-33831, Telex: 859-356, Fax: +44-483-34888, Contact: Richard Jerrard. Clearwater Systems produce water, wastewater and sewerage treatment systems. Our standard products include packaged sewage treatment plants and packaged potable water treatment plants. Exporting to over 30 countries for simple installation on site.

**ALAN COBHAM ENGINEERING LTD** Holland Way, Blanford Forum, Dorset, DT11 7BJ, UK, Tel: +44-258-51441, Telex: 417254, Fax: +44-258-51414, Contact: Gordon Day. Design and manufacture of liquid level control equipment: float switches, flow switches, level indicators and control valves. Also manufacture filtration equipment.

**COMMERCIAL FILTERS** 1515 W South St, Lebanon,

IN, 46052, USA, Tel: +1-317-482-3900, Fax: +1-317-482-8410, Contact: Mr Westly. Commercial Filters Division of Parker Hannifin Corporation, produces industrial filtration products for both industrial and consumer use. We are one of the major producers of water filtration equipment.

**CRYSTAL FLUID FILTER CO** 865 Grand Boulevard, Westbury, NY, 11590, USA, Tel: +1-516-333-6768. Sediment and odour removal filters, 3 gals to 167 gals per minute. Existing water pressure usually operates units, but pumps can be inserted. Constructed of plastic or SS filter media cartridges.

**CRYSTALAB INC** 612 Capitol Avenue, Hartford, CT, 06106, USA, Tel: +1-203-951-3215. Manufacturers of demineralizing equipment-regeneration of bulk ion exchange resins. Distributor of ion exchange resin.

**CULLIGAN INTERNATIONAL CO** Blenheim Rd, Cressex Industrial Estate, High Wycombe, Bucks, HP12 3RS, UK, Tel: +44-494-36-484, Telex: 83-146, Fax: +44-494-23833, Contact: Mr William. Water may be available - but is not always safe to drink. Culligan, the world's largest supplier of water treatment equipment, can solve your water problems.

**CULLIGAN INTERNATIONAL CO** 1 Culligan Parkway, Northbrook, IL, 60062, USA, Tel: +1-312-498-2000. Manufacture water conditioning equipment for household, commercial, industrial, including demineralization, cooling tower treatment and reverse osmosis purification.

**CUNO INC** 400 Research Parkway, Meriden, CT, 06450, USA, Tel: +1-203-237-5541, Telex: 221083, Fax: +1-203-238-8716, Contact: Martin Mahard. Cuno Process Filtration manufactures general filtration and microfiltration products for the chemical, pharmaceutical, cosmetic, food and beverage, automotive and electronic industries.

**CX/OXYTECH** 208 Beaver St, Yorkville, IL, 60560, USA, Tel: +1-312-553-0668. Ozone generators and systems for distribution and injection-diffusion into water for removal of bacteria and metals. Please contact direct for further details.

**DACAR CHEMICAL CO** 1007 McCartney St, Pittsburgh, PA, 15220, USA, Tel: +1-412-921-3620. Manufacturer of water treatments for boilers, cooling towers, closed systems and equipment for feeding and testing.

**DARCHET ENGRG & WATER TREATMENT PTE LTD** Blk 1001 Kim Chuan Light Industries Park, #01-2530 Hougang Avenue 1, 1953, Singapore, Tel: +65-3-2883566, Fax: +65-2841984, Contact: Alfred Lee. We specialise in water and waste water treatment and offer a total system approach: ultrapure water system, industrial waste/recycling system, package sewage treatment plant, package chemical injection plant, reverse osmosis desalination, package potable

**DEGREMONT LAING LTD** Page St, London, NW7 2ER, UK, Tel: +44-1-959-3636, Telex: 8958741, Fax: +44-1-906-5164, Contact: Julie Mitchell. Complete range of



## GENERAL EQUIPMENT AND PROCESSES

municipal/industrial water and waste treatment plant. Processes include: pulsator clarifiers, Aquazur filters, dissolved air flotation, ozone generation - sludge dewatering, desalination plants, turnkey contracts, pressure filters, biological treatment.

**DELTA ENGINEERING BV** P O Box 227, Vlaardingen, 3130 AE, The Netherlands, Tel: +31-10-46-00-000, Telex: 24536, Fax: +31-10-46-00-898, Contact: Mr Verwey. Designers and contractors for complete water treatment installations.

**DELTA PURE FILTRATION CORP** 305 S Richardson Rd, Ashland, VA, 23005, USA, Tel: +1-804-798-2888. Manufacturer of a complete line of a high quality wound cartridge filters for sediment removal. Currently being used nationwide in a variety of commercial and industrial water applications.

**DR BRUNO LANGE GMBH** Willstaetter 11, Dusseldorf 99, 4000, W Germany, Tel: +49-211-503-061, Telex: 8588757, Fax: +49-211-500-97143, Contact: Mr Waters. Dr Bruno Lange GmbH is one of Europe's leading producers of photometers and reagents for waste water, drinking water and quality controls.

**DU-MOR SOFT WATER CO** 23737 U S 33, Elkhart, IN, 46517, USA, Tel: +1-219-875-8596. Water conditioning equipment assembly, wholesale and retail.

**DURABLE MANUFACTURING CO** 232 S Evergreen St, Bensenville, IL, 60106, USA, Tel: +1-312-766-0398. Manufacture depth wound polypropylene water filter cartridges in all sizes and packaged with your label or ours.

**THE DYMAX GROUP INC** P O Box 57, Pleasanton, CA, 94566, USA, Tel: +1-415-463-1888. Manufacturers agents/distributors-liquid handling equipment, including filters, conditioners and minerals.

**DYNAMIC INDUSTRIES & DEVELOPMENT INC** 2921 N 84th St, Omaha, NE, 68134, USA, Tel: +402-571-6820. Designs and manufactures broad line of filtration, purification and conditioning equipment for domestic, commercial and industrial use. Some of the latest, most advanced equipment and technology for specialized water treatment. (WT)

**E L C WATER TREATMENT CO** 7603-A Blueberry Lane, Powell, IN, 37849, USA, Tel: +1-615-947-3601. Manufactures RKK multi filters developed for water needs such as removal of chemicals, organics, chlorine, pesticides, detergents and undissolved particles (sediment discoloration. )Bacteria growth inhibitor, dependable service and reasonably priced. (WT)

**E W C SUPPLY COMPANY** 3233 S Main St, Elkhart, IN, 46514, USA. Specializing in sales of QEST polybutylene plumbing materials exclusively to the water conditioning industry.

**EBARA CORPORATION** 11-1 Haneda Asahicho, Ohta-Ku, Tokyo, 144, Japan, Tel: +81-3-743-67-16 London: +44-1-892-8971, Telex: EBARATYO J 22988, Fax: +81-3-745-3576 London: +44-1-891-6730, Contact: Mr RD Jones.

London Office: Regal House, London Rd, Twickenham, Middlesex Tw1 3QS Pollution control and environmental protection, cleansing potable water.

**EBCO MANUFACTURING CO** 265 N Hamilton Rd, Columbus, OH, 43213, USA, Tel: +1-614-861-1350. Manufacture water coolers, fountains and chillers.

**ECODYNE CORP** P O Box 64420, St Paul, MN, 55164, USA, Tel: +1-612-739-5330. Products include water softeners, refiners, filters, drinking water systems, chemicals and compounds, diaphragm, piston and peristaltic solution feeders, deionization plants and custom units. (WT)

**EDEN EQUIPMENT CO** 17649 Jacquelyn Lane, Huntington Beach, CA, 92647, USA, Tel: +1-714-842-8181. Filter supplies and equipment. (WT)

**EMCO ENGINEERING INC** 25 North St, Canton, MA, 02021, USA, Tel: +1-617-828-7340, Telex: 924326, Fax: +1-617-828-1714, Contact: Charvel Bechir. The Emco group of companies is an international organisation incorporated in the state of Massachusetts, in 1974, specialising in the manufacture of water and waste treatment equipment, including: reverse osmosis, brackish and sea-water desalting plants, ultrafiltration systems, sewage treatment systems, water softeners, reclamation systems, deionization lime treatment, swimming pool equipment and water storage tanks.

**EMERY CHEMICALS, OZONE TECHNOLOGY GROUP** 4900 Este Avenue, Cincinnati, OH, 45232, USA, Tel: +1-513-482-2100. Manufactures ozone generation systems for potable water and wastewater treatment, odor control and chemical synthesis in industrial and municipal applications.

**ENTING WATER CONDITIONING INC** Box 5463211 Dryden Rd, Dayton, OH, 45449, Tel: USA, Contact: . Manufacture, assembly and distribution of POE, POU water conditioning products for residential, commercial and industrial use.

**ENVIROGARD PRODUCTS LIMITED** P O Box 64, 301 Major Mackenzie Drive, Richmond Hill, Ont, L4C 4X9, Canada, Tel: +1-416-884-9388, Telex: 06986766, Fax: +1-416-884-8296, Contact: Scott McDonald. Manufacturer of in-line water filter and sterilizers for domestic or commercial application. Units employ disposable or cleanable/reusable cartridge. Branded or private label available.

**ENVIRONMENTAL ELEMENTS CORP** Box 1318, Baltimore, MD, 21203, USA, Tel: +1-301-368-7272. Low headless rapid gravity sand filters for removal of suspended solids and turbidity from water and waste water.

**F F LUFT A/S** M Svendsens Vej 2, Bjerringbro, DK-8850, Denmark, Tel: +4586-68-18-00, Fax: +4586-68-03-04, Contact: Arne K Pedersen. Established 1919. Having manufactured engines for 40 years, and piston air compressors for over 30 years, F F Luft a/s has the know-how needed when it comes to being a leading manufacturer of high quality compressors. Export to most European countries, Middle East and Africa.

## GENERAL EQUIPMENT AND PROCESSES

**FACTAIR LTD** Dobbs Lane, Kesgrave, Ipswich, Suffolk, IP5 7QQ, UK, Tel: +44-473-622701, Telex: 98523, Contact: D J Wyllie. Factair Ltd manufactures compressed-air filtration/regulation units for injecting pure air into water mains to remove loose deposits. This system has proved more efficient than swabbing or flushing.

**FASTEK - A KODAK COMPANY** 7120 Henry Clay Boulevard, Liverpool, NY, 13088, USA, Tel: +1-315-451-0592. Committed to research in both filtration and separation technology. Product line includes reverse osmosis membrane elements, disposable cartridge filters for liquids and gases, in-line ceramic filters for specialty gases and microparticle spheres for filters testing. (WT)

**FILTERCOLD CORP INC** 1840 E University #2, Tempe, AZ, 85281, USA, Tel: +1-602-894-2941, Fax: +1-602-894-5485. Manufactures water filtration, concentrating on carbon filtration.

**FILTERITE** 5 W Aylesbury Rd, Timonium, MD, 21093, USA, Tel: +1-301-252-0800 Ext 6053. Manufactures a full line of residential and light commercial water filtration products to remove sediment, dirt and rust, unpleasant tastes and odors, and chemical contaminants as well as replacement cartridges for all major brands of filters. (WT)

**FILTRINE MFG CO** Main St, Harrisville, NH, 03450, USA, Tel: +1-603-827-3321. Manufactures water filters, fountains and coolers for process and drinking water applications. (WT)

**FILTROS PLANT, FERRO CORP** 603 W Commercial St, East Rochester, NY, 14445, USA, Tel: +1-716-586-8770. Manufacturer of porous ceramic products for water and wastewater applications. Specifically diffusers and filters.

**FLUID MECHANICS INC** PO Box 1215, Lafayette, IN, 47901, U S A, Tel: +1-317-742-2338. Manufacturer of no-salt, chemical-free water treatment products for residential and commercial applications. Water conditioner offers water conditioning dealers an alternative softening method to the ion-exchange system. (WT)

**FOSPUR LTD** Alfreton Industrial Estate, Somercotes, Derbyshire, DE55 4LR, UK, Tel: +44-773-604321/6, Telex: 377150, Fax: 44-773-606901, Contact: Mr Coleman. Manufacture and supply water treatment chemicals and equipment. Specialists in all forms of water and effluent treatment in industrial and domestic fields.

**FRAM CORP - GENERAL PRODUCTS DIV** 135 Zene St, Henderson, NC, 27536, USA. Manufacture water filters.

**FRANKLIN HODGE INDUSTRIES LTD** Ramsden Rd, Rotherwas Industrial Estate, Hereford, HR2 6LR, UK, Tel: +44-432-269605, Telex: 35593, Fax: +44-432-277454. Franklin Hodge Industries supply high quality, reliable, economic water storage tanks, which require minimal long term maintenance. Franklin Hodge tanks

have particular relevance to the storage of processed water, with no harmful or potentially polluting

**GELMAN SCIENCES INC** 600 S Wagner Rd, Ann Arbor, MI, 48106, USA, Tel: +1-313-665-0651. Manufacturer of depth and membrane filters. Offer cartridge filters, capsules, devices and housings for high purity (30 um to 0.1 um) liquids and gases.

**GENERAL RESOURCE CORPORATION** 201 3rd St South, Hopkins, Minnesota, 55343, USA, Tel: +1-612-933-7474, Telex: 290383, Fax: +1-612-933-9777, Contact: Mr Jerome Lapham. Manufacturers of complete hydrated lime or pebble-quick lime systems including storage silos. A complete line of pneumatic conveying systems and components.

**GRAVER WATER INTERNATIONAL** 2720 US Highway 22, Union, NJ, 07083, USA, Tel: +1-201-964-2554, Telex: 6853093, Fax: +1-201-964-7770, Contact: Mr Iiman. Graver designs and manufactures a complete line of water and waste treatment equipment to fit the needs of industrial corporation and electric generating utilities.

**GREAT LAKES INTERNATIONAL** 1905 Kearney Avenue, Racine, WI, 53403, USA, Tel: +1-414-634-2386, Telex: 262043, Fax: +1-414-634-6259, Contact: Anne Mulready. Full line supplier and manufacturer of RO systems, water chillers, inline filters and water processing systems. Also manufacture and market complete line of plastic components, tubing, pipe and other related accessories.

**GREAT SALT LAKE MINERALS & CHEMICALS CORP** PO Box 1190, Ogden, UT, 84402, USA. Manufacture solar water conditioning salt in x-coarse, pellets and blocks.

**GW PLASTICS INC** Pleasant St, Bethel, VT, 05032, USA, Tel: +1-802-234-9941. Manufacture custom injection molding/supplying center cores for cartridge filters.

**HAGUE HYDRO-CLEAN** 4343 S Hamilton Rd, Groveport, OH, 43125, USA, Tel: +1-614-836-2195. Manufacturer of the Hydro-Clean System, which includes a full line of water conditioning and filtering equipment using the exclusive Hague Gold Crown Valve. Also manufactures distillers, reverse osmosis systems and the micro-carbon filters. (WT)

**HALCO PRODUCTS** 100 N Gordon, Elk Grove, IL, 60007-1193, USA, Tel: +1-312-956-1600. Manufacture under-sink RO units as well as design and build total package ultrapure water systems. Total package RO units and UF for special applications available.

**HANNA INSTRUMENTS** 584 Park East Drive, Woonsocket, RI, 02895, USA, Tel: +1-401-765-7500. Manufacture testing, controlling, correcting equipment for water treatment and waste water industries.

**HANS ASCHENBRENNER** A-2500 Baden, Erzherzog-Wilhelm-Ring 21, Austria, Tel: +43-2252-89-1-70/80-15-13. By physical means the Kwabi water conditioner

## GENERAL EQUIPMENT AND PROCESSES

prevents furring in pipes, boilers, washing machines etc. No chemical additives are necessary and water thus retains its natural freshness. Of compact design, the device can be easily inserted in the water main. This method of water treatment saves money on energy.

**HARMSCO INDUSTRIAL FILTERS** P O Box 14066, North Palm Beach, FL, 33408, USA, Tel: +1-407-848-9628, Fax: +1-407-845-2474. Harmsco Inc has been in business 35 years, producing stainless steel filter housings and pleated filter cartridges for the water industry. All products comply with FDA and NSF requirements.

**HARVESTER STAINLESS LTD** The Avenue, Rubury, Birmingham, B45 9AG, UK, Tel: +44-21-453-6111, Telex: 339-190, Fax: +44-21-453-8435, Contact: Mr Comerford. Major manufacturers and suppliers of all stainless steel tubular and flat roll products, inclusive of specialized grades for the water and water treatment industry.

**HESONWERK** A-4655 Vorchdorf, Pettenbacher Strasse 66, Austria, Tel: +43-7614/8301, Telex: 24466. Apart from turning out various steel and plastic articles Hesonwerk specialize in the planning, production and installation of water treatment and waste water purification and recycling plants.

**HETHON INTERNATIONAL BV** P O Box 40, Barchemseweg 40, Ruurlo, 7260 AA, The Netherlands, Tel: +31-5735-1350, Fax: +31-5735-2866, Contact: Mr Hamers. Hethon International, NL. represents manufacturers of fluid and solid handling equipment as GRI, Accurate, Spiroflow, Duff Norton, Gorman Rupp etc. Hethon is specialized in combining products into complete systems for fluid and/or solid handling.

**HILMAR BECKER GESELLSCHAFT mbH & CO KG** A-4020 Linz, Franzosenhausweg 50, , Austria, Tel: +43-732/83-0-01, Telex: 021507 becker a. The sphere of operations of Hilmar Becker comprises the production, servicing and sale of water treatment plants and heating, ventilating and air conditioning equipment. The HB production shops turn out filtering, de-ironing, deacidifying and softening plants, and plants for partial and full desalination and for reverse osmosis.

**HOH WATER TECHNOLOGY CORP** 3481 Old Conejo Rd Ste 103, Newbury Park, CA, 91320, USA, Tel: +1-805-499-0507. Manufacture and market patented new water treatment device which softens and decontaminates polluted water in a single pass without salt, acids, holding tank or booster pump. Residential market, point-of-entry installation.

**JACK HOLT & ASSOCIATES** Odessa, TX, 79762, USA, +1-915-366-5295. Specialized in the BYOB drinking water connection, design RO systems (from 200-10,000 gpd) pre-treatment, storage tanks, delivery and post-treatment equipment. Complete water store, the design, construction and marketing services.

**HUDSON CORP OF TEXAS** 01 Newell St, San Antonio, TX, 78212, USA, Tel: +1-512-226-3196. Manufacture water treating equipment.

**HUNGERFORD AND TERRY INC** PO Box 45, Clay-

ton, NJ, 08312, USA, Tel: +1-609-881-3200, Telex: 510-686-6580, Fax: +1-609-881-6859, Contact: Ken Sayell. Manufacturer of water treatment equipment for commercial and industrial applications including pressure filters, softeners, ion remove filters and special application ion exchange.

**HOWARD E HUTCHING CO INC** PO Box 249, 7190 Penryn Plaza, Penryn, CA, 95663, USA, Tel: +1-916-663-1371. Manufactures chemical meter equipment, proportional feed systems and systems design. Water and waste water treatment. (WT)

**HUTTER & SCHRANTZ AKTIENGESELLSCHAFT** Grossmarkstrasse 7, Wien, A-1232, Austria, Tel: +43-222/67-75-11, Telex: 132420 husch a. H & S filter elements are used mainly in solid/liquid and solid/gas separation. The materials used are technical fabrics - of metal wire or synthetic monofilaments and multifilaments - and/or perforated sheets. By various mechanical shaping methods and injection moulding the said filter materials are turned into filter elements differing in form according to the problem to be solved or to customers' drawings.

**HYDRO INSTRUMENTS INC** P O Box 615, Quakertown, PA, 18951, USA, Tel: +1-215-538-1367, Fax: +6711643 HYDROUW, Contact: John Scalets. Hydro Instruments Inc manufactures the world's most rugged and durable gas chlorinator. The body and parts are machined from solid material, not injection moulded. Capacities range from 4 - 500 lbs per day.

**HYDRO-MASTER PARTS CO INC** 27 Stone Hill Rd, Oswego, IL, 60543, USA, Tel: +1-312-554-9192. Provide water treatment industry with custom options for their slotted riser, lateral needs and other plastic parts for OEM requirements.

**HYDRO-MAX CORP DIV RAYTEC WATERGROUP** 500 W Oklahoma Avenue, Milwaukee, WI, 53207, USA, Tel: +1-414-747-3700. Manufacture water treatment equipment for domestic, commercial and industrial applications, specializing in industrial.

**HYDRO-PURE INC** 1001 E Shaw, Pasadena, TX, 77506, USA, Tel: +1-713-477-2538. Distillation equipment.

**HYDROFLO INC** 15 W Aylesbury Rd, Timonium, MD, 21093, USA, Tel: +1-301-561-4423. Manufactures a complete line of residential, commercial and industrial water treatment products. Patents pending on the NFA15 automatic neutralizer and Maryland State Health Department approved NSR844MP automatic household nitrate removal unit.

**HYDROMATION BELGIUM** P O Box 99, 3700 Tongeren, , Belgium, Tel: +32-12-233361, Telex: 39118, Fax: +32-12-238992, Contact: Mr A S Creten. Hydromation Belgium manufacture and install water filtration equipment.

**HYDROTECH CHEMICAL CORPORATION** P O Box 6549, Marietta, GA, 30065, USA, Tel: +1-404-952-2581, Fax: +1-404-953-2109, Contact: Douglas H Freeland. Hydrotech is a full line manufacturer of specialty chemi-

## GENERAL EQUIPMENT AND PROCESSES

cals and equipment for the swimming pool and spa/hot tub industry. Chemical products, which include both the Hydrotech and Guardex brand names, consist of chlorine and bromine disinfectants as well as water balancing and other specialty products. Equipment products consist of pumps, filters, heaters, lights and valves in the Purex name.

**HYDROTECH ENTERPRISES INC** P O Box 142, 3036 N Lake Terrace, Glenview, IL, 60025-0142, USA, Tel: +1-312-998-6900. Manufacturer and wholesaler of a complete line of water treatment equipment and supplies for industrial, medical, pharmaceutical, laboratory, commercial and residential applications. (WT)

**HYDROTECHNIK GESELLSCHAFT mbH** A-5033 Salzburg, Alpenstrasse 54, POB 14, Austria, Tel: +43-662/22-4-72, Telex: 633821 hydro a. The company's line-up includes the planning, production, installation and sale of water treatment plants, reverse osmosis, desalination and water supply facilities and waste water purifying plants for industrial and municipal use. Hydrotechnik turn out turnkey water treatment plants with the cooperation of experienced building firms, or supply merely the necessary mechanical and electrical equipment.

**HYTREX FILTER DIV OSMONICS INC** 5951 Clearwater Dr, Minnetonka, MN, 55343, USA, Tel: +1-612-933-2277. Manufactures extensive line of high quality filtration products and disposables.

**IDEAL HORIZONS INC** PO Box 1707, Rutland, Vermont 05701 1707 USA Tel: +1-802-773-4346, Fax: +1-802-773-2538. Ideal Horizons manufacture stainless steel ultra-violet disinfection equipment. Our modular systems allow for versatility over a wide range of applications and flow rates. These systems are engineered for durability and performance.

**ILLINOIS WATER TREATMENT CO** 4669 Shepherd Trail, Rockford, IL, 61103, USA, Tel: +1-815-877-3041. Water treatment equipment manufacturer.

**IMB** Mathias-Brüggen Strasse 17, Cologne 30, Biken-dorf, D-5000, West Germany, Tel: +49-221-580-40, Fax: +49-221-5880488. IMB have been building plant since they were founded over 20 years ago. The company provides waste water purification by various filtration and make up systems.

**INAQUA ENTERPRISES INC** 6265 E Sawgrass Rd, Sarasota, FL, 34240, USA, Tel: +1-813-377-1889, Contact: Bill Ravey. Manufacturer of commercial industrial and residential water treatment equipment. Also a major distributor of component parts.

**INDUSTRIAL FILTER & PUMP MFG CO** 5900 Ogden Avenue, Cicero, IL, 60650, USA, Tel: +1-312-656-7800. Manufacturer of filters, demineralizers and pumps used in water treatment industry.

**ING HARTWIG KARRER GROSSBANLAGEN - UND APPARATEBAU** Gewerbestrasse 7, Uttendorf, asse 7, A-5261, Tel: Austria, Fax: +43-7724-6292. 27468 karrer a Karrer plan, produce, install and service: plants

for the treatment of surface water (river and reservoir water) for drinking. Full desalination plants (reverse osmosis and/or ion exchange, for hospitals of dialysis quality). Fermentation gas plants for solid waste utilisation (agriculture, abattoirs etc) and waste water purification by a patented process.

**INTERATOM** Friedrich-Ebert-Strasse, Bergisch, Gladbach, 5060, West Germany, Tel: +49-2204-840, Telex: 08874457, Fax: +49-2204-840207, Contact: Renata Cruz. Complete works for production of drinking or industrial water:- water treatment plant, desalination plant, super filtration in closed water circuits, supplementary modules for existing systems, analysis and monitoring etc.

**INTERMATIC INC** Intermatic Plaza, Spring Grove, IL, 60081, USA, Tel: +1-815-675-2321. Manufacture timers, electronic and electromechanical for water treatment.

**INTERNATIONAL WATER SYSTEMS** 1069 Evans Avenue, Akron, OH, 44305, USA, Tel: +1-216-633-1114, Contact: Richard Stonebur. Manufacturer of complete line of water treatment equipment. Distribute plumbing and waterwell supplies, extensive application and design capabilities for domestic, commercial and industrial requirements. One of the largest suppliers to independent water conditioning dealers and assemblers providing full line of products incorporating latest technology.

**ION EXCHANGE PRODUCTS INC** 4834 S Halstead St, Chicago, IL, 60609, USA, Tel: +1-312-254-1300. Since 1922 has been in the business of supplying quality water treatment equipment for industries, cities, hospitals, laboratories, off-shore and homes. (WT)

**IONICS INCORPORATED** 65 Grove St, Watertown, MA, 02172, USA, Tel: +1-617-926-2500, Telex: 922403, Fax: +1-617-926-4304, Contact: Mr Vanwely. Total capability company operating in all fields of water and waste. Specialists in desalination of brackish and seawater, primarily using membrane processors such as EDR and RO. All regular water treatment facilities.

**JOHNSON MICROFLOC** Johnson House, Browells Lane, Feltham, Middlesex, TW13 7EQ, UK, Tel: +44-1-751-4424, Telex: 935479 uselon, Fax: +44-1-890-1533, Contact: Mrs Dicker. Suppliers of advanced technology, High rate, water and wastewater treatment equipment including packaged portable water production systems.

**JUDO WASSERAUFBEREITUNG GmbH** Hohreuschstr: 39-41, Winnenden, D-7057, West Germany, Tel: +49-7195-692-0, Fax: +49-7195-692-110, Contact: Hartmut Dopschlaff. Judo Wasseraufbereitung GmbH was founded in 1936 and currently consists of 180 employees. The company is engaged in the production of protective filters, dosing equipment, water softening equipment, reverse osmosis plants, desalination equipment, swimming-pool filter equipment and accessories.

**K J WATER TREATMENTS LTD** K J House, 15 Hardings Lane Penge, London, SE20, UK, Tel: +44-1-659-7216/7, Fax: +44-1-676-0138, Contact: Mr Briganza.

## GENERAL EQUIPMENT AND PROCESSES

Manufacturers and suppliers of a complete range of water treatment equipment and chemicals, including consultancy, design, chemical cleaning, chlorination and contract servicing.

**KABB INC** 5108 B Taravella Rd, Marrero, LA, 70072, USA, Tel: +1-504-340-1283. Manufactures POU reverse osmosis and GAC water treatment units that range in size from counter top to 500 gpd commercial systems. (WT)

**KANE INTERNATIONAL** 702 N Madison St, Rockford, IL, 61107, USA, Tel: +1-815-968-7511. Distribute bacteriostatic water processor.

**KEE SERVICES** College Rd, Aston Clinton, Aylesbury, Bucks, HP22 5EZ, UK, Tel: +44-296-631499, Telex: 837545, Fax: +44-296-630263, Contact: Mr Johnston. Design, construction, maintenance and refurbishment of all forms of equipment for effluent and waste treatment.

**KENDALL (Subsidiary of Colgate-Palmolive)** 50 Kerry Place, Norwood, MA, 02062, USA, Tel: +1-617-769-6112, Fax: +1-617-769-3274, Contact: Mr Jim Greene. The Kendall company manufacture a line of poly-sulfane ultra-filtration membranes and membrane cartridges for the ultra-pure water industry, also a line of products for the bio-separation industry.

**KENNICOTT/THOMPSON CHARLTON ENGINEERS** Spring Rd, Wolverhampton, W Midlands, WV4 6JX, UK, Tel: +44-902-353353, Telex: 337-412, Fax: +44-902-405500, Contact: Mrs P Grainger. Founded in 1902, Kennicott is a major water treatment company offering a comprehensive range of treatment plants and processes for a wide variety of industrial and potable applications.

**KEYSTONE FILTER DIV MET-PRO CORP** 2385 N Penn Rd, Hatfield, PA, 19440, USA, Tel: +1-215-822-1963. Manufacturer of water filter and replacement cartridges. Also design and manufacture custom filter cartridges and cartridge components.

**RICH KLINGER AKTIENGESELLSCHAFT** A-2352 Gumpoldskirchen, POB 19, Austria, Tel: +43-2252-62406, Telex: +14430 klglg a. Klinger are engaged in the production of industrial fittings. One of the main items in the line-up are the Ballostar Ball Cocks. These are available in every size from DIN 10 to 600, of cast iron, steel and acid-resistant steel, and in numerous special designs (eg for hot water up to 230°C). Other products turned out by Klinger are Klingerit sealing sheets, piston valves, meter pipe cocks and liquid level gauges.

**KOSKO MANUFACTURING CO** P O Box 211, 800 So McClellan St, Warsaw, IN, 46580, USA, Tel: +1-219-267-6217. Manufacture full water conditioning line.

**L A WATER TREATMENT CORP** 17400 E Chestnut St, City of Industry, CA, 91749, USA, Tel: +1-213-912-5411. Engineer, design and manufacture water treatment equipment for all applications.

**LANCASTER PUMP, A DIVISION OF C-B TOOL**

CO 1340 Manheim Pike, Lancaster, PA, 17601, USA, Tel: +1-717-397-3521. Manufacture domestic water treatment equipment.

**CLAUDE LAVAL CORP** 1911 N Helm Avenue, Fresno, CA, 93727, USA, Tel: +1-209-255-1601. Full line manufacturer of filtration products featuring Lakos sand separators and pump protection sand separators. Also, cartridge filters, screen filters and sand media filters. (WT)

**LAYNE-WESTERN CO INC** 721 West Illinois Avenue, Aurora, IL, 60506, USA, Tel: +1-312-897-6941. With 28 offices located throughout the US, Layne-Western Company is recognized as the leader in the field of water technology. Fully capable of providing practically every vital service needed by water users, municipal, industrial and agricultural. Services: complete hydrological engineering investigation, industrial and irrigation supply systems, drill and maintain water wells, install and service deep well pumping equipment, sell and install water and waste water treatment equipment.

**LEE POLLUTION CONTROL LTD** 1 Station Rd, Four Ashes, Wolverhampton, WV10 7DQ, UK, Tel: +44-902-791616, Telex: 335684, Fax: +44-902-791772, Contact: Mrs Juggins. Contractors for custom - designed and built water and effluent treatment plants. Please contact for further details.

**LEEDS AND NORTHRUP CO** Sunneystown Pike, North Wales, PA, 19454, USA, Tel: +1-215-643-2000, Fax: +1-215-699-5245, Contact: Bill Reed. Manufacturer of analytical instrumentation and sensors for water and waste water treatment. Also manufacture venturi meters and rate-of-flow controllers, liquid and dry chemical feeds equipment, filter bottoms, surface agitators, troughs, digital and analog control systems.

**LINK-O-MATIC** PO Box 148600 N 6th St, Richmond, IN, 47375, USA, Tel: +317-962-1538, Fax: +317-966-0674. Link-O-Matic is an OEM selling a complete line of water conditioners, filters, aerators, chlorinators, RO and DI equipment for residential, commercial and industrial applications. It also sells a patented 3" opening tinned brass DI exchange tank adapter and accessories as well as various miscellaneous products related to the water treatment industry. Link-O-Matic was established in 1951.

**LYONNAISE DES EAUX** 52 Rue de Lisbonne, Paris, Cedex 08, 75008, France, Tel: +33-40-75-70-00, Telex: 643-407, Fax: +33-1-45624270, Contact: Mlle Valenfi. Lyonnaise serve communities in fulfilling long-term needs of municipalities and industry, in the field of water supply and management, waste water treatment, drinking water distribution, sanitation.

**MAHON & MCPHILLIPS (STRATFORD)** LTD Holford Way, Witton, Birmingham, West Midlands, B6 7AX, UK, Tel: +44-21-356-7606, Telex: 334041, Fax: +44-21-356-892, Contact: Mr Hatt. Mechanical plant contractors, designers and manufacturers in the field of municipal and industrial water and waste water treatment.

## GENERAL EQUIPMENT AND PROCESSES

---

**MARLO INC** P O Box 4070, 2227 South St, Racine, WI, 53404, USA, Tel: +1-414-681-1300. Manufacturer of water treatment equipment for residential, commercial and industrial applications.

**MARTINSTILL CORP** 5001 S 16th, Lincoln, NE, 68512, USA, Tel: +1-402-423-7688, Contact: Diane Kinaman. Manufacturer and marketer of stainless steel, energy efficient water distillers for labs, commercial and home use. Also manufactures and markets dispensers. (WT)

**MASTER WATER CONDITIONING CORP** 224 Shoemaker Rd, Pottstown, PA, 19464, USA, Tel: +1-215-323-8358, Fax: +1-215-323-5526, Contact: Mr Karl Christ. Manufacturers of water softeners, filters, deionizers, reverse osmosis systems and ultraviolet purifiers.

**MATT-SON INC** 28 W 005 Industrial Avenue, Barrington, IL, 60010, USA, Tel: +1-312-628-8766, Contact: Brett Oleskaw. Design, manufacture and distribute plastic components for the water treatment industry. Stock supplier of US water treatment.

**MEISSNER FILTRATION PRODUCTS** 3750 Cohasset St, Burbank, CA, 91505, USA, Tel: +1-818-767-3262. Manufacturer of wide range of pleated filter elements suitable for the removal of particulates and colloids from water and chemicals.

**MENCO CHEMICAL** 442 Boston Post Rd, Waterford, CT, 06385, USA, Tel: +1-203-442-5628, Contact: John Menzies. Manufacturer of complete line of boiler cooling and process water treatment chemicals.

**METROPOLITAN REFINING CO INC** 50-23 23rd St, Long Island City, NY, 11101, USA. Manufacture chemical water treatment for boilers, cooling towers.

**MID AMERICA WATER TREATMENT** 901 W Lake St, Addison, IL, 60101, USA, Tel: +1-312-289-6400, Contact: Robert Colluzzi. Water treatment components for industrial, commercial and residential use, which includes all kinds of filters, reverse osmosis, drinking water, control valves and different types media.

**MID AMERICA WATER TREATMENT INC INT'L** 2045 Lake St, Hanover Park, IL, 60103, USA, Tel: +1-312-289-6400. Manufacturer of a complete line of residential and commercial water conditioning equipment including softeners, filters, chemicals, chemical feed pumps, RO systems and a complete line of component parts, pressure vessels, resin, valves, brine tanks, feeder tanks, filter housings, cartridges and carbon. (WT)

**MILLIPORE CORP** 80 Ashby Rd, Debford, MA, 01730, USA, Tel: +1-617-275-9200, Telex: 4430066, Fax: +1-508-875-2050, Contact: Linda Roettar. Offers several microbiological analysis kits providing a complete array of filters and equipment for field testing procedures.

**MINGORI** 1620 Avenue de Thuys, Bagonleg, Paris, 93170, France, Tel: +33-1-43-62-50-05, Telex: 670479, Contact: Mr Dumas. Manufacture mixers, taps and accessories for sanitation.

**MINNTECH CORP** 14905 28th Avenue North, Min-

neapolis, MN, 55441, USA, Tel: +1-612-553-3325. The hollow fiber ultrafilter is a polysulfone ultrafilter which can be used in a standard 10" industrial filter housing. The device contains 32 sq ft of surface area. (WT)

**MITCO WATER LABORATORIES INC** P O Box 1435, Winter Haven, FL, 33882-1435, USA, Tel: +1-813-967-4456. Chemicals, equipment and service for treatment of commercial and industrial cooling tower, boiler and potable water systems. Ion exchange, reverse osmosis and filtration process water purification equipment. Full service analytical laboratory.

**MONARCH WATER SYSTEMS** 245 N Valley Rd, Xenia, OH, 45385, USA, Tel: +1-513-426-7000. Manufacture pressure vessel water treatment equipment for domestic and commercial use. Also distribute parts for many systems including valves, controls, resin, filter media and instrumentation.

**MOYER DIEBEL CORP** 59 John Glenn Drive, Amherst, NY, 14120, USA, Tel: +1-416-562-4195. Manufacturer of the revolutionary DOLFYN water distiller, a fully automatic distiller capable of producing nine gallons of distilled water every 24 hours. Also available, a complete line of reservoirs, stands, demand pump systems, pre- and post-filtration systems. (WT)

**MYRON L COMPANY** 6231 Yarrow Drive, Carlsbad, CA, 92009, USA, Tel: +1-619-438-2021, Fax: +1-619-931-9189, Contact: John Burg. Manufacturers of conductivity instruments and control systems for water analysis and treatment. Ro/Di systems.

**N R G ENTERPRISES INC** PO Box 1097, Mercer Island, WA, 98040, USA, Tel: +1-206-232-1274, Telex: 9102507470, Fax: +1-206-232-1880. Water filters for the home which require no plumbing to install and no filter change for 5 years. We supply and train distributors in set up and operation.

**NATIONAL WATER PURIFIERS CORP** 1065 E 14th St, Hialeah, FL, 33010, USA, Tel: +1-305-887-0703. Manufacture residential and commercial water treatment equipment.

**NIAGRA PRODUCTS** 4 Gold Mine Rd, NJ, 07836, USA, Tel: +1-201-347-3700, Fax: +1-201-691-2225, Contact: Duane Cutler. Manufacturers of water conservation programmes and products.

**NITTO DENKO TECHNICAL CORP** 2910 Corvin Drive, Santa Clara, CA, 95051, USA, Tel: +1-408-720-8760. Manufacturer of reverse osmosis and ultrafiltration membranes, available in tubular, spiral wound and capillary configurations with a wide variety of membrane materials. (WT)

**OCV CONTROL VALVES** 7400 East 42 Place, Tulsa, Oklahoma, 74145, USA, Tel: +1-918-627-1942, Telex: 910-845-2227, Fax: +1-918-622-8916. OCV manufactures and internationally markets a complete line of automatic, hydraulically operated, diaphragm actuated, pilot controlled valves. The OCV line of control valves is widely used throughout private, municipal and military water treating facilities.

## GENERAL EQUIPMENT AND PROCESSES

**OETIKER INC** POB 9371-77 Okner Parkway, Livingston, New Jersey, 07039-0093, USA, Tel: +1-201-992-1920, Telex: 023-138493, Fax: +1-201-553-1826. Oetiker clamps - crimp style hose/tubing clamps, available in 1008 zinc plated or stainless steel. These clamps are an excellent choice for water (coolant) or air lines and other applications. The 2-Ear Clamp provides a quick, safe, tamper-proof and low profile positive clamping action.

**OLIN CORP** 120 Long Ridge Rd, Stamford, CT, 06904, USA, Tel: +1-203-356-2029. Basic water filters for taste and odor or sediment reduction, standard water filters for taste, odor and sediment reduction, patented automatic water filter (with controls) for reduction of taste, odor, sediment, organic chemical and inorganic chemical problems, and the technically advanced and patented reverse osmosis system, the Ultra II (with controls) for reduction of taste, odor, sediment, organic chemical and inorganic chemical problems. (WT)

**OLIN WATER SERVICES-OLIN CORP** 51 Corporate Woods, 9393 W 110th St, Overland Park, KA, 66210, USA, Tel: +1-913-451-3100. Water treatment programs, ie, chemicals, equipment and service.

**OMNIPURE FILTER CO** P O Box 1359 518 Kit Avenue, Caldwell, ID, 83605, USA, Tel: +1-208-454-2597, Fax: +1-208-454-0020. Dk supply inline, disposable, carbon filters, sediment filters and cartridge type carbon filter elements. Uses include RO filtration, distillers, beverage dispensers, refrigeration and more. Dedicated to quality, reliability and fast customer service.

**ORC/KDF TECHNOLOGIES** 120 S Washington, Constantine, MI, 49042, USA, Tel: +1-616-435-5835. Marketing the KDF 55-D media for the removal of chlorine, chloramines, hydrogen sulfide, iron and pre-treatment before RO systems to protect the membrane from chlorine and bacteria degradation. (WT)

**PALL PROCESS FILTRATION CORP PALL ULTRAFINE FILTRATION CORP** 2200 Northern Boulevard, East Hills, NY, 11548, USA, Tel: +1-516-484-5400. International leader in design, manufacture and marketing of sophisticated filters and other fluid clarification devices which serve the health care, aeropower and fluid processing markets.

**PARKER HANNIFIN CORP** 17325 Euclid Avenue, Cleveland, OH, 44112, USA, Tel: +1-216-531-3000. Parker Hannifin is a leading producer of filtration and motion control components and systems. Its commercial filters division offers a line of home water filters and cartridges that remove sediment, rust, algae, chlorine and odors.

**PATERSON CANDY INTERNATIONAL LTD** 21 The Mall, Ealing, London, W5 2PU, UK, Tel: +44-1-578-1311, Telex: 27239, Contact: S F J Lindsey. Design, process engineering, construction, mechanical/electrical engineering of potable water treatment works from village schemes to major cities worldwide.

**PAYNE MANUFACTURING CO INC** 1900 Petra Lane

Unit E, Placentia, CA, 92670, USA, Tel: +1-714-777-1093, Fax: +1-714-514-8780, Contact: Mr Tony Branson. Manufacturers of OFM reverse osmosis purification systems and all component parts.

**PCI OZONE CORP** 1 Fairfield Crescent, West Caldwell, NJ, 07006, USA, Tel: +1-201-575-7052, Telex: 244067, Fax: +1-201-575-8941. PCI Ozone Corp provides ozone systems for use in water and wastewater treatment, odor control and chemical processes. Ozone in the presence of polluting compounds reacts rapidly to form environmentally safe byproducts. This process is particularly effective as a treatment for both potable water and wastewater disinfection.

**PEERLESS INC** 1701 E Vine St, Kalamazoo, MI, 49001, USA, Tel: +1-616-344-6137. Manufacturer of all types of water treatment equipment including softeners, filters, deionizers, condensate polishers, dealkalizers, etc. (WT)

**THE PERMUTIT CO** E 49 Midland Avenue, Paramus, NJ, 07652, USA, Tel: +1-201-967-6000. Manufacture water and wastewater treatment equipment (industrial).

**PEWPLAN (WT) LTD** Beechwood Hall, Kingsmead Rd, High Wycombe, Bucks, HP11 1LA, UK, Tel: +44-494-35671, Telex: 837139, Fax: +44-494-465489, Contact: Mr David Moreau. Undertake design and contracting of major water treatment installations.

**PLASWORLD-DIV OF RAYTEC WATER-GROUP** 500 W Oklahoma Avenue, Milwaukee, WI, 53207, USA, Tel: +1-414-747-3700. Supplier of residential and commercial water treatment equipment to independent water treatment dealers. Proprietary products in water conditioning and reverse osmosis.

**PLYMOUTH SALES CO INC** 1115 West Struck Avenue, Orange County, CA, 92667, USA, Tel: +1-714-997-5482. Wholesale distribution of filter housings, cartridges and accessories to water improvement industry.

**POLAR BEAR WATER DISTILLERS CO LTD** PO Box 113 Main St, Pickardville, Alberta, T06 1W1, Canada, Tel: +1-403-349-4872, Fax: +1-403-349-5904. Polar Bear Water Distillers is Canada's largest manufacturer of residential, commercial and industrial water distillers. Constructed of quality stainless steel, their units remove greater than 99% of all contaminants from any source of food water, with virtually maintenance-free option available. Polar Bear also manufactures a stainless steel purified water dispensing system for water profit centres. Backed by excellent warranty, Polar Bear is "clearly" the best!

**POREX TECHNOLOGIES** 500 Bohannon Rd, Fairburn, GA, 30213, USA, Tel: +1-404-964-1421. Manufacturer of Porex™ porous plastics used in applications requiring filtering, diffusing, aerating, wicking, venting, muffling, fluidizing and supporting system. (WT)

**PORTALS WATER TREATMENT LTD** Oldfield Lodge, 156 Bridge Road, Maidenhead, Berkshire, SL6 8DG UK Tel: +0628771444, Telex: +849067 PWT MHDG, Fax: +0628771567. PWT has four business sectors related to water, waste service and contracting: Major

## GENERAL EQUIPMENT AND PROCESSES

projects up to \$500 million in value, Speciality chemicals for boiler, cooling and process water applications, Products and services including standard industrial treatment plants, plan rehabilitation, customisation and packaged systems, Special products including pump sets, cooling towers, mass transfer systems and screening presses.

**PRO-FLO PRODUCTS INC** 29 Ryder Rd, Wayne, NJ, 07470, USA, Tel: +1-201-956-1057, Telex: 5106013192, Fax: +1-201-585-1904, Contact: Mr Smith. Manufacture products for treatment of water at residential and small commercial level, reverse osmosis, carbon filtration and ultra-violet.

**PROMINENT FLUID CONTROLS** 1005 Parkway View Drive, Pittsburgh, PA, 15205, USA, Tel: +1-412-787-2484. Manufacture chemical feed and control equipment for water treatment.

**PURE SOLUTIONS DIV OF IONICS INC** 4101 E Wood St, Phoenix, AZ, 85040, USA, Tel: +1-602-437-1355. Specify, design, fabricate, install and service water purification equipment, including filtration, reverse osmosis, degasification, deionization, ultraviolet sterilization and ozonation.

**PURE WATER INC** PO Box 83226, Lincoln, NE, 68501, USA, Tel: +1-402-467-2577. Manufacturer and marketer of water distillers for home, office and light commercial. A full range of vented distillation systems including manual, semi-automatic, fully-automatic, a refrigerated unit and convenience accessories that deliver distilled water to an accessory faucet or ice cube maker. (WT)

**PURE WATER INTERNATIONAL INC** 3633 Pomona Boulevard, Pomona, CA, 91768, USA, Tel: +1-714-594-4433. Manufacture point-of-use water purification devices.

**PURE WATER TECHNOLOGIES INC** 257 Riverside Avenue, Westport, CT, 06880, USA, Tel: +1-203-454-0006. Manufacturer of POU purification system and unique combination of ultraviolet and carbon filtration technology.

**PURIFICATION PRODUCTS CO** 820 Los Vallecitos, Ste G, San Marcos, CA, 92069, USA, Tel: +1-619-471-2991, Telex: 251761, Fax: +1-619-471-2046, Contact: Mr O'Hair. Manufacturers of reverse osmosis, membrane element for point-of-use and point-of-entry water purification.

**PURITAN WATER CONDITIONING INC** 216 Lafayette Avenue, Crawfordsville, IN, 47993, USA. Manufacturer of water conditioning and iron filtering equipment. (WT)

**PURWATER INT'L CUNO INC** 3633 Pomona Boulevard, Pomona, CA, 91768, USA, Tel: +1-714-594-4433. Product line includes reverse osmosis membranes, through which water is forced to remove dissolved salts and chemical contaminants. (WT)

**QPS PLASTICS** New York Industrial Estate, Summer-

bridge, Harrogate, North Yorkshire, HG3 4LA. UK. Tel: +44-423-780389, Fax: +44-423-781516. QPS Plastics are suppliers of the "Q-CAP"<sup>TM</sup> range of sewage distributor-arm end caps. Cast in En-thane<sup>TM</sup> polyurethane, "Q-Caps" offer many advantages over conventional metal end caps and bungs, including speed of "flushing" and/or "rodding out", no corrosion, less weight, greater resilience, reduced handling, etc. "Q-Caps" are available in a full range of sizes in both BSP threaded and plain tapered.

**QSP DISTRIBUTING CO INC** P O Box 6, Luverne, MN, 56156, USA, Tel: +1-507-283-9591. Wholesaler-supplier of water conditioning materials, components and related products.

**RADIANT INDUSTRIES CORP** 1227 Rockaway Avenue, Brooklyn, NY, 11236, USA, Tel: +1-718-649-5577, Contact: Mr George Adams. Manufacture a complete line of water conditioning equipment for domestic and commercial applications.

**RAINSOFT WATER CONDITIONING CO** 2080 Lunt Avenue, Elk Grove Village, IL, 60007, USA, Tel: +1-312-437-9400. Manufacturer of a complete line of water treatment equipment for home, business and industry: water softeners, deionizers, iron filters, turbidity filters, acid neutralizers, taste and odor filters, water purifiers and reverse osmosis equipment. (WT)

**RAYNE CORP DIV OF RAYTEC WATER-GROUP** P O Box 90, Santa Barbara, CA, 93101, USA, Tel: +1-805-966-1695. Manufacture line of water conditioning equipment for home and commercial applications.

**RAYTEC WATERGROUP** 500 W Oklahoma Avenue, Milwaukee, WI, 53207, USA, Tel: +1-414-747-3760, Telex: 6878041, Fax: +1-414-747-3812, Contact: Marti Cocker. Raytec Watergroup is a market leader and has been supplying the finest in water treatment for over 40 years. Raytec Watergroup complete, state-of-the-art products line includes exclusive proprietary equipment designed to solve today's water problems.

**REFINITE WATER CONDITIONING COMPANY INC** P O Box 11676 555 Paddock Parkway, Rock Hill, South Carolina, 29730, USA, Tel: +1-803-324-7600, Fax: +1-803-324-1116, Contact: Mr Spencer E Bush. Since 1918, has manufactured large capacity municipal and industrial water treatment systems. The 250,000 sq ft ASME approved facility offers stainless steel, aluminium and plastic lined or zinc metalized steel. Standard products include carbon adsorption, packed tower aerators, softeners, deionizers, dealkalizers, diatomaceous earth filters, cooling tower filters, iron removal plants, horizontal pressure filters, gravity filters and packaged clarifier/filter plants.

**ROMICON INC** 100 Cummings Park, Woburn, Massachusetts, 01801, USA, Tel: +1-617-935-7840, Telex: 94-9333, Fax: +1-617-935-7183, Contact: Dr Roger Johnson. Manufacturers of ultrafiltration membrane modules and fully automated ultrafiltration systems.

**RUSTRAP MFG CO** 111 Howard St, E Edgerton, MI, 56128, USA, Tel: +1-507-442-3451, Fax: +1-507-442-3775,



## GENERAL EQUIPMENT AND PROCESSES

Contact: Mr Roger Pool. Manufacturer of dual inline water filters, R. V. softeners and complete line of both commercial and residential water softeners.

**S & G WATER CONDITIONING** 525 N York Rd, Warminster, PA, 18974, USA, Tel: +1-215-672-2030. Manufacture of water conditioning equipment for home and business.

**S E E** Rue de la Science, Brussels, B 1040, Belgium, Tel: +32-2-230-9314, Telex: 25 237, Fax: +32-2-230-7613. Water treatment plants: drinking water, waste water, water for industry, swimming pool water. Chemical products for water conditioning. Pre-fabricated units for the production of drinking water and waste treatment.

**SAXTON MANUFACTURING CO** 16782 Milliken Avenue, Irvine, CA, 92714, USA, Tel: +1-714-863-0606. Manufacture water conditioning equipment for home, commercial and photographic markets.

**SCIENCO SYSTEMS INC** 3240 N Broadway, St Louis, MO, 63147, USA, Tel: +1-314-621-2536, Telex: 442449, Fax: +1-314-621-1952, Contact: Mr Don Mason. Manufacture point of use water treatment equipment, on-site chlorine generators, small and large applications, mobile and fixed package water treatment systems for making potable water from surface, well, brackish and salt water.

**SEPARMATIC FILTER COMPANY** 7628 West Florist Avenue, Milwaukee, WI, 53218, USA, Tel: +1-414-466-5200. Manufacture water purification equipment and chemical feed pumps.

**SERCK BAKER LTD** Riga House, 380 Bristol Rd, Gloucester, Gl2 6XY, UK, Tel: +44-452-421561, Telex: 43567, Fax: +44-452-423414, Contact: Alan Brown. Design, install and commission total water and effluent treatment systems. Specialists in filtration, aeration and chemical injection systems.

**SERFILCO LTD** 1234 Depot St, Glenview, IL, 60025, USA, Tel: +1-312-998-9300. Manufacture individual chemical pumps, filter chambers for water and chemical solutions, filtration systems, steam cleaners/hot pressure washers, automatic gravity and vacuum filtration systems, polishing filter for waste treatment systems and other related equipment.

**SERFILCO UK LTD** Unit 4B, Broadoak Industrial Park, Ashburton Rd West, Trafford Park, Manchester, M17 1RW, UK, Tel: +44-61-872-1317, Telex: 665424, Fax: +44-61-873-8027, Contact: Margaret Chapman. Manufacturers of plastic pumps, filter chambers and filter cartridges as components in complete filtration systems.

**SIFTO® SALT DIV, DOMTAR INDUSTRIES INC** 4825 N Scott St, Ste 400, Schiller Park, IL, 60176-1354, USA, Tel: +1-312-671-0680. Mines, processes, packages and delivers salt for many markets including water conditioning. A full line of salt products is available in bulks, bags and blocks as solar, rock and evaporated. (WT)

**SOUTHERN WATER CONDITIONING DIV ANDERSON CHEMICAL** 1840 Waterville Rd, Macon, GA,

31206, USA, Contact: L. M Horton. Manufacture water and wastewater treating equipment and chemicals.

**SPRINGSOFT** 2390 United Lane, Elk Grove, IL, 60007, USA, Tel: +1-312-894-5000. Full stock of all water treatment materials - complete systems, residential and commercial.

**STA-RITE INDUSTRIES INC, WATER TREATMENT DIV** 1875 Dewey Avenue, Benton Harbor, MI, 49022, USA, Tel: +1-616-925-8812. Manufactures a broad line of commercial/industrial water treatment products. The commercial/industrial line ranges from small commercial units to large commercial and industrial units as well as complete multiple-unit systems. (WT)

**HUBERT STAVOREN BV** 20 Kooyweg, Stavoren, 8715 EP, The Netherlands, Tel: +31-51-49-1625, Telex: 46110 EHSTA NL, Fax: +31-51-49-2198, Contact: Mr Allablas. The company design, manufacture and install equipment for water treatment and waste water treatment.

**ERICH STROBL** A-5021 Salzburg, Lastenstrasse 14, POB 49, Austria, Tel: +43-6222/72-1-31/75-3-59, Telex: 633387. Strobl specialize in water handling plants and systems. The line-up includes water treatment plants for swimming-pools, drinking water supply systems and water supply plants for industry. The firm undertakes the planning, production, installation and servicing of water-handling plants.

**SULZER BROTHERS LIMITED**, CH-8401 Winterthur, Switzerland, Tel: +41-52-81-11-22, Telex: 896-060, Fax: +41-52-23-42-83. Sulzer water treatment and wastewater purification plants meet the special requirements associated with all kinds of municipal and industrial applications. In addition, pumps are supplied for communal and industrial water supply and irrigation installations. Furthermore, pumps, decanters and fluid-bed driers required for the treatment of waste waters and sewage sludges.

**SUN STANDARD INC** 10105-C Acoma SE, Albuquerque, NM, 87123, USA, Tel: +1-505-296-8000. Manufactures point-of-use solid carbon block drinking water purification systems. Stainless steel housings. Water dispensers designed to replace bottle water dispensers. (WT)

**SUNBIRD SALES INC** Box 125 Rt 68 Highway 107, Cullowhee, NC, 28723, USA, Tel: +1-704-293-5912. Sales and distribution of water treatment equipment.

**SUNROC CORP** Rt 452, Glen Riddle, PA, 19037, USA, Tel: +1-215-459-1100. Manufacturers of bottled water coolers.

**SUPERSTILL TECHNOLOGY INC** 888 Second Avenue, Redwood City, CA, 94063, USA, Tel: +1-415-366-1133. Manufactures Vapor Compression Water Processors™, one of the world's most energy efficient water distillers. Capacities range from 25 to 1000 gph (600-24,000 gpd). (WT)

**SYNTECHNICS INC** 700 Terrace Lane, Paducah, KY, 42003, USA, Tel: +1-502-898-7303, Fax: +1-502-898-7306,

## GENERAL EQUIPMENT AND PROCESSES

Contact: Michael B Beott. SynTechnics manufactures fibreglass reinforced plastic cover systems for the water treatment and wastewater treatment industries. FRP is most advantageous in meeting structural requirements in hostile, corrosive environments. Applications for SynTechnics' structural enclosures include clarifiers, digesters, sludge thickeners, water storage tanks and other clear span applications with needs for weather protection and/or odor control.

**TARI GESELLSCHAFT mbH** A-5280 Braunau/Inn, Peter-Rosegger-Weg 12, Austria, Tel: +43-772/32-64, Telex: 027-75524. Tari Gesellschaft mbH are engaged in water technology. Their products are used for water treatment, in particular drinking and service water from rivers, brackish and karst waters, for ultraviolet irradiation, reverse osmosis, full desalination and decarbonisation. For water treatment the firm produces ozonizing equipment. Tari undertake the planning, production and installation of various facilities, including small and large size swimming-pool systems using mechanical and chemical water treatment.

**TEMCOR** PO Box 3039 2825 Plaza Del Amo, Torrance, CA, 90510-3039, USA, Tel: +1-213-320-0554, Fax: +1-213-320-8629, Contact: G Clark Margolf. Design, fabrication and erection of all maintenance free aluminum covers and domes, for tanks of all shapes and sizes in the water and wastewater industry. Please contact for further details.

**TOUCH-FLO MFG CO** 75 E Palm Avenue, Burbank, CA, 91502, USA, Tel: +1-818-843-8117. Manufacture drinking water dispensers, saddle valves and air gaps for RO and carbon home filtration units.

**TRANSCONTINENTAL WATER PURIFICATION I<sup>P</sup>** O Box 846, Eugene, OR, 97440, USA. Water and wastewater equipment. Contractors and manufacturers representatives.

**TRUPAR INC** 2901 West Third St, Dayton, OH, 45417, USA, Tel: +1-513-268-6626. Manufactures domestic and industrial pumps and water treatment equipment. (WT)

**UNOX EFFLUENT TREATMENT SYSTEMS (WIMPEY ENGINEERING)** 27 Hammersmith Grove, London, W6 7EN, UK, Tel: +44-1-748-2000, Telex: 25666, Fax: +44-1-748-0076/748-6083, Contact: Amanda Powell. Contractors and specialist process and equipment suppliers to the water and sewage treatment industry.

**VAPONICS INC** Cordage Park, Plymouth, MA, 02360, USA, Tel: +1-508-746-7555. Manufactures quality water purification systems including distillation, RO, ultrafiltration and deionization for industry.

**VOEST-ALPINE AG** Postfach 2, A-4010 Linz, Austria, Tel: +43-732/585-1, Telex: 2208-600 va a. The company's water engineering activities form only part of the varied range of products and services. They include: drinking-water treatment of surface and ground water, service water treatment, treatment of circuit, cooling and process water, mechanical, biological and chemical treatment of sewage and industrial waste, stabilisation, digestion, thickening, draining, drying, composting,

disposal and incineration of sludge, and sludge draining using screen belt presses.

**VOEST-ALPINE MONTAGE GESELSCHAFT mbH** Dieselstrasse 2, Wels, A-4600, Austria, Tel: +43-7242/81-7-51, Telex: 02-5512. Voest Alpine Montage GesmbH, an affiliate of Voest Alpine AG, Linz, specialize among other things in water treatment plants, embracing filtering and softening plants, plants for part and full desalination, cooling and drinking water conditioning plants, seawater desalination plants (applying the VAM multi-effect process) and water supply projects using large-capacity tankers.

**WALTHAM CHEMICAL PUMP CORP (WALCHEM)** P O Box 565, 1396 Main St, Waltham, Massachusetts, USA, Tel: +1-617-899-8604, Tel: 923478, Fax: +1-617-647-9507, Contact: Richard Jewett. Manufacturers and suppliers of positive displacement metering pumps, fluid control systems.

**WATER CONDITIONING CONTROLS INC** 418 Division St, Madison, WI, 53704, USA, Tel: +1-608-249-5001. Manufacture regeneration and backwash valves for the water conditioning industry.

**WATER CONDITIONING INC** 3119 O, Lincoln, NE, 68501, USA, Tel: +1-402-435-6104. Manufacture a complete line of water conditioning and purification units and own line of components, tanks and brine tanks etc.

**WATER ENGINEERING LTD** Aynho Rd, Adderbury, Banbury, Oxon, OX17 3NL, UK, Tel: +44-295-810581, Telex: 83655, Fax: +44-295-811997, Contact: John Mee. Design and supply of municipal effluent and water treatment plants worldwide, either on a project management basis or as individual products and process - extending to installation and commissioning.

**WATER ENGINEERING SERVICES LTD** Unit F, Kemberton, Halesfield 22, Telford, TF7 4QX, UK, Tel: +44-952-290497, Telex: 35835, Fax: +44-952-290353. Suppliers of packaged and purpose built water/effluent treatment plants including pressure filters, deionisation units, reverse osmosis and rotating biological contactors for sewage treatment.

**WATER EQUIPMENT TECHNOLOGIES INC** 832 Pike Rd, W Palm Beach, FL, 33411, USA, Tel: +1-407-684-6300, Contact: George T Karmbis. Manufacturers of water filtration and reverse osmosis products from 12 gallons to 250,000 gallons per day.

**WATER REFINING INDUSTRIAL INC** 500 N Verity Parkway, Middletown, OH, 45042, USA, Tel: +1-513-423-9421. Company has designed, manufactured and supplied water conditioning equipment worldwide since 1957. Unique polyethylene linings, solid state controls, broad line of standard vessel designs mean quick deliveries and competitive pricing. Near total control of in-house manufacturing assures top quality.

**WATER RESOURCES INTERNATIONAL INC** 2310 W Sherman St, Phoenix, AZ, 85009, USA, Tel: +1-602-257-0510. Manufacture water treatment equipment systems.

## GENERAL EQUIPMENT AND PROCESSES

**WATER SERVICES CORP/WATERSOFT CO** 111E North St, Waukesha, WI, 5318, USA, Tel: +1-414-547-1862, Fax: +1-414-547-5728, Contact: Julie Watner. Manufacturers of reverse osmosis, iron exchange, filtration and ultra filtration equipment for commercial and industrial use.

**WATER SOFT INC** 220 Ohio St, Ashland, OH, 44805, USA, Tel: +1-419-289-0633. Manufactures a full line of water treatment equipment for residential and commercial use. Broad line covers water softeners, activated carbon filters, iron filters, turbidity filters, neutralizer filters and domestic chlorination systems.

**WATER SYSTEMS WAREHOUSE** 789 W Michigan Avenue, Saline, MI, 48176, USA, Tel: +1-313-429-1846. Wholesale assembly and distribution of the original patented Paterson Iron Filter which requires no salt or chemicals for regeneration.

**WATER TECH INC** 214 N E 83rd St, Vancouver, WA, 98665, USA, Tel: +1-206-573-7176. Manufacture potable and industrial water treatment packaged plants, also industrial wastewater treatment packaged plants.

**WATERCO INDUSTRIES** 4811 N E 12th Avenue, Ft Lauderdale, FL, 33334, USA, Tel: +1-305-772-0020, Telex: +1-305-776-5403, Contact: Beverly Schecter. WATERCO have manufactured water purification equipment since 1973. Manufacturing a complete line from counter-top to custom designs for large commercial installations.

**WATERSAFE INTERNATIONAL** 4201 Mesa Vista Drive, La Canada, CA, 91011, USA, Tel: +1-818-952-1045. Manufactures and distributes both wholesale and retail total water conditioning systems for homes, businesses and agriculture. Product line includes travel units to whole house systems.

**WATERWISE INC** P O Box 4599, Center Hill, FL, 33514, USA, Tel: +1-904-787-5008, Fax: +1-904-787-8123. Supplier for Distil Clear Pure Water System and other distillation equipment including filters, bottles, dispensers, demand pumps, faucets, tubing and test equipment, home and office application.

**WCP SYSTEMS** 245 S Quince St, Escondido, CA, 92025, USA, Tel: +1-619-745-8383. Software for water conditioning industry.

**WESTERN PURIFIER CO** 22900 Ventura Boulevard Suite 220, Woodland Hills, CA, 91364, USA, Tel: +1-818-703-0444. Manufacturer and distributors of 1 to 2 GPM point of use residential, commercial and recreational water purifiers and filters. Please contact for further details.

**WESTERN WATER INTERNATIONAL INC** 7715 Penn Belt Drive, Forestville, MD, 20747, USA, Tel: +1-301-568-0200. Exclusive manufacturer of Aquaspace® filter compound and water filter product line. Systems available for residential, commercial and industrial applications. Specializing in total systems for POE. POU systems and replacement cartridges also available. Non-chemical systems for cooling towers, boilers and vending machines etc.

**WICOR CANADA INC, FILTERSOFT DIV** 111 Plymouth St, Winnipeg, Manitoba, R2X 2V5, Canada, Tel: +1-204-694-2288. Manufacturer of residential and commercial water treatment equipment including softeners, filters, cartridge-type filters and related products. (WT)

**WILLIAMETTE WATER AND SOLAR CO** 1301 W 6th Avenue, Eugene, OR, 97402, USA, Tel: +1-503-484-2027. Assemblers of component parts for filters, softeners, RO's, private label available. New product testing. Manufactures representatives for commercial equipment. Many lines.

**WOOD BROTHERS IND INC** P O Box 4426, 4021 N 48 St, Lincoln, NE, 68504, USA, Tel: +1-402-467-1236, Contact: Mr Edward Wood. A range of water softening products for both commercial and domestic applications. Iron filters, carbon filters, reverse osmosis equipment etc also available.

**WSH LABORATORIES LTD** 3851 B 21st NE, Calgary, Alberta, T2E 6T5, Canada, Tel: +1-403-250-9164. Manufacturer of clear water treatment systems and complete line of softeners, dealkalizers, chemical iron filter and the unique non-chemical iron filter with the ARV valve. (WT)

**WYNHAUSEN/O & G WATER CONDITIONING** 431 S San Gabriel Boulevard, San Gabriel, CA, USA, Tel: +1-818-287-2148. Manufacturers of water conditioning equipment.

**YIT CORPORATION** Ratamest Arinkatu 12, Helsinki, SF-00520, Finland, Tel: +358-0-15051, Telex: H121416, Fax: +358-0-1505282, Contact: Mr Nuudineu. YIT Corporation specialises in all types of water and sewage projects ranging from rural water supply schemes to complete turnkey plants including planning, supplies and civil/mechanical/electrical execution on site.

**YSI INCORPORATED** YSI Scientific Ltd, Iysons Avenue, Ash Vale, Aldershot, Hampshire, GU12 5QR, UK, Tel: +44-252-513006, Telex: 858210 INSTCOG, Fax: +44-252-511855. YSI dissolved oxygen and conductivity instruments monitor wastewater treatment and provide environmental control and enforcement. Other YSI systems help maintain pure water supplies by measuring temperature, pH, conductivity and ORP in surface water and groundwater as it's pumped from test wells. YSI instruments assure healthy crops of fish and shellfish in hatcheries and on fish farms. contact for further details.

**ZEMARC CORP** 2240 Gaspar Avenue, Los Angeles, CA, 90040, USA, Tel: +1-213-721-5598. Manufacture filter housings and replaceable filter cartridges.

**ZENON WATER SYSTEMS INC** 845 Harrington Court, Burlington, Ontario, L7N 3P3, Canada, Tel: +1-416-639-6320. Specializes in advanced water treatment technology based products and services. Manufactures single and double RO systems, ultrafiltration, laboratory water purification systems, utilized on medical, electronics, pharmaceutical and many other applications.

### Specialised Equipment and Processes

**AQUA PROCESS ENGINEERING LTD** Aqua House, 27 Denison Rd, London, SW19 2DJ, UK, Tel: +44-1-543-3647/8, Telex: 915089 aqua g, Contact: Mr Clave. Engineers in potable water treatment. Specialists in pressure filtration plant refurbishment and site installation.

**AQUATEC MARKETING LTD** Unit 1D, Kennetside, Newbury, Berks, RG14 5PX, UK, Tel: +44-635-49141, Fax: +44-635-38681, Contact: Madeline Hall. Aquatech Marketing Limited is an international distributor of swimming pool, spa, whirlpool, water treatment and water engineering equipment. The company's comprehensive product range includes pressure vessels, pumps and irrigation equipment.

**ARLAT TECHNOLOGY INC** 150 East Drive, Bramalea, Ontario, L6T 1C1, Canada, Tel: +416-458-8220, Fax: +416-458-8224, Contact: R Larry Madden. Arlat Technology Inc is a Canadian based manufacturer and representative of engineered process equipment for the water and wastewater treatment market. Arlat Technology Inc offers complete engineering and design capabilities along with products such as ultraviolet disinfection systems, ozonation equipment, plate settlers, clarifier mechanisms and static mixers.

**BIG IRON DRILLING INC** 3400 E. Century Avenue, Bismark, ND, 58501, USA, Tel: +1-701-258-2621, Contact: Phil Carufel. Manufacture water treatment equipment, automatic water distillers, automatic iron filters and related accessories. Equipment fully patented.

**BIRTLEY** Avenue de Tervueren 32-36, Boite 11-12, Brussels, B1040, Belgium, Tel: +32-2-73-60037, Telex: 24-747, Fax: +32-2-736-44-76, Contact: Mr Gerard. Self-cleaning water intakes for rivers, canals or main pipes have an opening of 1mm without moving parts, automatic filters and strainers are remote controlled or not, have no moving parts, and a filtration size ranging from 100 to 800 microns, pressure goes up to 20 bars (about 300 psi), separators, remote controlled or not are fully automatic. There are no moving parts. They have a separation level ranging from 10 to 100 microns and deal with all pressures and require practically no maintenance.

**BRITISH FILTERS LTD** Thames Industrial Estate, Fieldhouse Lane, Marlow, Buckinghamshire, SL7 1TD, UK, Tel: +44-6284-73131, Telex: 849216, Fax: +44-6284-75955, Contact: Mr Brendan Phelan. Manufacturers of pre-coat filters and water filtration equipment in general.

**CLACK-CORP** P O Box 500, 4462 Duraform Lane, Windson, WI, 53598, USA, Tel: +1-608-251-3010, Fax: +1-608-846-2586, Contact: Peter Chevmak. Manufacture and distribute water treatment components including: reverse-osmosis, ion exchange resins, pressure vessels, brine tanks and accessories, activated carbon, and a complete line of filter media.

**CRYSTAL FLUID FILTER CO** 865 Grand Boulevard, Westbury, NY, 11590, USA, Tel: +1-516-333-6768. Sediment and odour removal filters, 3 gals to 167 gals per minute. Existing water pressure usually operates units, but pumps can be inserted. Constructed of plastic or SS filter media cartridges.

**DELTA COOLING TOWERS INC** P O Box 952, 114 Clinton Rd, Fairfield, NJ, 07006, USA, Tel: +1-201-227-0300, Fax: +1-201-227-0458, Contact: John Halligan. Manufacture a line of factory assembled packaged cooling towers from 10 tons to 1,000 tons. We also manufacture a line of pack air strippers for removal of toxic organic contamination from water.

**DREW INDUSTRIAL DIVISION** One Drew Plaza, Boonton, New Jersey, 07005, USA, Tel: +1-201-263-7600, Telex: 136444 Drewchems Boon, Fax: +1-201-263-3323, Contact: J R Townsend. Drew Industrial Division provides specialty chemical products and services for the management and treatment of water and fuel in steam generating, process cooling, air conditioning, clarification and process water systems. Industrial water treatment needs are covered by a broad range of products: corrosion and scale inhibitors, dispersants, microbiocides and defoamers.

**ETA PROCESS & EFFLUENT PLANT LTD** The Levels, Brereton, Rugeley, Staffordshire, UK, Tel: +44-8894-76501, Telex: 36519, Fax: +44-8894-79856, Contact: Mr Homer. ETA is world leader in design of de-aerators for a wide range of water applications. Also available are degassers to remove carbon dioxide, hydrogen sulphide, THMs etc. Low energy and reliability are the main advantages.

**EVERPURE INC** 660 N Blackhawk Drive, Westmont, IL, 60559, USA, Tel: +1-312-654-4000, Telex: 210050, Fax: +1-312-850-0799, Contact: Tom Wood. Point-of-use water treatment for premium quality drinking and cooking water in restaurants and homes.

**FIBERGRATE CORP** PO Box 814610, Dallas, TX, 75-381-4610, USA, Tel: +1-214-250-1633, Fax: +1-214-2150-1530, Contact: Mr David L Eberhart. Manufacturer of fiberglass grating, walkways, platforms, bridges, ladders, handrails and other corrosion-resistant pedestrian facilities, complete concept to completion capabilities including design and installation.

**FIBREDYNE INC** 190 Crosby Rd, Dover, NH, 03820, USA, Tel: +1-603-749-1610, Fax: +1-603-749-2699, Contact: Alice Bussiere. Manufacture disposable water filter cartridges.

**FILTROS PLANT FERRO CORP** 603 W Commercial St East, Rochester, NY, 14445, USA, Tel: +1-716-586-8770, Fax: +1-716-586-7154, Contact: Dick Veeper. Filtrors diffusers consist of porous ceramic materials in the shape of tubes, plates, discs and domes. Diffuser tube and disc assemblies are offered for connection into an air supply to provide small-bubble aeration for sewage treatment. Porous ceramic filter plates are used for underdrains in water filtration facilities.

**FLUID MECHANICS INC** P O Box 1215, Lafayette, IN,

**"A TRUE REFLECTION OF ...**

# **QUALITY™**

Hyperfiltration Membranes

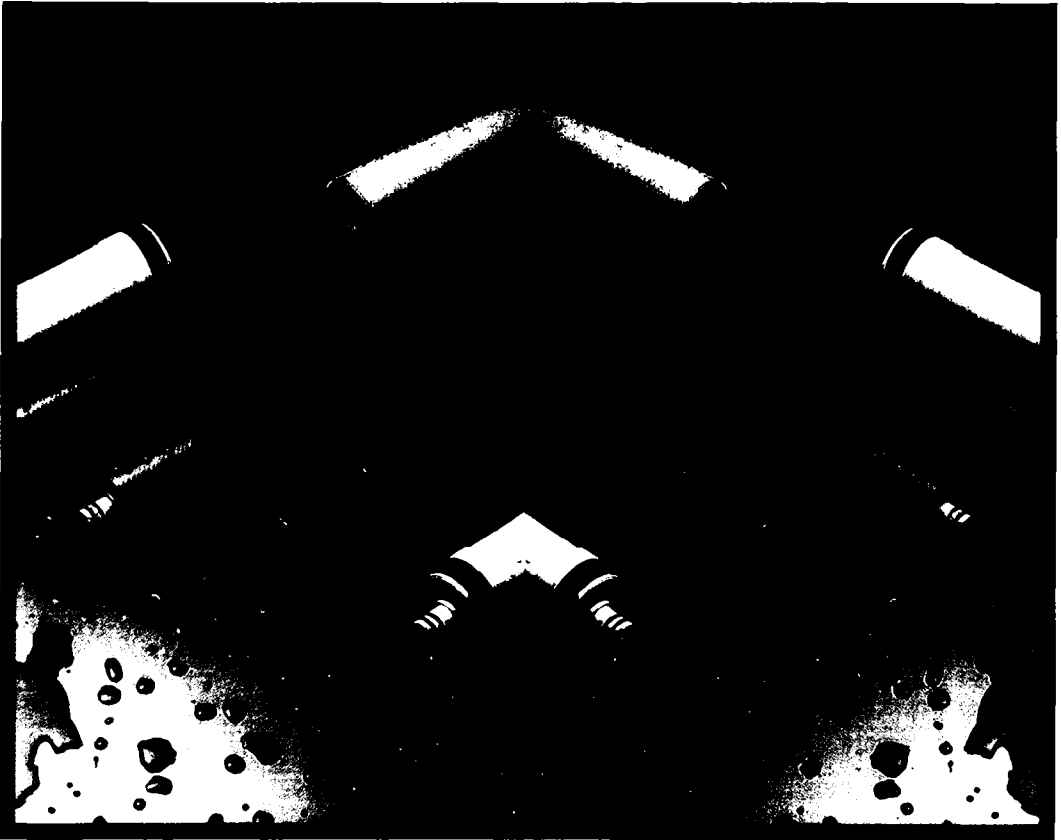

- Reverse Osmosis Elements
- Pressure Vessels
- Home & Point of Use Systems
- Pressure Assist Units
- Tanks & Component Parts
- Repressurization Assemblies
- Car Wash Systems
- Vending Machines
- Commercial 100-30,000 Gallon/Day Units
- Industrial Plant Purification



**HYPERFIL INDUSTRIES, INC.**  
1170 Van Horne Way  
Anaheim, CA 92806  
USA (714) 630-4381  
FAX (714) 630-2366

***Manufactured in USA***



## SPECIALISED EQUIPMENT AND PROCESSES

47901, USA, Tel: +1-317-742-23380. Manufacturer of no-salt, chemical-free water treatment products for residential and commercial applications. Water conditioner offers water conditioning dealers an alternative softening method to the ion-exchange system. (WT)

**FORCE FLOW EQUIPMENT** 3467 Golden Gate Way, Lafayette, CA, 94549, USA, Tel: +1-415-284-2200, Fax: +1-415-284-5945, Contact: Susan Peal. Manufacture chlorine scales for 1 ton containers, primarily for the waste water and water treatment industries. Also manufacture scales for stationary 30-60,000 pound tanks.

**GENERAL FILTER CO** 600 Arrasmith Trail, Ames, IA, 50010, USA, Tel: +1-515-232-4121, Fax: +1-515-232-2571, Contact: Bob Inonye. Manufacture water and waste water equipment: softeners, clarifier, packaged filter plants and gravity filter parts and controls.

**GULDAGER SYSTEM** Hejrevang 1-3, Allerød, DK-3450, Denmark, Tel: +45-42-273100, Fax: +45-42-271504, Contact: H Guldager. Production, installation and service of electrolysis systems for the protection against corrosion and scaling in domestic water systems, process water systems and filters for swimming pools, anti-fouling and cathodic protection.

**H B FULLER CO MONARCH DIV** 311 109th Avenue Nw, Minneapolis, MN, 55421, USA, Tel: +1-612-782-1724. Manufactures cleaners and sanitizers for RO/UF membranes and systems used in water purification, biotechnology, food processing and other specialized applications. Products supported by customized programs, technical assistance, analytical testing and consulting.

**HICK HARGREAVES & CO LTD** Crook St, Bolton, Lancs, BL3 6DB, UK, Tel: +44-204-23373, Telex: 63244, Fax: +44-204-395261. Hick Hargreaves blowers are used extensively to provide oil free air for effluent and water treatment. The 2000 and 4000 Series cover capacities from 35 to 9000 M3/hr and larger blowers can be supplied for capacities up to 45,000 M3/hr. Please contact for further details.

**HOWDEN WADE LTD** Crowhurst Rd, Brighton, Sussex, BN1 8AJ, UK, Tel: +44-273-506311, Telex: +87511, Fax: +44-273-557123. Reputable blower manufacturer represented through the world. Equipment utilised extensively for filter air scour and waste water aeration by many potable water authorities and purification plant contractors.

**ROBERT HUDSON (EFFLUENT EQUIPMENT) BECORIT LTD** Hallam Fields Rd, Ilkeston, Derbyshire, DE7 4BS, UK, Tel: +44-602-302603, Telex: 37526, Fax: +44-602-329683, Contact: Mr Hough. Design, manufacture and installation of a range of rectangular tank scrapers, circular tank scrapers and mechanical screens for water, effluent and sewage treatment plants.

**HYPERFIL INDUSTRIES INC** 1170 Van Horne Way, Anaheim, CA, 92806, USA, Tel: +1-714-630-4381, Fax: +1-714-630-2366, Contact: Gene Gilley. Gene Gilley, President of Hyperfil Industries, has over 25 years of experience and research in reverse osmosis technology

from membrane research to desalination of specialised Governmental projects. Research conducted of cellulose acetate, cellulose tri-acetate and thin film composite membranes. Elements available of each type for drinking water applications and water purifying systems. For further information contact Gene Grilley or Yolanda Grilley.

**IDEAL HORIZONS INC** PO Box 1707, Rutland, Vermont 05701 1707 USA Tel: +1-802-773-4346, Fax: +1-802-773-2538. Ideal Horizons manufacture stainless steel ultra-violet disinfection equipment. Our modular systems allow for versatility over a wide range of applications and flow rates. These systems are engineered for durability and performance.

**IMI OPELLA - A DIVISION OF IMI MOULDINGS** Twyford Rd, Rotherwas Industrial Estate, Hereford, HR2 6JR, UK, Tel: +44-432-57331, Telex: 35114, Fax: +44-432-264014, Contact: Ms Seymour. Manufacturers of IMI 400 Series of in-line water filters for domestic and general purpose applications. Basic models available include sediment removal, sediment taste and odour removal, fine sediment removal and bacteriological and fine sediment removal.

**INDUSTRIAL FILTER & PUMP MFG CO** 5900 Ogden Avenue, Cicero, IL, 60650, USA, Tel: +1-312-656-7800, Fax: +1-312-656-7806, Contact: Charles Movotny. Manufacturer of filters, demineralizers and pumps used in the water treatment industry.

**INTERTUBE SYSTEMS LTD** Estover Rd, Plymouth, Devon, PL6, UK, Tel: +44-752-775781, Telex: 45260, Fax: +44-752-777316, Contact: Mr Moat. Automatic and manual lubrication systems for water treatment and associated plants. Also metering pumps for antifoam suppression.

**JENOLITE LTD** Unit 19, Vincent Works, Vincent Lane, Dorking, Surrey, UK, Tel: +44-306-740474, Telex: 268006, Fax: +44-306-740378, Contact: Mr Miller. Jenolite Ltd - serving the water industry worldwide. Aldecon T is formulated specifically for cleaning stainless-steel filters in water-supply undertakings. It removes a wide variety of contaminants, such as hard-water scale, without adversely affecting the stainless-steel substrate.

**JOHNSON FILTRATION SYSTEMS** Johnson House, Browells Lane, Feltham, Middx, TW13 7EQ, UK, Tel: +44-1-751-4424, Telex: 935479 uselon, Fax: +44-1-890-1533, Contact: Mrs Dicker. Manufacturers of well screens for water, oil and gas wells: screens for raw water intakes and water treatment processes. Also drilling fluids and logging equipment.

**JOHNSON FILTRATION SYSTEMS INC** PO Box 64118, St Paul, MN, 55164, USA, Tel: +1-612-636-3900, Telex: 297451, Fax: +1-612-636-3132, Contact: Mr E D Broeders. Supply water well screens, environmental monitor screens and water treatment screens.

**JOHNSON-PROGRESS LTD** PO Box 103, Wright St, Broadheath, Altrincham, Cheshire, WA14 5EF, UK, Tel: +44-61-928-6388, Fax: +44-61-941-7309, Contact: Davy Richie. Complete plants for filtering slurries and sludges



for Reverse Osmosis Systems

# **FLOCON<sup>®</sup> 100** **ANTISCALANT**

The liquid polymeric antiscalant approved by all major membrane manufacturers.

**Safe • Effective • Economical**

Accepted for potable water use by the EPA and regulatory authorities worldwide.

## **FLOCLEAN CLEANERS**

A family of liquid and solid cleaners for both cellulose acetate and thin film composite membranes—effective against both inorganic and organic foulants.

For information, contact Mr. Roy M. Dickinson

Pfizer Inc., Water Treatment Products

235 East 42nd Street, New York, N.Y. 10017

Tel: 212-573-2531 Telex: 234088 RCA

## SPECIALISED EQUIPMENT AND PROCESSES

from water and from domestic/industrial effluent treatment. Product range includes filter presses, filter media, pumps pretreatment and cake handling equipment.

**LASERTRIM LTD** Unit 1, Argyle St Industrial Estate, Hull, HU3 1HD, UK, Tel: +44-482-215335, Telex: 597619, Contact: Gary Church. Lasertrim design and manufacture the CCS - coagulant control system, providing clients with reliable and repeatable water quality. Can also supply project engineering services and additional instrumentation to operate in conjunction with the CCS.

**LEIGH POLLUTION CONTROL LTD** 1 Station Rd, Four Ashes, Wolverhampton, West Midlands, WV10 7DQ, UK, Tel: +44-902-791616, Telex: 335684, Fax: +44-902-791-772, Contact: Mr Spencer. Suppliers of metal finishing products, water treatment and effluent treatment plant, water softeners and deionising equipment etc.

**LENSER KUNSTSTOFF-PREBOVERK GmbH CO KG** Postfach 1309, Senden, D-7913, West Germany, Tel: +49-7307-8010, Telex: 712459, Fax: +49-7307-33275, Contact: Mr Willemer. Lenser produce filter plates and frames, chamber plates and membrane filter plates for solid, liquid dewatering. Filter elements are totally corrosion proof and reduce the transport and disposal cost by higher dry solids.

**LEOPOLD** 227 South Division St, Zelienople, PA, 16063, USA, Tel: +1-412-452-6300, Telex: 866474, Fax: +1-412-452-1377, Contact: Ms Dee Ann Eiphenaver. Leopold manufacture, supply, install and service filter equipment, (clarifiers, filter control systems, instrumentation, fiber-glass, wash troughs, valves and agitators).

**MARSON BROSYSYSTEM** PO Box 154, Halmstad, 30103, Sweden, Tel: +46-35-109-670, Fax: +46-35-11-1194, Contact: Benjt Mahrstron. Specialized in water treatment for aqua culture farming of fish and crustacean. Oxygenation, nitrification, aeration, filtration and heat exchange.

**MET-PRO CORPORATION** P O Box 144, 160 Cassell Rd, Harleysville, PA, 19438, USA, Tel: +1-215-723-6751, Telex: 244903, Fax: +1-215-723-6758, Contact: Bob Reploge. Keystone Filter Division - manufactures cartridge filtration equipment for removal of sediment, taste and odor, lead, nitrates and other undesirable contaminants in drinking water supplier. Systems Division - manufactures packaged water purification systems, clarifiers, carbon treatment systems and gravity and pressure filtration equipment.

**N V AQUAVIA S A** Vosselarestraat 73, Nevele, B-9840, Belgium, Tel: +32-91-71-71-71, Telex: +11477, Fax: +91-71-71-80. Manufacture flotation, filtration (diatomite and sand) and aeration systems. Also install and design, if necessary, mechanical and chemical treatment systems, potable, swimming pool, industrial and municipal treatment.

**NEPCCO** 2140 North East 36th Avenue, Suite 300, Ocala, Florida, 32670, USA, Tel: +1-904-867-7482, Fax: +1-904-867-1320, Contact: Mr Olsen. Manufacturers of recovery well pump systems and air-stripper towers, multi-

well pump controllers, soil venting systems and catalytic converter systems.

**WALTER NOLD COMPANY INC** 24 Birch Rd, Natick, MA, 01760-1696, USA, Tel: +1-617-653-1635. Researched and discovered new process for degasification of fluids which can degas water, for instance, to boilerwater purity. Has opened many fields: nuclear, medical, geotechnical, wastewater treatment, chemical, ultrapure water and electronics. Fast degasification without use of heat.

**NORTHERN GRAVEL CO** PO Box 307, Muscatine, IA, 52761, USA, Tel: +1-319-263-2711, Fax: +1-319-263-2857, Contact: Ms Clarke. Producers of sand and gravel for use in filtration and suppliers of most related process media.

**OLSEN CHEMICAL CO INC** 62 E 26th St, Paterson, NJ, 07514, USA, Tel: +1-201-525-2600. Manufacturer of boiler water treatment for business.

**OSMONICS INCORPORATED** 5951 Clearwater Drive, Minnetonka, MN, 55343, USA, Tel: +1-612-933-2277, Telex: 029-0847, Fax: +1-612-933-0141, Contact: Terri Levonn. Manufacturers of filtration and separation equipment.

**P U K WATER TREATMENT LTD** Unit 11, Weynton Close, Riverside, Medway City Estate, Strood, Rochester, Kent, ME2 4DP, UK, Tel: +44-634-290142, Telex: 966539, Contact: Mr F H Stone. Filtration: Rotary filters for primary or sole filtration and for polishing sewage.

**PENFIELD LIQUID TREATMENT SYSTEMS** 8 West St, Plantsville, CT, 06479, USA, Tel: +1-203-621-9141, Fax: +1-203-621-2380, Contact: Mr Schultz. Manufacturers of filtration, softening, ion exchange, reverse osmosis and water filtration equipment.

**PFIZER WATER TREATMENT PRODUCTS** Chemical Division, 235 East 42nd Street, New York, NY 10017 Tel: +2125732531. Pfizer Water Treatment Products Group, a unit of the Pfizer Inc. Pharmaceutical Corporation, manufactures the FLOCON line of antiscalants specifically designed to inhibit scale formation in reverse osmosis desalination units. Pfizer also sells and distributes the FLOCLEAN cleaners for reverse osmosis membranes and provides a variety of services to the industry including water analysis, membrane autopsies, and computerised dosing programs.

**PREMIER COLLOID MILLS LTD** Hersham Trading Estate, Walton-on-Thames, Surrey, KT12 3PZ, UK, Tel: +44-932-26305, Telex: 25539, Fax: +44-932-253234, Contact: Mr Peart. Manufacturers of flocculators, mixers and agitators specially designed for the effluent and water treatment industries. Range - 0. 25kw to 25kw, direct drive or geared.

**RUSCO CORP** 13360 Chambord St, Brooksville, FL, 34613, USA, Tel: +1-904-596-4200, Fax: +1-904-596-9489, Contact: Russ Welte. Manufacture plastic spin down sediment filters - operating from one to 100 gallons per minute.



## SPECIALISED EQUIPMENT AND PROCESSES

**SCREENING & APPLICATION ENGINEERS LTD**  
SAE House, 409 Hagley Rd West, Quinton, Birmingham, B32 2AD, UK, Tel: +44-21-421-6331, Fax: +44-21-421-2468, Contact: Mr Pittwood. Rotary separators for the removal of suspended and floating solids from liquid flow.

**STRANCO** Box 389, Bradley, IL, 60915, USA, Tel: +1-815-932-8154, Telex: 703480, Fax: +1-815-932-0674, Contact: Diane Anderson. Manufacture polymer injection equipment for potable and waste water applications.

**SULZER (UK) LTD** Westmead, Farnborough, Hants, GU14 7LP, UK, Tel: +44-252-544311, Telex: 858771, Fax: +44-252-518636, Contact: Mr Reeve. Engineers and distributors of mixers for the water and allied industries.

**SYBRON CHEMICALS INC** PO Box 66, Birmingham Rd, Birmingham, NY, 08011, USA, Tel: +1-609-894-8211, Fax: +1-609-894-8641, Contact: Frank Duniono. Sybron Chemicals Inc manufactures and markets ion exchange resins under the Ionac brand name for water softening, demineralization and waste treatment, they also manufacture a complete line of biochem engineered bacteria for waste treatment.

**WATCON INC** 2215 S Main, South Bend, IN, 46613, USA, Tel: +1-219-287-3397, Contact: George Resnik.

Water treatment surveys, testing, chemicals, equipment for industrial, commercial, municipal and institutional requirements.

**WATER—INE S A** Postfach 23, Mezzovico, CH-6849, Switzerland, Tel: +41-91-95-20-62, Telex: 79-559 water ch, Contact: Mr Ari Wostenfeld. Holders of a worldwide patent for the treatment, conservation and packaging of potable water into sterile polyethylene bags, which can be stored for up to five years. The water is kept in perfect condition with no regermination possible.

**WEAVERBROOK LTD** 12 Draycott Rd, Upper Tean, Staffs, ST10 4JF, UK, Tel: +44-538-723777, Telex: 36523, Fax: +44-538-723723, Contact: Mrs Grey. Design and manufacture chemical process plant for the water treatment industry and effluent treatment.

**YSI INCORPORATED** YSI Scientific Ltd, Lysons Avenue, Ash Vale, Aldershot, Hampshire, GU12 5QR, UK, Tel: +44-252-513006, Telex: 858210 INSTCOG, Fax: +44-252-511855. YSI dissolved oxygen and conductivity instruments monitor wastewater treatment and provide environmental control and enforcement. Other YSI systems help maintain pure water supplies by measuring temperature, pH, conductivity and ORP in surface water and groundwater as it's pumped from test wells. YSI instruments assure healthy crops of fish and shellfish in hatcheries and on fish farms.

**KATADYN**

WATER IS LIFE

**Katadyn Multus®**  
Ultraviolet radiation

**Katadyn®-Filter**  
Microfiltration

**Electro-Katadyn®**  
Silver ion method

**Micropur®**  
Tablets, powder and liquid

**Katadyn Products Inc.**  
**Water Purification**  
Industriestrasse 27  
CH-8304 Wallisellen / Switzerland  
Telephone 01/830 36 77  
Telex 826 267 kdyn ch  
Telefax 01/830 79 42

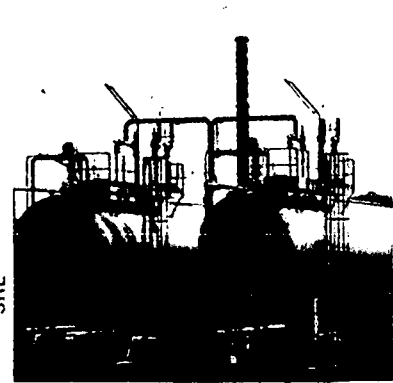
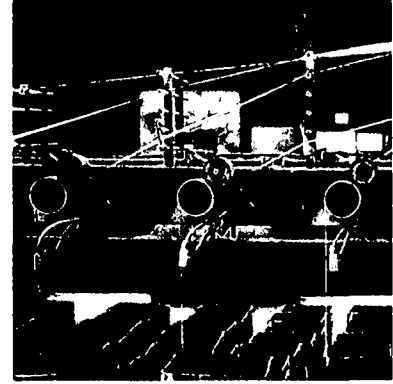
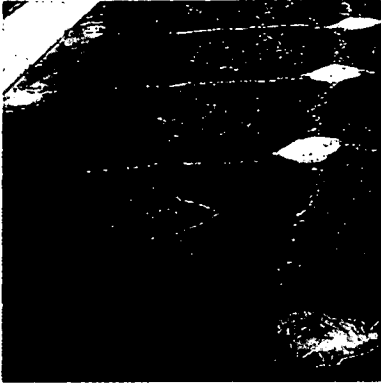

**POLCON** SRL  
**ITALIANA**  
*engineers & contractors*

***Environmental control systems***

Aerobic systems for the biological treatment of domestic and industrial wates

Water quality improvement in natural and man-made impoundments

Eutrophication reversal

Ice prevention in water basins

Pneumatic barriers

Reservoirs oxygenation

Silt prevention in harbours

Anaerobic digestion

Sludges dewatering

Energy and water recovery

***Chemical process engineering***

Natural latex rubber thread production plants

Natural latex gloves production plants

Furfural production plants from agricultural residua

LPG storage, bottling and distribution plants



• Wastewater Treatment •

# TRENDS IN WASTEWATER TREATMENT

By

K. V. Ellis

**The developments in wastewater treatment over the last two decades are such that anyone viewing the situation from the standpoint of some twenty years ago, and bearing in mind the near stagnation in development over the previous forty years, would find it difficult to credit the progress achieved since.**

*Water Hyacinth (Eichhornia crassipes) being used experimentally to remove plant nutrients from treated effluent.*

Of special interest to them would be the fact that the progress made has not only been in the areas of higher technology but also, and substantially, towards simple, low-maintenance, low-cost processes.

However, it must be remembered that the situation in the late 1960s was such that substantial development had become inevitable. The major problems created by the post-war boom in detergent sales had finally been overcome, activated-sludge plants with adequate supplies of air were at last beginning to appear; plastic-media filters were on the horizon and worldwide there was an increasing awareness of the problems of surface water pollution and the necessity for its control.

Since that period, high-rate treatment of wastewater by plastic-media filtration has arrived and served a vital purpose, but is perhaps now significantly on the decline as a result of problems not entirely foreseen in the early days. Another aerobic fixed-film process — that of the rotating biological contactor — has at last proved, after rather a slow start, to be a possibly more enduring success. These plants are now employed not only for the treatment of wastewaters from small communities, but also at larger municipal installations and widely for the treatment of moderate to strong industrial wastes. Designs of activated-sludge plants continue to improve — although not invariably — as the result of better understanding on the part of the designer of the principles of biological treatment. Better effluents can now be produced, more difficult substrates accepted and shorter retention periods employed.

Possibly the most exciting developments with the activated-sludge process have been with the employment of high-purity oxygen systems or perhaps, although not so widespread, with the deep-shaft process. High-purity oxygen has enabled many strong effluents —



hitherto considered to be untreatable by activated-sludge processes — to be stabilized without difficulty and has permitted the upgrading, without great expense, of several periodically heavily overloaded installations. The deep-shaft process has demonstrated a remarkable efficiency coupled with an ability to cope with ex-

tremely difficult wastewaters. The efficacy of this process has been most effectively substantiated by the achievements at the Tilbury works of the Anglian Water Authority in the UK where faith in the process has been demonstrated by the recent commissioning of a second major shaft.

Still, with activated sludge the oxidation ditch has evolved from a crude and not totally reliable innovation to a refined process available in several interesting modifications capable of producing high-quality effluents without recourse to tertiary treatment. And, not dissimilarly but at a cheaper level, the simplicity and effectiveness of aerated lagoons is making this adaptation of the stabilization pond system very attractive for the treatment of many varieties of industrial wastewater.

Of importance over recent years has been the realisation that the reasons for treating wastewater prior to discharge are not invariably the same in all situations. Whereas the satisfaction of oxygen demand prior to the discharge of an effluent to a receiving stream may be the principal concern in many countries,

## WASTEWATER TREATMENT

it is the removal of potentially pathogenic micro (and other) organisms which exercise the ability of the wastewater treatment plant designer in the developing world. This awareness has encouraged significantly the development of the stabilization pond system and has led to its acceptance as one of the principal techniques of water pollution control. Although a definitive design approach is still awaited, pond systems can be constructed either primarily to satisfy oxygen demand or to produce a pathogen-free effluent — or both. The simplicity, low-maintenance costs and reliability of these ponds have fostered their spread, not only in North America where they had their origins and to the developing world, where almost invariably they must be the first choice for

ter treatment are perhaps exemplified by Biological Fluidized Bed (BFB) plants in which a small-sized medium (400  $\mu\text{m}$ ) is employed in an upflow reactor utilizing an oxygen enriched feed. Micro-organism concentrations of about five times those of conventional activated-sludge plants are possible in these units, no final settlement is required and there is a potential for the production of a highly-concentrated waste sludge. Installation costs tend to be relatively low but operational costs are high, being especially related to the provision of oxygen and the need for substantial recycling. There are few operational plants at present but it is a process that must be watched.

Possibly the most dramatic recent developments in

*A high-rate plastic media filter treating wastewater from soft-drinks manufacture. (Bangkok, Thailand.)*

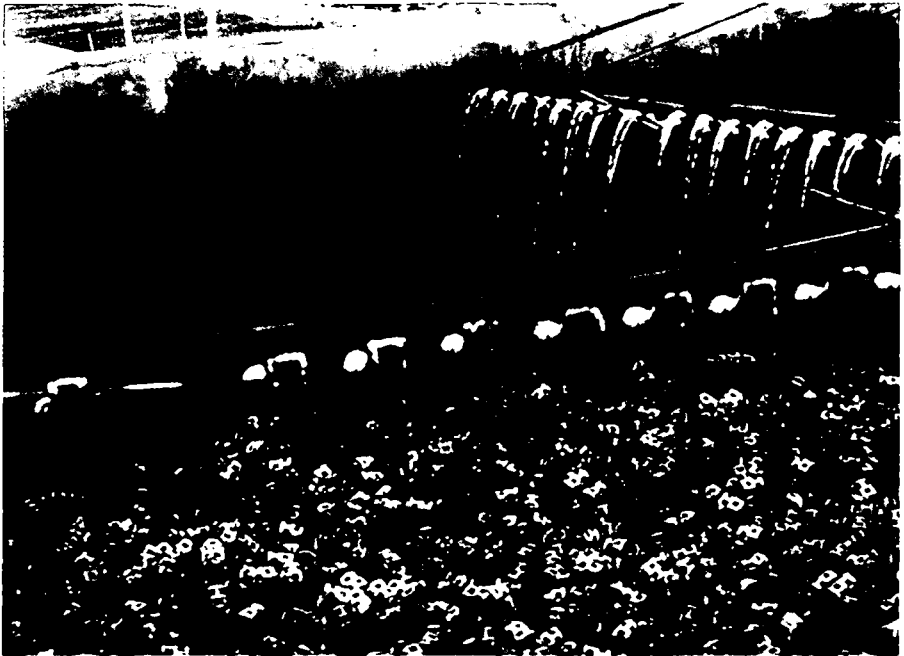

wastewater treatment, but increasingly into Europe and there are even expectations that the conservative British industry may be beginning to consider their advantages.

Simple, low-technology treatment techniques have certainly become more acceptable recently within the wastewater industry with much thought and endeavour being put into root-zone treatment, the results of which have not perhaps always lived up to early expectations. Floating macrophytes, as an example of simple technology, are now used both to remove troublesome nutrients from treated effluents and also for the full treatment of wastewater, but the problems of harvesting and disposal have not yet been entirely overcome. Algae may also provide, in the future, an effective means of reducing the eutrophying influence of treated effluents on receiving waters but at present the effective means available for separating them finally from the effluent tend to be of an incompatible and expensive higher technology.

Higher technology developments in the wastewa

ter treatment have been associated with anaerobic treatment. As a result, anaerobic treatment has changed from being the Cinderella of the treatment processes, suitable only for the partial stabilization of sewage sludges to a varied, high-loading, low-cost-effective means of reducing high oxygen demands. In addition to the anaerobic contact process (anaerobic activated-sludge), attached growth processes using either fixed inert media or mobile fine-media in either the fluidized-bed or expanded-bed modes have been developed. More recently an upflow anaerobic reactor is now in operation employing an anaerobic sludge with excellent settlement characteristics. Loadings are high at up to 16 kg COD/ $\text{m}^3\cdot\text{d}$ . and with claims sometimes considerably higher. In addition, it is weaker wastes of a strength comparable with those of municipal wastewaters that are now attracting the interest of the researcher. The field of anaerobic treatment is dynamic and vital and much further development can be expected in the not too distant future. ◦

# Waterbirds of a feather

PWT is active world-wide offering process design, engineering and contracting; products and speciality chemicals for water, effluent, sewage and process liquids treatment.

One of the world's leading water treatment groups, combining the experience and expertise of autonomous specialist operating companies in Europe, Middle East, Africa, Asia, Australasia and USA.

Each company produces products and services appropriate for local needs.

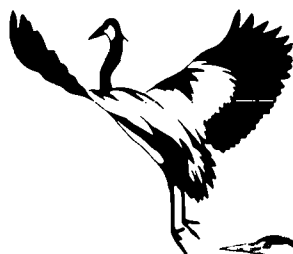

WORLDWIDE

together at **PWT...**

#### The Companies:

PWT Projects Ltd  
incorporating Paterson  
Candy International and  
Permutit-Boby Projects.

The Permutit Company Ltd.

Stella-Meta Filters Ltd

Eta Process Plant Ltd.

PCI Membrane Systems Ltd.

Portacel Limited.

F W Talbot & Company Ltd.

Houseman BV.

Homé Waterbehandeling BV.

Houseman NV.

PWT Projects Iraq.

PWT Egypt.

PWT Projects (Nigeria) Ltd.

PWT (Singapore) Pte. Ltd.

Teknologi Air Patcandy  
Sdn. Bhd.

PWT (Hong Kong) Ltd.

Permutit-Boby Australia  
Pty. Ltd.

PWT New Zealand Ltd.

L\* A Water Treatment Corp.

#### Group Activities:

##### Process Design, Engineering & Contracting

- Potable Water ■ Sewage
- Industrial Water
- Effluent ■ Mass Transfer

##### Products

- Industrial Water Treatment
- Household Water Softeners
- Speciality Filtration
- Membranes ■ Chlorination
- Water Filtrings
- Packaged Sewage Treatment
- Mobile Water Purification
- Tower Packings & Internals
- Cooling Towers

##### Speciality Chemicals

- Boiler Water
- Cooler and Humidifying
- Chemical Cleaning
- Lab/Site Monitoring Service



**PWT WORLDWIDE**  
Oldfield Lodge, 156 Bridge Road  
Maidenhead, Berkshire SL6 8DG  
Tel. (0628) 771444  
Telex 849067 PWT MHD  
Fax (0628) 771567

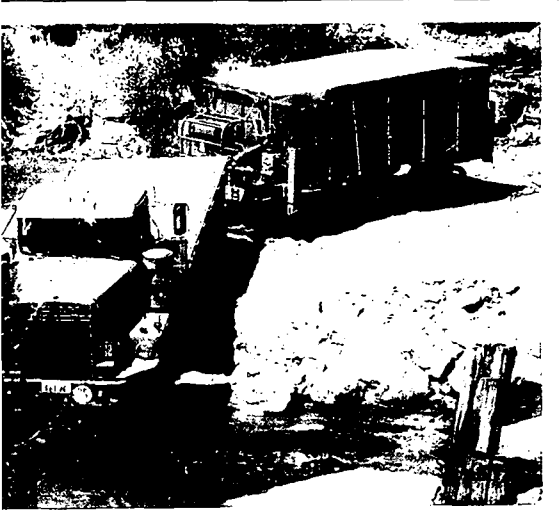

## ... we meet your needs

Everyone's water and wastewater needs are different but PWT companies worldwide provide expertise and equipment appropriate to local requirements. We provide rural and urban schemes using a variety of materials and construction methods. We have also developed mobile units to provide safe drinking water during emergencies. For disinfection we

manufacture a highly innovative range of gas chlorination equipment. For water conservation we produce the "Tallo" standpost valve. Our couplings and fittings for underground water mains and service connections are specified by water authorities in more than sixty countries. And our training programmes ensure continuing efficiency.

**PWT, essential for social and economic progress**

## ADVERTISEMENT FEATURE

### PORTALS WATER TREATMENT PWT (WORLDWIDE)

PWT has emerged over the last decade as a major international company in the water and waste water treatment field.

PWT has responded to its increasing international activities (currently some 80 per cent of PWT's activities are outside of the UK and over half of these are within the Developing World).

PWT breaks its business into sectors ie, Design and Contracting, Chemicals, Products and Services, and Pipeline Products.

The Design and Contracting activity is represented in the UK by PWT (Projects) which combines the previous activities of Paterson Candy International and Permutit-Boby Projects.

PWT (Projects) employing 500 people based in Isleworth, Middlesex, designs and builds projects in all sectors ie, municipal, water and sewage, power stations, steel works, the food industry etc. Some typical examples are the major water works at Ankara in Turkey and Baghdad in Iraq - schemes with values in the 100 million US\$ or more area. The company also handles small specialist industrial packages such as filtration packages for offshore oil rigs with sales values of under a million US\$ but utilising the companies' design and drafting facilities to the full - particularly CAD.

Recent orders received by PWT (Projects) in 1989 include the key component water treatment plant which forms part of the largest Japanese OECF financed project for the Uttar Pradesh State Electricity Board in India. The contract, with a value approaching 30 million US\$, is to supply and supervise the building of the water treatment plant for the 2 x 500 MW Anpara 'B' power station. The company has also, this year, received an order from the Iraqi Ministry of Industry and Military manufacturing with a value approaching 20 million US\$ for the water treatment plant associated with Al Shamal power station.

The other big order so far this year has been in Egypt for NOPWASD with the award of the Beheira potable treatment plant funded by the World Bank (value c. 15 million US\$).

PWT has other major contracting companies in the USA (L\*A Water Treatment) and in Australia (Permutit Boby Australia) with further companies in New Zealand, Singapore, Kuala Lumpur and Hong Kong.

These companies form a major part of PWT's international design and contracting abilities and their competence is perhaps best illustrated by reference to two current projects. L\*AWT is handling the turnkey Provincial Cities contract for Beni Suef, Fayoum and Minia in Egypt. The contract with a value of 58 million US\$ includes three new drinking water plants, modernising various sewage pumping stations, leak detection surveys - overhead storage tanks, new connection mains. In fact, a complete modernisation of water treatment and sewage facilities in the three cities. Permutit-Boby Australia has recently commissioned the Bayswater power station 'zero discharge' water treatment plant. This plant, sometimes called the World's largest industrial treatment plant, exemplifies PWT's diverse contracting skills perfectly, including as it does clarification, filtration, ion exchange makeup, condensate polishing, reverse osmosis, sludge concentration, complex recycling loops and sophisticated control systems.

PWT's Chemical activities cover the full range of specialist chemical supply and the attendant vital service element. PWT has chemical companies in the UK, Holland, Australia and New Zealand with operating subsidiaries of these in the Middle East and Far East. PWT's chemical expertise is particularly strong in the commercial area ie, air conditioning, cooling systems etc, and its work in the Legionella prevention area.

PWT incorporates a number of companies offering specialised Products and Services.

THE PERMUTIT COMPANY LIMITED handles standard industrial water treatment plant - Permutit has an unrivalled reputation throughout the UK and over the last years has introduced its 'Scion' and 'Hipol' ion exchange systems confirming its reputation for service and innovation. Permutit exports its standard products throughout the world.

STELLA-META FILTERS specialises in fine filtration and particularly has achieved success in the developing world with its well proven range of mobile water treatment plant both for civilian and military use

ETA PROCESS PLANT LIMITED is a mass transfer company with particular knowledge of gas/liquid separation technology. Many product oil rigs are equipped with Eta gas stripping towers.

PORTACEL LIMITED designs and manufactures a comprehensive range of gas and chlorination equipment.

PCI MEMBRANE SYSTEMS LIMITED designs and manufactures ultrafiltration and reverse osmosis systems for application in the food and pharmaceutical industry. Typical of such applications are concentration of milk whey, tomato juice and fruit juices. PCI produces its own membranes and prides itself on its technical innovation, particularly its ability to produce membranes for specific customer requirements. PCI Membrane Systems is the unchallenged world leader in its field.

PWT has specialist companies around the world including Btu producing a range of specialist strainer and heat exchangers; Warren producing a range of presses for sludge, waste etc, and Marley Cooling Towers in Australia.

F W TALBOT AND COMPANY LIMITED based in Winchester in the UK, produces a range of water pipes and fittings. Talbot leads its field and is justly proud of the success of its range of 'Pushfit' water service fittings, which provide for quick and reliable installation of polyethylene pipework and have set new standards in the industry.

PWT continues to grow internationally and as part of this growth was pleased with the agreement reached between Portals Holding PLC (PWT's parent company) and Thames Water Authority in the UK in April 1989 which enables Thames and PWT to work closely together culminating in Thames Water purchasing PWT once Thames Water is privatised ie, floated on the London stock market. Flotation is expected at the end of 1989.

THAMES WATER owns and operates the UK's largest drinking water and waste water network and sells its operational skills around the world. The combination of Thames and PWT will create an organisation able to offer solutions to all the water and waste water treatment requirements of the Developing World.





# BIOLOGICAL TREATMENT

## Biological Treatment

**AERATION INDUSTRIES INTERNATIONAL INC** 4100 Peavey Rd, Chaska, Minnesota, 55318, USA, Tel: +1-612-448-6789, Telex: 910-5780838, Fax: +1-612-448-7293, Contact: Jane Runyon. Aire-02: A patented aspirator aerator. Mixes and circulates the water in a horizontal fashion, a necessary factor in the biological treatment of wastewater.

**AQUA-AEROBIC SYSTEMS INC** P O Box 2026 6306 North Alpine Rd, Rockford, Illinois, 61130-0026, USA, Tel: +1-815-654-2501, Fax: +1-815-654-2508, Contact: Carol S Zies. Aqua-Aerobic Systems Inc is a designer/manufacturer of equipment used in the biological treatment of water and wastewater. Equipment includes: direct drive aerators, direct drive mixers, automatic backwash filters and a sequencing batch reactor (SBR) system.

**AQUARIUS WATER PURIFICATION LTD** Unit 12, Craven Court, Winwick Quay, Warrington, Cheshire, UK, Tel: +44-925-445144, Telex: AQUA 627151, Fax: +44-925-413524. Aquarius 150 for controlled chlorination of raw and municipal water.

**AUREPA FAHRZEUGWERKE HEITGER GmbH & CO** 11 Industriestrasse or P O Box 14 80, Hockenheim-Talhaus, D-6832, W Germany, Tel: +49-6205/2006-0, Fax: +49-6205/8324, Contact: Mr W W Pfisterer. Supply of Biofiltromat compact units for biological cleaning of waste water in particular from industrial productions with special filter and oxygen supply for activating the biological process. By adding further fine filters, purified water can be used for industrial or drinking water. The Biofiltromat process is environmentally beneficial.

**BIOLOGISCHE VERFAHRENS-TECHNIK GESELLSCHAFT M b h** Arlbergstrasse 139F9 Bregenz, A-6900, Austria, +43-557437-7-002, Fax: 57430 manal a. BVT have developed an up-to-date high-economy digester for the anaerobic treatment of the highly polluted waste water and sludges occurring in the agro-industry and for the liquid and solid manure from farms and intensive livestock raising enterprises. The production of methane, the high waste water cleansing rate and the high quality of the manure make the digester a paying proposition and ensure maximum environmental protection.

**BIOSCIENCE MANAGEMENT INC** 1530 Valley Center Parkway Suite 120, Bethlehem, PA, 18017, Tel: +1215-974-9693, Fax: +1215-6912170, Contact: Carol E Downey. Bioscience Management Inc is an environmental biotechnology company, manufacturing and marketing specialized bacterial products for enhancement of industrial wastewater treatment (biological). We also carry a line of respirometric instrumentation for monitoring of biological degradation. BMI also has a fully equipped laboratory which is capable of performing biodegradation feasibility studies for organic contamination in soil and/or groundwater.

**BS FLOCOR LIMITED** E5 Stafford Park 15, Telford,

TF3 3BB, UK, Tel: +44-952-290350, Telex: 35835, Fax: +44-952-290353. Suppliers of patented Flocor® plastics biofiltration media for sewage and effluent treatment, MAT Aerators and Cyclomat units for aeration of lagoons, fish farms, lakes and sewage treatment. Also Photozone activated air systems for sterilisation of water.

**CARBORUNDUM ABRASIVE GB LTD** P O Box 55, Trafford Park, Manchester, M17 1HP, UK, Tel: +44-61-872-2381, Telex: 667344, Fax: +44-61-872-1471, Contact: Mr Towers. Supply a range of vitrified effuser products used in the aeration technique of sewage management. Manufacture both domes and discs to exacting standards and to a precise permeability.

**DAVIS-EMU** 1706 Metcalf Avenue, Thomasville, CA, 31792, USA, Tel: +1-912-226-5733, Fax: +1-912-226-4793, Contact: Harry Roufe. Manufacturer of submersible sewage pumps and aeration equipment.

**DEEP SHAFT TECHNOLOGY INC** 801 York Mills Rd, Don Mills, Ontario, M3B 1X7, Canada, Tel: +1-416-391-5616, Fax: +1-416-391-1326, Contact: Paul G Daly. Deep Shaft Technology Inc, are a drilling company and process engineering firm specializing in a unique wastewater treatment process. The Deep Shaft process is a biological treatment system utilizing a totally enclosed steel cased reactor 200-500 ft deep. This process treats both municipal and industrial wastewater.

**ECOLOGICAL LABORATORIES INC** Box 123, 123 Henry St, Freeport, NY, 11520, USA, Tel: +1-516-379-3441, Fax: +1-516-379-3632, Contact: Robert Berger. Manufacturer of bacterial products for the waste water industry.

**EFO INTERNATIONAL LTD** Bath Rd, Padworth, Reading, Berkshire, RG7 5HR, UK, Tel: +44-734-712648, Telex: 848673 EFO G, Fax: +44-734-712901, Contact: Mrs Boks. Designers, suppliers and contractors to the waste water industry with both aeration and rbc based treatment systems. Suppliers of Sewpass sludge handling equipment and earth anchors.

**EL-CAR PATERSON CANDY IT SRL** Via G Di Vittorio 307/5, Sesto, San Giovanni, 20099, Italy, Tel: +39-2-2424841, Telex: +326166 Elcar I. Design, construction and installation of equipment and full plants for water treatment.

**FILTROS PLANT FERRO CORP** 603 W Commercial St East, Rochester, NY, 14445, USA, Tel: +1-716-586-8770, Fax: +1-716-586-7154, Contact: Dick Veeper. Filtrors diffusers consist of porous ceramic materials in the shape of tubes, plates, discs and domes. Diffuser tube and disc assemblies are offered for connection into an air supply to provide small-bubble aeration for sewage treatment. Porous ceramic filter plates are used for underdrains in water filtration facilities.

**GENERAL ENVIRONMENTAL SCIENCE CORPORATION** PO Box 22294, Beachwood, Ohio, 44122, USA, Tel: +1-216-795-4733, Fax: +1-216-795-1311, Contact: Barton Gilbert. Manufacturer of the LLMO® system products which are bacterial suspensions used in waste and wastewater treatment systems to enhance



# Biological Products

## THE ICI DEEP SHAFT PROCESS

A HIDDEN SOLUTION TO YOUR EFFLUENT BOD PROBLEMS

The Deep Shaft process has a proven track record in reliable treatment of a wide range of wastes including domestic, industrial, food, alcohol, pulp and paper etc.

### PROCESS CHARACTERISTICS

- ◆ **LOW POWER COST:**  
*3.0 – 4.0 kg BOD/kWhr*
- ◆ **LOW LAND AREA:**  
*10 – 20% of conventional requirements*
- ◆ **LOW CAPITAL COST:**  
*can cost less than 50% of the capital of a conventional process*
- ◆ **HIGH O<sub>2</sub> TRANSFER RATE:**  
*more than 3 kg O<sub>2</sub>/m<sup>3</sup>/hr*  
*High strength wastes? No problem!*
- ◆ **NO SMELL, NOISE, MIST OR SPRAY**

These are just some of the advantages of the ICI Deep Shaft Process

***Shouldn't you be using it?!***

### CONTACT:

Dr. Peter R. Fields, Manager  
Waste Water Treatment Business

ICI Biological Products

PO Box 1, Billingham  
Cleveland TS23 1LB  
ENGLAND

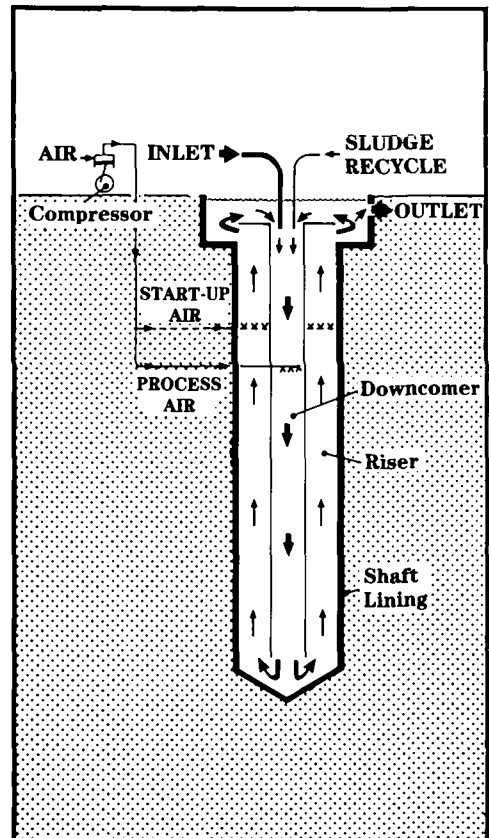

Telephone: England (0642) 523786

Fax: England (0642) 522676

Telex: 587443 ICIAGH G

## THE ICI DEEP SHAFT PROCESS

In the mid 1970's ICI developed a new process for aerobic effluent treatment called the ICI Deep Shaft Process. The heart of the process is the Deep Shaft with its head tank. The Deep Shaft is most often between 50–100m deep and is divided into two parts known as the downcomer and the riser. The air is injected mainly into the downcomer and circulation is brought about by the air-lift effect based on the relative difference between the voidage in the downcomer and the riser. It is a basic feature that the influent feed to the shaft circulates in this manner many times on average before being discharged. The influent is thus very rapidly mixed with the entire mass of activated sludge so ensuring very high resistance to shock loads.

The solubility of the oxygen in the water at the bottom of the shaft can be ten times that at the surface and the residence time of the air bubbles is several minutes. These factors plus the high turbulence of the liquid in the shaft give rise to very good power efficiencies (e.g. 3–4 kg O<sub>2</sub>/kWhr) and a higher capacity for oxygen transfer (> 3kg O<sub>2</sub>/m<sup>3</sup>/hr) than any other process. The process has a typical hydraulic residence time of 1–2 hours and, thus, has a total process volume which can be less than 10% of a conventional process. The MLSS exit the Deep Shaft can be degassed using a vacuum degasser or coarse bubble aerator before being passed to a conventional design of sedimentation clarifier. In certain circumstances a degasser is not used but the sludge is separated by a flotation type clarifier.

Examples of typical applications of the Deep Shaft process are given as follows:

Location	Start-Up	Shaft Depth (m)	Shaft Size Diam (m)	Type of Waste	BOD Load (kg/day)	BOD In (mg/l)	BOD Out (mg/l)
Barrie, Canada	1980	150	14	BREWING	5,230	2,400	100
Leer, Germany	1981	80	26	MUNICIPAL	12,480	830	80
Kashima, Japan	1983	100	20	PHENOL	3,380	2,000	150
Numazu, Japan	1984	50	28	FISH	10,440	17,400	120
Osaka, Japan	1985	44	12	DOMESTIC	329	500	20
Tilbury, U.K	1987	60	5.8	MUNICIPAL	26,000	600	60
Tokyo, Japan	1987	100	34	PULP/PAPER	4,500	500	15
Tokyo, Japan	1988	60	10	DOMESTIC	136	135	8

The selection of Deep Shaft to treat a particular duty can be for a number of reasons including low land use, low capital cost, low running cost and good resistance to peak loads. As an example

of savings in land and capital cost, the Tilbury plant (see Table opposite) is currently treating the waste from a population equivalent of approximately 500,000. The total cost of this plant was less than £9 million (i.e. < £18/population equivalent). The area of this Tilbury plant, broken down in sections, is as follows:

	Plant Area	Population Equivalent/m <sup>2</sup>
Main Aeration Section (Shaft + Head Tank)	264 m <sup>2</sup>	1,900
Shaft plus Sludge-Degassing Lanes	1,500 m <sup>2</sup>	333
Full Plant (Shaft, Degasser, Compressors & Clarifiers)	7,000 m <sup>2</sup>	70

A photograph of the Tilbury plant is shown below.

The aforementioned details were presented to give a better understanding of the characteristics of Deep Shaft. Since ICI took the decision to license the process in the late 1970's there have been a steadily increasing number of plants operational around the world. Experience has shown that when Deep Shaft is used to treat a particular effluent it is undoubtedly the preferred process based on capital and operating costs. This is especially so in these days of increasing concern over the environment where the added advantages of reduced odour, low land usage and flexibility gives Deep Shaft an overall performance which is difficult to find in any other competing process.

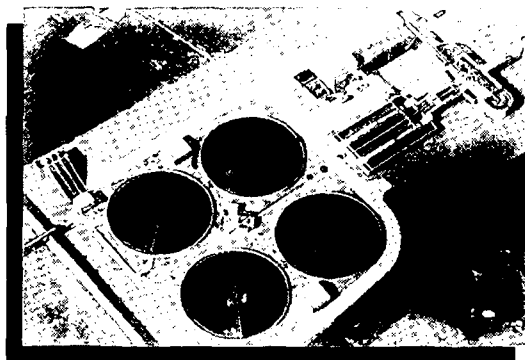

*Aerial Photograph of  
Tilbury Plant*

*The Municipal treatment plant at Tilbury (London UK). The twin-shaft head tank is shown in the upper right of the picture attached to the 4 sludge degassing lanes. This feeds to the 4 clarifiers shown. The building is the compressor house and control centre.*

## BIOLOGICAL TREATMENT

efficiency, reduce and/or remove sludge from treatment plants and lagoons, used where grease and fats are a particular problem and for nitrification and denitrification in wastewater treatment and aquaculture.

**HICK HARGREAVES & CO LTD** Crook St, Bolton, Lancs, BL3 6DB, UK, Tel: +44-204-23373, Telex: 63244, Fax: +44-204-395261. Hick Hargreaves blowers are used extensively to provide oil free air for effluent and water treatment. The 2000 and 4000 Sseries cover capacities from 35 to 900 M3/hr and larger blowers can be supplied for capacities up to 45,000 M3/hr. Please contact for further details.

**HOWDEN WADE LTD** Crowhurst Rd, Brighton, Sussex, BN1 8AJ, UK, Tel: +44-273-506311, Telex: +87511, Fax: +44-273-557123. Reputable blower manufacturer represented through the world. Equipment utilised extensively for filter air scour and waste water aeration by many potable water authorities and purification plant contractors.

**ICI BIOLOGICAL PRODUCTS** PO Box 1, Billingham, Cleveland, TS23 1LB UK Tel: +44-642-523786, Telex: +587443 ICIAGH G, Fax: +44-642-522676. ICI has a worldwide network of licensees who can provide design, construction and commissioning of its Deep Shaft process technology. The Deep Shaft process is increasingly used to treat a range of effluents, including domestic, industrial, food, alcohol, pulp and paper etc. Low running cost, low capital cost, high oxygen transfer rate and low land area are just some of the advantages.

**IDEAL HORIZONS INC** PO Box 1707, Rutland, Vermont 05701 1707 USA Tel: +1-802-773-4346, Fax: +1-802-773-2538. Ideal Horizons manufacture stainless steel ultra-violet disinfection equipment. Our modular systems allow for versatility over a wide range of applications and flow rates. These systems are engineered for durability and performance.

**INNOVA-TECH INC** P O Box #920, Valley Forge Corporate Center, Valley Forge, Pennsylvania, 19481, USA, Tel: +1-215-666-9080, Fax: +1-215-666-1766. The Innova-Tech Total Barrier Oxidation Ditch (TBOD) features: High oxygen transfer efficiency, independent control of pumping and aeration leading to excellent process control, design flexibility - round, square or conventional, nutrient removal capabilities, available for municipal or high strength industrial final treatment, design and process assistance available at no extra cost.

**INTERNATIONAL BIOCHEMICALS LTD** Galvin Rd, Slough, Berkshire, SL1 1DL, UK, Fax: 44-753-71551, Contact: Mr Geoff Johnson. 44-753-694201 846776 int bio Car Phone: 08365-07469

**MASS TRANSFER INTERNATIONAL**, Haversham, Cumbria, LA7 7EB, UK, Tel: +44-4482-3851, Telex: 65145, Fax: +44-4482-2729, Contact: Mrs S Whittaker. World leaders in the design and supply of low-energy, anaerobic and nitrification effluent treatment plant. Over 2,000 plants worldwide, treating an extensive range of industrial and municipal effluents.

**CARL MUNTERS AB** Box 7093, Sollentuna, S-19107, Sweden, Tel: +46-8-754-7100, Telex: 15921 Munters s, Fax: +46-8-754-5666, Contact: Mr Erik Andersson. Suppliers of de-humidifiers, evaporative cooling systems for animal housing, non-inflammable glass fibre materials, cooling towers, comprehensive moisture control services for post-flood and fire problems.

**NORTHEY ROTARY COMPRESSORS LTD** Alder Rd, Parkstone, Poole, Dorset, BH12 4BB, UK, Tel: +44-202-741725, Telex: 41444, Contact: Mr Parsons. Oil-free gas compressors for the recirculation of Bio Gas in anaerobic digestion. Oil-free compressors for aeration purposes, and oil-free vacuum pumps.

**NSW ENVIROMENTAL SYSTEMS** PO Box 1464, Nordenham, D-2890, West Germany, Tel: +49-4731-82-224, Telex: 238315 NSW D, Fax: +49-4731-82-301, Contact: Mr David Buckley. Biological sewage treatments for domestic and industrial sewages, stripping towers for water and process engineering industries, biological denitrification systems, air pollution control equipment for acidic oil and elimination. Please contact for further details.

**PANNONPLAST WORKS** P O Box 30, Budapest, H-1400, Hungary, Tel: +36-1-225-849, Fax: +36-1-229-228, Contact: Jozsef Lazar. Production, design and supply of plastic modules for biological trickling filter towers, and rotating biological contractors. The company has 4 plants and 1800 staff.

**POLCON ITALIANA SRL** 45 Viale Scarampo - Milan, 20148, Italy Tel: +023272321333, Telex: +331832 POLCON, Fax: +02347546. Polcon Italiana S.r.l., established in 1975, is active worldwide in the environmental pollution control and in the chemical process engineering. Services offered range from preliminary feasibility studies to the engineering and realisation of projects and include the training of staff to properly run the plant. Plant we deal with relate to: Domestic - Municipalities, Hospitals, Resort facilities, Hotels and the like. Industrial - Galvanic, Automotive, Mechanical, Electronic and Electric, Photoengraving, Photography, Chemical, Pharmaceutical, Iron Metallurgy, Petrochemical, Textile, Tannery, Wood Processing and Paper Mills, Ceramic, Rubber. Breeding Facilities - Foodstuffs and Agricultural produces processing Industries, such as: Swine, Minks and Cattle Breeding; Slaughter-Houses; Production of Salami, Olive-Oil, Wine, Spirits, Beverages, Ice-Cream, Frozen and Tinned foodstuffs, etc. Mixtures of industrial and domestic wastes. Oxygenation of natural and man-made impoundments; Pneumatic Barriers; Ice-Prevention Systems. Oil and Metal recovery from wastes; Recovery of Proteins (Olive Oil and Fat industrie); Spring-waters conditioning; Sludges Dewatering; Re-Utilisation of Bio-Gas developed during anaerobic fermentation.

**POLIMEX - CEKOP LTD** 7/9 Czackiego Str, Warszawa, 00-950, Poland, Tel: +48-26-80-01, Telex: 814231, Fax: +48-26-04-93. Polimex Cekop Ltd fights pollution of the environment and ensures clean water, offering: services of our specialists in research and design works of wastewater processing methods, deliveries of biological sewage treatment plants for campsites, and hotels.

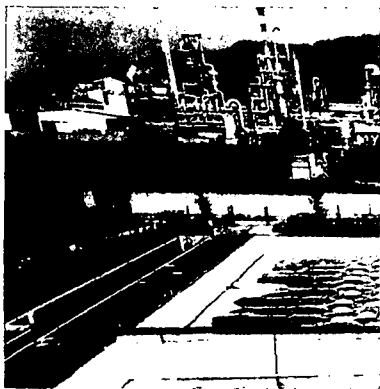

**engineers & contractors**

**Environmental control systems**

Aerobic systems for the biological treatment of domestic and industrial wates

Reservoirs oxygenation

Water quality improvement in natural and man-made impoundments

Silt prevention in harbours

Eutrophication reversal

Anaerobic digestion

Ice prevention in water basins

Sludges dewatering

Pneumatic barriers

Energy and water recovery

**Chemical process engineering**

Natural latex rubber thread production plants

Furfural production plants from agricultural residua

Natural latex gloves production plants

LPG storage, bottling and distribution plants

**POLYBAC CORPORATION** 954 Marcon Boulevard, Allentown, PA, 18103, USA, Tel: +1-215-264-5740, Fax: +1-215-264-8013. Biomass engineering firm providing services to commercial, industrial and municipal clients. Develop, manufacture, distribute and sell specialized microbes and related biochemicals, equipment and speciality chemicals for pollution control.

**PURAC AB** PO Box 1146, Lund, S-22105, Sweden, Tel: +46-46-135100, Telex: 8305083, Fax: +46-46-14-6988, Contact: Mr Erik Sander. Low-energy two-stage biological systems applicable to many wastewater treatment problems to economically meet stringent effluent standards. Some plants have as much as 20 tons BOD<S5>-load per day.

**PURATOR KLÜRANLAGEN** Goldegasse 2, Wien, A-1040, Austria, Tel: 43-222-65-67-85, Telex: 132716. Purator specialist in: sewer, separator and sewage clarification engineering. The line-up embraces: installations for conveying waste water from point of origin to sewer (eg manhole covers, gullies etc), petroleum, grease and starch separators, biological clarification plants for sewage, industrial and municipal waste waters (eg activated-sludge plants, bio filters, trickle filters, etc).

**SHERIDAN PRODUCTS** 4591 W Overlook Drive, Williamsville, NY, 14221, USA. Formulator of specially selected bacterial cultures for pollution abatement and order control.

**SOLMAR CORP** 625 W Katella Avenue Suite 5, Orange, CA, 92667, USA, Tel: +1-714-538-0881. Manufactures of advanced bio cultures for enhancing wastewater treatment, controlling malodors, and degrading fats and oils. Heavily involved in degradation of organic hazardous wastes.

**SYBRON CHEMICALS INC** PO Box 66, Birmingham Rd, Birmingham, NY, 08011, USA, Tel: +1-609-894-8211, Fax: +1-609-894-8641, Contact: Frank Duniono. Sybron Chemicals Inc manufactures and markets ion exchange resins under the ionac brand name for water softening, demineralization and waste treatment, they also manufacture a complete line of biochem engineered bacteria for waste treatment.

**TECH-LINE INSTRUMENTS/ARTECH INTNT'L** Tri Campus Park P O Box 1236, Fond du Lac, WI, 54936, USA, Tel: +1-414-922-6970, Fax: +1-414-922-1085, Contact: Robert M Arthur. Manufactures and sells automated laboratory and on-line respirometers that provide real time biological information used in monitoring and controlling the wastewater process. Applications include process control, troubleshooting of biological processes, toxicity-treatability testing, anaerobic digestion-short term BOD testing, compost testing and plant design. Sample chambers from 250ml - 10L and up.

**WAAGNER-BIRÉ** Stadlauer Strasse 54, Wien, Aktiengesellschaft, A-1220, Austria, Tel: +43-222-2244, Telex: 134827 awbwa. The environmental engineering division of Waagner-Biré offers the following: biological waste water treatment, sewage purification systems for municipal and industrial effluents.

### Chemicals for Wastewater Treatment

**ALLIED COLLOIDS LTD** P O Box 38 Low Moor, Bradford, W Yorks, BD12 0JZ, UK, Tel: +44-274-671267, Telex: 51646, Fax: +44-274-606499, Contact: Graham Dawson. Suppliers of high efficiency chemicals specifically designed for solids/liquid separation processes within the potable water, sewage and industrial waste water fields. The unit processes which can benefit both technically and economically from the application of these products include sedimentation, flotation, thickening and dewatering.

**AMERICAN INTERNATIONAL CHEMICAL INC** 27 Strathmore Rd, Natick, MA, 01760, USA, Tel: +1-617-655-5805. Suppliers of chemicals for the water and waste water treatment industries: potassium permanganate, sodium fluoride, sodium hexametaphosphate, copper sulfate, sodium chlorite and more. (WT)

**AMERICAN NORIT CO INC** 420 Agmac Avenue, Jacksonville, FL, 32205, USA, Tel: +1-904-783-6406. Manufacturer of a wide range of activated carbons designed to deodorize, decolorize, clarify or purify water, waste water or process stream. A wide variety of unique pore size carbons are available to solve tough treatment problems. (WT)

**AQUARIUS WATER PURIFICATION LTD** Unit 12, Craven Court, Winwick Quay, Warrington, Cheshire, UK, Tel: +44-925-445144, Telex: AQUA 627151, Fax: +44-925-413524. Aquarius 150 for re-cycling waste water.

**BK LADENBURG** Dr Albert-Reimann-Strasse 2, Ladenburg, D 6802, West Germany, Tel: +49-6203-77-4307, Fax: +49-6203-1-2818, Contact: Ferdinand Puhe. The use of Labufloc®, a series of organic high-molecular flocculants, improves the economical and technical quality of the following water or waste water purification: sedimentation, flotation, static and pressure filtration, sludge thickening and dewatering.

**BOLIDEN WATER TREATMENT** P O Box 902, Helsingborg, S-25109, Sweden, Tel: +46-42-171000, Telex: 72185 BOLIDVS, Contact: Mrs Linkvist. Produce aluminium sulphate for drinking water and AVR for sewage. Also supply equipment for sewage water treatment plants and drinking water.

**BRENCO INTERNATIONAL** 30 Kirkham Industrial Court, St Louis, Missouri, 63119, USA, Tel: +1-314-968-0404, Fax: +1-314-968-2465, Contact: John S Brennan. Brenco International produces and markets, on a worldwide basis, wastewater treatment chemicals for industrial and commercial use.

**CARUS CHEMICAL CO** 1500 Eighth St, La Salle, IL, 61301, USA, Tel: +1-815-223-1500. Manufacturer of potassium permanganate, chemical for water treatment, air pollution control and wastewater treatment.

**CARMEUSE SA** Rue du Chateau, 13, Seilles, 5210

---

---

# H u n g a r i a P l a s t i c W o r k s

are pleased to announce that their new name is

## **PANONPLAST**

**We hope that our new name and new image will assist in our mutually beneficial co-operation in the future too.**

We are one of the major plastic processors with four plants in Hungary and a staff of 1800. Besides other processing fields we developed our activity in water technology and engineering.

*In this range we offer you:*

**HEXACELL** biological trickling filter media for cost efficient municipal industrial water purification.

It offers high efficiency of B.O.D. removal, simple to operate, small energy consumption, safer operating under load variation conditions, lower investment and operating costs, less space demand, decreases the level and the number of manpower to operate, easily automotive operation. **Hexacell** is available in 100 and 200 m<sup>2</sup>/m<sup>3</sup> specific surface grades.

Rotating Biological Contractors for effective small scale biological water purification.

This equipment contains high specific surface plastic packings partly submerged, incorporated into a rotating compact steel structure and suitable for treating waste waters from e.g. camping sites, blocks of flats small villages e.t.c. Containerised forms are also available.

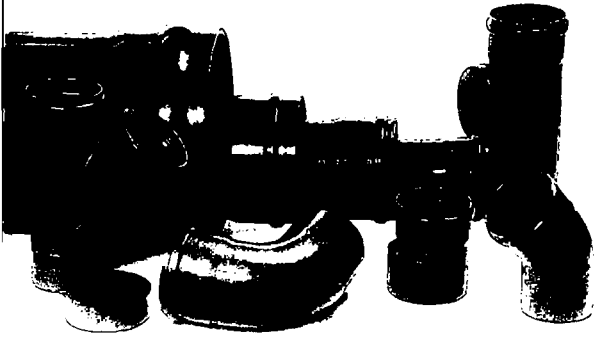

*Below: HEXACELL Modul*

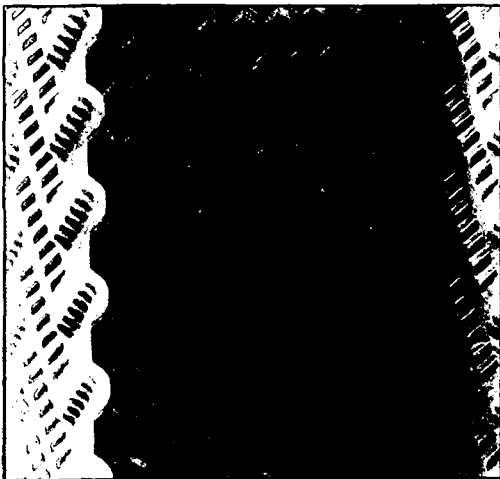

## CHEMICALS FOR WASTEWATER TREATMENT

Belgium Tel: +3285825009, Telex: +59608, Fax: +3285826302. CARMEUSE is a producer of calcium carbonate, calcium oxide and calcium hydroxide, in Belgium, the Netherlands and France. In the water treatment area, the calcic products are used for: Flocculation of impure water, Remineralisation of drinking water, Softening of industrial and portable waters, PH correction of drinking waters and industrial waters, Residual mud conditioning before dewatering, Disinfection and Pasteurisation of residual muds, Dephosphatation of waters. As some of the lime qualities are very pure, Carmeuse lime is often used in the area of drinking water treatment. Due to its excellent geographical position, close to the harbour of Antwerp and Rotterdam, Carmeuse exports large quantities of lime to all countries of the world, especially to Africa and the Middle East.

**CHEMPROHA CHEMICAL DISTRIBUTORS** P O Box 35, Zwijndrecht, 3330 AA, The Netherlands, Tel: +31-1804-23488, Fax: +31-1804-27322, Contact: Mr Van P'veer. As a distributor of chemicals, with locations in the Netherlands, Hong Kong and Puerto Rico, Chemproha buys, transports and sells chemicals around the globe. Within our product range we handle a line of water treatment chemicals for surface and waste waters as well as for swimming pools, such as flocculating agents, pH-control products and conditioning chemicals.

**EES CORP** 12850 Bournewood Drive, Sugar Land, Texas, 77478, USA, Tel: +1-713-240-6770, Telex: 795459, Fax: +1-713-240-6762. The Sanuril<sup>®</sup> 115 formulated wastewater disinfection tablet contains 70 percent available chlorine. These large, 2.625 inch diameter, 145 gram tablets are the safest form of chlorine as well. The tablets are dispensed in one of EES's tablet feeders, which are capable of disinfecting up to 50,000 gallons per day. Disinfection is achieved without moving parts or electricity. D-Chlor<sup>®</sup> tablets in EES feeders are available to remove chlorine prior to discharge.

**GOLDCREST CHEMICAL LTD** Armitage Bridge Mills, Armitage Bridge, Huddersfield, West Yorks, HD4 7NR, UK, Tel: +44-484-666606, Telex: 517243, Contact: Mr Smalley. Manufacturers and suppliers of chemicals and equipment for water, sewage and effluent treatment. The product range includes inorganics, synthetic polymers starch derivatives and enzymes plus equipment for their efficient application.

**GRACE DEARBORN LTD**, Widnes, Cheshire, WA8 8UD, UK, Tel: +44-51-424-5351, Fax: +44-51-423-2722, Contact: Michael R Cooke. Suppliers of speciality chemicals and consultancy for treatment of steam raising plants, cooling water systems, air conditioning plants and waste water treatment.

**GUARDIAN CHEMICAL SPECIALITIES** P O Box 1743, 1225 W Princess St, York, PA, 17405, USA, Tel: +1-717-848-2570, Contact: Bruce Ketrick. Develop and market products and consultation services for industrial influent to effluent water treatment requirements. This includes clarification, pre-treatment equipment, boiler water chemical treatment, cooling water chemical treatment, fuel additives and waste water programme.

**HUNGALU TRADING COMPANY** PO Box 63, Budapest, 1388, Hungary, Tel: +36-1-494750, Telex: 22-54-71, Fax: +36-1-402-723. Granulated aluminium sulphate for water purification and sewage purification.

**INTEROX CHEMICALS LTD** PO Box 7, Warrington, Cheshire, WA4 6HB, UK, Tel: +44-925-51277, Telex: 82221, Contact: Mr Rogers. Chemical manufacture with water, sewage, industrial effluent, gas scrubbing and disinfection as speciality areas.

**JOSHUA GREAVES & SON LTD** PO Box 2, Garden St, Ramsbottom, Nr Bury, Lancs, UK, Tel: +44-706-824191, Telex: 635265, Contact: J W Greaves. Joshua Greaves & Son Ltd manufacture a complete range of fluid mixers and offer chemicals for use in the water and sewage industry.

**KING LEE CHEMICAL CO.** P O Box 146, Del Mar, California, 92014, USA Tel: +6196931358, Fax: +6196931358. King Lee offers safe and highly effective microbiological additives for the Secondary Treatment of municipal sewage. Additives provide complete break down of sewage into non-hazardous simple end products for the safe processing of sewage. In addition, additives eliminate Hydrogen Sulfide and other undesirable end products by controlled microbiological reactions. DISTRIBUTOR INQUIRIES ARE WELCOME!

**KRONOS TITAN-GmbH** PO Box 100720, D-5090 Leverkusen 1, West Germany Tel: +49-21-43560, Telex: +8510823, Fax +49-21-4356481. KRONOS Water Treatment Chemicals based on iron salts for the treatment of drinking water, process water and cooling water; for purification of industrial and municipal water water; for dewatering of sewage sludge; and for the pretreatment for seawater desalination by RO and odour control for water water collection system. Many years of successful experience in water treatment and waste water purification qualify KRONOS TITAN-GmbH for a leading position in this field. KRONOS-TITAN GmbH is a subsidiary of NL Chemicals, Inc., Hightstown/USA a company with an annual turnover of over 1,000 million US-\$. KRONOS Water treatment chemicals are sold worldwide and produced in Leverkusen and Nordenham, West Germany, and in Fredrikstad, Norway.

**MELCHEMIE HOLLAND BV** Jansbuictingsingel 20, Arnhem, The Netherlands, Tel: +31-85451251, Telex: 4501945523, Fax: +31-85-425-093, Contact: Mrs Overkerk. Dry Chlorine Products (calciumhypochlorite and other disinfectants), flocculants (aluminium sulphate, ferrous sulphate, polyelectrolytes), pH regulating agents (hydrated lime, sodiumcarbonate and sodiumbicarbonate), sanuril 115, aquaward (easy chlorination system), melquick (effervescent chlorine tablets) and swimming pool chemicals.

**SUTCLIFFE SPEAKMAN CARTON LTD** Guest St, Leigh, Lancs, WN7 2HE, UK, Tel: +44-942-672101, Telex: 67555, Fax: +44-942-677136, Contact: Mr Colin Moore. Sutcliffe Speakman Carbons manufacture activated carbon from coal and coconutshells for a wide range of applications including water/effluent treatment, sew-



# CHEMICALS FOR WASTEWATER TREATMENT

erage odour control and air filtration. Impregnated carbons are also available.

**SUTCLIFFE SPEAKMAN CARBON LTD** Guest St, Leigh, Lancs, WN7 2HE, UK, Tel: +44-942-672101, Telex: 67555 sutspk, Fax: +44-942-677136, Contact: Colin Moore. Manufacturer of granular and powdered effluent/water treatment activated carbon.

**SYBRON CHEMICALS INC** PO Box 66, Birmingham Rd, Birmingham, NY, 08011, USA, Tel: +1-609-894-8211, Fax: +1-609-894-8641, Contact: Frank Duniono. Sybron Chemicals Inc manufactures and markets ion exchange resins under the Ionic brand name for water softening, demineralization and waste treatment, they also manufacture a complete line of biochem engineered bacteria for waste treatment.

**WESTERN WATER MANAGEMENT INC** PO Box 7469, 1345 Taney, N Kansas City, MO, 64116, USA, Tel: +1-816-842-0560, Fax: +1-816-842-6388, Contact: Paul M Gale. Wastewater treatment chemicals and equipment.

## Industrial Wastewater Treatment

**ABWASSERTECHNIK WERNER PROCHASKA** Dammgasse 18, Wolfpassing, A-3424, Austria, Tel: +43-2242-71434. The stored-program waste treatment and detoxification plant from Abwassertechnik Werner Prochaska is of compact design and can be used for handling all the waste waters occurring in industry. The waste water is collected in holding tanks provided by the customer and pumped automatically in set quantities from the treatment unit into the reaction tank.

**AQUA-AEROBIC SYSTEMS INC** P O Box 2026 6306 North Alpine Rd, Rockford, Illinois, 61130-0026, USA, Tel: +1-815-654-2501, Fax: +1-815-654-2508, Contact: Carol S Zies. Aqua-Aerobic Systems Inc is a designer/manufacturer of equipment used in the biological treatment of water and wastewater. Equipment includes: direct drive aerators, direct drive mixers, automatic backwash filters and a sequencing batch reactor (SBR) system.

**AQUA-CHEM INC** 210 W. Capitol Drive/PO Box 421, Milwaukee, Wisconsin 53201, USA Tel: +4149615060, Telex: +26679AQM MIL, Fax: +4149612723. Aqua-Chem Inc. engineers and manufacturers custom designed packaged and field-erected evaporator and crystalliser systems. MVR, Thermocompression and multiple-effect designs available in falling film, forced circulation, and natural circulation. Systems are used for concentration of aqueous and non-aqueous process and waste streams in chemical, petrochemical, metal plating and food and beverage industries.

**ASCO KOHLENSAEURE AG** Industriestrasse 4, Romanshorn, CH-8590, Switzerland, +41-71-63-33-33, Tel: +41-71-071-63-63-83, Fax: 881 666 asco ch, Contact: Thomas Trachsel. Manufacturer of all sorts of carbon dioxide equipment including fully automatic low-cost compact CO<sub>2</sub> water neutralisation plants. Also manu-

facturer of complete CO<sub>2</sub> and dry ice production systems.

**BENCKISER-KNAPSACK GmbH** Dr.-Albert-Reimann-Str. 2 D-6802 Ladenburg Bundesrepublik Deutschland, Tel: +06203/774289 Fax: +0620312818. Product systems for water treatment - for drinking water, cooling water, boiler water, autoclave water, waste water and sea water.

**BEWT (WATER ENGINEERS) LTD** Alcester, Warwickshire, B49 6QT, UK, +44-789-763669/764065, Tel: +44-789-400274, Fax: 312501, Contact: Mrs Berry. BEWT Manufacture, install and commission a comprehensive range of processes designed to minimise pollution caused by manufacturing industries. Particular emphasis is made on recovery techniques for a variety of metals utilising the patented Chemelec electrolytic process.

**BIRD ENVIRONMENTAL SYSTEMS INC** 1 Dedham Place, Westwood, MA, 02090, USA, Tel: +1-617-461-1414, Telex: 924428, Fax: +1-617-668-6855, Contact: Denise Lange. Development, installation and servicing of systems for treatment of industrial waste water.

**BK LADENBURG** Dr Albert-Reimann-Strasse 2, Ladenburg, D 6802, West Germany, Tel: +49-6203-77-4307, Fax: +49-6203-1-2818, Contact: Ferdinand Puhe. The Labufloc® range offers a wide variety of speciality products with different ionic character to obtain best results in sedimentation, flotation, filtration, thickening and dewatering.

**BLUE CIRCLE INDUSTRIES PLC** 2 Hassell St, Newcastle Under Lyme, Staffordshire, ST5 1AG, UK, Tel: +44-782-618668, Telex: 367119. Clarifloc is Blue Circle's inorganic coagulant for the physico-chemical treatment of sewage and polluted wastewaters. It can be used as an aid to conventional settlement processes, and is capable of achieving significant reductions in contamination levels. Its versatile properties are being used to control and eliminate odours and treat industrial wastes. It has the added advantage of being delivered to site ready to use, for direct dosing into the wastewater stream under treatment.

**BURT SEPARATORS** 45-47 South St, Bishops Stortford, Herts, CM23 3AG, UK, Tel: +44-279-53221, Fax: +44-279-757232. Burt offer a design and construction service of unique patented oil and other chemicals separator at home and abroad. Particularly applicable to palm oil industry and airport operations.

**CHEMIE - UND ANLAGENBAU DIPL - ING H ZEBISCH & CO KG**, Scharding am Inn, A-4780, Austria, Tel: +43-7713-321-6921, Telex: 27360 cauf a. Cauf-Caprex Contact High-speed Clarifiers are intended for cleaning surface water and the waste water occurring in mining and in gravel and sand washing. They are also used for neutralisation, residual concrete handling and emulsion splitting.

**DEEP SHAFT TECHNOLOGY INC** 801 York Mills Rd, Don Mills, Ontario, M3B 1X7, Canada, Tel: +1-416-391-5616, Fax: +1-416-391-1326, Contact: Paul G Daly.

## INDUSTRIAL WASTEWATER TREATMENT

Deep Shaft Technology Inc, are a drilling company and process engineering firm specializing in a unique wastewater treatment process. The Deep Shaft process is a biological treatment system utilizing a totally enclosed steel cased reactor 200-500 ft deep. This process treats both municipal and industrial wastewater.

**DEWPLAN (ET) LTD** Beechwood Hall, Kingsmead Road, High Wycombe, Bucks, HP11 1LA, UK, Tel: +44-494-35671, Telex: 837139, Fax: +44-494-465489, Contact: Mr David Moreau. Undertake design and installation of large and small industrial effluent treatment plant.

**ENVIRO-CHEMIE AG** CH 8733, Eschenbach, Switzerland, Tel: +41-5584-11-51, Telex: 875263, Fax: +41-5586-31-59, Contact: Ms Muller. Enviro-Chemie specialise in manufacturing and selling standardized waste water treatment plants (SPLIT-O-MAT-emulsion splitting, ultrafiltration, charcoal adsorption). Also in projecting and constructing individual, customized waste water treatment plants for all kinds of industrial waste waters.

**FLYGT AB** Box 1309 S-171 25 SOLNA, Sweden. Tel: +46-8-733 6500, Telex: +43887 flygtab s, Fax: +46-8-295816, Contact: Anderz Öhringe. Flygt is the world's leading manufacturer of submersible heavy-duty pumps for contaminated and abrasive liquids. The annual sales for 1988 was approx SEK 2.3 billion. With over 1,250,000 installations in more than 100 countries throughout the world, Flygt submersible products encompass an awe-

some range of pumps, mixers and hydro turbine generators for small scale hydro electric power stations. The main office is situated in Solna, just outside Stockholm, with manufacturing facilities are in Lindas. Flygt has subsidiaries in 16 countries and 3,400 employees of which 1,500 are in Sweden.

**GLASFORMEN UND MASCHINEN GES M b h (GMA)** Judenburger Strasse 176, Küflach, A-8580, Austria, Tel: +43-3144-22-50, Telex: 312047 gma a. The water purification plants supplied by GMA operate on the mechanico-chemical adsorption principle. Intended for cleaning highly polluted industrial waste water, they are used mainly by paper and pulp mills, leather producers, tanning and dyeing works.

**W R GRACE & CO, DEARBORN DIV** 300 Genesee St, Lake Zurich, IL, 60047, USA, Tel: +1-312-438-8241, Telex: 2-2428, Fax: +1-312-540-1588, Contact: Jeff Schummel. Leader in development of solutions for industrial water treatment problems. For 100 years has provided products and services to meet industry's boiling water, cooling water and waste water treatment needs.

**GRAVER WATER INTERNATIONAL** 2720 US Highway 22, Union, NJ, 07083, USA, Tel: +1-201-964-2554, Telex: 6853093, Fax: +1-201-964-7770, Contact: Mr Liman. Graver designs and manufactures a complete line of water and waste treatment equipment to fit the needs of industrial corporation and electric generating utilities.

### Latest technology for economical waste-water treatment

#### The new waste-water treatment plant **SOLVIN A+W+A 2000** based on electro-physical principles

*Bilge cleaning  
Oil refineries*  
**Wherever industrial wastewater is a problem**

Margarine- and Oilfactories  
Railway- and Buscompanies  
Paper- and Cellulose-Industry  
Car dewaxing- and cleaning plants  
Metalindustry



the most economical and ecological way to treat polluted water

*high efficiency  
low running costs*  
**SOLVIN A + W + A 2000 is the answer!**

capacities from 10 - 250 lit/min  
water may be reused and circulated many times  
little space required  
works continuously or batchwise  
no chemicals required

### **Wassertechnik Ges.m.b.H.**

Mitterndorf 5 · A-3452 Atzenbrugg  
Austria - Europe  
Phone 0 22 75/61 01, 61 02 · Telex 113442 solv a

# INDUSTRIAL WASTEWATER TREATMENT

**GUARDIAN CHEMICAL SPECIALALITIES** PO Box 1743 1225 W Princess St, York, PA, 17405, USA, Tel: +1-717-848-2570, Contact: Bruce Ketrick. Develop and market products and consultation services for industrial influent to effluent water treatment requirements. This includes clarification, pre-treatment equipment, boiler water chemical treatment, cooling water chemical treatment, fuel additives and waste water programme.

**HAGER & ELSASSER GmbH** P O B 800540, Stuttgart 80, 7000, West Germany, Tel: +49-711-7866-0, Fax: +49-711-7866-202, Contact: Mr Rau. Water treatment plants for treatment of fresh water (sea and bralish-water, ultra-pure-water for electronical and pharmaceutical industry, boiler-feed water) and waste-water (metall-working industry, textile industry, power plants and seepage water).

**HESONWERK NACHFOLGER COLLI KG** Zentral: Pettenbacher Strasse 66, Vorchdorf, A-4655, Austria, Tel: +43-7614-83-01-02, Telex: 24466 heson a. Hesonwerk deal with many waste water problems occurring in the metalworking industry. The firm's products also include plants for the purification of waste waters in the electroplating and textile industries, for laboratory waste and solvents.

**HYDROTECHNIK GmbH** Alpenstrabe 54, PO Box 14, A-5033 Salzburg, Austria Tel: +43-662-285310, Telex: +633821 hydr a, Fax: +43-662-2853110. **HYDROTECHNIK AUSTRIA** was founded in 1970 and originally concerned with the design of waste water treatment plants for the paper, pulp and textile industry. During the following year, working with leading Austrian enterprises, a water conditioning plant as well as what were then the largest biological sewage works in the world were supplied to the Middle East. **HYDROTECHNIK AUSTRIA** can draw on 19 years of experience in the offering of a wide range of conventional turn-key water treatment plants or in the acting as a supplier of mechanical and electrical equipment. In order to meet the specific requirements of an international clientele, new process methods for the reutilisation of treated water have been developed.

**ICI BIOLOGICAL PRODUCTS** PO Box 1, Billingham, Cleveland, TS23 1LB UK Tel: +44-642-523786, Telex: +587443 ICIAGH G, Fax: +44-642-522676. ICI has a worldwide network of licensees who can provide design, construction and commissioning of its Deep Shaft process technology. The Deep Shaft process is increasingly used to treat a range of effluents, including domestic, industrial, food, alcohol, pulp and paper etc. Low running cost, low capital cost, high oxygen transfer rate and low land area are just some of the advantages.

**INNOVA-TECH INC** PO Box #920, Valley Forge Corporate Center, Valley Forge, Pennsylvania, 19481, USA, Tel: +1-215-666-9080, Fax: +1-215-666-1766. Innova-Tech's products and processes include: the Total Barrier Oxidation Ditch for efficient final treatment and nutrient control. Flow Equalization Basins (FEB) combined with a Biofloculation Unit (BFU) to remove soluble BOD<S5> from industrial flows. Ideal before

our Dissolved Air Flotation Unit (DAF) which removes up to 85% of oils and greases from wastewater. Call or write for process assistance.

**KRONOS TITAN-GmbH** PO Box 100720, D-5090 Leverkusen 1, West Germany Tel: +49-21-43560, Telex: +8510823, Fax +49-21-4356481. **KRONOS** Water Treatment Chemicals based on iron salts for the treatment of drinking water, process water and cooling water; for purification of industrial and municipal water water; for dewatering of sewage sludge; and for the pretreatment for seawater desalination by RO and odour control for water water collection system. Many years of successful experience in water treatment and waste water purification qualify **KRONOS TITAN-GmbH** for a leading position in this field. **KRONOS-TITAN GmbH** is a subsidiary of NL Chemicals, Inc., Hightstown/USA a company with an annual turnover of over 1,000 million US-\$s. **KRONOS** Water treatment chemicals are sold worldwide and produced in Leverkusen and Nordenham, West Germany, and in Fredrikstad, Norway.

**LENZING AG**, Lenzing, A-4860, Austria, Tel: +43-7672/25-11, Telex: 26606 lenfa a. Liquid membrane permeation (LMP) is a combined extraction-reextraction process for the economical removal and recovery of metals from industrial waste waters. The heavy-duty LMP plant put into operation in Lenzing reduces the zinc content from 500 mg/l to less than 5 mg/l and yields a concentrated zinc solution of over 50 g/l. **Lenzing AG** and Prof Dr Marr of Graz Technical University offer worldwide: preliminary lab tests, on-site tests with mobile plant, and planning, production and installation of large-scale LMP recycling plants.

**LIGHT SOURCES INC** PO Box 410, Main St, Ansonia, CT, 06401, USA, Tel: +1-203-736-9961, Telex: 643266, Fax: +1-203-736-2879, Contact: Ken Ell. Manufacturers of ultra-violet lamps for waste water, potable water and high purity water treatment.

**P W T (HOLLAND) BV** Industrieweg 13, Assendelft, 1566, The Netherlands, Tel: +31-75-285651, Telex: 19159, Fax: +31-75-28619. Pielkenrood Water Treatment is specialised in water purification. PWT has a complete range of systems and installations for the treatment of industrial effluent and process and surface water. Our systems are tailor-made and suited to up-grade existing systems.

**PAQUES B V P O** Box 52, Balk, AB, 8560, The Netherlands, Tel: +31-5140-3441, Telex: 46417 paque nl, Fax: +31-5140-3342. Anaerobic (UASB) waste-water treatment technology. Full-scale plants and know-how. Marketing via licence partners in 14 countries. Application for food, beverage and pulp/paper industry. Registered as BIOPAQ® process. World-wide already 50 treatment plants in operation.

**PORTALS WATER TREATMENT LIMITED** Oldfield Lodge, 156 Bridge Rd Maidenhead Berkshire SL6 8DG UK Tel: +44-628-771444, Telex: 849067, Fax: +44-628-771567. PWT has four business sectors related to water, waste service and contracting: major projects up to \$500 million in value, specialty chemicals for boiler,

# INDUSTRIAL WASTEWATER TREATMENT

cooling and process water applications, products and services including standard industrial treatment plants, plant rehabilitation, customisation and packaged systems, special products including pump sets, cooling towers, mass transfer systems and screening presses.

**PREUSSAG ANLAGENBAU** PO Box 1320, Heinrich-Hertz-Strasse 23, Hemmingen 1, D-3005, West Germany, Tel: +49-511-4206-0, Telex: 923523, Fax: +49-511-4206-359. 4

**RESOURCES CONSERVATION COMPANY** 3006 Northup Way, Bellevue, WA, 98004, USA, Tel: +1-206-828-2400, Fax: +1-206-828-0526. World leader in the design of energy efficient evaporator systems for industrial wastewater treatment. These systems recover pure water for recycling, reduce waste volume and help industry meet strict "zero liquid discharge" water pollution control regulations. RCC specializes in reliable systems for difficult waste chemistries.

**STOISER UND WOLSCHNER** Bahnstrasse 87 + 93, Klagenfurt, Postfach 309, A-9021, Austria, Tel: +43-4222-321-09, Telex: 422902 stowa a. Stoiser und Wolschner (SW) Compact Oil-absorber Plants are designed for the cleaning of waste water contaminated with mineral oil in a series of cleaning steps. The compact basin is made of steel fibre and Tor steel-reinforced concrete with corrosion-proof inner lining.

**SYBRON CHEMICALS INC** PO Box 66, Birmingham Rd, Birmingham, NY, 08011, USA, Tel: +1-609-894-8211, Fax: +1-609-894-8641, Contact: Frank Duniono. Sybron Chemicals Inc manufactures and markets ion exchange resins under the Ionic brand name for water softening, demineralization and waste treatment, they also manufacture a complete line of biochem engineered bacteria for waste treatment.

**TECH-LINE INSTRUMENTS/ARTECH INTNT'L** Tri Campus Park P O Box 1236, Fond du Lac, WI, 54936, USA, Tel: +1-414-922-6970, Fax: +1-414-922-1085, Contact: Robert M Arthur. Manufactures and sells automated laboratory and on-line respirometers, that provide real time biological information, used in monitoring and controlling the wastewater process. Applications include, process control, troubleshooting of biological processes, toxicity-treatability testing, anaerobic digestion - short term BOD testing, compost testing and plant design. Sample chambers from 250 ml - 10L.

**WESTMOOR LTD** 3452 N Knox Avenue, Chicago, IL, 60641, USA, Tel: +1-312-282-2237, Fax: +1-312-282-4954. Manufacture rotary vane, positive displacement air blowers used for aeration. Products include pumps and pump units plus aeration kits. Aeration systems by Westmoor are used in waste water facilities, lake management and aquaculture.

## Package and Portable Treatment Units

**AQUARIUS WATER PURIFICATION LTD** Unit 12,

Craven Court, Winwick Quay, Warrington, Cheshire, UK, Tel: +44-925-445144, Telex: AQUA 627151, Fax: +44-925-413524. A150 - unique portable water purification unit, 150 gallons per hour.

**CONDER GROUP PLC** Kingsworthy Court, Winchester, Hants, SO23 7QA, UK, Tel: +44-962-882222, Telex: 47465, Fax: +44-962-885016, Contact: Mike Moore. Clearwater specialise in package sewage and effluent treatment systems for the single dwelling to a complete township. Water treatment extends from simple filtration to plant producing ultra pure water for medical use.

**EL-CAR PATERSON CANDY IT SRL** Via G Di Vittorio 307/5, Sesto, San Giovanni, 20099, Italy, Tel: +39-2-2424841, Telex: +326166 Elcar I. Design, construction and installation of equipment and full plants for water treatment.

**CSR-HUMES PTY LTD** PO Box 31, World Trade Centre, Melbourne Vic. 3005, Australia Tel: +61-36-113311, Telex: +38015, Fax: +61-36-146347. Humepipe Systems, Precast, Structural Concrete Products, Protective Linings, Soil Stabilisation Products: Humes Concrete is Australia's leading producer of concrete pipe and precast concrete products and, as such, is a significant contributor to the construction of the nation's irrigation, sewerage and drainage reticulation systems. As well, Humes Concrete products are utilised in major transport infrastructure works, rural and domestic applications. Advance Australia Award winning Euro-cycle, a compact domestic wastewater treatment plant which is an inexpensive alternative to sewerage, septic tank and pump-out systems.

**HYDROTECHNIK GmbH** P O Box 14, Salzburg, A-5033, Austria, Tel: +43-662-224-720, Telex: 633-821, Contact: Miss Imza. Using the results of research and development accumulated over 20 years, HYDROTECHNIK AUSTRIA has become a leading specialist in the fields of Water Treatment, Sewage Treatment and Desalination technology. Depending on the required capacity, HYDROTECHNIK AUSTRIA provides either conventional plants or their HYDROCOMPACT-plants, which are completely prefabricated and tested in Austria. Thereof results very short and simple erection work. The large number of sold containerised HYDROCOMPACT-plants, mainly to Arab and African countries, has proven their quality. Hundreds of these plants have been producing worldwide continuously drinking water for thousands of people.

**IDEAL HORIZONS INC** PO Box 1707, Rutland, Vermont 05701 1707 USA Tel: +1-802-773-4346, Fax: +1-802-773-2538. Ideal Horizons manufacture stainless steel ultra-violet disinfection equipment. Our modular systems allow for versatility over a wide range of applications and flow rates. These systems are engineered for durability and performance.

**KIPSZER** PO Box 28, Budapest X, Faszberenyi ut 36, H-1475, Hungary, Tel: +36-1-575-122, Telex: +22-5328, Fax: +36-1-572-958. Design, manufacture, delivery, installation and service of twin-model high speed filters for use in boiler feed water treatment lines to remove solids.

# innova-tech<sup>TM</sup> INC.

## THIS IS IT!

### THE Total Barrier Oxidation Ditch System

For MUNICIPAL,  
FOOD PROCESSING,  
And INDUSTRIAL  
WASTEWATER  
TREATMENT

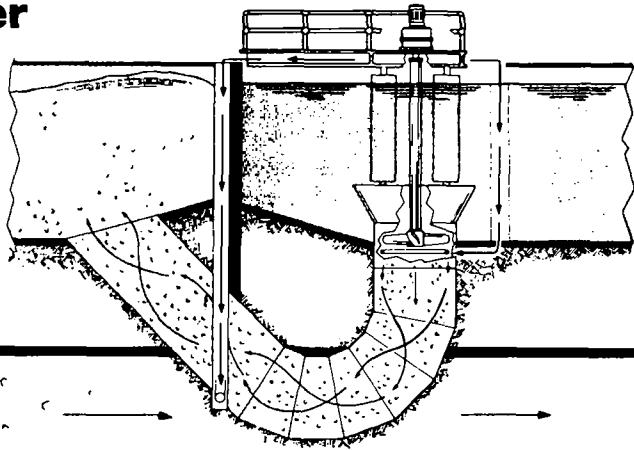

- HIGH OXYGEN TRANSFER EFFICIENCY
- EFFICIENT PROCESS CONTROL
- DESIGN FLEXIBILITY

**innova-tech**

915 Madison Avenue, P.O. Box 920  
Valley Forge Corporate Center  
Valley Forge, PA 19481

CALL FOR  
**NEW**  
BULLETIN

Call TOLL-FREE: 800-523-7299  
In Pennsylvania, Call Collect:  
(215) 666-9080

## PACKAGE AND PORTABLE TREATMENT UNITS

Cirkojet filters are available for one-step filtering of surface and well waters as well as integrated water softeners. These filters run at low operating cost and are environmentally friendly. Thermal degassing towers for removing oxygen from water are applicable in an extremely wide operation range (10-100 per cent).

**PANNONPLAST WORKS** P O Box 30F9 Budapest, H-1400, Hungary, +36-1-225-849, Tel: +36-1-229-228, Contact: Jozsef Lazar. Rotating biological contractors with 100-250 m<sup>2</sup>/m<sup>3</sup> specific surface, containerized type is also available.

**POLIMEX - CEKOP LTD** 7/9 Czackiego Str, Warszawa, 00-950, Poland, Tel: +48-26-80-01, Telex: 814231, Fax: +48-26-04-93. Polimex Cekop Ltd fights pollution of the environment and ensures clean water, offering: services of our specialists in research and design works of wastewater processing methods, deliveries of biological sewage treatment plants for campsites and hotels.

**PONT-ÛA-MOUSSON S A** 4X, Nancy Cedex, 54017, France, Tel: +33-83-96-8121, Telex: 966555, Fax: +33-83-96-3048, Contact: Mr Coiffer. Pont-ua-Mousson SA manufactures and supplies ductile iron pipes and relevant accessories for water and sewerage networks. Throughout the world, more than 1000 cities including 80 capitals use Pont-a-Mousson products.

**PREUSSAG ANLAGENBAU** P O Box 1320, Heinrich-Hertz-Strasse 23, Hemmingen 1, D-3005, West Germany, Tel: +49-511-4206-0, Telex: 923323, Fax: +49-511-4206-359.

**ROSEWATER ENGINEERING LTD** Stonebroom Industrial Estate, Stonebroom, Derby, DE5 6LQ, UK, Tel: +44-773-875017, Telex: 378146, Fax: +44-773-874921, Contact: Mr Ainge. Rosewater designs, manufactures and installs process plant for the waste water treatment market including peristaltic pumps, fine bubble aerators, automatic desludging systems, package treatment plants, digester refurbishment and control panels.

**SUBURBIA SYSTEMS INC/INNOVATIVE MATERIAL SYSTEMS** PO Box 2987, Olathe, KS, 66062, USA, Tel: +913-829-2900, Fax: +913-829-2989, Contact: Andrew A Elliott. Manufacturer of dredges, pumps and pumping systems for sludge removal and handling to the wastewater and water industry. Manufacturer of package treatment plants, clarifiers, gravity filters for the wastewater industry.

**T L B CORPORATION** 150 Willard Avenue, Newington, CT, 06111, USA, Tel: +1-203-233-5109, Fax: +1-203-233-1268, Contact: Thomas E Bond. T L B Corporation is the only prefabricated sewage treatment plant manufacturer that uses 100% noncorrosive materials. This means little maintenance, and longevity of perhaps over 100 years. Activated sludge process 25,000 to 3 MGD. Trickling filter systems up to 50 MGD. A license to fabricate their products in your country is available.

**TUKE & BELL LTD** Beacon St, Lichfield, Staffs, WS13 7BB, UK, Tel: +44-543-414161, Telex: 339216, Fax: +44-543-250462, Contact: Mr Walker. Tuke & Bell Ltd designs, manufactures and installs sewage purification

equipment under contract, ranging from complete mechanical and electrical turnkey projects to individual systems and package sewage treatment plants.

**WATER TECH INC** 214 N E 83rd St, Vancouver, WA, 98665, USA, Tel: +1-206-573-7176. Manufacture potable and industrial water treatment packaged plants, also industrial wastewater treatment packaged plants.

### Preliminary Treatment - Screens and Disintegrators

**BIRTLEY** Avenue de Tervueren 32-36, Boite 11-12, Brussels, B1040, Belgium, Tel: +32-2-73-60037, Telex: 24-747, Fax: +32-2-736-44-76, Contact: Mr Gerard. Self-cleaning water intakes for rivers, canals or main pipes have an opening of 1mm without moving parts, automatic filters and strainers are remote controlled or not, have no moving parts, and a filtration size ranging from 100 to 800 microns, pressure goes up to 20 bars (about 300 psi), separators, remote controlled or not, are fully automatic. There are no moving parts. They have a separation level ranging from 10 to 100 microns and deal with all pressures with little maintenance.

**ENVIRO-CARE CO** 5614 W Grand Avenue, Chicago, IL, 60639, USA, Tel: +1-312-745-7773, Fax: +1-312-745-8383. Enviro-Care manufacturers of comminutors and bar screens that are revolutionary in their design and performance. The uniqueness of these products is a result of three components: simplicity in design, ease of operation and maintenance and competitive pricing. World wide installations are testimony to their high quality. Products that are built to perform and last.

**HAIGH ENGINEERING CO LTD** Alton Rd, Ross-on-Wye, Herts, HR9 5NG, UK, Tel: +44-989-763131, Telex: 35388, Fax: +44-989-766360, Contact: Mr Glover. The Haigh Engineering Company manufacture, design and install water borne sewage control systems. Individually designed, the emphasis is on quality of design and materials for a long working life. Products include sludge pumps, macerators, penstocks and pumping stations.

**HAWKER SIDDELEY BRACKETT LTD** Severalles Lane, Colchester, Essex, CO4 4PD, UK, Tel: +44-206-852121, Telex: 98391, Fax: +44-206-844509, Contact: Mr Day. Hawker Siddeley Brackett manufacture a complete range of screens and pipeline strainers/filters for raw water intakes to power and industrial plants and for waste water treatment for primary and full treatment.

**INKA SYSTEMS LTD** 7 Watt Rd, Hillington, Glasgow, G52 4RY, UK, Tel: +44-41-882-5395, Telex: 778210 INKA G, Fax: +44-41-810-5387, Contact: Mr Verney. Design and supply of effluent and sewage treatment plants and equipment including: screens, presses, grit removal, clarifiers, aerators, mobile and static sludge dewatering plant, sludge thickener and tertiary treatment.

**JONES & ATTWOOD LTD** Titan Works, Stourbridge,

# FLO-SCREEN™

THE BAR SCREEN OF REVOLUTIONARY SIMPLICITY  
BUILT WITH THE OPERATOR IN MIND.

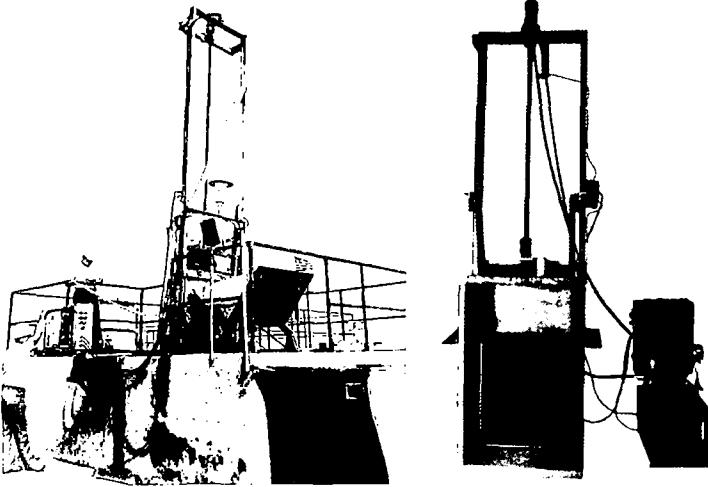

#### FEATURES:

- ★ RUGGED STAINLESS STEEL CONSTRUCTION
- ★ OPENINGS FROM 1/8" AND UP
- ★ AUTOMATIC OPERATION
- ★ SAFE INSTALLATION IN HAZARDOUS AREA-HYDRAULIC DRIVE
- ★ ANGLED BARS PROVIDE UNMATCHED SCREENING EFFICIENCY
- ★ MINIMAL ENERGY REQUIREMENT BECAUSE OF 90%+ EFFICIENCY OF BALL BEARING SCREW
- ★ NO SPARE PARTS WITH MINIMAL MAINTENANCE

# FLOWMINUTOR®

HYDRAULICALLY DRIVEN COMMINUTOR  
THE BEST THERE IS FOR OPEN CHANNEL INSTALLATION

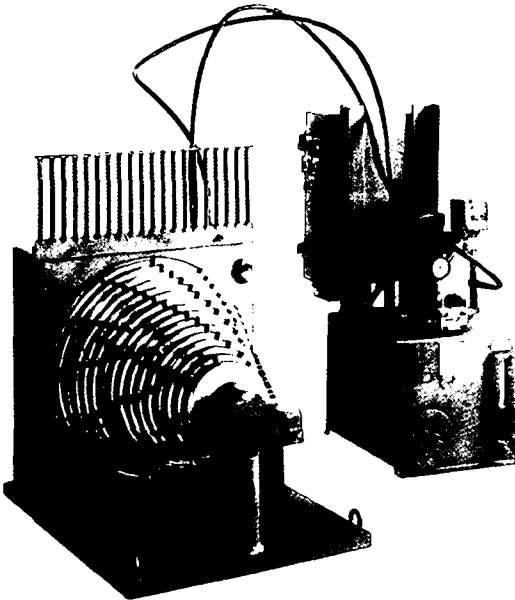

#### FEATURES:

- ★ CRITICAL PARTS ARE STAINLESS STEEL
- ★ EFFICIENT SCISSOR-LIKE CUTTING IS PERFORMED IN THE CENTER OF THE UNIT
- ★ EASY INSTALLATION IN ANY RECTANGULAR CHANNEL
- ★ INSTALLATION IN HAZARDOUS AREAS - HYDRAULIC DRIVE
- ★ EASY MAINTENANCE AND PARTS REPLACEMENT
- ★ TOTALLY SUBMERSIBLE

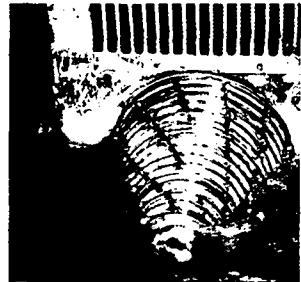

from the  
INFLOW SPECIALISTS



**ENVIRO-CARE CO.**

5614 W. GRAND AVE.  
CHICAGO, ILLINOIS 60639  
Phone (312) 745-7773  
Fax No. (312) 745-8383

# PRELIMINARY TREATMENT - SCREENS AND DISINTEGRATORS

W Midlands, DY8 4LR, UK, Tel: +44-384-392181, Telex: 338120, Fax: +44-384-371937, Contact: Mr Bache. Jones & Attwood founded 1876, pioneered activated sludge treatment process in early 1900s. Since 1950s has concentrated on the pre-treatment phase, specialising in the removal/processing of non-biodegradable solids in municipal/industrial effluent treatment plants.

**FRANKLIN MILLER** 60 Okner Parkway, Livingston, NJ, 07039, USA, Tel: +1-201-535-9200, Telex: 177-472, Fax: +1-201-535-6269, Contact: Harold Colen. Complete range of size reduction machinery for operation in fluid or gas pressure systems, vacuum conditions or gravity flow conditions. Also comminutors and sludge grinders.

**PURAC AB** P O Box 1146, Lund, S-22105, Sweden, Tel: +46-46-135100, Telex: 8305083, Fax: +46-46-14-69-88, Contact: Mr Erik Sander. Proven dissolved air flotation systems where Purac's extensive developments and its construction of some 400 plants for sewage, as well as potable water, are proof of Purac's world leadership in flotation.

**WASTE-TEC** Barton Rd, Heaton Mersey Industrial Estate, Stockport, Cheshire, SK4 3EE, UK, Tel: +44-61-443-1333, Telex: 66970WTECG, Fax: +44-61-443-1444, Contact: Judy Stevenson. Manufacture and service of "the" grinder/disintegrator for sewage, sludges and screenings - the "MONO MUNCHER", sewage pumps, sludge pumps and packaged stations.

## Sedimentation:

### Solid/Liquid Separation

**B K LADENBURG** Dr Albert-Reimann-Strasse 2, Ladenburg, D 6802, West Germany, Fax: 49-6203-77-4307, Contact: Ferdinand Puhe. 49-6203-1-2818

**BIRD MACHINE COMPANY** 100 Neponset St, South Walpole, MA, 02071, USA, Tel: +1-617-668-0400, Telex: 924428, Fax: +1-617-668-6855, Contact: Denise Lange. Manufacturers and suppliers of a highly efficient range of industrial centrifuges for dewatering sludge and solid liquid separation in waste treatment plant.

**DORR-OLIVER EUROPE BV** Baden Powellweg 305, Amsterdam, LH, 1069, The Netherlands, Tel: +31-20-5107911, Telex: 12367, Fax: +31-20-5107293, Contact: Mr Mau. Design, supply and erection of equipment and systems for solid/liquid separation, sewage and industrial wastewater treatment. Specialists in dewatering and incineration of sludges. Oxitron and anitron systems for treatment of wastewater.

**FARROW (A DIVISION OF WRIGHT RAIN LTD)** Crow Arch Lane, Ringwood, Hampshire, BH24 1PA, UK, Tel: +44-425-47251, Telex: 41206, Fax: +44-425-472258, Contact: Norman Murphy. Pumps for handling solids in suspension, dewaterers for the separation of sludges into solid and liquid fractions.

**OSMONICS INCORPORATED** 5951 Clearwater

Drive, Minnetonka, MN, 55343, USA, Tel: +1-612-933-2277, Telex: 029-0847, Fax: +1-612-933-0141, Contact: Terri Levenn. Manufacturers of filtration and separation equipment.

**PANNONPLAST WORKS** P O Box 30, Budapest, H-1400, Hungary, Tel: +36-1-225-849, Fax: +36-1-229-228, Contact: Jozsef Lazar. Production, design and supply of plastic tube settler modules for clarifier intensification. The hydraulic load can be increased up to 6-7 m/h. Smaller surface, less construction costs.

**PAXMAN PROCESS PLANT DIVISION GEC DIESELS LTD** PO Box 8, Paxman Works, Colchester, CO1 2HW, UK, Tel: +44-206-575151, Telex: 98151, Fax: +44-206-577869, Contact: Mr Rouse. Paxman filtration offers versatility in filtration technology with a range of products specialising in liquid/solid separation. Paxman engineers are specialists in sludge dewatering having a long and broad history of experience.

**RUSCO CORP** 13360 Chambord St, Brooksville, FL, 34613, USA, Tel: +1-904-596-4200, Fax: +1-904-596-9489, Contact: Russ Welte. Manufacture plastic spin down sediment filters - operating from one to 100 gallons per minute.

**STOCKDALE FILTRATION SYSTEMS LTD** Stockdale House, Waters Green, Macclesfield, Cheshire, SK11 6LF, UK, Tel: +44-625-616109, Telex: 66885, Fax: +44-625-34678, Contact: Mr Bosley. All types of liquid/solid separation equipment including: rotary vacuum, pressure leaf, sand filters, cartridge filters and oil/water flotation separators. Main applications - effluent, sludge dewatering and water polishing.

**STRANCO LTD** Commercial Rd, Eastbourne, Sussex, BN21 3XE, UK, Tel: +44-323-37011, Fax: +44-323-646035. STRANCO'S industrial division manufactures polyelectrolyte preparation plant for the sewage and waste water industries.

**XENTEX INC** 14902 W 117th St, Olathe, KS, 66062, USA, Tel: +1-913-764-3800, Fax: +1-913-764-1743. Supplier to capital construction projects, water stills for hospitals and laboratories, water demineralizers and water softeners. Equipment for wastewater projects such as liquid solid separators, filtration equip, water recycle equip, pond and pit plastic liners etc.

## Sludge Treatment and Disposal

**AMSTON EQUIPMENT PTE LTD** Blk 16 Pandan Loop Unit 105, Singapore, 0512, Republic of Singapore, Tel: +65-7787826, Fax: +65-7781065, Contact: Jeffrey W T Goh. Manufacturer of filter presses for application in solid-liquid separation of sludges from industrial waste water treatment plant and municipal sewage treatment plant. Capacity of presses ranges from 20 litres to 1500 litres.

**ATRITOR LTD** PO Box 101, Edgwick Park Trading Estate, Canal Rd, Coventry, CV6 5RD, UK, Tel: +44-203-662266, Telex: 312337 AIRLTD G, Fax: +44-203-



---

---

**TETRAFLOK** settling modules for money savings in clarification and sedimentation technology.

The product is recommended for settling suspended solid particles in clarifiers and in sedimentation tanks, both in post-settling of waste waters and in

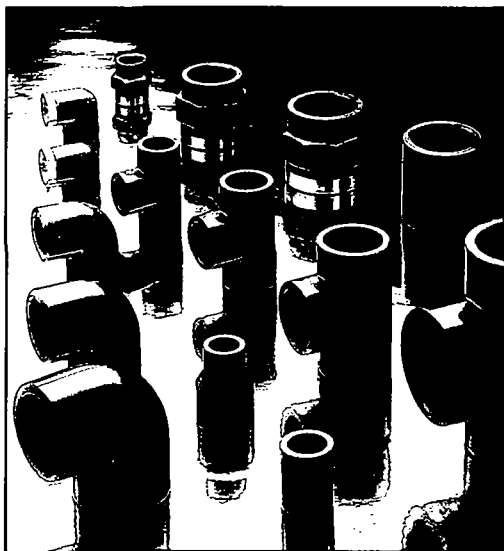

pre-settling of drinking and industrial waters. It provides a better laminar flow, reduces the settling path, hence increasing the hydraulic capacity of the process by 80-150%, so it saves space and cost. Existing facilities can also be out-fitted with **Tetraflo**.

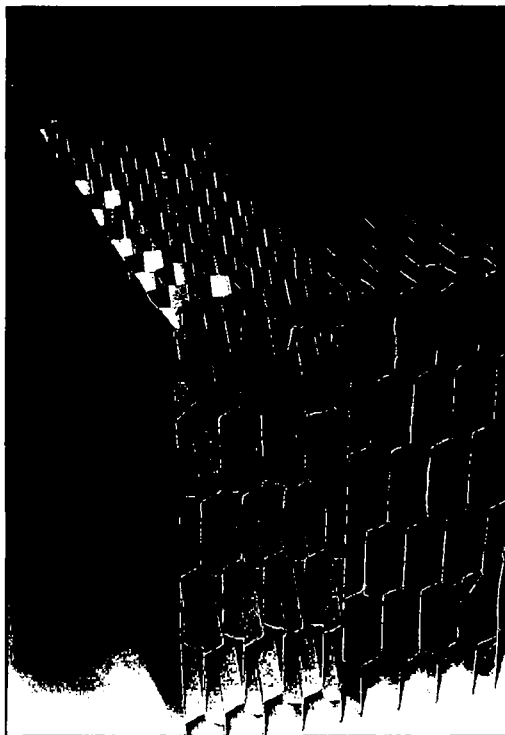

Above: *TETRAFLOK Modul*

Rigid PVC pipes and fittings from 16 to 500mm diameter for water supply, distribution, canalisation and sewage applications.

Cooling tower packings mainly used for wet cooling towers of both counter and cross flow type as well as for chemical transport processes (e.g. degasifying, gas washing, enrichment of gases with liquids).

Full service from consultancy through realisation to joint ventures are provided.

Contact us for more information and quotations!

**Pannonplast Works**  
*Export Division*

**Budapest VII. Szövetség u.9, Letters: H 1400, Budapest POB 30. Hungary**

**Phone: (36 1) 225 849 Telefax: (36 1) 229 228, Telex: 22 3066 pnpkk h**

---

## SLUDGE TREATMENT AND DISPOSAL

665751, Contact: Mr Jarvis. A combined drying and pulverizing machine, its an airswept attrition machine for drying and grinding digested sewage sludge, industrial sludge and lime from water purification processes.

**BABCOCK JENKINS LIMITED**, Retford, Notts, DN22 7AN, UK, Tel: +44-777-706777, Telex: 56122, Fax: +44-777-708141. The Andritz continuous belt press is widely applied for the dewatering of sludges in sewage and effluent treatment plants. The design of the press, established from practical experience and development derived from many years of working in this particular field, presents an economic and efficient method of dewatering sludge on a continuous basis. The details of construction ensure a high level of reliability with a low level of maintenance in the most adverse operating conditions. Units are available for treatment of sludge with flow rate from 1 to 60 M<sup>3</sup>/hour, depending upon application.

**BIRD MACHINE COMPANY** 100 Neponset St, South Walpole, MA, 02071, USA, Tel: +1-617-668-0400, Telex: 924428, Fax: +1-617-668-6855, Contact: Denise Lange. Manufacturers and suppliers of a highly efficient range of industrial centrifuges for dewatering sludge and solid liquid separation in waste treatment plant.

**BK LADENBURG** Dr Albert-Reimann-Strasse 2, Ladenburg, D 6802, West Germany, Tel: +49-6203-77-4307, Fax: +49-6203-1-2818, Contact: Ferdinand Puhe. BK Ladenburg (Benckiser-Knapsack GmbH) - a Benckiser GmbH - a fifty/fifty joint venture of Hoechst AG and Benckiser GmbH - has been successful for over twenty years in international markets. The Labufloc® range enables the economical treatment (thickening and dewatering) of sludge by bandfilter presses, centrifuges, filter presses, vacuum pressure filters and sludge beds.

**BROWN BEAR CORPORATION** P O Box 148, Lenox, Iowa, 50851, USA, Tel: +1-515-333-4551, Fax: +1-515-333-2592, Contact: David Harder. Diesel powered tractors with auger attachments used to dewater sludge as an aid to solar drying. Reduces drying time up to 50%. Also used for mixing amendment such as flyash and composting for volume reduction and stabilization.

**DARCY PRODUCTS** Invictor Works East Malling Kent ME19 6BP U K Tel: 44-732-843131, Telex: 95131, Fax: 44-732-870016, Contact: Mr Proctor. Manufacturers of the Drizit Range of oil absorbents for the control and clean up of oil pollution. Fiber materials sold in loose cushion and boom and sheet pure polypropylene for all applications.

**DORR-OLIVER EUROPE BV** Baden Powellweg 305, Amsterdam, LH, 1069, The Netherlands, Tel: +31-20-5107911, Telex: 12367, Fax: +31-20-5107293, Contact: Mr Mau. Design, supply and erection of equipment and systems for solid/liquid separation, sewage and industrial wastewater treatment. Specialists in dewatering and incineration of sludges. Oxitron and anitron systems for treatment of wastewater.

**EDWARDS & JONES INC** 1515 Route 10, Parsnippany, NJ, USA, Tel: +1-201-428-2828, Fax: +1-416-661-

9620, Contact: Rose Hill. Provide primary sludge or dewatering process systems.

**EFLO INTERNATIONAL LTD** Bath Rd, Padworth, Reading, Berkshire, RG7 5HR, UK, Tel: +44-734-712648, Telex: 848673 EFLO G, Fax: +44-734-712901, Contact: Mrs Boks. Designers, suppliers and contractors to the waste water industry with both aeration and rbc based treatment systems. Suppliers of Sewpass sludge handling equipment and earth anchors.

**FARROW (A DIVISION OF WRIGHT RAIN LTD)** Crow Arch Lane, Ringwood, Hampshire, BH24 1PA, UK, Tel: +44-425-47251, Telex: 41206, Fax: +44-425-472258, Contact: Norman Murphy. Pumps for handling solids in suspension, dewaterers for the separation of sludges into solid and liquid fractions.

**INKA SYSTEMS LTD** 7 Watt Rd, Hillington, Glasgow, G52 4RY, UK, Tel: +44-41-882-5395, Telex: 778210 INKA G, Fax: +44-41-810-5387, Contact: Mr Verney. Design and supply of effluent and sewage treatment plants and equipment including: screens, presses, grit removal, clarifiers, aerators, mobile and static sludge dewatering plant, sludge thickener and tertiary treatment.

**JOHNSON-PROGRESS LTD** PO Box 103, Wright St, Broadheath, Altrincham, Cheshire, WA14 5EF, UK, Tel: +44-61-928-6388, Fax: +44-61-941-7309, Contact: Davy Richie. Complete plants for filtering slurries and sludges from water and from domestic/industrial effluent treatment. Product range includes filter presses, filter media, pumps pretreatment and cake handling equipment.

**KOMLINE-SANDERSON** 12 Holland Avenue, Peapack, NJ, 07977, USA, Tel: +1-201-234-1000, Telex: 136-328, Fax: +1-201-234-9487, Contact: Mr Loudon. Manufacturers of thickening equipment.

**KRONOS TITAN-GmbH** PO Box 100720, D-5090 Leverkusen 1, West Germany Tel: +49-21-43560, Telex: +8510823, Fax +49-21-4356481. KRONOS Water Treatment Chemicals based on iron salts for the treatment of drinking water, process water and cooling water; for purification of industrial and municipal water water; for dewatering of sewage sludge; and for the pretreatment for seawater desalination by RO and odour control for water water collection system. Many years of successful experience in water treatment and waste water purification qualify KRONOS TITAN-GmbH for a leading position in this field. KRONOS-TITAN GmbH is a subsidiary of NL Chemicals, Inc., Hightstown/USA a company with an annual turnover of over 1,000 million US-\$\$. KRONOS Water treatment chemicals are sold worldwide and produced in Leverkusen and Nordenham, West Germany, and in Fredrikstad, Norway.

**M-U-T MASCHINEN-UMWELTECHNIK-TRANSPORTANLAGEN G m b H & CO KG** Schiessstatgasse 49, Stockerau, A-2000, Austria, Tel: +43-2266-25-45-0, Telex: 135673. Municipal vehicles: sewer cleaners, in particular mud suction, high pressure flushing and combined units, also of explosionproof design. Refuse collection trucks, small refuse collectors.

**MAGYAR ACELARUGYAR TISZASZALKAI**

## SLUDGE TREATMENT AND DISPOSAL

**GYARA** PO Box 291, Budapest 62, H-1399, Hungary, Tel: +36-1-371-526. Manufacture and export the System Gyulavari container sewage treatment systems which reduce or entirely eliminate the bulking sludge. The plants are standard pre-engineered packages suitable for either above or below ground installation. Ideal for communal or industrial waste water applications.

**MASCHINENFABRIK ANDRITZ AKTIENGESELLSCHAFT** A-8045 Graz, Statteggerstrasse 18, Austria, Tel: +43-316-602-0, Telex: 311313 antz. Dewatering engineering - dehydration of various sludges occurring in process engineering. The CPF continuous pressure filters designed for the purpose operate on the mechanical pressure filter principle.

**NASH ENGINEERING (GB) LTD** Road One Industrial Estate, Winsford, Cheshire, UK, Tel: +44-606-594242, Fax: +44-606-551994, Contact: A J Whalley. Supply Liquid Ring compressors for gas recirculation in sludge digestors. This type of compressor has the ability to handle wet corrosive gas as well as liquid slugs and semi-solid carry over. These compressors can be supplied as complete packages.

**PAXMAN PROCESS PLANT DIVISION GEC DIESELS LTD** PO Box 8, Paxman Works, Colchester, CO1 2HW, UK, Tel: +44-206-575151, Telex: 98151, Fax: +44-206-577869, Contact: Mr Rouse. Paxman filtration offers versatility in filtration technology with a range of products specialising in liquid/solid separation. Paxman engineers are specialists in sludge dewatering having a long and broad history of experience.

**PENNWALT LTD (SHARPLES DIVISION)** Doman Rd, Camberley, Surrey, GU15 3DN, UK, Tel: +44-276-63383, Telex: 858283, Fax: +44-276-683615, Contact: Mr Jeff Ford. Pennwalt Ltd are manufacturers of centrifuges for thickening and dewatering of both municipal and industrial sludges. The Sharples Maximiser gives a remarkable 50 per cent better throughput.

**PIERSON & CO (ADPEC) LTD** Thrift St, Wollaston, Wellingborough, Northants, NN9 7QJ, UK, Tel: +44-933-663246, Telex: 311463, Fax: +44-933-664061, Contact: Mr East. Design, manufacture and install worldwide a horizontal vacuum belt filter.

**PURAC AB** PO Box 1146, Lund, S-22105, Sweden, Tel: +46-46-135100, Telex: 8305083, Fax: +46-46-14-6988, Contact: Mr Hudd. The unique BIAV composting system treats sludge and separated compostable fractions from solid waste in an aerobic composting reactor which produces valuable compost, rich in nutrients, suitable for parks, gardens and farms.

**RUND-STAHL-BAU GESELLSCHAFT M b H**, Am Brand 8, Bregenz, A-6900, Austria, Tel: +43-5574-25-5-98, Telex: 57-400. Rund-Stahl-Bau is engaged in the production and sale of special formwork for the construction of cylindrical and funnel-shaped buildings, such as water towers, reservoirs, silos, sewage clarification plants, sludge digestion towers, fermentation gas plants, etc. The complete system incorporates working, supporting and safety frames and thus requires no extra scaffolding.

**SEPARATION AS (ALFA-LAVAL)** 5 Maskinvej, Soborg, DK-2860, Denmark, Tel: +45-167-03-11, Telex: 22201, Contact: Bjorn Nielsen. Manufacturers of fully-engineered plant and equipment for surplus activated sludge thickening and sludge dewatering using decanter centrifuges.

**STOCKDALE FILTRATION SYSTEMS LTD** Stockdale House, Waters Green, Macclesfield, Cheshire, SK11 6LF, UK, Tel: +44-625-616109, Telex: 66885, Fax: +44-625-34678, Contact: Mr Bosley. All types of liquid/solid separation equipment including: rotary vacuum, pressure leaf, sand filters, cartridge filters and oil/water flotation separators. Main applications - effluent, sludge dewatering and water polishing.

**SUBMERGED COMBUSTION (ENGINEERING) LTD** Station Rd, Donnington, Telford, TF2 8JZ, UK, Tel: +44-952-670371, Telex: 35170, Fax: +44-952-607571, Contact: Mr Rigby. Design, supply and installation of process engineering plant incorporating submerged combustion and other specialised combustion processes. Work includes recarbonation plant and heating sewage sludge for efficient anaerobic digestion.

**SUBURBIA SYSTEMS INC/INNOVATIVE MATERIAL SYSTEMS** PO Box 2987, Olathe, KS, 66062, USA, Tel: +913-829-2900, Fax: +913-829-2989, Contact: Andrew A Elliott. Manufacturer of dredges, pumps and pumping systems for sludge removal and handling to the wastewater and water industry. Manufacturer of package treatment plants, clarifiers, gravity filters for the wastewater industry.

**SULZER BROTHERS LIMITED**, CH-8401 Winterthur, Switzerland, Tel: +41-52-81-11-22, Telex: 896-060, Fax: +41-52-23-42-83. Sulzer water treatment and wastewater purification plants meet the special requirements associated with all kinds of municipal and industrial applications. In addition, pumps are supplied for communal and industrial water supply and irrigation installations. Furthermore, pumps, decanters and fluid-bed driers required for the treatment of waste waters and sewage sludges.

**TRANSORGANICS LTD** Lotherton Way, Garforth, Leeds, LS25 2JY, UK, Tel: +44-532-872722, Telex: 667737, Fax: +44-532-870190, Contact: Mr Holt. Specialists in recycling to agricultural land, organic waste products from water authorities and the food industry. Provide vacuum tanker services.

**VOEST-ALPINE AG** Postfach 2, A-4010 Linz, Austria, Tel: +43-732/585-1, Telex: 2208-600 va a. The company's water engineering activities form only part of the varied range of products and services. They include: drinking-water treatment of surface and ground water, service water treatment, treatment of circuit, cooling and process water, mechanical, biological and chemical treatment of sewage and industrial waste, stabilisation, digestion, thickening, draining, drying, composting, disposal and incineration of sludge, and sludge draining using screen belt presses.

**WAB - WASSERAUFBEREITUNGSANLAGEN GmbH** Leberstrasse 118, Wien, A-1111, Austria, Tel:

## SLUDGE TREATMENT AND DISPOSAL

+43-222-74-35-60-0, Telex: 132291 wab a. The Messner Aeration Panel (MPB) is a system for the uniform fine-bubble aeration of activated sludge tanks of municipal or industrial sewage treatment plants. Thanks to their small size the air bubbles travel very slowly to the surface. This results in a long retention time and a high transition rate, thus ensuring maximum oxygen dispersion.

### General Equipment and Processes

**ADAMS HYDRAULICS LTD** P O Box 15, York, YO1 1XA, UK, Tel: +44-904-622047, Telex: 57664 ADAMS G, Fax: +44-904-611449, Contact: Mr Hopwood. Although over 100 years old, Adams is still an independent company specialising in the manufacture of pumping and treatment machinery and equipment for sewage disposal, water pollution control and industrial processes.

**AL KAWTHER INDUSTRIES LTD** P O Box 7771, Jeddah, 21472, Saudi Arabia, Tel: +966-2-6360644, Telex: 602907 KAWTHR SJ, Fax: +966-2-637-4337, Contact: Hussein Mikati. Al Kawther provides a wide range of consultancy, design and O & M services as well as supplying: packaged water/wastewater treatment plants, filters and sterilisers, custom built water/wastewater treatment plants.

**ALL PURPOSE MACHINES AND PLANT LTD** 55 Seven Oaks Avenue, Heaton Moore, Stockport, Cheshire, SK4 4AU, UK, Tel: +44-61-432-1877, Contact: N P Lister. Designers and manufacturers of mechanical handling and process plants. Reclamation of oil and solvents, distribution plants, steel fabrications, hydraulic lift tables and desalination plant.

**APV CHEMICAL MACHINERY** Glenburn Rd, College Milton North, Glasgow, East Kilbride, G74 5BJ, UK, Tel: +44-3552-25461, Telex: 777755 APVOC, Fax: +44-3552-63496, Contact: David Reid. Designers and manufacturers of all types of fluid mixing equipment. Also canned, glandless, leakproof pumps, ceramic lined pumps, metering pumps and dosing sets.

**AQUA CONTROL INC** 320 Lasalle Rd, Lasalle, IL, 61301, USA, Tel: +1-815-223-6303, Contact: Willis Dane. Aqua Control makes a variety of aerators and decorative fountains which can improve conditions of many lakes. Units of 1/2 to 3 Hp, in several voltages and in single and 3-phase are available. They are light and easy to install, and offer lake owners economical opportunity to improve their lakes.

**AQUA MAN INC** P O Box 4152, Westlake Village, CA, 91359, USA, Tel: +1-805-499-5707. Manufacturer of solid block carbon cartridges and 9 3/4" and 5" housings in a rainbow of colors that remove bacteria and chemicals. Also manufactures TDS meters, reverse osmosis units from under sink to very large industrial units for water purification and separation. (WT)

**AQUA TECH** Ferdinand Porsche Strasse 1, Salzburg, 85020, Austria, Tel: +43-662-77130, Telex: 632618, Fax:

+43-662-7713077, Contact: Mr Aberger. Aqua Tech design and manufacture small treatment plants for drinking water, process water and waste water.

**AQUAMECH CORPORATION SDN BHD** 5 Jalan Segambut Pusat, Segambut, Kuala Lumpur, 51200, Malaysia, Tel: +60-3-62699306298296262524, Fax: +60-3-6215642, Contact: Mr N Y Wong. A Malaysian incorporated limited company specialising in designing process, manufacturing and installing equipment particularly suited to the developing countries, with emphasis in biological treatment, activated sludge package sewage and wastewater treatment plants, mechanical screens, clarifier and sludge thickener, scraper drives, bridge mounted and floating low speed mechanical surface aerator.

**ARLAT TECHNOLOGY INC** 150 East Drive, Bramalea, Ontario, L6T 1C1, Canada, Tel: +416-458-8220, Fax: +416-458-8224, Contact: R Larry Madden. Arlat Technology Inc is a Canadian based manufacturer and representative of engineered process equipment for the water and wastewater treatment market. Arlat Technology Inc offers complete engineering and design capabilities along with products such as ultraviolet disinfection systems, ozonation equipment, plate settlers, clarifier mechanisms and static mixers.

**ARMFIBRE LTD** Shortmead St, Biggleswade, Beds, SG18 0BB, UK, Tel: +44-767-312619, Telex: +826322. Manufacture GRP plant components for sewerage and water treatment plants and supply odour control systems. Also manufacture standard ventilation and odour control equipment, based on activated carbon, together with tank covers and other related equipment. Supply a patented by-pass oil/petrol interceptor and conventional single and multi-chamber interceptors.

**ARTECO S A S** 55100 Lucca, Viale Pacini, 99/D, Italy, Tel: +39-583-95-23-94, Fax: +39-583-95-23-95. Arteco designs and installs tailor-made wastewater treatment plants for industry and communities. Marichlor for marine use, Extabiol for biodegradable effluents and Drydry for galvanization wastes are proprietary processes marketed worldwide.

**AWA SIGISBERT BOKAN GESELLSCHAFT mbH** A-8010 Graz, Pluüddemanngasse 34A, Austria, Tel: +43-316/80-3-68. AWA are specialists in the planning and production of waste water and sewage treatment plants and have developed a rotary pumping system (Bokan). Plants operating on this principle are used for petroleum, sludge and grease separation. Other products include plants for residual oil separation (by coagulation and active carbon filtration), percolating plants with sludge retention and biological clarification plants.

**BECKEL-EDELSTAHL** P O BOX 97, Bad Ischl, A-4820, Austria, Tel: +43-6132-33-77-0, Telex: 68138. Beckel-Edelstahl supplies stainless steel equipment for water supply and sewage disposal. The line-up embraces: components for tanks, eg pressure doors, feed and delivery pipes (to give uniform spiral or parallel flow), extraction turbines, pipe fittings, etc.

**BIO TREATMENT LTD** 5 Chiltern Close, Cardiff

## GENERAL EQUIPMENT AND PROCESSES

Industrial Park, Cardiff, CF4 5DL, UK, Tel: +44-222-766-802, Telex: 497244, Fax: +44-222-766945, Contact: Dr John Rees. Service based company offering services in the treatment and reclamation of surface and sub-surface contaminated land, the treatment of ground waters and solid and liquid industrial arisings through the application of biological, and chemical engineering.

**BIOMECHANICS ENVIRONMENTAL LTD** 1 Station Rd, Four Ashes, Wolverhampton, WV10 7DQ, UK, Tel: +44-902-791616, Telex: +335684, Fax: +44-902-791772. Specialise in the design, supply, installation and commissioning of plants for waste and water purification and for the treatment of toxic and non-toxic waste embracing the latest technology. Biomechanics specialise in the anaerobic treatment of effluent.

**BIOTECHNIK FORSCHUNGS - UND PRODUKTIONSGELLSCHAFT M b h** Rossakgasse 30, Wien, A-1232, Austria, Tel: +43-222-67-66-65. The KWA catalytic water cleaners are suitable for use with all conventional sewage, liquid manure and water pumps. Without the use of chemicals all waste and rain water can be clarified to drinking water quality, organic and anorganic substances precipitated, and germs neutralized.

**BIWATER SEWAGE TREATMENT** Milltown St, Radcliffe, Manchester, M26 9NU, UK, Tel: +44-61-723-3821, Telex: 669834, Fax: +44-61-724-5605, Contact: Mr Geoff Spencer. Specialists in the manufacture and installation of sewage and industrial effluent treatment plant.

**BOC LTD** 24 Deer Park Rd, London, SW19 3UF, UK, Tel: +44-1-543-3911, Telex: 263490, Fax: +44-1-540-6557, Contact: Mr Stringer. Manufacturers and suppliers of oxygen and other industrial gasses and of gas manufacturing plant. Processes include: Primox - oxygen injection equipment for pumped and gravity sewers, Vitox - high efficiency oxygenators for sewage treatment.

**BOLIDEN WATER TREATMENT P O** Box 902, Helsingborg, S-25109, Sweden, Tel: +46-42-171000, Telex: 72185 BOLIDVS, Contact: Mrs Linkvist. Produce aluminium sulphate for drinking water and AVR for sewage. Also supply equipment for sewage water treatment plants and drinking water.

**BRITE-TECH CORPORATION SDN BHD** 12, Jalan 27a, Kawasan 16, SG Rasa Industrial Area, Klang, Selangor Darul Ehsan, 41300, Malaysia, Tel: +60-3-34289883-3424034/5, Fax: +60-3-3424033, Contact: Pang Wee See. Brite-Tech has been established as a company which specialises in total water management. The company provides a complete range of services and products in the field of water treatment, pollution control, process additives and fuel treatment. Its motto is "make water treatment part of productivity".

**CARTER INDUSTRIAL PRODUCTS LTD** Bedford Rd, Birmingham, W Midlands, B11 1AY, UK, Tel: +44-21-772-4300, Telex: 339219, Fax: +44-21-772-3672. Manufacturers of industrial water cooling towers, water purification and effluent treatment plants.

**CHEMIE - UND ANLAGENBAU DPIL - ING H**

**ZEBISCH & CO KG**, Scharding am Inn, A-4780, Austria, Tel: +43-7713-321 6921, Telex: 27360 cauf a. Cauf-Caprex Compact High-speed Clarifiers are intended for cleaning surface water and the waste water occurring in mining and in gravel and sand washing. They are also used for neutralisation, residual concrete handling and emulsion splitting.

**CLEARWATER SYSTEMS** Riverway Estate, Portsmouth Rd, Guildford, GU3 1LZ, UK, Tel: +44-483-33831, Telex: 859-356, Fax: +44-483-34888, Contact: Richard Jerrard. Clearwater Systems produce water, wastewater and sewerage treatment systems. Our standard products include packaged sewage treatment plants and packaged potable water treatment plants. Exporting to over 30 countries for simple installation on site.

**CTP CHEMISCH-THERMISCHE PROZESSTECHNIK GESELLSCHAFT M b h** A-8010 Graz, Stiftingtalstrasse 165 d, Austria, Tel: +43-316-31404-0, Telex: 116540. Extraction plants for separating chemicals from waste waters and reducing pollution in outfalls (purification of waste water). Applications include phenol extraction, metal salt extraction and the cellulose industry.

**DARCHET ENGRG & WATER TREATMENT PTE LTD** Blk 1001 Kim Chuan Light Industries Park, #01-2530 Hougang Avenue 1, 1953, Singapore, Tel: +65-3-2883566, Fax: +65-2841984, Contact: Alfred Lee. We specialise in water and waste water treatment and offer a total system approach: ultrapure water system, industrial waste/recycling system, package sewage treatment plant, package chemical injection plant, reverse osmosis desalination, package potable, etc.

**DAVCO** 1706 Metcalf Avenue, Thomasville, GA, 31792, USA, Tel: +1-912-226-5733, Fax: +1-912-226-4793, Contact: Mr Harry Roufe. Manufacturer of waste water treatment equipment for industrial, municipal or domestic applications.

**DEGREMONT LAING LTD** Page St, London, NW7 2ER, UK, Tel: +44-1-959-3636, Telex: 8958741, Fax: +44-1-906-5164, Contact: Julie Mitchell. Complete range of municipal/industrial water and waste treatment plant. Processes include: pulsator clarifiers, Aquazur filters, dissolved air flotation, ozone generation - sludge dewatering, desalination plants, turnkey contracts, pressure filters and biological treatment.

**DUALL DIVISION MET-PRO CORP** 700 S McMillan, Owosso, MI, 48867, USA, Tel: +1-517-725-8184, Fax: +1-517-725-8188. Duall manufactures wet scrubbers utilized in control of odours in wastewater treatment. Carbon units for lift station odour are also available.

**EBARA CORPORATION** 11-1 Haneda Asahicho, Ohta-Ku, Tokyo, 144, Japan, Tel: +81-3-743-67-16 London: +44-1-892-8971, Telex: EBARATYO J 22988, Fax: +81-3-745-3576 London: +44-1-891-6730, Contact: Mr R D Jones. London Office: Regal House, London Rd, Twickenham, Middlesex TW1 3QS Pollution control and environmental protection, cleansing potable water, sewage and effluent.

## GENERAL EQUIPMENT AND PROCESSES

**EMCO ENGINEERING INC** 25 North St, Canton, MA, 02021, USA, Tel: +1-617-828-7340, Telex: 924326, Fax: +1-617-828-1714, Contact: Charvel Bechir. The Emco group of companies is an international organisation incorporated in the state of Massachusetts, in 1974, specializing in the manufacture of water and waste treatment equipment, including: reverse osmosis, brackish and sea-water desalting plants, ultrafiltration systems, sewage treatment systems, water softeners, reclamation systems, deionization lime treatment, swimming pool equipment and water storage tanks.

**EMERY CHEMICALS, OZONE TECHNOLOGY GROUP** 4900 Este Avenue, Cincinnati, OH, 45232, USA, Tel: +1-513-482-2100. Manufactures ozone generation systems for potable water and wastewater treatment, odor control and chemical synthesis in industrial and municipal applications.

**ENVIRONMENTAL ELEMENTS CORP** Box 1318, Baltimore, MD, 21203, USA, Tel: +1-301-368-7272. Low headless rapid gravity sand filters for removal of suspended solids and turbidity from water and waste water.

**ENVIRONMENTAL ENGINEERING LTD** Little London, Spalding, Lincs, PE11 2UE, UK, Tel: +44-775-68964, Fax: +44-775-710294, Contact: John Douglas. Environmental Engineering Ltd supply and install on a turnkey basis industrial and domestic effluent treatment plants both in the UK and overseas. Hardware consists of screens, presses, wedge wire clarifiers, dissolved air units, sludge dewatering, effluent treatment and flotation cells.

**EVANS UNIVERSAL LTD** Millshaw, Leeds, LS11 8EQ, UK, Tel: +44-532-711888, Telex: 557885, Fax: +44-532-718188, Contact: Mr Barnham. Evans Universal Ltd is the UK's largest supplier of incineration equipment for all markets particularly hospitals, governments, armed forces and water industry. Its sewage screening incinerators are used successfully in the UK and are unique in that they have no moving parts to cause high maintenance costs.

**FASTEK - A KODAK COMPANY** 7120 Henry Clay Boulevard, Liverpool, NY, 13088, USA, Tel: +1-315-451-0592. Committed to research in both filtration and separation technology. Product line includes reverse osmosis membrane elements, disposable cartridge filters for liquids and gases, in-line ceramic filters for specialty gases and microparticle spheres. (WT)

**FILTROS PLANT, FERRO CORP** 603 W Commercial St, East Rochester, NY, 14445, USA, Tel: +1-716-586-8770. Manufacturer of porous ceramic products for water and wastewater applications. Specifically diffusers and filters.

**FOSPUR LTD** Alfreton Industrial Estate, Somercotes, Derbyshire, DE55 4LR, UK, Tel: +44-773-604321/6, Telex: 377150, Fax: +44-773-606901, Contact: Mr Coleman. Manufacture and supply water treatment chemicals and equipment. Specialists in all forms of water and effluent treatment in industrial and domestic fields.

**GLASFORMEN UND MASCHINEN GES M b H**

**(GMA)** Judenburger Strasse 176, Küflacha, A-8580, Austria, Tel: +43-3144-22-50, Telex: 312047 gma a. The water purification plants supplied by GMA operate on the mechanico-chemical adsorption principle. Intended for cleaning highly polluted industrial waste water, they are used mainly by paper and pulp mills, leather producers, tanning and dyeing works.

**GRAVER WATER INTERNATIONAL** 2720 US Highway 22, Union, NJ, 07083, USA, Tel: +1-201-964-2554, Telex: 6853093, Fax: +1-201-964-7770, Contact: Mr Liman. Graver designs and manufactures a complete line of water and waste treatment equipment to fit the needs of industrial corporation and electric generating utilities.

**HANNA INSTRUMENTS** 584 Park East Drive, Woonsocket, RI, 02895, USA, Tel: +1-401-765-7500. Manufacture testing, controlling, correcting equipment for water treatment and waste water industries.

**HARVESTER STAINLESS LTD** The Avenue, Rubury, Birmingham, B45 9AG, UK, Tel: +44-21-453-6111, Telex: 339-190, Fax: +44-21-453-8435, Contact: Mr Comerford. Major manufacturers and suppliers of all stainless steel tubular and flat roll products, inclusive of specialized grades for the water and water treatment industry.

**HETHON INTERNATIONAL BV** P O Box 40 Barchemseweg 40, Ruurlo, 7260 AA, The Netherlands, Tel: +31-5735-1350, Fax: +31-5735-2866, Contact: Mr Hamers. Hethon International, NI. represents manufacturers of fluid and solid handling equipment as GRI, Accurate, Spiroflow, Duff Norton, Gorman Rupp etc. Hethon is specialized in combining products into complete systems for fluid and/or solid handling.

**HOWARD E HUTCHING CO INC** P O Box 249, 7190 Penryn Plaza, Penryn, CA, 95663, USA, Tel: +1-916-663-1371. Manufactures chemical meter equipment, proportional feed systems and systems design. Water and waste water treatment. (WT)

**HYDROTECHNIK GESELLSCHAFT mbH** A-5033 Salzburg, Alpenstrasse 54, POB 14, Austria, Tel: +43-662/22-4-72, Telex: 633821 hydro a. The company's lineup includes the planning, production, installation and sale of water treatment plants, reverse osmosis, desalination and water supply facilities and waste water purifying plants for industrial and municipal use. Hydrotechnik turn out turnkey water treatment plants with the cooperation of experienced building firms, or supply merely the necessary mechanical and electrical equipment.

**ICI BIOLOGICAL PRODUCTS** P O Box 1, Billingham, Cleveland, TS23 1LB UK Tel: +44-642-523786, Telex: +587443 ICIAGH G, Fax: +44-642-522676. ICI has a worldwide network of licensees who can provide design, construction and commissioning of its Deep Shaft process technology. The Deep Shaft process is increasingly used to treat a range of effluents, including domestic, industrial, food, alcohol, pulp and paper etc. Low running cost, low capital cost, high oxygen transfer rate and low land area are just some of the advantages.

# O-CAP.<sup>TM</sup>

DISTRIBUTOR ARM END CAP

THE  
MARKET  
LEADER

NO CORROSION  
NO THEFTS  
OPERATIONAL SAVINGS  
LESS WEIGHT  
GREATER RESILIENCE  
IMPROVED DESIGN

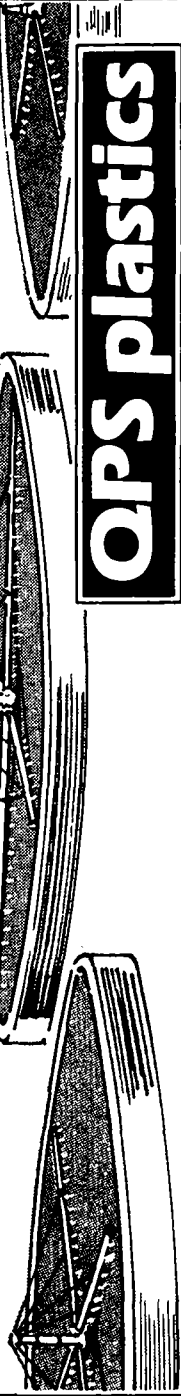
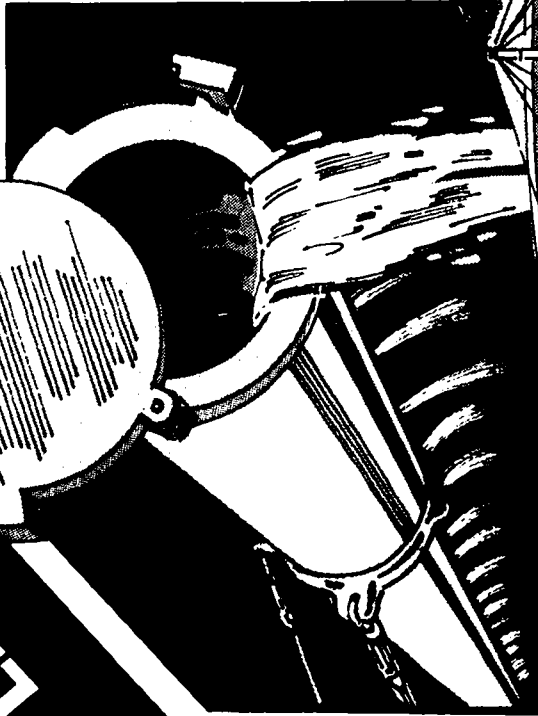

**OPS plastics**

OPS PLASTICS NEW YORK IND. ESTATE SUMMERBRIDGE HARROGATE N. YORKS HG3 4LA TEL. 0423 780389 FAX. 0423 781516

## GENERAL EQUIPMENT AND PROCESSES

---

**INFILCO DEGREMONT INC** PO Box 29599, Richmond, VA, 23221, USA, Tel: +1-804-281-7600, Contact: . Manufacture industrial and municipal water and wastewater treatment equipment.

**INKA SYSTEMS LTD** 7 Watt Rd, Hillington, Glasgow, G52 4RY, UK, Tel: +44-41-882-5395, Telex: 778210 INKA G, Fax: +44-41-810-5387, Contact: Mr Verney. Design and supply of effluent and sewage treatment plants and equipment including: screens, presses, grit removal, clarifiers, aerators, mobile and static sludge dewatering plant, sludge thickener and tertiary treatment.

**INNOVA-TECH INC** P O Box #920, Valley Forge Corporate Center, Valley Forge, Pennsylvania, 19481, USA, Tel: +1-215-666-9080, Fax: +1-215-666-1766. Full line capabilities: Whether you're interested in a complete waste treatment proposal or a modification of your existing facility, you can count on InnoVA-Tech to meet your needs. We can provide flow equalization systems, dissolved air flotation, aeration, biological treatment and clarification. Nutrient removal can be obtained with our Total Barrier Oxidation Ditch (TBOD).

**INVERSAND CO** PO Box 650, Clayton, NJ, 08312, USA, Tel: +1-609-881-2345. Manufactures manganese greensand for iron, manganese and hydrogen sulfide removal from groundwaters. Supplier to the water treatment industry for calcite, anthracite, filter sand and gravels. (WT)

**JOHNSON MICROFLOC** Johnson House, Browells Lane, Feltham, Middlesex, TW13 7EQ, UK, Tel: +44-1-751-4424, Telex: 935479 usclon, Fax: +44-1-890-1533, Contact: Mrs Dicker. Suppliers of advanced technology, High rate, water and wastewater treatment equipment including packaged portable water production systems.

**KEE SERVICES** College Rd, Aston Clinton, Aylesbury, Bucks, HP22 5EZ, UK, Tel: +44-296-631499, Telex: 837545, Fax: +44-296-630263, Contact: Mr Johnston. Design, construction, maintenance and refurbishment of all forms of equipment for effluent and waste treatment.

**KLARGESTER ENVIRONMENTAL ENGINEERING LTD** College Rd, Aston Clinton, Aylesbury, Bucks, HP22 5EW, UK, Tel: +44-296-630190, Telex: 837545, Fax: +44-296-630263, Contact: Mr Pritchard. Klargestester has pioneered the development of compact sewage treatment equipment using modern corrosion-resistant materials. Klargestester's products are marketed worldwide with clients including individual property owners, water authorities and major national companies.

**KVK A-8551** Wies, Austria, Tel: +43-3465/25-13, Telex: 034342, Contact: . The firm KVK has been engaged for years in the production of large capacity tanks for acids, lyes and waste water. In line with pollution control requirements it has developed a compact neutralisation plant for the treatment of used waters and acids.

**LAKESIDE EQUIPMENT CORPORATION** PO Box 8448, Bartlett, Illinois, 60103, USA, Tel: +1-312-837-5640, Fax: +1-312-837-5647. Lakeside is a wastewater treatment equipment company with over 60 years of design

and development experience. Offers a wide range of treatment equipment: clarifiers, oxidation ditches, rotor aerators, screw pumps, filter distributors, tertiary filtration, sewage samplers, grit collectors and package plants. Lakeside offers equipment and service for any size installation.

**LANCY INTERNATIONAL INC** PO Box 419, Pittsburgh, PA, 15230, USA, Tel: +1-412-772-0044, Fax: +1-412-772-1360, Contact: John Lowry. Since its founding in 1945, Lancy has been a pioneer in the development of wastewater recovery and treatment technology. We are committed to technical excellence, quality products and marketing leadership in this field.

**LEEDS AND NORTHRUP CO** Sunneytown Pike, North Wales, PA, 19454, USA, Tel: +1-215-643-2000, Fax: +1-215-699-5245, Contact: Bill Reed. Manufacturer of analytical instrumentation and sensors for water and waste water treatment. Also manufacture venturi meters and rate-of-flow controllers, liquid and dry chemical feeds equipment, filter bottoms, surface agitators, troughs, digital and analog control systems.

**LOCHER & CIE AG** Pelikan-Platz 5, Zurich 1, CH-8022, Switzerland, Tel: +41-1-211-56-00, Telex: +813-399, Fax: +41-1-221-24-59. For sewage treatment plants - the deep shaft aeration.

**LYONNAISE DES EAUX** 52 Rue de Lisbonne, Paris, Cedex 08, 75008, France, Tel: +33-40-75-70-00, Telex: 643-407, Fax: +33 1-45624270, Contact: Mlle Valenfi. Lyonnaise serve communities in fulfilling long-term needs of municipalities and industry in the field of water supply and management, waste water treatment, drinking water distribution, sanitation and financial engineering.

**MAHON & MCPHILLIPS (STRATFORD) LTD** Holford Way, Witton, Birmingham, West Midlands, B6 7AX, UK, Tel: +44-21-356-7606, Telex: 334041, Fax: +44-21-356-892, Contact: Mr Hatt. Mechanical plant contractors, designers and manufacturers in the field of municipal and industrial water and waste water treatment.

**MAROLF INC** 15500 49th St North, Clearwater, FL, 33520, USA, Tel: +1-813-536-5991. Manufacture of water and wastewater treatment equipment for use in subdivisions and municipalities.

**MASS TRANSFER INTERNATIONAL**, Haversham, Cumbria, LA7 7EB, UK, Tel: +44-4482-3851, Telex: 65145, Fax: +44-4482-2729, Contact: Mrs S Whittaker. World leaders in the design and supply of low-energy, anaerobic and nitrification effluent treatment plant. Over 2,000 plants worldwide, treating an extensive range of industrial and municipal effluents.

**MECOLA MILIEUTECHNIEK BV** Corn Drebbel Straat, Wijchen, BH, 6603, The Netherlands, Tel: +31-8894-12176, Telex: 48769, Fax: +31-8894-21451, Contact: Mr Jonge. Sewage water treatment equipment, reverse osmosis equipment, pyrolyses, piping erection and welding, dissolved air flotation and radiation shielding.





**POLIMEX-CEKOP LTD.**  
the problem solving company.

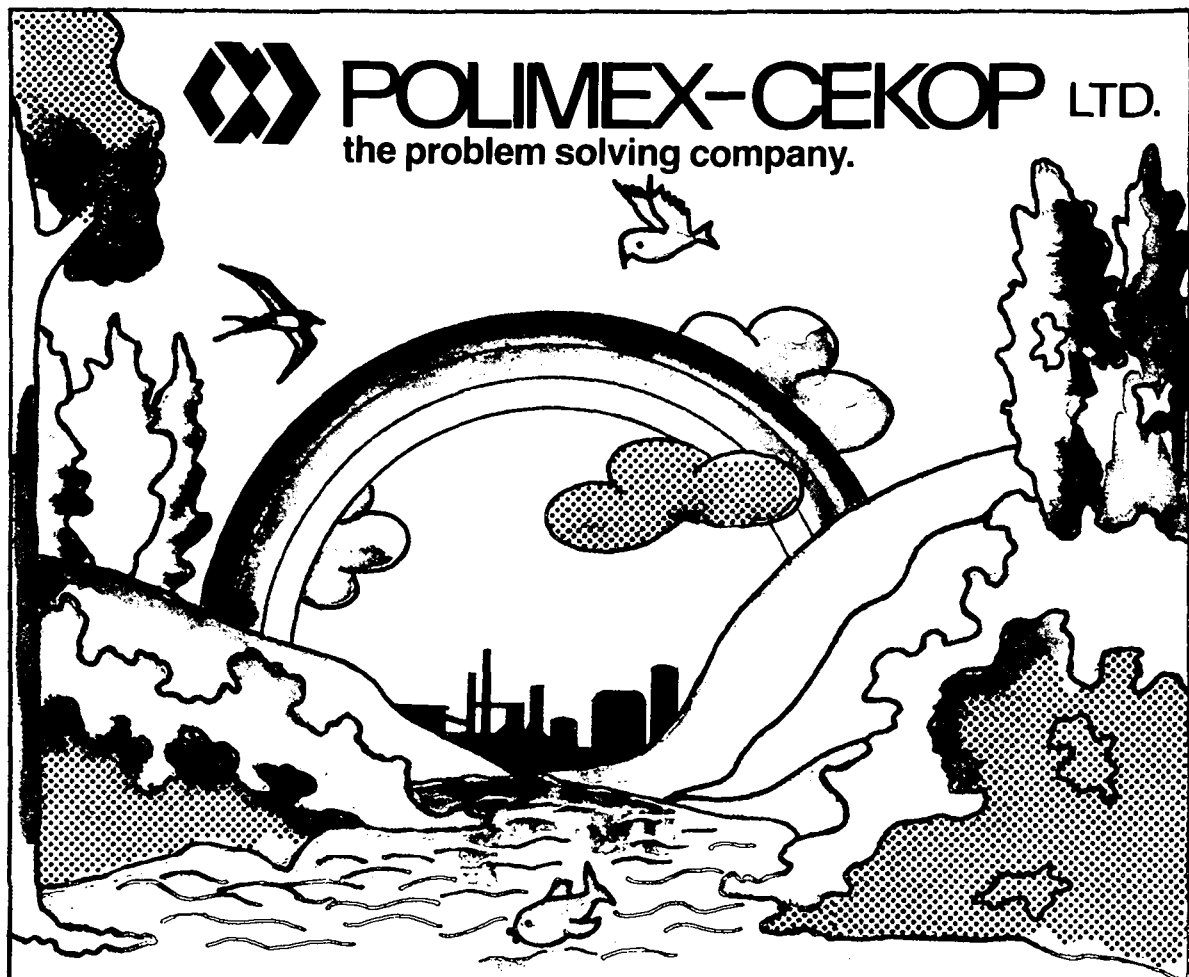

**We specialise in environment protection and water supply projects**

Polimex-Cekop is the most experienced Polish foreign trade company, we export turnkey projects, machinery and equipment, licences and know how, services including design work, consulting, technical supervision, erection works, modernization and reconstruction works. We also offer our services as subcontractor or supplier of elements and parts, basing on documentation of the foreign partner.

**Our export offer:**

- water supply systems for municipal and industrial purposes:
  - a/ water treatment plants/potable water and industrial water treatment plants/,
  - b/ water distribution systems,
  - c/ surface and ground water intakes,
- mechanical, biological and chemical treatment plants of municipal and industrial effluents, of various types,
- sewerage systems,
- water and sewage pumping stations,
- outdoor water and plumbing systems,
- elevated water tanks,
- utilization of municipal wastes.

Our experience abroad includes projects executed in Czechoslovakia, GDR, Greece, FR of Germany, Abu Dhabi, Egypt, Iraq, Iran, Kuwait, and Syria.

**For any inquiries, we are at your service.**

**Just contact**



**Polimex-Cekop**

Dept B-27, POLAND, 00-950 Warszawa, PO Box 815,  
Czackiego 7/9, tel. 0-4822 268001, ltx 814271, fax 260493

## GENERAL EQUIPMENT AND PROCESSES

**MET-PRO CORPORATION** P O Box 144, 160 Cassell Rd, Harleysville, PA, 19438, USA, Tel: +1-215-723-6751, Telex: 244903, Fax: +1-215-723-6758, Contact: Bob Reploge. Keystone Filter Division - manufactures cartridge filtration equipment for removal of sediment, taste and odor, lead, nitrates and other undesirable contaminants in drinking water supplier. Systems Division - manufactures packaged water purification systems, clarifiers, carbon treatment systems and gravity and pressure filtration equipment.

**NIAGRA PRODUCTS** 4 Gold Mine Rd, NJ, 07836, USA, Tel: +1-201-347-3700, Fax: +1-201-691-2225, Contact: Duane Cutler. Manufacturers of water conservation programmes and products.

**NITROKEMIA IPARTELEPEK - CHEMOLIMPEX HUNGARIAN TRADING COMPANY FOR CHEMICALS** H-1805 Budapest, POB 121, Hungary Tel: +361640240/840360, Telex: +226333, Fax: +361640078. CHEMOLIMPEX Hungarian Trading Company has achieved a good reputation on the international market. Our partners are satisfied with the cooperation both when exporting or importing their products. CHEMOLIMPEX deals with a wide variety of chemical products, including organic and inorganic base materials and intermediates for industrial and agricultural chemicals, base materials and final products of the plastics industry, and photographic chemicals. CHEMOLIMPEX is gradually growing into a group of companies that includes independent companies and concerns of various sphere of tasks and owners. CHEMOLIMPEX/NITROKEMIA has been engaged in the manufacture and marketing of ion exchange resins since 1957 under the VARION brand name. Ion exchange resins are widely used for water treatment in all fields of industry. We have developed specific ion exchange resins types for the following main applications: Conventional industrial water treatment, Decontamination of radio-active waste, Household water treatment, Novelty: micro ion exchange resin: more effective than powder resins.

**P & S WATER INDUSTRIES INC** 680 Waterloo St, London, Ontario, N6A 4N8, Canada, Tel: +1-519-672-0330. Manufacture of domestic water pumps and wastewater treatment equipment for use in the home and business.

**P V PACIFIC PTE LTD** 239 UBI Avenue 4, Intrepid Warehouse Complex, 1440, Singapore, Tel: +65-7488109, Fax: +65-7486168, Contact: Lim Hap Heng. Complete engineering design, supply, installation and commissioning on tanking projects. Basis for industrial effluent plant such as physical chemical and biological systems, process water drinking plants, deionization plants, sludge treatment and oil water separation for on/off shore application.

**PENFIELD LIQUID TREATMENT SYSTEMS** 8 West St, Plantsville, CT, 06479, USA, Tel: +1-203-621-9141, Fax: +1-203-621-2380, Contact: Mr Schultz. Manufacturers of filtration, softening, ion exchange, reverse osmosis and water filtration equipment.

**THE PERMUTIT CO** E 49 Midland Avenue, Paramus,

NJ, 07652, USA, Tel: +1-201-967-6000. Manufacture water and wastewater treatment equipment (industrial).

**PORTALS WATER TREATMENT** Oldfield Lodge, 156 Bridge Rd, Maidenhead, SL6 8DG, UK, Tel: +44-628-771444, Telex: 849067, Fax: +44-628-771567, Contact: Mr Hunter. Process design and engineering of water, effluent sewage and process liquids treatment project. PWT undertake contracts of any size throughout the world, and supply their own fully proven range of pre-engineered products and protect systems with a comprehensive range of speciality chemicals.

**PURATOR KLARANLAGEN** Goldegasse 2, Wien, A-1040, Austria, Tel: +43-222-65-67-85, Telex: 132716, Contact: Purator specialist in: sewer, separator and sewage clarification engineering. The line-up embraces: installations for conveying waste water from point of origin to sewer (eg manhole covers, gullies etc), petroleum, grease and starch separators, biological clarification plants for sewage, industrial and municipal waste waters (eg activated-sludge plants, bio filters, trickle filters, etc).

**ROSEWATER ENGINEERING LTD** Stonebroom Industrial Estate, Stonebroom, Derby, DE5 6LQ, UK, Tel: +44-773-875017, Telex: 378146, Fax: +44-773-874921, Contact: Mr Ainge. Rosewater designs, manufactures and installs process plant for the waste water treatment market including peristaltic pumps, fine bubble aerators, automatic desludging systems, package treatment plants, digester refurbishment and control panels.

**S E E Rue de la Science** 2F9 Brussels, B 1040, Belgium, +32-2-230-9314, Tel: +32-2-230-7613, Fax: 25-237. Water treatment plants: drinking water, waste water, water for industry, swimming pool water. Chemical products for water conditioning. Pre-fabricated units for the production of drinking water and waste treatment.

**SERCK BAKER LTD** Riga House, 380 Bristol Rd, Gloucester, GL2 6XY, UK, Tel: +44-452-421561, Telex: 435667, Fax: +44-452-423414, Contact: Alan Brown. Design, install and commission total water and effluent treatment systems. Specialists in filtration, aeration and chemical injection systems.

**SOUTHERN WATER CONDITIONING DIV ANDERSON CHEMICAL** 1840 Waterville Rd, Macon, GA, 31206, USA, Contact: L M Horton. Manufacture water and wastewater treating equipment and chemicals.

**HUBERT STAVOREN BV** 20 Kooyweg, Stavoren, 8715 EP, The Netherlands, Tel: +31-51-49-1625, Telex: 46110 EHSTA NL, Fax: +31-51-49-2198, Contact: Mr Allablas. The company design, manufacture and install equipment for water treatment and waste water treatment.

**STOISER UND WOLSCHNER** Bahnstrasse 87 + 93, Klagenfurt, Postfach 309, A-9021, Austria, Tel: +43-4222-321-092, Telex: 422902 stwo a, Contact: Stoiser und Wolschner (SW) Compact Oil-absorber Plants are designed for the cleaning of waste water contaminated with mineral oil in a series of cleaning steps. The compact basin is made of steel fibre and Tor steel-reinforced concrete with corrosion-proof inner lining.

## GENERAL EQUIPMENT AND PROCESSES

**SUNBIRD SALES INC** Box 125 Rt 68 Highway 107, Cullowhee, NC, 28723, USA, Tel: +1-704-293-5912. Sales and distribution of water and wastewater treatment equipment.

**SYNTECHNICS INC** 700 Terrace Lane, Paducah, KY, 42003, USA, Tel: +1-502-898-7303, Fax: +1-502-898-7306, Contact: Michael B Beott. SynTechnics manufactures fibreglass reinforced plastic cover systems for the water treatment and wastewater treatment industries. F R P is most advantageous in meeting structural requirements in hostile, corrosive environments. Applications for SynTechnics' structural enclosures include clarifiers, digesters, sludge thickeners, water storage tanks and other clear span applications with needs for weather protection and/or odor control.

**TEMCOR** PO Box 3039, 2825 Plaza Del Amo, Torrance, CA, 90510-3039, USA, Tel: +1-213-320-0554, Fax: +1-213-320-8629, Contact: G Clark Margolf. Design, fabrication and erection of all maintenance free aluminum covers and domes, for tanks of all shapes and sizes in the water and wastewater industry.

**TRANSCONTINENTAL WATER PURIFICATION** P O Box 846, Eugene, OR, 97440, USA. Water and wastewater equipment. Contractors and manufacturers representatives.

**TUKE & BELL LTD** Beacon St, Lichfield, Staffs, WS13 7BB, UK, Tel: +44-543-414161, Telex: 339216, Fax: +44-543-250462, Contact: Mr Walker. Tuke & Bell Ltd designs, manufactures and installs sewage purification equipment under contract, ranging from complete mechanical and electrical turnkey projects to individual systems and package sewage treatment plants.

**UNOX EFFLUENT TREATMENT SYSTEMS (WIMPEY ENGINEERING)** 27 Hammersmith Grove, London, W6 7EN, UK, Tel: +44-1-748-2000, Telex: 256666, Fax: +44-1-748-0076/748-6083, Contact: Amanda Powell. Contractors and specialist process and equipment suppliers to the water and sewage treatment industry.

**WAAGNER-BIRÉ** Stadlauer Strasse 54, Wien, Aktiengesellschaft 54, A-1220, Austria, Tel: +43-222-22-44, Telex: 134827 awbwa. The environmental engineering division of Waagner-Biré offers the following: biological waste water treatment, sewage purification systems for municipal and industrial effluents.

**WALLACE & TIEMAN DIV PENNWALT CORP** 25 Main St, Belleville, NJ, 07109, USA, Tel: +1-201-759-8000. Manufacturer of chlorination and other chemical-feed equipment and systems for treatment of municipal and industrial water and wastewater, includes indicating and transmitting flowmeters, chemical metering pumps, dry chemical feeders and cathodic protection systems for water storage tanks and treatment structures.

**WASSERTECHNIK GES M b h** Mitterndorf 5, Atzenbrugg, A-3452, Austria, Tel: +43-2275-61-02, Telex: 113442 solva. Solvin AWA 2000 high-speed waste water cleaning plants are intended for the immediate continuous separation of emulsified oil/water mixtures

without the addition of chemicals, low pollution, economy of operation and dependability being guaranteed by electronic monitoring.

**WATER ENGINEERING LTD** Aynho Rd, Adderbury, Banbury, Oxon, OX17 3NL, UK, Tel: +44-295-810581, Telex: 83655, Fax: +44-295-811997, Contact: John Mee. Design and supply of municipal effluent and water treatment plants worldwide, either on a project management basis or as individual products and process - extending to installation and commissioning.

**WATER ENGINEERING SERVICES LTD** Unit F, Kemberton, Halesfield 22, Telford, TF7 4QX, UK, Tel: +44-952-290497, Telex: 35835, Fax: +44-952-290353. Suppliers of packaged and purpose built water/effluent treatment plants including pressure filters, deionisation units, reverse osmosis and rotating biological contactors for sewage treatment.

**WEMCO (GB) - DIVISION OF BAKER HUGHES LTD** Mansard Close, Westgate, Northampton, NN5 5DL, UK, Tel: +44-604-52411, Telex: 311705, Fax: +44-604-57256, Contact: Mrs Willis. Mineral processing engineers and effluent treatment specialists. Manufacturers and distributors of specialised pumps for water.

**WESTERN WATER MANAGEMENT INC** PO Box 7469, 1345 Taney, N Kansas City, MO, 64116, USA, Tel: +1-816-842-0560, Fax: +1-816-842-6388, Contact: Paul M Gale. Wastewater treatment chemicals and equipment.

**YSI INCORPORATED** YSI Scientific Ltd, Lysons Avenue, Ash Vale, Aldershot, Hampshire, GU12 5QR, UK, Tel: +44-252-513006, Telex: 858210 INSTCOG, Fax: +44-252-511855. YSI dissolved oxygen and conductivity instruments monitor wastewater treatment and provide environmental control and enforcement. Other YSI systems help maintain pure water supplies by measuring temperature, pH, conductivity and ORP in surface water and groundwater as it's pumped from test wells. YSI instruments assure healthy crops of fish and shellfish in hatcheries and on fish farms.

### Specialised Equipment and Processes

**A R I K FAR CHARUV WATER SUPPLY ACCESSORIES** Kibbutz Kfar Charuv, Ramat Hagan, 12950, Israel, Tel: +972-6-763390, Telex: 6731 ARI IL, Fax: +972-6-763402. A R I Sewage Air Release Valve specially designed to release air and gasses during the filling of the line and to allow air to enter the line during emptying. The accumulated air and gasses at their high point are released when the pipe is under pressure. An air pocket which remains trapped inside the valve prevents contact between the sealing system and the sewage. A drainage opening on the side of the valve enables cleaning and draining of solids from the valve.

**ANDCO ENVIRONMENTAL PROCESSES INC** 595 Commerce Drive, Amherst, NY, 14150, USA, Tel: +1-

## SPECIALISED EQUIPMENT AND PROCESSES

716-691-2100, Telex: 91-547, Fax: +1-716-691-7221, Contact: Gary Peck. Manufacture and supply of waste water treatment systems for treatment of heavy metals, phosphates, fluorides and other water soluble organics.

**AQUATICS UNLIMITED** 2150 Franklin Canyon Rd, Martinez, CA, 94553, USA, Tel: +1-415-370-9175, Fax: +1-415-370-9179, Contact: James R Ziegler. Manufacturer of Aquamog-a multi purpose marine maintenance vessel with many easily interchangeable attachments. Aquamog cuts aquatic weeds deep and fast, rotovates hydrosol, removes rooted vegetation. Aquamog is a powerful suction dredge and bucket dredge. Self propelled, eliminates cables, reduces downtime, reaches under piers, inside boatslips, close to shore and cleans waterways.

**ARLAT TECHNOLOGY INC** 150 East Drive, Bramalea, Ontario, L6T 1C1, Canada, Tel: +416-458-8220, Fax: +416-458-8224, Contact: R Larry Madden. Arlat Technology Inc is a Canadian based manufacturer and representative of engineered process equipment for the water and wastewater treatment market. Arlat Technology Inc offers complete engineering and design capabilities along with products such as ultraviolet disinfection systems, ozonation equipment, plate settlers, clarifier mechanisms and static mixers.

**BIOFLOW (ENVIRONMENTAL CULTURES) LTD** Unit 18, Raleigh Industrial Estate, Eccleshall, Staffs, ST21 6JL, UK, Tel: +44-785-851573, Telex: 36136, Contact: Mr Divall. Environmental laboratory supplying bacteria cultures for various wastewater treatments including biological and hydraulic overloads, grease, odour, sludge-improvement and specific applications.

**BISANCO INC** 200 Rich Lex Drive, Lexington, SC, 29072, USA, Tel: +1-803-796-9231, Fax: +1-803-796-1602, Contact: Bill Watkins. Manufacture floating diversion baffle systems for waste treatment lagoons. Can used to create various flow patterns to improve efficiency. Suitable for indus trial, biological or domestic applications.

**BROOKLYNS LTD** Sandford Lane, Wareham, Dorset, BH20 4DY, UK, Tel: +44-9295-6656, Fax: +44-9295-54169, Contact: Mr Green. Manufacture a wide range of pre-cast concrete products for the water industry, including underground and above ground chambers and kiosks for stop cocks, valves, meters and hydrants, sewage treatment products and revetment systems. Also metal products - covers and frames, indicators and marker posts for pipelines etc.

**CHRIST AG** Hauptstrasse 192, Aesch, CH-4147, Switzerland, Tel: +41-61-78-46-46, Telex: 62458, Fax: +41-61-784485, Contact: Mr Meuli. Christ's processes are used for: the production of ultra pure water for electronic and pharmaceutical industries, the treatment and recycling of waste water from n-fertilizer plants, and for odour abatement of waste air.

**CJB DEVELOPMENTS LTD** Airport Service Rd, Portsmouth, PO3 5PG, UK, Tel: +44-705-664911, Telex: 664911, Fax: +44-705-697864, Contact: John Wilkinson. CJB Developments provides project management and

equipment for the treatment of waste water, eg flotation equipment to recover valuable products and to reduce effluent charges and oil/water separators.

**DENVER PROCESS EQUIPMENT LTD** Stocks House, 9 North St, Leatherhead, Surrey, KT22 7AX, UK, Tel: +44-372-379313, Telex: 23704, Fax: +44-372-379504, Contact: Mr Rickard. Produce machinery for the process industries, including slurry pumps, flotation machines, air pollution control units.

**FORCE FLOW EQUIPMENT** 3467 Golden Gate Way, Lafayette, CA, 94549, USA, Tel: +1-415-284-2200, Fax: +1-415-284-5945, Contact: Susan Peal. Manufacture chlorine scales for 1 ton containers, primarily for the waste water and water treatment industries. Also manufacture scales for stationary 30-60,000 pound tanks.

**GENERAL FILTER CO** 600 Arrasmith Trail, Ames, IA, 50010, USA, Tel: +1-515-232-4121, Fax: +1-515-232-2571, Contact: Bob Inonye. Manufacture water and waste water equipment: softeners, clarifier, packaged filter plants and gravity filter parts and controls.

**GRAVER WATER INTERNATIONAL** 2720 US Highway 22, Union, NJ, 07083, USA, Tel: +1-201-964-2554, Telex: 6853093, Fax: +1-201-964-7770, Contact: Mr Liman. Graver designs and manufactures a complete line of water and waste treatment equipment to fit the needs of industrial corporation and electric generators.

**GRIFFIN TECHNICS INC** Box 330, 178 Route 46, Lodi, NY, 07644, USA, Tel: +1-201-778-2131, Telex: 133411, Fax: +1-201-778-2357, Contact: G Lesznik. Manufactures and designs ozone-generating systems for potable water treatment, waste water disinfection and speciality chemical applications.

**GROUNDWATER TECHNOLOGY INTERNATIONAL LTD** St Andrews House, 22-28 High St, Epsom, Surrey, KT19 8AH, UK, Tel: +44-3727-42055, Telex: 948104, Fax: +44-3727-432100, Contact: Richard McIntosh. Primarily specialize in the restoration of contaminated soil and groundwater. A professional staff of approx 900 is dedicated to groundwater restoration and a manufacturing division produces specialized equipment for the recovery of contaminants and for the treatment of contaminated soil and ground water.

**GUARDIAN CHEMICAL SPECIALALITIES** PO Box 1743, 1225 W Princess St, York, PA, 17405, USA, Tel: +1-717-848-2570, Contact: Bruce Ketrick. Develop and market products and consultation services for industrial influent to effluent water treatment requirements. This includes clarification, pre-treatment equipment, boiler water chemical treatment, cooling water chemical treatment, fuel additives and waste water programme.

**ROBERT HUDSON (EFFLUENT EQUIPMENT) BECORIT LTD** Hallam Fields Rd, Ilkeston, Derbyshire, DE7 4BS, UK, Tel: +44-602-302603, Telex: 37526, Fax: +44-602-329683, Contact: Mr Hough. Design, manufacture and installation of a range of rectangular tank scrapers, circular tank scrapers and mechanical screens for water, effluent and sewage treatment plants.

## SPECIALISED EQUIPMENT AND PROCESSES

**ICI BIOLOGICAL PRODUCTS** PO Box 1, Billingham, Cleveland, TS23 1LB UK Tel: +44-642-523786, Telex: +587443 ICIAGH G, Fax: +44-642-522676. ICI has a worldwide network of licences who can provide design, construction and commissioning of it's Deep Shaft process technology. The Deep Shaft process is increasingly used to treat a range of effluents including domestic, industrial, food, alcohol, pulp and paper etc. Low running cost, low capital cost, high oxygen transfer rate and low land area are just some of the advantages.

**ICI PROFESSIONAL PRODUCTS** Woolmead House East, Woolmead Walk, Farnham, Surrey, GU9 7UB, UK, Tel: +44-252-724525, Telex: 858347, Contact: Ms Norris. Actellic M20 insecticide for use against chironomids, sylvicola and psychoda on sewage filter beds. Midstream and caseron aquatic herbicides for weed control in waterways.

**IDEAL HORIZONS INC** PO Box 1707, Rutland, Vermont 05701 1707 USA Tel: +1-802-773-4346, Fax: +1-802-773-2538. Ideal Horizons manufacture stainless steel ultra-violet disinfection equipment. Our modular systems allow for versatility over a wide range of applications and flow rates. These systems are engineered for durability and performance.

**INDUSTRIEANLAGEN-PLANUNGS UND HANDELSGES M b h** Willibald Nr 36, ST, A-4762, Austria, Tel: +43-7762-33-81 33-82, Telex: 27393 iph a. The firm plans and builds special waste disposal plants for contaminated soil, air and water. Combinations of various processes are widely used, eg fixed-bed electrolysis, centrifugal separation, special extraction, reverse osmosis and hyperfiltration, depending on the job.

**INNOVA-TECH INC** P O Box #920, Valley Forge Corporate Center, Valley Forge, Pennsylvania, 19481, USA, Tel: +1-215-666-9080, Fax: +1-215-666-1766. High strength food waste? Innova-Tech has experience in the meat, poultry, milk, candy and specialty food industries. Industrial pre-treatment or final stream discharge. We can help in either area! The Total Barrier Oxidation Ditch (TBOD) for final treatment. Flow equalization basins, bioflocculation units, dissolved air flotation units for industrial pre-treatment.

**LEIGH POLLUTION CONTROL LTD** 1 Station Rd, Four Ashes, Wolverhampton, West Midlands, WV10 7DQ, UK, Tel: +44-902-791616, Telex: 335684, Fax: +44-902-791772, Contact: Mr Spencer. Suppliers of metal finishing products, water treatment and effluent treatment plant, water softeners and deionising equipment etc.

**MODULAR PRODUCTION EQUIPMENT INC** 13939 Northway Freeway, Ste 143, Houston, TX, 77040, USA, Tel: +1-713-462-8607. Manufacturer of a unique non-clogging free flow oil coalescer - The S P Pack®. This can be used to enhance performance of existing API separator or flumes, CPI or tanks. Also can be used to separate free oil from waste water or any application where water effluent quality is important. (WT)

**NEPCCO** 2140 North East 36th Avenue, Suite 300, Ocala,

Florida, 32670, USA, Tel: +1-904-867-7482, Fax: +1-904-867-1320, Contact: Mr Olsen. Manufacturers of recovery well pump systems and air stripper towers, multi-well pump controllers, soil venting systems and catalytic converter systems.

**NORTHANTS AFORM LTD** Pound Lane, Thatcham, Nr Newbury, Berkshire, RG13 4TQ, UK, Tel: +44-635-63040, Fax: +44-635-71950, Contact: Mr Williams. Manufacturers of glass re-inforced covers for water tanks, and component parts for packaged effluent treatment and anaerobic digester systems.

**NORTON-PERFORMANCE PLASTICS** 150 Derby Rd, Wayne, NJ, 07470, USA, Tel: +1-201-696-4700, Fax: +1-201-696-4501. Manufacturers of cast nylon sewage sprockets for waste water treatment facilities and a complete range of products for the monitoring and sampling of ground water.

**P U K WATER TREATMENT LTD** Unit 11, Wheyston Close, Riverside, Medway City Estate, Strood, Rochester, Kent, ME2 4DP, UK, Tel: +44-634-290142, Telex: 966539, Contact: Mr F H Stone. Filtration: Rotary filters for primary or sole filtration and for polishing sewage.

**PCI OZONE CORP** 1 Fairfield Crescent, West Caldwell, NJ, 07006, USA, Tel: +1-201-575-7052, Telex: 244067, Fax: +1-201-575-8941. PCI Ozone Corp provides ozone systems for use in water and wastewater treatment, odor control and chemical processes. Ozone in the presence of polluting compounds reacts rapidly to form environmentally safe byproducts. This process is particularly effective as a treatment for both potable water and wastewater disinfection.

**PREMIER COLLOID MILLS LTD** Hersham Trading Estate, Walton-on-Thames, Surrey, KT12 3PZ, UK, Tel: +44-932-26305, Telex: 25539, Fax: +44-932-253234, Contact: Mr Peart. Manufacturers of flocculators, mixers and agitators specially designed for the effluent and water treatment industries. Range - 0. 25kw to 25kw, direct drive or geared.

**RIMER-ALCO LTD** Melingriffith Works, Whitchurch, Cardiff, CF47XT, UK, Tel: +44-222-378421, Telex: 498666, Fax: +44-222-387294, Contact: Mrs Davies. Rimer-Alco are manufacturers of compressed air dryers, filters, nitrogen and oxygen generating equipment for the treatment of effluent and oxygen enrichment for combustion systems.

**SIMON - HARTLEY LTD**, Stoke-on-Trent, ST4 7BH, UK, Tel: +44-782-202300, Telex: 36305SIMHARG, Fax: +44-782-261494, Contact: Bob Foxley. Manufacturers of a full range of mechanical equipment for the treatment of sewage and industrial effluents. Also full turnkey facilities for erection and supply of complete plants for sewage and industrial effluent treatment. Penstock and valves in metals and plastic construction.

**SKIMOVEX UK LTD** Highway House, 17 London End, Beaconsfield, Bucks, HP9 2HN, UK, Tel: +44-4946-7728/9, Telex: 837042, Fax: +44-494-678628, Contact: Mr Hume. Design, manufacture and supply of oil separation equipment, coalescers, filters, air flotation and

## SPECIALISED EQUIPMENT AND PROCESSES

chemical dosing equipment for use in all industrial/municipal waste applications.

**SMIT NYMEGEN** P O Box 9107, Nijmegen, 6500 HJ, The Netherlands, Tel: +31-80-568707, Telex: 48156, Fax: +31-80-567636, Contact: Mr Looy. High gradient magnetic systems for waste water treatment.

**SOBEA** P O Box 414, 62 Renan, Nanterre, 92004, France, Tel: +33-1-47-24-22-66, Telex: +203978. Produce and install water treatment units for the purification of waste water by filtration.

**STOCKDALE FILTRATION SYSTEMS LTD** Stockdale House, Waters Green, Macclesfield, Cheshire, SK11 6LF, UK, Tel: +44-625-616109, Telex: 66885, Fax: +44-625-34678, Contact: Mr Bosley. All types of liquid/solid separation equipment including: rotary vacuum, pressure leaf, sand filters, cartridge filters and oil/water flotation separators. Main applications - effluent, sludge dewatering and water polishing.

**STRANCO** Box 389, Bradley, IL, 60915, USA, Tel: +1-815-932-8154, Telex: 703480, Fax: +1-815-932-0674, Contact: Diane Anderson. Manufacture polymer injection equipment for potable and waste water.

**UOP FLUID SYSTEMS** 10054 Old Grove Rd, San Diego, CA, 92131, USA, Tel: +1-619-695-3840, Telex: 188906, Fax: +1-619-695-2176, Contact: Mr Randy Truby. Spiral wound, reverse osmosis membrane elements and pressure vessels. Applications include desalination, wastewater treatment and ultrapure water production.

**VALMONT INDUSTRIES INC** Valley, Nebraska, 68064, USA, Tel: +1-402-359-2201, Telex: 484459 VMYVLLY, Fax: +1-402-359-4429. Valmont Industries

offers the "Slurry Shooter" a specially designed center pivot for land application and treatment of slurry and effluent. The systems economically and efficiently apply waste from agricultural, industrial or municipal operations. A single system can cover up to 60 hectares and distribute over 4 million liters of waste per day. Valmont, through its associate company Rudolf Bauer of Voitsberg, Austria, also offers a complete range of specialized slurry pumps and Rainstar travelling guns suitable for wastewater application.

**WATTS URETHANE PRODUCTS LTD** Church Rd Lydney Gloucestershire GL15 5EN U K Tel: 44-594-44090, Telex: 43512 WATTS G, Fax: 44-594-42429, Contact: Mr Powell. Manufacturers of products from cast elastomeric polyurethane which has excellent load carrying capacity and excellent resistance to mechanical abuse. Applications include bridge support wheels and bottom scraper blades for primary settlement tanks.

**WEAVERBROOK LTD** 12 Draycott Rd, Upper Tean, Staffs, ST10 4JF, UK, Tel: +44-538-723777, Telex: 36523, Fax: +44-538-723723, Contact: Mrs Grey. Design and manufacture chemical process plant for the water treatment industry and effluent treatment.

**YSI INCORPORATED** YSI Scientific, Lysons Avenue, Ash Vale, Aldershot, Hampshire, GU12 5QR, UK, Tel: +44-252-513006, Telex: 858210 INSTCOG, Fax: +44-252-511855. YSI dissolved oxygen and conductivity instruments monitor wastewater treatment and provide environmental control and enforcement. Other YSI systems help maintain pure water supplies by measuring temperature, pH, conductivity and ORP in surface water and groundwater as it's pumped from test wells. YSI instruments assure healthy crops of fish and shellfish in hatcheries and on fish farms.

DEVELOPING WORLD  
**WATER**

**E**ntries ending in WT are taken from Water Technology Magazine's Planning and Purchasing Handbook. The subscription address is: Water Technology Magazine, 13 Century Hill Dr, Latham, NY 12110, USA. Telephone (518) 783-1281. Entries ending in IAWPRC are reproduced from the 1987-88 Yearbook of the International Association on Water Pollution Research & Control (IAWPRC) with the Association's consent. IAWPRC, 1 Queen Anne's Gate, London SW1H 9BT, England.



• Irrigation Projects •

**Increase your country's food production using the world's most tested, proven, automated irrigation system. Valmont's.**



Valmont systems operate in more than 45 countries, irrigating more than 30,000,000 hectares, proven over 500,000,000 operating hours.



## Automated irrigation offers tremendous savings of valuable resources – water, energy, chemicals, labor.



Valmont center pivots, linears, and corner systems are not simply a means of automatically distributing water. They are a proven means of saving and conserving your country's valuable resources while significantly increasing yields. Whether it's on heavy soils, sandy soils, rough ground or rolling land – over grains, vegetables, fodder, oilseed crops, or sugar cane, a Valmont system is a proven method of increasing your yield potential. Your cost per unit of production can drop dramatically. The additional income from increased yields alone can pay for the entire project in just a few years.

The precise, timely nature of water distribution is one reason. Automated systems distribute water evenly over the entire field. This allows for the application of plant nutrients through the system. Fertilizers. Herbicides. Micronutrients. Insecticides. Fungicides. All can be applied with great precision and at greatly reduced costs.

And while we're talking about savings, if you're surface irrigating now, you can look to water savings alone of up to 20%-60% with a Valmont automated system.

The successful development of mechanized irrigation projects requires careful attention to numerous details involving cost, policies, personnel, management and training. As the world's largest developer of automated irrigation projects, we pro-

vide a system's approach to development.

Please contact us for more information and specific guidelines for the following: 1) Feasibility studies. 2) Financial and economic appraisals. 3) Project management. 4) Construction. 5) Training. 6) On-going technical assistance.

**Valmont International**, Valley, Nebraska 68064 USA, Tel: (402) 359-2201, Telex: 484459 VMTVLLY, Fax: (402) 359-4429.

**Valmont S.A.**, Paseo de la Castellana 135 2, 28046 Madrid, SPAIN, Tel: (1) 4416222, Telex: 23772 VALME.



*Using lakes, streams, or underground water, large scale projects of even several hundred systems can be completed in far less time than projects based on canals and dams. And, in almost all cases, the cost is significantly less.*

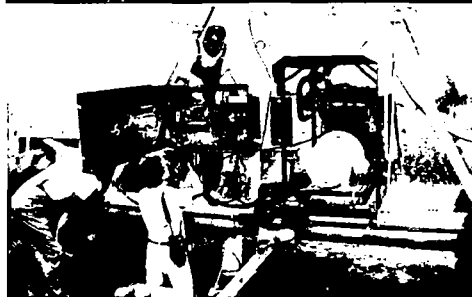

*Training is often a key to the future of any project. Valmont has facilities in several countries for technical training and is also prepared to provide training at the project itself.*



*Valmont will undertake construction of the entire project from water source development to final installation. The linear system pictured here is one in a project of 127 Valmont linear systems.*

# FOOD SECURITY THROUGH IRRIGATION

by

Richard Faulkner

**The population of many developing countries is growing at an alarming rate while their food output is not only failing to keep pace but is, in some cases, actually declining.**

For example, in Sub-Saharan Africa the population growth is estimated at 3.2% and the overall increase in food production at 2.3%. The result of this ever widening gap is that whereas the region produced 90% of its cereal needs in 1970, this had fallen to about 75% in 1985

and could be little more than 50% at the start of the next century. The recent series of droughts in the region have cruelly accentuated the underlying problem. In contrast, land with agricultural potential is some three times that currently utilised and the technical potential

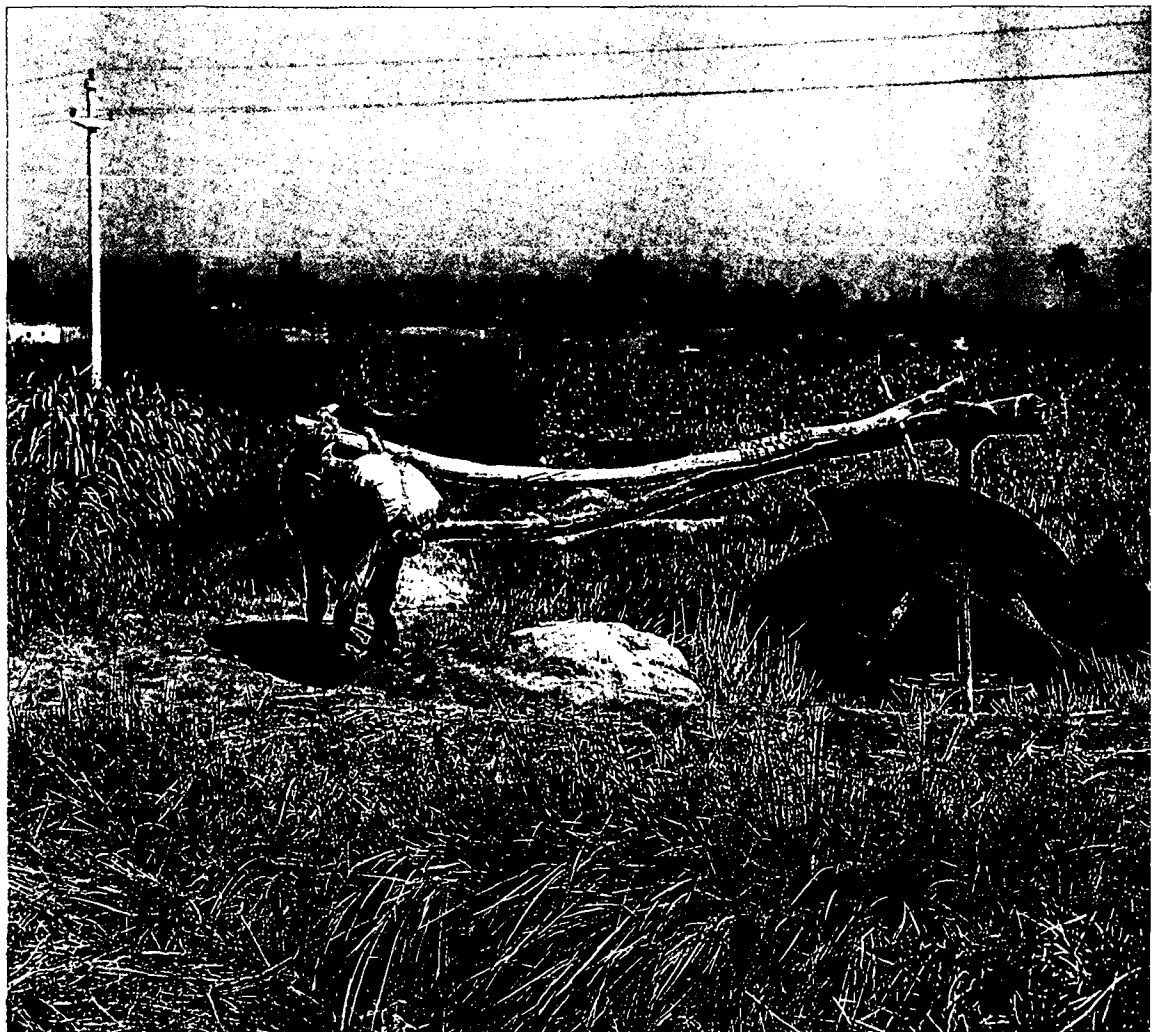

## IRRIGATION

for expanding irrigation has been estimated at six times the present level.

In the past, irrigation has been seen as a means of not only producing additional food for local consumption but as generating foreign exchange from cash crops (e.g., tobacco, tea). However, irrigation is no panacea and many existing schemes have not produced the anticipated benefits. The philosophy has prevailed that the maximum economies of scale would bring the greatest return on investment in such schemes. This led to very large individual projects involving the construction of a large dam, an extensive conveyance system of canals and regulator gates to facilitate precise control of water to different parts of the scheme and the introduction of mechanised farming techniques to maximise production. Unfortunately, all too often it may have been forgotten that the objective of irrigation is to grow crops and the indigenous skills and traditions of the local farmers and potential managers were ignored in the

*Traditional methods can give the best results.*



planning process. A long period of adjustment and training is necessary for people to adapt and this represents a considerable commitment from centralised extension services. There is much in the literature about the severe difficulties found in operating and maintaining large schemes in developing countries where remote locations and the need for spare parts and materials from overseas present insurmountable problems.

When problems arise, farmers tend to revert to traditional practices. Having been accustomed to water as a scarce resource, there is a tendency to over-irrigate when there is an apparently abundant supply which leads to waterlogging of the soil and possibly to salinity and the associated dramatic loss of fertility. It has been estimated that the annual loss of land worldwide due to these factors is in excess of 200,000 hectares. The health problems of large canalised schemes have also been widely publicised where water-borne disease and disease carrying vectors have increased manifold.

The most promising way forward in expanding irrigated agriculture is through small scale schemes and rehabilitation of existing works rather than building more very large schemes as in the past. Small projects are self-contained and remain manageable. Local farmers and people can be involved more easily in the planning process from an early stage and traditional farming skills can be preserved. In practice, small scale irrigation has been expanding with little or no support from governments. In Nigeria, for instance, fadama wetland cultivation increased sevenfold between 1958 and 1978. In Zimbabwe, an aggregate area of about 20,000 hectares on dambos (shallow wetland depressions) is currently cultivated, compared to less than 8,000 hectares on formalised large schemes; and the potential exists to increase this by a factor of five. However, there is a need for governments and donor agencies to recognise this sector as a valid target for support. Institutional support, loans, grants and training are needed to promote sustainable projects with some level of support continuing for ten years or more. Assistance is needed for basic water resource and socio-economic surveys, project design and construction, scheme operation and maintenance, agronomic research, extension services, health factors and monitoring and evaluation.

The cost of developing new, large irrigation works is variously estimated to be between US \$4,000 and US \$8,000 per hectare, whereas the cost of rehabilitation can be as low as US \$1,500. Further, the cost of developing traditional methods with plot sizes of less than one hectare, suitable for individual family units, is of the order of only US \$500 per hectare.

In conclusion, expansion of irrigated agriculture in developing countries is vital to meet the food demands of an increasing population. This expansion is most likely to be achieved by the rehabilitation of existing schemes and the promotion of numerous small scale schemes rather than by the construction of huge projects as seen in the past. Extension services and a commitment to continuing training will be necessary to ensure that the benefits resulting from irrigated agriculture are sustainable.

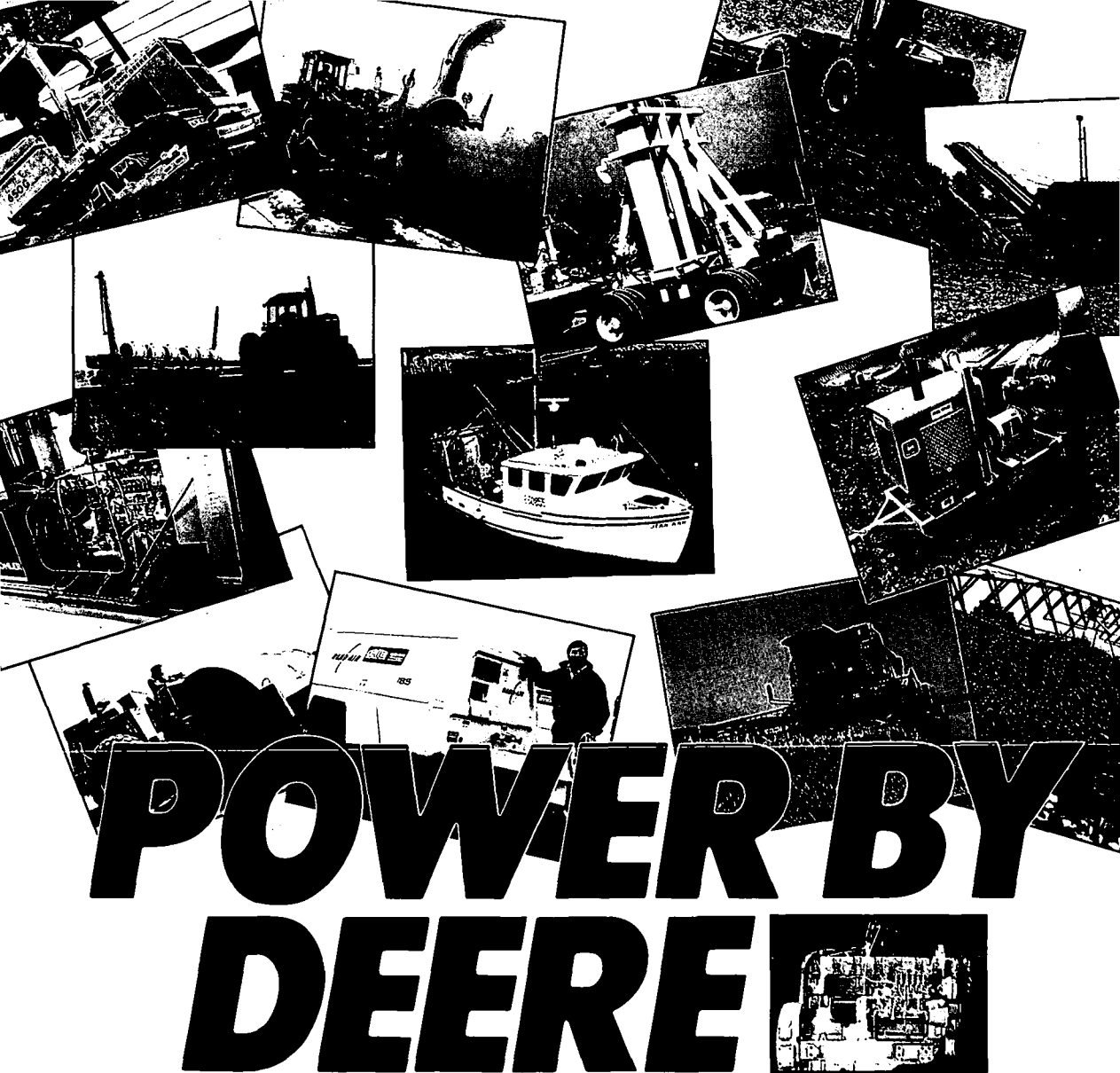

Irrigation, pumping, agricultural and other equipment is an asset only when it's up and running. So you can't take chances with diesel engines that can't be trusted.

John Deere has been manufacturing diesel engines since 1949, and is now one of the most popular sources of off-highway diesel power in North America. And John Deere tractors and combines are familiar sights around the world. That's because John Deere diesel engines have a proven track record for reliability, durability and serviceability. Customers everywhere trust John Deere diesel power to keep their businesses up and running.

Power by Deere. Put it to work for you.



For more information, contact  
John Deere Engine Group,  
P.O. 5100, Waterloo, IA 50704  
U.S.A. Telephone: 319/292-3916.  
Fax: 319/292-5075.  
Or B.P. 13, F-45401 Fleury-les-  
Aubrais Cedex, France.  
Telephone: 33 38 82 6023.  
Fax: 33 38 82 6000.

# REFLECTING THE CHANGES IN WORLD WATER

If you are involved in the world wide water industry you need  
**DEVELOPING WORLD WATER**

As well as a fascinating mix of feature editorial which covers subjects as diverse as surface water exploitation, urban sewage treatment, and irrigation systems for food crops, there is a comprehensive product & service information section which identifies over 4000 companies by their products and services, which makes this the most comprehensive guide available to the industry.

DWW is available direct from the publishers at £49.95 including post and packing.

Full details are available from

**Grosvenor Press International, Holford Mews,  
Cruikshank St., London WC1X 9HD.**

Credit Card sales are on 01 278 3000.

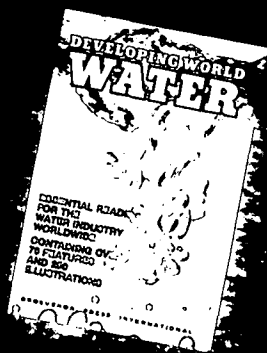

## Agricultural Chemicals (Pesticides, Fertilizers)

**AGRIMEX LTD** The Gallery, 72 West St, Marlow, Bucks, SL7 2BP, UK, Tel: +44-6284-71388, Telex: 847904 TREVAN, Fax: +44-735-75396, Contact: Trevor Barret. Agrimex have been exporting ULV sprayers to the Middle East and Far East for some time. As a result of ULV spraying, effective control of insects and diseases is obtained using much less active material than in water-based spraying.

**AQUASHADE INC** Box 198, Eldred, NY, 12732, USA, Tel: +1-914-557-8077, Fax: +1-914-557-8015, Contact: Billie Wilson. Aquashade® aquatic plant growth control. Through light reduction.

**BRENCO INTERNATIONAL** 30 Kirkham Industrial Court, St Louis, Missouri, 63119, USA, Tel: +1-314-968-0404, Fax: +1-314-968-2465, Contact: John S Brennan. Brenco International markets a line of agricultural chemicals, including chelated micronutrients, liquid and dry fertilizer, agricultural and greenhouse equipment.

**CULTIVEX PTY LTD** 244 Latrobe Terrace, Geelong, Victoria, 3220, Australia, Tel: +61-52-218394, Fax: +61-52-216313, Contact: Adrian M Kelly. Cultivex is a manufacturer and exporter of "cultisol" water soluble fertiliser suitable for drip irrigation application to vegetable crops, flower crops, fruit and vine crops. Cultisol is available in several different blends to suit crop types and growth stages of plant life.

**REGENAPLANT PRODUKTIONS - UND VERTRIEBSGES M b h & CO KG** Rossakgasse 30, WIEN, A-1232, Austria, Tel: +43-222-67-66-65. Regenaplant-Combi is a microfertiliser with homoeopathic catalyst and activator. Thanks to the carefully coordinated, minimised and directed application of all the constituents there is no pollution of soil, water or air but effective regeneration of soils and plants. The fertiliser is used for activating, regenerating and dressing of various plant cultures. It is based on a microanalysis system (backed by 12 years of experience) with which equally high if not higher yields can be achieved using considerably lower quantities of fertiliser and plant protection agents.

**WATERMATION LTD** Monument Way E, Woking, Surrey, GU21 5LY, UK, Tel: +44-4862-70303, Fax: +44-483-755082, Contact: Mrs E Hawthorn. Manufacturers of irrigation equipment for sports turf, landscape and dust control. Contractors for installation of irrigation schemes. Maintenance division for repairs and maintenance and, consultancy for design of irrigation schemes.

## Agricultural Machinery

**ABC HANSEN COMP AS** Soenbergade 3, Randers, 8900, Denmark, Tel: +45-642-11-11, Fax: +45-6-413622. ABC Hansen supply all manner of equipment for irri-

gation and agricultural applications, primarily to the newly industrialised and developing world.

**BIZZI & TEDESCHI SNC** Via Brodolini 35A, Campegine, RE, 42040, Italy, Tel: +39-522-677209-676257, Fax: +39-522-677633, Contact: Daniele Bizzi. Manufacturers of submersible electropumps for wells.

**CASE I H** 700 State St, Racine, Wisconsin, 53404, USA, Tel: +1-414-636-6011, Telex: +264425. Worldwide manufacturer and marketer of Case IH agricultural and Case construction equipment. The international marketing division supports local marketing offices, manufacturing plants, parts depots and a dealer network operating in six continents. Case IH is an affiliate of Tenneco Inc, Houston.

**CATERPILLAR DO BRAZIL SA** Av Nacoes, Unidas 22-540, Sao Davlo Sp, 04795, Brazil, Tel: +55-11-2464880, Contact: Alice Pab. Manufacture, assembly, importation and exportation of tractors and construction machinery, marine engines, generators, winches and related parts and equipment for the following markets: agriculture, earthmoving, road construction, industrial machinery and mining.

**CAYWOOD TRACTOR INCORPORATED** P O Box 22445, Lexington, Kentucky, 40522, USA, Tel: +1-606-268-2288, Contact: Michael Poole. In the business of renting and selling cases and backhoes. Also international John Deeres Tractors.

**JOHN DEERE** 400 Nineteenth St, Moline, Illinois, 61265, USA, Tel: +1-309-765-3057, Telex: 468-427, Fax: +1-309-765-3051, Contact: Dick Sellon. Complete line of agricultural production equipment: including 20 tractors from 25 to 370 gross horsepower, primary tillage, seed bed-finishing and crop-care equipment, combines, hay, forage and cotton harvesters. Three, four and six cylinder diesel engines, 58 to 315 SAE net hp, for powering pumping and irrigation systems. Track and wheel excavators, backhoe loaders, four-wheel-drive loaders, motor graders, scrapers and forestry equipment lines.

**ECON GROUP** Boroughbridge Rd, Ripon, N Yorks, HG4 1UE, UK, Tel: +44-765-5321, Telex: 57493, Contact: David Hollywell. Manufacturers of agricultural and municipal equipment. The all season self propelled sprayer and the MIID demountable sprayer. Suitable for all agricultural crop spraying.

**EIN-DOR LTD** PO Box 13129, 3 Haarad St Tel Aviv 61131 Israel Tel: +972-3482231/2, Fax: +972-3-483171, Contact: Mrs Ruhama Rubinstein. Manufacturers of modern irrigation equipment. Wide range of modular emitters for low-volume irrigation in orchards, trees, vegetables, nurseries, flowers, hothouses, landscape gardening, for frost protection and cooling system. Sprinklers, minisprinklers, midisprinklers, low-pressure, anti-insect, half-circle, misters, sprayers, bubblers, pressure regulators, numerous assemblies press-fit design to fit all requirements and technical engineering advise.

**R A HANSON COMPANY INC** P O Box 7400, Spokane, WA, 99207, USA, Tel: +1-509-467-0770, Telex: 326474,

# AGRICULTURAL MACHINERY

Fax: +1-509-466-0212, Contact: Mr Marty Col. As designers, engineers and manufacturers of custom machinery, the R A Hanson Company Inc provides working solutions to some of the world's most challenging equipment problems. RAHCO- efficiency through innovation.

**HARTVIG JENSEN & CO AS** Farverland 6, Glostrup, 2600, Denmark, Tel: +45-2-964355, Telex: 33123, Fax: +45-2-2459135, Contact: Mr Kjelstrup. Export to more than 100 countries, with subsidiary companies in six countries, among them Kenya. Product line is application equipment for all agricultural use - fields, orchards and horticulture as well as garden use.

**HORSTINE FARMERY LTD** North Newbald, York, YO4 3SP, UK, Tel: +44-696-827330, Telex: 52470, Fax: +44-696-57132, Contact: Mr Atkinson. Supply sprayers, fertiliser application equipment and hand-held equipment for the application of liquid and granular agrichemicals. Specialist equipment for granular insecticides. Specially relevant to new schemes.

**MOTORENFABRIK HATZ** Ernst-Hatz-Strabe 16, D-8399 Ruhstorf/Rott, PO Box 1162, Federal Republic of Germany Tel: +085313191, Telex: +57260, Fax: +0853132716. Motorenfabrik Hatz GmbH & Co. KG is by tradition an expert with over 100 years experience related to agricultural machinery, such as driving corn mills, rice shelling equipment, tractors, generating sets and pumping equipment. The Diesel engines are air-cooled and range from 3 - 8/HP. Hatz is represented in over 100 countries worldwide.

**OMACO INTERNATIONAL INC** 230 Park Avenue, Suite C-303, New York, 10169, USA, Tel: +1-212-682-4460, Telex: 961666, Fax: +1-212-490-6383, Contact: Mr Avedikian. Suppliers of irrigation and agricultural equipment.

**SAPP** P O Box 5513, Stockholm, S-11485, Sweden, Tel: +46-8-783-85-00, Telex: 19620 export s, Fax: +46-8-662-90-93, Contact: Mr Slodh. SAPP is the semi-official organization for collaborating Swedish companies specializing in the provision of services, technology, plants and equipment for agro-industry and agriculture, including water resources assessment and water supply.

**STUBENRUSS IRRIGATION SAS** V Castellano 4, Bressanone, BZ, I-39042, Italy, Tel: +39-472-35775, Telex: 400477, Fax: +39-472-34355. 2

**TIFA (C I) LTD** 50 Division Avenue, Millington, NJ, 07946, USA, Tel: +1-201-647-4570, Fax: +1-201-647-2517/7338. Fly and mosquito control.

**VARITY CORPORATION** 35 Davies St, London, W1Y 2FA, UK, Tel: +44-1-491-7000, Telex: 28346, Fax: +44-1-491-5271, Contact: Sandy Hill. Varity Corporation (formerly Massey-Ferguson Ltd), is a management holding company, based in Canada, whose operating business designs, manufactures and distributes farm machinery, industrial machinery, diesel engines, auto motive and hydraulic components

**VERMEER MANUFACTURING CO** Box 200, New

Sharon Rd, Pella, Iowa, 50219, USA, Tel: +1-515-628-3141, Telex: 478-309, Fax: +1-515-628-9338, Contact: Glenn Miller. Manufacturers of track trenchers, rubber tyre trenchers, agricultural equipment and tree-moving equipment.

## Control Equipment - Valves and Gates

**A R I K FAR CHARUV WATER SUPPLY ACCESSORIES** Kibbutz Kfar Charuv, 12950, Israel, Tel: +972-6-763390, Telex: 6731 ARI IL, Fax: +972-6-763402. ARIMAD-2, Field Testing System gets its information directly from the plant. A single leaf is placed in a sealed test chamber, in which atmospheric pressure is increased until a drop of water appears at the cut end of the leaf's stem. At that instant, the pressure is read, yielding an indication of the plant's "water potential" - its ability to absorb and utilize additional moisture. The test is then repeated with several additional specimens, to obtain a representative average value. ARIMAD-2 is light and portable. It can be operated easily by one person anywhere.

**ARAD LTD DALIA** Water Meter Works of Israel, Doar Dalia, 18920, Israel, Tel: +972-4-897911, Telex: 46383, Fax: +972-4-897960. Arad - 50 years a pioneering force in the production of technologically superior water meters, hydraulic and electronic control systems and irrigation valves. Arad systems are designed to meet modern needs of municipalities, agriculture and industry.

**BERMAD** Kibbutz Evron, M P Ashrat, Israel, Tel: +972-4-929241, Telex: 471606, Fax: +972-4-929-46, Contact: Ruben Weingorten. A complete range of valves for all applications in water supply and irrigation. Automatic valves, air release valves, pressure reducing and sustaining valves etc.

**BUCKNER** P O Box 60016, 4381 N Brawley Avenue, Fresno, CA, 93794-0018, USA, Tel: +1-209-275-0500, Telex: 910-350-6333, Fax: +1-209-275-3384, Contact: David Truttman. Manufacture a full line of products for the irrigation industry, including valves, sprinklers and controllers. Our products are applicable for the agricultural, residential, commercial, industrial and golf markets.

**EAGLE SIGNAL CONTROLS** 8004 Cameron Rd, Austin, TX, 78753, USA, Tel: +1-512-837-8300, Telex: 166975, Fax: +1-512-837-8486, Contact: Ray Piet. Provide industrial and commercial timers and controls for water treatment and irrigation industries. Particularly repeat cycle timers and percentage timers.

**HENDRIKSON BROS** 2931 Lester Avenue, Corona, CA, 91719, USA, Tel: +1-714-737-6822, Fax: +1-714-737-91751, Contact: Don Hendrikson. Manufacturers of water flow controls and pre-set pressure regulators for drip and low flow irrigation.

**IMPERIAL UNDERGROUND SPRINKLER CO** 13555

## CONTROL EQUIPMENT -VALVES AND GATES

W 107th, Lenexa, Kansas, 66215, USA, Tel: +1-913-469-5700, Contact: Bob Caviar. Manufacturers of underground sprinkler equipment for irrigation. Products include controllers, brass and plastic valves, and heads..

**IRRIGATION COMPONENTS INTERNATIONAL INC** P O Box 1063, 202 Congress St, Mobile, Alabama, 36633, USA, Tel: +1-205-432-5085, Telex: 881262, Fax: +1-205-433-7467, Contact: Mr John McCabe. ICI manufacture the following items (for center pivots) gear-boxes, gearmotors, sprinklers, drop pipes, main control panels, tower control panels, drive line couplings. Also a complete line of drip irrigation equipment, filters, valves, sprinkler irrigation equipment, (side rolls, aluminium fittings). Complete line of flowmeters, fertilizer/chemical injections pumps.

**JEFFERY ELECTRONIC CONTROL P/L** 6 Pacific Highway, St Leonards, New South Wales, 2065, Australia, Tel: +61-2-439-5982, Contact: Judy Jeffery. Design and manufacture of 'J E C' electronic irrigation and mist propagation controllers. Especially 'COMPU-RAIN' microprocessor irrigator and 'Weather Watcher' sensor automisters. Also cooling-humidifying units, filter flushing units, anemometer controls etc.

**MILLARS WELLPOINT (INTERNATIONAL) LTD** Barnham, Thetford, Norfolk, IP24 2PD, UK, Tel: +44-842-89451, Telex: 81361, Fax: +44-842-89645. Suppliers of pumps, wellpoint dewatering, irrigation and sewerage control systems. Engineering consultancy service supplying turnkey engineering packages.

**MOTOROLA COMMUNICATIONS ISRAEL LTD** 16 Kremenetzki St, Tel Aviv, 67899, Israel, Tel: +972-3-388306, Fax: +972-3-388925, Contact: Zvi Segal. Motorola, a world leader in electronics has developed a large family of computerized irrigation controllers. Capable to control water and fertilizer applications on real quantity bases and on line real time flow monitoring, can act as a stand alone in the field, or as a remote of control centre.

**L R NELSON CORP** 7719 North Pioneer Lane, Peoria, Illinois, 61615, USA, Tel: +1-309-692-2200, Telex: 882149, Fax: +1-309-692-5847, Contact: Judith Peterson. Manufacturer of high quality commercial and residential watering equipment. Oscillators, impact, nozzle, hose repair couplings and timers. Underground products include pop up sprinklers, controllers and valves.

**NETAFIM MAGAL K Magal, D N Hefer, 38-845, Israel, Tel: +06-367222, Fax: +972-6367252, Contact: D Biran.** Netafim offers the grower an ingeniously designed irrigation system to maintain full control on plant growth and yield. The agronomic department in conjunction with the design and field service departments, make sure you will get the equipment, design and service you require.

**NUOVO PIGNONE** Via Tiburtina Km, Rome, 12730, Italy, Tel: +06-40993-1, Fax: +06-4091239. Supervisory and remote control systems for water distribution, water treatment, wastewater treatment and water quality.

**OCV CONTROL VALVES** 7400 East 42 Place, Tulsa,

Oklahoma, 74145, USA, Tel: +1-918-627-1942, Telex: 910-845-2227, Fax: +1-918-622-8916. OCV manufactures and internationally markets a complete line of automatic, hydraulically operated, diaphragm actuated, pilot controlled valves. Included in the line are models for pump control, on/off, pressure reducing and relief and rate of flow for irrigation systems.

**P & R SURGE SYSTEMS INC** P O Box 3070, Lubbock, Texas, 79452, USA, Tel: +1-806-747-0065. P & R manufactures an extensive line of valves and controllers for surge irrigation. Surge is a low cost technique for improving surface irrigation uniformity and efficiency by cycling water between two irrigated sets. Low pressure diverter valves are available for pipe sizes from 4" to 12" diameter and all controllers are solar powered.

**RAIN spa** Via Petrocchi 4, Milano, 20127, Italy, Tel: +39-2-2610422, Telex: +324149 Rain I, Fax: +39-2-2828721, Contact: Judy A Evans. Electric solenoid diaphragm valves, resistant to chemicals, incorporating a self-cleaning system, available in various sizes. Screen filters providing centrifugal vortex water distribution with screen filtration in polyester or stainless steel.

**RAVIT IRRIGATION SYSTEMS** P O Box 9217, Tel Aviv, 61091, Israel, Tel: +972-3-338405, Telex: 342630, Fax: +972-8-443445/972-55-79552, Contact: Mr Abraham. Portable aluminium irrigation equipment 2" up to 10", couplings, valves, accessories, giant sprinkler system accessories, hydraulic control valves, tow line system and accessories, turnkey projects.

**SOCLA S A FRANCE** 1 Rue Paul Sabatier - BP300, 71107 Chalon s/Saone, Cedex, France, Tel: +33-85-46-30-34, Telex: 800259 SOCLA CHALN, Fax: +33-85-41-49-31. Socla offer a unique range of automatic backflow prevention devices which provide effective protection against contamination of potable water supplies in areas of high risk. Backflow or backsiphonage causes the device to drain contaminated water to atmosphere.

**SUPERIOR CONTROLS COMPANY** 24950 Ave Kearny, Valencia, CA, 91355, USA, Tel: +1-805-257-3533, Telex: 194250, Fax: +1-805-257-9472, Contact: Alan Greenland. Manufacture automatic irrigation controls both electro/mechanical and electronic, brass control valves for the irrigation industry from 3/4" to 3".

**US EXPORT & TRADING CO** 848 Harding St, Escondido, California, 92027, USA, Tel: +1-619-743-8211, Telex: RCA294277/ITT4994245, Fax: +1-619-745-1314, Contact: L L Forehand. Specialists in landscape irrigation design. Manufacturers of irrigation products (sprinklers, pipes, fittings and valves), ultra-violet resistant PVC pipe.

**WATERMAN IND INC** PO Box 458, Exeter, CA, 93221, USA, Tel: +1-209-592-3174, Fax: +1-209-562-2277, Contact: Mr J Howell. Manufacturer of surface irrigation equipment, alfalfa valves, riser valves, flap valves, penstocks, air vents, and pressure relief valves for drip and sprinkler systems. Low pressure gate valves, penstocks for turnout structures.

**WEATHER-MATIC** 17 Moorlands Rd Westmoors,



## CONTROL EQUIPMENT -VALVES AND GATES

Wimborne, Dorset, BH22 0JN, UK, Tel: +44-202-897781, Fax: +44-202-897780, Contact: Paul De Rham. Manufacturer of controllers, valves, sprinklers, bubblers and related accessories for landscape and turfgrass irrigation. All products manufactured in the U S A.

### Overhead and Drip Irrigation Systems

**ÜSTERREICHISCHE SALEN-KUNSTSTOFFWERK GESELLSCHAFT mbH** A-1072 Wien, Kaiserstrasse 45, P O Box 100, Austria, Tel: +43-222/96-15-01, Telex: +131406. Österreichische Salen-Kunststoffwerk GesmbH are Austria's biggest producer of plastic piping: systems and networks of plastic pipes characterised by corrosion-resistance, optimum flow (smooth internal wall surfaces) and low weight (easy transport).

**ABC HANSEN COMP AS** Soenbergade 3, Randers, 8900, Denmark, Tel: +45-642-11-11, Fax: +45-641-36-22. ABC Hansen supply all manner of equipment for irrigation and agricultural applications, primarily to the newly industrialised and developing world.

**AGRIFIM DE COLOMBIA** P O Box 26864, Bogota, Columbia, Tel: +57-1-2680899, Fax: +57-1-2447962, Contact: Fernando Umana. Agrifim manufactures drip and microirrigation emitters, jets and sprinklers as well as valves, filters, fertilizer injectors and all the fittings and accessories required for a system installation.

**AGRIFIM** 236 W Portal Avenue, Suite 327, San Francisco, CA, 94127, USA, Tel: +1-415-553-8048, Fax: +1-415-553-4110, Contact: Rodney Ruskin. Micro irrigation equipment: sale of equipment and licensing of technology to manufacture a full range of micro irrigation equipment.

**AMES-TINSA S A** Felix Cuevas No 120, Col Del Valle, CP, 03100, Mexico, Tel: +52-55-75-92-93, Fax: +52-5353166, Contact: John F Newby. Manufacture, design and sale of portable and semi-portable agricultural irrigation systems.

**AQUA PORE - DIVISION OF NATIONAL PUMPS** P O Box 1599, Glendale, Arizona, 85311, USA, Tel: +1-602-979-3211, Telex: JWX 910950111, Fax: +1-602-878-5923, Contact: Roger Jesttke. Manufacture a sub-surface irrigation system, low volume, low pressure. Delivers water directly to the root, the product is made of rubber and polyethelene.

**BANCILHON IRRIGATION** 21 Les Mourgues, Route D'Arles, Saint Gilles, 30800, France, Tel: +33-66874155, Contact: Mr Lagandre. Bancilhon manufacture a complete range of irrigation equipment, including centre pivot machinery, reel machinery, secondary and tertiary tubing and a solid set system of sprinklers.

**RUDLOF BAUER GESELLSCHAFT mbH** A-8570 Voitsberg, Austria, Tel: +43-3142/24-73, Telex: +03-13-41. The pipe and pump producer Rudolf Bauer GesmbH also turn out mobile and stationary sprinkling installa-

tions built to various designs. In the Solid Set System the whole field is densely covered with Bauer express-coupling pipes mounting closely spaced small-size sprinklers. In the Pipe Grid System sprinklers are fitted at only some of the points provided but can be operated under pressure to ensure the desired effect. In the Hose Pull System the distance between the sprinkler pipes is extended to as much as 100 m.

**BAYARD** 166 Rue de 4 Aout, Villeurbanne, 69625, France, Tel: +33-7-868-8181, Fax: +33-7-868-8815, Contact: Mr Bayard. Bayard manufacture component parts for water irrigation and water relief networks.

**BERMAD** 4070 Leaberton Court, Anaheim, CA, 92807, USA, Tel: +1-412-429-0247, Fax: +1-714-666-2533, Contact: Lary Schneider. Manufacturer and supplier of a complete range of irrigation equipment and associated products.

**A S BORDING MASKINFABRIK** Klochsvej 67, Bording, DK 7441, Denmark, Tel: +45-6861288, Telex: 16214, Fax: +45-6861520, Contact: Ole Soerenfn. Manufacturers and suppliers of self propelled irrigation machines, which employ a sprinkler system.

**BOWSMITH INC** PO Box 428, Exeter, CA, 93221, USA, Tel: +1-209-592-9485, Fax: +1-209-592-2314, Contact: Allan Smith. Bowsmith - 15 years of leadership in low volume irrigation products. The Bowsmith Non-Stop drip emitter is recognized worldwide as the most trouble-free emitter ever made. The first and only truly self-cleaning emitter. The Bowsmith Fan Jet sprinklers, too, have no equals. Fixed spray streams with 11 wetting pattern choices. Bowsmith products, often imitated, never duplicated. Peerless quality, consistent, accurate flow rates and unmatched dependability.

**BUCKNER** P O Box 60016, 4381 N Brawley Avenue, Fresno, CA, 93794-0018, USA, Tel: +1-209-275-0500, Telex: 910-350-6333, Fax: +1-209-275-3384, Contact: David Truttmann. Manufacture a full line of products for the irrigation industry including valves, sprinklers and controllers. Our products are applicable for the agricultural, residential, and commercial markets.

**CARVELLE** PO Box 2, St Denis Hotel, 45550, France, Tel: +33-38-59-02-10, Telex: 760786, Fax: +33-38-59-15-93, Contact: Mme Bellande. Pumps and sprayers for crop treatment.

**CENTRAL SUPPLY INC** 31-A Makaala St, Hilo, 96720, Hawaii, Tel: +1-808-961-5855, Contact: Mr Vince M Kimura. Central supply is in the supply house industry currently distributing industrial piping and supply, plumbing accessories, irrigation pipes and supply, irrigation systems design and sewer/drain pipes and fittings. Primarily wholesale.

**CHAPIN WATERMATIC INC** P O Box 490, 740 Water St, Watertown, New York, 13601, USA, Tel: +1-315-782-1170, Telex: 494-4418 CHAP WTR, Fax: +1-315-782-1490, Contact: Mr Boice. Manufacture drip irrigation products for nurseries, greenhouses and row crop.

**COMMERCIAL IRRIGATION SYSTEMS** P O Box

# RE-TRAC WATER SYSTEMS, S.A.

1755 Pech Rd. • Houston, Texas 77055  
Tel. #713/446-4815 • FAX 713/446-8488

**This whole irrigation system disappears in minutes!**

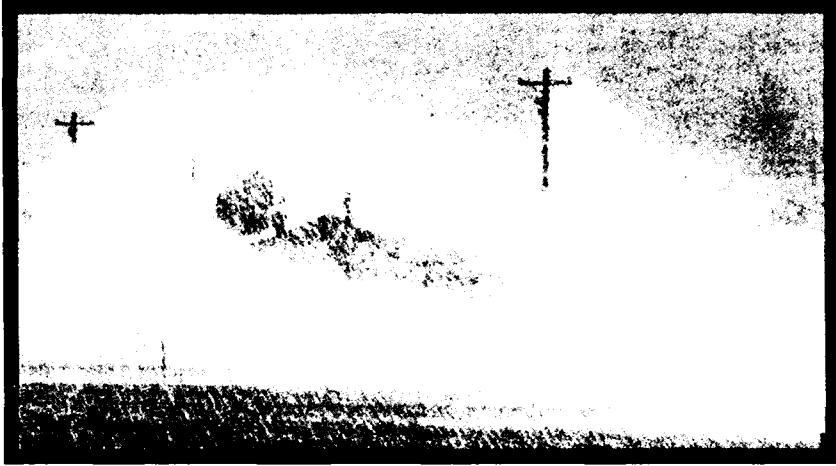

Retracted, the RE-TRAC water system can be disked over, plowed over, mowed over, and you can drive heavy equipment over it. You can subsoil over it, pick over it harvest over it, cultivate over it, plant over it, fertilize over it, and not stub your toe or bend a hoe. It disappears...really !

If you consider the advantages of something as simple as the RE-TRAC water system, you'll come up with some pretty amazing notions.

The system can be completely automated...that is, it will turn itself on, worm itself up through the ground, irrigate a field, and either remain above ground after turning off, or retract itself below the surface - you decide. Or, you can turn the valves on and off manually. The nice thing about the system is that you do not tear it to pieces when it's time to work the field...it submerges; it just goes away.

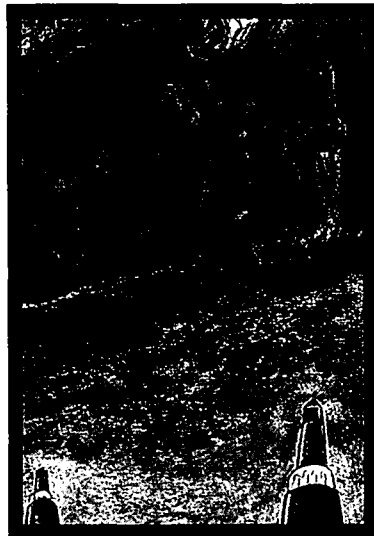

For ordering instructions or more information contact:  
**RE-TRAC WATER SYSTEMS, S.A.**

1755 Pech Rd.  
Houston, Texas 77055  
Tel. # 713/446-4815  
FAX: 713/446-8488

# RE-TRAC WATER SYSTEMS, S.A.

1755 Pech Rd. • Houston, Texas 77055  
Tel. #713/446-4815 • FAX 713/446-8488

**SEE! IT'S GONE. Same field, three minutes later!!!**

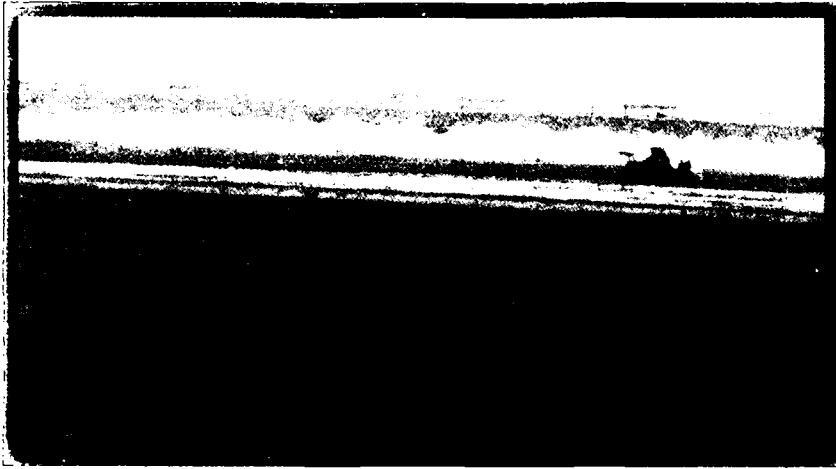

Water pressure on one side of the sprinkler units drives them skyward (four feet in the standard model, and more if you need it), and water pressure on the other side drives them back down. You decide how much of that four feet, or more, you want above and below the ground the system doesn't care. With the standard four-foot stroke, you can have the sprinklers submerge three feet and emerge one foot, submerge one foot and emerge three feet... you get the idea.

When the RE-TRAC system emerges and is in operation, only the very ends rotate (by means of a water driven turbine motor), eliminating large rotating mechanisms. Nozzles are available from 1/8 inch to 3/16 inch, enabling any field of any shape to be irrigated.

These pictures can't tell the whole story...our agents can. Please contact us for your specific needs.

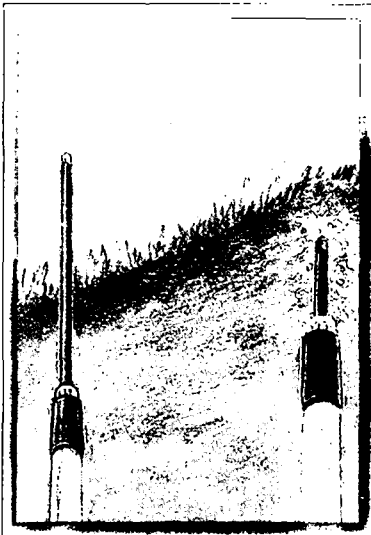

For ordering instructions or more information contact:

**RE-TRAC WATER SYSTEMS, S.A.**

1755 Pech Rd.

Houston, Texas 77055

Tel. # 713/446-4815

FAX: 713/446-8488

## OVERHEAD AND DRIP IRRIGATION SYSTEMS

75027, Birmingham, AL, 35253, USA, Tel: +1-205-871-7054, Fax: +1-205-871-7054, Contact: Carter L Elliott. Irrigation design, sales and construction, specialized in athletic fields, golf courses and commercial buildings.

**CONDRILL AB** Sveavagen 83 113 50 Stockholm Sweden Tel: +46-8-349560, Telex: +12336, Fax: +46-8-316762

**DINENNA IRRIGATION** 3235 Pine Valley Drive, Sarasota, Florida, 34239, USA, Tel: +1-813-924-8963, Fax: +1-813-644-9794, Contact: Frank J Dinenna. Irrigation specialist dealing in the service as designer, consultant and supervisor of irrigation systems for gold courses, playing fields and landscaping of commercial hotels. Also designs and builds drip and mist systems for agriculture and nurseries. Well versed in all irrigation components.

**ECON GROUP** Boroughbridge Rd, Ripon, N Yorks, HG4 1UE, UK, Tel: +44-765-5321, Telex: 57493, Contact: David Hollywell. Manufacturers of agricultural and municipal equipment. The all season self propelled sprayer and the MF1D demountable sprayer. Suitable for all agricultural crop spraying.

**ESSE BI PLASTIC SRL** Via la Forma N1, 60020, Sirola (Ancona) Italy Tel: +39-71-73600145. Telex: +560606 MARRA I, Fax: +39-71-936787. Clamp saddles, Quick release joint from pm 16 to 63 diameter from 75-90-110 they are pm 10, PVC fittings jointed threading, Sprinklers - small rotating atomiser, Sprayers, Dripper.

**EVENPRODUCTS LTD** Blayney's Lane, Evesham, Worcestershire, WR11 4TS, UK, Tel: +44-386-41212, Telex: 337300, Contact: Bob Rowland. Evenproducts Ltd are suppliers of irrigation equipment, specialising in sprinkler, trickle, sprayline and most systems for small to medium sized farmers. They supply a full range of ancillary products such as tanks, pumps, etc.

**GILMOUR GROUP** 332 W Broadway, Louisville, KY, 40202, USA, Tel: +1-502-587-5975, Fax: +1-502-587-5142. Irrigation and hose end (sprinklers, nozzles), pressurized tank sprayers in polythene and galvanized.

**HARDIE IRRIGATION** P O Box X, El Cajon, CA, 92022, USA, Tel: +1-619-562-2950, Fax: +1-619-258-9973, Contact: R Willis. Hardie Irrigation is the largest manufacturer of drip irrigation equipment in the world. An extensive product range in drip irrigation from emitters to filters, hose to valves. Distribution in many locations throughout the world.

**HB-PLASTIC GESELLSCHAFT mbH** A-2100 Korneuburg, Ungerweggasse 27, Austria, Tel: +43-2262/43-39, Telex: +132912 hbpla. HB-Plastic specialize in the production of drip-irrigation plants. For water well construction a patented system has been developed. At a drilled well diameter of 100mm the corrosion-resistant pipes can be given a length of up to 15 metres and submersible pumps of appropriately high delivery inserted. The drilling unit is of mobile design and can be transported by lightweight truck.

**HENDRY IRRIGATION INC** P O Box 846 5005 Main

St, Labelle, FL, 33935, USA, Tel: +1-813-675-3355, Fax: +1-813-675-6094, Contact: Steve Ridgely. Supplier and installer of drip and microjet irrigation, specializing in citrus crops. Whether you are looking for the right parts for the job, or the right people for the job, Hendry Irrigation is your wise choice.

**HOBBS-ADAMS ENGINEERING CO** P O Box 1833, Suffolk, Virginia, 23434, USA, Tel: +1-804-539-0231, Telex: 494-8083, Fax: +1-804-934-3264, Contact: Harrold Blythe. Hobbs-Adams Engineering Company manufactures reel rain traveler and center pivot irrigation.

**IMPERIAL UNDERGROUND SPRINKLER CO** 13555 W 107th, Lenexa, Kansas, 66215, USA, Tel: +1-913-469-5700, Contact: Bob Caviar. Manufacturers of underground sprinkler equipment for irrigation. Products include controllers, brass and plastic valves, heads and nozzles.

**IRRI-NAMIC INC** P O Box 686, Randolph, MA, 02368, USA, Tel: +1-617-986-2847, Contact: Mr Charter. Manufacturers of sub-surface, modified drip irrigation products and accessories. The system is used in most applications in lieu of conventional upright systems.

**IRRIDELCO CORPORATION** P O Box 1615, Irridelco Plaza, 440 Sylvan Avenue, Englewood Cliffs, NJ, 07632, USA, Tel: +1-201-569-3030, Telex: 219240 178153 1781521, Fax: +1-201-569-9237, Contact: Mr John Jordan. Design and distribute irrigation systems and equipment worldwide. Specialising in drip irrigation, sprinkler irrigation and mechanised irrigation.

**IRRIGATION COMPONENTS INTERNATIONAL INC** P O Box 1063, 202 Congress St, Mobile, Alabama, 36633, USA, Tel: +1-205-432-5085, Telex: 881262, Fax: +1-205-433-7467, Contact: Mr John McCabe. ICI manufacture the following items (for center pivots) gearboxes, gearmotors, sprinklers, drop pipes, main control panels, tower control panels, drive line couplings. Also a complete line of drip irrigation equipment, filters, valves, sprinkler irrigation equipment, (side rolls, aluminium fittings). Complete line of flowmeters, fertilizer/chemical injection pumps.

**IRRIGATION SYSTEMS CO** West Lodge, Adsdean, Funtington, Chichester, Sussex, UK, Tel: +44-243-575708, Telex: 86333, Fax: +44-243-786930, Contact: Mr Usher. Design, supply and installation of sprinkler and drip irrigation systems, for agriculture, horticulture etc. Turnkey contracting, management contracts, and feasibility studies.

**IRRITECH** 20 Avenue 20-29, Zone 10, Guatemala City, Guatemala, Tel: +502-2-373228, Fax: +502-2-347360, Contact: Estuardo Juaréz Pineda. Design installation and maintenance service for drip irrigation systems. Hardie irrigation products.

**JOHNSTON IRRIGATION INC** Post Office Box 2076, Fort Pierce, FL, 34954, USA, Tel: +1-407-466-4500, Fax: +1-407-466-6081, Contact: Matthew M Johnston. Johnston Irrigation serves the US and the international marketplace with complete irrigation services including overhead and drip irrigation systems, engineering/

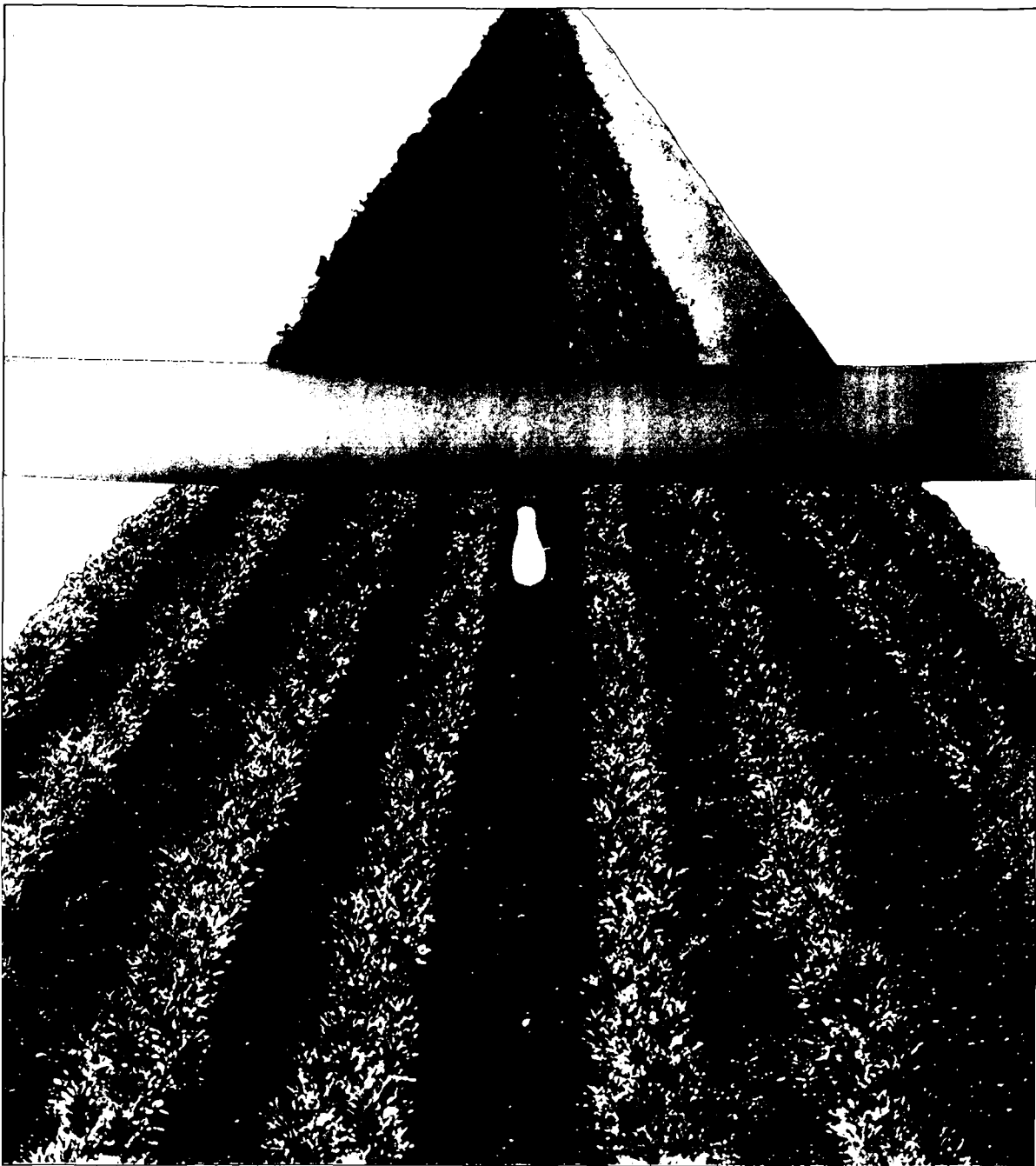

## Netafim. The down-to-earth solution.

Netafim has revolutionized the way things grow, with drip irrigation systems that deliver precise water and nutrient solutions directly to plant roots.

In any climate, topography, existing water conditions, or soil composition, Netafim systems account for significant yield increases in many types of crops—in some cases, as much as tenfold!

An international concern with representation in over 60 countries,

Netafim leads the world in drip irrigation systems and equipment.

For a full range of services, including feasibility studies, consultation, system-planning, installation, and turn-key projects, contact your nearest Netafim representative, or any of our home offices.

No matter where on earth you are, Netafim's advanced technology is there to meet your needs.



**NETAFIM**  
IRRIGATION EQUIPMENT  
& DRIP SYSTEMS

**Kibbutz Hatzetim**  
D.N. Hanegev 4, 85505, Israel,  
Tel. 057-6731111, Fax: 972-57-420098  
Telex: 5207 NET IL.

**Kibbutz Magal**  
D.N. Hefer 38845, Israel,  
Tel. 06-367222, Fax: 972-6-367252  
Telex: 471733 NET MG IL.

**Kibbutz Yiftah**  
D.N. Merom Hagail, 13840, Israel,  
Tel. 06-942761, Fax: 972-6-951221  
Telex: 6727 YI NET IL.,

## OVERHEAD AND DRIP IRRIGATION SYSTEMS

design, project management/installation, wholesale materials, pump design, and consulting. Johnston Irrigation is one of the largest agricultural irrigation contracting companies in the United States.

**K-RAIN** 1640 Australian Avenue, Riviera Beach, Florida, 33404, USA, Tel: +1-407-844-1002, Fax: +1-407-842-9493, Contact: Mr Hudson. Manufacture irrigation control timers, valves and sprinklers.

**KASKAD ENGINEERING LTD** 26-30 Station Rd, Epworth, Nr Doncaster, DN9 1JU, UK, Tel: +44-427-873034, Telex: 56326, Contact: J O'Toole. Manufacturers of hose reel irrigators and suppliers of associated equipment, installation of submersible pumps, irrigation scheme design, and borehole consultancy.

**KIFCO/AG-RAIN INC** 600 S Schrader Avenue, Havana, Illinois, 62644, USA, Tel: +1-309-543-4425, Fax: +1-309-543-4945, Contact: Graham Curtis. Manufacture a range of hard hose machines from 0.86'i/d x 220' to 4.0'i/d x 1250' long. Also specialize in both small machines for sportsturf and mid-size to large machines for agricultural use.

**LINDSAY INTERNATIONAL SALES CORP** 363 North Belt, Suite 1230, Houston, TX, 77060, USA, Tel: +1-713-591-7300, Telex: 203292 LINHI UR, Fax: +1-713-591-0566, Contact: Gaston Solis. Lindsay® and Zimatic® centre pivot irrigation systems are widely recognised as leaders in the industry. Zimatic systems using water, energy and labour to deliver higher yields. A wide array of sprinkler/spray options allows maximum water application efficiency.

**LOCKWOOD CORPORATION** P O Box 160, Highway 92 East, Gering, Nebraska, USA, Tel: +1-308-436-5051, Telex: 484454, Fax: +1-308-436-5732, Contact: Leonard Esenach. Manufacturers of mechanized centre pivot irrigator and linear irrigation for medium and large acreage.

**MAXIJET** PO Box 1849, Dundee, Florida, 33838, USA, Tel: +1-813-439-3667, Telex: 5106006190, Fax: +1-813-439-6851, Contact: Suzy Thayer. Maxijet pioneered low-volume spray irrigation. 14 years experience and commitment to quality guarantees the finest spray jet available.

**MOSS PRODUCTS PTY LTD** 711 Clayton Road, Clayton South, Victoria, Australia, Tel: +61-3-551-6188, Fax: +61-3-551-7915, Contact: Gary Strahan. Garden watering & small irrigation systems. Supplies of pop-up sprinklers & drip watering systems, micro-spray and misting sprinklers. The complete irrigation system. For the home gardener or small market gardens.

**L R NELSON CORP** 7719 North Pioneer Lane, Peoria, Illinois, 61615, USA, Tel: +1-309-692-2200, Telex: 882149, Fax: +1-309-692-5847, Contact: Judith Peterson. Manufacturer of high quality commercial and residential watering equipment. Oscillators, impact, nozzle, hose repair couplings and timers. Underground products include up sprinklers, controllers and valves.

**THE OASIS WAY** 4260 Venture Circle, Meridian, Idaho,

83642, USA, Tel: +1-208-323-8283, Contact: Peter Corino. Make automatic fertilizer systems for turf irrigation and the fertilizer to go with the system. Through our system there is no friction loss or pressure loss, no gauges for external power required. It is totally self-contained and automatic.

**OMACO INTERNATIONAL INC** 230 Park Avenue, Suite C-303, New York, 10169, USA, Tel: +1-212-682-4460, Telex: 961666, Fax: +1-212-490-6383, Contact: Mr Avedikian. Suppliers of irrigation and agricultural equipment.

**PEPCO WATER CONSERVATION PRODUCTS** 1820 W Jacquelyn Avenue, Fresno, CA, 93722-5027, USA, Tel: +1-209-275-3555, Fax: +1-209-275-5021. Manufacturers of products used for water conservation in landscaping irrigation. Extrude polythene tubing, which is laser drilled, allowing water to be emitted over 6" to 12". Also manufacture Quadra Bubbler flow control device, which controls flow from 2gpm to 20gpm.

**PERROT IRRIGATION LTD** 38 High St, Rowhedge, Colchester, Essex, CO5 7ET, UK, Tel: +44-206-867624, Telex: 987852, Fax: +44-206-869911, Contact: Mr Thornton. Manufacture and supply of irrigation equipment: sprinklers, mobile, stationary, quadrangle, horticultural, agricultural, dust suppression, pipes and fittings, pumps and hose reel irrigators, slurry irrigators.

**PIOGGIA CARNEVALI SpA** Strada S Cisa 47, Porto Mantovano, MN, 46047, Italy, Tel: +376-398151 2 3 4, Telex: 300541 PIOCAR, Fax: +376-390873. Pioggia Carnevali SpA is one of the largest and oldest manufacturers of irrigation equipment in Italy. The firm manufactures self-propelled hard hose irrigation systems offering 68 different models for all type and size of farms. These high quality irrigation systems are sold and promoted worldwide. Also manufactures: aluminium and galvanized steel pipe, couplings, fittings, large volume and low volume sprinklers, tractor and engine driven pumps of all sizes, tripods and hand-primer-pumps.

**PLUMMER SUPPLY INC** PO Box 177, Bradley, Michigan, 49311, USA, Tel: +1-616-792-2215, Fax: +1-616-792-6637, Contact: Cal Plummer. Sales & service of pumping units, hard & soft hose, travelers, alum & pvc pipe & fitting. Also sprinklers.

**POLYTHENE PIPES CD-HD** PO Box 488, 152 St Andrew St, Limassol, Cyprus, Tel: +357-51-62860, Telex: 2668, Contact: Mr Filios. Suppliers of drip irrigation systems, polythene tubes, PVC pipes and associated products.

**POLYTUBES (1977) LTD** PO Box 3814 Stn D, 12160 160 St, Edmonton, Alta, T5L 4J8, Canada, Tel: +1-403-452-8375, Fax: +1-403-452-8397, Contact: L M McCaffery. Poly tubes (1977) Ltd has been in the polyethylene tubing and pipe business for 36 years. We manufacture tubing and pipe from 1/4" to 6" diameters in low, medium and high densities. We also manufacture tubing for drip applications.

**PREMIER IRRIGATION EQUIPMENT LTD** 17/1C

## OVERHEAD AND DRIP IRRIGATION SYSTEMS

Alipore Rd, Calcutta, West Bengal, 700027, India, Tel: +91-45-530245-762645-7455, Contact: M J Pook. We manufacture a range of irrigation equipment and systems available at competitive prices along with full technical, sales and installation support: aluminium and lightweight galvanised quick coupling pipes, sprinklers of all types, drip irrigation tubing, fittings and filters, pumps, diesel/electric and tractor driven pumps and hydrams - powerless pumps.

**RÜHREN-UND PÜMPENWERK RUDOLF, BAUER GmbH** Kowaldstrabe 2, Voitsberg, Postfach 2, 8570, Austria, Tel: +43-3142-2473, Telex: 03214803-1341. Bauer sprinkler irrigation systems help to make soil fertile. Conventional sprinkler irrigation plants with Bauer quick-coupling pipes, sprinklers and "Stargun" wide-range rainers are operating throughout the world. Solid set sprinkler systems which require little maintenance. Rainstar irrigation machines for fully mechanized irrigation operation. Center Pivot systems to make sprinkler irrigation fully automatic. Turnkey sprinkler irrigation plant and agroindustrial projects. Industrial plants for manufacturing sprinkler irrigation equipment. Waste water treatment, transforming waste water into water usable for irrigation.

**RAVIT IRRIGATION SYSTEMS** P O Box 9217, Tel Aviv, 61091, Israel, Tel: +972-3-338405, Telex: 342630, Fax: +972-8-443445/972-55-79552, Contact: Mr Abraham. Portable aluminium irrigation equipment 2" up to 10", couplings, valves, accessories, giant sprinkler system accessories, hydraulic control valves, tow line system and accessories, turnkey projects.

**RE-TRAC WATER SYSTEMS** 1755 Pech Road, Houston, Texas 77055, USA Tel: +1-713-446-4815, Fax: +1-713-446-8488. Automated Irrigation Sprinklers which can be withdrawn into the ground for tillage or harvest of the field and, on demand, its riser is thrust upward through the soil. The water driven turbine motor in the top of the riser rotate's the sprinkler nozzle mounted thereon for overhead irrigation sprinkling.

**REINKE MANUFACTURING COMPANY INC** PO Box 566, Deshler, Nebraska, 68340, USA, Tel: +1-402-365-7251, Telex: 910-623-8031, Fax: +1-402-365-4370, Contact: Mr Kling. Manufacture central pivot and lateral move irrigation systems.

**SALCO PRODUCTS INC** 4463 W Rosecrans Avenue, Hawthorne, California, 90250, USA, Tel: +1-213-973-2400, Contact: Samuel Tobey. Salco Products Inc has over twenty years' experience in the manufacture of drip irrigation products. This experience, together with extensive research and development, enable Salco to offer one of the best, most reliable and cost-effective drip irrigation systems available anywhere in the world. Their products are distributed extensively in the USA and in many parts of the world and are used with great success in both the agricultural and the landscape industries.

**SAPP** P O Box 5513, Stockholm, S-11485, Sweden, Tel: +46-8-783-85-00, Telex: 19620 export s, Fax: +46-8-662-90-93, Contact: Mr Slodh. SAPP is the semi-official organization for collaborating Swedish companies spe-

cializing in the provision of services, technology, plants and equipment for agro-industry and agriculture, including water resources assessment and water supply.

**SENNINGER IRRIGATION INC** 6416 Old Winter Garden Rd, Orlando, FL, 32811, USA, Tel: +1-407-293-5555, Telex: 56-6558, Fax: +1-407-293-5740, Contact: Ms Laurie Johnson. Manufacturers of sprinklers, spray nozzles and pressure regulators for all types of irrigation equipment, both pivot and solid step systems.

**SIEMENS SOLAR GmbH** Buchenallee 3, Bergisch Gladbach 1, D-5060, West Germany, Tel: +49-2204-4060, Telex: 884891 sso, Fax: +49-2204-40666. Our scope of supply encloses solar powered surface water and deep well pumping systems for irrigation: surface water pump - max height 11.5 m, max output 43 m<sup>3</sup>/h. Deep well pump - max height 5-160m, max output 1.3-36 m<sup>3</sup>/h. Converting light into electricity, we use the greatest energy resource at lowest costs.

**SNEED-MCBRIDE INTERNATIONAL INC** 8440 Walnut Hill Lane, Suite 501, Dallas, Texas, 75231, USA, Tel: +1-214-369-5710, Telex: 732645, Fax: +1-214-739-3551, Contact: Billie. SMI/Sneed-McBride International Inc, was among the first companies to introduce modern methods of irrigation worldwide. SMI equipment includes: SMI 360 center pivot, SMI drip and micro spray, SMI speedroll sprinkler, Kelley pumps and SMI grain-potato-storage systems.

**SOCIETE NOUVELLE IRRIFRANCE** 34230 Paulhan, France, Tel: +67-25-25-25, Telex: 490-971 F. Irrifrance is a member of the SETI group (Societe d'etudes des techniques d'irrigation). The company supplies: installations with mobile pipes, sprinklers and pumping stations, mechanized equipment such as "automatic reel machines" for sprinkling of small and medium areas, pivot system "pivomatic" for the automatic sprinkling of medium and large areas, drip irrigation or micro-irrigation.

**SPRINKLINK** PO Box 45-0054, Garland, Texas, 75045-0054, USA, Tel: +1-214-530-3631, Contact: N Warren Johnson. Residential and commercial landscape irrigation design.

**SUBMATIC INC** P O Box 246, Lubbock, Texas, 79408, USA, Tel: +1-806-747-9000, Contact: Dave Brown. Drip irrigation equipment, pivots and extension equipment for drip tubing.

**T-L IRRIGATION COMPANY** PO Box 1047, Hastings, Nebraska, 68901, USA, Tel: +1-402-462-4128, Telex: 438047 THRRGHAST, Fax: +1-402-462-4617, Contact: Dave Thom. Manufacturer of centre pivot, linear mode corner systems, quickflow and aluminium tubing.

**TEAM SPRAYERS LTD** Unwins Industrial Estate, Prickwillow Rd, Ely, Cambs, CB7 4QT, UK, Tel: +44-353-661211, Telex: 81486 standen g, Contact: Mr Hubbard. Design, develop and manufacture agricultural and horticultural spraying machinery and equipment for spraying products going into store.

**THE URBAN FARMER STORE** 2833 Vicente St, San

## OVERHEAD AND DRIP IRRIGATION SYSTEMS

Francisco, CA, 94116, USA, Tel: +1-415-661-2204, Contact: John Stokes. Publish their own mail-order catalog of drip and low volume irrigation supplies, and are a source for Hardie, Toro, Buckner, Rainbird, Oasis and Garden America (Irritrol/Richdel) timers, valves and sprinklers.

**TORO (EUROPEAN & MIDDLE EAST OFFICE)** Unit 7, Millstream Trading Estate, Ringwood, BH24 3SD, UK, Tel: +44-4254-6261, Telex: 41136, Contact: Mr Roberts. Toro offers fingertip control plus quality products designed specifically for irrigating landscape, parkland and sports turf areas worldwide. Backed by their extensive international distributor network, Toro also provides reliable maintenance and spares back-up customer services.

**TORO (HEAD OFFICE)** 5825 Jasmine St, Riverside, California, 92504, USA, Tel: +1-714-688-6261, Telex: 676490. Toro offers fingertip control plus quality products designed specifically for irrigating landscape, parkland and sports turf areas worldwide. Backed by their extensive international distributor network, Toro also provides reliable maintenance and spares back-up customer services.

**TORO (PACIFIC OFFICE)** P7 Waitara, New South Wales, 2077, Australia, +61-2-487-1622, Fax: 790-25873. Toro offers fingertip control plus quality products designed specifically for irrigating landscape, parkland and sports turf areas worldwide. Backed by their extensive international distributor network, Toro also provides reliable maintenance and spares back-up customer services.

**TWIN DROPS IBERICA SA** Basilio Sala 21, San Juan De Alicante, Alicante, 03550, Spain, Tel: +34-96-5652058, Fax: +34-96-5657437, Contact: Juan Fco Martinez Vicente. Drip-irrigation systems, drippers, polyethylene tubes, valves, accessories and irrigation equipment.

**TYKOFLEX AB** Box 614, Tyresö, S-13526, Sweden, Tel: +46-8-712-0055, Telex: 10902, Fax: +46-8-742-3001, Contact: Kristina Sauqvist. Tykoflex sell irrigation systems for golfcourses, cemeteries, lumfer-yards and agriculture purposes. Red obstruction light, RL30, for high obstacles, quick coupling, Model 42, pipes and fittings of stainless steel, aluminium and galvanised steel.

**US EXPORT & TRADING CO** 848 Harding St, Escondido, California, 92027, USA, Tel: +1-619-743-8211, Telex: RCA294277/ITT4994245, Fax: +1-619-745-1314, Contact: L L Forehand. Specialists in landscape irrigation design. Manufacturers of irrigation products (sprinklers, pipes, fittings and valves), ultra-violet resistant PVC pipe.

**VALMONT INDUSTRIES INC** Highway 275, Valley, Nebraska, 68064, USA, Tel: +1-402-359-2201, Telex: 484459 VMTVLLY, Fax: +1-402-359-4429, Contact: Gary Geiger. Manufacturers of mechanised irrigation equipment (central pivot, linear moves and hard-nose travellers).

**VU-FLOW FILTERS COMPANY** 7805 Ellis Rd, Mel-

bourne, FL, 32901, USA, Tel: +1-407-723-5171, Fax: +1-407-723-1627, Contact: Bryan Russell. Manufacture filters, strainers and sand separators commonly used in turf and agricultural irrigation. These filters are manufactured entirely of non-corrosive materials and are capable of flow rates from 5 to 2000 gallons per minute.

**WADE'RAIN SPRINKLER IRRIGATION** PO Box 23666, Portland, Oregon, 97223, USA, Tel: +1-503-641-1865, Telex: 15-1539, Fax: +1-503-626-8298, Contact: Theresa Rodriguez. Manufacturers of a variety of irrigation systems primarily for agriculture and centre pivot systems, sideroll systems, aluminium solid set systems, aluminium portable systems, aluminium mainline, plastic drip systems and polyethylene drip tubing.

**ING WALDHAUSER MASCHINENFABRIK GESELLSCHAFT mbH & CO KG** A-8591 Maria Lankowitz, Puchbachweg 239, Austria, Tel: +43-3144/2228 3153 3157, Telex: +3-104513. Waldhauser is engaged in the production of automatic sprinkling plants for various crops and field or farm sizes. A special feature of the Waldhauser sprinkling plants is the hydrostatic drive, which operates with minimum pressure losses, and guarantees troublefree handling of muddy or sandy water and even homogeneous liquid manure without the need for filtration. The sprinklers are of simple design and maintenance-free.

**WATER WAYS IRRIGATION ENGINEERING INC** P O Box 70188, Bakersfield, California, 93387, USA, Tel: +1-805-831-3535, Contact: John Tkac. Manufacturers of aluminum irrigation systems.

### Software and Irrigation Services

**JAMES BARRETT ASSOCIATES INC** P O Box 853, Montclair, NJ, 07042, USA, Tel: +1-201-744-8237, Contact: J M Barrett. The firm provides a full range of design and consulting services for all facets of golf course irrigation systems, including new construction and remodeling.

**CPN CORP** 2830 Howe Rd, Martinez, CA, 94553, USA, Tel: +1-415-228-9770, Fax: +1-415-228-3183, Contact: William Mancuso. Manufacture of neutron probe for measurement of sub-surface moisture.

**DUNTECH IRRIGATION SERVICES LTD** Lashlake Nurseries, Towersey, Oxon, OX9 3QZ, UK, Tel: +44-84421-5411, Telex: 83628, Contact: Mr Enticknap. Agricultural and horticultural irrigation and water engineering. Feasibility studies, design, procurement, installation and management. Techcrop hydroponics and rockwell systems. Environmental control, effluent treatment, well master rising main and associated pumps.

**FEDERAL LAWN SPRINKLER SUPPLY CO** 6029 14 Mile Rd, Sterling Hts, MI, 48077, USA, Tel: +1-313-264-7460, Fax: +1-313-264-7171. Wholesale distributor of irrigation fountains and low voltage landscape lighting supplies. Product lines include Hardie Irrigation, Nelson Sprinklers, Weather-Matic Lawn Sprinklers, Rain-Jet Fountains, Luma Landscape Lighting and many



## SOFTWARE AND IRRIGATION SERVICES

more. Services include complete specification and design for each of these areas.

**FLOSONICS INC** PO Box 390, Umatilla, Oregon, 97882, USA, Tel: +1-503-567-1966, Contact: Terry Henderson. Flosonics Inc offers complete irrigation system design, analysis and re-design, computer printouts for center pivot sprinkler spacing and related services.

**FRIEL IRRIGATION INC** PO Box 415 Marstons Mills, Cape Cod, MA, 02648, USA, Tel: +1-508-420-7805, Contact: Jim Friel. We sell, install and service underground lawn sprinkler systems. Friel Irrigation is a full service company, serving both the residential and commercial market. We are centrally located in the town of Barnstable covering the Cape.

**GILMOUR GROUP** 332 W Broadway, Louisville, KY, 40202, USA, Tel: +1-502-587-5975, Fax: +1-502-587-5142. Irrigation and hose end (sprinklers, nozzles), pressurized tank sprayers in polythene and galvanized.

**NUOVO PIGNONE** Via Tiburtina Km, Rome, 12730, Italy, Tel: +06-40993-1, Fax: +06-4091239. Supervisory and remote control systems for water distribution, water treatment, wastewater treatment and water quality.

**WADE'RAIN SPRINKLER IRRIGATION** PO Box 23666, Portland, Oregon, 97223, USA, Tel: +1-503-641-1865, Telex: 15-1539, Fax: +1-503-626-8298, Contact: Theresa Rodriguez. Manufacturers of a variety of irrigation systems primarily for agriculture and centre pivot systems, sideroll systems, aluminium solid set systems, aluminium portable systems, aluminium mainline, plastic drip systems and polyethylene drip tubing. Over 50 years experience. Also system design and turnkey projects.

**WAT-IRR INC** P O Box 215, Buckeye, Arizona, 85326, USA, Tel: +1-602-247-4170, Contact: Don W Drew. Irrigation systems, design, system analysis.

### Special Purpose Pumps, Pipes and Other Equipment

**A/S DE SMITHSKE** Tagholm 1, PO Box 205, DK-9400 Norresundby Denmark Tel: +45-9-8178111, Telex: 69620 desmi dk, Fax: +45-9-8175494. A/S De Smithske is a modern production and sales enterprise with a considerable technical know-how and with modern production and administration facilities. During the past years an intensive product development has resulted in new DESMI products within our entire range of centrifugal pumps and transmissions for the industrial and agricultural sectors.

**ABACHEM ENGINEERING LTD** Jessop Way, Newark, Notts, NG24 2ER, UK, Tel: +44-636-76483, Contact: Mr Parrott. Manufacture windpumps for domestic, irrigation and drainage systems, up to 120 metre head and maximum capacity of 8,700 litres per hour.

**ABS PUMPEN AG**, Lohmar, D-5204, W Germany, Tel:

+49-2246/13-1, Telex: 889619, Fax: +49-2246/13-200, Contact: Mr W Klimmek. ABS PUMPEN AG is one of the world leaders for submersible pumps for drainage, irrigation and sewage up to 500 kw, including submersible mixers. Subsidiaries and representation in more than 50 countries.

**ALPHA POMPE SRL** P O Box 10, Via Molino Emili, Maclodio BS, 25030, Italy, Tel: +39-30-978661, Fax: +39-30-27-22-261, Contact: Mr Grazioli Venanzio. Centrifugal, selfpriming drainage pumps, electric pumps, petrol and diesel motor pumps.

**AMIAD FILTRATION SYSTEMS** Kibbutz Amiad, Mobile Post Korazim, 12335, Israel, Tel: +972-6-935838, Telex: 6693 AMIAD IL, Fax: +972-6-935-337, Contact: Ms Tamar Nir. Manufacturers of water filters for irrigation, industry and municipal purposes. Manually-cleaned plastic filters from 3/4" to 3". Manually-cleaned steel filters from 2" to 14". Automatic self-cleaning filters from 2" to 12" made of steel or stainless steel. Also manufacturing chemical and fertilizer injectors which need no outside source of energy.

**AQUASERVICE** Cunard Building, Water St, Liverpool, L3 1HR, UK, Tel: +44-51-236-6421, Telex: +628512, Fax: +44-51-227-4759. Aquaprime engine pumpsets for irrigation and de-watering.

**BERSELLI SAS DI BERSELLI LEANDRO MIRRO** RC P O Box 76 Via Emilia Est 86, Castelfranco Emilia, MO, 41013, Italy, Tel: +3959-92-41-06, Telex: 520527 Irrber I, Fax: +3959-92-01-06. Specialized in the production of galvanized steel pipes and aluminium pipes for irrigation and industry, fittings, motorpumps, electric pumps.

**E BRAUDE (LONDON) LTD** Liberta House, Sandhurst, Surrey, GU17 8JR, UK, Tel: +44-252-876123, Telex: 858842, Contact: Mr Stables. Braude corrosion resistant high performance low cost self priming chemical pumps handle water treatment solutions. Levelmaster provides reliable and accurate level control of chemical solutions and water including de-ionised water.

**CARVELLE** PO Box 2, St Denis Hotel, 45550, France, Tel: +33-38-59-02-10, Telex: 760786, Fax: +33-38-59-15-93, Contact: Mme Bellande. Pumps and sprayers for crop treatment.

**DAF DIESEL** Geldropseweg 303, TK Eindhoven, 5645, The Netherlands, Tel: +31-40-142709, Telex: 51297, Fax: +31-121-047. Manufacturers of high quality diesel engines and power packs for irrigation installations.

**DAVEY PRODUCTS PTY LTD** 118 Atkinson St, Oakleigh, Victoria, 3166, Australia, Tel: +61-3-568-1655, Telex: AA139654, Fax: +61-3-568-4551. Manufacturers and marketers of pressure systems, end suction pumps - domestic, commercial and farm, swimming pool filters and pumps, spa bath pumps, engine driven pumps and pressure tanks.

**DUIJVELAAR POMPEN BV (DP INDUSTRIES)** Kalkovenweg 52, Alphen Aan Den Rijn, LK, 2401, The

Small amount to invest – low cost to operate – high yield to harvest

## **HYDRAK**

The most cost-effective underground irrigation system for loose and desert soil structures.

### SOME ADVANTAGES OF HYDRAK

- water and energy saving process
- highest pressure needed is 0, 5-0, 8 bar
- irrigation directly to the roots
- soil structure is not compressed
- all soluble fertilisers and soil disinfectants can be introduced into the soil
- up-to-date agrotechnical activity is not adversely affected
- applicable to already existing cultivations

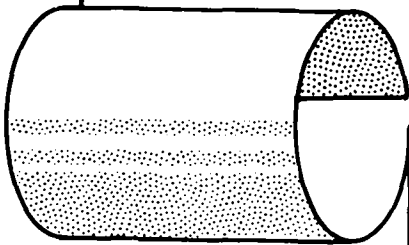

No-one in this economic-conscious world can afford the luxury of not at least trying a system, which has so many advantages like the Hydrak Underground Irrigation System.

**NIKEX HUNGARIAN FOREIGN TRADING CO.**

H-1016 BUDAPEST I., MÉSZÁROS U 48-54

TEL: 361/753128, 560122

TLX: 22-6406

TELEFAX: 36-1-755131 NIKEX-H

Please transfer enquiries in the Gulf States to:

MR TAMÁS

P.O. BOX: 574 SHARJAH U.A.E.

TELEX: 68354

FAX: 00971 6592760

## SPECIAL PURPOSE PUMPS, PIPES AND OTHER EQUIPMENT

Netherlands, Tel: +31-1720-37034, Telex: 39691, Fax: +31-1720-33137, Contact: Ms Vogel. Duijvalaar pumps are used to supply drinking water, for irrigation in greenhouses, as jockey pump, boilerfeed pump, on car wash installations, for air conditioning and many other purposes. One of the most important features of the Duijvalaar pumps is that they are mainly made of stainless steel, thus combining durability with high efficiency.

**EBARA CORPORATION** 11-1 Haneda Asahicho, Ohta-Ku, Tokyo, 144, Japan, Tel: +81-3-743-67-16, Telex: EBARA TYO 322988, Fax: +81-3-745-3576, Contact: Mr R D Jones. EBARA is probably one of the largest specialist pump companies in the world 4000 employees manufacturing in Japan, Indonesia and Singapore a comprehensive range of pumps for all applications.

**EMPIRE IRRIGATION INC** Box 1237, Adams City, CO, 80022, USA, Tel: +1-303-288-3400, Telex: 493-2481 EMPIRE, Contact: Steve Spear. Manufacturers of gravity flow surface irrigation products such as aluminium syphon tubes and plastic collapsible surface gated pipes.

**ESSE BI PLASTIC SRL** Via la Forma N1, 60020, Sirolo (Ancona) Italy Tel: +07173600145, Telex: +560606 MARRA I, Fax: +071936787. Clamp saddles, Quick release joint from pm 16 to 63 diameter from 75-90-110 they are pm 10, PVC fittings jointed threading, Sprinklers - small rotating atomiser, Sprayers, Dripper.

**EVENPRODUCTS LTD** Blayney's Lane, Evesham, Worcestershire, WR11 4TS, UK, Tel: 144-386-41212, Telex: 337300, Contact: Bob Rowland. Evenproducts Ltd are suppliers of irrigation equipment, specialising in sprinkler, trickle, sprayline and most systems for small to medium sized farmers. They supply a full range of ancillary products such as tanks, pumps PVC main, etc.

**FLUXINOS ITALIA SRL** Via Genova 8, 58100 Italy Tel: +0564451272, Telex: 322458 Ikrane I, Fax: +0564454237. Pulsa System water oscillation or spring rebound inertia deep well solar and/or hand pumps for small-scale microirrigation market gardening and animal watering in developing countries. Used in boreholes from 65mm internal diameter and for water levels of up to 50m+. 300Wp photovoltaic array connected directly to above ground direct current motor. Daily capacity approximately 9m<sup>3</sup>, plus supplementary capacity through use by had in hours when sunlight not available or in support of the solar panels when instantaneous sun power insufficient on its own for pump operation.

**FLYGT AB** Box 1309 S-171 25 SOLNA, Sweden. Tel: +46-8-733 6500, Telex: +43887 flygtab s, Fax: +46-8-295816, Contact: Anderz Öhringe. Flygt is the world's leading manufacturer of submersible heavy-duty pumps for contaminated and abrasive liquids. The annual sales for 1988 was approx SEK 2.3 billion. With over 1,250,000 installations in more than 100 countries throughout the world, Flygt submersible products encompass an awesome range of pumps, mixers and hydro turbine generators for small scale hydro electric power stations. The main office is situated in Solna, just outside Stock-

holm, with manufacturing facilities are in Lindsa. Flygt has subsidiaries in 16 countries and 3,400 employees of which 1,500 are in Sweden.

**FORDWATER PUMPING SUPPLIES LTD** 49-53 Stratford Rd, Birmingham, West Midlands, B11 1RQ, UK, Tel: +44-21-772-8336, Telex: 335807, Contact: Brian Powell. Supply and maintain all types of pumps.

**GRAINLAND INC** 239 Lincoln, Clay Center, KS, 67432, USA, Tel: +1-913-632-3101, Fax: +1-913-632-5860, Contact: Kyle Bauer. Grainland offers insertion flowmeters for portable and permanent installation. The electronic meters are programmable for various line sizes and report totality and rate of flow. No outside power is needed. Maintenance requirements are low and can be performed in the field.

**GRUNDFOS INTERNATIONAL A/S** P D Jensensvej 7, Bjerringbro, 8850, Denmark, Tel: +45-6-68-14-00, Telex: 60731 gfos dk, Fax: +45-6-68-44-72. Grundfos can supply a wide range of general water supply and booster pumps for both surface and groundwater based irrigation schemes.

**HASTINGS IRRIGATION PIPE INC** East Highway 6, Hastings, Nebraska, 68901, USA, Tel: +1-402-463-6633, Telex: 910-621-0808, Fax: +1-402-463-4355, Contact: John Rabbic. Manufacturers of welded seam aluminium irrigation pipes offering a complete line of irrigation pipe, fittings, pumps and irrigation systems. Also waste water systems.

**HAWS ELLIOTT LTD** Rawlings Rd, Smethwick, Warley, W Midlands, B67 5AB, UK, Tel: +44-21-420-2494, Fax: +44-21-429-1668, Contact: Mr Massey. Manufacture watering cans, spray heads, watering lances and pressure sprayers.

**HAYWARD TYLER LTD** 24 Crawley Green Rd, Luton, Beds, LU1 3LW, UK, Tel: +44-582-31144, Telex: 82158, Fax: +44-582-452198, Contact: Pat Clements. Borehole submersible pumps for water supply and irrigation.

**HIGH DUTY PLASTICS LTD** 94 Tallyho St, Rotorua, New Zealand, Tel: +64-73-482215, Fax: +64-73-462880. Manufacture chemical pumps used successfully in a wide range of applications - chemical plants, paper, copper and steel mills, tanneries, fish and fertiliser factories, dairies, sewage treatment plants, anodising plants and abattoirs.

**RICHARD HILL PUMPS LTD** Brooke Rd, Ridlington, Leicestershire, LE15 9AN, UK, Tel: +44-572-823385, Telex: 34694, Contact: Richard Hill. Manufacturers of self-priming centrifugal pumps close coupled to petrol and diesel engines and electric motors. Widely used for irrigation systems and general industrial applications.

**H R HOLFELD (PUMPS) LTD** 65 Carshalton Rd, Sutton, Surrey, SM1 4LH, UK, Tel: +44-1-661-0719, Telex: 28650, Fax: +44-1-642-0454, Contact: James Potter. Holfeld Pumps design and supply advanced pumping technology and the Holpak range of pump sets and pressure booster systems to specific customer require-

## SPECIAL PURPOSE PUMPS, PIPES AND OTHER EQUIPMENT

ments covering a wide range of applications including building services, irrigation, water and waste treatment and fire prevention.

**HOMA PUMPENFABRIK GmbH** Industriestr 1, Postfach 2020, Neunkirchen-Seelscheid 2, D-5206, West Germany, Tel: +49-2247-7020, Telex: 889448, Fax: +49-224770244. HOMA Pumps has been developing and producing submersible pumps for over 20 years. Its actual product range includes pumps for sewage and effluent treatment, drainage, irrigation, pumping chemicals, a full range of accessories and equipment.

**HUGALL & HOILE** 46 Flynn St, Wembley, WA, 6014, Australia, Tel: +61-9-3877677, Fax: +61-9-387-8554, Contact: Colin J Campbell. Wholesaler of irrigation and industrial pump & valve products. Retailer of domestic and rural irrigation products through network of six owned retail shops. Contractor designing/installing domestic & commercial irrigation systems.

**HYDROFLO CORPORATION** Plumsteadville, PA, 18949, USA, Tel: +1-215-766-7867, Fax: +1-215-766-8290, Contact: Mr Harry Black. Chemical injection pumps for irrigation systems. Also used in water and waste treatment systems.

**JLC PUMPS & ENGINEERING CO LTD** Oxgate Farm Works, Coles Green Rd, London, NW2 7EX, UK, Tel: +44-1-452-4081, Telex: 82317, Contact: Mr Catton. All types of pumps for all purposes.

**JOHNSTON IRRIGATION INC** Post Office Box 2076, Fort Pierce, FL, 34954, USA, Tel: +1-407-466-4500, Fax: +1-407-466-6081, Contact: Matthew M Johnston. Johnston Irrigation serves the US and the international marketplace with complete irrigation services including overhead and drip irrigation systems, wholesale materials, pump design, and consulting. Johnston Irrigation is one of the largest agricultural irrigation contracting companies in the United States.

**KROY INDUSTRIES** PO Box 309, York, NE, 68467, USA, Tel: +1-402-362-6651, Fax: +1-402-362-6566, Contact: Mr Marvin Gilstore. PVC tubing for irrigation from 3/4" to 16". Make 6", 8", 10" and 12" transmission PVC line for above ground. Also aluminium tubing from 2" to 12".

**KUBOTA LTD** 11-12 Hanover St, London, W1R 9HF, UK, Tel: +44-1-629-6471, Telex: 263235, Fax: +44-1-629-6915, Contact: Mr Takeshita. Manufacture a very wide range of pumps, valves, ductile iron piping, pvc piping and ancillary equipment. Design, construction and equipment for water supply, irrigation and pollution control systems in many countries.

**LaBOUR PUMP CO LTD (ALCORN DIVISION)** Denington Estate, Wellingborough, Northants, NN8 2QL, UK, Tel: +44-933-225080, Telex: 31428, Fax: +44-933-440032, Contact: Les Massey. The "Alcon" pump range comprises self-priming centrifugal, end suction and diaphragm pumps. Supplied mainly to the agricultural, horticultural, building contracting and civil engineering industries. Outputs range up to 4000 lit/min and heads to 55 metres.

**LASCO FITTINGS PHILIPS INDUSTRIES INC** 3255 E Miraloma Avenue, Anaheim, California, 92806, USA, Tel: +1-714-993-1220, Fax: +1-714-524-0232, Contact: Harold Hartman. Lasco Fittings, a division of a 'Fortune Manufacturing 500' firm, is a leading producer of schedule 40 and 80 PVC pressure pipe fittings, insert fittings and PVC-DWV fittings, as well as specialized swing joints, swivel joints and repair couplings for both large-scale and small-scale turf irrigation projects, proven in worldwide installations under every climatic condition.

**LAYNE-WESTERN CO INC** 721 West Illinois Avenue, Aurora, IL, 60506, USA, Tel: +1-312-897-6941. With 28 offices located throughout the US, Layne-Western Company is recognized as the leader in the field of water technology. Fully capable of providing practically every vital service needed by water users, municipal, industrial and agricultural. Services: complete hydrological engineering investigation, industrial and irrigation supply systems, drill and maintain water wells, install and service deep well pumping equipment, sell and install water and waste water treatment equipment.

**McDOWELL MANUFACTURING COMPANY** PO Box 665, Dubois, PA, 15801, USA, Tel: +1-814-371-6550, Fax: +1-814-371-7110, Contact: Steven Rowe. Manufacture a complete line of couplings and fittings for use with PVC pipes in IPS PIT and metric size fittings. They are epoxy coated steel for use in irrigation.

**MACHINEFABRIEK LANDUSTRIE BV** PO Box 199, A D Sneek, NL-8600, The Netherlands, Tel: +31-5150-11411, Telex: 46145, Fax: +31-5150-12398, Contact: Mr Bosner. Manufacturer and supplier of pumping stations for drainage, irrigation and sewage and sewage treatment stations.

**MASCHINENFABRIK ANDRITZ AG** POB 24, Statteggerstrasse 18, Graz-Andritz, A-8045, Austria, Tel: +43-316-602-0, Telex: 03-1313. Pumps and complete pumping stations for irrigation and drainage, industrial water supply plants, cooling water pumps for thermal power stations, sewage pumps and process pumps. All the pumps designs have been based on models subjected to detailed scrutiny of characteristics, efficiency and cavitation.

**MAZZEI INJECTOR CORP** 11101 Mt View Rd R5, Bakersfield, CA, 93307, USA, Tel: +1-805-845-2253, Fax: +1-805-845-3302, Contact: Bob Pettis. Mazzei Injector Corporation manufactures and distributes world-wide, a full line of high efficiency, trouble free Venturi-type differential pressure injectors. These injectors begin to create suction with as little as a 20% pressure differential. They are manufactured from polypropylene or PVDF-KYNAR, and come in all sizes from 1/2 inch to 2 inches

**MERRILL PUMPS AND ENGINEERING CO LTD** Chapel Works, Sheffield Rd, Sheepbridge, Chesterfield, Derbys, S41 9EH, UK, Tel: +44-246-450518, Fax: +44-246-455-552, Contact: Mr Crispin. Manufacturers of hand pumps for bore holes in the developing world. Also irrigation pumps.

# Oetiker Stainless 1-Ear Clamps for Water Service Lines



**Oetiker 1-Ear Clamps** are used primarily for low or normal pressure lines and have been successfully employed for years on black poly-pipe irrigation systems. They are economical and may be installed on location simply with a pair of pincers. *No more tedious or time consuming screw driving.*

A reinforcing "dimple", typical in Oetiker 1-Ear Clamps, builds a spring action into the clamp band. This allows the clamp to stay tight under variable pressure, surges or vibration.

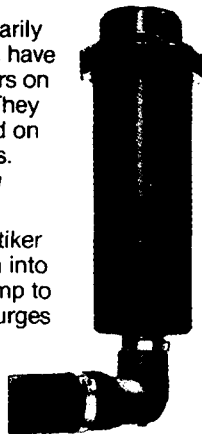

**Oetiker Stepless™ Ear Clamps** (Heavy-duty 908R series) are well suited to higher pressure applications such as irrigation pressure points, swimming pools, sprinkler and pump installations. They compliment our standard 1-Ear clamps.

The patented "Stepless™" design provides a 360° seal around the clamped surface.

Heavy-duty Stepless Clamps are made of 9 mm wide x 0.8 mm thick bandsteel while our standard 1-Ear Clamp is 7 mm wide x 0.6 mm thick bandsteel.

For additional information, please request an Oetiker catalogue today.



QUALITY ASSURED CLAMPS

Oetiker, Inc.  
P.O. Box 217  
3305 Wilson Street  
Marlette, MI 48453-0217 USA  
Telephone (517) 635-3621  
Telex 5 101 012 489  
Telefax (517) 635-2157

Hans Oetiker  
Metallw. & App.Fabr. GmbH  
Postfach 1220  
D-7833 Endigen 1 W-Germany  
Telefon (7642) 68 40  
Telex (17) 76 42 11  
Telefax (7642) 68 435

# JACUZZI®

## LINESHAFT AND SUBMERSIBLE TURBINE PUMPS

- Custom engineered to your specifications
- High quality manufacturing
- Settings up to 600' (183m) with standard construction **JACUZZI** lineshaft and submersible turbine pumps
- Vitreous enameled, close grain cast iron bowls
- 4" through 14" bowls
- Enclosed or semi-open bronze impellers
- Up to 3,800 gallons per minute (1,439 decaliters per minute)
- Water or oil lubricated
- Complete stock of parts and accessories including: motors; gear drives; and electrical controls
- Delivery without delay

### DISTRIBUTORS WANTED

TELEPHONE: 901-345-7204

TELEFAX: 901-345-3129

**JACUZZI®** *TURBINE PUMPS*

Manufactured by MID-SOUTH PUMP COMPANY

1555 THREE PLACE • MEMPHIS, TENNESSEE 38116 U.S.A.

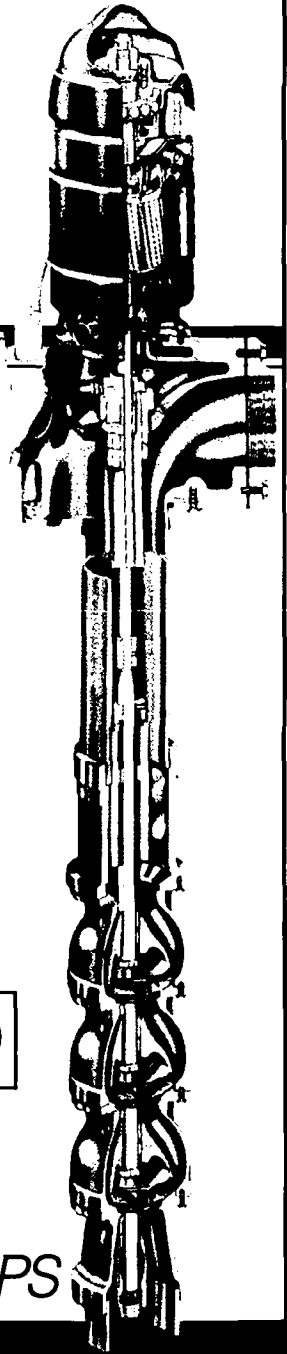

## SPECIAL PURPOSE PUMPS, PIPES AND OTHER EQUIPMENT

**MID-SOUTH PUMP CO** PO Box 16785, Memphis, TN, 38186, USA, Tel: +1-901-345-7204, Fax: +1-901-345-3129. Shipping: 1555 Three Place Memphis T N 38116 United States of America Manufactured with skill and pride for irrigation needs. Settings up to 600' with standard construction Jacuzzi and Delta lineshaft and submersible turbines. Vitreous enameled close grain cast iron bowls, enclosed or semi-open bronze impellers to 3800 GPM, water or oil lubricated. Completer one stop shopping-delivery without delay.

**F E MYERS CO** 400 Orange St, Ashland, Ohio, 44805-2285, USA, Tel: +1419-289-1144, Telex: 987443, Fax: +1419-289-6658, Contact: Mr Gary Lindekamt. Manufacturers of a complete range of pumps for all aspects of the water industry.

**NEW HADEN PUMPS LTD** New Haden Works, Cheadle, Stoke-on-Trent, Staffs, ST10 2NW, UK, Tel: +44-538-752351, Telex: 36142, Fax: +44-538-756569, Contact: Mr Bates. New Haden Pumps are leaders in the manufacture of systems for water supply, irrigation, sewage handling effluent treatment and sludge pumping. A complete service is available for any of the above.

**NIJHUIS PUMPS** PO Box 102, Parallelweg, De Winterswyl, 47102, The Netherlands, Tel: +31-5430-16561, Telex: 44185, Contact: Mr Jacobs. Involved in international business. Irrigation, water and sewage treatment, bio-protection and booster stations. Also produce surgical turbine pumps, mixed flow pumps, induction pumps and horizontal split case pumps.

**NIKEX HUNGARIAN FOREIGN TRADING CO** H-1016 Budapest 1, Mészáros v 48-54, Tel: +36-1-753128/560122, Telex: 22-6406, Fax: +36-1-755131 Nikex-H, Nikex is a foreign trading co established in 1948 and having approximately 600 employees, mostly engineers and economists. The Company represents approximately 1000 Hungarian firms in the foreign market and has connections to companies all over the world. Main fields of activity are: foundry, metallurgy, industrial fittings; rolling stocks; machines for the building and road construction industries; water engineering and environmental protection; mining equipment; building industry; agriculture/irrigation, transfer of agricultural technologies, etc; drilling of oil, water and geothermal wells.

**OCHSNER GESELLSCHAFT M b H & CO** P O BOX 60, Oberfeldstrasse 8, Linz, A-4024, Austria, Tel: +43-732-41-3-58, Telex: 02-1439 ochsnr a. For over 100 years Ochsner have produced pumps and compressors for the chemical, petrochemical and refining industries and for use in irrigation plants. The line-up includes water and waste water pumps (also pumps for the heavy industry) displaying the following characteristics: delivery up to 8,000 m<sup>3</sup>/h, lift up to 700m, drive capacity up to 1,500kW. Materials used are alloyed and unalloyed metals depending on operating conditions.

**PAIGE ELECTRIC CORP** PO Box 368, 1071 Hudson St, Union, New Jersey, 07083, USA, Tel: +1-201-687-7810, Telex: 138121, Fax: +1-201-687-2722, Contact: Mr Orlando Dirienzo. Design and supply cable for sub-

mersible pumps, agricultural irrigation and turf irrigation.

**PEERLESS PUMP LTD** Ferry Lane, Brentwood, Middlesex, TW8 0AL, UK, Tel: +44-1-560-3922, Contact: Pat Clemets. Borehole submersible pumps for water supply and irrigation.

**PERFECTION SPRINKLER CO** Box 1363, Ann Arbor, MI, 48106, USA, Tel: +1-313-761-5110, Fax: +1-313-761-8659, Contact: T R Wilkins. The continuous cleaning action of Perfection Sprinkler's self-cleaning strainers increase the time of pumping cycles and eliminates strainer maintenance. The self-cleaning strainers are available in sizes 3" to 10", with gallon ratings from 100GPM to 3000GPM. All models are adapted easily to existing suction lines.

**PERROT IRRIGATION LTD** 38 High St, Rowhedge, Colchester, Essex, CO5 7ET, UK, Tel: +44-206-867624, Telex: 987852, Fax: +44-206-869911, Contact: Mr Thornton. Manufacture and supply of irrigation equipment: sprinklers, mobile, stationary, quadrangle, horticultural, agricultural, dust suppression, pipes and fittings, pumps and hose reel irrigators, slurry irrigators.

**G C PILLINGER & CO (ENGINEERS) LTD** 30 Factory Lane, Croydon, Surrey, CR0 3RL, UK, Tel: +44-1-688-7445, Telex: 887463, Fax: +44-1-681-2887, Contact: Mr O'Rourke. Manufacture specialised pumping systems, ie booster sets, irrigation systems. Provide the complete package for all pumping needs.

**PIOGGIA CARNEVALI SpA** Strada S Cisa 47, Porto Mantovano, MN, 46047, Italy, Tel: +376-398151 2 3 4, Telex: 300541 PIOCAR, Fax: +376-390873. Pioggia Carnevali SpA is one of the largest and oldest manufacturers of irrigation equipment in Italy. The firm manufactures self-propelled hard hose irrigation systems offering 68 different models for all type and size of farms. These high quality irrigation systems are sold and promoted worldwide. Also manufactures: aluminium and galvanized steel pipe, couplings, fittings, large volume and low volume sprinklers, tractor and engine driven pumps of all sizes, and hand-primer-pumps.

**PIVOT PRODUCTS DISTRIBUTORS INC** P O Box 591, 15/16 West American Boulevard, Muleshoe, Texas, 79347, USA, Tel: +1-806-272-5536, Contact: Arnold Price. Manufacture DROPS and LEPA equipment for irrigation. Also drive line couplers and associated parts.

**PROTEK SPECIALTY CO** P O Box 446, Bellaire, TX, 77401, USA, Tel: +1-713-667-6691, Fax: +1-713-667-7867, Contact: W H Lane. Diaphragm pumps and primers for centrifugal pumps.

**PUMPING SERVICE (GB) LTD** Whitehouse St, Jack Lane, Hunslet, Leeds, LS10 1AD, UK, Tel: +44-532-446111, Telex: 557445, Fax: +44-532-465649, Contact: Mr Fox. Distributors for most of the leading British pump manufacturers. Around 2,000 pumps of various sizes and types in stock at any time, covering all applications.

**RAINBOW IRRIGATION SYSTEMS** PO Box 70, Fitz-

## SPECIAL PURPOSE PUMPS, PIPES AND OTHER EQUIPMENT

gerald, Georgia, 31750, USA, Tel: +1-912-423-4341, Telex: 80501, Fax: +1-912-423-4345, Contact: Dr Zee. Manufacture pumps, pipes, centre pivot, travellers, volume guns and all kinds of fittings. Also supply equipment for irrigation of waste water and land application.

**OY E SARLIN AB** Po Box 750, Helsinki 10, 00101, Finland, Tel: +358-0-535022, Telex: 121894, Fax: +358-0-5633989, Contact: Mr Saaremi. Sarlin is a manufacturer of submersible pumps for sewage systems, raw water intake, dewatering, irrigation and flood control. Pumps are easy to install and maintain.

**SIHI - HALBERG** Halbergstr 1, Ludwigshafen/Rh 1, 6700, West Germany, Tel: +49-621-56120, Telex: 4-64-833 halu d, Fax: +49-621-5612209. Pumping stations, pumps irrigation, water supply pumps and water work pumps.

**SNAP-TITE HOSE INC** 217 Titusville Rd, Union City, PA, 16438, USA, Tel: +1-814-438-7616, Telex: 4735-TLX-0914553-01, Fax: +1-814-438-7616, Contact: Alyn Holle. Snap-tite Hose Inc - A manufacturer of lightweight, layflat, synthetic hose products ranging in diameters from 1" through 8". Primary products include irrigation hose for soft hose traveler machines.

**SNEED-MCBRIDE INTERNATIONAL INC** Suite 501 8440 Walnut Hill Lane, Dallas, Texas, 75231, USA, Tel: +1-214-369-5710, Telex: 732645, Fax: +1-214-739-3551, Contact: Billie. SMI/Sneed-McBride International Inc, was among the first companies to introduce modern methods of irrigation world-wide. SMI equipment includes: SMI 360 center pivot, SMI drip and micro spray, SMI speedroll sprinkler, kelley pumps and SMI grain-potato-storage systems.

**SPRINKLINK** PO Box 45054, Garland, TX, 75045-0054, USA, Tel: +1-214-530-3631. Manufacture "Riserec" auto-return coupling for shrub risers.

**STA-RITE INDUSTRIES** 175 Wright St, Delazan, Wisconsin, 53115, USA, Tel: +1-414-728-5551, Telex: 4970245, Fax: +1-414-728-4461, Contact: Mr Bruce Lindhorst. Major suppliers of residential water systems and commercial irrigation type pumps to anywhere in the world. Branches in Australia, Canada, England, Germany and Japan.

**STUBENRUSS IRRIGATION SAS** V Castellano 4, Bressanone, BZ, I-39042, Italy, Tel: +39-472-35775, Telex: 400477, Fax: +39-472-34355.

**SULZER BROS (UK) PUMPS LTD** Manor Mill Lane, Leeds, LS11 8BR, UK, Tel: +44-532-701244, Telex: 55471, Fax: +44-532-772397, Contact: Mr Paley. Sulzer have supplied complete pumping packages for water supply, sewage and irrigation applications in developing countries throughout the world. Wide experience in engineering and financial packaging makes Sulzer a strong partner for your project.

**SULZER BROTHERS LIMITED** Pump Division, 8401 Winterthur, Switzerland, Tel: +41-52-81-11-22, Telex: 896-060-40, Fax: +41-52-23-42-83. Over many years, Sulzer has established an extensive manufacturing

pump programme for liquid transport application. Currently, this programme includes pumps for large flows of water over long distances with high heads, drinking water supply pumps, irrigation and drainage pumps and effluent transport pumps.

**TEFEN PLASTIC PRODUCTS MFG** Nahsholim, 30815, Israel, Tel: +972-6-390782/396711, Fax: +972-6-390813. Manufacturers of plastic fittings and tubes for irrigation and pneumatics.

**TFS SYSTEMS** 8733 Magnolia #100, Santee, CA, 92071, USA, Tel: +1-619-449-6408, Fax: +1-619-449-2368, Contact: Marilyn Strong. TFS Systems is the leading manufacturer of automatic fertilizer injectors, including the award-winning 'ADD-IT' injector which is available in 8 sizes ranging from 1 pint up to 10 gallons and the PRO-jector proportioning injector, available in quart, gallon and 5 gallon sizes.

**THOMPSONS KELLY & LEWIS LIMITED** PO Box 160, Springvale, Victoria, 3171, Australia, Tel: +61-3-562-0744, Fax: +61-3-562-0885, Contact: Ruedi Birmele. Thompsons, Kelly & Lewis is Australia's leading manufacturer and supplier of end suction centrifugal pumps. The KL-ISO and HYDRO-TITAN are back pull-out pumps with the KL-ISO COMPACT a close-coupled version using a standard electric motor. These pumps are ideal for all rural applications including irrigation. Flow Rates to 250 L/s and heads to 150 m.

**TORRENT PUMP INDUSTRIES** P O Box 51066, Kitisia, GR-145 10, Greece, Tel: +30-1-81617128161702, Telex: 215870, Fax: +30-1-8161018. Special purpose pumps and accessories.

**US EXPORT & TRADING CO** 848 Harding St, Escondido, California, 92027, USA, Tel: +1-619-743-8211, Telex: RCA294277/ITT4994245, Fax: +1-619-745-1314, Contact: L L Forehand. Specialists in landscape irrigation design. Manufacturers of irrigation products (sprinklers, pipes, fittings and valves), ultra-violet resistant PVC pipe.

**J M VOITH AG** P O BOX 168, St Pöulten, A-3100, Austria, Tel: +43-27-42-25-01, Telex: 015510. For decades J M Voith have turned out pumps for irrigation, drainage and drinking water supply purposes and cooling water pumps for nuclear and thermal power plants.

**VOPO POMPEN- & MACHINEFABRIEK BV** De Volger 2, De Rijp, NL, 1483 GA, The Netherlands, Tel: +31-2997-1312, Fax: +31-2997-3358. Surface water pumps, built for continuous operation, maintenance free. Large capacity for low heads. Widely used for drainage and irrigation jobs. Capacity 40 - 1000 M<sup>3</sup>/hour.

**J T WADE & SON LTD** West Wycombe Rd, High Wycombe, Bucks, HP11 2LJ, UK, Tel: +44-494-450133, Telex: 837935, Fax: +44-494-465640, Contact: Mr Harvey. Manufacturers of a large range of pumping sets for agriculture, brewing, chilled water, hospitals, domestic water supply and water booster installations, fire booster sets, shower pumps plus many general applications.





•Mechanical &  
Electrical Equipment•

# ENERGY EFFICIENT PUMPING AND PUMP SYSTEMS

by  
Maurice A. Yates

Even if a pump is running smoothly, without breaking down, it may still have unnecessarily high operating costs, due to wastage of energy. This article looks at the causes of these losses and ways to reduce them.

These are assessed under the following headlines.

- a) Pump selection and system operation
- b) Operation efficiency of pumps
- c) Total life costing of pumping plant
- d) Motor/drive performance

Figure 1: The effect of changes in the System Characteristic or the Pump Characteristic

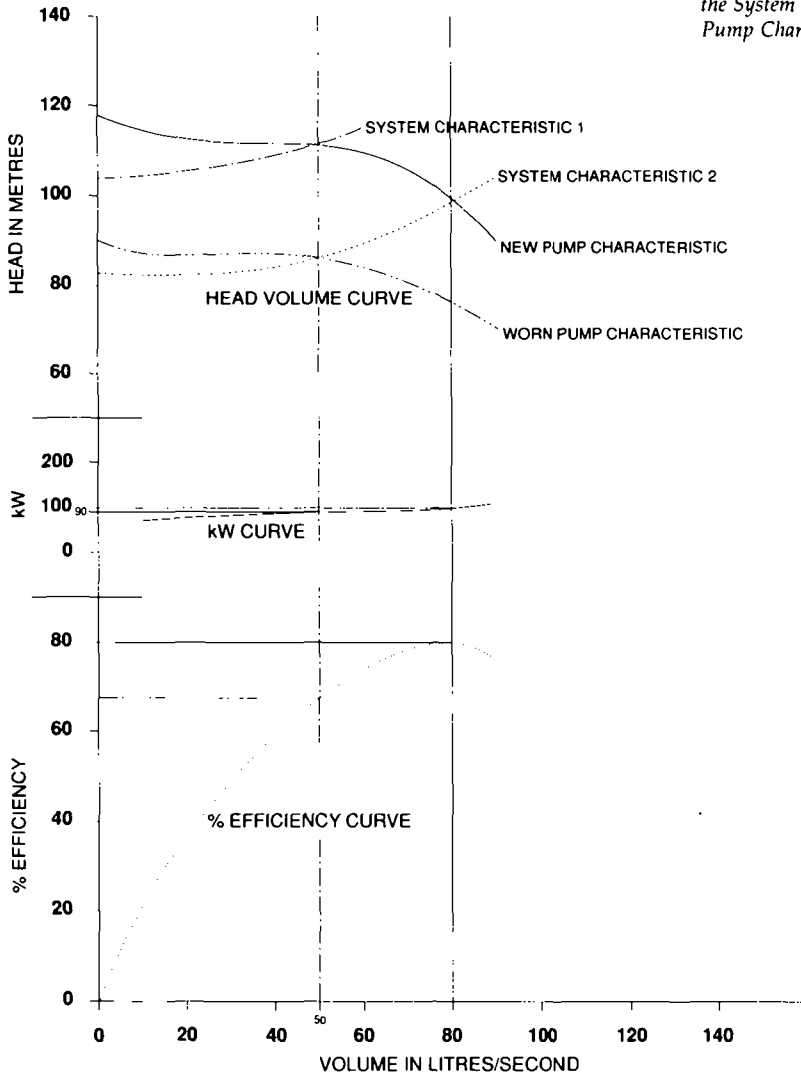

# ENERGY EFFICIENT PUMPING

## a) Pump Selection and System Operation

When purchasing pumps on the precise system requirement is an essential criterion. For instance, in Figure 1, consider a pump with a requirement of 5,000m<sup>3</sup>/day. If the pump is operating at Point A, then the pump will deliver 80 l/s and draw 100 kW of electrical power from the supply.

In this operation the pump will consume; hours run/day x kW (from kW curve)

$$\frac{5,000}{80} \times 1,000 \text{ hrs} \times 100 \text{ kW} = 1,736 \text{ kW hrs per day}$$

This is an increase in consumption of 44%.

A similar effect is seen when the pump changes, for instance because of pump wear. It is, therefore, essential for efficient pump running that the pump is operating at the correct point on its operating curve.

## b) Operating Efficiency of Pumps

The measurement of pump efficiency on site has always been difficult. However, with the advent of new instruments, for example the Yatesmeter, this difficulty has been removed and pump efficiency can now be measured

Figure 2: The Yatesmeter for measuring pump efficiency

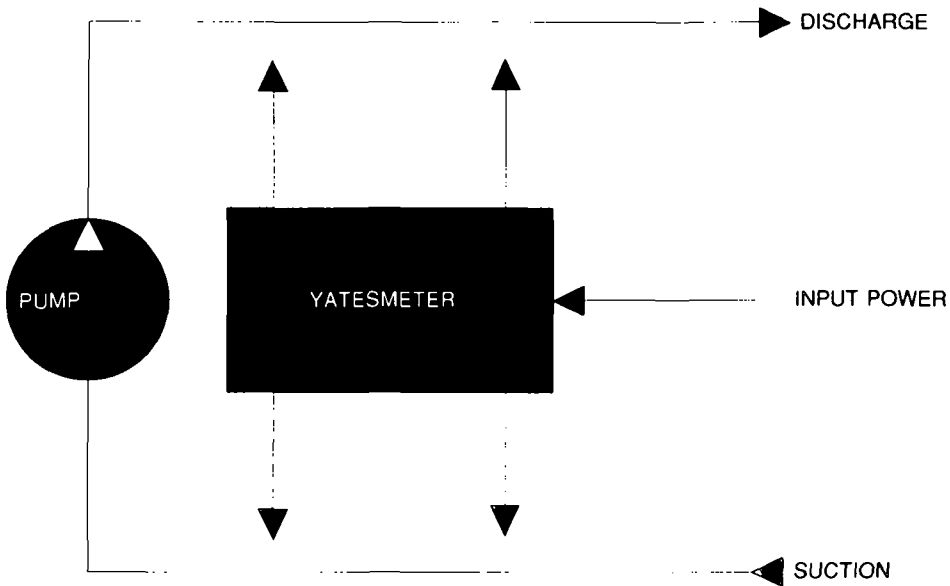

simply and accurately in real time without disturbing the pump's operation.

The Yatesmeter is connected directly across the pump and has four sensors to measure the suction and discharge conditions of the pump. They are used to determine the efficiency of the pump. The input power to the motor is also measured and using this information along with the pump efficiency the flow through the pump is calculated. The Yatesmeter can also be used for determining the motor efficiency.

## c) Total Life Costing of Pumping Plant

When considering the total life cycle costs of pumping, the energy consumed by the pump during its life is the major factor. The purchase price is normally considerably less than the running costs.

For instance:

$$\begin{array}{rcccc} \text{Purchase Price} & + & \text{Maintenance} & + & \text{Running Cost} & = & \text{Total Cost} \\ 5\% & & 10\% & & 85\% & = & 100\% \end{array}$$

Therefore, any improvement in the efficient running of a pump is immediately seen in its total costings.

## d) Motor/Drive Performance

Other factors influencing the overall efficiency of pumping plants are the drive motors and control equipment. When considering the pump drive the performance of the motor is critical, it must provide the following:

1. Adequate starting torque throughout the acceleration of the pump, even during periods of low voltage.
2. Sufficient power to operate the pump at its maximum point of power.
3. The correct speed for the pump operating curve. The efficiency of the motor is also an important point. The new

# Do you need low-cost electricity?

V/O ENERGOMACHEXPORT offers a variety of  
HYDROELECTRIC POWER PLANT:

- \* hydroelectric units with vertical Francis, Kaplan or Pelton turbines, diagonal or propeller-type turbines
- \* horizontal units for pumped storage power electric stations
- \* separate hydraulic turbines of any design and power

V/O ENERGOMACHEXPORT supplies hydro-mechanical and auxiliary equipment for hydro-power plants, spare parts and units; renders engineering and consulting services – at Customer's option.

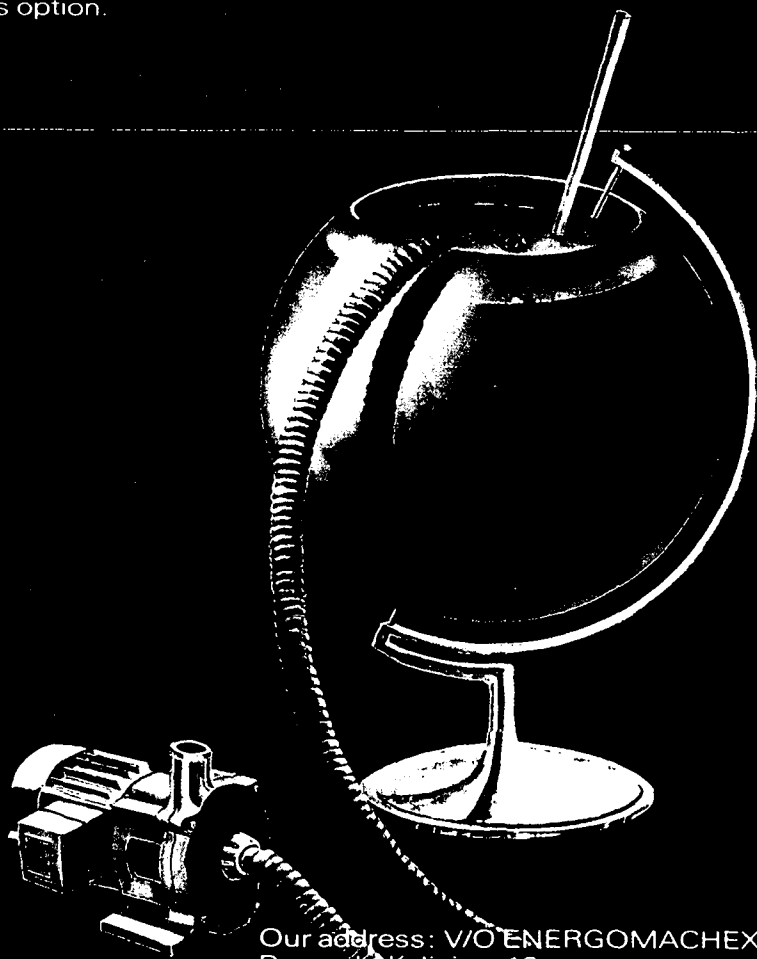

Our address: V/O ENERGOMACHEXPORT  
Prospekt Kalinina, 19  
121019, Moscow, USSR  
Tel. 203-15-71  
Telex. 411965 ENEK SU

# ENERGY EFFICIENT PUMPING

type high efficiency motors are usually worthwhile in the UK if a pump is running for more than eight hours a day. Also, it must be remembered that a standard motor has poor efficiencies below 70% of full load.

### Variable Speed

Pump systems which have a low static head and a high friction loss benefit from variable speed drives, particularly when low-priced electricity may be available at certain times during the day. Consider a variable speed pump having a combined motor/pump efficiency of 70% required to pump 270m<sup>3</sup>/hr.

At speed (1) the pump will consume:

$$\frac{g \times Q \times H \times \text{pump running}}{\text{efficiency}}$$

$$\frac{9.81 \times 0.1 \times 89 \times 0.75}{0.7} = 93.54 \text{ kWhrs/hr}$$

At speed (2) the pump will consume:

$$\frac{9.81 \times 0.075 \times 50 \times 1}{0.7} = 52.55 \text{ kWhrs/hr}$$

At speed (1) the pump will only run 75% of the time but it will consume 93.54 kWhrs/hr; this is 78% more than if the pump were to operate at speed (2) when it will run 100% of the time but only consume 52.55 kWhrs/hr.

### Conclusions

To summarize:

- 1) Pumps are very expensive to run.
- 2) Savings may be made by:
  - i) Carrying out a system survey;
  - ii) Checking pump efficiency;
  - iii) Using a high efficiency motor;
  - iv) Using selective variable speed.

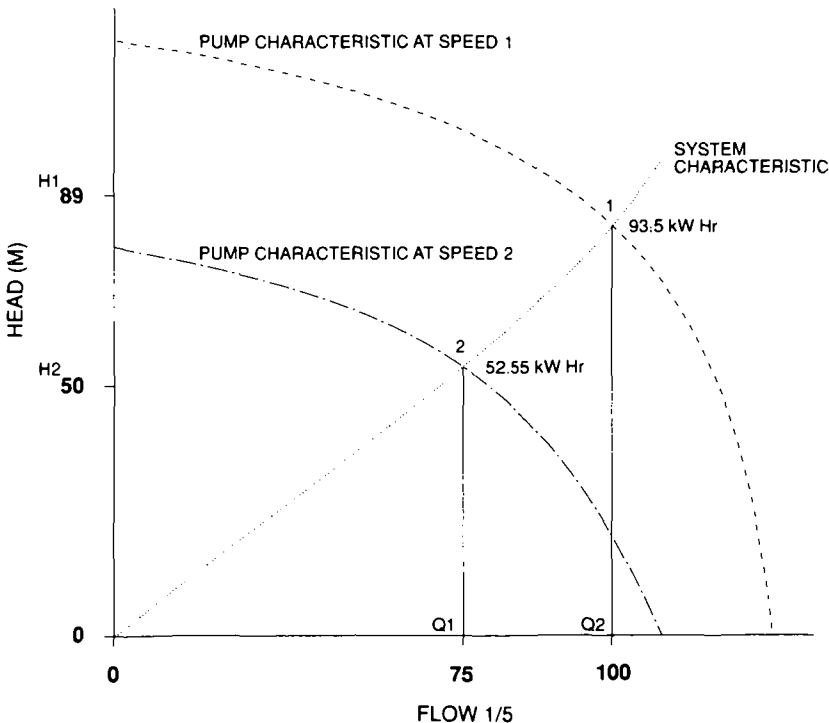
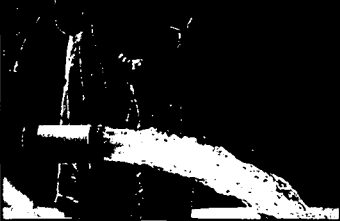
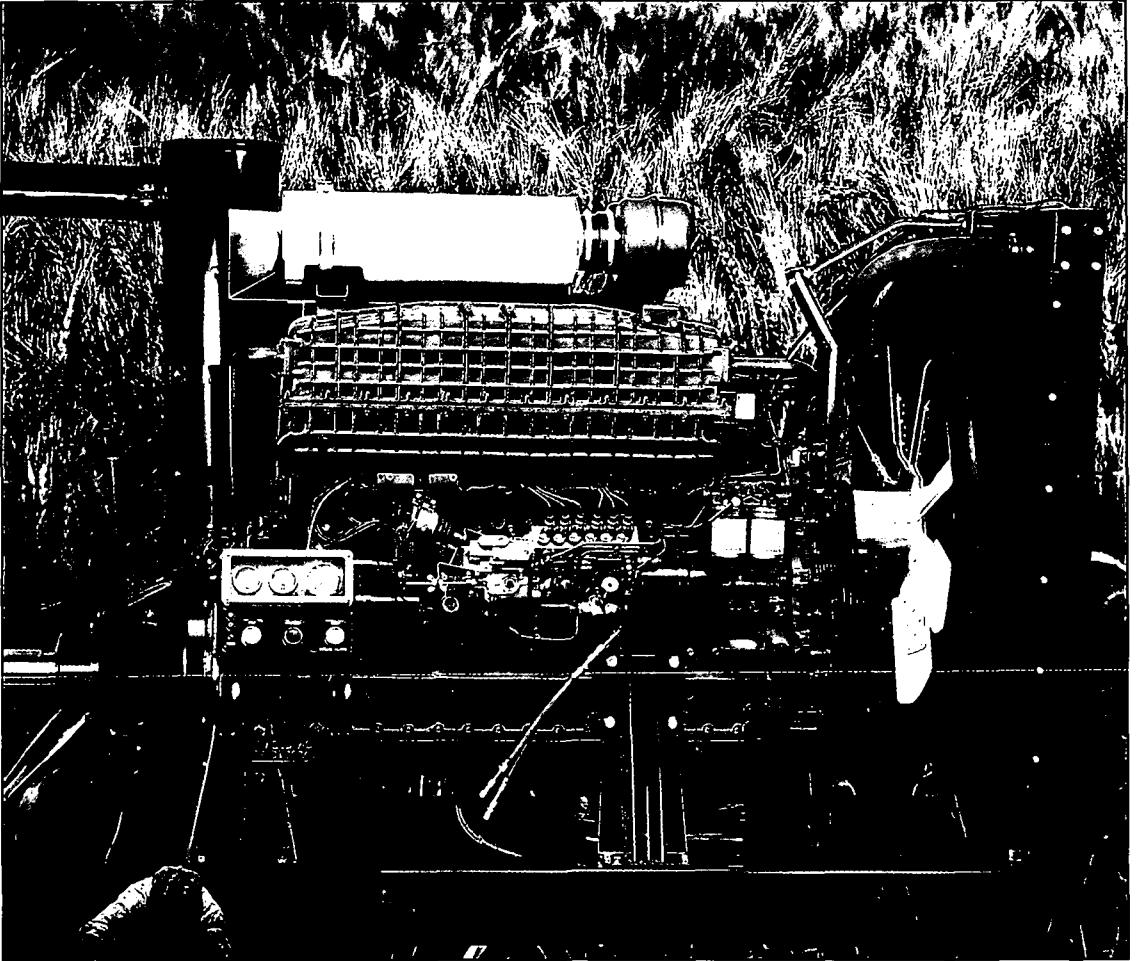

Figure 3: Example of a Variable Speed Pump

Being an independent company in the Volvo Group, Volvo Penta develops engines, transmissions and services for a wide spectrum of industrial and marine applications  
AB Volvo Penta, S-405 08 Goteborg, Sweden



## Easier service, longer life. When reliability really matters.

Volvo Penta's in-line six turbodiesels for stationary applications are from their conception designed to operate continuously in the world's most demanding environments. Sturdy and proven units, incorporating the latest state-of-the-art computer design technologies geared to strengthen reliability, enhance durability and improve end user economy.

Whatever the use, Volvo Penta engines are backed by a dedicated after sales organisation, ready to handle both regular maintenance and full engine overhauls if required. Thus downtime is kept to a minimum, ensuring continued end user satisfaction.

*Power Range:* 48 - 330 kW (65 - 449 hp), according to ISO 3046. All engines available in two versions: as base engines or as complete Power Packs, ready mounted on a base frame with radiator, instrument panel etc.

**VOLVO  
PENTA**

## Cranes, Lifting and Hydromechanical Equipment

**GRESSBACH WINDEN - UND MASCHINENBAU GmbH** P O Box 6, Obernburg, D-8753, West Germany, Tel: +49-6022-3-10-47, Telex: 4-188-132 gres d, Fax: +49-6022-3-10-50. Gressbach Winden - und Maschinenbau GmbH was founded in 1816. Manufacturing and marketing of WIMAG equipment- lifting gear and construction equipment, especially for underground engineering, pipe handling equipment, cranes and special constructions.

**JLG INDUSTRIES INC** JLG Drive, McConnellsburg, PA, 17233, USA, Tel: +1-717-485-5161, Fax: +1-717-485-6417. Complete range of self-propelled aerial work platforms in telescoping, articulating and scissors models - from 7.62m to 33.5m platform heights. Capacities from 230kg to 908kg. Complete range of truck mounted boom cranes (loaders) from 6 to 17 tons (US). Manufacturing and production facilities in USA, UK and Australia.

**MANITEX INC** 4300 Acapulco Avenue, McAllen, Texas, 78503, USA, Tel: +1-512-630-2690, Fax: +1-512-630-2695, Contact: Tony Simmons. Manitex is a wholly owned subsidiary of the Manitowoc Company. Manitex designs and builds a wide range of crane products including overhead travelling and Gantry or Goliath cranes, pedestal mounted box, telescopic and lattice boom hydraulic cranes and a line of telescopic hydraulic cranes for installation on a commercial truck chassis.

**METALNA Machine Builders, Steel Fabricators and Erectors** Zagrobska 20, G2001 Maribor, Yugoslavia, POB 200 Tel: +3862412511/411272,413272, Telex: +33115 Yumotmb, Fax: +412030.

**NATIONAL ENGINEERING LABORATORY** East Kilbride, Glasgow, G75 0QH UK Tel: +0355220222, Telex: +777888, Fax: +0355236930. The National Engineering Laboratory (NEL) is an international centre for testing and approval of water turbines.

**RANSOMES & RAPIER PLC** P O Box No 1, Waterside Works, Ipswich, Suffolk, IP2 8HL, UK, Tel: +44-473-690383, Telex: 98176. Dragline excavators and crawler cranes for work on dam, barrage and irrigation, canal construction worldwide.

**TUBAFOR INTERNATIONAL** 39 Champs Elysees, Paris, 75008, France, Tel: +33-1-42-25-9342/20-26-2432, Telex: +280888/160620. Hydrometric equipment - level and/or temperature indicators, water level and/or temperature recorders and solid state memory.

## Diesel, Petrol and Natural Gas Engines

**APPLIED ENERGY SYSTEMS** 1 Whippendell Rd,

Watford, Herts, WD1 7LZ, UK, Tel: +44-923-242222, Telex: 935926, Fax: +44-923-30402, Contact: Barbara Hamilton. Specific design and manufacture of combined heat and power up to 3000 kWe and prime, standby and emergency packages for power generation up to 5000 kWe. This quality background has led to the development of the leading range of small scale combined heat and power systems called Mini-Chips which are being adopted more widely for new and existing leisure centres, hospitals, hotels, sheltered housing, residential property such as blocks of flats and estates, water treatment works and industrial processes.

**DAWSON-KEITH LTD** DeeKay House, Brockhampton Lane, Havant, Hants, PO9 1QH, UK, Tel: +44-705-474122, Telex: 86491, Fax: +44-705-470921, Contact: Barbara Braby. Manufacturers of diesel and gas engine generator sets, containerised power packages, mains failure and synchronising panels, mobile standby sets, power range from 4 to 14 megawatts. A worldwide after sales service available as are maintenance contracts.

**JOHN DEERE** 400 Nineteenth St, Moline, Illinois, 61265, USA, Tel: +1-309-765-3057, Telex: 468-427, Fax: +1-309-765-3051, Contact: Dick Sellen. Diesel engines (20 models, 58-315 SAE net horsepower, 3-, 4- and 6-cylinder versions) for stationary power unit and OEM applications. Also used in John Deere tractors, harvesters, earthmoving and construction equipment.

**DETROIT DIESEL CORPORATION** 13400 Outer Drive, West Detroit, MI, 48239-4001, USA, Tel: +1-313-592-3753, Fax: +1-313-592-7288, Contact: Charles P Yount. Detroit Diesel Corporation manufactures and distributes quality diesel engines to fill power requirements from 5 to 2200 horsepower. We have the right engines to meet your power needs.

**DORMAN DIESELS LTD** Tixall Rd, Stafford, ST16 3UB, UK, Tel: +44-785-223141, Telex: 36156, Fax: +44-785-215110, Contact: Mr Lusby. Manufacturers of diesel and gas engines air and water cooled range: diesel 16 BKW - 1880 BKW and gas 16 BKW - 660 BKW. For power generation, pumping duties and marine applications.

**KHD GREAT BRITAIN LTD** Riverside Rd, London, SW17 0UT, UK, Tel: +44-1-946-9161, Telex: 8954136, Fax: +44-1-947-6380, Contact: Mr Jarvis. Manufacturers and suppliers of a complete range of air and water cooled diesel engines for auto motive, industrial and marine applications. Outputs from 3 to 3250 kW.

**LINCOLN DIESELS PLC** Great Northern Terrace, Lincoln, LN5 8HJ, UK, Tel: +44-522-511512, Telex: 56430 LINDSL, Fax: +44-522-512935, Contact: Malcolm Mitchell. Largest independent supplier of medium & high speed diesel engine spare parts in UK. Over 1m. of diesel engine spare parts carried ex stock for UK and worldwide despatched. Spare parts for Ruston, English Electric, Whallen, Mirlees Blackstone(Stamford), Paxman, Lister-Peters and Cummins etc, & Napier Turbocharger etc. Qualified diesel engineers.

**LISTER-PETTER LTD** Long St, Dursley, Glos, GL11

# Since 1920 Supplier of Water

## Control Equipment

Our long-standing experience in designing, manufacturing and technology allow us to provide water control equipment of the highest quality at competitive price. If you are confronted with problems dealing with water, refer to us, we are ready to respond to your requirements. Proven technology and experience can be your high quality and low cost source for hydromechanical equipment, penstocks and cranes.

We produce:

### Equipment for dams:

- spillway gates
- hydraulic and mechanical hoists
- stoplogs
- gantry cranes
- water level measuring equipment
- remote controls for gate operation
- water flow measuring equipment

### Penstocks and linings:

- high pressure steel penstocks
- distributors (bifurcations, trifurcations)
- expansion joints
- fixed-dispersion cone valves
- power tunnel linings
- model tests

### Equipment for power plants:

- intake trashracks
- intake trashrack rakes
- bulkhead gates
- service gates of sliding, roller, or radial type
- stoplogs
- gate hoists:
  - hydraulically operated
  - mechanically operated
- stoplog handling cranes
- water level measuring equipment

**metalna** Machine Builders, Steel Fabricators and Erectors

Zagrebska 20  
62001 Maribor, YUGOSLAVIA  
POB 200  
Phone: +3862/412-511, 411-272  
413-272  
Cables: metalna maribor  
Telex: 33115 Yu metmb  
Fax: +3862/412-030

REPRESENTATIVE OFFICE IN NEW YORK:

INGRA Inc.  
225W 34 Str. Room 2017  
New York, USA  
Phone: (212) 564-7297  
564-7298  
Telex: (RCA) 249327



# Metalna on all Continents

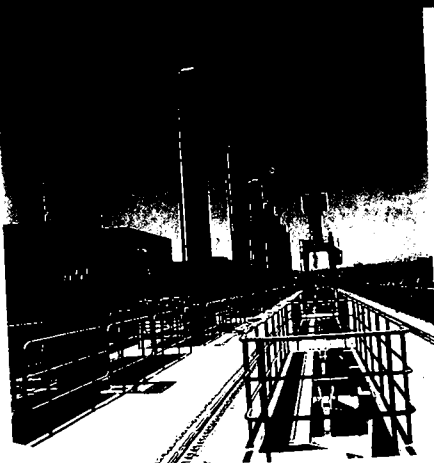
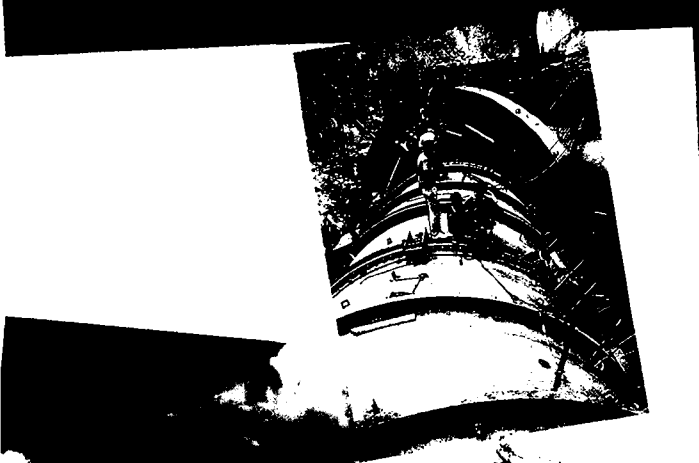
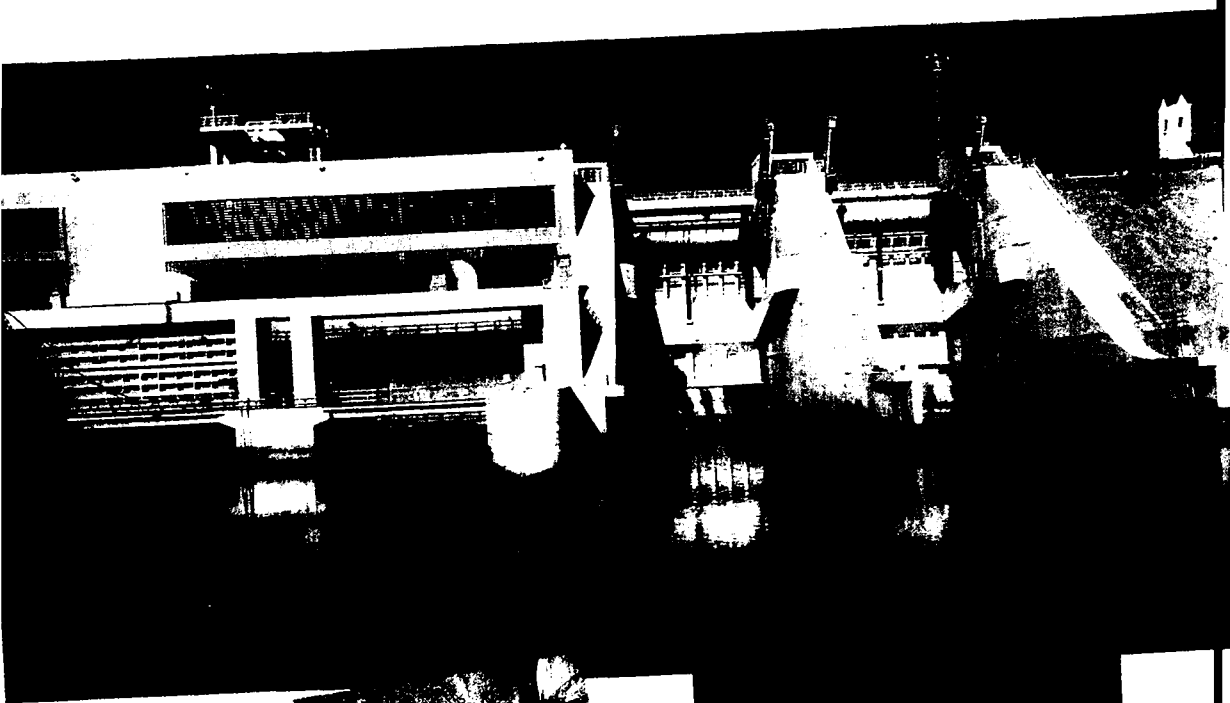

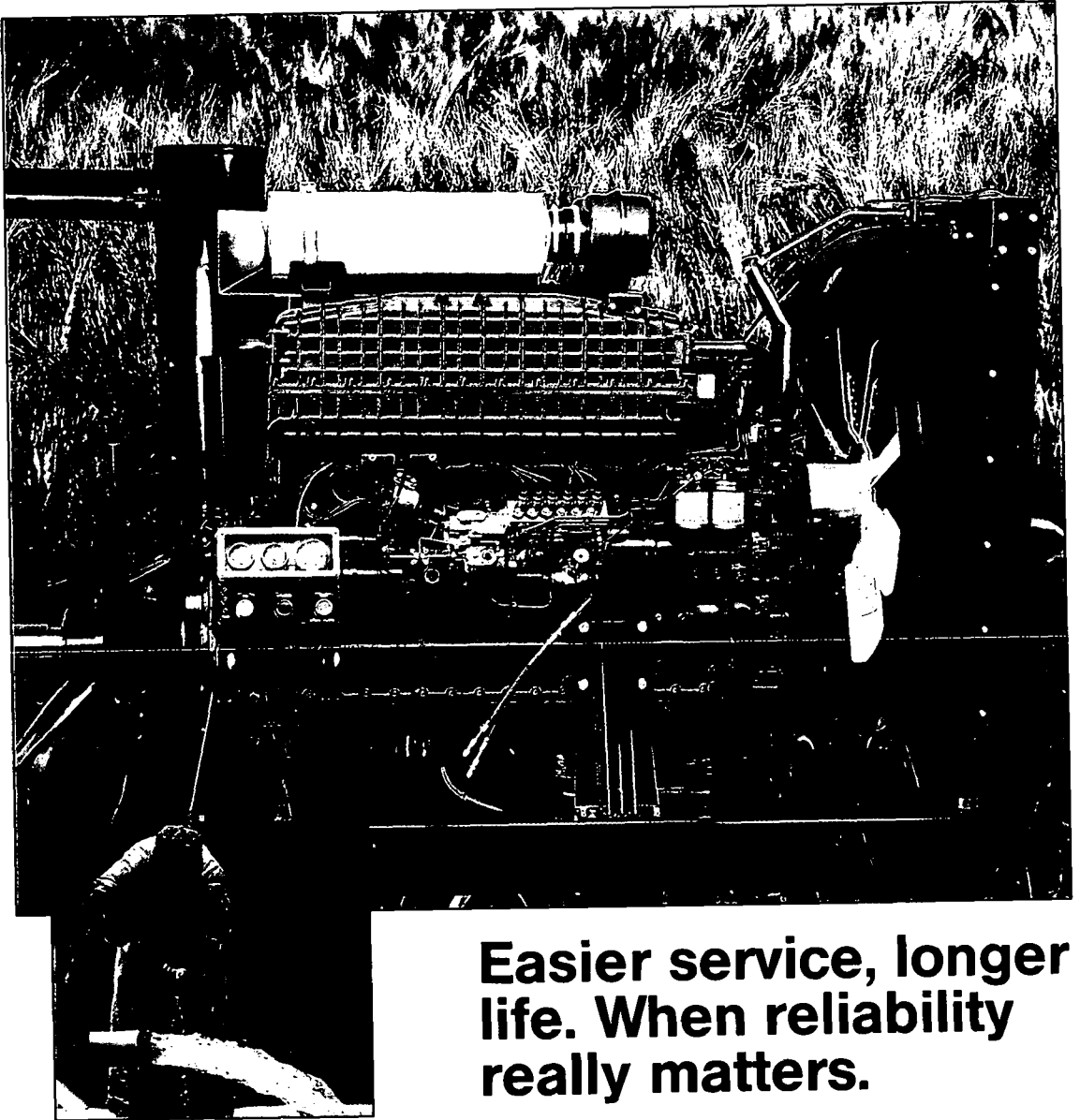

## Easier service, longer life. When reliability really matters.

Volvo Penta's in-line six turbodiesels for stationary applications are from their conception designed to operate continuously in the world's most demanding environments. Sturdy and proven units, incorporating the latest state-of-the-art computer design technologies geared to strengthen reliability, enhance durability and improve end user economy.

Whatever the use, Volvo Penta engines are backed by a dedicated after sales organisation, ready to handle both regular maintenance and full engine overhauls if required. Thus downtime is kept to a minimum, ensuring continued end user satisfaction.

*Power Range: 48 - 330 kW (65 - 449 hp), according to ISO 3046. All engines available in two versions: as base engines or as complete Power Packs, ready mounted on a base frame with radiator, instrument panel etc.*

**VOLVO  
PENTA**



HATZ – the power behind  
agriculture for over 80 years

# The power **HATZ** behind DIESEL water



Worldwide millions of HATZ engines  
are at work. From arctic  
temperatures to the scorching heat  
of deserts and to the intense  
humidity of jungles. With back-up in  
the field that you can count on.



HATZ Diesel Engines  
range from 1 to 80 HP  
with a high  
reputation for durability,  
reliability and cost  
saving economic use.

West German  
engineering quality  
guarantees  
quality of water.  
Quality one  
can depend on.



**MOTORENFABRIK HATZ GmbH & Co. KG**  
D-8399 Ruhstorf a.d. Rott  
Rep. of West Germany  
Tel: 08531-3191 Fax: 08531-32716  
Telex: 57260

## DIESEL, PETROL AND NATURAL GAS ENGINES

---

4HS, UK, Tel: +44-453-4141, Telex: 43261 LPLTD-G, Fax: +44-453-46732, Contact: Mr Sellwood. Manufacturers and suppliers of air and water cooled diesel engines from compact single cylinder models up to turbo-charged 6-cylinder versions producing continuous power outputs from 1.1 to 224kw (1.5 to 300 brake horsepower).

**MOTORENFABRIK HATZ** Ernst-Hatz-Strabe 16, D-8399 Ruhstorf/Rott, PO Box 1162, Federal Republic of Germany Tel: +085313191, Telex: +57260, Fax: +0853132716. Motorenfabrik Hatz GmbH & Co.KG is one of the biggest European manufacturer's of aircooled Diesel engines in the output range of 3-80 hp. The engines are suitable for applications such as agricultural machines, driving water pumps, generating sets or construction equipment. Hatz is represented in over 100 countries of the world and has considerable know-how in the application of Diesel engines under the most difficult and arduous conditions.

**RUSTON DIESELS LTD** Vulcan Works, Newton-Le-Willows, Merseyside, WA12 8RU, UK, Tel: +44-925-225151, Fax: +44-925-222055, Contact: R B Williamson. Medium speed diesel, spark ignited gas and dual fuel engines within the power range of 715 to 7000 BHP (500 to 4400kw). Designed for continuous operation in arduous conditions the engines are ideally suited to base load power generation. Emergency stand-by with automatic mains failure facilities.

**SAAB-SCANIA AB** Södertülje, S-15187, Sweden, Tel: +46-755-81000, Telex: 10200 Scania S, Fax: +46-755-95559, Contact: Mr B O Jarnsjö. Most Scania diesel engines destined for industrial applications are used in construction equipment, farming tractors, forest machinery, generating sets and power packs for water irrigation. As regards water irrigation, customers in Saudi Arabia have ordered around 6,800 Scania power units since the early 1980s. Scania is one of the world's leading manufacturers of heavy trucks in the 16 tonne gross vehicle weight class and upwards.

**VOLVO PENTA** S-40508, Goteborg, Sweden, Tel: +46-31235460, Telex: 20755 S, Fax: +46-31510595. Volvo Penta is an industrial company which has advanced technology, high quality and a high level of product specialization as its principal competitive assets. Volvo Penta designs, manufactures and markets engines for marine and industrial use. Volvo Penta engines are used in a wide range of industrial applications. Over 30,000 engines 50-350KW are installed for irrigation pump drive the world over.

### Electrical Motors, Starters, Controls, Transformers, Switch- gear, Alternators and Generators

**BANCHORY INVESTMENTS LTD** North Deeside Rd Banchory Kincardineshire AB3 3YR U K Tel: 44-3302-2667, Fax: 44-3302-3573, Contact: Sue Stevens. Condition monitoring equipment for power generation equipment.

**BEVI WRIGHT LTD** Pellon Lane, Halifax, W Yorks, HX1 5QL, UK, Tel: +44-422-60201, Telex: 51101, Fax: +44-422-51092, Contact: Mr P J Franke. Comprehensive range of standard and special AC motors, both single and three-phase in sizes from 0.1 to 160kw.

**BRIMOTOR LTD** Clarence Works, 30a Church Rd, Tunbridge Wells, Kent, TN1 1JP, UK, Tel: +44-892-37588, Telex: 95446 BIMOTR G, Contact: Mr Mossery. Manufacturers of portable, mobile and mains failure generating sets, and portable mobile floodlighting units. Manufacturers of self-priming and diaphragm pumps.

**BRUSH ELECTRICAL MACHINES LTD** P O Box 18, Loughborough, Leics, LE11 1HJ, UK, Tel: +44-509-611511, Telex: 341091, Fax: +44-509-610440, Contact: Mr Wells. Generators for diesel and turbine drive motors and variable speed drives. Dedicated microprocessor systems. Generator control equipment.

**BRUSH TRANSFORMERS LTD** P O Box 20, Loughborough, Leics, LE11 1HN, UK, Tel: +44-509-611511, Telex: 341094, Fax: +44-509-610550, Contact: Mr Wells. Manufacturers of distribution and power transformers, flame-proof transformers and switchgear, transformers for highly specialised applications.

**CATERPILLAR DO BRAZIL SA** Av Nacoes, Unidas 22-540, Sao Davlo sp, 04795, Brazil, Tel: +55-11-2464880, Contact: Alice Pab. Manufacture, assembly, importation and exportation of tractors and construction machinery, marine engines, generators, winches and related parts and equipment for the following markets: agriculture, earthmoving, road construction, industrial machinery and mining.

**CORTINA ELECTRIC CO LTD** Olds Approach, Tolpits Lane, Watford, Herts, WD3 8XL, UK, Tel: +44-923-775235, Fax: +44-923-771029, Contact: Mr Flynn. Design, manufacture and supply variable frequency inverter drives, DC converter drives, kramer slip energy recovery drives and composite pump control centres built to customers' specification.

**DAWSON-KEITH LTD** DeeKay House, Brockhampton Lane, Havant, Hants, PO9 1QH, UK, Tel: +44-705-474122, Telex: 86491, Fax: +44-705-470921, Contact: Barbara Braby. Manufacturers of diesel and gas engine generator sets, containerised power packages, mains failure and synchronising panels, mobile standby sets, power range from 4 to 14 megawatts. A worldwide after sales service available as are maintenance contracts.

**DEPENDABLE TURBINES LTD** 7-3005 Murray St, Port Moody, BC, V3H 1X3, Canada, Tel: +1-604-461-3121, Fax: +1-604-461-2314, Contact: Robert Prior. Manufacturers of a complete range of governors, generators and turbines.

**WILLIAM DON LTD** Low Lane, Horsforth, Leeds, LS18 5NY, UK, Tel: +44-532-584286, Telex: 55417, Fax: +44-532-390056, Contact: Mr Nigel Riding. Manufacturers of fixed and variable speed AC/DC motor control system. General motor control system and automation aids. Turnkey programmable control system.

## GENERATING SETS 2 KVA-2000 KVA

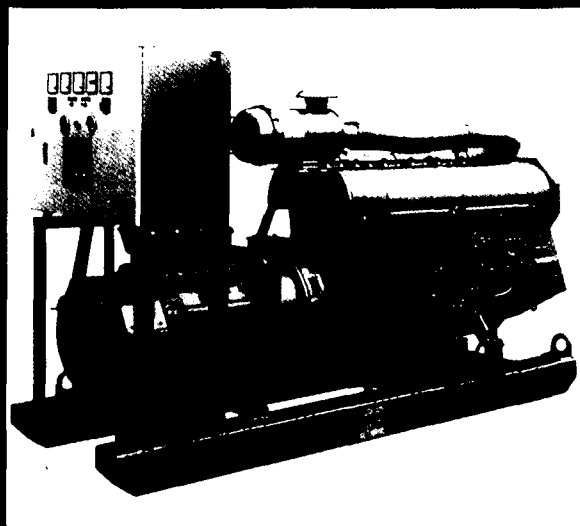

Engineered to exacting standards to provide a highly dependable, but economic source of electrical power, units are available as 1 or 3 phase, 50-60-400 HZ to suit all world voltages. Equipment may be drawn from an extensive 'standard' product range, which includes advanced environmentally protected machines, specifically designed to operate centre pivot and linear move irrigators, or custom built to suit individual technical or operational requirements.

Applications cover automatic standby and base load duties, including mini power stations featuring single sets or multiple set automatic duty cycling or synchronised installations, static or mobile configurations, with weatherproof and/or soundproof enclosures.

Machines housed in specially adapted ISO containers provide readily transportable, self-contained packages, ensuring availability of on site power in the shortest possible times.

A range of high efficiency combined heat and power systems (CHP's) are becoming increasingly popular with Municipalities and other organisations requiring substantial electrical loads and large heat requirements.

## DIESEL POWER PACKS 20 HP-1300 HP

Rugged, high quality units, providing reliable independent power at the centre of any project involving irrigation, drilling, drainage and many other applications.

Manufactured in self-contained, ready to run form, these machines incorporate starter batteries, fuel tanks, exhaust systems, various forms of heavy duty PTO clutches, heavy duty filters, automatic safety equipment and comprehensive control and monitoring systems. All equipment is carefully selected and matched to ensure ease of operation, installation and maintenance and to guarantee high performance under the most arduous operating and climatic conditions.

Most units can be fitted with an auxiliary generator system to provide from 20 KVA of on site electrical power in addition to mechanical flywheel power. Similarly, a wide range of air compressors and hydraulic pumps may be fitted also powered from auxiliary drives. Complete pump set packages including deep well applications are also available.

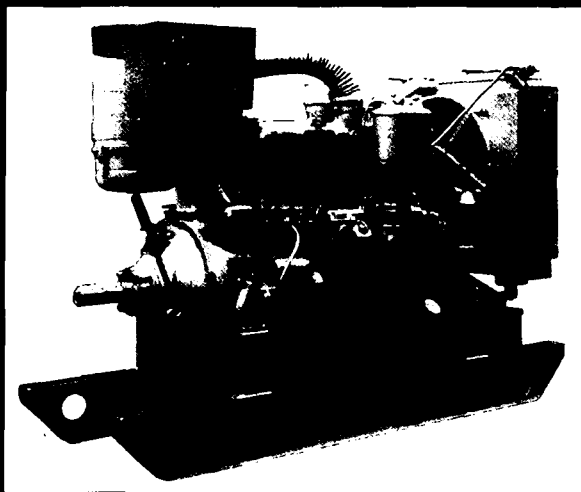

In order to best meet a variety of local needs such as spares availability, user acceptance, climatic conditions, etc., a wide range of air and water cooled engines, of international repute, are offered as prime movers for both power packs and generator sets. These include Lister-Petter, Deutz, VM, Perkins, Rolls-Royce, Cummins, Iveco-Fiat, Volvo Penta, Scania, DAF, Dorman, Mercedes, Caterpillar, Bedford and Mitsubishi. Units are available fuelled by petrol, diesel and natural gas.

# IRRIGATION & POWER

## SYSTEMS LTD

P.O. Box 510  
Maidenhead  
Berkshire SL6 7BW England

Telephone: Maidenhead (0628) 38031 Fax: (0628) 74928 Telex: 849462 TELEFAC G

## ELECTRICAL MOTORS, STARTERS, CONTROLS ETC.

---

Turnkey computer control and monitoring system.

**ELECTRICAL SYSTEMS LTD** 226-228 Holbrook Lane, Holbrooks, Coventry, CB6 4DD, UK, Tel: +44-203-637086, Contact: Mr Jones. Manufacturers of medium voltage motor control gear panels, starters, distributors, switchboards and general control panels for use in the sewage and water industry.

**EMERSON ELECTRIC CO** P O Box 4100, 8000 West Florissant Avenue, St Louis, Missouri, 63136, USA, Tel: +1-314-553-2000, Telex: 19-3117-44-876, Fax: +1-314-553-3527, Contact: Sue. Manufacturers of a broad range of electrical/electronic products.

**ERSKINE SYSTEMS LTD** Lee De Forrest House, Fastfield, Scarborough, North Yorks, YO11 3DU, UK, Tel: +44-723-583511, Telex: 52562 ERSKIN G, Fax: +44-723-581231, Contact: Mr Hill. Manufacturers of secure AC and DC power supplies, emergency lighting, battery chargers and uninterruptible power supplies.

**FRANKLIN ELECTRIC** Blufton, IN, 46714, USA, Tel: +1-219-824-2900, Telex: 232-493, Fax: +1-219-824-2909, Contact: Mr Schach. Franklin is the world's leading manufacturer of submersible motors for deep well pumps and a leading manufacturer of electric motors for centrifugal pumps, with a maximum rating of 3 hp.

**N J FROMENT & CO**, Easton Stamford, Lincolnshire, PE9 3NP, UK, Tel: +44-780-51051, Telex: 32275, Fax: +44-780-66061, Contact: Mr Sewter. Manufacturers of tractor-driven generators, load banks, dynamometers and test equipment.

**G E CANADA** 795 First Avenue, Lachine, Quebec, H8S 2S8, Canada, Tel: +1-514-485-4110, Fax: +1-514-485-4230. G E Canada has served the worldwide hydro market for over 100 years. The company designs and manufactures hydraulic turbines, hydrogenerators, synchronous generators, static excitation equipment and isolated phase bus duct.

**GEC LARGE MACHINES LTD** Mill Rd, Rugby, Warwickshire, CV21 1BD, UK, Tel: +44-788-542121, Telex: 31671 GECMCR G, Fax: +44-788-79740, Contact: Mr M A Lovie. Manufacturers of motors and generators for pumping applications including variable speed drive equipment, also provide a spares, commissioning and maintenance service.

**GREAT LAKES HYDRAULIC INC** 4170 36th St, S E Grand Rapids, Michigan, 49508, USA, Tel: +1-616-949-8844, Fax: +1-616-949-6598, Contact: Dave Van Der Dean. Manufacturer of the "Infidrive" a variable speed drive which works on oil-shear principle for torque transmission. Used primarily in pumping applications to control flow, level and pressure.

**GRUNDFOS INTERNATIONAL A/S** P D Jensensvej 7, Bjerringbro, 8850, Denmark, Tel: +45-6-68-14-00, Telex: 60731 gfos dk, Fax: +45-6-68-44-72. The Grundfos range of products includes not only pumps and attached driving arrangements but also the entire palette of related accessories such as starters, controls and well-heads etc.

**HANSEN TRANSMISSIONS INTERNATIONAL S A** Leonardo Da Vincilaan 1, Edegem, B-2520, Belgium, Tel: +32-3-450-12-11, Fax: +32-3-450-12-20, Contact: R Breyne. Hansen manufactures several lines of high-quality power transmission products. The central product line is the Hansen Powerplus standardized gear unit. The complementary Hansen Junior range of geared motors, is available from 20 Nm to 9.000 Nm. Synergic.

**HEENAN DRIVES LTD** P O Box 52, Blackpole Rd, Worcester, WR3 8TL, UK, Tel: +44-905-57555, Telex: 335409, Fax: +44-905-56539, Contact: Graham Perry. Manufacturers of AC and DC variable speed drives, eddy current couplings and complete drive systems for the water industry.

**HUBERTS BV** PO Box 251, Veghel, AG, 5460, The Netherlands, Tel: +31-41-30-66811/41-30-42275, Telex: 74645, Fax: +31-4130-42029, Contact: Ms Ira Turner. Import/export wholesale company in mainly wood-working and metalworking machines for semi-industrial purposes: metal lathes, wood lathes, bench grinders, (pedestal) drilling machines, air tools, compressors, water pumps, electric motors, band sawing machines, metal sawing machines, welding equipment and dust exhausters.

**HUSBANDS SHIPYARDS LTD** Electrical Division Cracknore Hard Marchwood, Southampton, SO4 4ZD, UK, Tel: +44-703-663555, Telex: 47450 HUSBND G, Fax: +44-703-663094, Contact: Mr P B Husband. Designers and manufacturers of M V switchboards, distribution, motor control, process control and instrumentation control panels for electrical, electropneumatic and pneumatic systems. Site installation, commissioning and maintenance. After sales service.

**HYDRO BOND ENGINEERING LTD** Unit 2B, Woodside Road Bridge of Don, Aberdeen, AB2 8EF, UK, Tel: +44-224-822996, Telex: 739454, Fax: +44-224-825142, Contact: Mr Glyn Gilbert. Hydro-Bond Engineering design, manufacture and service a range of underwater electrical connectors and electrical pressure penetrators. The extensive service facility covers cable connector moulding, cable splicing, connector/cable repair, tether and umbilical cable termination.

**IDEAL ELECTRIC CO** 330 East First St, Mansfield, Ohio, 44903, USA, Tel: +1-419-522-3611, Telex: 987410, Contact: Nick Vucelic. Ideal Electric has been designing and building custom designed electrical equipment for 85 years. Horizontal and vertical, synchronous and induction motors, also build eddy current couplings which can be used as variable speed drives.

**KLOECKNER INDUSTRY ANLAGEN GmbH** PO Box 100852, Kloeckner Haus, Duisburg, D-4100, West Germany, Tel: +49-203-181, Telex: 085581870 RC D, Fax: +49-203-340095, Contact: Herr Hillerf. Provide a complete turnkey service to the waste water industry. Also complete mechanical and electrical packages including engineering, start up and operation maintenance if required.

**MARATHON ELECTRIC MFG CORP** P O Box 8003, Wausau, WI, 54402-8003, USA, Tel: +1-715-675-3311,

## ELECTRICAL MOTORS, STARTERS, CONTROLS ETC.

Telex: 260175, Fax: +1-715-675-6361, Contact: Deb Mortenson. Manufacturer of generators and motors.

**NEI ELECTRONICS LTD (INDUSTRIAL CONTROLS)** Kingsway, Team Valley, Gateshead, Tyne & Wear, NE11 0QJ, UK, Tel: +44-91-487-0811, Telex: 537040, Fax: +44-91-482-0006, Contact: Ian Laven. AC & DC variable drive systems from 3 kVA to highest ratings available, motor control centres and control and instrument packages.

**PETBOW LTD** Ramsgate Rd, Sandwich, Kent, CT13 9NE, UK, Tel: +44-304-613311, Telex: 96329, Fax: +44-304-613358, Contact: Mr Ridout. Manufacture a range of generating sets from 1 KVA up to 6,000 KVA either as open, enclosed, portable, mobile, silenced, or fully automatic with a wide choice of diesel engines.

**SAFRONICS LTD** Pearson St, Leeds, West Yorkshire, LS10 1BQ, UK, Tel: +44-532-457170, Telex: 55210, Fax: +44-532-421739, Contact: Mr Tremlin. Manufacturers of AC and DC motor control systems including multi-motor control centres.

**A O SMITH** 531 North 4th St, Tipp City, Ohio, 45371, USA, Tel: +1-513-667-2431, Telex: 288097, Fax: +1-513-667-2339, Contact: Mr Terry Glass. Manufacturers and suppliers of electric motors for domestic water systems and swimming pools, and of centrifugal pumps.

**SQUARE D (UK) LTD** Cheney Manor, Swindon, Wiltshire, SN2 2QG, UK, Tel: +44-793-513533, Telex: 8958791, Fax: +44-793-485141, Contact: Mr Hiley. Manufacturers of electrical motor control including control centres, variable speed AC and DC drives, distribution switchboards, and programmable controllers including data logging systems with graphic displays.

**THAMESMEAD ENGINEERING LTD** Headley Cottage, Weston Green, Thames Ditton, Surrey, KT7 0JY, UK, Tel: +44-1-398-3178, Telex: 8955340, Fax: +44-1-398-7021, Contact: Mr Richard Payne. Electronic load governors, water level and pressure pulse output controllers, speed monitor relays, control panels, full range of alternators, motors and switchgear, purpose built and designed for water power and water industry requirements.

**THORN EMI ELECTRONICS LTD (AUTOMATION DIVISION)** P O Box 4, Rugeley, Staffordshire, WS15 1DR, UK, Tel: +44-8894-5151, Telex: 36135, Fax: +44-8894-5151 ext 213, Contact: Mr R A G Clarke. Motor drives for pumps, fans and for other process plant, providing close control of variable speed. The range of standard units covers most ratings up to 600kw.

**TORRENT PUMP INDUSTRIES** P O Box 51066, Kifisia, GR-145 10, Greece, Tel: +30-1-81617128161702, Telex: 215870, Fax: +30-1-8161018. Power panels.

**TOTTON PUMPS LTD** Southampton Rd, Cadman, Southampton, SO4 2MS, UK, Tel: +44-703-813136, Fax: +44-703-813-650, Contact: Mr Bran. Manufacturers of magnetically coupled centrifugal pumps, diaphragm pumps, submersible column pumps and small electric motors to 80 watt output.

**WHIPP & BOURNE LTD** Switchgear Works, Castleton, Rochdale, Lancashire, OL11 2SS, UK, Tel: +44-706-32051, Telex: 63442, Fax: +44-706-345896, Contact: Philip Thompson. Manufacturers of: DC switchgear up to 3000 volt, 12. 000 amp, vacuum switchgear up to 13. 8kv, 3000 amp, 40ka, air-brake switchgear to 7. 2kv, 43ka.

### Hydroelectric Turbines and Equipment

**ABB STAL** Dept M, Finspong, S 61220, Sweden, Tel: +46-122-81000, Telex: 64045, Fax: +46-122-186-84, Contact: Ms Kvarmstrom. Manufacturers of turbines and pressurised fluidised bed combustion systems.

**AMERICAN HYDRO CORPORATION** 130 Derry Court, York, PA, 17402, USA, Tel: +1-717-764-3587, Fax: +1-717-764-0848, Contact: Mr Bill Colwill. Manufacturers of custom-designed, upgraded turbine runners. Specialists in turbine research and development, repair and refurbishment.

**BIWATER HYDRO POWER LTD** Crow Arch Lane, Ringwood, Hants, BH24 1PE, UK, Tel: +44-425-472405, Telex: 418295 ARLICO G, Fax: +44-425-471652, Contact: Ken Grubb. Specialise in small scale water engineering designed to produce hydro-electric power for local, domestic and industrial consumption or for investment purposes.

**BOVING & CO LTD** Villiers House, 41-47 Strand, London, WC2N 5LB, UK, Tel: +44-1-839-2401, Telex: 28444 BOVING G, Fax: +44-1-930-3991, Contact: Mr Arotzky. Boving & Company Limited, a part of the Kvaerner Hydro Group of companies, was founded in 1912 and is the only supplier of large water turbines in the United Kingdom.

**CIMH** 42 Avenue J Desplats, Castres, 81100, France, Tel: +33-63-35-63-15, Telex: 520200, Contact: Pierre Dutoit. Manufacturers of small frontsturbines and propeller turbines up to 400kw. CIMH also undertake feasibility studies and design for the water industry.

**DANUBE HYDRO AUSTRIA** P O Box 88, Parkring 12, Vienna, A-1011, Austria, Tel: +43-222-515-38-0, Telex: 111-366-DO1A, Fax: +43-1-515-38-3900. International consulting service for dam and hydro power development covering the multitude of technical and economic disciplines with particular emphasis on low head dams, river engineering and inland navigation.

**DEPENDABLE TURBINES LTD** 7-3005 Murray St, Port Moody, BC, V3H 1X3, Canada, Tel: +1-604-461-3121, Fax: +1-604-461-2314, Contact: Robert Prior. Manufacturers of a complete range of governors, generators and turbines.

**DUMONT SA** Pont de St Uze, St Vallier, 26240, France, Tel: +33-75-23-09-22, Telex: 345-501, Fax: +33-75-03-94-82, Contact: Mr Henri. Hydraulic turbines.

**ESSEX TURBINE COMPANY** Kettle Cove Industrial

**All pumps are alike. But ours  
are made especially for you!**

Pumps made to Customer's  
specifications or to our own  
high-standard specifications.

- \* Artesian-well submersible pumps
- \* Centrifugal sectioned pumps (Model TsNS)
- \* Pumps for mine water withdrawal (Models N-1M or PNP-50-12)
- \* Slurry and sludge pumps

**ALWAYS ON OUR EXPORTS LIST.**



V/O ENERGOMACHEXPORT  
19, Prospekt Kalinina,  
121019, Moscow, USSR  
Tel. 203-15-71  
Telex. 411965



# HYDRAULIC POWER GENERATING PLANT FROM THE USSR

L.I. Kurtynin, Deputy General director

Power industry is a fundamental sector of national economy in any country. By the level achieved and by the rate of progress in power industry we can always judge the place of a nation in the structure of world economy.

Hydroelectric power generating industry, in itself a vital area of the entire power industry, has become to some countries, for many objective reasons, dominating and most promising for a foreseeable future. To other countries, including most of the developed nations, hydroelectric power generating industry guarantees 10-20 per cent of their power output. On the whole, world hydroelectric resources are yet to be developed on this planet by future generations. What with the high power generating efficiency and equally high economics the share of hydraulic power stations will be continuously growing in the world power balance.

On the other hand, the acuteness of ecological problems on a regional, as also on the planetary scale, poses a few serious questions which have to be decided before we move ahead with hydroelectric power construction. Decision-taking in the area of new hydraulic construction demands nowadays a careful approach from all angles and points of view, before economic feasibility of this or that hydraulic project is finally appraised. In this light capability of major hydroelectric power generating plant acquires an even greater importance, particularly, such features as size and mass of turbines and generators, their efficiency, reliability, extended service life, utilization of advanced automation. Cost and credits added, these factors pre-determine the level of competitiveness of hydroelectric power generating plant on the world market.

Soviet hydroelectric power generating in-

dustry – its achievements and progressing rates of development – has a world reputation. The total installed capacity of all hydroelectric power stations in the USSR has reached 62 million kW with an annual output in the region of 215 billion kW.h. Soviet hydroelectric power generating industry has accumulated an enormous experience in design and construction of hydraulic projects, bearing in mind our vast territories and all the diversity of climatic, topographic and geological conditions in which are home hydroelectric power stations are built. The experience fused with advanced manufacturing facilities seem to us the best guarantee of quality equipment. In fact, the achievements of our hydroelectric machine building industries and the experience we have acquired in the area of foreign trade have altogether brought positive results in terms of commercial benefits. In the past few years, Soviet foreign trade association ENERGOEXPORT gainfully realized some large international contracts.

From 1973 to 1980, Canada purchased and installed Soviet hydroelectric power plant to a total of 1988 MW installed capacity. Two hydraulic machines of 444MW are now in operation at MICA; six bulb-type hydroelectric units run at Jenpeg, each rated at 28MW; two turbines of 110MW each are installed at MAC-TAKWAK and four turbines of 173MW at PEACE CANYON.

According to MANITOBA HYDRO's President Bitty, his company is satisfied with the decade-long performance of the bulb-type turbines at Jenpeg. Nor had they any serious problems with other machines delivered to Canada from the USSR.

In December 1982, the last of fourteen units was commissioned at SALTO-GRANDE – a

joint Argentina-Uruguay Hydro-Electric Project. The first one was installed and commissioned in June 1979. Each next 135MW unit was commissioned with a three-months interval. And these are rather large machines: 8.5m-dia. of the turbine-wheel, 650-ton mass of the rotor. All fourteen turbines for Salto-Grande had been built at the Kharkov Turbine Works, generators - by ELEKTROSILA of Leningrad.

Unique run-away tests performed in 1982 on one of the machines installed at Salto-Grande proved the extremely high reliability of Soviet machines. Full-scale field tests which were carried out according to the contract terms indicated that turbine efficiency was, as a matter of fact, higher than that specified in the contract. Excellent performance and operational reliability of the plant, confirmed by the reports of many competent experts in Argentina, created the Salto-Grande Project a reputation of a most dependable source of electric power in both Argentina and Uruguay. "Extremely high reliability of Soviet plant made Salto-Grande project an overall success for Argentina and Uruguay", - confirmed in September 1987 Diego Algorta, Chief Engineer of the power station.

The turbines built by the Leningrad Metal Works have also proved a success in Brazil. Installed 10 years ago in São Paulo, four Soviet turbo-generator sets of 163MW unit capacity have turned into a reliable source of power supply.

In the years 1979-1982, six units of 178MW unit capacity had been commissioned at SOBRADINJO on the São Francisco in Brazil. These were the world's first ever Kaplan turbines with a 9.5m-dia. wheel.

In 1988, the Greek customers signed a memorandum which thus put an end to the testing program, thereby confirming the undoubted success of three hydraulic sets each rated at 103MW installed at PURNARI. Excellent reports on the performance of Soviet hydroelectric generating plant are coming from India, Norway, Iceland and other countries.

Currently, V/O ENERGOEXPORT is realizing a few major contracts, including the 4x350 MW PJEDRA DEL AGILA Hydro-Electric project or supply of bulb-type turbines of 14MW unit capacity to Yugoslavia. In 1982, the Power electricity board on the Atlantic coast of Columbia - COREXCA - signed a large contract for the construction of the ALTO SINU Hydro-Electric Project on the Sinu which was to incorporate two hydraulic power stations - URRRA I (4x85MW) and URRRA II (4x215MW), totalling 1200MW.

Traditionally, Soviet responsibilities ex-

tended to: design, manufacture, field supervision of installation, precommissioning, commercial commissioning and guarantee operation of turbines and generators. In certain instances, turbine deliveries covered other accessories, like hydroelectric controllers complete with an oil pressure-operated station; in other cases, generators are delivered complete with a system of thyristorized (static) excitation. At Customer's option, V/O ENERGOEXPORT is prepared to supply other station auxiliaries, like hydromechanical plant, overhead travelling cranes for machine rooms, electric distribution panels and control desks, transformers, etc. The scope of supply is in each case the object of agreement with the client or may be otherwise specified in Tender documents. Our services on field supervision of plant installation and precommissioning operation can be further extended to coaching of personnel, or retrofitting and refurbishment, or overhauling of the existing plant.

Construction of any turbine to specific requirements is preceded by comprehensive research which is to provide the optimal design of the flow passage and of the turbine wheel. Research work is carried out in hydraulic laboratories, such as are at the disposal of our two major producers of hydraulic turbines - at the Leningrad Metal Works and Kharkov Turbine Works. Both laboratories experiment with a broad spectrum of models, including scale models of Kaplan, Francis, bulb-type and other hydraulic turbines, so, they have a capacity to ensure excellent performance of each machine with specified parameters. Where necessary, the two laboratories may exchange models and information which may thus double the capability of Soviet hydraulic turbine builders.

The laboratories are stocked with advanced equipment, up-to-date monitoring facilities and precise instrumentation, to an extent required for all kinds of experiments, including testing facilities for:

- hydrodynamic model studies of hydraulic turbines and turbo-pumps;

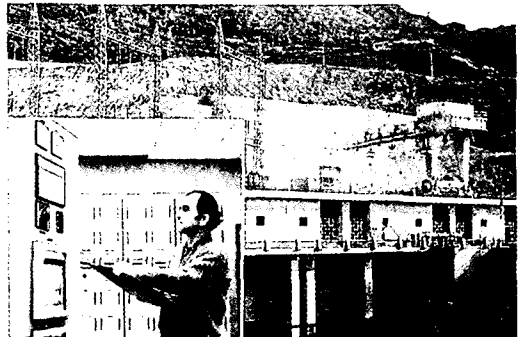

## ADVERTISEMENT FEATURE

- endurance and vibration tests;
- structural studies of machines, mechanical components and various materials.

Computer-aided hydrodynamic and strength calculations make it possible to design new machines on a higher engineering level.

Large teams of skilled design engineers employed by the turbine works are qualified to tackle and solve any difficult problem they may encounter on the way to development of new machines. Up-to-date computers and computing facilities are broadly used to facilitate their design work. The turbine building enterprises have advanced manufacturing equipment and employ skilled labor.

The reports of our users we mentioned above and their high appraisal of the performance of Soviet hydroelectric power generating plant are the best proof of what had been said in the previous statement.

Over the entire history of the Leningrad Metal Works, they built here more than 800 different models of hydraulic turbines, including 340 Francis machines for a head of 200m to 350m.

The Francis turbines installed at the Sayno-Shushenskaya Hydro-Electric Power Station operate at up to 220m heads and even higher, carrying a load of 735MW. The 6.77m-dia. turbine wheel has an enhanced resistance to cavitation effects and offers high energy characteristics. In 1969, the Leningrad Metal Works built for the Jerdap Hydro-Electric Project (Iron Gates) on the Danube a 195MW Kaplan turbine with a 9.5m-dia. wheel.

The P/A LMZ (Production Association LENINGRAD METAL WORKS) designs and builds Pelton turbines. In this area, all efforts are concentrated on the development of Pelton turbines of a greater unit capacity, higher efficiency, enhanced speed and their utilisation at still higher heads. A few original engineering ideas have already been incorporated in the design of Pelton turbines. One such innovation is the welded construction of the wheel which has no analogues anywhere in the world of hydraulic turbine building.

As regards the Kharkov Turbine Works, the local engineers have accumulated a vast experience in the design and construction of high-pressure Francis turbines which will withstand a head of up to 400 metres. In 1987, they launched into quantity production a series of six turbosets of 615MW unit capacity, designed for 245m effective head, which will be installed at the Rogunskaya Hydro-Electric Power Station. In the past few years, the P/A KhTZ (Production Association KHARKOV TURBINE WORKS) built a series of Kaplan turbines of 230MW unit capacity, 8.5m-dia. wheel for the Shulbinskaya Hydro-Electric

Power Station; another series of the same machines of 59.3MW unit capacity, 10.3m-dia. wheel for the Saratovskaya Hydro-Electric Power Station, and yet another series of Kaplan turbines of 195MW unit capacity, 7.5m-dia. wheel for the Shamkhorskaya Hydro-Electric Power Station. P/A KhTZ is a major producer of large waterlocks for pressure conduits at hydraulic power stations and pumped storages. Altogether, over the entire history of the Works, they built here more than 280 waterlocks for a wide range of diameters and heads. It will be relevant to observe that engineers of P/A KhTZ designed and built a unique waterlock - RO170-V-180 - is has an absolutely original design and may perform functions of a common Kaplan turbine and of a pre-turbine lock.

At the same time, the world market of sophisticated plant, such as hydroelectric power generating machines are, demands nowadays - a side from purely technical aspects - solution of many other associated problems which will finally determine the success of this or that piece if the equipment is on the market. Essentially, one of the ways to a most rational solution of the entire set of organizational, financial and technological problems is joint participation of several companies in one specific project. An international consortium, which draws in several private and state companies in the client country is now one of the most popular forms of joint ventures.

V/O ENERGOEXPORT has a rich experience in realization of some major projects - both thermal and hydraulic power stations - in the form of consortia with West European and Latin American countries.

Just, for instance, the Salto-Grande project was realized in a consortium with the local Argentina company TAURO. The latter, in its turn, invited to participate as sub-contractors other local companies from Argentina. In Greece, we realized our contract in a consortium with BRAUN BOVERI from the FRG.

In pursuance of our consortium policy, we invited participation of local partners in the PJEDRA DEI AGILA project in Argentina. The contract for supply and installation of four turbines and generators of 350MW unit capacity was signed in April, 1986 by our Argentinian customer - HYDRONOR Co. and the Soviet-Argentinian consortium made up by V/O ENERGOEXPORT (USSR) and two local companies - IMPSA and COMETARSA. The terms of the inter-consortium agreement provided for joint design of turbines and generators both in the USSR and in Argentina and the use of Soviet experience and technology by Argentinian partners. Two turbines were

## ADVERTISEMENT FEATURE

built at the Kharkov Works and two other turbines – at the local factories. Electrical components of the generators are to be delivered by ELEKTROSILA (Leningrad). The remaining parts and assemblies of the generators, and their assembly will be done at the local factories against the Soviet technology and under supervision of Soviet specialists. For the turbines and generators to be built locally in Argentina the Soviet manufacturers will deliver, in a break-down form, some large assemblies and most sophisticated parts.

At customer's option, some systems and components of the turbines and generators will be purchased, on terms of a sub-contract, from West European countries. Say, electrical systems of turbine controllers will be delivered by NEIRPIC (France), generator excitation systems will be supplied by Switzerland's BRUAN BOVERI, on-load tap changers for the power transformers – by MASCHINEFABRIK from the FRG.

The detailed design and supply of auxiliaries for the hydraulic units will be the responsibility of our Argentinian partners in cooperation with Soviet specialists from the Leningrad branch of the GIDROPROYEKT Institute (USSR). Both partners in the consortium will take care of field supervision of plant installation they will supply and will be responsible to the customer as regards their joint indivisible liabilities concerning the dates, workmanship and performance of their supplies.

In the past few years, the world market of hydroelectric plant indicated a trend towards the construction of small hydraulic power stations with bulb-type turbines. The biggest advantages of such power stations are a relatively small nominal head of 4m to 11m and a much reduced land to be flooded. With the same wheel diameter, the bulb-type turbine – as compared with the vertical turbine – will guarantee a greater throughput capacity which will raise the specific capacity of the machine by 30 per cent; moreover, the optimal efficiency of the former is 1-2 per cent higher than that of the vertical turbine. The total cost of construction of power stations with horizontal hydraulic machines is 10-20 per cent less than that involved in the construction of hydroelectric power stations with vertical Kaplan turbines.

In spite of the fact that from the structural and installation points of view the bulb-type turbines are more complicated than the Francis and Kaplan machines, the above-mentioned advantages made them highly popular all over the world. Soviet manufacturers have already built some 100 turbines of this type which gainfully operate both at home and abroad, including six machines of 28MW unit capacity

at Jenpeg in Canada where they withstand a 7.3m head, and 5.3MW machines at KLOSTERFOSS in Norway for the 5m head. In fact, the Soviet Union is a major world producer of bulb-type turbines.

Today, some countries are developing their energy programs on a basis of new nuclear and thermal power stations. However, a limited capacity of such power units to change quickly their daily loads in a required range of capacities has led to excess generation of electricity at night and shortage of power supply in the day time. One of the ways to solve this problem is a pumped storage which may operate either as a turbine or as a pump, dependent on the demand.

Several pumped storage projects are now either in the design stage or under construction in the Soviet unit.

One such project – the Zagorskaya Pumped Storage is now under construction in the vicinities of Moscow. The maximum expected head here will be 113m. The station will have six units of 200MW each. The turbopump will have a 6.3m-dia. wheel which will be enough to ensure a capacity of 205/217MW in the turbine and pumping duties accordingly. Another such project – the Kaishyadorskaya Pumped Storage – will have eight units of 200MW capacity each. Annual output of electric energy will amount to 2.4 billion kW.h. The Dnestrovskaya Pumped Storage will have seven units of 324MW each with a 7.3m-dia. wheel. The design turbine head is 135.2m.

The reforms that took place recently in our national structure of foreign trade and economic cooperation have also spread to V/O ENERGOEXPORT. Three Soviet foreign trade associations – V/O ENERGOEXPORT, V/O SOVELECTRO and V/O ZARUBEZHENERGOSTROI – have joined their efforts and set up a consortium – ENERGOEXPORT – which will be ready to go into package deals, starting from earlier design stages and ending with commercial commissioning of plant at thermal and hydraulic power stations.

**Hydraulic turbines and generators of all known types**

Soviet manufacturers produce hydropower units of up to **800 MW** in capacity

V/O ENERGOEXPORT is the largest supplier of Soviet hydroelectric power generating equipment

## HYDROELECTRIC TURBINES AND EQUIPMENT

Park, Magnolia, MA, 01930, USA, Tel: +1-617-525-3523, Fax: +1-617-525-3214, Contact: Mr Gary Manter. The company builds hydro electric turbines (axial flow bulb style - 50 to 1000 kw). Specialists in stand-alone power plant. Manufacturers of turnkey packages.

**FABRICA TURBINE E CALDAIE** FTC Legnano SRL, Piazza Monumento 12, Legnano, (Milan) 20025, Italy Tel: +39-331-522111, Telex: +330661/314385 FTOSI, Fax: +39-331-593321. Fabrica Turbine E Caldaie - FTC Legnano SRL (Franco Tosi Group) represents a wealth of know-how and experience in the fields of generation, conversion, utilisation and recovery of energy in its various forms, as well as in other areas such as sea water desalination, ship propulsion and in general industrial plants, where equipment produced by the company finds a field of application.

**FLYGT AB** Box 1309 S-171 25 SOLNA, Sweden. Tel: +46-8-733 6500, Telex: +43887 flygtab s, Fax: +46-8-295816, Contact: Anderz Öhringe. Flygt is the world's leading manufacturer of submersible heavy-duty pumps for contaminated and abrasive liquids. The annual sales for 1988 was approx SEK 2.3 billion. With over 1,250,000 installations in more than 100 countries throughout the world, Flygt submersible products encompass an awesome range of pumps, mixers and hydro turbine generators for small scale hydro electric power stations. The main office is situated in Solna, just outside Stockholm, with manufacturing facilities in Lindas. Flygt has subsidiaries in 16 countries and 3,400 employees of which 1,500 are in Sweden.

**FRANCO TOSI INDUSTRIALE SPA** Piazza Monumento 12, Legnano, Milan, 20025, Italy, Tel: +39-331-522-111/36-331-547-690, Telex: 330661-314385 FTOSI, Fax: +39-331-593-321. Established in 1882, operates in the field of power generation equipment design and manufacturing (steam and hydraulic turbines, boilers, feedwater heaters and condensers, compressors, pumps and desalination plants).

**GANZ-MAVAG LOCOMOTIVE & RAILWAY CARRIAGE MANUFACTURERS, MECHANICAL ENGINEERS** P O Box 136, Budapest VIII, Konyves Kalman krt 76, Budapest, H-1967, Hungary, Tel: +36-137-020, 335-950, Telex: 22-5575, 22-5576. Water turbines (Francis, Kaplan and Pelton types), water turbine stations, pumps and pumping stations.

**GE CANADA** 795 First Avenue, Lachine, Quebec, H8S 2S8, Canada, Tel: +1-514-485-4110, Fax: +1-514-485-4230, Contact: Mr Tom Way. GE Canada has served the worldwide hydro market for over 100 years. The company designs and manufactures hydraulic turbines, hydro-generators, synchronous generators, static excitation equipment and isolated phase bus duct.

**GEC ENERGY SYSTEMS LTD** Cambridge Rd, Whetstone, Leicester, LE8 3LH, UK, Tel: +44-533-863434, Telex: 34611, Fax: +44-533-866084, Contact: Mr Chris Swan. Manufacturers of Francis, Kaplan and propeller type water turbines and associated ancillary equipment including electronic governors.

**GILKES LTD**, Kendal, Cumbria, LA9 7BZ, UK, Tel:

+44-539-20028, Telex: 65125, Fax: +44-539-32110, Contact: Mr Figge. Manufacturers of water turbines for hydro-electric use, cooling water pumps, simulation equipment for educational establishments, power systems.

**GSA INTERNATIONAL CORPORATION** Croton Falls Executive Park, Croton Falls, NY, 10519, USA, Tel: +1-914-277-8000, Fax: +1-914-277-8001, Contact: Mr Grover. Manufacturers of complete packaged hydro-electric plants from 1 kw to 1 megawatt, impulse turbines, double regulated Kaplan turbines and Francis turbines. Suppliers of speed increasers, generators and control panels. Provide a training service in the developing countries.

**HYDROELECTRA AG** Karl Vülkerstrasse 2, Heerbrugg, CH-9435, Switzerland, Tel: +41-71-72-60-79, Telex: 881111, Contact: Mr von Rotz. Suppliers of used turbines in all sizes, and of complete computer control systems for hydro-power stations.

**IREM S P A** Via Vaie 42, S Antonio Di Susa, Turin, 10050, Italy, Tel: +3911-9649133, Telex: 212134, Fax: +3911-9649933, Contact: Mr A Bonini. Ecovatt Microhydroelectric plants exploit small falls and flows generating clean energy (power from 50w to 50kw). Irem Research quality, reliability are driving forces behind success.

**JANSEN VENNEBOER B V P O** Box 12, AA Wijke, 8130, The Netherlands, Tel: +31-5702-2525, Telex: 49418, Fax: +31-5702-3618. Design, production and installation of mechanical construction for hydraulic works. Products include: archimedean screws, penstocks, sluice gates and radial gates, regulating and measuring weirs, weedscreens, automatic raking installations Volanta handpumps and low-head water turbines ( up to 1000 kW).

**MAWDSLEY'S LTD** Dursley, Glos, GL11 5AE, UK, Tel: +44-453-4131, Telex: 43128, Fax: +44-453-46571, Contact: Mr Reeves. Mawdsley's specialise in the manufacture of low voltage AC generators from 3-2,000 KVA for hydro electric installations.

**NOHAB-KMW TURBIN AB** P O Box 925, Trollhattan, 46129, Sweden, Tel: +46-520-18410, Telex: 42247, Fax: +46-520-89299, Contact: Mr Lenn Svensson. Manufacturers of water turbines (Francis and Kaplan), also of auxiliary equipment for the nuclear power industry.

**OBBERMEYER HYDRAULIC TURBINES LTD** 10 Front St, Collinsville, Connecticut, 06022, USA, Tel: +1-203-693-0295, Telex: 9102503706, Fax: +1-203-693-1447, Contact: Mr Neil Murdoch. Manufacturers of hydro-electric turbines and support systems (induction and synchronous) gate systems, control and switchgear and engineering support.

**OSSBERGER TURBINES INC** 5709 South Laburnum Avenue, Richmond, Virginia, 23231, USA, Tel: +1-804-226-9180, Telex: 5101001298, Fax: +1-804-222-1097. Ossberger Turbines Inc are suppliers of complete hydro-power stations for independent and/or grid-connected operation in the range between heads of 1 and



*Sea water desalination plant  
on three lines, 32,100 m<sup>3</sup>/day  
fresh water production each.*

**18 Desalting plants over 5,000 cubic meters/day capacity**

**Total capacity: 300,000 cubic meters/day**

**Gained output ratio between 7 and 13**

**Long tubes and cross flow technology**

**20 years of design and operating experience**

**Average availability over 90%**

**SERVICE / MAINTENANCE / REVAMPING EXPERIENCE**

**Fabbrica Turbine e Caldaie**

**F.T.C. Legnano s.r.l. - Italy**

PIAZZA MONUMENTO, 12 — Tel.(0331) 547.690 — 522.111  
Telex 330661-314385 F. TOSI I — Fax (G3) (0331) 593.321

Franco Tosi Industriale Group

DANUBE HYDRO AUSTRIA

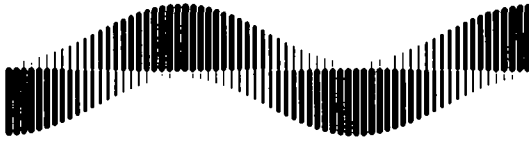

**ÖSTERREICHISCHE  
DONAUKRAFTWERKE AG**

A - 1011 Vienna

Parkring 12 P.O. Box 88

tel. +43 1 515 38 - 0

fax +43 1 515 38 - 3900

telex 111 366 do 1 a

## **MULTIPURPOSE HYDRO SCHEMES, AN ADVANTAGEOUS CONCEPT**

DANUBE HYDRO's concept of developing multipurpose hydro schemes brings out a lot more beneficial impacts than you might have imagined:

### *Generation of non-polluting energy*

at low costs, a most rewarding investment, serving the industrial and economic development as well as the structural improvement.

### *Stabilization of the public grid*

due to high flywheel effects, much appreciated by any national electricity board.

### *Navigation*

as a cheap and efficient means of transport, contributing to the development of industry, trade and tourism.

### *Flood control*

through warning systems and protective dikes, prevention of severe flood damages.

### *Environmental improvement*

through reforestation of wetbiotopes, protection of flora and fauna, wildlife refuges, river pollution and water quality improvement.

### *Social promotion*

by recreation areas and water sports facilities, development of leisure and tourism.



## **YOU CAN TRUST OUR PROPOSALS FOR SOLVING YOUR HYDRO PROBLEMS**

Consultancy Services, Preliminary Investigations, Master Plans, Feasibility Studies, Engineering Design and Cost Estimates, Tendering and Procurement, Detailed Drawings, Supervision and Coordination of Construction and Erection, Commissioning, Operation, Training, Reports on Specific Problems, Computer and Physical Models.

# HYDROELECTRIC TURBINES AND EQUIPMENT

200 metres and outputs of between 1 and 1,500 kw. Most of the Ossberger Plants are run-off-the-river applications.

**OSSBERGER-TURBINENFABRIK GmbH & CO P O** Box 425, Otto-Rieder-Strasse 7, Weissenburg, Bavaria, D-8832, West Germany, Tel: +49-9141-4091, Telex: 624627 OSSBG D, Fax: +49-9141-70522. Based on the OSSBERGER Turbine which is a radial impulse type turbine with partial admission, Ossberger-Turbinenfabrik GmbH & Co offer complete small hydro-power stations for independent and/or grid-connected operation in the range between heads of 1 and 200 metres and outputs of between 1 and 1,500 kW.

**PORTMORE ENGINEERING LTD** Clady Works, 48 Dunadry Rd, Muckamore, Co Antrim, BT4 14QN, N Ireland, Tel: +353-8494-32444, Contact: Mr Patterson.

**PSL INTERNATIONAL LTD** PO Box 4, Humber Rd, Barton-on-Humber, South Humberside, DN18 5BN, UK, Tel: +44-652-32702, Telex: 527305, Fax: +44-652-33401, Contact: Mrs McKenzie. Rotating equipment engineers - pumps, turbines and compressors, particularly for the water industry. Repairs to submersible pumps.

**SCHICK WASSERKRAFTTECHNIK** Prager Gasse 3/5, Vohenstrauß, D-8483, West Germany, Tel: +49-9651-2301, Fax: +49-9651-1693, Contact: Mrs Stahl. Specialised in screen cleaners (modern systems), net independent, free from ice sluice weirs and electronic control module complete for parallel power line operation of synchronized and asynchronous small hydro plants with quick-disconnect in case of malfunctions and power failure.

**TAMPELLA LTD** P O Box 616, Tampere, 33101, Finland, Tel: +358-31-32400, Telex: 22577, Fax: +358-31-134511, Contact: Mr A Kotisaari. Manufacturers of turbines, gate and butterfly valves.

**J M VOITH GmbH** PO Box 1940, St Poltner Strasse 43, Heidenheim, D-7920, West Germany, Tel: +49-7321-370, Telex: +714-79920, Fax: +49-7321-373000. Francis, Pelton and Kaplan turbines, Kaplan bulb turbines, pump/turbines and power-recovery turbines.

**WASSERKRAFT VOLK GmbH** Gefall 45, Simonswald, D-7809, West Germany, Tel: +49-7683-844, Telex: 0772668, Contact: Mr Ulas. Control systems, governors, generators and a wide range of turbines.

**WATER POWER ENGINEERING** Coaley Mill, Coaley, Dursley, Gloucestershire, GL11 5DS, UK, Tel: +44-453-89376, Telex: 437105, Fax: +44-45-383-4004, Contact: Mr Goring. Manufacturers of a small range of hydro-electric power systems of modern design and high performance, of modular construction. Available in four sizes, manufactured in polymers and composites.

## Lighting Equipment

**AEROFLASH SIGNAL** 1715 W Carroll Avenue, Chi-

cago, IL, 60612, USA, Tel: +1-312-733-3513, Fax: +1-312-733-0192, Contact: Ms Cari A Murray. Manufacturer of solid state strobe lights, warning systems and back-up alarms.

**BRIMOTOR LTD** Clarence Works, 30a Church Rd, Tunbridge Wells, Kent, TN1 1JP, UK, Tel: +44-892-37588, Telex: 95446 BIMOTR G, Contact: Mr Mossery. Manufacturers of portable, mobile and mains failure generating sets, and portable mobile floodlighting units. Manufacturers of self-priming and diaphragm pumps.

**JULIAN A MCDERMOTT CORP** 1635N Stephen St, Queens, NY C, 11385, USA, Tel: +1-718-456-3606, Fax: +1-718-381-0229, Contact: J Scott. This company has been in business for 45 years engineering and supplying safety and lighting equipment to utilities and municipalities. The devices include battery operated hand lights, flashers and work lights, barricades and vehicle warning lights for protection of men from vehicular traffic.

**PARAGON ELECTRIC CO INC** 606 Parkway Boulevard, Two Rivers, WI, 54241, USA, Tel: +1-414-793-1161. Manufacturer of programmable time controls, both electronic and electromechanical for lighting and HVAC.

**F W THORPE PLC** Facet Rd, Kings Norton F9 Birmingham, B38 9PU, UK, +4421-459-1122, Tel: +4421-451-2131, Fax: 339327, Contact: Mr Peach. F W Thorpe PLC (Thorlux Lighting) manufacturers of industrial and commercial lighting equipment. Product range covers fluorescent luminaries, bulkheads, floodlights High Bay reflectors, Type-N luminaries for zone 2 use and emergency lighting.

## Pumps- Centrifugal, Axial Flow and General

**A/S DE SMITHSKE** Tagholm 1, PO Box 205, DK-9400 Norresundby Denmark Tel: +45-9-8178111, Telex: 69620 desmi dk, Fax: +45-9-8175494. A/S De Smithske is a modern production and sales enterprise with a considerable technical know-how and with modern production and administration facilities. During the past years an intensive product development has resulted in new DESMI products within our entire range of centrifugal pumps and transmissions for the industrial and agricultural sectors.

**ABS PUMPEN AG** PO Box 12, 20 Scheiderhohe, Lohmar 1, 5204, West Germany, Tel: +49-2246-13-0, Telex: 889-619, Fax: +49-2246-13-200. ABS produces axial flow pumps with submersible electrical motor for a maximum capacity of 11000 l/sec. The use of axial flow pumps with submersible motor reduces building costs by 40 percent.

**ACROMET (AUST) PTY LTD** 14 Winterton Rd, Clayton, Victoria, 3168, Australia, Tel: +61-3-544-7333, Fax: +61-3-543-6706, Contact: Ernest A Hair. Acromet is an



# ECOWATT: CLEAN ENERGY FREE FROM WATER

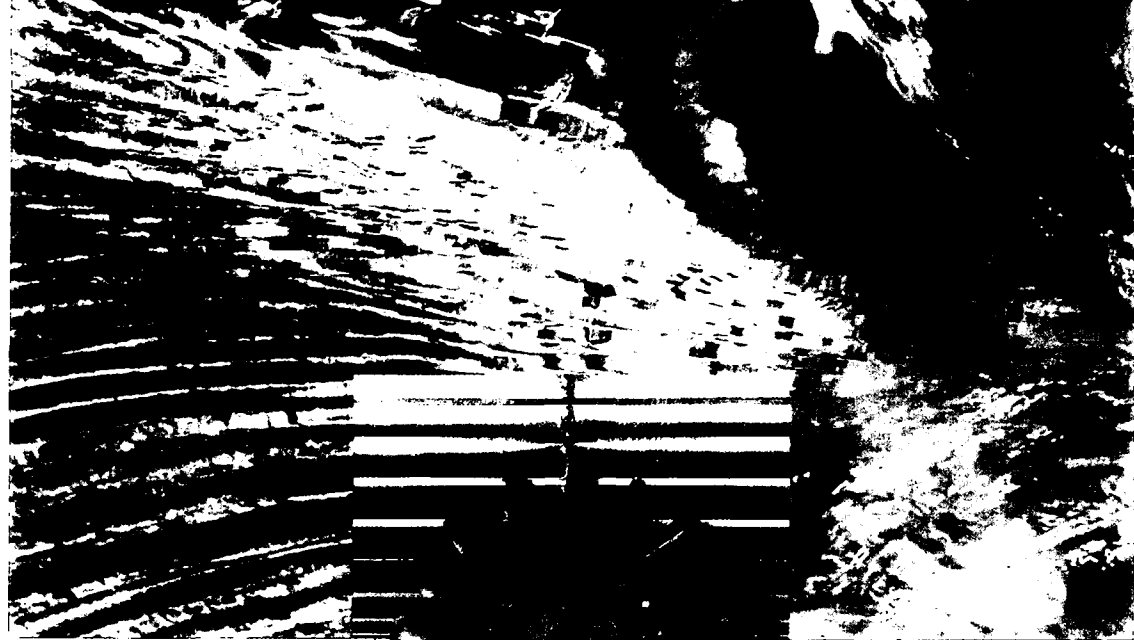

## THE TURBINE DIVISION

Long before the energy crisis and the birth of concern for the environment IREM was involved in clean energy supply.

The ECOWATT mini-stations are real miniature hydroelectric power stations which exploit small falls and minimum water volume flows to produce electricity supplies ranging from 50W to 50KW.

They supply independent sources of energy to Alpine refuges, small villages, shepherd's crofts and farms, agricultural concerns and isolated communities.

The vast range of models available and the modular assembly of the system make them adaptable to even the most disparate water supplies to give clean and cheap energy.

For IREM research and quality are the driving force behind success.

Company philosophy is to solve the customer's problems with a highly reliable product which is conceived as a «service» in the true sense of the term.

## IREM LEADERSHIP TODAY

Since 1946 IREM has been known for quality, reliability and advanced technology of its products and is a today leader among manufacturers of:



arc lamp power supply units for movie and lighting;



power supplies for computers - voltage regulators - line conditioners - UPS;



industrial voltage regulators and line conditioners - single phase - three phase up to 1000 KVA



mini hydroelectric power plants.

IREM S.p.A. - Via Vaie 42  
10050 S. ANTONINO (TORINO) ITALY  
Tel. (011) 9649133/4/5 - Telex 212134 IREMTO I  
Fax (011) 9649933

# IREM

## PUMPS- CENTRIFUGAL, AXIAL FLOW AND GENERAL

Australian manufacturer of chemical metering pumps and dry chemical feeders and a distributor of gas chlorination equipment and chemical pumps, both diaphragm and centrifugal, in plastic and special alloy construction. Acromet pumps and feeders are widely used throughout Australasia and South East Asia in water and wastewater treatment plants, and have an even wider range of applications in industry. Distributorships are available in many parts of the world.

**ADAMS HYDRAULICS LTD** P O Box 15, York, YO1 1XA, UK, Tel: +44-904-622047, Telex: 57664 ADAMS G, Fax: +44-904-611449, Contact: Mr Hopwood. Although over 100 years old, Adams is still an independent company specialising in the manufacture of pumping and treatment machinery and equipment for sewage disposal, water pollution control.

**ALBANY ENGINEERING CO LTD (INCORPORATING CROWN PUMPS)** Church Rd, Lidney, Gloucestershire, GL5 5EQ, UK, Tel: +44-594-42275, Telex: 43363, Fax: +44-594-42574, Contact: Mr Mckernon. Albany Engineering manufacture a range of diaphragm type metering pumps, centrifugal and rotary pumps, for a variety of applications in the water industry.

**ALPHA POMPE SRL** P O Box 10, Via Molino Emili, Macclodio BS, 25030, Italy, Tel: +39-30-978661, Fax: +39-30-27-22-261, Contact: Mr Grazioli Venanzio. Centrifugal, selfpriming drainage pumps, electric pumps, petrol and diesel motor pumps.

**AQUATEC MARKETING LTD** Unit 1D, Kennetside, Newbury, Berks, RG14 5PX, UK, Tel: +44-635-49141, Fax: +44-635-38681, Contact: Madeline Hall. Aquatec Marketing Limited is an international distributor of swimming pool, spa, whirlpool, water treatment and water engineering equipment. The company's comprehensive product range includes pressure vessels, pumps and irrigation equipment.

**ARKOS** Via Repubblica, 34 Brescello, RE, Italy, Tel: +39-522-687521, Telex: 531-227, Contact: Becchi. Manufacturers of centrifugal and self-priming low pressure water pumps 1-2 1/2", 30 - 100 cc two - stroke engines.

**ARMSTRONG PUMPS LTD** Peartree Rd, Stanway, Colchester, Essex, CO3 5JX, UK, Tel: +44-206-579491, Telex: 987858, Fax: +44-206-760532, Contact: Anne Greenall. Manufacturers of pumps, expansion equipment, booster sets and associated accessories.

**AUTOMETRIC PUMPS LTD** Turkey Court, Ashford Rd, Maidstone, Kent, UK, Tel: +44-622-677650, Telex: 965-633, Contact: Roger Burt. Producers of small pumps and sizes up to 2" BSP. The range includes centrifugal, gear, turbine, hand and vacuum pumps. We also handle a large range of pumps of other manufacture.

**B-RAM SOLIDS** 620 S Broadway, Albert Lea, MN, 56007, USA, Tel: +1507-373-3996, Fax: +1507-373-5937, Contact: Mr Wayne Bell Richard. Manufacturers of pumps for the transfer of difficult materials - from sludge or slurry to whole bones.

**BARNANT CO** 28W092 Commercial Avenue, Barring-

ton, IL, 60010, USA, Tel: +1-312-381-7050. Manufacture peristaltic tubing pumps, lab equipment (pH, thermometers, vacuum/pressure pumps).

**BARNES BOWSER (PUMPS) LTD** 75 Tupwood Lane, Caterham, Surrey, CR3 6DD, UK, Tel: +44-883-43619, Contact: Mr W Stevens. Barnes Bowser manufacture self-priming single stage pumps from 1.5 inch - 6 inch bore and mixed flow pumps (non self priming) upto 12 inch bore. These products have their application in drawing water from wells and bore holes.

**BARTHOD POMPES SA** 21 Rue Bearraban, Lyon, Paris, 69006, France, Tel: +33-78848651, Contact: Mr Canea. Barthod Pompes produce a large range of pumps and associated accessories such as rotating head systems and nozzles. Standard pressure range from 50-100 bars but high pressure versions are available from 20-7000 bars.

**BC PUMPS LTD** 29-30 Kernan Drive, Loughborough, Leicestershire, LE11 0JF, UK, Tel: +44-509-231872, Telex: 342185, Fax: +44-509-215228, Contact: Debbie Kendall. Manufacturers of centrifugal pumps for water and sewage applications. Ranges include DIN2455 water pumps, borehole, multistage, horizontal and vertical sewage, submersible sewage and drainers.

**BELZONA MOLECULAR LTD** Claro Rd, Harrogate, N Yorkshire, HG1 4AY, UK, Tel: +44-423-67641, Telex: 629497, Fax: +44-423-505967, Contact: Mrs Cooper. Maintenance product and services for the repair and refurbishment of pumps, valves and associated equipment. Accepted supplier of coatings and systems for protection against corrosion and chemical attack on concrete.

**BERESFORD PUMPS** Burnsall Rd, Canley, Coventry, CV5 6BN, UK, Tel: +44-203-78412, Telex: 317298, Contact: Mr Murray. Manufacturers of centrifugal self-priming pumps in cast iron, bronze or stainless steel, sump and cellar drainage pumps. Also water and chemical pumps of polypropylene construction.

**BIWATER PUMPS** Millers Rd, Warwick, CV34 5AN, UK, Tel: +44-926-411740, Telex: 317473, Fax: +44-926-410740, Contact: Mr Chatterton. Manufacturers of pumps - both solids - handling sewage pumps and submersible waste water pumps. Build pumps into complete pumping stations including mechanical and electrical. Manufacturers of compatible control panels.

**BLUE WHITE INDUSTRIES** 14931 Chestnut St, Westminster, CA, 92683, USA, Tel: +1-714-893-8529, Contact: Robin Gledhill. Manufactures Chem-feed® Diaphragm type metering pumps, Flexflo peristaltic metering pumps, and Scamp® Submersible metering pumps, as well as a full line of hand machined and injection molded flowmeters.

**BRIMOTOR LTD** Clarence Works, 30a Church Rd, Tunbridge Wells, Kent, TN1 1JP, UK, Tel: +44-892-37588, Telex: 95446 BIMOTR G, Contact: Mr Mossery. Manufacturers of portable, mobile and mains failure generating sets, and portable mobile floodlighting units. Manufacturers of self-priming and diaphragm pumps.

# PLANNING THE PRESENT TO ADMINISTER THE FUTURE THE FUTURE IS IN THE ENVIRONMENT.

GRUPPO ACQUA IS THE FUTURE IN THE ENVIRONMENT:  
A BIG SOCIETY WITH SEVEN COMPANIES (THE SUBSIDIARIES ARE  
E.M.I.T. ERCOLE MARELLI IMPIANTI TECNOLOGICI AND EMAS ERCOLE MARELLI  
SERVIZI TECNOLOGICI) WHICH OPERATE IN THE PROJECT SECTOR. PRODUCTION,  
ADMINISTRATION OF PLANTS AND PUBLIC AND PRIVATE SERVICES, FOR DEPURATION, UTILIZATION,  
WATER, AIR & SOIL TREATMENT, SOIL RESEARCH FOR ALTERNATIVE RESOURCES & CLEAN ENERGY. GRUPPO ACQUA IS  
SITUATED IN MILAN. COMMUNICATION AND IMAGE HEADQUARTERS IS OPEN TO ANYONE WHO IS INTERESTED IN ACQUIRING INFORMATION  
AND SPECIFIC DOCUMENTATION.



Acqua S.p.A.  
Via Tortona, 33. 20144 Milano  
Tel. (02) 4299.513  
Telex 330883 ACQUA I  
Telefax (02) 4120310  
Partita IVA 1869020154

## PUMPS- CENTRIFUGAL, AXIAL FLOW AND GENERAL

**C BANCROFT PIPELINE LTD** Pellon Lane, Halifax, W Yorks, HX1 5BG, UK, Tel: +44-422-64121, Telex: 517743, Fax: +44-422-53513, Contact: Phil Sharp. Bancroft Pipeline are distributors of pipeline equipment to water authorities and industrial users both in the UK and overseas. Their range includes: pumps, valves, control equipment and pipework in various materials.

**CAPITAL ENGINEERING SERVICES** Unit D4, Mailmech Industrial Estate, 83 Copeth Cope Rd, Beckenham, Kent, UK, Tel: +44-1-658-2243, Contact: Ms Nield. Capital Engineering produce a full range of pumps, both manually operated and mechanical ranging from 1/2 horse power to 1000s of horse power for drawing water from wells and bore holes etc.

**CAPRARI SpA** Emilia Ovest 900, MO, 41100, Italy, Tel: +39-59-330-533, Fax: +39-59-338153, Contact: Cloudia. Leading European manufacturers of: electric submersible pumps for 4" to 14" wells, deep well turbine pumps, vertical and horizontal electric monobloc pumps, single and multistage centrifugal pumps and P. T. O. pumps.

**CAT PUMPS CORPORATION** 1681 94th Lane N E, Minneapolis, MN, 55434, USA, Tel: +1-612-780-5440, Telex: 290276, Fax: +1-612-780-2958, Contact: Darla Thompson. Manufacture high pressure, triplex piston and plunger pumps, motorized pump units, corrosion resistant and 316 stainless steel pumps and complete line of complementary systems accessories an available through international network of sales and service reps.

**CHAMPENOIS SA** Chamouilley, Eurville, F-52410, France, Tel: +33-25-55-59-55, Telex: 840914, Contact: Mr Champenois. Manufacture small centrifugal pumps.

**CHEM-TECH INTERNATIONAL** P O Box 1476 92 Bolt St, Lowell, MA, 01853, USA, Tel: +1-617-453-4020, Telex: 947-156. Manufacture chemical pumps and related accessories and complete systems used for industrial, home and agricultural applications.

**CHIMMASHEXPOR** 25 Bezbozhny Per, Moscow, 129869, USSR, Tel: +7-288-36-90, Telex: 411032. Soviet Foreign Trade Association Chimmashexport was established in 1987 as the sole supplier of machinery and equipment for the chemical and petrochemical industry. Exports plant and equipment, oil, petrochemical, pulp and paper industries, cryogenic plant, air and gas compressors, pumps, industrial valves and fittings.

**CLASSEN & CO LTD** Horton Close, West Drayton, Middlesex, UB7 8JA, UK, Tel: +44-895-443206, Fax: +44-895-441274, Contact: Mr Thomas. Classen and Co are distributors for a full range of multiple application pumps from Hanning & Kahl and Grindex submersible electric pumps from 1-50hp, and Telstar float regulators.

**CLAYTON SON & CO LTD** Moor End Works, Hunslet, Leeds, West Yorkshire, LS10 2BH, UK, Tel: +44-532-705226, Fax: +44-532-760372, Contact: Mr R H Thomson. Welded steel pumps, 450mm diameter and over. All UK standards API-511 (monogram authorized, all coatings). Well casing tubes, surge and contact vessels. Floating roof digestors and gas holders.

**CLEGHORN WARING & CO (PUMPS) LTD** 9-15 Hitchin St, Baldock, Hertfordshire, SG7 6AH, UK, Tel: +44-462-893838, Telex: 826832, Fax: +44-462-894719, Contact: W Cleghorn. Specialist distribution of centrifugal and positive displacement pumps, including self priming types, for low pressure water transfer.

**COLLEY NOCKOLDS LTD** 37 Bowater Rd, London, SE18 5TF, UK, Tel: +44-1-855-6593, Fax: +44-1-854-8421, Contact: Mr Parry. Distributors of a wide range of both motorised and hand operated transfer pumps.

**CONDRILL AB** Sveavagen 83 113 50 Stockholm Sweden Tel: +46-8-349560, Telex: +12336, Fax: +46-8-316762

**CORROCOAT SERVICES LTD** Forster Rd, Leeds, West Yorkshire, LS10 1PW, UK, Tel: +44-532-770051, Telex: 557243, Fax: +44-532-760700, Contact: Paula Carter. Carry out engineering, overhauls and coating on pumps, valves and ancillary equipment. The Corrocoat Fluigiude system can be incorporated to give increases in efficiency of up to 8% on new/refurbished pumping installations.

**CRANE BVMI** Shaw Rd, Bushbury, Wolverhampton, West Midlands, WV10 9NN, UK, Tel: +44-902-20496, Telex: 338171, Fax: +44-902-27167, Contact: Mr Richard Smyth. Manufacturers of strainers (forged or cast), pumps-vertical in line, vertical spindle, end suction and valves - bellow sealed design, globe or gate. All available in standard or exotic materials and of assured quality conforming to most specified requirements. B55882, B5570 parts 1,2,3 and MOD Aqap series.

**CROWN - PACIFIC INTERNATIONAL** 18001 South Mitchell, Irvine, CA, 92714, USA, Tel: +1714-660-1798, Telex: 18100, Fax: +1714-660-9229, Contact: Mr Richard Mahoney. Suppliers of pumps and related equipment.

**CT (LONDON) LTD** Westfield House, Westfield Rd, Guildford, Surrey, GU1 1EL, UK, Tel: +44-483-502020, Telex: 859284, Fax: +44-483-502953, Contact: Mr Noble. CT (London), long established in fluids handling, can offer a variety of valves, pumps, pipe supports, gauges, chemical dosing and spray equipment to solve your water handling problems. Call us!

**DAVEY PRODUCTS PTY LTD** 118 Atkinson St, Oakleigh, Victoria, 3166, Australia, Tel: +61-3-568-1655, Telex: AA139654, Fax: +61-3-568-4551. Manufacturers and marketers of pressure systems, end suction pumps - domestic, commercial and farm, swimming pool filters and pumps, spa bath pumps, engine driven pumps and pressure tanks.

**DAWSON DOWNIE LAMONT LTD** Elgin Works, North Elgin St, Clydebank, Strathclyde, G81 1YF, UK, Tel: +44-41-952-2271, Telex: 777857, Fax: +44-41-952-9088, Contact: Mr Irving. Dawson Downie Lamont Ltd have been manufacturing reciprocating pumps since 1905. These pumps are in use in countries throughout the world for water, sewage, oil, petrochemical, soap pastes and other uses.

**DEAN PUMP DIV MET-PRO CORP** 6040 Guion Rd,

## PUMPS- CENTRIFUGAL, AXIAL FLOW AND GENERAL

Indianapolis, IN, 46254, USA, Tel: +1-317-293-2930. Manufacture and sell single-stage, single suction pumps.

**DEMPSTER INDUSTRIES INC** 711 South Sixth St, Beatrice, NB, 68310, USA, Tel: +1-402-223-4026, Telex: 701447, Fax: +1-402-228-4389, Contact: Dean Kilgore. Manufacturers of pumps, water pumping windmills, hand pumps, (including the Mark II pump) pump cylinders and pump rods.

**DIA-METER PUMPS LTD** Unit 22, Bridge Industries, Broadcut, Fareham, Hampshire, PO16 8SX, UK, Tel: +44-329-233542, Telex: 86736 Sotex G Dia-meter, Contact: Mr Carver. Manufacturers of diaphragm additive pumps for water treatment.

**DIAS INC** P O Box 3188, Kalamazoo, MI, 49003, USA, Tel: +1-616-344-1008. Manufactures pumps and pump timer combinations that are used with water treatment chemicals to treat many residential, industrial and commercial applications. (WT)

**DRESSER PLEUGER UNTERWASSERPUMPEN** PO Box 701320, Friedrich-Ebert-Damm 105, Hamburg 70, D-2000, West Germany, Tel: +49-40-69-460, Telex: 21-32-75, Fax: +49-40-69-46-242, Contact: Herr Jabs. Modern industry requires more water than all residential users put together. And often the water is corrosive, hot or polluted. But this is no problem for Pleuger units as they are specially constructed to perform well under these conditions.

**DUIJVELAAR POMPEN BV (DP INDUSTRIES)** Kalkovenweg 52, Alphen Aan Den Rijn, LK, 2401, The Netherlands, Tel: +31-1720-37034, Telex: 39691, Fax: +31-1720-33137, Contact: Ms Vogel. Duijvelaar pumps are used to supply drinking water, for irrigation in greenhouses, as jockey pump, boilerfeed pump, on car wash installations, for air conditioning and many other purposes. One of the most important features of the Duijvelaar pumps is that they are mainly made of stainless steel, thus combining durability with high efficiency.

**EBARA CORPORATION** 11-1 Haneda Asahicho, Ohta-Ku, Tokyo, 144, Japan, Tel: +81-3-743-67-16, Telex: EBARA TYO 322988, Fax: +81-3-745-3576, Contact: Mr R D Jones. EBARA is probably one of the largest specialist pump companies in the world 4000 employees manufacturing in Japan, Indonesia and Singapore a comprehensive range of pumps for all applications.

**ELDEX LABORATORIES INC** 831 Bransten Rd Unit L, San Carlos, CA, 94070, USA, Tel: +1-415-592-9270. Manufacturer of precision high pressure metering pumps and accessories for liquid chromatography.

**ENSIVAL (ATELIERS DE CONSTRUCTION D') SA** 44 Rue Hodister, Pepinster-Wegnez, 4851, Belgium, Tel: +32-87-46-01-11, Telex: 49058 Pompsi B, Fax: +32-87-46-04-41. A Belgian manufacturing company with over 60 years' experience in light/heavy pumps, Ensival is a leading expert in the development of water management.

**ENVIROCLEAN SYSTEMS LTD** South Tyne Works,

Haltwhistle, Northumberland, NE49 9DE, UK, Tel: +44-498-20556, Telex: 859215, Fax: +44-498-21480, Contact: Mr Phillip. Enviroclean Systems manufacture and distribute an extensive range of high pressure pumping rigs for many duties including: central cleaning systems, high pressure shower dust suppression, reverse osmosis etc.

**FABRICA TURBINE E CALDAIE FTC** Legnano SRL, Piazza Monumento 12, Legnan, (Milan) 20025, Italy, Tel: +0331522111, Telex: +330661/314385 F TOSI, Fax: +0331593321. Fabrica Turbine E Caldaie - FTC Legnano SRL (Franco Tosi Group) represents a wealth of know-how and experience in the fields of generation, conversion, utilisation and recovery of energy in its various forms, as well as in other areas such as sea water desalination, ship propulsion and in general industrial plants, where equipment produced by the company finds a field of application.

**FARROW (A DIVISION OF WRIGHT RAIN LTD)** Crow Arch Lane, Ringwood, Hampshire, BH24 1PA, UK, Tel: +44-425-472251, Telex: 41206, Fax: 44-425-472258, Contact: Norman Murphy. A range of small to medium size pumps available as tractor PTO, diesel or electrically driven. The diesel units are available on two-wheeled trolleys or mounted on skid base. Also available is a full range of pump control and engine protection equipment.

**FMC CORP** 5601 E Highland, Jonesboro, AR, 72401, USA, Tel: +1-501-935-1970. Plunger, piston pump manufacturer since 1884 with many innovations, patents in use. Manufactures complete line from 5 to 225 gpm with pressures to 5000 psi. (WT)

**FORDWATER PUMPING SUPPLIES LTD** 49-53 Stratford Rd, Birmingham, West Midlands, B11 1RQ, UK, Tel: +44-21-772-8336, Telex: 335807, Contact: Brian Powell. Supply and maintain all types of pumps.

**FYBROC DIV MET-PRO CORP** 235 Township Line Rd, Hatfield, PA, 19440, USA, Tel: +1-215-723-8155. Corrosion resistant fiberglass pumps - horizontal, vertical and cantilever configurations - capacities to 4,000 gpm - heads to 300 ft. Also recessed impeller pumps that handle many solids up to 6-in diameter.

**GARBARINO SpA** Via St Lazzaro 3, Acqui Terme, AL, 15011, Italy, Tel: +39-144-58671, Telex: 212158, Fax: +39-144-55260, Contact: John Lilley. Garbarino are manufacturers of centrifugal, self-priming, gear and rotary pumps (constructed to NATO and Italian Military standards) which are supplied worldwide to the naval, industrial and chemical sectors.

**GELBER PUMPS INC** 3721 W Morse Avenue, Lincolnwood, IL, 60645, USA, Tel: +1-312-673-5800. Manufacturer/distributor of wide variety of pumps and related equipment including filters, fluid agitators, instrumentation and controls.

**GENERAL PUMP - US** 3380 Highway 149, Eagan, MN, 55121, USA, Tel: +1-612-454-6500. One of the world's largest manufacturers of triplex plunger pumps with 73 models - all ceramic plungers, stainless steel valves

# PERFORMANCE UNDER PRESSURE



A/S De Smithske is a leading Danish pump manufacturer situated close to Aalborg International Airport in the northern part of Denmark. The company is more than 150 years old, however, with a young mind, a new factory, and up-to-date machinery.

The product programme is designed to meet the demands for water pumping within very wide limits. The programme consists of the recently developed three individual series of Modular pumps. The Modular S, H, and V pumps form a unique system and contain the absolute minimum of different parts which, consequently, keeps the number of spare parts necessary to cover the three types at a minimum, thus aiding a minimum stockholding, prompt deliveries, and competitive prices.

**The DESMI Modular S** series consists of self-priming centrifugal pumps, priming on the diffuser principle. This priming principle enables the pump to carry a mixture of liquid and air. The priming is not dependent on external valves or other mechanical elements.

The Modular S pumps can be supplied with free shaft end, mounted on base plate with electric or hydraulic motor, petrol or diesel engine. They can also be fitted with disengaging clutch and V-belt pulley.

Capacity range: 1-400 m<sup>3</sup>/h  
Pressure range: 1-150 mWC

**The DESMI Modular H** is a *non self-priming* end-suction pump, normally in horizontal but also available in vertical execution. The pump is a further development of the above S type, based on the same components. Can be delivered in monobloc versions.

Capacity range: 8-300 m<sup>3</sup>/h  
Pressure range: 3-100 mWC

**The DESMI Modular V** is a vertical in-line pump, also a member of the Modular family. Is available in monobloc versions or mounted

with spacer coupling to ensure easy access for service and maintenance.

Capacity range: 8-350 m<sup>3</sup>/h  
Pressure range: 3-140 mWC

Still very popular are the highly-reputed **DESMI SA** pumps, which are sturdy, versatile, self-priming pumps. Through many years of work they have proved DESMI a manufacturer of high reputation for self-priming centrifugal pumps.

The SA pumps are designed with open impellers including a replaceable wear plate. This means that the pumps can carry both solids and impurities along with the actual fluid.

Capacity range: 1-450 m<sup>3</sup>/h  
Pressure range: 1-100 mWC

**The DESMI SL** pump series consists of vertical in-line centrifugal pumps, which are known as reliable pumps with low NPSH values and high efficiency.

The SL pumps are radially split and can be supplied with three different coupling types depending on the number of revolutions, capacity and demand for compact installation dimensions.

Capacity range: 8-1400 m<sup>3</sup>/h  
Pressure range: 2-200 mWC

**The DESMI PG range of gearboxes** for vertical turbine pumps are units intended for assembling on the discharge head of vertical turbines, axial flow and helical propeller pumps for irrigation, water supply, and industrial pumping service.

Capacity range: 20-222 HP at 1760 rpm vertical shaft.

On the basis of many years of experience in manufacturing right-angle gear drives, DESMI offers you a high quality product which will operate to your satisfaction. □

# DESMI quality products

Since the end of the thirties A/S De Smithske – colloquially called Desmi – has manufactured centrifugal pumps and right-angle gearboxes.

The technological reputation of the DESMI products is legendary and not without reason. Our demands for the highest possible quality and technology are not just empty words... They are the basis of our existence.

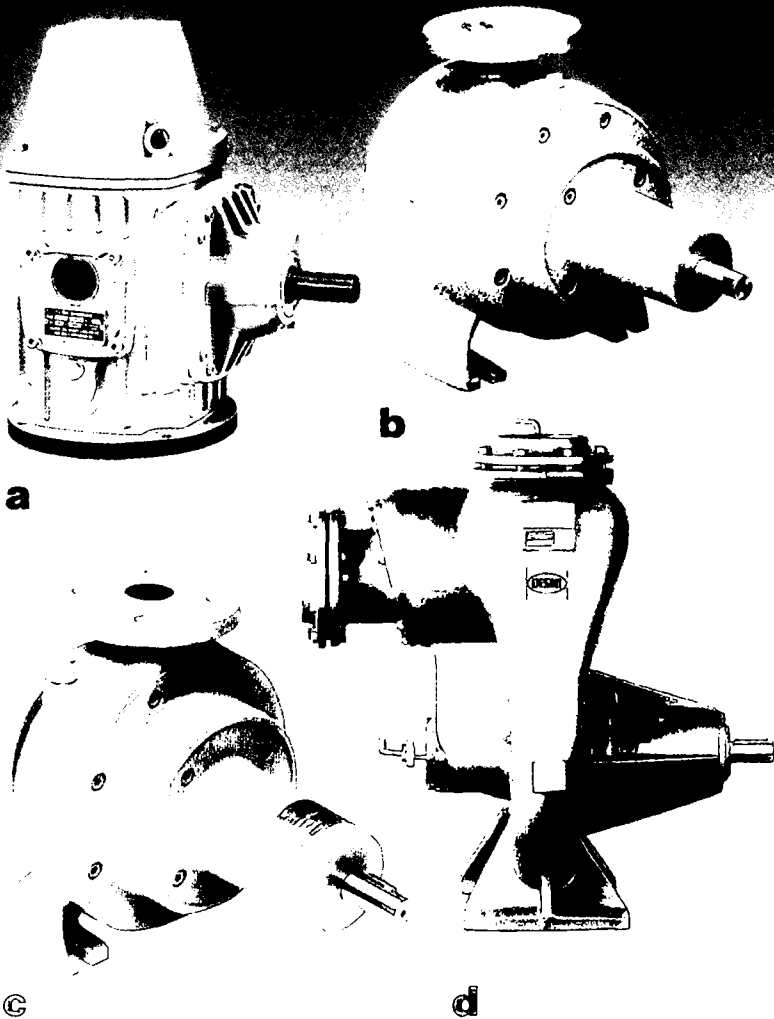

®

**A/s De Smithske**

Tagholm 1, P.O. Box 205  
DK-9400 Nørresundby – Denmark  
Tel. + 45 8 17 81 11  
Telex: 69620 desmi dk  
Telefax: + 45 8 17 54 94  
Cable: desmidk

**a**  
DESMI Right-Angle Gearbox.  
A first-class product with long life.

Through the years DESMI has produced more than 375.000 gearboxes. Capacities between 15 HP and 270 HP.

**b**  
DESMI MODULAR S Self-priming Centrifugal Pump.  
A study of modular construction.

An economical and reliable pump.  
Capacity range up to 400 m<sup>3</sup>/h.  
Pressure range up to 150 mWC.

**c**  
DESMI MODULAR H Non Self-priming Centrifugal Pump.

Developed according to the design of the future.  
Can be supplied in Monobloc execution.  
Various combinations of assembly.  
Same capacity and pressure range as MODULAR S.

**d**  
DESMI SA Self-priming Centrifugal Pump.  
Designed with open impeller. Cast iron or bronze execution.

A sturdy and versatile pump type.  
Capacity range up to 450 m<sup>3</sup>/h.  
Pressure range up to 100 mWC.

## PUMPS- CENTRIFUGAL, AXIAL FLOW AND GENERAL

---

forged bronze, stainless steel, aluminum, bronze heads. Flow rates from one to 43 gpm and pressures 100 to 6000 psi. Close-coupled motor/pump assemblies and a complete line of high quality accessories to match all pumps. (WT)

**GIANT PRODUCTS CO** 900 N Westwood Avenue, Toledo, OH, 43607, USA, Tel: +1-419-531-4600. Has one of the widest selection of accessories and high pressure triplex piston/plunger pumps, including direct drive models. Equipment is built to give years of maintenance-free performance. (WT)

**GIRDLESTONE PUMPS LTD**, Melton, Woodbridge, Suffolk, IP12 1ER, UK, Tel: +44-3943-3777, Telex: 98461, Fax: +44-3943-6733, Contact: Mrs Nelson. Girdlestone specialise in the design and manufacture of pumps and pumping equipment for the chemical, oil and gas, marine and brewing industries.

**GOULDS PUMPS INC** 240 Fall St, Seneca Falls, NY, 13148, USA, Tel: +1-315-568-2811. Manufacture over 60 different pump models.

**GORMAN-RUPP INTERNATIONAL** PO Box 1217, Mansfield, Ohio 44901-1217 USA Tel: +7551011, Telex: +987422, Fax: +4197551266. The Gorman-Rupp Company is a leading manufacturer of self-priming centrifugal pumps for the construction, industrial, sewage, agricultural, petroleum, fire, municipal and OEM markets. Gorman-Rupp also manufactures submersible, diaphragm, rotary gear and straight centrifugal pumps, as well as fibreglass enclosed pumping lift stations. Pumps range in size from 1 1/2" to 12" with solids handling capability to 3" spherical solids, depending on the size of the pump. Special metals are also available, with a variety of gas or diesel engines, electric motors and controls.

**GRAHAM PRECISION PUMPS LTD** The Forge, Congleton, Cheshire, CW12 4HQ, UK, Tel: +44-260-274721, Telex: 667383, Fax: +44-260-276965, Contact: John Trowbridge. Specialist manufacturers of liquid ring and rotary vane vacuum pumpsets and ejectors, centrifugal pumps, twin pumps, inline, horizontal and vertical multi-stage pumps, self priming, gear and rotary vane pumps.

**GRUNDFOS INTERNATIONAL A/S** Poul Due Jensens Vej, Bjerringbro, DK-8850, Denmark, Tel: +45-6681-400, Telex: 60731 GFOSDK, Fax: +45-6-684472, Contact: Mr Rasmussen. Manufacturers of water pumps, domestic circulators, industrial circulators, booster, boiler feed and general service pumps, sump pumps, deep well submersible pumps, in line and end suction pumps.

**GRUNDFOS PUMPS LTD** Grovebury Rd, Leighton Buzzard, Bedfordshire, LU7 8TL, UK, Tel: +44-525-850000, Telex: 825544, Fax: +44-525-850011, Contact: Mr Styles. Grundfos manufacture a wide range of hot and cold water pumps for applications including domestic and commercial heating, water boosting and supply, liquid transfer, dewatering and cooling. Details of the complete range are available in a handy pocket-size publication entitled 'Pump Selection Guide'.

**HARRINGTON INDUSTRIAL PLASTICS** 14480 Yorba, Chino, CA, 91710, USA, Tel: +1-714-597-8641. Specializes in ultrapure and corrosion resistant plastic liquid handling. Pipe fittings, valves, pumps, tanks, filters and instrumentation.

**RICHARD HILL PUMPS LTD** Brooke Rd, Ridlington, Leicestershire, LE15 9AN, UK, Tel: +44-572-823385, Telex: 34694, Contact: Richard Hill. Manufacturers of self-priming centrifugal pumps close coupled to petrol and diesel engines and electric motors. Widely used for irrigation systems and general industrial applications.

**H R HOLFELD (PUMPS) LTD** 65 Carshalton Rd, Sutton, Surrey, SM1 4LH, UK, Tel: +44-1-661-0719, Telex: 28650, Fax: +44-1-642-0454, Contact: James Potter. Holfeld Pumps design and supply advanced pumping technology and the Holpak range of pump sets and pressure booster systems to specific customer requirements covering a wide range of applications including building services, irrigation, water and waste treatment and fire prevention.

**THE HOTSY CORP** 21 Inverness Way F, Englewood, CO, 80112, USA. Manufactures 15 models of corrosion resistant pumps for use in reverse osmosis systems. One-15 gpm, up to 3000 psi. Pumps available in pulley belt or direct drive configurations. (WT)

**HOVAL FARRAR LTD** Northgate, Newark, Nottinghamshire, NG24 1JN, UK, Tel: +44-636-72711, Telex: 37164, Fax: +44-636-73532, Contact: Peter Neers. Birral Pumps manufactured in Switzerland from the highest quality materials to exacting standards. Birral can design and build to specific requirements or supply standard pumps from its large stocks. The range is from small water circulating pumps to deep well submersibles to pressure boosting and water feed pumps, sewage pumps, control systems and special designs.

**HUBERTS BV** PO Box 251, Veghel, AG, 5460, The Netherlands, Tel: +31-41-30-66811/41-30-42275, Telex: 74645, Fax: +31-4130-42029, Contact: Ms Ira Turner. Import/export wholesale company in mainly wood-working and metalworking machines for semi-industrial purposes: metal lathes, wood lathes, bench grinders, (pedestal) drilling machines, air tools, compressors, water pumps, electric motors, band sawing machines, metal sawing machines, welding equipment.

**HYDRAINER PUMPS LTD** Norwood Industrial Estate Rotherham Rd, Killamarsh Sheffield, South Yorkshire, S31 8HB, UK, Tel: +44-742-484868, Fax: +44-742-510136. The Hydrainer range covers a complete spectrum of pumping applications with various power pack and a family of pumps which cater for flows up to 1630 gpm, head capability to 250 ft and solids handling to 2 3/4" solids. All pumps up to and including the 4" unit can be handled by one man. The unique concept of the Hydrainer power pack offering variable speed to the impeller significantly improves the overall pumping efficiency. Furthermore the Hydrainer will consume only 1/3 of the fuel used by a conventional end suction pump.

**HYPRO CORPORATION** 375TH Fifth Avenue NW,



# NASOSMASH FIRM

The range of equipment the firm Nasosmash of V/O Chimmashexport is dealing with comprises more than 4 thousand types and modifications of pumps and spare parts for them. The Soviet-made pumps are known for their reliability, efficiency, simplicity of assembly and easy maintenance.

Besides the firm Nasosmash exports industrial fittings for water, steam, petroleum products and gases which, depending on their destination are made of cast iron, steel, stainless steel, non-ferrous metals and titanium. For handling chemically active media the firm offers cast iron fittings coated with hard steel and flanges faced with polyethylene, fluoroplastic materials or enamels.

## Export programme

Water pumps:

- centrifugal pumps
- cantilever pumps
- vortex pumps
- well and artesian-well pumps
- axial-flow pumps
- suction dredge, sand and sludge pumps
- pumps for domestic needs

Pumps for electric power industry:

- supply line pumps
- feed pumps
- circulating pumps
- condensate pumps.

Pumps for chemical industry.

Special pumps.

Industrial pipe-line valves.

Petroleum pipe-line valves.

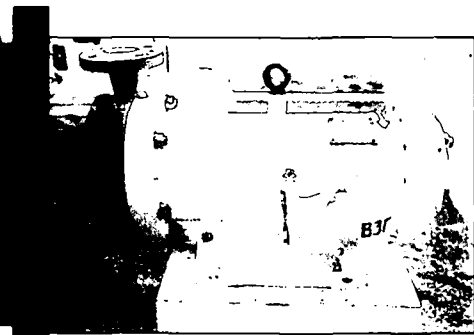
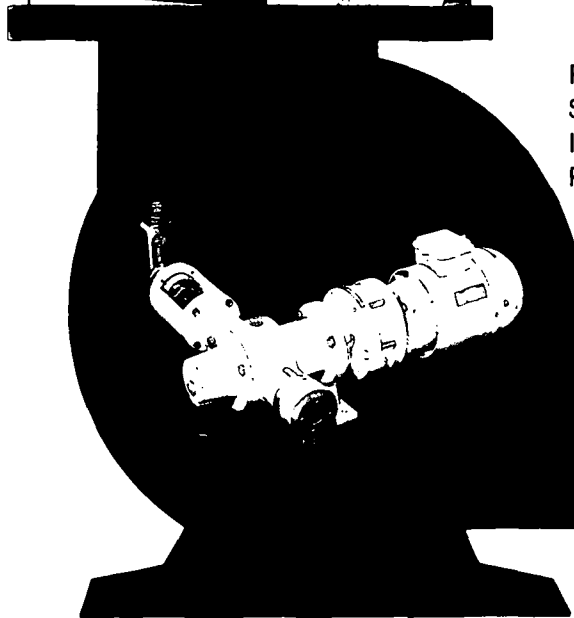
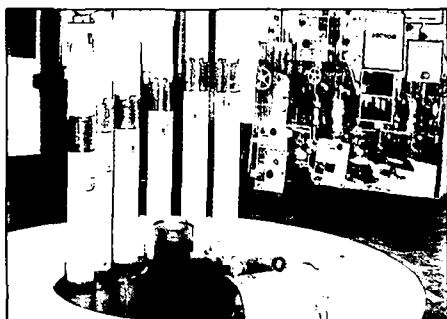

For more information, please apply to:

V/O CHIMMASHEXPORT 35, Mosfilmovskaya Ul. 117330 Moscow, USSR  
Tel. 143-86-63 Telex 411068, 411228

## PUMPS- CENTRIFUGAL, AXIAL FLOW AND GENERAL

New Brighton, MN, 55112, USA, Tel: +1-612-633-9300, Telex: 4310109, Fax: +1-612-633-6864, Contact: Mr Dean Johnson. Manufacturer of pumps and fluid handling accessories for high pressure cleaning, spraying and general liquid transfer. Roller pumps, centrifugal pumps and diaphragm pumps in a range of sizes.

**INDUSTRIAL FILTER & PUMP MFG CO** 5900 Ogden Avenue, Cicero, IL, 60650, USA, Tel: +1-312-656-7800, Fax: +1-312-656-7806, Contact: Charles Movotny. Manufacturer of filters, demineralizers and pumps used in the water treatment industry.

**INTERSIGMA EXPORT AND IMPORT CORPORATION OF SIGMA CONCERN** POB 1111, Praha 1, Vaclavske nam 60, 111 87, Czechoslovakia. Exports: pumps, pumping equipment, irrigation equipment, industrial valves, complete water management plants, pumping stations, sewage water purifying plants, water treatment plants and industrial pipings.

**INTERTUB GERMANIA GmbH** Industriestrasse 7, Dogern, D-7891, West Germany, Tel: +49-7751-2106, Telex: 792219, Fax: +49-33-42701, Contact: Herr Fliet. Manufacturers and distributors of submersible pumps, water pumps and vacuum pumps for a variety of applications.

**JLC PUMPS & ENGINEERING CO LTD** Oxgate Farm Works, Coles Green Rd, London, NW2 7EX, UK, Tel: +44-1-452-4081, Telex: 82317, Contact: Mr Catton. All types of pumps for all purposes.

**JOBSON BECKWITH LTD** Treadway House, 26-30 Cubitt St, London, WC1X 0LR, UK, Tel: +44-1-833-0395, Telex: 940-96319, Fax: +44-1-837-5673, Contact: Mr D Goodson. Jobson Beckwith manufacture/distribute a range of positive displacement pumps for handling viscous liquids. Centrifugal, hand and flexible impeller pumps are also available, as is installation, servicing and pumping systems.

**LABOUR PUMP CO LTD (ALCORN DIVISION)** Denington Estate, Wellingborough, Northants, NN8 2QL, UK, Tel: +44-933-225080, Telex: 31428, Fax: +44-933-440032, Contact: Les Massey. The "Alcon" pump range companies self-priming centrifugal, end suction and diaphragm pumps. Supplied mainly to the agricultural, horticultural, building contracting and civil engineering industries. Outputs range up to 4000 lit/min and heads to 55 metres.

**GEORGE LANCASTER LTD** 501 Ipswich Rd, Slough Trading Estate, Slough, Berkshire, SL1 4EP, UK, Tel: +44-753-692527, Telex: 846395 REMEX G, Fax: +44-753-73235, Contact: Mr Moghul. Manufacturers of float switches. Suppliers of pumps and pump equipment.

**LIQUID METRONICS INC** 19 Craig Rd, Acton, MA, 01720, USA, Tel: +1-617-263-9800. Manufactures metering pumps.

**LITTLE GIANT PUMP CO** 3810 No Tulsa St, Oklahoma City, OK, 73112, USA, Tel: +1405-947-2511, Fax: +1405-942-2285, Contact: V X Smith. Manufacturer of fractional HP centrifugal pumps, submersible and non-

submersible. Used in water and corrosive chemicals. Specialty pumps also for effluent and sewage.

**GEORGE MELLER LTD** Orion Park, Northfield Avenue, London, W13 9SJ, UK, Tel: +44-1-579-2111, Telex: 27800/919153, Fax: +44-1-579-7326, Contact: Mr Ansari. George Meller Limited is a supplier of equipment to the process industries. Specifically for the water industry we can supply flowmeters, valves and pumps.

**METRIX ENGINEERING** Blagdon St, Sheffield, S25 0QS, UK, Tel: +44-742-767921, Telex: 547621, Contact: R Smith. Manufacturers of a range of centrifugal and heavy-duty diaphragm pumps and associated equipment for the water and sewage industry.

**MILTON ROY CO** 201 Ivyland Rd, Ivyland, PA, 18974, USA, Tel: +1-215-441-0800, Telex: 4761138, Fax: +1-215-441-8620, Contact: Jack Craneg. The coagulant control centre represents the best available technology for coagulant/flocculant dose monitoring and automatic control in treatment of raw surface waters, waste sludge dewatering and process water.

**MILTON ROY COMPANY HARTELL DIVISION** 70 Industrial Drive, Ivyland, PA, 18974, USA, Tel: +1-215-322-0730. Manufacturer of chemical metering pumps.

**FRANK W MURPHY LTD** 22 Blackmoor Rd, Verwood, Dorset, BH21 6AY, UK, Tel: +44-202-827223, Telex: 418388, Fax: +44-202-827890, Contact: John Burton. Designers and manufacturers of reliable and simple diagnostic instrumentation and control systems for pumps, over 50 years' experience in providing reliable and simple control systems.

**F E MYERS A PENTAIR COMPANY** 1101 Myers Parkway, Ashland, Ohio, 44805-1923, USA, Tel: +1-419-289-1144, Telex: 98-7443, Fax: +1-419-289-6658. Today, with more than 118 years of industry experience, F E Myers, a Pentair Company, manufactures submersible and centrifugal jet pumps for residential water systems, environmental waste handling pumps and systems, sump and sewage pumps, reciprocating and centrifugal industrial pumps, plus a wide range of repair part and accessories.

**MYSON PUMPS & MOTORS LTD** Pellen Lane, Halifax, West Yorkshire, HX1 5QL, UK, Tel: +44-422-60201, Telex: 51101 wright G, Fax: +44-422-51892, Contact: Alan Richardson. In-line and centrifugal pumps for pumping of water and similar fluids, sizes up to 200mm-75kW.

**NATIONAL ENGINEERING LABORATORY** East Kilbride, Glasgow, G75 0QH UK Tel: +0355220222, Telex: +777888, Fax: +0355236930. The National Engineering Laboratory (NEL) carries out research, testing and consultancy in the field of mechanical engineering including centrifugal, mixed-flow or axial pumps. NEL has facilities to test such pumps utilising dynamometers with power up to 260kW. Once particular facility is available which can test high-power pumps (up to 3mw) at flowrates up to 1.0m<sup>3</sup>/s and head of 4250m.

**NEI - APE LTD LEE-HOWL (A DIVISION OF BEL-**



## PUMPS- CENTRIFUGAL, AXIAL FLOW AND GENERAL

**LISS & MORCROM** Icknield Square, Birmingham, B16 0QL, UK, Tel: +44-21-454-3531, Telex: 337507, Fax: +44-21-455-8607, Contact: Dawn Lamb. Pump range includes submersible turbine borehole pumps, mixed flow bowl pumps, split casing water pumps, drywell and submersible sewage and solids handling pumps. Capacities 10 l/s to 350 l/s.

**NEPTUNE CHEMICAL PUMP CO** PO Box 247, Lansdale, PA, 19446, USA, Tel: +1-215-699-8701. Manufacturer of mechanical and hydraulic diaphragm-type and piston-type metering pumps, mixers and complete chemical feed systems. (WT)

**NEW HADEN PUMPS LTD** New Haden Works, Cheadle, Stoke-on-Trent, Staffs, ST10 2NW, UK, Tel: +44-538-752351, Telex: 36142, Fax: +44-538-756569, Contact: Mr Bates. New Haden Pumps are leaders in the manufacture of systems for water supply, irrigation, sewage handling effluent treatment and sludge pumping. A complete service is available for any of the above.

**NIJHUIS PUMPS** PO Box 102, Parallelweg, De Winterwyh, 47102, The Netherlands, Tel: +31-5430-16561, Telex: 44185, Contact: Mr Jacobs. Involved in international business. Irrigation, water and sewage treatment, bio-protection and booster stations. Also produce surgical turbine pumps, mixed flow pumps, induction pumps, horizontal split case pumps.

**OCHSNER GESELLSCHAFT M b h & CO P O BOX 60**, Oberfeldstrasse 8, I.inz, A-4024, Austria, Tel: +43-732-41-3-58, Telex: 02-1439 ochsnr a. For over 100 years Ochsner have produced pumps and compressors for the chemical, petrochemical and refining industries and for use in irrigation plants. The line-up includes water and waste water pumps (also pumps for the heavy industry) displaying the following characteristics: delivery up to 8,000 m<sup>3</sup>/h, lift up to 700m, drive capacity up to 1,500kW. Materials used are alloyed and unalloyed metals depending on operating conditions. Rotary compressors for charging biogas motors and water compressors.

**OSMONICS INC** 5951 Clearwater Drive, Minnetonka, Minnesota, 55343 USA Tel: +6129332277, Telex: +290847, Fax: 6129330141. Osmonics manufactures TONKAFLO® multi-stage centrifugal and American air operated diaphragm pumps. TONKAFLO pumps deliver 2-300 gpm at 50-600 psig with one pump and up to 1000 psig with two pumps in series. Materials of construction are stainless steel and Noryl. American pumps offer capacities from 0 to 120 gpm. Made of pure TEFLON PTFE or VIRGIN POLYPROPYLENE with no metal to liquid contact.

**P & S WATER INDUSTRIES INC** 680 Waterloo St, London, Ontario, N6A 4N8, Canada, Tel: +1-519-672-0330. Manufacture of domestic water pumps and wastewater treatment equipment for use in the home and business.

**PEACOCK INC** PO Box 1040, Station "A", Montreal, Quebec, H3C 2X5, Canada, Tel: +1-514-366-5900, Fax: +1-514-366-9804. Market a range of speciality pumps

including "Seepex" progressive cavity positive displacement pumps, "Desmi" centrifugal pumps, "Leistritz" positive displacement rotary screw pumps, "Emerick" piston diaphragm pumps and the full range of Weir centrifugal pumps.

**PEGSON LTD** Mammoth St, Coalville, Leicestershire, LE6 3ES, UK, Tel: +44-530-510051, Telex: 34423, Fax: +44-530-510041, Contact: Mr Smethurst. Self-priming and centrifugal pumps incorporating defusion pipe priming principle, suitable for suction lifts up to 7.5 metres. Branch sizes range from 50mm to 100mm. Applications include marine, agricultural, contractors, industrial uses and aircraft refuelling.

**G C PILLINGER & CO (ENGINEERS) LTD** 30 Factory Lane, Croydon, Surrey, CR0 3RL, UK, Tel: +44-1-688-7445, Telex: 887463, Fax: +44-1-681-2887, Contact: Mr O'Rourke. Manufacture specialised pumping systems, ie booster sets, irrigation systems. Provide the complete package for all pumping needs.

**PIONEER WESTON** Douglas Green, Pendleton, Salford, Greater Manchester, M6 6FT, UK, Tel: +44-61-736-5811, Telex: 667255, Fax: +44-61-736-5107. Pioneer Weston, one of Europe's premier manufacturers of rotary shaft and mechanical seals, offers a range of seals specifically designed for water pump applications both light and heavy duty. Known generally as KA, R and S types, these seals can be offered with a range of matching face and counterface materials and WRC approval.

**PLENTY LTD** Ham Bridge Rd, Newbury, Berkshire, RG14 5TR, UK, Tel: +44-635-42363, Telex: 848023, Fax: +44-635-49758, Contact: Andy Colquhoun. Manufacture and design of filters, mixers, pumps, pipe cleaning equipment and electro chlorinators. Representation worldwide.

**POMPE PORCELLI ELVIO & FIGLI SNC S S 148 KM 82,500**, B GO S Donato, Sabaudia (I.T), 04010, Italy, Tel: +39-773-50392-3, Fax: +39-773-50393, Contact: Mrs S Battini. Range of pumps from deep well vertical and horizontal pumps, electric submersible, centrifugal and trolleyed pumps.

**PROCON PRODUCTS** 910 Ridgely Rd, Munfreesboro, TN, 37130, USA, Tel: +1-615-890-5710, Telex: 55-5181, Fax: +1-615-896-7729, Contact: Mr Joe Crowder. Positive displacement rotary vane pumps for circulating, transferring or pressurizing numerous clean fluids (flows from 15 to 660 GPH, pressures to 250 PSI). Applications include reverse osmosis, carbonation, boiler feed, cooling, car wash, and many others.

**PSL INTERNATIONAL LTD** PO Box 4, Humber Rd, Barton-on-Humber, South Humberside, DN18 5BN, UK, Tel: +44-652-32702, Telex: 527305, Fax: +44-652-33401, Contact: Mrs McKenzie. Rotating equipment engineers - pumps, turbines and compressors, particularly for the water industry. Repairs to submersible pumps.

**PUMP TECHNICAL SERVICES LTD** Beco Works Kent House Lane, Beckenham, Kent, BR3 1LA, UK, Tel: +44-1-778-4271, Fax: +441-659-3576, Contact: Steven Kava-

## PUMPS- CENTRIFUGAL, AXIAL FLOW AND GENERAL

nagh. Pump Technical Services are currently enjoying their sixtieth year in the pumping industry. The association with jung pumpen of West Germany has proved very successful. Broadwall jung having become synonymous with sewage and surface water pumping, for civil and water authorities. Special packaged sets, drainers, macerators and corrosion resistant pumps.

**PUMPENFABRIK ERNST VOGEL GESELLSCHAFT**  
M b h P O BOX 42, Stockerau, A-2000, Austria, Tel: +43-2266-25-61, Telex: 135679 ervo a. Vogel pressure boosting plants are automatically controlled pumping stations and are used for supplying single houses, high-rise buildings, villages and whole settlements. They incorporate all the components necessary for fully automatic operation such as pumps, air receiver with compressor or membrane type tank, fittings, pressure gauge and electric switchboxes.

**PUMPING SERVICE (GB) LTD** Whitehouse St, Jack Lane, Hunslet, Leeds, LS10 1AD, UK, Tel: +44-532-446111, Telex: 557445, Fax: +44-532-465649, Contact: Mr Fox. Distributors for most of the leading British pump manufacturers. Around 2,000 pumps of various sizes and types in stock at any time, covering all applications.

**RED JACKET MFG CO** Box 3888, Davenport, IA, 52808, USA, Tel: +1-319-391-8600.

**RITZ PUMPENFABRIK** PO Box 1780, Schwaebisch, Gmuend, D707, West Germany, Tel: +49-7171-6091, Telex: 7248806, Fax: +49-7171-609287, Contact: Herr Wolf. Manufacture pumps for water of any consistency sizes up to one cubic meter p/s at depths up to 1000m.

**ROBAN ENGINEERING LTD** 18 Avenue Rd, Belmont, Surrey, SM2 6JD, UK, Tel: +44-1-643-8070, Telex: 946918, Fax: +44-1-642-1104, Contact: Mr Keith Buckley. Manufacturers and distributors of liquid handling equipment including pumps and flow meters.

**SCANPUMP AB** P O Box 2053, Holmdal, S 43102, Sweden, Tel: +46-3183-6300, Telex: 20626, Fax: +46-31184906, Contact: Mr Zettrling. Supplier of all kinds of centrifugal pumps, including submersible. Capacities up to 18,000 m<sup>3</sup>/hr.

**SELWOOD PUMPS** Bournemouth Rd, Chandler's Ford, Eastleigh, Hampshire, SO5 3ZL, UK, Tel: +44-703-266311, Telex: 477481, Fax: +44-703-260906, Contact: Bob Osmond. Selwood Pumps design and manufacture a range of 2" - 6" pumps suitable for handling a variety of fluids from clean water to solids in suspension. Models include the Selwood Simplite Spate, Selflow and Seltorque.

**SERFILCO UK LTD** Unit 4B, Broadoak Industrial Park, Ashburton Rd West, Trafford Park, Manchester, M17 1RW, UK, Tel: +44-61-872-1317, Telex: 665424, Fax: +44-61-873-8027, Contact: Margaret Chapman. Manufacturers of plastic pumps, filter chambers and filter cartridges as components in complete filtration systems.

**SHURFLO PUMP CO** 1400 Cerritos Avenue, E Anaheim, CA, 92805, USA, Tel: +1-714-533-7700. Manu-

facturers line of demand pumps to move distilled water from a reservoir on a distiller or from a bottle to faucets and ice-makers in a system. Offers fittings and filters to be used with its pumps.

**SIHI - HALBERG** Halbergstr 1, Ludwigshafen/Rh 1, 6700, West Germany, Tel: +49-621-56120, Telex: 4-64-833 halu d, Fax: +49-621-5612209. Pumping stations, pumps irrigation, water supply pumps and water work pumps.

**SIHI PUMPS (UK) LTD** Bridgewater Rd, Broadheath, Altrincham, Cheshire, WA14 1NB, UK, Tel: +44-61-928-6371, Telex: 667013, Fax: +44-61-928-3022, Contact: Mr Hunter. Extensive range of centrifugal pumps, single and multi-stage, which can be used for potable water or in the treatment of waste water.

**A O SMITH** 531 North 4th St, Tipp City, Ohio, 45371, USA, Tel: +1-513-667-2431, Telex: 288097, Fax: +1-513-667-2339, Contact: Mr Terry Glass. Manufacturers and suppliers of electric motors for domestic water systems and swimming pools, and of centrifugal pumps.

**SOVIET FOREIGN TRADE ASSOCIATION CHIMNASHEXPORT** 25 Bezbozhny per, 129369 Moscow, USSR Tel: +2883690, Telex: +411032 SOKEM. Soviet Foreign Trade Association Chimnasheexport was set up in 1987 as the sole supplier of machinery and equipment for the chemical and petrochemical industry. Exports: Plant and equipment for chemical, oil, petrochemical, pulp-and-paper industries, cryogenic plant, air and gas compressors, pumps, industrial valves and fittings. Imports: Complementary items for plant and equipment on the exports list.

**SPP PUMPS LTD** Theale Cross, Reading, RG3 7SP, UK, Tel: +44-734-323123, Telex: 848189, Fax: +44-734-323302, Contact: Mr Hatchett. Manufacturers of centrifugal pumps and pump packages for water, sewerage and fire protection industries.

**THE STERLING PUMP CO LTD** Water Lane, Spalding, Lincolnshire, PE11 2TH, UK, Tel: +44-775-2404, Fax: +44-775-710501, Contact: Mr Farrow. Suppliers of pumps - engine driven, electrically driven, PTO driven for all types of liquids, slurries, effluents etc. All pumping accessories including hosepips, fittings and piping.

**STUBENRUSS IRRIGATION SAS** V Castellano 4, Bressanone, BZ, I-39042, Italy, Tel: +39-472-35775, Telex: 400477, Fax: +39-472-34355.

**SULZER BROTHERS LIMITED**, CH-8401 Winterthur, Switzerland, Tel: +41-52-81-11-22, Telex: 896-060, Fax: +41-52-23-42-83. Sulzer water treatment and wastewater purification plants meet the special requirements associated with all kinds of municipal and industrial applications. In addition, pumps are supplied for communal and industrial water supply and irrigation installations. Furthermore, pumps, decanters and fluid-bed driers required for the treatment of waste waters and sewage sludges.

**SYKES PUMPS LTD** Gallions Rd, Charlton, London,

## PUMPS- CENTRIFUGAL, AXIAL FLOW AND GENERAL

---

SE7 7AP, UK, Tel: +44-1-858-8121, Telex: 896324, Fax: +44-1-853-4786, Contact: Mr Sharpe. Sykes Pumps are specialists in the provision of self-priming diesel and electro submersible pumps for ground water, slurry, sludge and storm water control. From 33 depots nationwide, Sykes provide a first class hire, sales and maintenance service.

**THE GORMAN - RUPP INTERNATIONAL COMPANY** P O Box 1217, Mansfield, Ohio, 44901-1217, USA, Tel: +1419-755-1011, Fax: +1419-755-1251, Contact: Pam Hamilton. Manufacturers of self-priming centrifugal pumps, trash-handling, clear-water and sewage pumps. Gorman - Rupp also manufacture a line of submersibles, diaphragm pumps and straight centrifugals.

**THE KSB MANUFACTURING CO LTD** Duke House, 6-12 Tabard St, London, SE1 4JT, UK, Tel: +44-1-403-1789, Telex: 8952557, Fax: +44-1-403-2101, Contact: Peter Robinson. Centrifugal pumps for all applications across the spectrum. Also manufacture valves.

**THOMPSONS KELLY & LEWIS LIMITED** PO Box 160, Springvale, Victoria, 3171, Australia, Tel: +61-3-562-0744, Fax: +61-3-562-0885, Contact: Ruedi Birmele. Thompsons, Kelly & Lewis is Australia's leading manufacturer and supplier of a complete range of centrifugal and positive displacement pumps for use throughout the water industry from rural, ground water to industrial and sewerage.

**TONKAFLOW PUMP - DIV OSMOSIS** 5951 Clearwater Drive, Minnetonka, MN, 55343, USA, Tel: +1-612-933-2277. Manufactures medium and high pressure multi-stage centrifugal pumps constructed of 316 stainless and durable noryl.

**TORRENT PUMP INDUSTRIES** P O Box 51066, Kifisia, GR-145 10, Greece, Tel: +30-1-81617128161702, Telex: 215870, Fax: +30-1-8161018. "Torrent" mixed and axial flow vertical pumps, centrifugal surface pumps and accessories.

**TOTTON PUMPS LTD** Southampton Rd, Cadman, Southampton, SO4 2MS, UK, Tel: +44-703-813136, Fax: +44-703-813-650, Contact: Mr Bran. Manufacturers of magnetically coupled centrifugal pumps, diaphragm pumps, submersible column pumps and small electric motors to 80 watt output.

**STUART TURNER LTD** Market Place, Henley on Thames, Oxon, RG9 2AD, UK, Tel: +44-491-572655, Telex: 847093, Fax: +44-491-573704, Contact: Mr Thompson. Stuart Turner Ltd manufacture a range of centrifugal and regenerative pumps up to 4 hp with flow rates up to 6000 gph. Also supplied are submersible pumps suitable for up to 2000 gph.

**U S PARA PLATE CORP** 1034 W Maude Avenue Ste 602, Sunnyvale, CA, 94088, USA, Tel: +1-408-737-8333. Manufacture various relief and pump regulating valves. Used in reverse osmosis system, 0-65 gpm, 0-1000 psi.

**ULTRA POMPES SA** 47 BD Georges Clemenceau, Courbevoie, 92400, France, Tel: +33-16-1-43-33-53-90,

Telex: POMPSYK 611432 F. Centrifugal self priming pumps from 18 to 200 M3/H, submersible drainage pumps from 11.5 to 50 M3/H, diaphragm pumps.

**VANDEZANDE** Esenweg 142, Diksmuide, 8160, Belgium, Tel: +32-51-50-01-17, Telex: 81649, Fax: +32-51-504-117, Contact: Mr Vandezande. Manufacturers of screw pumps for sewage and effluent. Also for land drainage.

**VARISCO POMPE S P A** Zona Industriale Nord, Terza Strada 9, Padova, 35129, Italy, Tel: +39-49-773944, Fax: +39-49-772168, Contact: Andrew Walker. Manufacturer of self-priming centrifugal pumps for water containing solids in suspension. Capacities up to 1500m<sup>3</sup>/h, heads up to 100m. Applications in sewage by-pass, water and effluent treatment, surface irrigation, fertirrigation and groundwater dewatering.

**J M VOITH A G P O BOX** 168, St Pöulten, A-3100, Austria, Tel: +43-27-42-25-01, Telex: 015510. For decades J M Voith have turned out pumps for irrigation, drainage and drinking water supply purposes and cooling water pumps for nuclear and thermal power plants.

**J M VOITH GmbH P O Box** 1940, St Poltner Strasse 43, Heidenheim, D-7920, West Germany, Tel: +49-7321-370, Telex: +714-79920, Fax: +49-7321-373000. Storage pumps, radial pumps, mixed flow pumps and axial flow pumps.

**VOPO POMPEN- & MACHINEFABRIEK BV** De Volger 2, De Rijp, NL, 1483 GA, The Netherlands, Tel: +31-2997-1312, Fax: +31-2997-3358. Surface water pumps, built for continuous operation, maintenance free. Large capacity for low heads. Widely used for drainage and irrigation jobs. Capacity 40 - 1000 M<sup>3</sup>/hour.

**W S DARLEY & CO** 2000 Anson Drive, Melrose Park, IL, 60160, USA, Tel: +1-312-345-8050, Fax: +1-312-345-8993, Contact: Paul C Darley. Manufacture a complete line of portable pumps, flow testing equipment, leak locators, dipping needles, pitots and offer a complete municipal supplies catalog.

**J T WADE & SON LTD** West Wycombe Rd, High Wycombe, Bucks, HP11 2LJ, UK, Tel: +44-494-450133, Telex: 837935, Fax: +44-494-465640, Contact: Mr Harvey. Manufacturers of a large range of pumping sets for agriculture, brewing, chilled water, hospitals, domestic water supply and water booster installations, fire booster sets, shower pumps plus many general applications.

**WAN-DEL COMPANY INC** 1204 Chestnut Avenue, Minneapolis, MN, 55403, USA, Tel: +1-612-332-5681. Manufacturer of pumps.

**WANNER ENGINEERING INC** 1204 Chestnut Avenue, Minneapolis, MN, 55403, USA, Tel: +1-612-332-5681. Manufacturer of triplex high pressure pumps and accessories.

**WARSOP POWER TOOLS** Hever Rd, Edenbridge, Kent, TN8 5DL, UK, Tel: +44732-863081, Telex: 95155,

## PUMPS- CENTRIFUGAL, AXIAL FLOW AND GENERAL

Fax: +44732-865680, Contact: Mr Lambert. Warsop manufacture and market a range of pumps, which comprise self priming centrifugals, submersibles, diaphragm and flexible shaft driven types. Suitable for clean water or water containing up to 40% solids in suspension.

**WEBER INDUSTRIES INC - WEBTROL PUMPS** 8417 New Hampshire Ave, St Louis, MO, 63123, USA, Tel: +1-314-6319200, Telex: 364412, Fax: +1-314-8427918, Contact: Joyce Molwak. Manufacture industrial and domestic water pumps. High pressure-low flow booster pumps available: 5-80 GPM and HP from 1/3 to 40 HP pumps used for chlorination, R O and ultra filtration.

**WEIR PUMPS LTD** Newlands Rd, Cathcart, Glasgow, G44 4EX, UK, Tel: +44-41-637-7141, Telex: 77161, Contact: Mr Inker. For water supply and sewage treatment: abstraction pumps, borehole pumps (shaft driven and submersible), pipeline and other distribution pumps, water treatment system pumps, sewage pumps, submersible sewage and land drainage pumps, complete pumping systems and controls, contract management, surge assessment of pumping systems, including the supply and setting to work of the necessary equipment, comprehensive facilities for model testing of pump sumps and complete intake systems.

**WORTHINGTON SIMPSON** PO Box 17, Lowfield Works, Newark, Nottinghamshire, NG24 3EN, UK, Tel: +44-636-705151, Telex: 37451, Fax: +44-636-705991, Contact: Mr White. UK's largest suppliers of standard industrial pumps. A division of Dresser (UK)Ltd.

### Pumps- Positive Displacement and Other Special Pumps

**ACROMET (AUST) PTY LTD** 14 Winterton Rd, Clayton, Victoria, 3168, Australia, Tel: +61-3-544-7333, Fax: +61-3-543-6706, Contact: Ernest A Hair. Acromet is an Australian manufacturer of chemical metering pumps and dry chemical feeders and a distributor of gas chlorination equipment and chemical pumps, both diaphragm and centrifugal, in plastic and special alloy construction. Acromet pumps and feeders are widely used throughout Australasia and South East Asia in water and wastewater treatment plants, and have an even wider range of applications in industry. Distributorships are available in many parts of the world.

**ALBANY ENGINEERING CO LTD (INCORPORATING CROWN PUMPS)** Church Rd, Lidney, Gloucestershire, GL5 5EQ, UK, Tel: +44-594-42275, Telex: 43363, Fax: +44-594-42574, Contact: Mr Mckernom. Albany Engineering manufacture a range of diaphragm type metering pumps, centrifugal and rotary pumps, for a variety of applications in the water industry.

**AQUA HYDRAULIUCS LTD** Star Trading Estate, Partridge Green, West Sussex, RH13 8RA, UK, Tel: +44-403-710855, Telex: 87508, Fax: +44-403-710067, Contact:

Mr Foster. Manufacturers of high pressure water pumps-pressures of up to 1000 bars, volumes up to 450 litres per minute. Suppliers of pumps in bare shaft form or made up into a variety of skids and trailer units.

**AQUATECH LTD** St Johns Rd, Wivenhoe, Colchester, Essex, CO7 9DR, UK, Tel: +44-206-223232/224242, Fax: +44-206-226262, Contact: Mr Colin Eade. Manufacturers of specialist pumping equipment including micro-processor and electronic liquid level controls. "ET" series packaged water pressure booster set with capacities up to 120 m3 are compatible with BMS systems.

**ARMSTRONG MACHINE CO** 302 N W 13th, Poca-hontas, Pocaontas, LI, 50574, Tel: USA, Fax: +1-712-335-4131, Contact: Sharon Porter. Suppliers of mud pumps, both new and used. Also all *manor of spare parts and repairs* undertaken will even make new spares for pumps, no longer available.

**AUTOMETRIC PUMPS LTD** Turkey Court, Ashford Rd, Maidstone, Kent, UK, Tel: +44-622-677650, Telex: 965-633, Contact: Roger Burt. Producers of small pumps and sizes 2" BSP. The range includes centrifugal, gear, turbine, hand and vacuum pumps. We also handle a large range of pumps of other manufacture.

**BERESFORD PUMPS** Burnsall Rd, Canley, Coventry, West Midlands, CV5 6BN, UK, Tel: +44-203-78412, Telex: 317298, Contact: Mr Murray. Manufacturers of centrifugal self-priming pumps in cast iron, bronze or stainless steel, sump and cellar drainage pumps. Also water and chemical pumps of polypropylene construction.

**BEVI WRIGHT LTD** Pellon Lane, Halifax, West Yorkshire, HX1 5QL, UK, Tel: +44-422-60201, Telex: 51101, Fax: +44-422-51092, Contact: Mr P J Franke. Pumps for circulation of hot or chilled water, pressure boosting etc. Sizes from 1in to 8in. Power output from 0. 1 to 40kw. Both single and twin pumps available. Also available in bronze construction.

**BIWATER PUMPS** Millers Rd, Warwick, CV34 5AN, UK, Tel: +44-926-411740, Telex: 317473, Fax: +44-926-410740, Contact: Mr Chatterton. Manufacturers of pumps - both solids - handling sewage pumps and submersible waste water pumps. Build pumps into complete pumping stations including mechanical and electrical. Manufacturers of compatible control panels.

**JOHN BLAKE LTD** PO Box 43, Royal Works, Accrington, Lancs, BB5 5LP, UK, Tel: +44-254-354419, Fax: +44-254-382899, Contact: Mr Nicholson. Manufacturers of the well known Lake Hydrain self acting water pump requiring no power other than running water.

**BURTS PUMPS INC** PO Box 431F9Decatur, IL. 62525, USA, +1-217-429-2591, Contact: Gena Schuman. Manufacture jet pumps, submersible pumps for water industry.

**CAT PUMPS CORPORATION** 1681 94th Lane N E, Minneapolis, MN, 55434, USA, Tel: +1-612-780-5440, Telex: 290276, Fax: +1-612-780-2958, Contact: Darla Thompson. Manufacture high pressure, triplex piston and

## PUMPS-POSITIVE DISPLACEMENT AND OTHER SPECIAL PUMPS

plunger pumps, motorized pump units, corrosion resistant and 316 stainless steel pumps and complete line of complementary system accessories all available through international network of sales and service reps.

**CHEM-TECH INTERNATIONAL INC** P O Box 1476, 92 Bolt St, Lowell, MA, 01853, USA, Tel: +1-617-453-4020. A leading US manufacturer of positive displacement diaphragm and piston pumps. CTI's line consists of over 120 models to address light-duty residential applications, along with demanding industrial requirements. (WT)

**CLEGHORN WARING & CO (PUMPS) LTD** 9-15 Hitchin St, Baldock, Herts, SG7 6AH, UK, Tel: +44-462-893838, Telex: 826832, Fax: +44-462-894719, Contact: W Cleghorn. Specialist distribution of centrifugal and positive displacement pumps, including self priming types, for low pressure water transfer.

**COLTFIELD ENGINEERING LTD** Bookers Way, Todwick Rd Industrial Estate, Dinnington, Sheffield, UK, Tel: +44-909-568861, Telex: 54533, Fax: +44-909-569423, Contact: Mr Trevor Skelding. Manufacturers of pumps (compressed air & electric high pressure slurry).

**COMMERCIAL HYDRAULICS LIVERPOOL LTD** Long Lane, Fazakerley, Liverpool, L9 7BW, UK, Tel: +44-51-525-5933, Telex: 629561, Fax: +44-51-523-4198, Contact: Mr Tarr. Design and manufacture hydraulic axial piston pump and motors, applicable to a wide range of industries.

**COMPRESSION SYSTEMS HOLLAND BV** PO Box 65, Nieuwkoop, AB, 2420, The Netherlands, Tel: +31-1725-9218, Telex: 39528, Fax: +31-1725-3695, Contact: Mr Haring. Manufacturers of sludge pumps (duplex and triplex) to customer specifications, steel and cast-iron piping with coatings suited to customers' requirements. Manufacturers of pipe coating machinery.

**CREST PUMPS LTD** Uddens Trading Estate, Wimborne, Dorset, BH21 7NH, UK, Tel: +44-202-874411, Telex: 41195, Fax: +44-202-861080, Contact: Mr Parker. Manufacture chemical pumps for corrosion resistant duties within the water industry.

**DEPLECHIN POMPES SA** Ave de Maire 28, Tournai, B-7500, Belgium, Tel: +32-69-228152, Telex: 57399, Fax: +32-69-212764, Contact: Mr Malisart. Hand-operated pumps for deep wells also export industrial pumps. Specialise in special pumps and accessories in small quantities to clients requirements. Also pumps for all kinds of industry-chemicals, food etc.

**FLUXINOS ITALIA SRL** Via Genova 8, 58100 Italy Tel: +39-564451272, Telex: 322458 Ikrane I, Fax: +39-564454237. Palsa System water oscillation or spring rebound inertia deep well solar and/or hand pumps for small-scale microirrigation market gardening and animal watering in developing countries. They work exploiting the characteristics of oscillating water columns and represent one of the world's most advanced pumping technologies. All completely eliminated to render the Palsa pumps post-VLOM and post-plastic. Entirely in stainless steel and rust and abrasion resis-

tant, with one single length of flexible polyethylene feed pipe. Vertical and/or horizontal operation Single level systematic preventive maintenance with itinerant artisan able to handle on his own up to 500 installations. Global long term (10 year cycle) maintenance cost 0.405 US\$ per person per year, with cost per cubic meter of water pumped US\$ 0.0385. All parts including those subject to wear and tear guaranteed against breakdown for 12 months irrespective of the intensity of use. The solar version is highly competitive from an economic point of view even for small villages. Hydraulic limit 25 litres/minute.

**FORDWATER PUMPING SUPPLIES LTD** 49-53 Stratford Rd, Birmingham, West Midlands, B11 1RQ, UK, Tel: +44-21-772-8336, Telex: 335807, Contact: Brian Powell. Supply and maintain all types of pumps.

**GARBARINO SpA** Via St Lazzaro 3, Acqui Terme, AL, 15011, Italy, Tel: +39-144-58671, Telex: 212158, Fax: +39-144-55260, Contact: John Lilley. Garbarino are manufacturers of centrifugal, self-priming, gear and rotary pumps (constructed to NATO and Italian Military standards) which are supplied worldwide to the naval, industrial and chemical sectors.

**GRAHAM PRECISION PUMPS LTD** The Forge, Congleton, Cheshire, CW12 4HQ, UK, Tel: +44-260-274721, Telex: 667383, Fax: +44-260-276965, Contact: John Trowbridge. Specialist manufacturers of liquid ring and rotary vane vacuum pumpsets and ejectors, centrifugal pumps, twin pumps, inline, horizontal and vertical multi-stage pumps, self priming, gear and rotary vane pumps.

**HARBEN SYSTEMS LTD** Churchfields, Salisbury, SP2 7UD, UK, Tel: +44-722-25424, Fax: +44-722-411329. Manufacturers of a range of unique radial piston high pressure water pumps producing pressures up to 700 bar. Applications include: water main descaling, drain/sewer cleaning, tube/pipe descaling, general descaling and floor cleaning.

**HIGH DUTY PLASTICS LTD** 94 Tallyho St, Rotorua, New Zealand, Tel: +64-73-482215, Fax: +64-73-462880. Manufacture and export chemical pumps to Indonesia and the Pacific Islands. The pumps have a robust construction, they are efficient, readily overhauled and competitively priced. Full range of spare parts available.

**HYDROFLO CORPORATION** Plumsteadville, PA, 18949, USA, Tel: +1-215-766-7867, Fax: +1-215-766-8290, Contact: Mr Harry Black. Chemical injection pumps for irrigation systems. Also used in water and waste treatment systems.

**HYPRO CORPORATION** 375TH Fifth Avenue NW, New Brighton, MN, 55112, USA, Tel: +1-612-633-9300, Telex: 4310109, Fax: +1-612-633-6864, Contact: Mr Dean Johnson. Manufacturer of pumps and fluid handling accessories for high pressure cleaning, spraying and general liquid transfer. Roller pumps, centrifugal pumps and diaphragm pumps in a range of sizes.

**JLC PUMPS & ENGINEERING CO LTD** Oxgate Farm



## PUMPS-POSITIVE DISPLACEMENT AND OTHER SPECIAL PUMPS

Works, Coles Green Rd, London, NW2 7EX, UK, Tel: +44-1-452-4081, Telex: 82317, Contact: Mr Catton. All types of pumps for all purposes.

**JOBSON BECKWITH LTD** Treadway House, 26-30 Cubitt St, London, WC1X 0LR, UK, Tel: +44-1-833-0395, Telex: 940-96319, Fax: +44-1-837-5673, Contact: Mr D Goodson. Jobson Beckwith manufacture/distribute a range of positive displacement pumps for handling viscous liquids. Centrifugal, hand and flexible impeller pumps are also available, as is installation, servicing and pumping systems.

**L-K INDUSTRIES INC** PO Box 230305F9Houston, TX, 77223, USA, +1-713-926-2623, Tel: +1-713-926-7736, Fax: 166786, Contact: Mr Tippen. Manufacturer of valves, rods and liners for all types of power pumps for the water industry.

**LABOUR PUMP CO LTD (ALCORN DIVISION)** Denington Estate, Wellingborough, Northants, NN8 2QL, UK, Tel: +44-933-225080, Telex: 31428, Fax: +44-933-440032, Contact: Les Massey. The "Alcon" pump range comprises self-priming centrifugal, end suction and diaphragm pumps. Supplied mainly to the agricultural, horticultural, building contracting and civil engineering industries. Outputs range up to 4000 lit/min and heads to 55 metres.

**LAWRENCE EDWARDS & CO (CO ENGINEERS) LTD** Stourport Rd, Kidderminster, Worcs, DY11 7QS, UK, Tel: +44-562-66233, Telex: 338373, Fax: +44-562-60231, Contact: Mr Williams. Manufacture roller vane pumps - 10 GPM to 40 GPM, slurry pumps - 3500 GPH and diaphragm pumps from 50 litres per minute. All power take-off driven.

**LIQUID DYNAMICS (MEMBRANFLEX LTD)** Hurstfield Industrial Estate, Hurst St, Reddish, Stockport, SK5 7BB, UK, Tel: +44-61-442-6222, Telex: 669236, Fax: +44-61-443-1486, Contact: Mr Charles. "PIPEHUGGER" pulsation dampeners and suction stabilisers for positive displacement pumps, shock (water hammer) alleviators, hydropneumatic accumulators, sizes 0.04 to 4000 litres, pressures from 0 - 30,000 psi.

**LITTLE GIANT PUMP CO** 3810 No Tulsa St, Oklahoma City, OK, 73112, USA, Tel: +1-405-947-2511, Fax: +1-405-942-2285, Contact: V X Smith. Manufacturer of fractional HP centrifugal pumps, submersible and non-submersible. Used in water and corrosive chemicals. Specialty pumps also for effluent and sewage.

**LUKO PUMPEN-MASCHINENFABRIK GESELLSCHAFT m b H** Grillgasse 15, Wien, A-1110, Austria, Tel: +44-222-74-15-63-63, Telex: 13-16000 luko a. Luko Pumpen-Maschinenfabrik GesmbH turn out series-produced displacement, rotary and submersible pumps. Luko self-priming rotary pumps, model Jonio, can be supplied ready fitted with electric motor or petrol or diesel engine. They are particularly suitable for conveying heavily contaminated, muddy and sandy waste water, even water of large-solid content. Luko normal-action pumps, Model N, are used for conveying highly contaminated water occurring in industry, agriculture and households.

**THE MEC-O-MATIC CO** 5445 Williamsburg Drive, Punta Gorda, FL, 33983, USA, Tel: +1-813-539-5235. Manufactures positive displacement chemical feed pumps. Undesirable water quality problems such as iron, pH and offensive hydrogen sulfide odors are addressed and can be corrected. (WT)

**MEGATOR PUMPS AND COMPRESSORS LTD** Hendon, Sunderland, Tyne And Wear, SR1 2NQ, UK, Tel: +44-91-567-5488, Fax: +44-91-567-8512, Contact: Mr Holland. Manufacturers of pumps and pumping systems for cold water pressurising services, fire sets, water treatment, sump clearance, oil recovery, oil/water separators and filtration, pollution control equipment.

**METRIX ENGINEERING** Blagdon St, Sheffield, S2 5QS, UK, Tel: +44-742-767921, Telex: 547621, Contact: R Smith. Manufacturers of a range of centrifugal and heavy-duty diaphragm pumps and associated equipment for the water and sewage industry.

**MILS** 17-25 Avenue Paul-Santy, Lyon, Cedex 8, F-69371, France, Tel: +33-78-74-85-71, Telex: 380913, Fax: +33-78-00-82-34, Contact: Mr Thevenin. Manufacturers of vacuum pumps and compressors.

**MOLEX PUMPS DIVISION** Whale Tankers Ltd, Ravenshaw Lane, Solihull, West Midlands, B91 2SU, UK, Tel: +44-21-704-3191, Telex: 336182, Fax: +44-21-705-3053, Contact: Mr Paris. Provide screw type positive displacement sludge pumps for use independently on trailed chassis and on gravity filled or vacuum tankers for the handling of sewage, water and sludges.

**MONO PUMPS LTD** Cromwell Rd, Bredbury, Stockport, SK6 2RF, UK, Tel: +44-61-494-6999, Telex: 668762 MONO G, Fax: +44-61-494-5802. Manufacturers of borehole pumps, hand driven to V.I.O.M design, for rural water supplies - depths to 90 metres and diesel, electric and solar driven, depths to 300 metres, flows to 100 m<sup>3</sup>/hr.

**F E MYERS A PENTAIR COMPANY** 1101 Myers Parkway, Ashland, Ohio, 44805-1923, USA, Tel: +1-419-289-1144, Telex: 98-7443, Fax: +1-419-289-6658. Today, with more than 118 years of industry experience, F E Myers, a Pentair Company, manufactures submersible and centrifugal jet pumps for residential water systems, environmental waste handling pumps and systems, sump and sewage pumps, reciprocating and centrifugal industrial pumps, plus a wide range of repair parts and accessories.

**NORTHVALE** Uxbridge Rd, Melton Rd, Leicester, Leicestershire, LE4 7ST, UK, Tel: +44-533-665911, Telex: 341573, Fax: +44-533-610050, Contact: Mr Hives. Manufacturers of check valves and fluid jet pumps.

**PATTERSON PUMP COMPANY** Highway 123 South PO Box 790, Toccoa, Georgia, 30577, USA, Tel: +1-404-886-2101, Telex: 8107661350, Fax: +1-404-886-0023, Contact: Mr Daryl Snyder. Manufacture ban pumps for fire water sprinklers, non-clog sewage pumps, vertical in-line pumps and horizontal split-gauge pumps.

**PROCON PRODUCTS** 910 Ridgely Rd, Murfreesboro,

## **PUMPS-POSITIVE DISPLACEMENT AND OTHER SPECIAL PUMPS**

TN, 37130, USA, Tel: +1-615-890-5710, Telex: 55-5181, Fax: +1-615-896-7729, Contact: Mr Joe Crowder. Positive displacement rotary vane pumps for circulating, transferring or pressurizing numerous clean fluids (flows from 15 to 660 GPH, pressures to 250 PSI). Applications include reverse osmosis, carbonation, boiler feed, cooling, car wash, and many others.

**PUMP TECHNICAL SERVICES LTD** Becco Works Kent House Lane, Beckenham, Kent, BR3 1LA, UK, Tel: +441-778-4271, Fax: +441-659-3576, Contact: Steven Kavanagh. Pump Technical Services are currently enjoying their sixtieth year in the pumping industry. The association with Jung Pumpen of West Germany has proved very successful. Broadwall Jung having become synonymous with sewage and surface water pumping, for civil and water authorities. Special packaged sets, drainers, macerators and corrosion resistant pumps.

**PUMPING SERVICE (GB) LTD** Whitehouse St, Jack Lane, Hunslet, Leeds, LS10 1AD, UK, Tel: +44-532-446111, Telex: 557445, Fax: +44-532-465649, Contact: Mr Fox. Distributors for most of the leading British pump manufacturers. Around 2,000 pumps of various sizes and types in stock at any time, covering all applications.

**ROBBINS & MYERS CANADA LTD** 17 Woodyatt Drive, Brantford, N3T 5N6, Canada, Tel: +1-519-752-5447, Telex: 06181131, Fax: +1-519-752-3243, Contact: Mr Murray Locke. Produce progressing cavity pumps for industrial and municipal applications and hand pumps which use the progressing cavity principle.

**SCHUCO SCIENTIFIC LTD** Woodhouse Rd, London, N12 0NE, UK, Tel: +44-1-368-1642, Telex: 893312, Fax: +44-1-361-3761, Contact: Mr Hutterer. The Schuco minipump comprises a range of inexpensive peristaltic pumps having flow rates 0.2 - 25 ml/min single, two and four channel models are available for mains of battery operation and are used by water authorities in the UK and abroad for water sampling.

**SEKO SPA** Via Don Luigi Sturzo 3, Cittaducale, RI, 02015, Italy, Tel: +39-746-62036, Fax: +39-746-62039, Contact: Manrico Bertozzi. Manufacturer of solenoid metering pumps, peristaltic pumps and dosing systems for applications in: water conditioning, chlorination, swimming pools, water treatment plants, industrial purifications, evaporating towers, surface treatment, detergents, photographic developing, hydro cleaning, agriculture, droplet irrigation, catering, drinking water, heating systems, boilers, paper industries, oenology, aquaculture.

**SERFILCO UK LTD** Unit 4B, Broadoak Industrial Park, Ashburton Rd West, Trafford Park, Manchester, M17 1RW, UK, Tel: +44-61-872-1317, Telex: +665424, Fax: +44-61-873-8027, Contact: Margaret Chapman. Manufacturers of plastic pumps, filter chambers and filter cartridges as components in complete filtration systems.

**SIEBEC B P 8** Rue Guy Mocquet, Fontaine, 38600, France, Tel: +33-76-26-12-09, Telex: +320-178, Fax: +33-76-27-04-82. Siebec provides a complete range of filters

for corrosive liquids up to 60 cubic metres per hour, supplied either with magnetic coupled pumps or with mechanical seal pumps. Also pumps with polypropylene or injected PVDF body.

**MICHAEL SMITH ENGINEERS** Oaks Rd, Woking, Surrey, GU21 1PH, UK, Tel: +44-4862-71871, Telex: 859306 MSEWOK, Fax: +44-4862-23110, Contact: Mr Sam Smith. Engineers and distributors for specialised pumping equipment. Pumping systems and packaged dosing systems designed to customer requirements. Chlorination equipment and pumps.

**SSP PUMPS LTD** Birch Rd, Eastbourne, Sussex, BN23 0PQ, UK, Tel: +44-323-25151, Telex: 87384, Fax: +44-323-0495, Contact: Mr Guppy. SSP Pumps Ltd manufacture a range of positive displacement rotary lobe pumps for use in the treatment of sewage and water. Pumps range from a quarter to twelve inches inlet and outlet with a capability of flow rates of sixty litres an hour, up to 680 cubic metres an hour and a maximum pressure rating of 20 bar.

**THOMPSONS KELLY & LEWIS LIMITED** PO Box 160, Springvale, Victoria, 3171, Australia, Tel: +61-3-562-0744, Fax: +61-3-562-0885, Contact: Ruedi Birmele. Thompsons, Kelly & Lewis is Australia's leading manufacturer and supplier of a complete range of centrifugal and positive displacement pumps for use throughout the water industry from rural, ground water to industrial and sewerage.

**TOMLINSON, HALL & CO LTD** Boathouse Lane, Stockton-on-Tees, Cleveland, TS18 3AT, UK, Tel: +44-642-675696, Telex: 587382, Fax: +44-642-676569, Contact: Mr Johnson. Pump engineers whose main area of operation is re-exporting a fast priming pump/dewatering pump, "Helivac" which pumps any combination of air and liquids and some fine solids.

**TORRENT PUMP INDUSTRIES** P O Box 51066, Kifisia, GR-145 10, Greece, Tel: +30-1-81617128161702, Telex: 215870, Fax: +30-1-8161018. Special purpose pumps and accessories.

**ULTRA POMPES SA** 47 BD Georges Clemenceau, Courbevoie, 92400, France, Tel: +33-16-1-43-33-53-90, Telex: POMPSYK 611432 F. Centrifugal self priming pumps from 18 to 200 M<sup>3</sup>/H, submersible drainage pumps from 11.5 to 50 M<sup>3</sup>/H and diaphragm pumps.

**VANTON PUMPS LTD** Unit 6, Radnor Park Industrial Centre, Congleton, Cheshire, CW12 4XL, UK, Tel: +44-260-277040, Telex: 666384, Fax: +44-260-280605, Contact: Mr Hubert. Manufacturers of pumps in engineered plastics, specifically for handling corrosives in the water dosing and treatment industry.

**WATSON-MARLOW**, Falmouth, Cornwall, TR11 4RU, UK, Tel: +44-326-73461, Telex: 45594, Fax: +44-326-76009, Contact: Heather Beale. Single and multi-channel peristaltic pumps, controllable manually or remotely by process signal. Flow rates between 15 microlitres to over 7000 litres per hour.

**WEBER INDUSTRIES INC** 8417 New Hampshire, St

## PUMPS-POSITIVE DISPLACEMENT AND OTHER SPECIAL PUMPS

Louis, MO, 63123, USA, Tel: +1-314-631-9200. Manufacturer of a high quality line of 4" and 6" submersible pumps, 4" and 6" submersible turbine pumps, high pressure booster pumps (5 through 80 gpm and up through 780 psi discharge pressures), sump pumps and assorted other specialty pumps. (WT)

**WEMCO (GB) - DIVISION OF BAKER HUGHES LTD** Mansard Close, Westgate, Northampton, NN5 5DL, UK, Tel: +44-604-52411, Telex: 311705, Fax: +44-604-57256, Contact: Mrs Willis. Mineral processing engineers and effluent treatment specialists. Manufacturers and distributors of specialised pumps for water.

**WILDEN PUMP AND ENGINEERING** 22069 Van Buren, Colton, CA, 92324, USA, Tel: +1-714-783-0621, Fax: +1-714-783-2432. Complete line of air-operated, double diaphragm, positive displacement pumps designed to handle very thick and very abrasive products. The pumps handle up to 90% solids to over 250ft heads in permanent, submerged and self-priming operations.

### Pumps- Submersible

**ABS PUMPEN AG** . Lohmar, D-5204, W Germany, Tel: +49-2246/13-1, Telex: 889619, Fax: +49-2246/13-200, Contact: Mr W Klimmek. ABS PUMPEN AG is one of the world leaders for submersible pumps for drainage, irrigation and sewage up to 500 kw, including submersible mixers. Subsidiaries and representation in more than 50 countries.

**AMCO DRILLING LTD** PO Box No 1, Whaley Rd, Barugh, Barnsley, S Yorks, S75 1HG, UK, Tel: +44-226-243413, Telex: 547401 AMCO G, Fax: +44-226-287-512, Contact: Mr Woodside. Contractors for rotary drilling, air, water, foam or reverse circulation techniques. Bores for observation, abstraction or re-charge wells. Installation and maintenance of borehole pumps control gears.

**ATLAS COPCO ENERGY AB** S-105 23, Stockholm, Sweden, Tel: +46-8-743-80-00, Telex: 14090 copco s, Fax: +46-8-716-59-75. Atlas Copco Energy handpumps combined with SW-riser pipes can be installed and service can be made without special lifting equipment. Few moving parts assure long period of use before any service is required. This is village level operation and maintenance.

**BC PUMPS LTD** 29-30 Kernan Drive, Loughborough, Leicestershire, LE11 0JF, UK, Tel: +44-509-231872, Telex: 342185, Fax: +44-509-215228, Contact: Debbie Kendall. Manufacturers of centrifugal pumps for water and sewage applications. Ranges include DIN2455 water pumps, borehole, multistage, horizontal and vertical sewage, submersible sewage and drainers.

**BIZZI & TEDESCHI SNC** Via Brodolini 35A, Campagnine, RE, 42040, Italy, Tel: +39-522-677209-676257, Fax: +39-522-677633, Contact: Daniele Bizzi. Manufacturers of submersible electropumps for wells.

**BRITISH PLEUGER SUBMERSIBLE PUMPS LTD** Station Rd, Coleshill, Birmingham, B46 1JH, UK, Tel:

+44-675-63342, Telex: 338451, Fax: +44-675-65827, Contact: Mr Nicholas. Manufacturers of radial, mixed flow and axial flow electro-submersible pumps for all applications involving handling water. Also double action reciprocating pumps for sewage sludge etc. Rectangular and rotary distributors, scrapers, mechanical screens, screw pumps and control panels.

**BURTS PUMPS INC** PO Box 431, Dectur, IL, 62525, USA, Tel: +1-217-429-2591, Contact: Gena Schuman. Manufacture jet pumps, submersible pumps.

**CAPRARI SpA** Emilia Ovest 900, MO, 41100, Italy, Tel: +39-59-330-533, Fax: +39-59-338153, Contact: Cloudia. Leading European manufacturers of: electric submersible pumps for 4" to 14" wells, deep well turbine pumps, vertical and horizontal electric monobloc pumps, single and multistage centrifugal pumps and P. T. O. pumps.

**CARIVAL SpA** Via Per Azzano, San Paolo 26/28, Grassobbio, 24050, Italy, Tel: +39-35-201069, Telex: 300165, Fax: +39-35-295347, Contact: Willi Tschigg. Suppliers of pumps of highest quality design and materials from circulating pumps to deep well submersibles, pressure boosting and water feed pumps, sewage pumps, control systems and special designs.

**CLASSEN AND CO LTD** Horton Close, West Drayton, Middlesex, UB7 8JA, UK, Tel: +44-895-443206, Fax: +44-895-441274, Contact: Mr Thomas. Classen and Co are distributors for a full range of multiple application pumps from Hanning & Kahl and Grindex submersible electric pumps from 1-50hp, and Telstar float regulators.

**CONDRILL AB** Sveavagen 83 113 50 Stockholm Sweden Tel: +46-8-349560, Telex: +12336, Fax: +46-8-316762.

**DAVIS-EMU** 1706 Metcalf Avenue, Thomasville, CA, 31792, USA, Tel: +1-912-226-5733, Fax: +1-912-226-4793, Contact: Harry Roufe. Manufacturer of submersible sewage pumps and aeration equipment.

**EBARA CORPORATION** 11-1 Haneda Asahicho, Ohta-Ku, Tokyo, 144, Japan, Tel: +81-3-743-67-16, Telex: EBARA TYO 322988, Fax: +81-3-745-3576, Contact: Mr R D Jones. EBARA is probably one of the largest specialist pump companies in the world 4000 employees manufacturing in Japan, Indonesia and Singapore a comprehensive range of pumps for all applications.

**FLYGT AB** Box 1309 S-171 25 SOLNA, Sweden. Tel: +46-8-733 6500, Telex: +43887 flygtab s, Fax: +46-8-295816, Contact: Anderz Öhringe. Flygt is the world's leading manufacturer of submersible heavy-duty pumps for contaminated and abrasive liquids. The annual sales for 1988 was approx SEK 2.3 billion. With over 1,250,000 installations in more than 100 countries throughout the world, Flygt submersible products encompass an awesome range of pumps, mixers and hydro turbine generators for small scale hydro electric power stations. The main office is situated in Solna, just outside Stockholm, with manufacturing facilities are in Lindas. Flygt has subsidiaries in 16 countries and 3,400 employees of which 1,500 are in Sweden.

# YOU CAN'T NAME A BETTER PUMP

# GRUNDFOS

They come rolling off production lines in six different countries. Circulators... in-line pumps for industry... submersible pumps for water supply.

Tens of thousands of them every working day, stamped with the name "Grundfos". And that one little word says a lot. For at Grundfos, we know a pump may have to perform day and night, and often in a hostile environment. So we design ours to work hard, despite constant wear and corrosion.

Just as important, "Grundfos" stands for dedicated

people. For skilled engineers and scientists. For thousands of production personnel who pride themselves on craftsmanship – and hundreds more who provide training and after-sales service.

"Grundfos"... To engineers, plumbers and home owners alike, it's another name for quality.

*Founded in 1945 in Denmark, Grundfos today has production, sales and service facilities worldwide. The company manufactures a wide range of pumps for heating systems, industrial applications, irrigation plants, and urban and rural water supply.*

**GRUNDFOS**  
You can't name a better pump

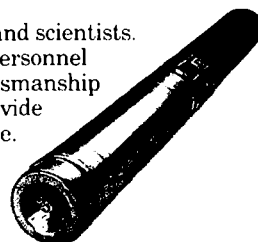

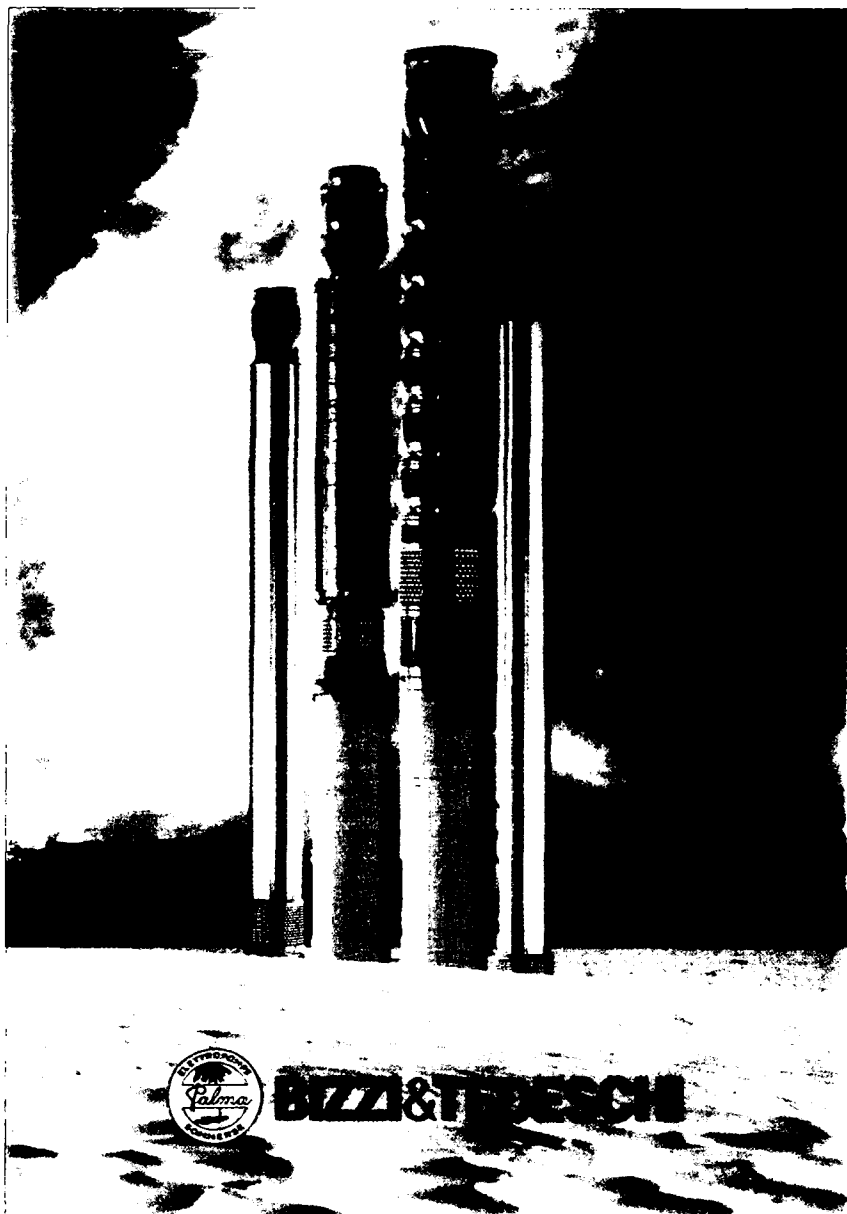

## **BIZZI & TEDESCHI**

Manufacturers of "PALMA" submersible electrical motors and pumps since 1957, is one of the leading companies in the field of the water extraction from deep wells. The object has been reached thanks to the characteristics of **PALMA SUBMERSIBLE ELECTROPUMPS:**

- QUALITY
- DURABILITY
- RELIABILITY
- HIGH EFFICIENCIES, LOW RUNNING COSTS
- EASY REPAIRING

More than 800,000 HP of installed power in 30 countries of EUROPE, AFRICA, MIDDLE-EAST, and ASIA are good reasons for a sure choice:

**PALMA**

Via Brodolini, 35/A 42040 Campegine (RE) Italy  
Tel: (0522) 677209-676257 Telex 530021 AINDRE I Fax: 0522-677633

**FLYGT**



# TALK TO A SUBMERSIBLE ENGINEER

Make sure you talk to the man from Flygt. He'll show you a whole new world of submersible technologies. Pointing your thoughts to a pump that's specifically engineered to handle liquids at minimal cost. The Flygt submersible. For dewatering, drainage, irrigation, sewage or level regulation. Submersible technology gives you a pump that's built as one integral unit. Needing no pump house and minimal ground surface. Enabling the complete pump to be directly lowered into the liquid. And that means you won't need a large and expensive pump house. The Flygt submersible is a precision engineered product, that can handle virtually any kind of effluent, and is so reliable that generally it's only got to be checked once a year.

## GLOBAL KNOWLEDGE

The Flygt submersible pump operates at very high efficiency and at very low cost. But we can also offer much more. The manpower, know-how and experience to provide you with in-depth consultancy. Our computer banks hold the answers to more than one million different ways of solving your problem. Stored data from installations around the world, which enables us to rapidly access system design, dimensions, sump formats, controls, products and performance. Combining geometries, components and materials to recommend the most-efficient equipment.

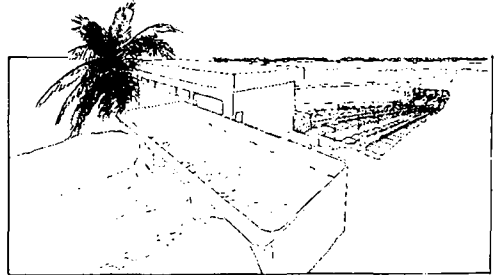

With more than 100 different models, we can select from a wide range of different motors, sizes, volutes, impellers and propellers. And we've got over 50 specialized software programs to help us make sure that you get the performance that exactly matches your needs.

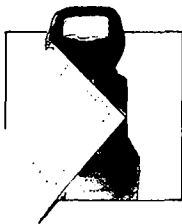

## GUARANTEED PERFORMANCE

Not one single product ever leaves our factories without thorough testing. The test curve supplied with each pump guarantees the performance we specify. From sub-suppliers, through

manufacturing to delivery and installation, we guarantee the quality of our products. And every new project — model changes, component improvements or large-scale design modifications — always ends with a field test. We've replaced quality control with quality assurance.

## ADVANCED RESEARCH

Research into cavitation, boundary layer flows, rotating currents and turbulence in detail, is routine work for Flygt. Using advanced equipment gives us results in just a few hours. Our development laboratories can therefore rapidly determine the correct geometry of any new hydraulic component.

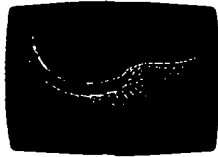

With superior CAD/CAM techniques, prototypes are manufactured very fast. And our own Flygt computer programs gives us a unique research capability. It keeps us out front — from design, through development, to end product.

**FLYGT** Your choice of a Flygt submersible pump is guaranteed to cut your investment  
**WILL CUT YOUR** costs, minimize maintenance and  
**COSTS** give you true long term economy.  
And with the largest range of submer-

sible pumps from the world's leading manufacturer, you're also assured that Flygt will always find the best possible answer to your particular problem.

*Flygt is represented in more than 100 countries around the world. For more information please contact your nearest Flygt engineer, or fill in the reply card at the end of this book.*



ITT Fluid Technology Corporation

**Flygt**

## PUMPS- SUBMERSIBLE

**FLYGT PUMPS LTD** Colwick, Nottingham, NG4 2AN, UK, Tel: +44-602-400111, Telex: 37316, Fax: +44-602-400444, Contact: Mr Waugh. Supply a range of electro-submersible pumps, mixers and ancillary equipment for sewage, industrial waste water and land drainage schemes. A complete service from design to commissioning and contract maintenance is available.

**FORDWATER PUMPING SUPPLIES LTD** 49-53 Stratford Rd, Birmingham, West Midlands, B11 1RQ, UK, Tel: +44-21-772-8336, Telex: 335807, Contact: Brian Powell. Supply and maintain all types of pumps.

**GARVENSWERKE BETRIEBSGESELLSCHAFT M b h** Handelskai 130, Wien, A-1020, Austria, Tel: +43-222-24-15-71, Telex: 134680. Since 1869, the firm has been engaged in pump and motor production. The main products exported are submersible pumps of various capacities for domestic, municipal water supply.

**GRUNDFOS INTERNATIONAL A/S** Poul Due Jensens Vej, Bjerringbro, DK-8850, Denmark, Tel: +45-6681-400, Telex: 60731 GFOSDK, Fax: +45-6-684472, Contact: Mr Rassmufen. Manufacturers of water pumps, domestic circulators, industrial circulators, booster, boiler feed and general service pumps, sump pumps, deep well submersible pumps, in line and end suction pumps.

**HAYWARD TYLER LTD** 24 Crawley Green Rd, Luton, Beds, LU1 3LW, UK, Tel: +44-582-31144, Telex: 82158, Fax: +44-582-452198, Contact: Pat Clements. Borehole submersible pumps for water supply and irrigation.

**HOMA PUMPENFABRIK GmbH** Industriestr 1, Postfach 2020, Neunkirchen-Seelscheid 2, D-5206, West Germany, Tel: +49-2247-7020, Telex: 889448, Fax: 49-224770244. HOMA Pumps has been developing and producing submersible pumps for over 20 years. Its actual product range includes pumps for sewage and effluent treatment, drainage, irrigation, pumping chemicals, a full range of accessories and equipment.

**HYPRO CORPORATION** 375TH Fifth Avenue NW, New Brighton, MN, 55112, USA, Tel: +1-612-633-9300, Telex: 4310109, Fax: +1-612-633-6864, Contact: Mr Dean Johnson. Manufacturer of pumps and fluid handling accessories for high pressure cleaning, spraying and general liquid transfer. Roller pumps, centrifugal pumps and diaphragm pumps in a range of sizes.

**INTERTUB GERMANIA GmbH** Industriestrasse 7, Dogern, D-7891, West Germany, Tel: +49-7751-2106, Telex: 792219, Fax: +49-33-42701, Contact: Herr Fliet. Manufacturers and distributors of submersible pumps, water pumps, and vacuum pumps for a variety of applications.

**JLC PUMPS & ENGINEERING CO LTD** Oxgate Farm Works, Coles Green Rd, London, NW2 7EX, UK, Tel: +44-1-452-4081, Telex: 82317, Contact: Mr Catton. All types of pumps for all purposes.

**LAYNE & BOWLER INC** PO Box 8097 1993 Chelsea Avenue, Memphis, TN, 38108, USA, Tel: +1-901-278-

3800. Possessing a history that stretches back 93 years, Layne & Bowler is known throughout the world for its expertise in the design, manufacture and installation of vertical turbine pumps up to 30,000 GPM capacity. Products: vertical well pumps, short coupled service pumps, in-line pumps, submersible pumps, volatile liquid pumps and well screen.

**LUKO PUMPEN-MASCHINENFABRIK GESELLSCHAFT m b h** Grillgasse 15, Wien, A-1110, Austria, Tel: +43-222-74-5-63-63, Telex: 13-1600 luko a. Luko Pumpen-Maschinenfabrik GesmbH turn out series-produced displacement, rotary and submersible pumps. Luko self-priming rotary pumps, model Jonio, can be supplied ready fitted with electric motor or petrol or diesel engine. They are particularly suitable for conveying heavily contaminated, muddy and sandy waste water, even water of large-solid content. Luko normal-action pumps, Model N, are used for conveying highly contaminated water occurring in industry, agriculture and households.

**MARLEY PUMP COMPANY** 5800 Foxridge Drive, Mission, Kansas, 66204, USA, Tel: +1-913-831-5700, Fax: +1-913-362-3610. Manufacture quality submersible pumping equipment for domestic and municipal pumping of fresh water from boreholes, submersible pumps for sewerage handling, and submersibles for domestic drainage water pumping. Trade names - "Red Jacket", "Hydromatic" and "Simer".

**F E MYERS A PENTAIR COMPANY** 1101 Myers Parkway, Ashland, Ohio, 44805-1923, USA, Tel: +1-419-289-1144, Telex: 98-7443, Fax: +1-419-289-6658. Today, with more than 118 years of industry experience, F E Myers, a Pentair Company, manufactures submersible and centrifugal jet pumps for residential water systems, environmental waste handling pumps and systems, sump and sewage pumps, reciprocating and centrifugal industrial pumps, plus a wide range of repair parts and accessories.

**NEI - APE LTD LEE-HOWL (A DIVISION OF BELLISS & MORCROM)** Icknield Square, Birmingham, B16 0QL, UK, Tel: +44-21-454-3531, Telex: 337507, Fax: +44-21-455-8607, Contact: Dawn Lamb. Pump range includes submersible turbine borehole pumps, mixed flow bowl pumps, split casing water pumps, drywell and submersible sewage and solids handling pumps. Capacities 10 l/s to 350 l/s.

**PAIGE ELECTRIC CORP** PO Box 368, 1071 Hudson St, Union, New Jersey, 07083, USA, Tel: +1-201-687-7810, Telex: 138121, Fax: +1-201-687-2722, Contact: Mr Orlando Dirienzo. Design and supply cable for submersible pumps, agricultural and turf irrigation. Please contact for further details.

**PB PUMPENBOESE KG** P O Box 1250, Bugwedel 1 - / Hannover, D-3006, West Germany, Tel: +49-5139-80880, Telex: 17-04151398592. PB Pumpenboese KG produce a range of well screens and casings, submersible pumps, handpumps, dewatering equipment as well as hydrometric instruments and auxiliary drilling equipment.

**PEERLESS PUMP LTD** Ferry Lane, Brentford, Mid-





## **Myers Submersible Pumps**

# **A TRADITION OF MARKET LEADERSHIP THROUGH INNOVATION.**

Responding to the needs of drillers and installers with innovative technology keeps Myers at the front of the submersible pump marketplace. Exclusive design features make our Predator and Rustler series submersibles the most dependable and innovative pumps available. And Myers' heavy-duty NEMA motor delivers greater reliability for longer life.

Join the Myers team and get our tradition of exceptional products and excellence through distribution channels working for you. Contact your local distributor or call Myers at (419) 289-1144.

# **Myers®**

**WHERE INNOVATION MEETS TRADITION**

F.E. Myers, A Pentair Company  
1101 Myers Parkway  
Ashland, Ohio 44805-1923  
(419) 289-1144

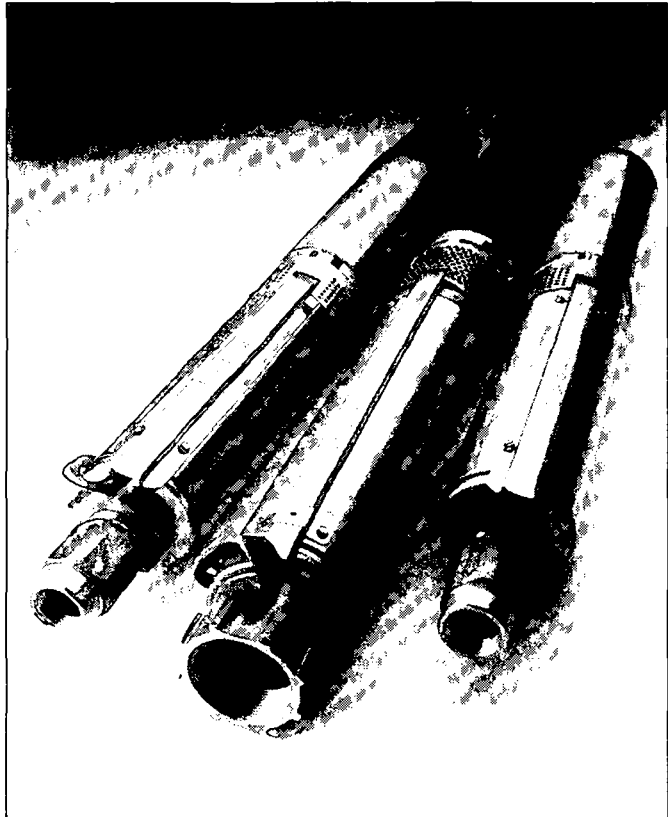

## GRINDER PUMPS SOLVE SEWAGE PROBLEMS IN RURAL AREAS

In many countries most of the waste water goes into the public sewer system. Despite this apparently satisfactory situation, there still remains a large volume of sewage which goes into septic tanks or untreated into the soil.

This situation is caused by the fact that it would be extremely costly, and in many cases virtually impossible due to terrain, to provide a conventional sewer system.

ABS Pumps, West Germany, have developed a grinder pump which uses narrow gauge plastic pipes in which sewage is pumped under pressure to a collection centre.

The grinding device chops up the destructible solids in the sewage into small particles, thus allowing the use of small gauge pipes (50mm).

The pump develops a high head – up to 30 metres – which means that the chopped up sewage can be pumped over long distances.

The ABS "PIRANHA" grinding system has been enthusiastically welcomed in several countries. In the USA the system was considered sufficiently innovative to attract federal grants of up to 85 per cent.

In the Netherlands, with its special problems of feeble gradients and numerous watercourses – don't forget that most of the country is under sea level – more than 100,000 units have been installed in the last few years. Up to 40 per cent of the Dutch installations use ABS "PIRANHA" pumps.

Low pressure individual sewers are also gaining popularity in the Gulf states, where the problem of flat gradients is compounded by high ambient temperatures making sewage go septic more quickly.

In Dubai, United Arab Emirates, ABS "PIRANHA" pumps working in pairs where the cheapest solution for connecting groups of two or three houses lying some way from the trunk sewer.

In the USA, the first large scale application solved a pollution problem from uncontrolled use of septic tanks around Lake of Egypt in Illinois. The shores of this artificial lake, dammed to provide cooling water for the Southern Illinois Electric Power Coopera-

tive, were gradually colonised by holiday homes. Some had little or no waste water treatment, others had poorly designed septic tanks, and many lacked proper drainage fields.

Conventional sewerage was prohibitively expensive – the buildings were strung out around an irregular 150km shoreline, at elevations varying by 60m, and rock is within one metre of the surface.

Twelve lift stations fitted with ABS submersible sewage pumps were installed in addition to 1,318 privately operated grinder stations.

The grinder stations are installed in people's gardens and run off the house-hold electricity supply, giving low-cost pre-treatment and sufficient head to the public sewer for onward transmission to the sewage works.

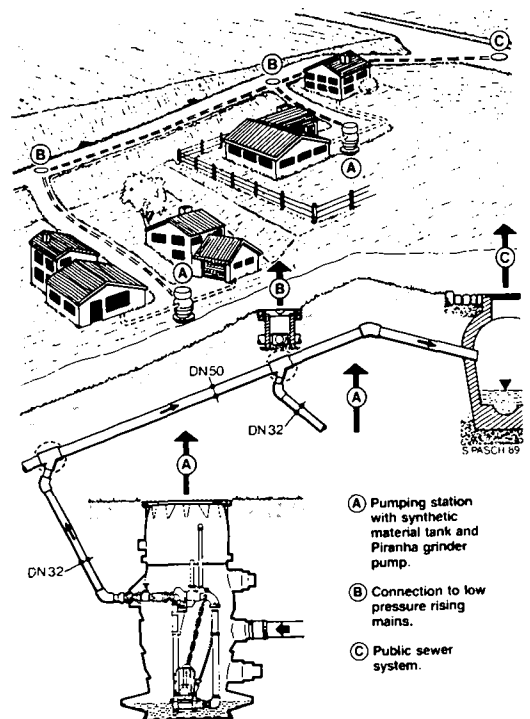

# 65.9% OF THE EARTH'S SURFACE CONSISTS OF WATER. AND WASTE WATER.

Water is the source of all life. And yet it is contaminated and poisoned increasingly – by volumes of waste water. This is why more and more communities, towns and countries now appreciate that the satisfactory disposal of sewage is just as important as the supply of drinking water.

Effective assistance is being provided by engineers and products from ABS Pumpen AG – throughout the world: submersible motor pumps with flow rates up to

11,000 l/s and motor outputs from 0.2 kW to 500 kW. These units are incorporated in systems for industry, Water Authorities and Local Authorities.

ABS Pumpen AG, Scheiderhöhe,  
D-5204 Lohmar, Telephone 49/2246/13-0.



*ABS Pumpen-Technik  
Aktiengesellschaft  
West-Germany, Rep. of Ireland, France, Brazil, USA*

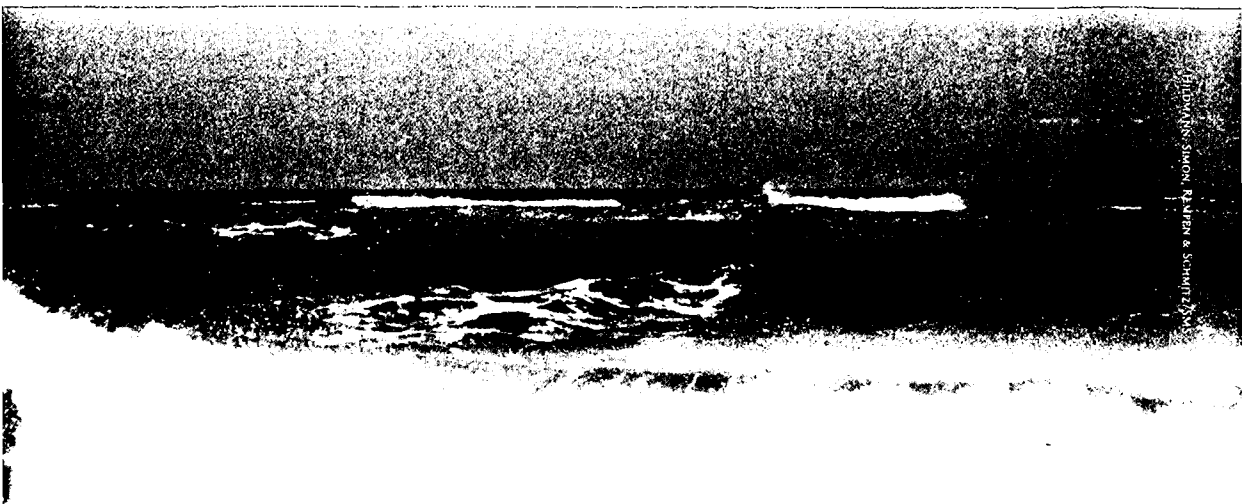

PHOTO: NIS-SIMON, RAUEN & SCHMITZ

## PUMPS- SUBMERSIBLE

dlexex, TW8 0AL, UK, Tel: +44-1-560-3922, Contact: Pat Clements. Borehole submersible pumps for water supply and irrigation.

**PLEUGER** Friedrich-Ebert-Damm 105, Hamburg 70, D-2000, West Germany, Tel: +49-40-6946-0, Telex: 213-275/274. Complete range of electrically driven submersible pumps and motors from 4 to 60". Flow rates from about 1 to 30.000m<sup>3</sup>/h. Motors ratings from 0.37 to 5.000KW. Also suppliers of control panels, water level monitoring systems, water level measuring systems, etc.

**POMPE PORCELLI ELVIO & FIGLI SNC S S** 148 KM 82,500, B GO S Donato, Sabaudia (LT), 04010, Italy, Tel: +39-773-50392-3, Fax: +39-773-50393, Contact: Mrs S Battini. Range of pumps from deep well vertical and horizontal pumps, electric submersible, centrifugal and trolleyed pumps.

**PSL INTERNATIONAL LTD** PO Box 4, Humber Rd, Barton-on-Humber, South Humberside, DN18 5BN, UK, Tel: +44-652-32702, Telex: 527305, Fax: +44-652-33401, Contact: Mrs McKenzie. Rotating equipment engineers - pumps, turbines and compressors, particularly for the water industry. Repairs to submersible pumps.

**PUMP TECHNICAL SERVICES LTD** Becco Works Kent House Lane, Beckenham, Kent, BR3 11A, UK, Tel: +441-778-4271, Fax: +441-659-3576, Contact: Steven Kavanagh. Pump Technical Services are currently enjoying their sixtieth year in the pumping industry. The association with jung pumpen of West Germany has proved very successful. Broadwall jung having become synonymous with sewage and surface water pumping, for civil and water authorities. Special packaged sets, drainers, macerators and corrosion resistant pumps.

**PUMPING SERVICE (GB) LTD** Whitehouse St, Jack Lane, Hunslet, Leeds, LS10 1AD, UK, Tel: +44-532-446111, Telex: 557445, Fax: +44-532-465649, Contact: Mr Fox. Distributors for most of the leading British pump manufacturers. Around 2,000 pumps of various sizes and types in stock at any time, covering all applications.

**R GOODWIN INTERNATIONAL LTD** Goodwin House, Ivy House Rd, Hanley, Stoke on Trent, ST1 3NR, UK, Tel: +44-782-208040, Telex: 36259, Fax: +44-782-208060, Contact: Brian Haliday. Manufacture specialist pumps and valves.

**S & N PUMP CO** 7545 Breen, Houston, TX, 77086, USA, Tel: +1-713-445-2243. Submersible systems specialist.

**OY E SARLIN AB** Po Box 750, Helsinki 10, 00101, Finland, Tel: +358-0-535022, Telex: 121894, Fax: +358-0-5633989, Contact: Mr Saaremi. Sarlin is a manufacturer of submersible pumps for sewerage systems, raw water intake, dewatering, irrigation and flood control. Pumps are easy to install and maintain.

**SARLIN LTD (PUMPS DIVISION)** Imperial House, St Nicholas Circle, Leicester, L91 4LF, UK, Tel: +44-533-531245, Telex: 341617, Fax: +44-533-26636, Contact: Mr

Andrews. Supply, deliver and install a comprehensive range of submersible sewage and effluent pumps complete with ancillary equipment. Products include pumps with vortex or channel impellers and motor sizes up to 160kw.

**SCANPUMP AB** P O Box 2053, Holmdal, S43102, Sweden, Tel: +46-3183-6300, Telex: 20626, Fax: +46-31184906, Contact: Mr Zettrling. Supplier of all kinds of centrifugal pumps, including submersible. Capacities up to 18,000 m<sup>3</sup>/hr.

**T R REDA PUMP DIVISION** Yiewsley Grange, High St, Yiewsley, Middlesex, UB7 7QP, UK, Tel: +44-895-422115, Fax: +44-895-448599, Contact: Mr McDonald. World leading manufacturers and distributors of electrical submersible pumps for oil and water in associated industries.

**THE GORMAN - RUPP INTERNATIONAL COMPANY** P O Box 1217, Mansfield, Ohio, 44901-1217, USA, Tel: +1419-755-1011, Fax: +1419-755-1251, Contact: Pam Hamilton. Manufacturers of self-priming centrifugal pumps, trash-handling, clear-water and sewage pumps. Gorman - Rupp also manufacture a line of submersibles, diaphragmpumps and straight centrifugals.

**THOMPSONS KELLY & LEWIS LIMITED** PO Box 160, Springvale, Victoria, 3171, Australia, Tel: +61-3-562-0744, Fax: +61-3-562-0885, Contact: Ruedi Birmele. Thompsons, Kelly & Lewis is Australia's leading manufacturer and supplier of a complete range of centrifugal and positive displacement pumps for use throughout the water industry from rural ground water to industrial and sewerage.

**TORRENT PUMP INDUSTRIES** P O Box 51066, Kri-fissia, GR-145-10, Greece, Tel: +30-1-81617128161702, Telex: 215870, Fax: +30-1-8161018. "Torrent" submersible electric pumps and "sta-rite/kazis" submersible pumps and accessories.

**TOTTEN PUMPS LTD** Southampton Rd, Cadman, Southampton, SO4 2MS, UK, Tel: +44-703-813136, Fax: +44-703-813-650, Contact: Mr Bran. Manufacturers of magnetically coupled centrifugal pumps, diaphragm pumps, submersible column pumps and small electric motors to 80 watt output.

**STUART TURNER LTD** Market Place, Henley on Thames, Oxon, RG9 2AD, UK, Tel: +44-491-572655, Telex: 847093, Fax: +44-491-573704, Contact: Mr Thompson. Stuart Turner Ltd manufacture a range of centrifugal and regenerative pumps up to 4 hp with flow rates up to 6000 gph. Also supplied are submersible pumps suitable for up to 2000 gph.

**ULTRA POMPES SA** 47 BD Georges Clemenceau, Courbevoie, 92400, France, Tel: +33-16-1-43-33-53-90, Telex: POMP5YK 611432 F. Centrifugal self priming pumps from 18 to 200 M<sup>3</sup>/H, submersible drainage pumps from 11.5 to 50 M<sup>3</sup>/H and diaphragm pumps.

**WARSOP POWER TOOLS** Hever Rd, Edenbridge, Kent, TN8 5DL, UK, Tel: +44732-863081, Telex: 95155,

## PUMPS- SUBMERSIBLE

Fax: +44732-865680, Contact: Mr Lambert. Warsop manufacture and market a range of pumps, which comprise self priming centrifugals, submersibles, diaphragm and flexible shaft driven types. Suitable for clean water or water containing up to 40% solids in suspension.

**WEBER INDUSTRIES INC - WEBTROL PUMPS** 8417 New Hampshire Ave, St Louis, MO, 63123, USA, Tel: +1-314-6319200, Telex: 364412, Fax: +1-314-8427918, Contact: Joyce Molwak. Manufacture industrial and domestic water pumps. High pressure-low flow booster pumps available: 5-80 GPM and HP from 1/3 to 40 HP pumps used for chlorination, RO and ultra filtration.

**WEIR PUMPS LTD** Newlands Rd, Cathcart, Glasgow, G44 4EX, UK, Tel: +44-41-637-7141, Telex: 77161, Contact: Mr Inker. For water supply and sewage treatment: abstraction pumps, borehole pumps (shaft driven and submersible), pipeline and other distribution pumps, water treatment system pumps, sewage pumps, submersible sewage and land drainage pumps, complete pumping systems and controls, contract management, surge assessment of pumping systems, including the supply and setting to work of the necessary equipment, comprehensive facilities for model testing of pump sumps and complete intake systems.

### Miscellaneous Mechanical Equipment, Including Compressors and Blowers

**ACROMET (AUST) PTY LTD** 14 Winterton Rd, Clayton, Victoria, 3168, Australia, Tel: +61-3-544-7333, Fax: +61-3-543-6706, Contact: Ernest A Hair. Acromet is an Australian manufacturer of chemical metering pumps and dry chemical feeders and a distributor of gas chlorination equipment and chemical pumps, both diaphragm and centrifugal, in plastic and special alloy construction. Acromet pumps and feeders are widely used throughout Australasia and South East Asia in water and wastewater treatment plants, and have an even wider range of applications in industry. Distributorships are available in many parts of the world.

**AIR POWER AND HYDRAULICS** 2 Erskine Square, Hillington Estate, Glasgow, G52 4PQ, UK, Tel: +44-41-810-4511, Telex: 777819, Fax: +44-41-883-3825, Contact: Ms Links. An independent company specialising in the design and manufacture of a complete range of hydraulic cylinders, sub c cylinders, activators and power units.

**ALL SPEEDS LTD** PO Box 43, Royal Works, Accrington, Lancs, BB5 5LP, UK, Tel: +44-254-354419, Telex: 63242, Fax: +44-254-382-899. Supply mechanical variable speed drives suitable for pumps and electronic A/C inverters with a built in pump programme.

**ANGUS AND CO LTD (GEO)** Fluid Seal Div, Coast Rd, Wallsend, Tyne and Wear, NE28 9NR, UK, Tel: +44-91-262-4551, Telex: 53628, Fax: +44-91-263-4301,

Contact: Mr Mcmenzie. Manufacturer of oil seals and hydraulic/pneumatic packings, diaphragms, gaskets, o-rings, mechanical seals etc.

**ANSALDO SISTEMI INDUSTRIALI SpA** Via Pieragostini 50, Genoa, 16151, Italy, Tel: +39-10-41-031, Telex: 281311 ANGASI I, Fax: +39-10-42-0451, Contact: Mr Brandinelli. Ansaldo Sistemi Industriali SpA is the contracting and engineering Company of Ansaldo operating in the field of industrial and electromechanical plants, of material handling and hydraulic systems, of port, ship and offshore systems, of territory architect engineering.

**AQUATICS UNLIMITED** 2150 Franklin Canyon Rd, Martinez, CA, 94553, USA, Tel: +1-415-370-9175, Fax: +1-415-370-9179, Contact: James R Ziegler. Manufacturer of Aquamog-a multi purpose marine maintenance vessel with many easily interchangeable attachments. Aquamog cuts aquatic weeds deep and fast, rotovates hydrosoil, removes rooted vegetation. Aquamog is a powerful suction dredge and bucket dredge. Self propelled, eliminates cables, reduces downtime, reaches under piers, inside boatslips, close to shore and cleans waterways.

**ATLAS COPCO ENERGY AB** S-105 23, Stockholm, Sweden, Tel: +46-8-743-80-00, Telex: 14090 copco s, Fax: +46-8-716-59-75. Atlas Copco Energy offers a complete range of high pressure compressors for deep air drilling, portable compressors and compressors mounted on special carriers (e. g. customized for off-road trailers), as well as booster compressors.

**BESTOBELL SEALS** 202-208 Bath Rd, Slough, Berks, SL1 4DP, UK, Tel: +44-753-20222, Telex: 847285, Fax: +44-753-691145, Contact: John Phillips. Manufacturers and suppliers of mechanical seals from 6mm shaft upwards, including split-face types. Wide range of material combinations available.

**BRITISH AUTOGUARD LTD** A Thousand Oaks, Maysey Hampton, Cirencester, Glos, GL7 5LH, UK, Tel: +44-285-713555, Telex: 437114, Fax: +44-285-713556, Contact: Mr Bailey. British Autogard are Market leaders in overload torque protection and control systems, covering a torque range from 28/57,000nm. Typical drives protected in the water industry include: screens collectors, clarifiers thickeners, screw pumps, scrapers etc.

**CHICAGO HEATER COMPANY INC** 425 Broad Hollow Rd Melville New York 11746 USA Tel: +1-516-694-3100, Fax: , Contact: . Since 1949 Chicago Heater has been intimately involved in the design of deaeration equipment for broad markets, including electric generating, industrial, marine, institutional and commercial construction.

**CONTINENTAL INOUSTRIE** 10 Rue Du Capitaine-Ferber, Villeurbanne, F-69100, France, Tel: +33-78-93-25-96, Telex: 900855, Fax: +33-78-89-65-58, Contact: Clair Barrachin. Manufacture multi-cellular centrifugal blowers and exhausters.

**JOHN CRANE UK LTD** Crossbow House, 40 Liver-

## MISCELLANEOUS MECHANICAL EQUIPMENT

pool Rd, Slough, SL1 4QX, UK, Tel: +44-753-31122, Telex: 848176, Fax: +44-753-73677, Contact: Viv Harman. Mechanical sales, gland packings and PTFE products, for reliable sealing of rotating shafts in pumps, compressors, mixing vessels and valves. Ancillary equipment, increasing the working life of our standard products.

**DRG KWIKSEAL PRODUCTS** The Woodside Estate, Dunstable, Beds, LU5 4TP, UK, Tel: +44-582-696666, Telex: 826040, Fax: +44-582-471085, Contact: Marie Henderson. DRG Kwikseal Products manufacture single and double-sided self-adhesive foam tapes, strip adhesive, preformed butyls and gun-grade sealants under the trade names of Inseal, Kwikstik and IDL.

**EFIMEX sa SITINDUSTRIE GROUP** 8, Rue du 31 Decembre, 1207-Geneva, Switzerland Tel: +41-227366610, Telex: +289392 EFST, Fax: +41-227366610. EFIMEX is dedicated to oil and water well equipment since 1974 as part of the SITindustrie group it constitutes a major manufacturing source for: - pump riser pipes in stainless steel, carbon steel supplied with flanges or threaded connectors - well heads in stainless steel - stainless steel fittings, tees and elbows.

**EUTECTIC CO LTD** Central Way, Feltham, Middlesex, TW14 0UE, UK, Tel: +44-890-3680, Telex: 27966, Fax: +44-751-2038, Contact: Don Gathercole. Suppliers of welding consumables and equipment for maintenance and repair welding.

**F F LUFT A/S M Svendsens Vej 2, Bjerringbro, DK-8850, Denmark, Tel: +45-86-68-18-00, Fax: +45-86-68-03-04, Contact: Arne K Pedersen. Established 1919. Having manufactured engines for 40 years, and piston air compressors for over 30 years, F F Luft a/s has the know-how needed when it comes to being a leading manufacturer of high quality compressors. Export to most European countries, Middle East and Africa.**

**FABBRICA TURBINE E CALDAIE F T C Legnano Srl** Piazza Monumento, 12 - Legnano, Milan, 20025, Italy, Tel: +39-331-522-111, Telex: 330661-314385 F TOSI, Fax: +39-331-593-321. Fabbrica Turbine E Caldaie - FTC Legnano SRL (Franco Tosi Group) represents a wealth of know-how and experience in the fields of generation, conversion, utilization and recovery of energy in its various forms, as well as in other areas such as sea water desalination, ship propulsion and in general industrial plants, where equipment produced by the company finds a field of application.

**FIBERGRATE CORP** P O Box 814610, Dallas, Texas, 75381-4610, USA, Tel: +1-214-250-1633, Fax: +1-214-250-1530, Contact: David L Eberhart. Manufacturer of fibreglass grating, walkways, platforms, bridges, ladders, handrail and other corrosion - resistant pedestrian facilities, complete concept to completion capabilities including design and installation.

**THE GLACIER METAL CO** Argyle House, Joel St, Northwood Hills, Middlesex, HA6 1LN, UK, Tel: +44-9274-26100, Telex: 936881 glamet G, Fax: +44-9274-26507, Contact: Tim Clark. Manufacturers of a wide variety of plain bearings (including Du Hi-ex and Deva).

**GREAT LAKES HYDRAULIC INC** 4170 36th St, S E Grand Rapids, Michigan, 49508, USA, Tel: +1-616-949-8844, Fax: +1-616-949-6598, Contact: Dave Van Der Dean. Manufacturer of the "Infidrive" a variable speed drive which works on oil-shear principle for torque transmission. Used primarily in pumping applications to control flow, level and pressure.

**HOERBIGER FLUIDTECHNIK KG** Prince-Eugen-Strasse 70, Wien, A-1040, Austria, Tel: +43-222-65-67-01-0, Telex: 133687, Contact: . In the hydraulic sector Hoerbiger Fluidtechnik offer the following products and services: hydraulic cylinders, adapted in size, capacity and operation to various requirements and with piston diameters up to 550mm and stroke length of 8m, hydraulic power units, geared to control and space requirements and built up from standardised sub-assemblies, hydraulic valve blocks, as complete and compact solutions to relevant problems, and the design and construction of complete hydraulic systems.

**HUBERTS BV** PO Box 251, Veghel, AG, 5460, The Netherlands, Tel: +31-41-30-66811/41-30-42275, Telex: 74645, Fax: +31-4130-42029, Contact: Ms Ira Turner. Import/export wholesale company in mainly wood-working and metalworking machines for semi-industrial purposes: metal lathes, wood lathes, bench grinders, (pedestal) drilling machines, air tools, compressors, water pumps, electric motors, band sawing machines, metal sawing machines, welding equipment and dust exhausters.

**HYDROVANE COMPRESSOR CO LTD** Claybrook Drive, Washford Industrial Estate, Redditch, Worcs, B98 0DS, UK, Tel: +44-527-25522, Telex: 339843 hyuane G, Fax: +44-527-21140, Contact: Neil Botting. Manufacturers of industrial and portable rotary vane compressors.

**IMI FLUIDAIR LTD** Miller St, Radcliff, Manchester, M26 0JB, UK, Tel: +44-4955-57722, Telex: 667071 imiflu, Fax: +44-61-724-8272, Contact: MR Satchwell. Rotary air compressors, air dryers and rotary vacuum pumps.

**INTERNATIONAL MACHINERY CONSULTANTS INC** PO Box 700, Cabano, Quebec, G0L 1E0, Canada, Tel: +1-418-492-1261, Fax: +1-418-929/308, Contact: Sylvia Pellepier. International machinery consultants trade in heavy machinery for multiple applications.

**IPSCO (UK) LIMITED** 22 Hoylake Rd, South Park Industrial Estate, Scunthorpe, South Humberside, DN17 2TT, UK, Tel: +44-724-849904, Telex: 52597, Fax: +44-724-861033, Contact: Mr Robin Moffatt. Manufacturers of underpressure drilling machines and linestopping equipment, or alternatively provision of service facility, hiring equipment and supervisor.

**KEMUTEC GROUP LTD** Hulley Rd Hurdfield Industrial Estate, Macclesfield, Cheshire, SK10 2ND, UK, Tel: +44-625-28733, Fax: +44-625-27319, Contact: K V Simpson. Manufacturers of powder processing equipment and systems for the food, pharmaceutical, chemicals and water industries. Offer a full range of vibratory, volumetric and loss-in-weight metering feeders for dosing dry additives into water and sewage flows.

## MISCELLANEOUS MECHANICAL EQUIPMENT

All make powder mixers and centrifugal sifting equipment.

**KINGSBURY INC** 10385 Drummond Rd, Philadelphia, PA, 19154, USA, Tel: +1-215-824-4000, Telex: 710-670-1897, Fax: +1-215-824-4999, Contact: Andrew M Tukula. Designers and manufacturers of fluid film bearings and magnetic bearings systems.

**KLINGER LTD** Klingerit Works, Sidcup, Kent, DA14 5AG, UK, Tel: +44-300-7777, Fax: +44-302-8145, Contact: Mr Thomas. Manufacturers of gasket material (P. T. F. E) and joint sealant (Sealex) to WRC standards.

**LUMATIC LTD** Ponswood, Hastings, East Sussex, TN34 1YS, UK, Tel: +44-424-436343, Telex: 95202, Fax: +44-424-429926, Contact: Mr Higham. Suppliers of lubrication systems for machinery and plant in the water industry.

**MEDCRAFT BROTHERS LTD** Hertford Rd, Barking, Essex, IG11 8BH, UK, Tel: +4-1-594-4101, Fax: +44-1-594-1863, Contact: Mr Jennings. Rubber engineers with expertise in the conversion of rubber encompassing, gaskets, bushes, extrusions, mouldings, rubber metal bonding, vulcanised sections, fabrications into complex shapes by stripping, drilling, milling, grinding and trepanning.

**METALOCK INTERNATIONAL LTD** Metalock House, Crabtree Manor Way, Belvedere, Kent, BA17 6AB, UK, Tel: +44-311-4040, Telex: 894491, Fax: +44-310-3902, Contact: Mr Bellamy. Specialists in the cold repair of broken castings, pump bodies, pipes, etc. Carried out on site or at workshops located throughout the world.

**MEWESTA HYDRAULIC GMBH** Dottinger Str 67 Munsingen D-7420 West Germany Tel: 49-7381-2510, Telex: 719336, Fax: 49-7381-3479, Contact: . Production line: standard series connection plates and hydraulics directing blocks for all hydraulically applications from cast iron - steel - aluminium up to a weight of 100kp per piece, to the requirements of the customers.

**OCHSNER GESELLSCHAFT M b h & CO P O BOX 60, Oberfeldstrasse 8, Linz, A-4024, Austria, Tel: +43-732-41-3-58, Telex: 02-1439 ochsnr a, Contact: . For over 100 years Ochsner have produced pumps and compressors for the chemical, petrochemical and refining industries and for use in irrigation plants. The line-up includes water and waste water pumps (also pumps for the heavy industry) displaying the following characteristics: delivery up to 8,000m<sup>3</sup>/h, lift up to 700m, drive capacity up to 1,500kW. Materials used are alloyed and unalloyed metals depending on operating conditions. Rotary compressors for charging biogas meters and water compressors as biogas compressors for gas lances for sludge activation are also turned out.**

**MARK RAINER INTERNATIONAL LTD** Leamore Close Leamore Industrial Estate, Walsall, West Midlands, WS2 7NL, UK, Tel: +44-922-401408/401433, Telex: 334173 MARAIN G, Fax: +44-922-495958. Mark Rainer International Ltd specialise in the design and manufacture of handrailing, flooring, access equipment and

associated steelwork. All products are available in a variety of materials to suit different installation requirements. These materials include aluminium, galvanised mild steel, stainless steel and GRP. The company's products are in use throughout the world and comply with relevant safety standards or specifications in all installations.

**ROOTS SYSTEMS (1984) LTD** Upper Mills Estate, Bristol Rd, Stonehouse, Glos, GL10 2BJ, UK, Tel: +44-45382-6581, Telex: 43598, Fax: +44-45382-6122, Contact: Mr Hook. Air and gas blowers for water and sewage treatment works.

**THE REISS ENGINEERING CO LTD** 2 Dalston Gardens, Stanmore, Middx, HA7 1BQ, UK, Tel: +44-1-204-7155, Telex: 935400, Fax: +44-1-206-0459, Contact: Mr Chapman. The company operates a valve division, manufacturing and marketing a range of knife gate valves and penstocks. High pressure pumps for cleaning. Also Reiss operate as agents for Ronningen Petter Portage USA for their range of filtration and strainer equipment.

**JAMES WALKER & CO LTD** Lion Works, Woking, Surrey, GU22 8AP, UK, Tel: +44-483-757575, Telex: 859221, Fax: +44-483-755711, Contact: Mr Thatcher. Manufacturers of pump packing and valve packing, seals and gaskets. Agents throughout the world.

### DEVELOPING WORLD WATER

**E**ntries ending in WT are taken from Water Technology Magazine's Planning and Purchasing Handbook. The subscription address is: Water Technology Magazine, 13 Century Hill Dr, Latham, NY 12110, USA. Telephone (518) 783-1281. Entries ending in IAWPRC are reproduced from the 1987-88 Yearbook of the International Association on Water Pollution Research & Control (IAWPRC) with the Association's consent. IAWPRC, 1 Queen Anne's Gate, London SW1H 9BT, England.

# JOHNSON CONTROLS PROVIDES COMPUTERIZED SOLUTIONS FOR THE WATER INDUSTRY

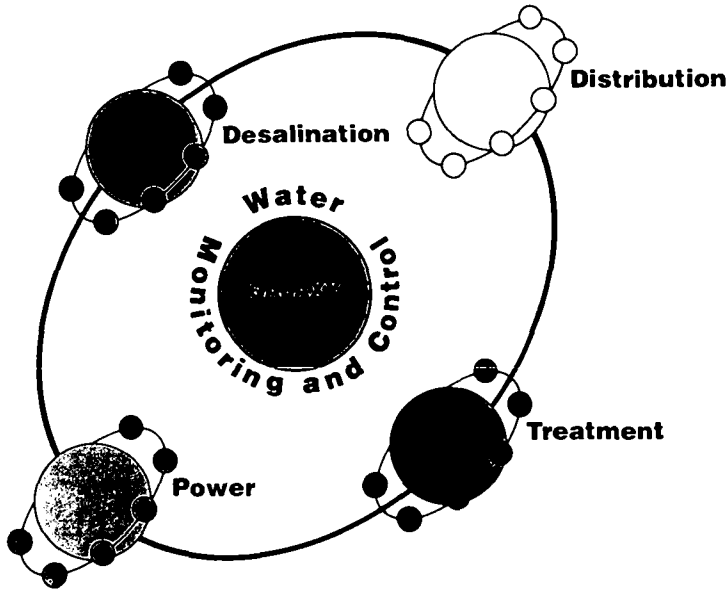

**\* Desalination**

- Pressures
- Temperatures
- Production

**\* Distribution**

- Irrigation
- Aqueducts
- Pipelines
- Canals

**\* Power**

- Dams
- Turbines
- Gates
- Grids

**\* Treatment**

- Drinking Water
- Sewerage
- Wastewater
- Sludge

*Stars In The Galaxy  
Universe Of Applications*

**W**hether your application concerns water desalination, distribution, treatment, or power, there is a Galaxy™ Automation System that will meet your monitoring and control requirements.

Galaxy's unique distribution of functionality among its components is just one of the many design features that places Galaxy far ahead of the competition. Each of the primary components contribute intelligent control to its tasks. This increases system efficiency, modularity, redundancy, versatility, and expandability.

Galaxy's versatile architecture accommodates small dedicated projects as well as large distributed monitoring and control applications. The automation system of the future is available today. Our optional artificial intelligence module can ensure that an expert is always in control.

**A**s a leader in monitoring and control of operations and facilities for over a century, Johnson Controls has the people, products, and state-of-the-art expertise to ensure the success of your project.

We can provide complete engineering design, procurement, assembly, integration, testing, installation, and start-up of your new system. Alternatively, we can enhance your existing system. Our support program includes operations and maintenance documentation, training, service, and continuing maintenance. Each Galaxy System comes with a guarantee of customer satisfaction.

**W**hatever your automation system requirements, Johnson Controls wants to ensure your success. Galaxy automation solutions can meet your needs both today and tomorrow. No matter where your problem exists in the Automation Universe, Johnson Controls' solutions are designed to brighten your stars and your future.

**JOHNSON  
CONTROLS**

**Johnson Controls International, Inc.**

150 NORTH HILL DRIVE  
BRISBANE, CA 94005 USA  
FAX: (415) 468-6363  
TELEPHONE: (415) 468-6050



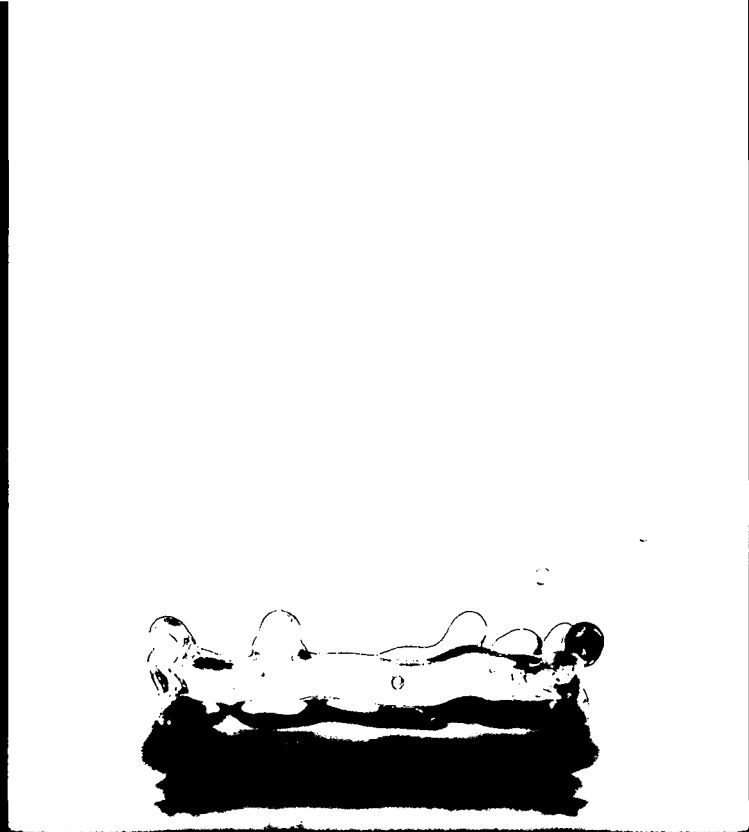

www.bentley.com

© Bentley Systems, Inc. 2007

• Instrumentation,  
Control & Analysis •

# INSTRUMENTATION, CONTROL AND ANALYSIS

by

L. G. Hutton

**Modern techniques in control, instrumentation and data gathering are being used throughout the world to improve water supply.**

These vary from the use of satellite imagery and geophysics exploration to computer aided design of systems and laboratory automation for testing the end product.

However, the use of new techniques must be appropriate to the situation. Professor Dan Okun's statement in "Developing World Water 1988" must always be borne in mind:

"The key requirement for an appropriate solution is that it be selected in the light of local circumstances, with particular attention to the human, material and financial resources available for operation and maintenance."

No matter how advanced the instrumentation, decision-taking must be done by human operators. Visual on-site inspection is still often the most effective means of providing information. It can, but not always, be the most expensive means.

New techniques have their place in terms of continuous routine control and in pinpointing areas of interest.

One of the problems with implementing more up-to-date techniques is that highly-placed decision takers are not always aware of their value. For example, while drilling will always be necessary to definitely prove the presence of groundwater, personnel skilled in remote sensing and geophysical techniques can predict likely high yielding zones using these exploration tools. This greatly reduces the cost of wildcat drilling.

Evaluation of surface water supply still depends on basic methods of data gathering. Simple rain gauges, stream flow gauges and meteorological equipment have to be in place for several years in order to provide useful historical data.

But these instruments do have to be read regularly. Data loggers, automatic recorders and ground transmission to satellites will enable this to be done remotely in future with occasional maintenance checks. An ultrasonic device with no moving parts (which would otherwise be a maintenance problem) can presently monitor levels of water and rates of water flow.

In the U.K. the reliability of automatic quality testing and control dosing is now being investigated, aided

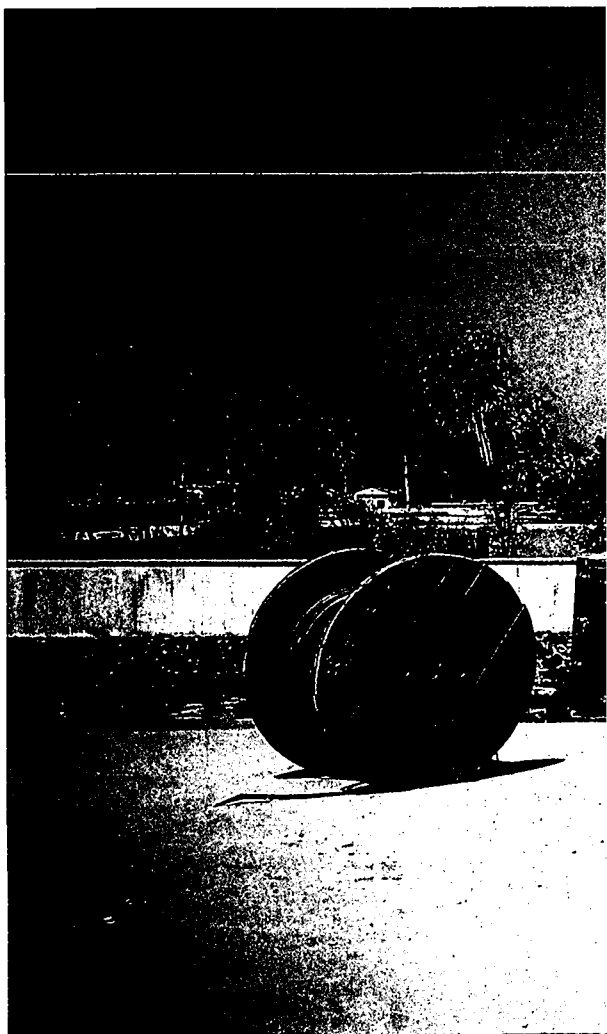

## INSTRUMENTATION, CONTROL & ANALYSIS

by a new technique called vibrational analysis to check the performance of pumps and motors. Once proved, these systems should work regardless of weather conditions, but their use must be tailored to the situation. In the U.K. there is a need to reduce manpower; elsewhere there may be a need to employ more people. Automatic systems are usually complex technologically. Who will repair and maintain such systems overseas? At what cost? Where will the parts come from? This serves as a reminder to the manager to assess the use of modern technology in the light of operating conditions.

Applications of new technology to water transmission and distribution systems are currently exploited in location of pipes, valves and leaks. Variable speed control and switchgear for pumps can save power consumption and prevent damage to equipments due to erratic power supplies.

The use of microcomputers in water supply and sewerage management systems will continue to influ-

ence planning, design, operations and financial control. The use of expert systems for all aspects has the potential for a great impact on development.

Water quality measurements have been made easier by modern technology. Analytical instruments are often at the leading edge of technology. Basic equipment for bacteriological testing is becoming more widely available but incubators are still too costly. More financial provision for water quality improvement needs to be made to complement the provision of water quantity which have so far been made during the Water Decade. There is also a need for more trained staff qualified to carry out bacteriological analyses.

In the field of water, sanitation and health there is plenty of opportunity to use new instrumental technology appropriately. The selection of such equipment needs to be made carefully with the consideration of capital and maintenance costs to be weighed against the cost of manual operation of simpler techniques. •

*Power supply can be monitored and controlled by switchgear to prevent overloads and other damage to electrical equipment. Kabul, Afghanistan*

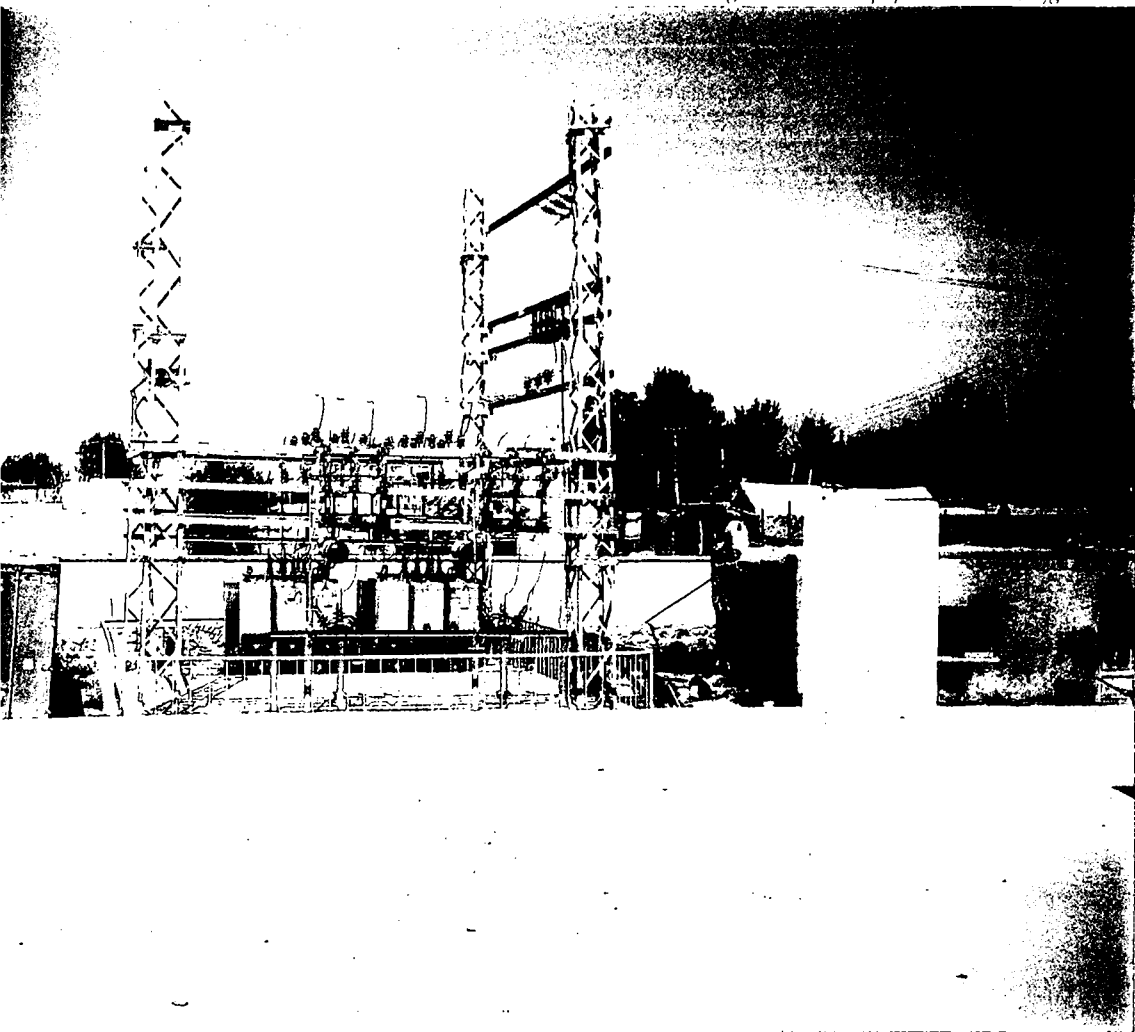

### Analysers, Electrodes and Meters

**PHOX SYSTEMS LTD** Ivel Rd, Shefford, Beds, SG17 5JU, UK, Tel: +44-462-813103, Telex: 825480, Fax: +44-462-814191, Contact: Mr Crossley. Instrumentation and systems for the water and process industries. Represented throughout the world. On-site advice available.

**ACAL AURIEMA LTD** 442 Bath Rd, Slough, Berks, SL1 6BB, UK, Tel: +44-6286-4353, Telex: 847155, Fax: +44-6286-3730, Contact: Mr Ridgewell. Process analysers, fluid controls, industrial data systems, industrial instruments, instrument hire service, components and refrigeration products.

**ANALYTICAL MEASUREMENTS LTD** Spring Corner, Feltham, Middlesex, TW13 4PB, UK, Tel: +44-1-890-5079, Contact: Ms Dymek. Suppliers of pH and redox meters, recorders and controllers, both portable and main. Manufacturers of ancillary equipment such as electrodes.

**ANALYTICAL MEASURING SYSTEMS** London Rd Pampuford, Cambridge, CB2 4EF, UK, Tel: +44-223-836001, Fax: +44-223-837417, Contact: Dr Paul S Pover. Manufacturer and distributor of laboratory instrumentation. Principal products are image analysers, gas chromatographs, colony counters and particle size analysers. We have an established presence in bacteriological and chemical monitoring in the water industry.

**ARIZONA INSTRUMENTS CORP** 1100 E University Drive, Temple, Arizona, 85281, USA, Tel: +1-602-731-3400, Telex: 910-950-0134, Fax: +1-602-731-3434, Contact: Wanda Randall. Manufacture mercury analysers and hydrogen sulphide analysers for the water industry.

**ARKON INSTRUMENTS LTD** Unit C3, Liddington Trading Estate, Old Station Drive, Leckhampton, Cheltenham, Glos, GL53 0DL, UK, Tel: +44-242-573444, Telex: 437269, Fax: +44-242-221701, Contact: Mr Brian Scott. Specialist suppliers of instrumentation for flow level, pressure and vacuum for water, gas and air. Also supply analytical instruments for the water industry ie: pH, redox, dissolved oxygen etc.

**AZTEC ENVIRONMENTAL CONTROL LTD** 8 Hawksworth Rd Southmead Industrial Park, Oxon, OX11 7HR, UK, Tel: +44-235-512000, Fax: +44-235-512020. Aztec manufacture and supply a range of on-line, wet, chemistry, computer controlled water quality monitors to assist and monitor the operation of municipal or industrial water treatment plants. The parameters include aluminium, iron, colour, colour/turbidity, nitrate, phosphate and manganese. They have automatic calibration and both digital RS232 and 4-20 mA analogue outputs, plus a range of self diagnostics.

**BECKMAN INDUSTRIAL CORPORATION** Cedar Grove Division, 89 Commerce Rd, Cedar Grove, NJ, 07009, USA, Tel: +1-201-239-6200, Telex: 710-994-5781, Fax: +1-201-857-9403, Contact: Mr Cuizy. Beckman industrial smart family solu comp® micro-processor

based water analysers are high purity resistivity and conductivity analysers with patented cell design for pure water measurement.

**CAPITAL CONTROL CO INC** P O Box 211, Colmar, PA, 18915, USA, Tel: +1-215-882-2901. Manufacturer and distributor of equipment and systems for water disinfection and analysis.

**CAPITAL CONTROLS LTD** Crown Quay Lane, Sittingbourne, Kent, ME10 3JG, UK, Tel: +44-795-76241, Fax: +44-795-79052, Contact: Mr White. Capital Controls manufacture a complete range of disinfection and chlorination equipment together with analysers for the measurement of residual content.

**CHEMLAB-INSTRUMENTS LTD** Hornminster House 129 Upminster Rd, Hornchurch, Essex, RM11 3XJ, UK, Tel: +44-4024-57011, Telex: 8951347, Contact: Jeff Cox. Chemlab Instruments is an acknowledged leader in the field of water analysis, sterilisation and laboratory purification. Products include peristaltic pumps, reverse osmosis, multichannel analysers, monitors, sterilisers, flow injection and laboratory equipment.

**CITY TECHNOLOGY LTD** 167-173 Goswell Rd, London, EC1V 7HE, UK, Tel: +44-1-253-3799, Fax: +44-1-608-1182, Contact: Peter Sullivan. City Technology Ltd is an independent manufacturer of electrochemical gas sensors, trademark Citicel®. The company supplies citicels to oems and instrument manufacturers for use in the detection of oxygen, carbon monoxide, hydrogen sulphide, sulphur dioxide, nitric oxide, nitrogen dioxide, chlorine, hydrogen, phosphine, hydrogen cyanide and hydrogen chloride.

**CONTINENTAL HYDRODYNE SYSTEMS INC** P O Box 116 102 S Main St, S Lebanon, OH, 45065, USA, Tel: +1-513-494-2587. Manufacturer of water analysis equipment.

**DOHRMANN** 3240 Scott Boulevard, Santa Clara, CA, 95054, USA, Tel: +1-408-727-6000. Manufacturer of instruments for water soil analysis.

**ELE INTERNATIONAL LTD** Eastman Way, Hemel Hempstead, Herts, HP2 7HB, UK, Tel: +44-442-218355, Telex: 825239, Fax: +44-442-52474, Contact: Neil Durham. Provide appropriate technology for analysis of drinking water and sewage. Products spearheaded by PAQUALAB, the fully portable laboratory for simple on-site testing.

**ENGINEERED SYSTEMS AND DESIGNS # 3 S** Tatnall St, Wilmington, DE, 19801, USA, Tel: +1-302-571-1195, Telex: 757674, Fax: +1-302-571-9264, Contact: Robert Spring. Engineered Systems and Designs manufactures a variety of instruments to measure pH, conductivity, dissolved oxygen and turbidity. The instruments are available in portable units or laboratory models. Catalogues available on request.

**CARLO ERBA INSTRUMENTS** P O Box 11, Rodano, Milan, 20090, Italy, Tel: +39-2-950591, Fax: +39-2-95059276, Contact: Mr Zanoni. Carlo Erba Instruments are one of Europe's largest manufacturers of equipment



# the World Leader in Water and Wastewater Testing Methods



## **On-Line, Laboratory and Portable**

*Our complete systems include simplified procedures, premeasured reagents, and step-by-step instructions.*

- Chlorine Analyzers
- pH Meters & Electrodes
- Sludge Analysis Systems
- Spectrophotometers
- Colorimeters
- Bacteria Testing Systems
- Test Kits
- Reagents
- COD/BOD Systems
- Digestion Apparatus
- Turbidimeters

### **Dealers Worldwide**

**HACH COMPANY**  
P.O. Box 389  
Loveland, Colorado 80539  
U.S.A.

Phone: 303-669-3050  
Telex/TWX: 910-930-9038  
FAX: 303-669-2932



**HACH EUROPE, S.A./N.V.**  
B.P. 229  
B5000 Namur 1  
Belgium

Phone: (32)(81)44.53.81  
TWX (TLX): 846-59027  
FAX: (32)(81)44.13.00

## ANALYSERS, ELECTRODES AND METERS

for water pollution control. Testing equipment is available for the specific analysis of all types of water be it drinking water, waste water etc.

**FIATRON SYSTEMS INC** 510 South Worthington, Oconomowoc, WI, 53066, USA, Tel: +1-414-567-3810, Telex: 9102601438, Fax: +1-414-567-4047, Contact: Mr John Guehlstors. Provide on-line process and laboratory wet chemical analysers. Also column heaters and temperature controllers for liquid chromatography.

**FOXBORO CO** Foxboro, MA, 020235, USA, Tel: +1-508-543-8750, Fax: +1-508-549-6750, Contact: Bob Perrotti. The most complete line of instrumentation available from a single manufacturer. These include flowmeter, pressure, level, temperature and pH transmitters, liquid and gas analyzers, pneumatic and electronic controllers and control systems, computer based systems, control valves and actuators.

**GAM RAD WEST INC** 32422 Alipaz St, Unit A, San Juan Capistrano, CA, 92675, USA, Tel: +1-714-661-0224, Fax: +1-714-661-7245, Contact: James Shata. Manufactures complete line of water quality sensors, reagents, buffers and accessories. Products include pH and ion-selective electrodes, oxidation reduction potential (orp) electrodes, standard pH buffers and conductivity solutions.

**GREAT LAKES INSTRUMENTS** 8855 N 55th St, Milwaukee, WI, 53223, USA, Tel: +1-414-355-3601, Telex: 269685, Fax: +1-414-355-8346, Contact: Mr Kuelita. Instrument manufacturer for measuring and controlling pH, ORP, conductivity, turbidity and dissolved oxygen in industrial process and water quality applications.

**HACH CO** World Headquarters, PO Box 389, Loveland Co 80539, USA Tel: +1-303-669-3050, Fax: +1-303-669-2932. Water Testing Equipment: HACH COMPANY offers analytical systems for field, laboratory and on-line water testing; laboratory and on-line turbidimeters and chlorine analyzers; preprogrammed spectrophotometers; pH meters and electrodes featuring advanced Hach One™ Technology; microbiological tests; and over 200 test kits ranging from single-parameter kits to complete portable laboratories, including pre-measured reagents and step-by-step instructions.

**HACH EUROPE B P** 51, Namur 1, B5000, Belgium, Tel: +32-81-445381, Fax: +32-81-441300, Contact: Alail Dehant. Hach produce a complete range of systems for water quality analysis. Products include test kits, portable laboratories, lab instruments and special process analysers.

**V A HOWE & CO LTD** 12-14 St Ann's Crescent, London, SW18 2LS, UK, Tel: +44-1-874-0422, Telex: 262110, Fax: +44-1-871-9764, Contact: Mr Kinnon. Suppliers of fully or semi-automated equipment for water analysis including conductivity, dissolved oxygen, pH and potentiometer stripping, voltometric photometers and centrifuges.

**INTERATOM** Friedrich-Ebert-Strasse, Bergisch, Gladbach, 5060, West Germany, Tel: +49-2204-840, Telex:

08874457, Fax: +49-2204-840207, Contact: Renata Cruz. Complete works for production of drinking or industrial water:- water treatment plant, desalination plant, super filtration in closed water circuits, supplementary modules for existing systems, analysis and monitoring etc.

**JACOBY-TARBOX CORPORATION** 808 Nepperhan Avenue, Yonkers, NY, 10703, USA, Tel: +1-914-965-8400, Fax: +1-914-699-1671, Contact: John Byrns. Manufacturers of fluid analyzers, sight flow indicators and ball valves.

**JENWAY LTD** Gransmore Green, Felsted, Dunmow, Essex, UK, Tel: +44-371-820122. Analytical measurement and control instrumentation for water purity.

**KAISER ELECTRICAL & ELECTRONIC CO** 35 Kallang Pudding Rd, #06-09 Tong Lee Building, 1334, Singapore, Tel: +65-7474298, Fax: +65-7471183, Contact: Lee Kam Yeow. Represent, sales and service for Great Lakes instruments, pH, ORP, DO, turbidity meter and flow meters. Other products include small deioniser and systems etc.

**KENT INDUSTRIAL MEASUREMENTS LTD** Howard Rd, Eaton Socon, St Neots, Huntingdon, Cambridgeshire, PE19 3EU, UK, Tel: +44-480-75321, Telex: 32676, Fax: +44-480-217948, Contact: Mr Roger Turner. Kent Industrial Measurements Ltd, an ABB Kent company, produce a wide range of instrumentation, including indicating, controlling and recording instruments, flowmeters, gas monitoring and analysis equipment and pH/Redox instrumentation.

**LABFACILITY LTD** Waldergrave Rd, Teddington, Middlesex, TW11 8LR, UK, Tel: +44-1-943-5331, Fax: +44-1-943-4351, Contact: Mr Riddett. Electrochemical and temperature sensors and instrumentation.

**LEEDS AND NORTHRUP CO** Sunneytown Pike, North Wales, PA, 19454, USA, Tel: +1-215-643-2000, Fax: +1-215-699-5245, Contact: Bill Reed. Manufacturer of analytical instrumentation and sensors for water and waste water treatment. Also manufacture ventry meters and rate-of-flow controllers, liquid and dry chemical feeds equipment, filter bottoms, surface agitators, troughs, digital and analog control systems.

**LEEDS AND NORTHRUP LTD** Wharfedale Rd, Tyseley, Birmingham, B11 2DJ, UK, Tel: +44-21-706-6171, Telex: 336577, Fax: +44-21-706-4824, Contact: Mr Thomlinson. Leeds & Northrup provide a complete range of microprocessor based analysers for pH, conductivity, dissolved oxygen, specific ion and Redox, suitable for a range of water, effluent and industrial applications.

**LTH ELECTRONICS** Chaul End Lane, Luton, Beds, LU4 8EZ, UK, Tel: +44-582-593693, Telex: 82210, Contact: Mr Hayward. Manufacturers of instruments for measuring of electro-conductivity, electro-liquidity, dissolved oxygen, liquid level, open channel flow etc. Portables, loggers and automatic on-line controllers.

**LUDWIG SEIBOLD MESSGERATEFABRIK** Wipplin-

## ANALYSERS, ELECTRODES AND METERS

gerstrasse 24, Wien, A-1013, Austria, Tel: +43-222-63-47-77, Telex: 114528 seib a. Ludwig Seibold has specialised for 40 years in pH and conductivity meters, universally applicable for detoxication purposes. Products are sold worldwide. Redox conductivity meters of MAT design (for neutralisation of waste water, detoxication of cyanide and chromate), ion-exchange plants, pH-Redox and ion-selective electrodes, Redox probes, pH simulators, conductivity/temperature probes.

**McNAB INCORPORATED** 20 North MacQueston Parkway, Mt Vernon, NY, 10550, USA, Tel: +1-914-699-1616, Telex: 701621, Fax: +1-914-699-1671, Contact: John Birds. Manufacturer of water quality analyzers including pH, salinity, conductivity, turbidity. High performance monitors, transmitters and controllers for above. Used in marine, reverse osmosis, military, industrial, process and wastewater applications. Also raw water measurements.

**MACHERY NAGEL GmbH & CO KG** Postfach 307, Neumann Nanderstrasse 6-8, Dueren, 5160, West Germany, Tel: +49-2421-61071, Telex: 833-893, Fax: +49-2421-66716. Filter papers, filter thimbles, products for analytical, technical filtration, Nanocolor photometric system, Visocolor test kits for analysis of water, waste water, pH indicator and test papers, columns, sorbents, accessories for all chromatographic techniques.

**MEASUREMENT TECHNOLOGY LTD** Power Court, Luton, Beds, LU1 3JJ, UK, Tel: +44-582-23633/450042, Telex: 825881 Mtlere, Fax: +44-582-422283, Contact: Mr Cockrell. Design, manufacture and sale of intrinsically safe instrumentation, including zener safety barriers, temperature transmitters, trip amplifiers, isolating interface units, digital indicators, multiplexers and lightning protection units.

**MOOR CONTROL INC** Po Box 632, 3400 S 24th St, Muskogee, OK, 74402-0632, USA, Tel: +1-918-683-0238, Telex: 492087, Fax: +1-918-683-4858, Contact: Rick Potlinger. Instrumentation manufacturer specialising in conductivity, pH and biocide, for cooling towers, boilers etc. Also ancillary equipment such as pumps, valves and other associated products.

**MYRON L COMPANY** 6231 Yarrow Drive, Carlsbad, CA, 92009, USA, Tel: +1-619-4382021, Fax: +1-619-9319189, Contact: John Burg. Manufacturers of conductivity instruments and control systems for water analysis and treatment. Ro/Di systems.

**NAGLE CO, DIVISION OF SYBRON CORP** Po Box 20365, Rochester, NY, 14602, USA, Tel: +1-716-586-8800, Telex: 978242, Fax: +1-716-586-8431, Contact: Kathryn Hafenstiner. Filtration products for water analysis and plastic products for industrial laboratories.

**NBA ENVIRONMENTAL SYSTEMS** Invincible Rd, Farnborough, Hampshire, GU14 7QU, UK, Tel: +44-252-514335, Telex: 858510, Fax: +44-252-521912, Contact: Mr Gittings. With over 22 years experience in environmental monitoring, products include: water level and quality measuring instruments and clean or dirty water flow meters, for open channel and closed conduit application.

**ORBECO ANALYTICAL SYSTEMS INC** 185 Marine St, Farmingdale, NY, 11735, USA, Tel: +1-516-293-4110. Manufacture water analyzers, turbidimeters and testing reagents.

**ORION RESEARCH INC** 529 Main St, Boston, MA, 02129, USA, Tel: +1-617-242-3900. Manufactures analytical instruments for laboratory and on-line water quality measurements.

**PARTECH (ELECTRONICS) LTD** Eleven Doors, Charlestown, St Austell, Cornwall, PL25 3NN, UK, Tel: +44-726-74856/7, Telex: 45362, Fax: +44-726-68850, Contact: Mrs Johnson. Partech is a company with 25 years' experience with the design, development, manufacture and marketing of water quality instrumentation, with a speciality in measuring turbidity, suspended solids, sludge density, level and interface.

**PFIZER INC** 235 East 42nd St, New York, NY, 10017, USA, Tel: +1-212-573-2531, Telex: 420440, Fax: +1-212-573-1166, Contact: Mr Roy Dickinson. Pfizer Inc markets "Flocon 100" the leading antiscalant for reverse osmosis systems as well as the "Floclean" family of RO cleaning compounds. Pfizer also provides water analysis services, membrane flow-testing and autopsy services. In addition, Pfizer offers a computer program to help designers and engineers determine optimum operating conditions and Flocon dosage.

**PHILIPS SCIENTIFIC** York St, Cambridge, CB1 2PX, UK, Tel: +44-223-358866, Telex: 817331, Fax: +44-223-312764, Contact: Mr Goodall. Philips Scientific offers the world's widest range of analytical techniques from electrochemistry to electron microscopy. A vast range of electronic test and measurement equipment together with communications, security and industrial automation systems.

**PJD ASSOCIATES** 924 Laguna St, Santa Barbara, CA, 93101, USA, Tel: +1-805-963-9282, Fax: +1-805-965-0601, Contact: Patrick Daley. PJD provide water testing and monitoring equipment, total dissolved solids, pH, temperature and orp testers, and in-line conductivity meters for RO and deionized water systems.

**PROCESS STYRNING AB** P O Box 410-135-24, Tyresö, Sweden, Tel: +46-8-712-0425, Fax: +46-8-742-8330, Contact: Peter Swanson. Sensors and transmitters for clean and waste water plants, level meters, flow meters, water samplers, pH-meters, conductivity meters and 0<2>-meters.

**QUADRINA LTD** Flint Rd, Letchworth, Herts, SG6 1HS, UK, Tel: +44-462-673486, Telex: 826726, Fax: +44-462-674666, Contact: Stuart Atkins. Manufacturers of flow measurement instrumentation and associated control and display systems. Specialists in the supply of portable flow monitoring equipment for distribution analysis and waste water detection and permanent flow metering installations.

**ROSEMOUNT ANALYTICAL GROUP/BECKMAN INDUSTRIAL DIV** 89 Commerce Rd, Cedar Grove, NJ, 07009, USA, Tel: +1-201-239-6200. Analytical instrumentation.

## ANALYSERS, ELECTRODES AND METERS

**ROYCE INSTRUMENT CORP** 13555 Gently, New Orleans, Louisiana, 70129, USA, Tel: +1-504-254-8888, Telex: 798317, Fax: +1-504-254-8855, Contact: Jim Whitaker. Analytical instrumentation, measuring dissolved oxygen, suspended solids and ultra-sonic blanket detection.

**RUSSELL pH LTD** Station Rd, Auchtermuchty, Fife, KY14 7DP, UK, Tel: +44-3372-8871, Telex: 76598, Fax: +44-3372-28972, Contact: Mr Mike Russell. Manufacture wide programme of electrochemical sensors - pH, orp, ion selective electrodes, buffers, reagents and ancillaries. New development - low conductivity water pH electrode. Also range of pH/millivolt meters.

**SAAB PROCESS AUTOMATION** P O Box 608, Sjöflö, 66100, Sweden, Tel: +46-533-15060, Telex: 5347 SPA AB, Fax: +46-533-16931, Contact: Gony Cronquist. Saab Process Automation is a leading Swedish manufacturer of measurement and control equipment for municipal and industrial water and sewage plants. Product range consists of sophisticated supervisory and control systems as well as measurement equipment for pH, redox, oxygen, flow, level, pressure and temperature.

**SERCK GLOCON** St Luke's St, Southgate St, Gloucester, GL1 5RE, UK, Tel: +44-452-308030, Telex: 43139, Fax: +44-452-506062, Contact: Mr Clulow. Serck Glocon market and manufacture a wide range of instrumentation designed for use in the potable and waste water industries. These include portable, laboratory and on-line turbidimeters, colour monitors and self cleaning suspended solids monitors as insertion or flow through versions. Also available are ultrasonic level monitors and insertion flow magmeters.

**SEURI** 36 Avenue Hoche, Paris, 75008, France, Tel: +33-1-4561150/45633514, Telex: 270618, Fax: +33-1-2251206, Contact: Mr Munier. Supplies monitoring units for analysis of water purity, using a process of osmosis.

**SIGNET INDUSTRIAL** 3401 Aerojet Avenue, El Monte, CA, 91734, USA, Tel: +1-818-571-2771. Manufacturer of flows and analytical instrumentation specializing in pH, conductivity/resistivity, temperature and pressure applications.

**TBI-BAILEY CONTROLS CO** 2175 Lockheed Way, Carson City, NV, 89701, USA, Tel: +1-702-883-4366. Manufacturer of pH, ORP and conductivity sensors and analyzers. Also resistivity indicators.

**THOR INTERNATIONAL INC** 13751 Lake City Way NE, 201, Seattle, WA, 98125, USA, Tel: +1-206-361-8467, Fax: +1-206-367-1721, Contact: Peter Thordauson. Ground water monitoring instruments for level/flow/temperature, electronic transducers, data loggers, multiplexers, pocket computer and hand held read out. Data loggers have a memory of 32,000 readouts. We also manufacture pH temperature and pressure meters.

**THORNTON** 1432 Main St, Waltham, MA, 02154, USA, Tel: +1-617-890-3399, Telex: 928096, Fax: +1-617-890-5507, Contact: Agie Leonguerron-Winters. Manufacturers of resistivity, conductivity, rejection, flow, pressure, pH, tank level controllers and sensors for Di/Ro.

**WALTRON LTD AQUALERT DIV** 50 Tannery Rd, Whitehouse, NJ, 08888, USA, Tel: +1-201-464-6500. Manufacturer of continuous on-line water chemistry monitoring instruments.

**WESTINGHOUSE ELECTRIC SA** Burymead Rd, Hitchin, Herts, SG5 1RT, UK, Tel: +44-462-422222, Telex: 825635, Fax: +44-462-53136, Contact: Mr John Stewart. Manufacturers of the analytical instrument "Tocor", to measure total organic and inorganic carbon in water. Specialists in process and environmental technology.

**YSI INC** PO Box 279, 1725 Brannum Lane, Yellow Springs, Ohio, 45387, USA, Tel: +1-513-767-7241, Telex: 205437, Fax: +1-513-767-9353. YSI manufactures a wide variety of oxygen, conductivity, temperature and pH instrumentation and probe for measuring the quality of wastewater, surface water or ground water. The model 50 is the newest dissolved oxygen meter with auto-calibration. The recently introduced model 3560 system measures the temperature, pH, conductivity and mV at the well-side with data logging outputs.

**YSI INCORPORATED** YSI Scientific Ltd, Lysons Avenue, Ash Vale, Aldershot, Hampshire, GU12 5QR, UK, Tel: +44-252-513006, Telex: 858210 INSTCOG, Fax: +44-252-511855. YSI dissolved oxygen and conductivity instruments monitor wastewater treatment and provide environmental control and enforcement. Other YSI systems help maintain pure water supplies by measuring temperature, pH, conductivity and ORP in surface water and groundwater as it's pumped from test wells. YSI instruments assure healthy crops of fish and shellfish in hatcheries and on fish farms.

## Control Equipment

**AB ELECTRONIC EQUIPMENT** Ivel Rd, Shefford, Beds, SG17 5JU, UK, Tel: +44-462-813103, Telex: 825480 PHOX G, Fax: +44-462-814191, Contact: Andrew Price. Manufacture and sales of electrolytic conductivity equipment including conductivity controllers and cells, level electrodes and holders for use in clean water and industrial process control and conservation of constituents in the blending, dosing and rinsing of chemical solutions.

**ACAL AURIEMA LTD** 442 Bath Rd, Slough, Berks, SL1 6BB, UK, Tel: +44-6286-4353, Telex: 847155, Fax: +44-6286-3730, Contact: Mr Ridgewell. Process analysers, fluid controls, industrial data systems, industrial instruments, instrument hire service, components and refrigeration products.

**ADS SERVICES INC** 2227 Drake Avenue S W, Suite 26, Huntsville, AL, 35805, USA, Tel: +1-205-883-9323, Telex: 4933400, Fax: +1-205-882-6765, Contact: Bess Boon. Process control and remote monitoring with telemetry using distributed digital approach. ADS provides turnkey services, including equipment, installation, operation and service.

**AMELEC INSTRUMENTS** Southdown Rd, Harpenden, Herts, AL5 1PW, UK, Tel: +44-5827-64421, Telex:



## CONTROL EQUIPMENT

825242, Contact: Dave Phillips. Design, manufacture and sale of process control instrumentation:- signal transmitters, trip amplifiers and arithmetic units, 19" rack, surface or low cost din rail mounted.

**AMOT CONTROLS CORP** P O Box 1312, Richmond, C A, 94802, USA, Tel: +1-415-236-8306. Manufactures quarter-turn rotary valve actuators and industrial controls.

**ANALYTICAL MEASUREMENTS LTD** Spring Corner, Feltham, Middlesex, TW13 4PB, UK, Tel: +44-1-890-5079, Contact: Ms Dymek. Suppliers of pH and redox meters, recorders and controllers, both portable and main. Manufacturers of ancillary equipment such as electrodes.

**AQUMATIC INT** 2412 Grant Avenue, Rockford, IL, 61003, USA, Tel: +1-815-964-9421, Contact: Mr Johnson. Manufacturers of plastic and metal valves and controls for water treatment equipment such as filters, softeners and deionizers.

**ARAD LTD DALIA** Water Meter Works of Israel, Doar Dalia, 18920, Israel, Tel: +972-4-897911, Telex: 46383, Fax: +972-4-897960. Arad - 50 years a pioneering force in the production of technologically superior water meters, hydraulic and electronic control systems and irrigation valves. Arad systimes are designed to meet modern needs of municipalities, and industry.

**ARKON INSTRUMENTS LTD** Unit C3, Liddington Trading Estate, Old Station Drive, Leckhampton, Cheltenham, Glos, GL53 0DL, UK, Tel: +44-242-573444, Telex: 437269, Fax: +44-242-221701, Contact: Mr Brian Scott. Specialist suppliers of instrumentation for flow level, pressure and vacuum for water, gas and air. Also supply analytical instruments for the water industry ie: pH, redox, dissolved oxygen etc.

**ASCO (UK)** 2 Pit Hey Place, West Pimbo, Skelmersdale, Lancashire, WN8 9PC, UK, Tel: +44-695-24270, Telex: 628400, Fax: +44-695-29477, Contact: Mr Shepstone. An engineering firm manufacturing a comprehensive range of solenoid valves. Our range of 2, 3 and 4 way valves are available from 1/8 to 3 inch pipe sizes in brass, aluminium and stainless steel.

**ATS TELEMETRY LTD** Burrell Rd, Haywards Heath, W Sussex, RH16 1TP, UK, Tel: +44-444-417531, Telex: 877134, Fax: +44-444-412961, Contact: Mr N L Holden. Manufacturers of a range of supervisory control and data acquisition systems based on digital equipment, corporation computers and IBM pcs. Also manufacture a range of telemetry equipment including out-stations, modems, lightning protectors and speech plus data equipment.

**AUTOTORK CONTROLS LTD** Birkby Lodge Works, Birkby Lodge Rd, Huddersfield, West Yorkshire, HD2 2BG, UK, Tel: +44-484-510421, Telex: 51513, Fax: +44-484-510421. Autotork electric actuators are suitable for any make, type and size of valve, penstock or sluice. Types include on-off/regulating and modulating with rotary, linear or part-turn outputs. Control systems and panels also supplied.

**AUTOTROL CORP** 5730 N Glen Park Rd, Milwaukee, WI, 53209, USA, Tel: +1-414-228-9100, Telex: 26-9538, Fax: +1-414-228-8729, Contact: Tom Husman. Autotrol is an innovative leader in the development and manufacture of water treatment including softener, filter and deionization controls, water meter/controllers, dry pellet chlorination systems and hydraulically operated feed pumps.

**AZTEC ENVIRONMENTAL CONTROL LTD** 8 Hawksworth Rd Southmead Industrial Park, Didcot, Oxon, OX11 7HR, UK, Tel: +44-235-512000, Fax: +44-235-512020. Aztec manufactures and supplies on-line, automatic, coagulation control equipment. This can be based on either streaming current methods or raw and treated water valves for colour, turbidity, pH in a total closed loop.

**B/W CONTROLS** 1080 N Crooks, Clawson, MI, 48017, USA, Tel: +1-313-435-9500, Telex: 235359, Fax: +1-313-280-1544, Contact: John Lindsay. Offers a complete line of conductivity point probes and continuous magnetostriuctive sensors.

**BAILEY CONTROLS** 29801 Euclid Avenue, Wickliffe, Ohio, 44092, USA, Tel: +1-216-585-8500, Fax: +1-216-943-4609216-585-8756. Bailey Controls is a worldwide supplier of instrumentation, controls and computer systems for the process industries. Products include control devices for flow, pressure and temperature as well as transmitters, recorders and gauges.

**BESTOBELL MOBREY SPARKLING METER FLOW** 190-196 Bath Rd, Slough, Berks, SL1 4DN, UK, Tel: +44-753-34646, Telex: 848875, Fax: +44-753-693603, Contact: Adrian Payne. Controls and instrumentation. Design and manufacture of electro-mechanical, electronic and microprocessor based equipment for liquid level, flow measurement, energy saving, pollution monitoring and boiler safety.

**BIWATER PUMPS** Millers Rd, Warwick, CV34 5AN, UK, Tel: +44-926-411740, Telex: 317473, Fax: +44-926-410740, Contact: Mr Chatterton. Manufacturers of pumps - both solids - handling sewage pumps and submersible waste water pumps. Build pumps into complete pumping stations including mechanical and electrical. Manufacturers of compatible control panels.

**CARIVAL SPA** Via Per Azzano, San Paolo 26/28, Grassobbio, 24050, Italy, Tel: +39-35-201069, Telex: 300165, Fax: +39-35-295347, Contact: Willi Tschigg. Suppliers of pumps of highest quality design and materials from circulating pumps to deep well submersibles, pressure boosting and water feed pumps, sewage pumps, control systems and special designs.

**CALERAY LTD** Managing Director, 26 Powerscraft Rd, Sidcup, Kent, DA14 5DT, Tel: UK, Telex: +44-1-300-7106, Fax: +44-1-302-3302/3, Contact: Mr Ballard. 896498 Electromagnetic flow meters and associated electronics to enable the measurement of water, sewage and effluent for control and measurement of pollution.

**CAMBRIDGE INSTRUMENTS LTD** Oakfield Rd, London, SE20 8EW, UK, Tel: +44-1-659-2424, Telex:

## CONTROL EQUIPMENT

262716, Fax: +44-1-778-1776, Contact: Annie Robinson. Cambridge Instruments manufacture a wide range of industrial controls under the brand names Londex, Baldwin and Black. These include energy, pressure and flow controls, alarm annunciators, mimics and customised systems.

**CHEMCON INC** 36 Mann St, South Attleboro, MA, 02703, USA, Tel: +1-617-761-6300, Telex: 951402, Fax: +1-617-761-6304, Contact: Charles Wilson. Chemon manufactures a broad line of non-hydraulic and hydraulic diaphragm metering pumps, related automatic controls and accessories. Also offer complete systems, ie pH control, liquid chlorination systems, polymer preparation systems, ect.

**CLACK-CORP** P O Box 500, 4462 Duraform Lane, Windson, WI, 53598, USA, Tel: +1-608-251-3010, Fax: +1-608-846-2586, Contact: Peter Chevma. Manufacture and distribute water treatment components including: reverse-osmosis, ion exchange resins, pressure vessels, brine tanks and accessories, activated carbon, and a complete line of filter media.

**ALAN COBHAM ENGINEERING LTD** Holland Way, Blanford Forum, Dorset, DT11 7BJ, UK, Tel: +44-258-51441, Telex: 417254, Fax: +44-258-51414, Contact: Gordon Day. Design and manufacture of liquid level control equipment: float switches, flow switches, level indicators and control valves. Also manufacture filtration equipment.

**CONCOL SYSTEMS LTD** Dunston House, Dunston Rd, Chesterfield, Derbyshire, UK, Tel: +44-246-260270, Telex: 547355, Contact: Mr Newton. Suppliers of electrical systems and process control systems using appropriate hardware and supervisory control software packages.

**EAGLE SIGNAL CONTROLS** 8004 Cameron Rd, Austin, TX, 78753, USA, Tel: +1-512-837-8300, Telex: 166975, Fax: +1-512-837-8486, Contact: Ray Piet. Provide industrial and commercial timers and controls for water treatment and irrigation industries. Particularly repeat cycle timers and percentage timers.

**ERIE CONTROLS DIV, OF ERIE MFG CO** 4000 S 13 St, Milwaukee, WI, 53221, USA, Tel: +1-414-483-0524. Manufacturer of a complete line of control valves for the water conditioning market. Product line consists of both top mount and side mount controls for both softener and filter applications. (WT)

**GEORGE FISCHER AG**, Schaffhausen, CH-8201, Switzerland, Tel: +41-5381111, Telex: 89-70-70-50, Fax: +41-53-48438, Contact: Mr Wilemer. George Fischer supply systems to measure, regulate and control process liquids in industrial piping systems. Fittings are available in a variety of plastic materials.

**FISCHER AND PORTER** County Line Rd, Warminster, PA, 19044, USA, Tel: +1-215-674-6000. Design, engineer, manufacture and sell instruments, systems, maintenance services and replacement parts for the measurement, recording and control of various processes.

**FISHER CONTROLS LTD** Medway House, Knight Rd, Strood, Rochester, Kent, ME2 2EZ, UK, Tel: +44-634-736900, Telex: 96355, Fax: +44-634-711860, Contact: Mr Gibbs. Manufacturers a comprehensive range of control valves, regulators and pneumatic controllers.

**FISHER CONTROLS LTD** Meridian East, Leicester, LE3 2WU, UK, Tel: +44-533-822822, Telex: 342737, Fax: +44-533-892896, Contact: Mr Speller. Manufacture and supply of control valves and process equipment for all aspects of the water industry.

**FLECK CONTROLS INC** 20580 Enterprise Avenue, Brookfield, WI, 53005, USA, Tel: +1-414-784-4490, Fax: +1-414-784-7794. Products include manual and fully automatic valves (sensor, meter or program clock regeneration), program timers, brine valves and iron filter feeder control systems. (WT)

**FLOWMATIC SYSTEMS INC** 9470 Ulmertown Rd #4B, Largo, FL, 34641, USA, Tel: +1-813-586-26560. Manufactures and sells to OEM's in the RO industry, including automatic shut-off valves, check valves, flow restrictors, membrane housings, in-line filter housings and carbon filters. (WT)

**FOXBORO CO** Foxboro, MA, 020235, USA, Tel: +1-508-543-8750, Fax: +1-508-549-6750, Contact: Bob Perrotti. The most complete line of instrumentation available from a single manufacturer. These include flowmeter, pressure, level, temperature and pH transmitters, liquid and gas analyzers, pneumatic and electronic controllers and control systems, computer-based systems, control valves and actuators.

**FOXBORO GREAT BRITAIN LTD**, Redhill, Surrey, RH1 2HL, UK, Tel: +44-737-765000, Telex: 892852, Fax: +44-737-765000, Contact: Diane Parker. Design, build and market instruments and systems for process management and control.

**GCA-PRECISION SCIENTIFIC** 3737 W Cortland St, Chicago, IL, 60647, USA, Tel: +1-312-227-2660, Telex: 4330120, Fax: +1-312-227-8228, Contact: Mr Rouso. Low temperature incubator, primary usage BOD test (five days 20 degrees Centigrade). The sewerage sampler is used to collect water samples at considerable depth. The sampler holds a 250ml or 300ml BOD sample bottle.

**H & H PRECISION PRODUCTS THERM-O-DISC INC** 1320 S Main St, Mansfield, OH, 44907, USA, Tel: +1-419-756-2131. Manufacturer of bubblers, carafe fillers, water valves, flow controls, tank assemblies and custom OEM products.

**HAYS DIV ROMAC INDUSTRIES** PO Box 300, Gastonia, NC, 28052, USA, Tel: +1-704-824-4605, Fax: +1-704-824-1686, Contact: Jim Arkin. Manufacturers of bronze solenoid valves, predetermined constant flow valves, balancing in line strainers, pulse meters and batch controls.

**HITMA BV** Anton Philipsweg 1, Vithoorn, AL, 1422, The Netherlands, Tel: +31-2975-68011, Telex: 18875, Fax: +31-2975-62341, Contact: Mr I. Millard. Pipes (all materials) pressure vessels: special equipment, sewage, water

# JOHNSON CONTROLS PROVIDES COMPUTERIZED SOLUTIONS FOR THE WATER INDUSTRY

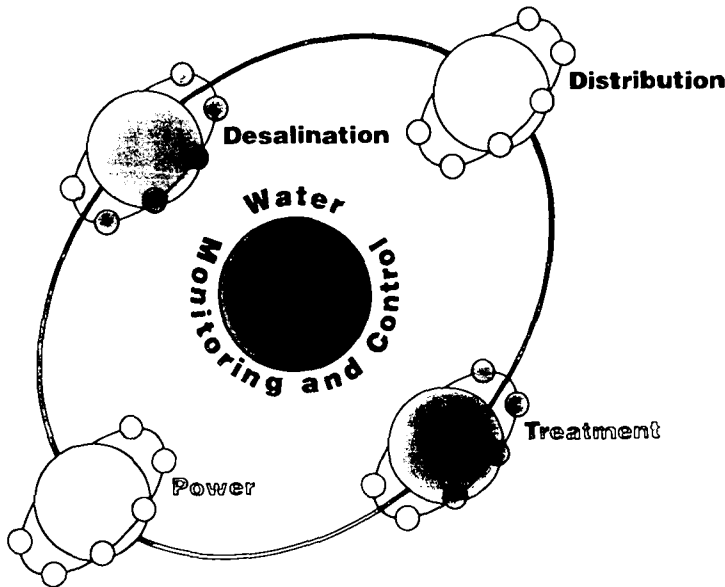

- \* **Desalination**
  - Pressures
  - Temperatures
  - Production
- \* **Distribution**
  - Irrigation
  - Aquaducts
  - Pipelines
  - Canals
- \* **Power**
  - Dams
  - Turbines
  - Gates
  - Grids
- \* **Treatment**
  - Drinking Water
  - Sewerage
  - Wastewater
  - Sludge

*Stars In The Galaxy  
Universe Of Applications*

Whether your application concerns water desalination, distribution, treatment, or power, there is a Galaxy™ Automation System that will meet your monitoring and control requirements.

Galaxy's unique distribution of functionality among its components is just one of the many design features that places Galaxy far ahead of the competition. Each of the primary components contribute intelligent control to its tasks. This increases system efficiency, modularity, redundancy, versatility, and expandability.

Galaxy's versatile architecture accommodates small dedicated projects as well as large distributed monitoring and control applications. The automation system of the future is available today. Our optional artificial intelligence module can ensure that an expert is always in control.

As a leader in monitoring and control of operations and facilities for over a century, Johnson Controls has the people, products, and state-of-the-art expertise to ensure the success of your project.

We can provide complete engineering design, procurement, assembly, integration, testing, installation, and start-up of your new system. Alternatively, we can enhance your existing system. Our support program includes operations and maintenance documentation, training, service, and continuing maintenance. Each Galaxy System comes with a guarantee of customer satisfaction.

Whatever your automation system requirements, Johnson Controls wants to ensure your success. Galaxy automation solutions can meet your needs both today and tomorrow. No matter where your problem exists in the Automation Universe, Johnson Controls' solutions are designed to brighten your stars and your future.

**JOHNSON  
CONTROLS**

**Johnson Controls International, Inc.**  
150 NORTH HILL DRIVE  
BRISBANE, CA 94005 USA  
FAX: (415) 468-6363  
TELEPHONE: (415) 468-6050

# HYDRO GAS CHLORINATION SYSTEMS

FOR POTABLE WATER SYSTEMS • POWER PLANTS  
INDUSTRIAL PROCESS WATER • WASTE WATER  
COMMUNITY WATER SYSTEMS  
SWIMMING POOLS • SANITARY SEWAGE

**WE're No. 1  
with Best Price  
and Best Quality**

**CHLORINE CYLINDER or MANIFOLD  
MOUNTED MODELS for every requirement!**

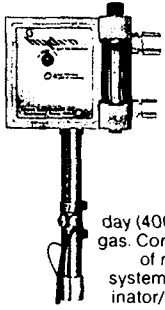

## 1 HYDRO SERIES 200

Cylinder or Manifold Mounted Gas Chlorinator. A rugged, durable, easy to install, vacuum operated system with capacity up to 200 lbs/day (4000 grams/hr) of chlorine gas. Control accuracy within 4% of max. capacity. Complete system combines Hydro chlorinator/vacuum control, ejector, remote meter/s and automatic switch-over for single or multipoint applications.

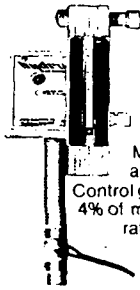

## 2 HYDRO SERIES 700

Ton cylinder or Manifold Mounted Gas Chlorinator. A larger capacity, vacuum operated system with Hydro Maximum operating dependability. rate 500 lbs/day (9500 Control grams/hr). accuracy to within 4% of max. capacity. Minimum feed rate is 5% of maximum. Hydro chlorinator/vacuum control, ejector, remote meters/s and automatic switchover provide a complete system for single or multipoint applications.

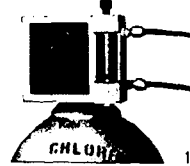

## 3 HYDRO SERIES 500

Cylinder Mounted Gas Chlorinator. For smaller capacity requirements of 4, 10, 25, 50 or 100 lbs/day (75, 250, 500, 1000 or 2000 grams/hr). Easy to install, low maintenance features have made this vacuum operated unit ideal for low capacity requirements. Hydro chlorinator/vacuum control, ejector, remote meter/s and automatic switchover provide a complete system for single or multipoint applications.

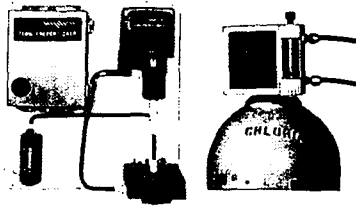

## 4 HYDRO FLOW PROPORTIONER

Cylinder or wall mounted units automatically feed chlorine gas in direct proportion to the flow of water or waste water. Six models with feed ranges of 10, 25, 50, 100, 200 and 500 lbs/day (200, 500, 1000, 2000, 4000 and 10000 grams/hr). Dosage control maintains residual in parts per million. Feed rates down to 20% of design dosage and increases to 200% possible. Meets stringent government regulations.

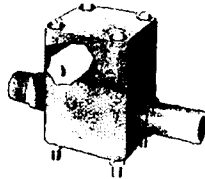

## 5 HYDRO EJECTOR

The ejector that has become the industry standard. No failures in over 3 years! Like all Hydro equipment, it uses chlorine resistant (wet or dry) materials. Operates with back pressures up to 100 psi (6.8 bar).



## 6 HYDRO AUTOMATIC SWITCHOVER

With a Hydro chlorinator /vacuum control installed on multiple cylinders, one automatic switchover will allow use of chlorine gas from both cylinders. As one cylinder is depleted, it automatically switches over to the unused cylinder. Completely automatic, no adjustment or setting needed.



## 7 HYDRO REMOTE METERS

For precise metering of chlorine gas to individual ejectors in remote locations. If more (or less) chlorine gas is required at one location the meter is simply set at the desired level for that location, maintain a perfectly balanced system.

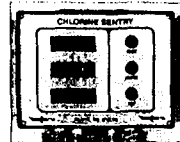

## 8 HYDRO CHLORINE SENTRY

Unique gas diffusion sensor instantly detects chlorine gas leaks...flashes yellow warning light, then red for danger and audible horn sounds. NEMA 4X enclosure with touch panel switches assures environmental integrity.

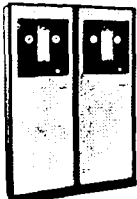

## 9 HYDRO CHLORINATOR/SULPHONATOR

For Water Authorities exacting specifications, these units are vacuum operated for continuous and constant solution feed of either chlorine or sulphur dioxide. Capacities available from 50 grams/hr to 160 Kg/hr.

Hydro Instruments is celebrating 10 years of providing Gas Chlorination throughout Asia, Africa, South and Central America. Hydro Units are fully machined (not injection molded.) No chlorinator diaphragm failure in ten years. Lifetime tantalum springs. Only the best.

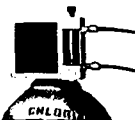

**hydro** INSTRUMENTS, INC.

P.O. Box 615 • 492 Richlandtown Pike • Quakertown, PA 18951 • 215-538-1367

Cable Address Hydro Quakertown

Fax 215-536-4442

## CONTROL EQUIPMENT

lines and suppliers to council authority. Control and automation industry: telemetering, flow metering, pressure and temperature control. Instantaneous heaters: wall mounting and central heating. Safety, relief, control and special industrial valves. Pinch valves, control valves, specifically designed for: sewage treatment, waste water, sludge, lime, scum and grit, lagoon drains, storm waters, clog free valves for solid waste conveyance and check valves.

**HYDRIL UK LTD AOT FLOWSYSTEMS** Central Way, Walworth Industrial Estate, Andover, Hampshire, SP10 5BW, UK, Tel: +44-264-65961, Telex: 47107 Aotflo, Fax: +44-264-57819, Contact: Steve Atkins. Designers and manufacturers of in-line and insertion flow meters and meter provers, flow computers and indicators, control systems. Also offer hydraulic calibration service in a laboratory environment.

**HYDRONAMIC ENGINEERING CORP** PO Box 1736, 186 Viking Avenue, Brea, CA, 92622, USA, Tel: +1-714-990-583. Manufacturer specializing in flow control components for home RO systems. Also check valves, pressure relief valves, flow restrictors and complete flow control units. (WT)

**INSTEM COMPUTER SYSTEMS LTD** Walton Industrial Estate, Stone, Staffs, ST15 0LT, UK, Tel: +44-785-812131, Telex: 36340, Fax: +44-785-812460, Contact: Mr Key. Instem Computer Systems Ltd supplies supervisory control and data acquisition (SCADA) systems and telemetry schemes for the efficient management and operation of water treatment and distribution.

**JASMIN ELECTRONICS PLC** Sellers Wood Drive, Bullwell, Nottingham, NG6 8UX, UK, Tel: +44-602-273741, Telex: 37142, Fax: +44-602-278614, Contact: Mr Hubbard. Jasmin Electronics is an acknowledged leader in the field of plant automation and control systems for the process industry, utilising state of the art technology, providing efficient economic solutions.

**JEFFERY ELECTRONIC CONTROL P/L** 6 Pacific Highway, St Leonards, New South Wales, 2065, Australia, Tel: +61-2-439-5982, Contact: Judy Jeffery. Design and manufacture of 'JEC' electronic irrigation and mist propagation controllers. Especially 'COMPU-RAIN' microprocessor irrigator and 'Weather Watcher' sensor automisters. Also cooling-humidifying units, filter flushing units, anemometer controls etc.

**JENWAY LTD** Gransmore Green, Felsted, Dunmow, Essex, UK, Tel: +44-371-820122. Analytical measurement and control instrumentation for water purity.

**KENT - PROCESS CONTROL LTD** Biscot Rd, Luton, LU3 1AL, UK, Tel: +44-582-21151, Telex: 825161, Fax: +44-582-421115, Contact: Mr Kingman. Manufacturers of process computer control systems for process and utility industries. Manufacturers of instrumentation.

**KENT INDUSTRIAL MEASUREMENTS LTD** Howard Rd, Eaton Socon, St Neots, Huntingdon, Cambridgeshire, PE19 3EU, UK, Tel: +44-480-75321, Telex: 32676, Fax: +44-480-217948, Contact: Mr Roger Turner. Kent Industrial Measurements Ltd, an ABB Kent

company, produce a wide range of instrumentation, including indicating, controlling and recording instruments, flowmeters, gas monitoring and analysis equipment and pH/Redox instrumentation.

**KEYSTONE VALVE (EUROPA) BV** Mijkenbroek 22, Breda, 4824AB, The Netherlands, Tel: +31-76-491000, Telex: 417-870, Fax: +31-76-417870, Contact: Jon Van Der Klift. Keystone Valve, AGCO and Yarway merged in 1986. Three of the big names in flow-control, in power and process engineering, with worldwide reputations for providing the most sophisticated, the most technologically advanced and reliable products for the industries they serve. The company can now offer not only butterfly valves and complete automated flow-control valve packages, but also a wide range of specialized products for pressure control, for safe and efficient steamprocessing, and for measurement.

**KEYSTONE VALVE (UK) LTD** 91 Meiklewood Road, Drumoyne, Glasgow, G51 4DU, UK, Tel: +44-41-810-3121, Telex: 779541, Fax: +44-41-810-4724, Contact: Marie Thomson. Keystone is the world's largest speciality valve flow control company in the UK, Keystone has manufacturing plants in Glasgow and Manchester producing butterfly valves, actuators, process control systems, power safety and instrumentation products.

**KNIGHT EQUIPMENT CO** P O Box 1378 1340-1346 Logan Avenue, Costa Mesa, CA, 93626, USA, Tel: +1-714-557-5400. Metering pumps and control systems, fibreglass tanks, demonstration and test kits.

**LB-ELECTRONICS GES M B H** Dodlinger Hauptstrasse 95, Wien, A-1190, Austria, Tel: +43-222-36-76-60, Telex: 133722 lind a. The "LB-26 Compulogger" is an Austrian-made electronic add-on device which transforms the Epson HX-20 Microcomputer into an "intelligent", freely programmable universal measuring instrument suitable for pollution control purposes without impairing its basic function.

**LEE-DICKENS LTD** Rushton Rd, Desborough, Kettering, Northants, NN14 2QW, UK, Tel: +44-536-760156, Telex: 341227, Fax: +44-536-762552, Contact: Giles Dickens. Process control instrumentation manufacturers specialising in signal conditioning, signal isolation, humidity and temperature monitoring.

**LEEDS AND NORTHRUP CO** Sunneytown Pike, North Wales, PA, 19454, USA, Tel: +1-215-643-2000, Fax: +1-215-699-5245, Contact: Bill Reed. Manufacturer of analytical instrumentation and sensors for water and waste water treatment. Also manufacture ventry meters and rate-of-flow controllers, liquid and dry chemical feeds equipment, filter bottoms, surface agitators, troughs, digital and analog control systems.

**LEONARD VALVE CO** 1360 Elmwood Avenue, Cranston, RI, 02910, USA, Tel: +1-401-461-1200, Fax: +1-401-941-5310, Contact: Rich Bruber. Manufacturer of thermostatic water mixing valves and controls.

**LTH ELECTRONICS** Chaul End Lane, Luton, Beds, LU4 8EZ, UK, Tel: +44-582-593693, Telex: 82210, Contact: Mr Hayward. Manufacturers of instruments for

## CONTROL EQUIPMENT

measuring of electro-conductivity, electro-liquidity, dissolved oxygen, liquid level, open channel flow, etc. Portables, loggers and automatic on-line controllers.

**MILLARS WELLPOINT (INTERNATIONAL) LTD** Barnham, Thetford, Norfolk, IP24 2PD, UK, Tel: +44-842-89451, Telex: 81361, Fax: +44-842-89645. Suppliers of pumps, wellpoint dewatering, irrigation and sewerage control systems. Engineering consultancy service supplying turnkey engineering packages.

**MILTON ROY CO** 201 Ivyland Rd, Ivyland, PA, 18974, USA, Tel: +1-215-441-0800, Telex: 4761138, Fax: +1-215-441-8620, Contact: Jack Craneg. The coagulant control centre represents the best available technology for coagulant/flocculant dose monitoring and automatic control in treatment of raw surface waters, waste sludge dewatering and process water.

**MORR CONTROL INC** P O Box 632, 3400 S 24th St, Muskogee, OK, 74402-0632, USA, Tel: +1-918-683-0238. Instrumentation manufacturer specializing in conductivity controls for cooling towers, boilers, swimming pools and horticultural use.

**MYRON L COMPANY** 6231 Yarrow Drive, Carlsbad, CA, 92009, USA, Tel: +1-619-438-2021, Fax: +1-619-931-9189, Contact: John Burg. Manufacturers of conductivity instruments and control systems for water analysis and treatment. Ro/Di systems.

**NEI THOMPSON VALVES** 17 Balena Close, Creekmoor, Poole, Dorset, BH17 7EF, UK, Tel: +44-202-697521, Telex: 41256, Fax: +44-202-605385. Manufacturers of pressure regulators and flow control valves and systems.

**NEPTUNE WATER METER CO** PO Box 458 Rt 229 South, Tallahassee, AL, 36078, USA, Tel: +1-205-283-6555. RO Master Control Valve provides multiple functions to include input water shut-off when tank fills, check valves to curtail water waste, adjustable recovery rates and demand rinsing of membrane. Tricon/s Water Treatment Control System is used for measurement and control of water in applications such as water softener regeneration, batching, pacing pump injection, boiler and cooling tower water treatment/make up and more. (WT)

**NUOVO PIGNONE** Via Tiburtinakm 12.700131 Rome Italy. Nuovo Pignone is one of the leading designers and manufacturers of machinery and equipment for gas, water, petroleum and Reciprocating and centrifugal compressors, Gas and steam turbines, Centrifugal pumps, Ball valves and valve actuators, Fabricated equipment, Control and safety valves, Process computers, Automation and remote control systems.

**PED LTD** Exning Rd, Newmarket, Suffolk, CB8 0AX, UK, Tel: +44-638-665161, Telex: 81245, Fax: +44-638-660718, Contact: Mr Maidham. Manufacturers of relays, solenoids and solenoid valves.

**PENN SYSTEMS INC** 812 Parkway, Broomall, PA, 19008, USA, Tel: +1-215-543-5000. Continuous flow and batch solid/liquid/gas instrumentation and controls.

**PHOTO-SCAN LTD** Dolphin Estate, Windmill Rd, Sunbury-on-Thames, Middlesex, TW16 7HG, UK, Tel: +44-932-789741, Telex: 8952449, Fax: +44-932-787067, Contact: Mrs Humphries. Specialists in the design and supply of CCTV systems for security, safety, process monitoring and management control. Please contact direct for further information.

**PLASTIC PUMPS LTD** Hanworth Trading Estate, Hampton Rd, West Hanworth, Feltham, Middlesex, TW13 6DJ, UK, Tel: +44-1-898-2799, Telex: 935282, Contact: M Sternberg. Plastic Pumps for handling various chemicals used for water treatment. Electronically operated dosing pumps and controllers for all applications.

**PLATON FLOWBITS LTD** Platon Park, Viabes, Basingstoke, Hants, RG22 4PS, UK, Tel: +44-256-460122, Telex: 858107, Fax: +44-256-63345, Contact: D N James. Platon Flowbits offer from stock a wide range of flowmeters, flow alarms, flow control valves and associated products.

**PLATON INSTRUMENTATION** Platon Park, Viabes, Basingstoke, Hants, RG22 4PS, UK, Tel: +44-256-470456, Telex: 858107, Fax: +44-256-63345, Contact: D N James. Platon Instrumentation incorporates Platon Flow Control and Platon A & I Ltd, manufacturing instruments for flow measurement and control for liquids and gases, together with design and manufacture of precise pressure measuring devices.

**PORTER CHADBURN ENGINEERING LTD** Park Lane Works, Bootle, Merseyside, L30 4UP, UK, Tel: +44-51-525-4155, Telex: 629576, Fax: +44-51-525-4150, Contact: Graham Freeman. Manufacturers and suppliers of mechanical hydraulic and pneumatic valve actuators and controls and pneumatic control panels. Suppliers of valve locking devices and pipework services.

**PRESTO-TEK** 4101 N Figueroa St, Los Angeles, CA, 90065, USA, Tel: +1-213-221-1178/800-421-1178. Manufactures portable and process instrumentation pH/orp, dissolved oxygen, temperature, relative humidity, pH/conductivity, salt analysis and flow, monitoring and control. Also manufactures pH/orp recorders and controllers, colorimeters pH and rH transmitters, temperature transmitters, chemical metering pumps, drum pumps and mixers. (WT)

**RAFFINEAU INC** 4595 Melrose Avenue, Montreal, PQH4A 2S8, Canada, +1-514-488-0336/514-636-9897. Offers water industry a compact, proven, low-cost, purpose-built adaptable microprocessor controller capable of operating various softener, DI dealkalizer, RO systems in simplex or any multiplex configuration. Complete customization possible with run of about 20 units. (WT)

**RAYLEIGH INSTRUMENTS** Raytel House, Brook Rd, Rayleigh Weir Estate, Rayleigh, Essex, SS6 7XH, UK, Tel: +44-268-775656, Telex: 99440, Fax: +44-268-745001, Contact: Mr Tolhurst. Manufacture and supply process control instrumentation including indicators, analogue/digital relays, kilowatt hour meters, transducers, gen-

## CONTROL EQUIPMENT

erator controls, electronic/mechanical thermostats and pressure controllers.

**B RHODES & SON LTD** Danes Rd, Crow Lane, Romford, Essex, RM7 0HR, UK, Tel: +44-708-762333, Telex: 896084, Fax: +44-708-45924, Contact: Alan Murray. Manufacture and supply of sight flow indicators, flowmeters and remote indication/totalising/ alarm/ batch control etc. Flow alarm switches and water meters.

**RO/CO CHEMICAL SYSTEMS INC** 4004 Volta Avenue, Brentwood, MD, 20722, USA, Tel: +1-301-799-2400. Distributor of water treatment chemicals, services and related chemical feed and control equipment.

**ROSSELL FLUID CONTROL/JESCO** Mead Lane, Lydney, Glos, GL15 5EU, UK, Tel: +44-594-42219/42488, Telex: 437150, Fax: +44-594-41781, Contact: Mr Brian. Manufacturer of chemical dosing pumps, chemical dry feeders, chlorination equipment, chemical transfer pumps and chemical control equipment.

**SAAB PROCESS AUTOMATION** P O Box 608, Sjöfalle, 66100, Sweden, Tel: +46-533-15060, Telex: 5347 SPA AB, Fax: +46-533-16931, Contact: Gony Cronquist. Saab Process Automation is a leading Swedish manufacturer of measurement and control equipment for municipal and industrial water and sewage plants. Product range consists of sophisticated supervisory and control systems as well as measurement equipment for pH, redox, oxygen, flow, level, pressure and temperature.

**SERCK CONTROLS LTD** Rowley Drive, Coventry, CD3 4FH, UK, Tel: +44-203-305050, Telex: 311970STRTOV, Fax: +44-203-302437, Contact: Mr Close. Supplier of supervisory control and data acquisition systems with a full range on intelligent remote terminal units plus real time systems software and experienced project management for major international projects.

**SPACE AGE ELECTRONICS INDUSTRIAL LTD** Spalding Hall, Victoria Rd, London, NW4 2BE, UK, Tel: +44-1-203-1132, Telex: 8811085, Fax: +44-1-203-4496, Contact: Mr Pepper. Space Age Electronics offer a range of high quality, low cost process control instrumentation covering ultrasonic level and flow equipment, as well as the new, transducer - radio telemetry range of radio data transmission systems. These have the ability to control the duty cycle of remote transducers, depending upon the state of a switch input, or an analogue level.

**STRAINSTALL** Denmark Rd, Cowes, Isle of Wight, PO31 7TB, UK, Tel: +44-983-295111, Telex: 86369 STRAIN G, Fax: +44-983-291335, Contact: Mr Turner. Manufacturers of load monitoring equipment for pull trials, mooring and monitoring systems.

**TIERWAY LTD** Unit 15 Sandown Park, White Horse Technology Park, Trowbridge, Wilts, UK, Tel: +44-373-823599, Telex: 44924, Contact: Mr Derrick. Level measurement and control for water, effluents, sewage etc, and for powders and granular solids. Control panels and complete instrument systems. Installation and commissioning. Please contact direct for further information.

**VALMONT INDUSTRIES INC** Valley, Nebraska, 68064, USA, Tel: +1-402-359-2201, Telex: 484459 VMTVLLY, Fax: +1-402-359-4429. Valmont Industries offers a variety of irrigation control equipment, including: "P & R Surge Valve". A cast aluminium unit with solar powered motor and programmable microprocessor for maximum efficiency in furrow irrigation. "Valmonitor II". A remote system for monitoring and controlling irrigation systems pumps, chemical injection systems etc. Utilizing radio signals for control it offers printed reports of your irrigation status (air temperature, wind speed and direction and soil moisture etc).

**VALTEK INCORPORATED** P O Box 2200, Mountain Springs Parkway, Springville, Utah, 84663, USA, Tel: +1-801-489-8611, Telex: 388-458, Fax: +1-801-489-3719, Contact: Erik Anthony. Valtek is an international manufacturer of precision control valves used in normal flow applications and for reducing flow noise and cavitation. Valtek manufactures Globe, angle, 3-way, Y-body, nuclear, butterfly and ball valves in sizes 1/2" to 42" in ANSI Classes 150 to 4500.

**WALTHAM CHEMICAL PUMP CORP (WALCHEM)** P O Box 565, 1396 Main St, Waltham, Massachusetts, USA, Tel: +1-617-899-8604, Telex: 923478, Fax: +1-617-647-9507, Contact: Mr Richard Jewett. Manufacturers and suppliers of positive displacement metering pumps, fluid control systems and thermoplastic moulded tanks up to 5000 gallons.

**WATER CONSERVATION SYSTEMS INC** 141 South Spring St, Claremont, California, 91711, USA, Tel: +714-621-5805, Telex: 9102402436 WCS INC CLA, Fax: +714-621-5806, Contact: Edward R Bramlett. Water Conservation Systems Inc (WCS) manufactures patented fully automatic irrigation control sensors and related products. These self-contained devices measure available soil moisture and rain fall and can start, stop or interrupt irrigation by zone. Tradenamed Hydrovisor and Rain Guard these and other WCS products are available worldwide. Contact WCS for information.

**WESTINGHOUSE SYSTEMS LTD** P O Box 41 Pew Hill, Chippenham, Wilts, SN15 1JJ, UK, Tel: +44-249-654141, Fax: +44-249-659635, Contact: Mr J Douglas. Manufacture SCADA systems. Westinghouse has a worldwide marketing and support operation that provides a fast and effective service to an impressive client base ranging through Europe, the Middle East, the Far East, USA, and South America.

## Data Acquisition, Analysis, Storage and Transmission

**ACAL AURIEMA LTD** 442 Bath Rd, Slough, Berks, SL1 6BB, UK, Tel: +44-6286-4353, Telex: 847155, Fax: +44-6286-3730, Contact: Mr Ridgewell. Process analysers, fluid controls, industrial data systems, industrial instruments, instrument hire service, components and refrigeration products.

**ATS TELEMETRY LTD** Burrell Rd, Haywards Heath,

W Sussex, RH16 1TP, UK, Tel: +44-444-417531, Telex: 877134, Fax: +44-444-412961, Contact: Mr N L Holden. Manufacturers of a range of supervisory control and data acquisition systems based on digital equipment, corporation computers and IBM pcs. Also manufacture a range of telemetry equipment including out-stations, modems, lightning protectors and speech plus data equipment.

**BRISTOL BABCOCK LTD** European HQ: Parsonage House, Parsonage Square, Dorking, Surrey, RH4 1UP, UK, Tel: +44-306-740033, Telex: 262335, Fax: +44-306-740800, Contact: Ron Thomas. Bristol Babcock supplies advanced control, SCADA, telecontrol and data acquisition systems to the water industry, worldwide. Our systems are fully supported by our field services organisation which offers installation, commissioning and maintenance services on a worldwide basis.

**CANADIAN APPLIED TECHNOLOGY** 10 Plantehet Rd, Unit 21, Concourse, Ontario, L4K 2C8, Canada, Tel: +1-416-738-8205, Telex: 06-964-887, Fax: +1-416-738-6964, Contact: Margaret Walker. Produces guaranteed turn-key environment systems for governments and industries.

**COMPUTING TECHNIQUES (MFG) LTD** Tinyard Lane, Gosdon Common, Bramley, Guildford, Surrey, GU5 0WA, UK, Tel: +44-483-898900, Telex: 858161, Fax: +44-483-898977, Contact: Mr Crowley. Design, develop and manufacture a range of data loggers for all applications in the water industry.

**CPN CORP** 2830 Howe Rd, Martinez, CA, 94553, USA, Tel: +1-415-228-9770, Fax: +1-415-228-3183, Contact: William Mancuso. Manufacture of neutron probe for measurement of sub-surface moisture.

**DELTA TECHNICAL SERVICES LTD** Asser House, Airport Service Rd, Portsmouth, Hants, PO3 5RA, UK, Tel: +44-205-697321, Telex: 86477, Contact: Mr Wheatcroft. Manufacture and sell data logging systems for both direct collection of data and telemetered data. Battery powered, sealed for life. Products specifically designed for the water industry.

**DOWTY INFORMATION RFL** Systems Division, Marshfield, Chippenham, Wiltshire, SN14 8NN, UK, Tel: +44-225-891440, Fax: +44-225-891889, Contact: Mrs Carter. Dowty produces single board outstations for major water authorities. The outstations consist of control and data processors which are capable of acquiring data relating to flows, levels and electrical power distribution.

**DYNAMIC LOGIC LTD** The Western Centre, Western Rd, Bracknell, Berks, RG12 1RW, UK, Tel: +44-344-51915, Telex: 849433, Fax: +44-344-52253, Contact: Mr Barbour. Dynamic Logic offer the complete package solution to all telemetry and instrumentation problems in the water industry. From a single level transducer to a complete regional telemetry scheme, using PSTN radio or private wire.

**ELIN-WASSERWERKSTECHNIK GmbH** Hainburger Strasse 33, Wien 3, A-1030, Austria, Tel: +43-726621,

Telex: 132142, Fax: +43-8285199, Contact: Mr Mehl. Elin manufacture equipment for water metering, flow measurement, apparatus for meter testing and calibrating as well as electronic remote control and data logging systems.

**FLARE SOFTWARE** 8 Gay St, Bath, BA1 2PH, UK, Tel: +44-225-319032, Contact: Julia Barkett. Take the work out of work study, use "FLARE WSF", the work study computer software system. Used extensively in the water industry.

**FLOSONICS INC** PO Box 390, Umatilla, Oregon, 97882, USA, Tel: +1-503-567-1966, Contact: Terry R Henderson. Flosonics Inc offers sales, installation and set-up services on state-of-the-art data acquisition systems, computerised data storage and radio telemetry transmission within the system.

**GOLDEN RIVER WATER LTD** 3 Wedgewood Rd, Bicester, Oxon, OX6 7UL, UK, Tel: +44-869-240840, Telex: 83336, Fax: +44-869-246858, Contact: Mr Granderson. Manufacturers of remote data logging equipment specifically for the water industry to measure flow, depth, pressure etc of water supply for applications such as irrigation and disposal. All equipment powered by a 10-year battery which is also supplied.

**HEEL GmbH & COMESSTECHNIK KG** Jaegerstrasse 4 - 12, Postfach 17 45, Kempten, D-8960, West Germany, Tel: +49-831-20-59-02, Fax: +49-831-2-05-9105, Contact: Herbert Friedrich. Data-acquisition systems and data-transmission systems.

**HORIBA INSTRUMENTS LTD** 1 Harrowden Rd, Brackmills, Northampton, NN4 0EB, UK, Tel: +44-604-765171, Telex: 311869, Fax: +44-604-765175. Horiba Instruments can supply instrumentation for use in water quality monitoring stations that automatically measure pollution parameters of sea water as well as fresh water so that pollution can be controlled in its entirety.

**HYDRAULIC ANALYSIS LTD** Mill House, Hawksworth Rd, Horsforth, Leeds, LS18 4JP, UK, Tel: +44-532-581622, Telex: 556301, Fax: +44-532-590863, Contact: David Clarke. Analysis of pumping mains, piped networks and open channels by computer simulation to provide solutions to unsteady flow problems, provision of engineering software.

**INSTEM COMPUTER SYSTEMS LTD** Walton Industrial Estate, Stone, Staffs, ST15 0LT, UK, Tel: +44-785-812131, Telex: 36340, Fax: +44-785-812460, Contact: Mr Key. Instem Computer Systems Ltd supplies supervisory control and data acquisition (SCADA) systems and telemetry schemes for the efficient management and operation of water treatment and distribution.

**INSTRUMENTAL NORTHWEST INC** 14972 NE 31st Circle, Redmond, WA, 98052, USA, Tel: +1-206-885-3729, Fax: +1-206-867-0404, Contact: Robert W Landick. Instrumental Northwest Inc, provides complete systems for use in hydrological testing applications. Multi-channel capability to 16 channels with many smaller variations available. Automated water level measurement and aquifer testing programs included.



## DATA ACQUISITION, ANALYSIS, STORAGE AND TRANSMISSION

**JOHNSON CONTROLS INTERNATIONAL** 150 North Hill Drive, Brisbane, California, 94005, USA, Tel: +1-415-468-6050, Telex: 356449 JCII SFO, Fax: +1-415-468-6363. Johnson Controls is a worldwide supplier of engineered and installed control systems and services. Design, manufacture, install, maintain and service supervisory control and data acquisition and process control and instrumentation, systems specifically to meet your water project requirements, with over 2000 outlets in 61 countries, Johnson offer their services anywhere in the world.

**JOUCOMATIC RUEIL EXPORT** 32 Avenue Albert 1er, Rueil-Malmaison, 92500, France, Tel: +33-1-47-49-0360, Contact: Mme Manchan. Joucomatic specialize in fluid control and automatic transmission, pneumatic components, electrovalves and remote controlled valves, valve actuators. Joucomatic is operational on all five continents with 350 sales outlets throughout the world.

**KIPP AND ZONEN B V P O** Box 507, AM Delft, 2600, The Netherlands, Tel: +31-15-561-000, Telex: 38137, Fax: +31-15-620-351, Contact: Mr Van Der Horst. Manufacturer of flatbed recorders, low profile recorders, printer/plotters and sun measuring equipment.

**LIVINGSTON TECHNICAL SALES** 2-6 Queens Rd, Teddington, TW11 0LR, UK, Tel: +44-1-977-0055, Fax: +44-1-977-9232, Contact: Michael Gregory. Distributors of high technology instrumentation and measurement products covering the fields of data communications, data logging, cable testing and mains disturbance analysis and line conditioning equipment. Main products selected from principals:- Hewlett Packard, Tektronix/Draneh, F W Bell, Schiumberger, Siemens, Square D. Full technical support offered including "In House" service and calibration.

**ML ENGINEERING (PLYMOUTH) LTD (INDUSTRIAL CONTROLS GROUP)** Fostover Close, Plymouth, PL6 7PU, UK, Tel: +44-752-702525, Telex: 453883, Fax: +44-752-701653, Contact: Mr Heaton. Manufacturers of turnkey projects in SCADA, data and telemetry systems.

**MOTOROLA COMMUNICATIONS ISRAEL LTD** 16 Kremenetzki St, Tel Aviv, 67899, Israel, Tel: +972-3-388325, Fax: +972-3-337925, Contact: Sam Har-Zahav. Motorola, a leading communication company, worldwide, is manufacturing, designing and installing scada, command and control systems, for water and wastewater distribution systems. Microprocessor-based remote terminal units communicating via radio or wire.

**NEPTUNE** 312 Hornsby Drive, Talahassee, AL, 36078, USA, Tel: +1-205-283-6555. Manufacture and market quality flowmeters, systems and data capture devices for the water utility and water treatment control markets.

**NUOVO PIGNONE** Via Tiburtina Km, Rome, 12730, Italy, Tel: +06-40993-1, Fax: +06-4091239. Supervisory and remote control systems for water distribution, water treatment, wastewater treatment and water quality.

**PJD ASSOCIATES** 924 Laguna St, Santa Barbara, CA,

93101, USA, Tel: +1-805-963-9282, Fax: +1-805-965-0601, Contact: Patrick Daley. PJD provide water testing and monitoring equipment, total dissolved solids, pH, temperature and orp testers, and in-line conductivity meters for RO and deionized water systems.

**PROCESS CONTROL AND AUTOMATION SYSTEMS LTD** Strawhall Industrial Estate, Carlow, Republic of Ireland, Tel: +44-503-42377, Telex: 60611, Fax: +44-503-42620, Contact: Mr Aidan Lynch. Designers and suppliers of computer and PLC control systems for data acquisition, supervisory and control applications. Specialists in systems for utility companies based on 10 years' international experience.

**SEBA HYDROMETRIE GmbH** Dessestr 5, Kaufbeuren-Neugablonz, D-8950, West Germany, Tel: +49-8341-62026, Fax: +49-8341-62029, Contact: Wolfgang Zasche. Seba Hydrometrie is a manufacturer of hydrological, meteorological and sewage measuring instruments. The instruments are installed in more than 90 countries worldwide. Range of production: data loggers and transmission systems, water sampling equipment 2"- and 4"- mechanical samplers, 2" submersible pump with 12 l/min capacity, water level recorders and control systems, current meters/winchies and all kind of meteorological sensors.

**SERCK CONTROLS LTD** Rowley Drive, Coventry, CD3 4FH, UK, Tel: +44-203-305050, Telex: 311970STROV, Fax: +44-203-302437, Contact: Mr Close. Supplier of supervisory control and data acquisition systems with a full range on intelligent remote terminal units plus real time systems software and experienced project management for major international projects.

**SERCO** 1922 Main St, Cedar Falls, IA, 50613, USA. Independent lab specializing in air, water, wastewater and hazardous waste analysis.

**SINCO-SLOPE INDICATOR CO LTD** Southerham House, Southerham, Lewes, East Sussex, BN8 6JN, UK, Tel: +44-273-474475, Fax: +44-273-474479, Contact: Mr Scott. Manufacturers and suppliers of dam instrumentation, inclinometers, piezometers, pressure cells, settlement gauges, extensometers, data acquisition systems and vibration monitors.

**SPACE AGE ELECTRONICS INDUSTRIAL LTD** Spalding Hall Victoria Rd, London, NW4 2BE, UK, Tel: +44-1-203-1132, Telex: 8811085, Fax: +44-1-203-4496, Contact: Mr Pepper. Space Age Electronics offer a range of high quality, low cost process control instrumentation covering ultrasonic level and flow equipment, as well as the new, transducer - radio telemetry range of radio data transmission systems. These have the ability to control the duty cycle of remote transducers, depending upon the state of a switch input, or an analogue level.

**SPECTRASCAN LTD** 42 New Brighton Rd, Emsworth, Hants, PO10 7QR UK Tel: +44-243-379121, Telex: +9312102018, Fax: +44-243-371471. For Supply and Distribution Engineers this specialist manufacturer has developed (in conjunction with the UK Water Research Centre) a comprehensive range of portable and fixed

electronic monitoring equipment outstanding for its toughness and reliability. The company has been a market leader in the UK since 1982, and 25 percent of its turnover is currently exported to the developing world and a network of agents is being built up. Spectrascan's catalogue of data loggers, sensors, software etc, is a must for every distribution manager or engineer. Their special catalogue for the Supply and Distribution industry features a wide range of pressure and flow sensors, including mechanical and electromagnetic insertion probes. Displays, data loggers and telemetry outstations and software compatible with all these transducers are available as is advice on building single installations or substantial data systems. Highly accurate pressure measurements are necessary, particularly in situations where the intention is to build a mathematical model of the distribution system for control and planning purposes. Spectrascan can provide pressure transducers accurate to within 10 cm when measuring 100m and these are supported by a comprehensive range of displays, portable data loggers, software, etc. where necessary. Also available are active pressure controllers using microprocessors to adjust pressure dependent on conditions.

**STROUD INSTRUMENTS LTD** Locking Hill, Stroud, Gloucestershire, GL5 1QN, UK, Tel: +44-4536-5433, Telex: 43621, Fax: +44-4536-4256, Contact: Mr G A Davis. Design, manufacture and sale of flow measurement equipment and process instrumentation including GRP flume liners, signal converters, trip amplifiers, isolators, linearisers, integrators, summators, square root extractors, and power supplies.

**TRANSMITTON LTD** Smisby Rd, Ashby-de-la-Zouch, Leics, LE6 5UC, UK, Tel: +44-530-415941, Telex: 341628, Fax: +44-530-411484, Contact: Mrs Beech.

**UNCO DATA SYSTEMS P O** Box 9427, Minneapolis, MN, 55440, USA, Tel: +1-612-935-4466, Fax: +1-612-933-7200 EX217, Contact: Alan Winquist. A staff of 17 data processing professionals provide computer services and systems to the water conditioning industry.

**WESTINGHOUSE SYSTEMS LTD P O** Box 41 Pew Hill, Chippenham, Wilts, SN15 1JJ, UK, Tel: +44-249-654141, Fax: +44-249-659635, Contact: Mr J Douglas. Manufacture SCADA systems. Westinghouse has a worldwide marketing and support operation that provides a fast and effective service to an impressive client base ranging through Europe, the Middle East, the Far East, USA, and South America.

### Dosing Systems and Equipment

**H E ANDERSON CO P O** Box 1006, 2100 Anderson Drive, Muskogee, OK, 74401, USA, Tel: +1-918-687-4426, Telex: 910-997-2323, Fax: +1-918-682-3342, Contact: Andy Aderson. Manufacturer of a water operated positive displacement, chemical metering pump used for hypochlorination, cooling tower treatment and boiler feedwater treatment.

**BAYROL CHEMISCHE FABRIK** Lochhamer Str 29,

Martinsried, 8033, West Germany, Tel: +49-89-85-7010, Telex: +524695, Fax: +49-89-85-701777, Contact: Mr Utz Heyn. Cleaning and disinfection in the production sectors of the brewing, food and beverage industries, as well as the use of technical enzymes. Industrial water treatment. Swimming pool and whirlpool care for the public and private sectors. Sauna care, special chemicals as starting materials for the processing industry.

**BLUE WHITE INDUSTRIES** 14931 Chestnut St, Westminster, CA, 92683, USA, Tel: +1-714-893-8529, Fax: +1-714-894-9492, Contact: Selma Haywood. Manufacturer of chemical feed metering pumps and flow meters with factory representatives covering the USA, Canada and overseas.

**E BRAUDE (LONDON) LTD** Liberta House, Sandhurst, Surrey, GU17 8JR, UK, Tel: +44-252-876123, Telex: 858842, Contact: Mr Stable. Braude corrosion resistant high performance low cost self priming chemical pumps handle water treatment solutions. Level-master provides reliable and accurate level control of chemical solutions and water including de-ionised water.

**CHEMCON INC** 36 Mann St, South Attleboro, MA, 02703, USA, Tel: +1-617-761-6300, Telex: 951402, Fax: +1-617-761-6304, Contact: Charles Wilson. Chemon manufactures a broad line of non-hydraulic and hydraulic diaphragm metering pumps, related automatic controls and accessories. Also offer complete systems, ie pH control, liquid chlorination systems, polymer preparation systems, etc.

**CHEMLAB-INSTRUMENTS LTD** Hornminster House 129 Upminster Rd, Hornchurch, Essex, RM11 3XJ, UK, Tel: +44-4024-57011, Telex: 8951347, Contact: Jeff Cox. Chemlab Instruments is an acknowledged leader in the field of water analysis, sterilisation and laboratory purification. Products include perisistic pumps, reverse osmosis, multichannel analysers, monitors, sterilisers, flow injection and laboratory equipment.

**CT (LONDON) LTD** Westfield House, Westfield Rd, Guildford, Surrey, GU1 1EL, UK, Tel: +44-483-502020, Telex: 859284, Fax: +44-483-50953, Contact: Mr Noble. CT (London), long established in fluids handling, can offer a variety of valves, pumps, pipe supports, gauges, chemical dosing and spray equipment to solve your water handling problems. Call us!

**DEMA ENGINEERING** 10020 Big Bend Boulevard, St Louis, MO, 63122, USA, Tel: +1-314-966-3533, Fax: +1-314-966-2532, Contact: Jack Deutsch. Dema Engineering Co offers a wide selection of dispensing equipment used to meter and proportion cleaning and sanitizing products. Proportioners, injectors, foamers and spray clean equipment mix chemical with water and air to provide a cleaning solution.

**DUSAPRO MILTON ROY (UK) LTD** DMR House, Fishponds Rd, Oaklands Park, Wokingham, Berks, RG11 2FD, UK, Tel: +44-734-771066, Telex: 846989, Fax: +44-734-771198, Contact: Mr Eagle. Supplier of dosing pumps and packages for water treatment and chemical handling. Flow rates from 0-10,000 l/h per head, pres-

## DOSING SYSTEMS AND EQUIPMENT

sures up to 500 bar, mixers, dry feeders, stream and current detectors.

**FLUID METERING INC** P O Box 179, 29 Orchard St, Oyster Bay, NY, 11771, USA, Tel: +1-516-922-6050, Telex: 5101001281, Fax: +1-516-624-8261, Contact: Winnie McKnight. Metering pumps and dispensers, valveless, variable, positive displacement pumps for precise handling of solutions, slurries, concentrate and gases. Flow rates from microliters to 2300 milliliters per minute at pressures to 100 psig with repeat accuracy of 0.1 per cent or better. Choice of chemical-resistant wetted ends.

**HANNA INSTRUMENTS** Highland Industrial Pumps, 584 Park East Drive, Woonsocket, RI, 02895, USA, Tel: +1-401-765-7500, Telex: 265398 HANNA UR, Fax: +1-401-765-7575, Contact: Richard Bouvier. Specialists in small-size plastic-body pumps (7lbs). For dosing additives such as hydrozine for boilers and antifouling for cooling towers, with adjustable flow rate from 6 to 83 gpd.

**INTERTUBE SYSTEMS LTD** Estover Rd, Plymouth, Devon, PL6, UK, Tel: +44-752-775781, Telex: 45260, Fax: +44-752-777316, Contact: Mr Moat. Automatic and manual lubrication systems for water treatment and associated plants. Also metering pumps for antifoam suppression.

**JOHNSON FILTRATION SYSTEMS** Johnson House, Browells Lane, Feltham, Middlesex, TW13 7EQ, UK, Tel: +44-1-751-4424, Telex: 935479, Fax: +44-1-890-1533. Johnson Filtration Systems market the Aquaritol, the worlds most advanced and flexible coagulation control systems, this offers flow following dosing, pH control system, choice of control. Either streaming current or inlet turbidity can be used for control. With streaming current option this is the parameter used for control with final turbidity used to trim. The turbidity control is feedback from final monitor and feed forward from raw monitor.

**KENNEDY & DONKIN SYSTEMS CONTROL LTD** Chatsworth House, 19 Lever St, Manchester, M1 3LT, UK, Tel: +44-61-228-6282, Telex: 668972, Fax: +44-61-228-3031, Contact: Mr Viney. Kennedy & Donkin Systems Control provides consulting services to the water industry on a worldwide basis. Services range from feasibility/planning studies through procurement to full implementation of telemetry, SCADA and communications schemes.

**LIQUID METRONICS INC** 19 Craig Rd, Acton, MA, 01720, USA, Tel: +1-617-263-9800. Manufacturer of chemical metering (dosing) pumps, slurry feeders and associated accessories. The metering pump line is based on pumps which include inherent pressure relief, total protective enclosure in corrosion-proof housings and easy adaptability to automatic operation. (WT)

**MATCHLESS MANUFACTURING CO LTD** Chief Executive Warrington, WA4 6PS, UK, +44-925-50676/37585, Tel: +44-925-59249/50676, Fax: 627702, Contact: Mr Wyliss. This unique pump is made from Nylon 66 with a percentage glass fill, all food quality. The accurate 1/2 litre chamber dispenses light of viscose fluid

from plastic or steel drums. Ideal for most liquids.

**MAZZEI INJECTOR CORP** 11001 Mt View Rd, Bakersfield, CA, 93307, USA, Tel: +1-805-845-2253. Manufacture and market high efficiency venturi type injectors for use in a wide variety of industrial and commercial treatment applications.

**MOOR CONTROL INC** Po Box 632, 3400 S 24th St, Muskogee, OK, 74402-0632, USA, Tel: +1-918-683-0238, Telex: 492087, Fax: +1-918-683-4858, Contact: Rick Potlinger. Instrumentation manufacturer specialising in conductivity, pH and biocide, for cooling towers, boilers etc. Also ancillary equipment such as pumps, valves and other associated products.

**MPL PUMPS LTD** Eton House, Waterside Drive, Langley, Slough, SL3 6EZ, UK, Tel: +44-753-49970, Telex: 847471, Fax: +44-753-46472, Contact: Mr Lancaster. MPL Metering Pumps Ltd offer a range of metering, dosing and transfer pumps for handling waste water and water treatment applications, eg aluminium, soda, activated silica, lime slurries, polyelectrolytes, ferrous sulphate, pH correction, chlorination, softening, control of scale formation and corrosion and boiler feed treatment.

**PLASTIC PUMPS LTD** Hanworth Trading Estate, Hampton Rd, West Hanworth, Feltham, Middlesex, TW13 6DJ, UK, Tel: +44-1-898-2799, Telex: 935282, Contact: M Sternberg. Plastic Pumps for handling various chemicals used for water treatment. Electronically operated dosing pumps and controllers for all applications.

**PRECISION DOSING PUMPS LTD** Alma Park Rd, Grantham, Lincs, NG31 9SE, UK, Tel: +44-476-77677, Telex: 37538, Fax: +44-476-75233, Contact: Mr Estcourt. Manufacturers of chemical dosing pumps for handling of free flowing liquids for both high and low capacity and pressure ranges. Chemical treatment packaged units and full accessory equipment. Double diaphragm, piston membrane and metal membrane units

**RO/CO CHEMICAL SYSTEMS INC** 4004 Volta Avenue, Brentwood, MD, 20722, USA, Tel: +1-301-779-2400. Distributor of water treatment chemicals, services and related chemical feed and control equipment.

**ROSSELL FLUID CONTROL/JESCO** Mead Lane, Lydney, Glos, GL15 5EU, UK, Tel: +44-594-42219/42488, Telex: 437150, Fax: +44-594-41781, Contact: Mr Brian. Manufacturer of chemical dosing pumps, chemical dry feeders, chlorination equipment, chemical transfer pumps and chemical control equipment.

**MICHAEL SMITH ENGINEERS** Oaks Rd, Woking, Surrey, GU21 1PH, UK, Tel: +44-4862-71871, Telex: 859306 MSEWOK, Fax: +44-4862-23110, Contact: Sam Smith. Engineers and distributors for specialised pumping equipment. Pumping systems and packaged dosing systems designed to customer requirements. Chlorination equipment and pumps.

**WALLACE & TIERNAN LTD** Priory Works, Tonbridge, Kent, TN11 0QL, UK, Tel: +44-732-771777, Telex:

## DOSING SYSTEMS AND EQUIPMENT

95278, Fax: +44-732-771800, Contact: Mr Miller. A company manufacturing a range of equipment to disinfect water and to provide the addition of chemicals necessary for coagulation etc. The range comprises of equipment designed for simple remote stations as well as the most sophisticated system of controlled addition.

### Field and On-Site Testing

**ABEM A B P O** Box 20086, Bromma, S-16102, Sweden, Tel: +46-8-764-60-60, Telex: 13079, Fax: +46-8-28-11-09. ABEM Chemmac measures and evaluates deep ground water characteristics such as the physicochemical parameters pH, redox potential and the free sulphide content, in open holes, within a packed off section of a well or on-line during test pumping. ABEM Piezomac measures natural piezometric pressure distribution in a borehole. ABEM Terrameter maps ground water pollution plumes downstream from landfills and other pollutants.

**AZTEC ENVIRONMENTAL CONTROL LTD** 8 Hawksworth Rd Southmead Industrial Park, Didcot, Oxon, OX11 7HR, UK, Tel: +44-235-512000, Fax: +44-235-512020. Aztec manufactures and supplies a range of portable field and on-site test equipment. These can range from sedimentation and flotation jar test equipment to chemical analysis kits and on-line quality monitors.

**THE BEN MEADOWS COMPANY INC** PO Box 80549, Atlanta, GA, 30366, USA, Tel: +1-404-455-0907, Fax: +1-404-457-1841, Contact: John E Amos. The Ben Meadows Company warehouses and distributes over 8,000 items from 500 different manufacturers. These products are designed to improve the productivity of the professional or worker out in the field. We offer water analysis equipment, sampling and measuring devices, water pollution detection and on-site sewage lab kits, among many other instruments and equipment your people can use in the field.

**BRAILSFORD AND CO LTD** 670 Milton Rd, Rye, NY, 10580, USA, Tel: +1-914-967-1820, Fax: +1-914-967-1836, Contact: Robert Drummond. We manufacture portable automatic water sampling instruments, battery or A/C operated, featuring long battery life good reliability and modest prices.

**C W COX INC** P O Box 3214, South El Monte, CA, 91733, USA, Tel: +1-818-443-5090, Contact: John Morgan. Instruments for field testing water supply pumps and water wells. Insertion flowmeters, electric well sounders, bottom sounders, software packages for pump efficiency calculations. Up to 2% accuracy. Adaptors for multiple pipe sizes.

**CHEMETRICS INC** Route 28, Calverton, VA, 22016, USA, Tel: +1-703-788-9026, Telex: 292861, Fax: +1-703-788-4856, Contact: Alissa Hudson. Manufacture over 200 different test kits for determining more than 40 water quality parameters. All products are simple to use and have a virtually unlimited shelf life.

**E M SCIENCE** 111 Woodcrest Rd, Cherry Hill, NJ, 08034, USA, Tel: +1-609-354-9200. Manufacturer of reagent chemical specialities including EM Quant® test strip kits for semi-quantitative analysis and colorphast pH test strips and liquids.

**ELE INTERNATIONAL LTD** Eastman Way, Hemel Hempstead, Herts, HP2 7HB, UK, Tel: +44-442-218355, Telex: 825239, Fax: +44-442-52474, Contact: Neil Durham. Provide appropriate technology for analysis of drinking water and sewage. Products spearheaded by PAQUALAB, the fully portable laboratory for simple on-site testing.

**ENGINEERED SYSTEMS AND DESIGNS # 3 S** Tatnall St, Wilmington, DE, 19801, USA, Tel: +1-302-571-1195, Telex: 757674, Fax: +1-302-571-9264, Contact: Robert Spring. Engineered Systems and Designs manufactures a variety of instruments to measure pH, conductivity, dissolved oxygen and turbidity. The instruments are available in portable units or laboratory models. Catalogues available on request.

**ENVIRONMENTAL TEST SYSTEMS INC** PO Box 4659, 23575 CR 106, Elkhart, IN, 46514, USA, Tel: +1-219-262-2060, Telex: 6008382, Fax: +1-219-264-2495, Contact: Dennis Kelly. Manufacture a dip and read test strip for free chlorine, total bacteria and yeast mould.

**GEOTECH ENVIRONMENTAL EQUIPMENT INC** Unit 17, 1441 West 46th Avenue, Denver, CO, 80211, USA, Tel: +1-303-433-7101. The Geotech Barrel Filter is an acrylic pressure filtration unit designed for the convenient and rapid filtration of water samples prior to chemical analysis. It is lightweight, compact, rugged and is particularly convenient for field use.

**HACH CO** World Headquarters, PO Box 389, Loveland Co 80539, USA Tel: +1-303-669-3050, Fax: +1-303-669-2932. Water Testing Equipment: HACH COMPANY offers analytical systems for field, laboratory and on-line water testing; laboratory and on-line turbidimeters and chlorine analyzers; preprogrammed spectrophotometers; pH meters and electrodes featuring advanced Hach One™ Technology; microbiological tests; and over 200 test kits ranging from single-parameter kits to complete portable laboratories, including pre-measured reagents and step-by-step instructions.

**HACH EUROPE** B P 51, Namur 1, B5000, Belgium, Tel: +32-81-445381, Fax: +32-81-441300, Contact: Alail Dehant. Hach produce a complete range of systems for water quality analysis. Products include test kits, portable laboratories, lab instruments and special process analysers.

**HANBY ANALYTICAL LABORATORIES INC** 4400 South Wayside, Suite 107, Houston, Texas, 77087, USA, Tel: +1-713-649-4500. Manufacture and market a field test kit for the detection of aromatic compound contamination in soil and groundwater. The kit provides an accurate method for water and soil analysis and can be used by non-technical personnel.

**WARREN JONES ENGINEERING LTD** 120-124 Churchill Rd, Bicester, Oxon, OX6 7XD, UK, Tel: +44-

# YSI Provides the Tools To Protect Water Quality

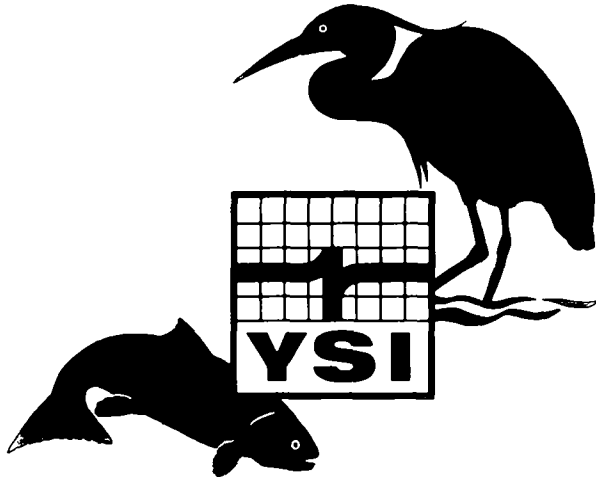

Worldwide, thousands of YSI dissolved oxygen and conductivity instruments monitor wastewater treatment, and provide environmental control and enforcement.

Other YSI systems help maintain pure water supplies by measuring the contamination of surface water and groundwater as it's pumped from test wells.

On farms and in hatcheries, YSI instruments assure healthy crops of fish and shellfish, an increasingly important source of food around the world.

Let us tell you how YSI can help you protect water quality. Contact YSI Scientific Ltd., Lysons Avenue, Ashe Vale, Aldershot, Hampshire GU12 5QR, England. Phone 44 252 513006.

## FIELD AND ON-SITE TESTING

869-246691, Telex: 83194, Fax: +44-869-253340, Contact: John Corris. Manufacturers of ultra-sonic level measurement equipment, sewage treatment monitoring equipment, and portable open-channel flow recorders.

**LAMOTTE CHEMICAL PRODUCTS CO** PO Box 329, Chestertown, MD, 21620, USA, Tel: +1-301-778-3100. Manufacture water analysis equipment for on-site demonstration and laboratory use.

**LXINGTON SCIENTIFIC LABORATORY LEXLAB INC** P O Box 3080, Lexington, OH, 44904, USA, Tel: +1-419-884-1340. Sanitation testing service for regeneration plants, EPA waste water analysis, well testing.

**MCCULLOUGH/LEAKTEK INC** 1105 Park Avenue, Murfreesboro, TN, 37130, USA, Tel: +1-615-890-9030, Contact: Grady Looney. Mobile Meter Tester, designed to test meters from 3/4-16" in the field. Completely portable, all testing equipment mounted on 6' x 8' steel trailer. Entire testing operation can be done by one man. Eliminates guess work, improves labor efficiency dramatically, all with greater accuracy.

**RÜF-GERÜTEBAU GmbH** Bahngasse 15, Dornbirn, A-6853, Austria, Tel: +43-5572-62-6-55. The Environment Test Kit by Ruf (Dr Passeger) is a portable field laboratory for the quick analysis of special waste at the receiving point. The kit is very easy to handle, which means that personnel without chemical training can be employed to operate it. It comprises a comprehensive set of instruments and includes a large selection of quick environment-related tests, eg cyanide, peroxide, chromate, nitrite, copper, zinc tests, pH measuring strips, oil and water detection tests, etc.

**SPACE AGE ELECTRONICS INDUSTRIAL LTD** Spalding Hall, Victoria Rd, London, NW4 2BE, UK, Tel: +44-1-203-1132, Telex: 8811085, Fax: +44-1-203-4496, Contact: Mr Pepper. Space Age Electronics offer a range of high quality, low cost process control instrumentation covering ultrasonic level and flow equipment, as well as the new, transducer - radio telemetry range of radio data transmission systems. These have the ability to control the duty cycle of remote transducers, depending upon the state of a switch input, or an analogue level.

**TAYLOR TECHNOLOGIES INC** 31 Loveton Circle, Sparks, Maryland, 21152, USA, Tel: +1-301-472-4340, Telex: 710-232-9363, Fax: +1-301-771-4291, Contact: Tom Seechuk. Water test kits and reagents.

**TINTOMETER LTD** Waterloo Rd, Salisbury, SP1 2JY, UK, Tel: +44-722-27242, Telex: 47372, Fax: +44-722-412322, Contact: Mr Alex Belbin. Manufacturers of Lovibond comparators and water analysis test kits for on site chemical analysis of treated and untreated water supplies. Ideal for semi skilled operators who require to carry out essential analysis on a low budget.

**WATER DYNAMICS INC** 375 Central Avenue, Bohemia, NY, 11716, USA, Tel: +1-516-567-5198. Specializing in test kits for hardness, calcium, iron, phosphate, copper, ammonia, sulfate, phenol, chlorine, nitrite, sulfide and nitrate etc.

**WILKINSON & SIMPSON LTD** Palintest House, Kingsway Team Valley, Gateshead, Tyne & Wear, NE11 0NS, UK, Tel: +44-91-491-0808, Telex: 537479, Fax: +44-91-482-5372, Contact: Dr Smoker. Portable water testing kits for most common parameters, in potable water and effluents, suitable for on site and field use.

**YSI INCORPORATED** YSI Scientific, Lysons Avenue, Ash Vale, Aldershot, Hampshire, GU12 5QR, UK, Tel: +44-252-513006, Fax: +44-252-511855, Contact: Lynda Hart. YSI dissolved oxygen and conductivity meters monitor wastewater treatment, and provide environmental control and enforcement. Other YSI systems help maintain pure water supplies by monitoring temperature, conductivity, pH and ORP in surface water and groundwater as it is pumped from test wells. YSI instruments also assure healthy crops of fish and shellfish in hatcheries and on farms.

### Pressure and Temperature Gauges and Regulators

**A1 INDUSTRIAL** London Rd, Pampisford, Cambridge, CB2 4EF, UK, Tel: +44-223-834420, Telex: 817536, Fax: +44-223-835050, Contact: Jill Francis. Air flow and pressure measuring instruments.

**BAILEY & MACKEY LTD** Baltimore Rd, Birmingham, UK, Tel: +44-21-357-5351, Fax: +44-21-357-8319, Contact: Ms Bach. Bailey and Mackey are involved in the development and manufacture of all types of pressure transducers and gauges from 0-20" of water upto 6000 psi. Also produced are: special materials for wetted parts on dosing equipment.

**CAMBRIDGE INSTRUMENTS LTD** Oakfield Rd, London, SE20 8EW, UK, Tel: +44-1-659-2424, Telex: 262716, Fax: +44-1-778-1776, Contact: Annie Robinson. Cambridge Instruments manufacture a wide range of industrial controls under the brand names Londex, Baldwin and Black. These include energy, pressure and flow controls, alarm annunciators, mimics and customised systems.

**DELTA CONTROLS LTD** Island Farm Avenue, East Molesey, Surrey, KT8 0UZ, UK, Tel: +44-1-941-5166, Telex: 27109, Fax: +44-1-783-1163, Contact: Richard Wigmore. Manufacturers of standard and custom built pressure, pressure difference, temperature, flow, vacuum and level switches, liquid level transmitters and fibre-optic based sensors for use in all areas. Instrument needle valves and manifolds and pressure transducers.

**DRUCK NEDERLAND BV** PO Box 232, Barendrecht, AE, 2990, The Netherlands, Tel: +31-1806-11555, Telex: 28164, Fax: +31-1806-18131, Contact: John Oosthon. Specialists in level and measuring devices including calibration and pressure measuring equipment, transducers.

**KDG INSTRUMENTS** Crompton Way, Crawley, West Sussex, RH10 2YZ, UK, Tel: +44-293-25151, Telex: 87235, Contact: Redshaw. Specialising in flowmeters, pres-

## PRESSURE AND TEMPERATURE GAUGES AND REGULATORS

sure and level transmitters, KDG products are used in applications such as reservoir level and storage tank level monitoring, water flows and pressures. With panel and wall-mounted tank contents monitors, and flow monitors.

**NORGREN MATONAIR LTD** P O Box 22, Eastern Avenue, Lichfield, Staffs, WS13 6SB, UK, Tel: +44-543-414333, Telex: 338555, Fax: +44-543-268052, Contact: Alan Satchwell. Manufacturers of pneumatic and electro-pneumatic equipment including ball valves, quick release hose couplings, pressure regulators and cylinders.

**OCV CONTROL VALVES** 7400 East 42 Place, Tulsa, Oklahoma, 74145, USA, Tel: +1-918-627-1942, Telex: 910-845-2227, Fax: +1-918-622-8916. OCV manufactures and internationally markets a complete line of automatic, hydraulically operated, diaphragm actuated, pilot controlled valves. The line includes the series 108, 127 and 120 for pressure relief, pressure reducing and rate of flow respectively.

**SAAB PROCESS AUTOMATION** P O Box 608, Suffle, 66100, Sweden, Tel: +46-533-15060, Telex: 5347 SPA AB, Fax: +46-533-16931, Contact: Gony Cronquist. Saab Process Automation is a leading Swedish manufacturer of measurement and control equipment for municipal and industrial water and sewage plants. Product range consists of sophisticated supervisory and control systems as well as measurement equipment for pH, redox, oxygen, flow, level, pressure and temperature.

**SPAN INSTRUMENTS INC** 1947 Avenue K, Plano, Texas, 75074, USA, Tel: +1-214-423-5320. Manufacturer of pressure instrumentation including gauges, switches and transmitters.

**VERNON MORRIS & CO LTD** Chester Rd, Bretton, Chester, CH4 0DH, UK, Tel: +44-244-660794, Telex: 01556CARIBAGI, Fax: +44-244-314635, Contact: Mr Stockton. Manufacturers and distributors of mechanical and electronic flow gauges, pressure recorders, flow and pressure test kits, back flow prevention devices, sand pipes, valve keys, test pumps and waterwork fittings etc.

**ALEXANDER WIEGAND GmbH & Co** Postfach 1180, Klingenberg/Main, D-8763, West Germany, Tel: +49-9372-132-0, Fax: +49-9372-132-406-414, Contact: Christine Hofmann. Wika Products are: pressure gauges, measurement of pressure and vacuum, chemical seals, sensor application protection system, tronic line, electronic instrumentation for pressure and temperature measurement, mechanical thermometers, bimetal thermometers, etc.

### Laboratory Equipment

**pHOX SYSTEMS LTD** Ivel Rd, Shefford, Beds, SG17 5JU, UK, Tel: +44-462-813103, Telex: 825480, Fax: +44-462-814191, Contact: Mr Crossley. Instrumentation and systems for the water and process industries. Represented throughout the world. On-site advice available.

**ANALYTICAL PRODUCTS INC** 3339 Arden Rd, Hayward, CA, 94545, USA, Tel: +1-415-732-5400, Fax: +1-415-732-6109. Manufacturers of laboratory reagents and supplies. Applicable to this market is the safety bulb to eliminate mouth pipetting and two and three-decimal place pH calibrating buffers, useful for the newer automatically calibrating meters.

**AQUATECH LTD** St Johns Rd, Wivenhoe, Colchester, Essex, CO7 9DR, UK, Tel: +44-206-223232/224242, Fax: +44-206-226262, Contact: Colin Eade. Manufacturers of specialist pumping equipment including micro-processor and electronic liquid level controls. "ET" series packaged water pressure booster set with capacities up to 120 m3 are compatible with BMS systems.

**AZLON PRODUCTS LTD** Towerscroft Rd, Sidcup, Kent, DA14 5EF, UK, Tel: +44-1-300-8886, Telex: 8951810, Fax: +44-1-300-2247, Contact: Mr Thomas. Manufacturers of water sampling equipment for pollution detection and control. Suppliers of a wide range of plastic lab equipment.

**AZTEC ENVIRONMENTAL CONTROL LTD** 8 Hawksworth Rd Southmead Industrial Park, Didcot, Oxon, OX11 7HR, UK, Tel: +44-235-512000, Fax: +44-235-512020. Aztec manufactures and supplies laboratory jar test equipment with variable speed, back lighting and G valves to test coagulation and treatment requirements for both sedimentation and dissolved air flotation processes.

**BDH LTD** Broom Rd, Poole, Dorset, BH12 4NN, UK, Tel: +44-202-745520, Telex: 41186/418123, Fax: +44-202-738299, Contact: Mr Colin Gibson. Manufacturers and suppliers of laboratory apparatus and instruments.

**CAMLAB LTD** Nuffield Rd, Cambridge, CB4 1TH, UK, Tel: +44-223-62222, Telex: 817664, Fax: +44-223-460856, Contact: Mr Carse. Suppliers of water quality test kits, turbidimeters and other equipment for the testing of water quality.

**CHEMLAB-INSTRUMENTS LTD** Hornminster House 129 Upminster Rd, Hornchurch, Essex, RM11 3XJ, UK, Tel: +44-4024-57011, Telex: 8951347, Contact: Jeff Cox. Chemlab Instruments is an acknowledged leader in the field of water analysis, sterilisation and laboratory purification. Products include peristaltic pumps, reverse osmosis, multichannel analysers, monitors, sterilisers, flow injection and laboratory equipment.

**CHEMTRIX INC** 5285 N E Elam Young Parkway Suite A-400, Hillsboro, OR, 97124, USA, Tel: +1-503-648-0762. Catalogue operation selling instruments and equipment to laboratories and industry.

**CLANDON SCIENTIFIC LTD** Lysons Avenue, Ash Vale, Aldershot, Hampshire, GU12 5QR, UK, Tel: +44-252-514711, Telex: 858210, Fax: +44-252-511855, Contact: Alan Pendry. Suppliers of a range of conductivity and dissolved oxygen meters, total organic carbon analysers and a range of water filters.

**ENGINEERED SYSTEMS AND DESIGNS # 3 S** Tatnall St, Wilmington, DE, 19801, USA, Tel: +1-302-

## LABORATORY EQUIPMENT

571-1195, Telex: 757674, Fax: +1-302-571-9264, Contact: Robert Spring. Engineered Systems and Designs manufactures a variety of instruments to measure pH, conductivity, dissolved oxygen and turbidity. The instruments are available in portable units or laboratory models. Catalogues available on request.

**FOXBORO CO** Foxboro, MA, 020235, USA, Tel: +1-508-543-8750, Fax: +1-508-549-6750, Contact: Bob Perrotti. The most complete line of instrumentation available from a single manufacturer. These include flowmeter, pressure, level, temperature and pH transmitters, liquid and gas analyzers, pneumatic and electronic controllers and control systems, computer based systems, control valves and actuators.

**GALLENKAMP INTERNATIONAL** Belton Rd West, Loughborough, Leicestershire, LE11 0TR, UK, Tel: +44-509-237371, Telex: 34391, Fax: +44-509-231893, Contact: Patrick Brannen. Gallenkamp International is a leading supplier of scientific equipment to educational, medical and industrial establishments throughout the world. The company stocks over 30,000 different items for shipment to over 100 countries.

**GCA-PRECISION SCIENTIFIC** 3737 W Cortland St, Chicago, IL, 60647, USA, Tel: +1-312-227-2660, Telex: 4330120, Fax: +1-312-227-8228, Contact: Mr Rouso. Low temperature incubator, primary usage BOD test (five days 20 degrees Centigrade). The sewerage sampler is used to collect water samples at considerable depth. The sampler holds a 250ml or 300ml BOD sample bottle.

**GLOBAL RESOURCE PLANNING** 928 Humphries Avenue, PO Box 149127, Orlando, FL 32814, USA. Complete, turn-key, chemical/environmental laboratory and training of laboratory personnel to use the equipment. Can supply sampling equipment and training for its use, or we can supply the personnel and equipment to do sampling and field testing.

**GRANT INSTRUMENTS (CAMBRIDGE) LTD** Barrington, Cambridge, CB2 5QZ, UK, Tel: +44-763-60811, Telex: 81328 grant g, Fax: +44-763-62410, Contact: Sarah Chapman. Manufacturers of laboratory water baths and circulators, and of portable battery operated data loggers.

**HACH CO** World Headquarters, PO Box 389, Loveland Co 80539, USA Tel: +1-303-669-3050, Fax: +1-303-669-2932. Water Testing Equipment: HACH COMPANY offers analytical systems for field, laboratory and on-line water testing; laboratory and on-line turbidimeters and chlorine analyzers; preprogrammed spectrophotometers; pH meters and electrodes featuring advanced Hach One™ Technology; microbiological tests; and over 200 test kits ranging from single-parameter kits to complete portable laboratories, including pre-measured reagents and step-by-step instructions.

**HACH EUROPE B P** 51, Namur 1, B 5000, Belgium, Tel: +32-81-445381, Fax: +32-81-441300, Contact: Alail Dehant. Hach produce a complete range of systems for water quality analysis. Products include test kits, portable laboratories, lab instruments and special process analysers.

**HARVARD / LTE** Greenbridge Lane, Greenfield, Oldham, OL3 7EN, UK, Tel: +44-457-76221, Fax: +44-457-770131, Contact: Robert J Bowen. Harvard/LTE is a British company with over 40 years' experience in the manufacture of laboratory equipment. We specialize in laboratory and instrument autoclaves from 3 litres up to 200 litres. A range of laboratory ovens, incubators, water baths and shakers is available, along with glassware drying cabinets and bottle storage cabinets.

**KANE-MAY LTD** Swallowfield, Welwyn Garden City, Herts, AL7 1JP, UK, Tel: +44-707-331051, Telex: 25724, Fax: +44-707-331202, Contact: Mrs Pamela Abbott. Kane-May Ltd designs and manufactures a range of portable electronic measuring and recording instruments which are sold worldwide. Parameters measured include pH, temperature, humidity, dewpoint, airflow and combustion gas, including some instruments with intrinsically safe approval.

**LABCONCO** 8811 Prospect, Kansas City, MO, 64132, USA, Tel: +1-816-333-8811. Worldwide manufacturer of laboratory equipment including water purification systems, fume hoods, freeze dry and Kjeldahl apparatus and Laminar flow equipment.

**MONITEK TECHNOLOGIES INC** 1495 Zephyr Avenue, Hayward, CA, 94544, USA, Tel: +1-415-471-8300, Fax: +1-415-471-8647, Contact: Mary A Betts. Monitek Technologies Inc is a manufacturer of measurement and control instrumentation for industrial and municipal markets. We make products for measuring flow, level, suspended solids, turbidity, sludge blanket level, dissolved oxygen and turbidity. We make both in-line and laboratory models.

**JOHN MOWLEM AND COMPANY PLC** Westgate House, Ealing Rd, Brentford, Middlesex, TW8 0QZ, UK, Tel: +44-1-568-9111, Telex: 24414, Fax: +44-1-847-4802, Contact: Jane Sandy. International construction and engineering group. Specialists in tunnelling for sewers and hydro schemes throughout the world. Some of the Mowlem Group subsidiaries are leaders in the field of soil mechanics, laboratory equipment, tankage, pipework and pilling.

**NAGLE CO, DIVISION OF SYBRON CORP** Po Box 20365, Rochester, N.Y, 14602, USA, Tel: +1-716-586-8800, Telex: 978242, Fax: +1-716-586-8431, Contact: Kathryn Hafenstiner. Filtration products for water analysis and plastic products for industrial laboratories.

**NESTER INSTRUMENTS/DIV OF LEEDS & NORTHRUP** Sumneytown Pike/MID-222, North Wales, PA, 19454, USA, Tel: +1-609-825-0254. Manufacturer of portable and laboratory analytical instrumentation.

**OSMONICS INC** 5951 Clearwater Drive, Minnetonka, Minnesota, 55343 USA Tel: +1-612-933-2277, Telex: +290847, Fax: +1-612-933-0141. Osmonics manufactures a variety of products for the laboratory market: biostatic pure silver membranes for analytic procedures and hot gas sampling, ceramic crucibles for quantitative analyses, CERATREX™ ceramic filters for steam filtration, OSMOORION™ reverse osmosis and ion exchange for water purification. Osmonics' SEPA® CF and ST



laboratory scale crossflow filtration units are designed for the biotechnology laboratory.

**PHILIPS SCIENTIFIC** York St, Cambridge, CB1 2PX, UK, Tel: +44-223-358866, Telex: 817331, Fax: +44-223-312764, Contact: Mr Goodall. Philips Scientific offers the world's widest range of analytical techniques from electrochemistry to electron microscopy. A vast range of electronic test and measurement equipment together with communications, security and industrial automation systems.

**PHIPPS & BIRD** 8741 Landmark Rd, Richmond, VA, 23228, USA, Tel: +1-804-264-7590, Fax: +1-804-264-7631, Contact: Wes Skaperdas. Phipps & Bird is a manufacturer of multiple-paddle (gang) stirrers for use in jar tests and other water and wastewater treatment laboratories. A complete line of accessories (illuminators, carrying cases, square jars etc) is available. Phipps & Bird has been serving the water industry world-wide since 1925.

**ROBIN INSTRUMENTS LTD** PO Box 93, Camberley, Surrey, GU15 1DU, UK, Tel: +44-276-26987/8, Telex: 858902, Fax: +44-276-64091, Contact: Mr Robin Norman. Main agents for Dr Bruno Lange GmbH, supplying laboratory instrumentation for COD and cuvette tests. Also turbidity meters and on-line nitrate meters. Worldwide distribution of portable incubator systems for E-Coli/Feacalform analysis.

**SENSIDYNE INC** Suite E, 12345 Starkey Rd, Largo, FL, 34643, USA, Tel: +1-813-530-3602, Telex: 756223, Fax: +1-813-539-0550, Contact: Mr Greg Cumerum. Manufacturers and exporters of portable and fixed gas monitoring equipment and other air handling equipment.

**SORBIOS GMBH** Ackerstrasse 71-76, 1000 Berlin 65, W Germany, Tel: +49-30-469-46-31, Fax: +49-30-469-46-46. Ozone generators, monitors, uV photometry, ozone process equipment, laboratory and engineering services, tour partner in ozone technology for water treatment (ultrapure, drinking, swimming pool and sewage water) chemical synthesis and sterilizing processes.

**WHEATON** 1000 N 10th St, Millville, NJ, 08332, USA, Tel: +1-609-825-1400. For 100 years the name Wheaton, the mark of quality, has meant useful, quality products for the laboratory, including ampules, vials, containers, cell culture and sample handling apparatus, fermentation, water purification and liquid handling systems. Please contact for further details.

**YSI INCORPORATED** YSI Scientific Ltd, Lysons Avenue, Ash Vale, Aldershot, Hampshire, GU12 5QR, UK, Tel: +44-252-513006, Telex: 858210 INSTCOG, Fax: +44-252-511855. YSI dissolved oxygen and conductivity instruments monitor wastewater treatment and provide environmental control and enforcement. Other YSI systems help maintain pure water supplies by measuring temperature, pH, conductivity and ORP in surface water and groundwater as it's pumped from test wells. YSI instruments assure healthy crops of fish and shellfish in hatcheries and on fish farms.

## Level Indicators and Controls

**pHOX SYSTEMS LTD** Ivel Rd, Shefford, Beds, SG17 5JU, UK, Tel: +44-462-813103, Telex: 825480, Fax: +44-462-814191, Contact: Mr Crossley. Instrumentation and systems for the water and process industries. Represented throughout the world. On-site advice available.

**ARKON INSTRUMENTS LTD** Unit C3, Liddington Trading Estate, Old Station Drive, Leckhampton, Cheltenham, Glos, GL53 0DL, UK, Tel: +44-242-573444, Telex: 437269, Fax: +44-242-221701, Contact: Mr Brian Scott. Specialist suppliers of instrumentation for flow level, pressure and vacuum for water, gas and air. Also supply analytical instruments for the water industry ie: pH, redox, dissolved oxygen etc.

**BESTOBELL MOBREY SPARLING METER FLOW** 190-196 Bath Rd, Slough, Berks, SL1 4DN, UK, Tel: +44-753-34646, Telex: 848875, Fax: +44-753-693603, Contact: Adrian Payne. Controls and instrumentation. Design and manufacture of electro-mechanical, electronic and microprocessor based equipment for liquid level, flow measurement, energy saving, pollution monitoring and boiler safety.

**CHEYLINE-INSTRUMENTS INC** 800 Campbell St, Cornwall, ONT, K6H 6L7, Canada, Tel: +1-613-938-8956, Telex: 05811520, Fax: +1-613-938-4857, Contact: Mr Higginson. Manufacture non-contacting flow and level instrumentation. The products include doppler type flow meters which work from outside a pipe, open channel flow meters, liquid level indicators.

**CLASSEN AND CO LTD** Horton Close, West Drayton, Middlesex, UB7 8JA, UK, Tel: +44-895-443206, Fax: +44-895-441274, Contact: Mr Thomas. Classen and Co are distributors for a full range of multiple application pumps from Hanning & Kahl and Grindex submersible electric pumps from 1-50hp, and Telstar float regulators.

**ALAN COBHAM ENGINEERING LTD** Holland Way, Blanford Forum, Dorset, DT11 7BJ, UK, Tel: +44-258-51441, Telex: 417254, Fax: +44-258-51414, Contact: Gordon Day. Design and manufacture of liquid level control equipment: float switches, flow switches, level indicators and control valves. Also manufacture filtration equipment.

**CONDRILL AB** Sveavagen 83 113 50 Stockholm Sweden Tel: +46-8-349560, Telex: +12336, Fax: +46-8-316762

**CRANE PRO-TECH ENVIRONMENTAL INSTRUMENTS** 800 Third Avenue, King of Prussia, PA, 19406, USA, Tel: +1-215-265-7212, Fax: +1-215-265-5432, Contact: E W J Diaper. Samplers are used for collecting samples of wastewater effluent for storage and analysis, flow monitors for measuring flow in open channels such as sewers and drains, distance and level meters are ultrasonic and electro-mechanical, used for measuring liquids and granular materials stored in tanks and bins.

## LEVEL INDICATORS AND CONTROLS

**DELTA CONTROLS LTD** Island Farm Avenue, East Molesey, Surrey, KT8 0UZ, UK, Tel: +44-1-941-5166, Telex: 27109, Fax: +44-1-783-1163, Contact: Richard Wigmore. Manufacturers of standard and custom built pressure, pressure difference, temperature, flow, vacuum and level switches, liquid level transmitters and fibre-optic based sensors for use in all areas. Instrument needle valves and manifolds and pressure transducers.

**DETECTRONIC LTD** Systems House, Edge Nook Lane, Shadsworth, Blackburn, BB1 2QB, UK, Tel: +44-254-54583, Telex: 635091 Albion G, Fax: +44-254-680604, Contact: Mr Woods. Manufacture a comprehensive range of specialised systems for many applications including: sewer flow and rainfall measurement and analysis, flow measurement and control of sewage treatment works, industrial process and effluent measurement, level measurement and control, pump protection using non-invasive flow detection.

**DRUCK LTD** Fir Tree Lane, Groby, Leicester, LE6 0FH, UK, Tel: +44-533-878551, Telex: 341743 DRUCK G, Fax: +44-533-875022, Contact: Susan Mould. Suppliers of precision depth and level measurement systems. Druck Ltd also supply transducers, transmitters and related digital indicators.

**DRUCK NEDERLAND BV** P.O. Box 232, Barendrecht, AE, 2990, The Netherlands, Tel: +31-1806-11555, Telex: 28164, Fax: +31-1806-18131, Contact: John Oosthon. Specialists in level and measuring devices including calibration and pressure measuring equipment, transducers.

**ENDECO INC** 13 Atlantis Drive, Marion, MA, 02738, USA, Tel: +1-617-748-0366, Telex: 929451 Endeco MNMS, Fax: +1-617-748-2543, Contact: Mrs Jones. Endeco Inc designs and manufactures instruments for monitoring water flow, waterlevel, ocean wave spectra and ocean chemistry. In addition, the company produces complete marine data acquisition systems customized for the needs of specific customers.

**EPIC PRODUCTS LTD** Broadway Industrial Area, Salford, M5 2UQ, UK, Tel: +44-61-872-1487, Telex: 665781 Mantel G, Fax: +44-61-848-7324, Contact: Mr Smith. Manufacturers of a complete range of automatic liquid samplers for use with raw sludge, crude sewage, etc and instruments to measure level and open channel flow.

**FLUID PRODUCTS CO INC** 14590 Martin Drive, Eden Prairie, MN, 55344, USA, Tel: +1-612-937-2467, Fax: +1-642-927-9726. Fluid Products Company Inc is a manufacturer of liquid level controls, switches and relays offering a standard line of single point switches. Multi-point switches can be made to customer's specifications. Also relays, one of which is intrinsically safe and FM approved. Delivery is off-the-shelf for standard items and 2-4 weeks for specials.

**HAWKER ELECTRONICS** Unit 250, Melchett Rd Kings Norton, Birmingham, B30 3HP, UK, Tel: +44-21-459-8911, Telex: 336579, Fax: +44-21-433-3041. Hawker Electronics specialise in the control and monitoring of lev-

els in water and sewage especially for the water and sewage authorities using Electrode, Pressure Transducer, Ultrasonic and Pneumatic systems.

**HEEL GmbH & CO MESSTECHNIK KG** Jacoerstrasse 4 - 12, Postfach 17 45, Kempten, D-8960, West Germany, Tel: +49-831-20-59-02, Fax: +49-831-2-05-9105, Contact: Herbert Friedrich. Water level recorders, contact gauges for water level and temperature.

**WARREN JONES ENGINEERING LTD** 120-124 Churchill Rd, Bicester, Oxon, OX6 7XD, UK, Tel: +44-869-246691, Telex: 83194, Fax: +44-869-253340, Contact: John Corris. Manufacturers of ultra-sonic level measurement equipment, sewage treatment monitoring equipment, and portable open-channel flow recorders.

**KIPSZER** P.O. Box 28, Budapest X, Faszberenyi ut 36, H-1475, Hungary, Tel: +36-1-575-122, Telex: +22-5328, Fax: +36-1-572-958. Fluicont<sup>®</sup> process control intelligent system including pull over level switches, submersible level switches, level control instruments, pressure and level transmitters. These systems can save energy up to 10 per cent.

**KROHNE MESSTECHNIK GmbH & CO KG** Ludwig-Krohne-Str 5, Duisburg 1, D-4100, West Germany, Tel: +49-203-301-0, Fax: +49-203-301-389, Contact: Mr Wilhelm Auf dem Hovel. Produce measuring instruments of highest precision for flow metering, mass measurement, level gauging and density measurement. Production programme is geared to the needs of each market, together with a smoothly functioning worldwide network.

**GEORGE LANCASTER LTD** 501 Ipswich Rd, Slough Trading Estate, Slough, Berkshire, SL1 4EP, UK, Tel: +44-753-692527, Telex: 846395 Remex G, Fax: +44-753-73235, Contact: Mr Moghul. Manufacturers of float switches. Suppliers of pumps and pump equipment.

**MARINE INDUSTRIE PETROLE** BP 47, Domont, Cedex, 95332, France, Tel: +33-1-39-91-12-12, Telex: 605928, Fax: +33-1-3-9912704, Contact: M Laplagne. Manufacture level switches, magnetic level indicators, instrument valves, butterfly valves, eccentric disc valves and microflow valves.

**MASSA PRODUCTS CORPORATION** 280 Lincoln St, Hingham, MA, 02043, USA, Tel: +1-617-749-4800, Fax: +1-617-740-2045, Contact: Fred Straut. Massa Products Corporation is a medium sized manufacturer of ultrasonic air transducers, ranging modules, ultrasonic proximity systems used in a variety of industrial, medical and consumer applications.

**MONITEK TECHNOLOGIES INC** 1495 Zephyr Avenue, Hayward, CA, 94544, USA, Tel: +1-415-471-8300, Fax: +1-415-471-8647, Contact: Mary A Betts. Monitek Technologies Inc is a manufacturer of measurement and control instrumentation for industrial and municipal markets. We make products for measuring flow, level, suspended solids, turbidity, sludge blanket level, dissolved oxygen and turbidity.

**OCV CONTROL VALVES** 7400 East 42 Place, Tulsa,

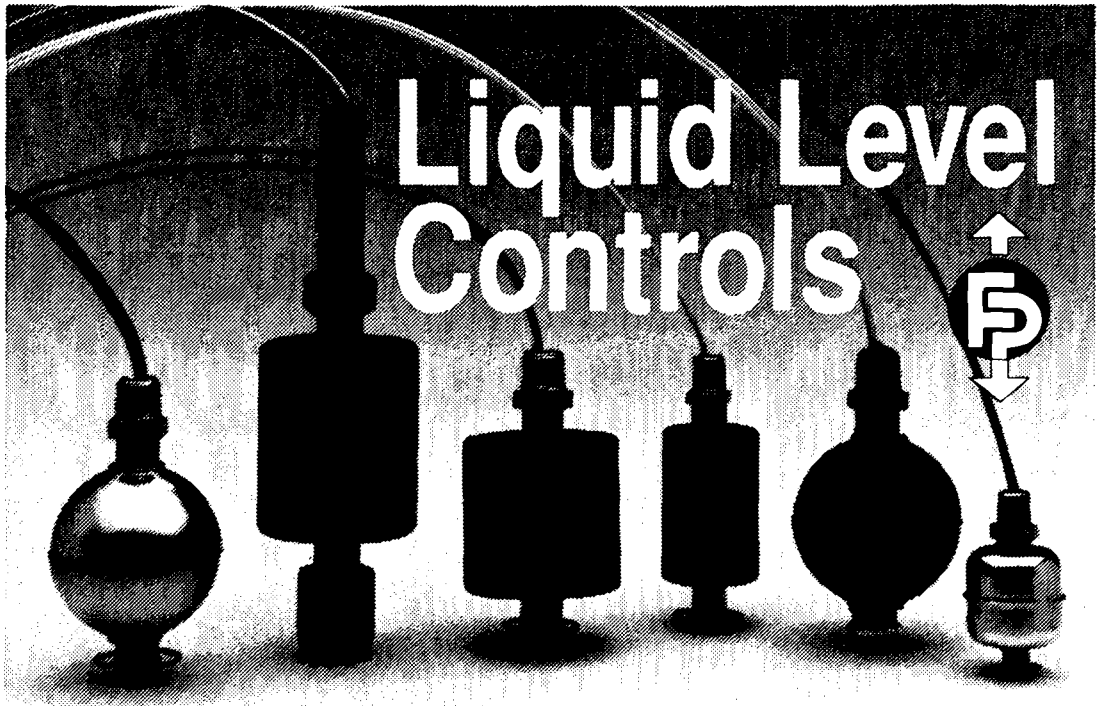

# Liquid Level Controls

**Monitor liquid level** in vessels of all sizes — "tea cups" to large tanks. Magnetic floats actuate internal reed switches to control pumps, alarms, valves, motors... *fast delivery* on standards and specials.

**Single point** float sizes down to 3/4".

**Multi point** monitors up to 40 or more levels.

**Construct-A-Level** kits for on-site assembly.

**Temp-A-Level** senses liquid temp and level.

**Side Mounted** for inaccessible tanks.

**Solid State Relays** to 15 amps AC. FM Approved Intrinsically Safe and Latching.

**CALL 612-937-2467**

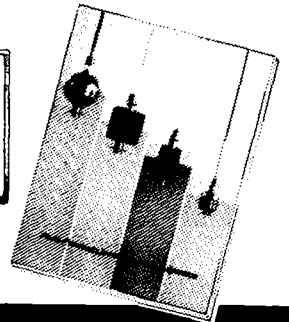

## FLUID PRODUCTS CO., INC.

14590 Martin Drive • Eden Prairie, MN 55344

## LEVEL INDICATORS AND CONTROLS

---

Oklahoma, 74145, USA, Tel: +1-918-627-1942, Telex: 910-845-2227, Fax: +1-918-622-8916. OCV manufactures and internationally markets a complete line of automatic, hydraulically operated, diaphragm actuated, pilot controlled valves. The line contains two series for handling liquid level control, the series 3000/3333 for elevated towers, standpipes and tanks, the series 8000/8100 float controlled valves for above and below ground storage tanks.

**PROCESS STYRNING AB** P O Box 410-135-24, Tyresö, Sweden, Tel: +46-8-712-0425, Fax: +46-8-742-8330, Contact: Peter Swanson. Sensors and transmitters for clean and waste water plants, level meters, flow meters, water samplers, pH-meters, conductivity meters and 0<2>-meters.

**SAAB PROCESS AUTOMATION** P O Box 608, Sjöflö, 66100, Sweden, Tel: +46-533-15060, Telex: 5347 SPA AB2, Fax: +46-533-16931, Contact: Gony Cronquist. Saab Process Automation is a leading Swedish manufacturer of measurement and control equipment for municipal and industrial water and sewage plants. Product range consists of sophisticated supervisory and control systems as well as measurement equipment for pH, redox, oxygen, flow, level, pressure and temperature.

**SARASOTA AUTOMATION LTD** Kingsworthy, Winchester, Hants, SO23 7QA, UK, Tel: +44-962-883200, Telex: 47189, Fax: +44-962-885530, Contact: Derek O'Garr. Sarasota produce flow and level gauges for rivers and sewers using ultrasonic and electromagnetic techniques. Sherpa loggers and viewlog software are used in water distribution to monitor flow and pressure in a network.

**SEBA HYDROMETRIE GmbH** Dessestr 5, Kaufbeuren-Neugablonz, D-8950, West Germany, Tel: +49-8341-62026, Fax: +49-8341-62029, Contact: Wolfgang Zasche. Seba Hydrometrie is a manufacturer of hydrological, meteorological and sewage measuring instruments. The instruments are installed in more than 90 countries worldwide. Range of production: water level recorders and control systems, water sampling equipment: 2"- and 4"- mechanical samplers, 2" submersible pump with 12 l/min capacity, current meters/winchers, data loggers and transmission systems and all kind of meteorological sensors.

**SEETRU** Albion Dockside Works, Hanover Place, Bristol, Avon, BS1 6UT, UK, Tel: +44-272-279204, Telex: 44697, Fax: +44-272-298193, Contact: Mr Grigsby. Manufacture safety release valves and liquid level gauges with both tubular glass and plastic sight tubes and prismatic reflex flat glass type tubes. Gauges available with automatic shut off valves. Also small circular sight glass.

**SENSATRON** 7551 Convoy Court, San Diego, CA, 92111, USA, Tel: +1-619-560-4400. An experienced OEM supplier with proven performance in quality products, using new state-of-the-art capacitance sensing electronics to sense water levels. New technology provides for no mechanical object in corrosive water, no current introduced into water and no pump stutter (false cycling).

**SHELLEY-SIGNS LTD** Eaton on Tern, Market Drayton, Shropshire, UK, Tel: +44-95-283483, Contact: Mr Shelley. Manufacturers of GRP water depth gauge boards and signs.

**SMAIL SONS AND CO LTD** Unit 1 St Andrews Rd, Glasgow, G41 1PP, UK, Tel: +44-41-429-4429, Telex: 777360, Fax: +44-41-429-2949, Contact: Mr Wheelan. Suppliers of water level recorders and water level contact gauges.

**SOCLA S A FRANCE** 1 Rue Paul Sabatier - BP300, 71107 Chalon s/Saone, Cedex, France, Tel: +33-85-46-30-34, Telex: 800259 SOCLA CHALN, Fax: +33-85-41-49-31. Socla has a range of control equipment available that includes float level switches, pressure switches for use with air compressors and pressure tanks and protection devices for use with submersible pumps.

**SPACE AGE ELECTRONICS INDUSTRIAL LTD** Spalding Hall, Victoria Rd, London, NW4 2BE, UK, Tel: +44-1-203-1132, Telex: 8811085, Fax: +44-1-203-4496, Contact: Mr Pepper. Space Age Electronics offer a range of high quality, low cost process control instrumentation covering ultrasonic level and flow equipment, as well as the new, transducer - radio telemetry range of radio data transmission systems. These have the ability to control the duty cycle of remote transducers, depending upon the state of a switch input, or an analogue level.

**TEKFLO SENSORS LTD** Albany Rd, Granby Industrial Estate, Weymouth, Dorset, DT4 9TH, UK, Tel: +44-305-772239, Telex: 41394, Fax: +44-305-772238, Contact: Jeff Rivers. Tekflo Sensors Ltd provide flow, level and differential measurement for the water industry. Can offer single items of equipment or complete measurement loops, from the primary sensor to the microprocessor based control system.

**THORNTON** 1432 Main St, Waltham, MA, 02154, USA, Tel: +1-617-890-3399, Telex: 928096, Fax: +1-617-890-5507, Contact: Agie Leonguerrier-Winters. Manufacturers of resistivity, conductivity, % rejection, flow, pressure, pH, tank level controllers and sensors for Di/Ro.

**TIERWAY LTD** Unit 15 Sandown Park, White Horse Technology Park, Trowbridge, Wilts, UK, Tel: +44-373-823599, Fax: +44924, Contact: Mr Derrick. Level measurement and control for water, effluents, sewage etc, and for powders and granular solids. Control panels and complete instrument systems. Installation and commissioning.

**TRANSINSTRUMENTS** Lennox Rd, Basingstoke, Hampshire, RG22 4AW, UK, Tel: +44-256-20244, Telex: 858103, Fax: +44-256-473680, Contact: Sue Taylor. Transinstruments manufacture an extensive range of waterproof pressure transducers and transmitters for fluid pressure, level and depth measurement. Designed for easy care, low cost ownership and virtually maintenance-free operation.

**TUBAFOR INTERNATIONAL** 39 Champs Elysees, Paris, 75008, France Tel: +33-142259342, Telex: +280888, Fax: +33-145638408. Hydrometric Instruments, Electric

## LEVEL INDICATORS AND CONTROLS

Contact Meters, Water Level Indicators, Water Level Recorders - Float, Bubbler gauge, Pressure transducer; Borehole Water Samplers, Solid State Memory Recorders.

**VALEPORT MARINE SCIENTIFIC LTD** Unit 7 Townstal Industrial Estate, Dartmouth, Devon, TQ6 9LX, UK, Tel: +44-8043-4031, Telex: 42669, Fax: +44-8043-4320, Contact: Andrew Talbot. Valeport manufacture and supply the Braystoke range of hydrological instruments and associated accessories for water flow and level measurement.

**WARRICK CONTROLS INC** 4237 Normandy Court, Royal Oak, MI, 48073, USA, Tel: +1-313-545-2512, Fax: +1-313-49-4904, Contact: Ted Wrona. Manufacture of conductance probe-type liquid level control systems. Other products include float switches and cybersounds (audible signalling devices).

**THE 30-98 CO LTD** 8 Avocet Trading Estate, 7 Victoria Gardens, Burgess Hill, W Sussex, RH15 9JZ, UK, Tel: +44-4446-43461, Telex: 87323 fsi bindex, Fax: +44-4446-43464, Contact: Mrs Walton. Process control engineers and manufacturers of the "Bin-Dex" and "Roto-bindex" range of level controls, also liquid-data (a continuous liquid level indicator) and the floatless level control for liquids.

### Meters - Flow Measurement

**ACCUSONIC DIVISION FERRANT ORE INC** PO Box 709, Falmouth, Massachusetts, 02541, USA, Tel: +1-617-548-5800, Telex: 6817399, Fax: +1-617-540-3835, Contact: Diane Ward. Accusonic offers a variety of flow measurement systems and services all based on the highly accurate multiple parallel path ultrasonic technique. Both permanent and portable systems are available to meet virtually all flow measurement requirements.

**ARAD LTD DALIA** Water Meter Works of Israel, Doar Dalia, 18920, Israel, Tel: +972-4-897911, Telex: 46383, Fax: +972-4-897960. Arad - 50 years a pioneering force in the production of technologically superior water meters, hydraulic and electronic control systems and irrigation valves. Arad systems are designed to meet modern needs of municipalities, agriculture and industry.

**ARKON INSTRUMENTS LTD** Unit C3 Liddington Trading Estate Old Station Drive Leckhampton, Cheltenham, Glos, GL53 0DL, UK, Tel: +44-242-573444, Telex: 437269, Fax: +44-242-221701, Contact: Mr Brian Scott. Specialist suppliers of instrumentation for flow level, pressure and vacuum for water, gas and air. Also supply analytical instruments for the water industry ie: pH, redox, dissolved oxygen etc.

**ASHDOWN PROCESS CONTROL LTD** Huntsfield, North Close, Shorncliffe Industrial Estate, Folkestone, Kent, CT20 3UH, UK, Tel: +44-303-40691, Telex: 966355 Ashpc G, Fax: +44-303-40703, Contact: Mrs Higgins. Manufacturers of pressure and differential pressure

transmitters and transducers for measurement applications including, flow and level of liquids and slurries, together with the recent addition of a technological advanced insertion flow-meter.

**BESTOBELL MOBREY SPARKLING METER FLOW** 190-196 Bath Rd, Slough, Berks, SL1 4DN, UK, Tel: +44-753-34646, Telex: 848875, Fax: +44-753-693603, Contact: Adrian Payne. Controls and instrumentation. Design and manufacture of electro-mechanical, electronic and microprocessor based equipment for liquid level, flow measurement, energy saving, pollution monitoring and boiler safety.

**K BIESINGER GmbH** Neckarsteinacher Strasse 74, Hirschhorn, 6932, West Germany, Tel: +49-6272-2037, Telex: 466808, Contact: Mr Thurnwald. Biesinger is a firm who have a production plant of water meters for houses, flats and rooms.

**BLUE WHITE INDUSTRIES** 14931 Chestnut St, Westminster, CA, 92683, USA, Tel: +1-714-893-8529, Fax: +1-714-894-9492, Contact: Selma Haywood. Manufacturer of chemical feed metering pumps and flow meters with factory representatives covering USA, and overseas.

**BUSH BEACH ENGINEERING LTD** Stanley Green Trading Estate, Earl Rd, Cheadle Hulme, Cheshire, SK9 3RL, UK, Tel: +44-61-485-8151, Telex: 667-548, Fax: +44-61-488-4048, Contact: Mr John Moss. Flow measuring products including orifice plate and Venturi sensors, complete metering runs and flow transmitters and totalisers, temperature sensors, transmitters and indicators for monitoring pumps and machinery.

**C W COX INC** P O Box 3214, South El Monte, CA, 91733, USA, Tel: +1-818-443-5090, Contact: John Morgan. Full diameter Pitot tubes with adaptors for use in multiple pipe sizes. Center sampling rotameter-style meters. Accuracies from 2% for the pitot tubes to 5% for the rotameters. Test instruments and permanent installations.

**CALERAY LTD** 26 Powerscraft Rd, Sidcup, Kent, DA14 5DT, UK, Tel: +44-1-302-3302/3, Telex: 896498, Fax: +44-1-300-7106, Contact: Mr Ballard. Electromagnetic flow meters and associated electronics to enable the measurement of water, sewage and effluent for control and measurement of pollution.

**CARLON METER CO** 715 Robbins Rd, Grand Haven, MI, 49417, USA, Tel: +1-616-842-0420, Contact: Jim O'Brien. Manufacture water meters for the municipal, commercial and industrial market place. Also electronic control for treatment of water.

**CHEYLINE-INSTRUMENTS INC** 800 Campbell St, Carwall, ONT, K6H 6L7, Canada, Tel: +1-613-938-8956, Telex: 05811520, Fax: +1-613-938-4857, Contact: Mr Higginson. Manufacture non-contacting flow and level instrumentation. The products include doppler type flow meters which work from outside a pipe, open channel flow meters, liquid level indicators and pump controllers.

**CONDRILL AB** Sveavagen 83 113 50 Stockholm

## METERS - FLOW MEASUREMENT

Sweden Tel: +46-8-349560, Telex: +12336, Fax: +46-8-316762

**CONTROLOTRON CORP** 155 Plant Avenue, Hauppauge, NY, 11788, USA, Tel: +1-516-231-3600, Telex: 961449, Fax: +1-516-231-3334, Contact: Tony Dove. Clamp on ultrasonic flow meters for potable water, incoming waste water, sewage treatment lines, pipelines and other liquid applications.

**CRA Rue Charles Demeer**, 1020 Brussels, 105-117, Belgium, Tel: +32-2-428-7149, Fax: +32-2-425-8813. Waste water flow measurement and sampling equipment technology for industry and waste water plants.

**CRANE PRO-TECH ENVIRONMENTAL INSTRUMENTS** 800 Third Avenue, King of Prussia, PA, 19406, USA, Tel: +1-215-265-7212, Fax: +1-215-265-5432, Contact: E W J Diaper. Samplers are used for collecting samples of wastewater effluent for storage and analysis, flow monitors for measuring flow in open channels such as sewers and drains, distance and level meters are ultrasonic and electro-mechanical, used for measuring liquids and granular materials stored in tanks and bins.

**DANFOSS A/S**, Nordborg, DK-6430, Denmark, Tel: +45-74-88-22-22, Telex: 50599, Fax: +45-74-49-09-49. Danfoss places much emphasis on sensor technology. In the technology behind Danfoss components for water treatment, emphasis is laid on them being maintenance-free, robust and reliable. Please contact direct for further information.

**DANFOSS FLOWMETERING LTD** Magflo House, Ebley Rd, Stonehouse, Glos, GL10 2LU, UK, Tel: +44-45382-8891, Telex: 43692, Fax: +44-45382-4013, Contact: Bryan Franklin. Danfoss Flowmetering Ltd is an established leading supplier of instruments to the water/waste treatment industry. The main product is flowmeters and DFL are able to supply equipment for most applications.

**DATA INDUSTRIAL** 53 Portside Drive, Pocasset, MA, 02559, USA, Tel: +1-617-563-7196. Manufacture flow meters to measure water based liquids in closed pipe applications. Electronic sensor and display combinations.

**DATAMATIC INC** 2121 North Glenville Drive, Richardson, Texas, 75082, USA, Tel: +1-214-234-4491, Telex: 6502721938, Fax: +1-214-234-1134, Contact: Mr Larry Parchment. Vendors of meter reading systems for utilities throughout the world.

**DEMA ENGINEERING** 10020 Big Bend Boulevard, St Louis, MO, 63122, USA, Tel: +1-314-966-3533, Fax: +1-314-966-2532, Contact: Jack Deutsch. Dema Engineering Co offers a wide selection of dispensing equipment used to meter and proportion cleaning and sanitizing products. Proportioners, injectors, foamers and spray clean equipment mix chemical with water and air to provide a cleaning solution.

**DETECTRONIC LTD** Systems House, Edge Nook Lane, Shadsworth, Blackburn, BB1 2QB, UK, Tel: +44-

254-54583, Telex: 635091 Albion G, Fax: +44-254-680604, Contact: Mr Woods. Manufacture a comprehensive range of specialised systems for many applications including: sewer flow and rainfall measurement and analysis, flow measurement and control of sewage treatment works, industrial process and effluent measurement, level measurement and control, pump protection using non-invasive flow detection.

**DIGITAL FLOTRONICS** 12530 Beatrice St, Los Angeles, CA, 90066, USA, Tel: +213-305-7080. Manufactures the Digitron 1000, one of the only digital electronic POU fluid flowmeters on the market that shuts off automatically when your filter needs replacing. The Digitron 1000 is designed for use in all fluid flow applications. (WT)

**ELIN-UNION AG FÜR ELEKTRISCHE INDUSTRIE** POB 5, Penzinger Strasse 76, Wien, A-1141, Austria, Tel: +43-1-829000, Telex: 1-12763. Elin's line-up of water supply equipment embraces devices for water flow measurement and equipment for testing and calibrating these. The emphasis here is upon vane water meters. Elin are interested mainly in the export of domestic water meters.

**ELIN-WASSERWERKSTECHNIK GmbH** Hainburger Strasse 33, Wien 3, A-1030, Austria, Tel: +43-726621, Telex: 132142, Fax: +43-8285199, Contact: Mr Mehl. Elin manufacture equipment for water metering, flow measurement, apparatus for meter testing and calibrating as well as electronic remote control and data logging systems.

**ENDECO INC** 13 Atlantis Drive, Marion, MA, 02738, USA, Tel: +1-617-748-0366, Telex: 929451 Endeco MNMS, Fax: +1-617-748-2543, Contact: Mrs Jones. Endeco Inc designs and manufactures instruments for monitoring water flow, water level, ocean wave spectra and ocean chemistry. In addition, the company produces complete marine data acquisition systems customized for the needs of specific customers.

**FLOSONICS INC** PO Box 390, Umatilla, OR, 97882, USA, Tel: +1-503-567-1966, Contact: Terry R Henderson. Flosonics Inc offers state-of-the-art flow measurement equipment ranging from the sophisticated Westinghouse Calorimetric, four path system to lower cost ultrasonics, doppler and intrusive flowmeters. With over ten years experience with the electronics design, production and use of flowmeters, Flosonics Inc also offers a wide range of services.

**FLOW RESEARCH CORPORATION** P O Box 27871, Houston, Texas, 77227, USA, Tel: +1-713-623-2143, Fax: 762649, Contact: Bill Smith. Manufacture flow meters for liquid flow in various applications. Also three non-contact meters measuring flow from the outside pipe.

**THE FORD METER BOX COMPANY INC** P O Box 443, Wabash, Indiana, 46992-0443, USA, Tel: +1-219-563-8441, Telex: 023-2654 FORD WASH, Fax: +1-219-563-0167. The Ford Meter Box Company Inc manufactures the industry's most complete line of water works brass valves and fittings, meter setting and testing equipment and main line pipe repair products.

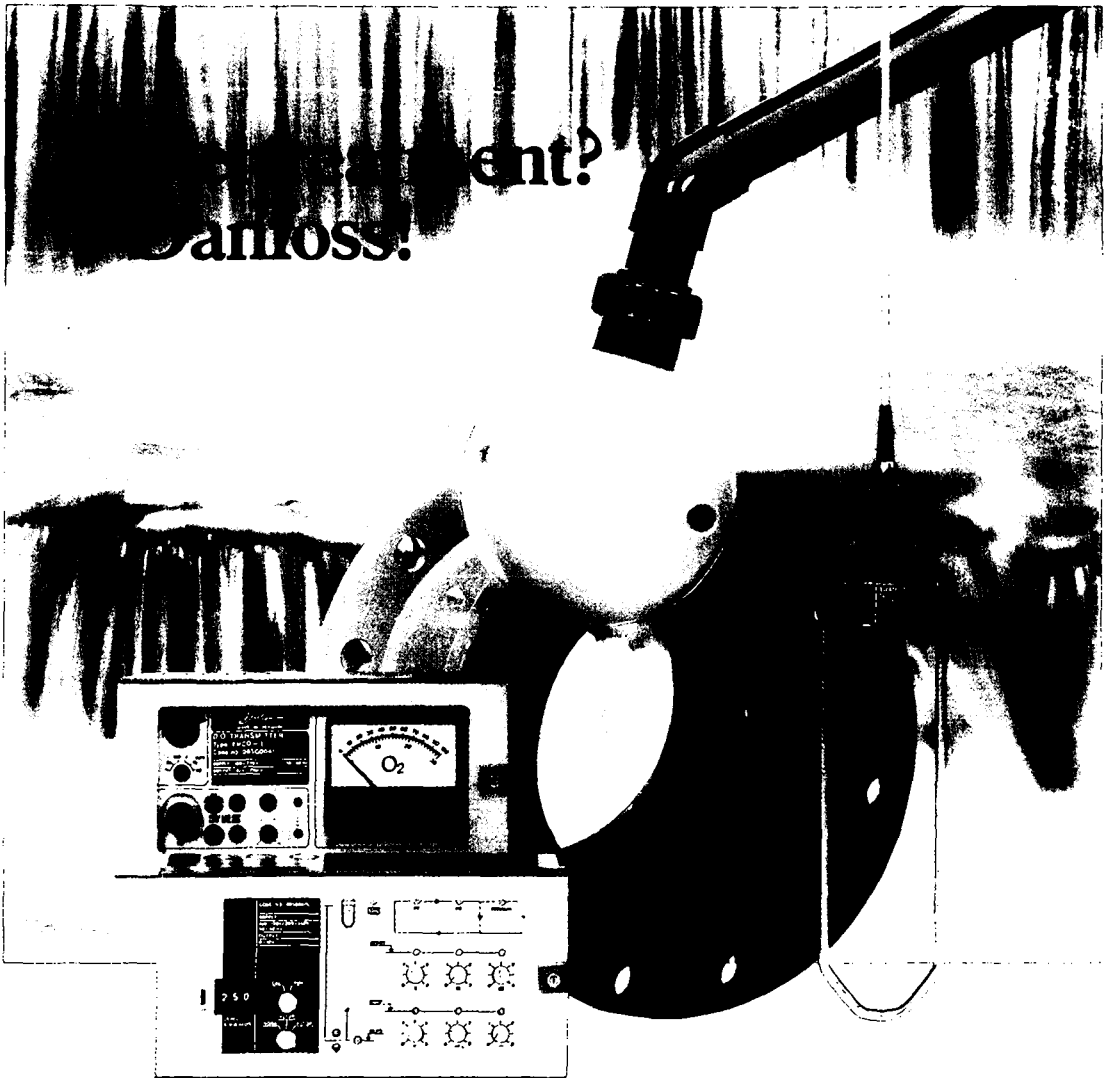

Process optimisation in waterworks for ground water and surface water, in sewerage systems and in purification plant, through the use of the latest technology in the measurement of

# flow, level, and oxygen

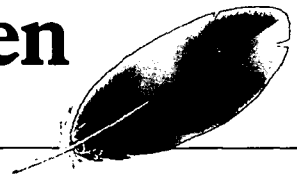

**Danfoss A/S**  
DK-6430 Nordborg  
Denmark  
Telephone: + 45 4 88 22 22  
Telefax: 45 4 49 09 49  
Telex: 50 599 danfss dk

UNIQUE IN ENGINEERING AND PERFORMANCE

3840\*\*\*\*

## METERS - FLOW MEASUREMENT

**FRAZER INTERNATIONAL** Walker House, 87 Queen Victoria St, London, EC4V 4AL, UK, Tel: +44-1-236-4008, Telex: 884733, Fax: +44-1-248-8615, Contact: Bob Braidwood. Supply "PAM" petrolatum tape, "Periquip" drilling, cutting and tapping equipment, "Roban" ductile iron pipe and Frazer water metering package. Materials include uPVC, MDPE, ductile pipe and fittings, pipe repair and protection, tools, drills and cutters. Metering equipment and metal detection equipment.

**GRAINLAND INC** 239 Lincoln, Clay Center, KS, 67432, USA, Tel: +1-913-632-3101, Fax: +1-913-632-5860, Contact: Kyle Bauer. GrainLand offers insertion flowmeters for portable and permanent installation. The electronic meters are programmable for various line sizes and report totality and rate of flow. No outside power is needed. Maintenance requirements are low and can be performed in the field.

**HEEL GmbH & CO MESSTECHNIK KG** Jaeoerstrasse 4 - 12, Postfach 17 45, Kempten, D-8960, West Germany, Tel: +49-831-20-59-02, Fax: +49-831-2-05-9105, Contact: Herbert Friedrich. Hydrometric instruments, current meters.

**HYDRIL UK LTD AOT FLOWSYSTEMS** Central Way, Walworth Industrial Estate, Andover, Hampshire, SP10 5BW, UK, Tel: +44-264-65961, Telex: 47107 Aotflo, Fax: +44-264-57819, Contact: Steve Atkins. Designers and manufacturers of in-line and insertion flow meters and meter provers, flow computers and indicators and control systems. Also offer hydraulic calibration service in a laboratory environment.

**INVENTRON** 23630 Industrial Park Drive, Farmington Hill, MI, 48024, USA, Tel: +1-313-473-9250, Fax: +1-313-473-9255, Contact: Gregory Marynbza. Offers a complete line of ultrasonic flow measuring systems for non-contact measurement in flumes, weirs and other open channels. Micro-processor based controller provides direct readout of flow rate.

**IRRIGATION COMPONENTS INTERNATIONAL INC** P O Box 1063, 202 Congress St, Mobile, Alabama, 36633, USA, Tel: +1-205-432-5085, Telex: 881262, Fax: +1-205-433-7467, Contact: Mr John McCabe. ICI manufacture the following items (for center pivots) gearboxes, gearmotors, sprinklers, drop pipes, main control panels, tower control panels, drive line couplings. Also a complete line of drip irrigation equipment, filters, valves, sprinkler irrigation equipment, (side rolls, aluminium fittings). Complete line of flowmeters, fertilizer/chemical injections pumps.

**JANSEN VENNEBOER B V** P O Box 12, AA Wijhe, 8130, The Netherlands, Tel: +31-5702-2525, Telex: 49418, Fax: +31-5702-3618. Design, production and installation of mechanical construction for hydraulic works. Products include: archimedean screws, penstocks, sluice gates, radial gates, regulating and measuring weirs, weedscreens, automatic raking installations, Volanta handpumps and low-head water turbines (up to 1000 kW).

**KDG INSTRUMENTS** Crompton Way, Crawley, West

Sussex, RH10 2YZ, UK, Tel: +44-293-25151, Telex: 87235, Contact: Redshaw. Specialising in flowmeters, pressure and level transmitters, KDG products are used in applications such as reservoir level and storage tank level monitoring, water flows and pressures. With panel and wall-mounted tank contents monitors.

**KENT METERS LTD** Pondwicks Rd, Luton, Bedfordshire, LU1 3LJ, UK, Tel: +44-582-402020, Telex: 825367, Fax: +44-582-36657, Contact: Mr Harris. Kent Meters is one of the worlds largest manufacturers of domestic and bulk water meters with a reputation for innovative design and advanced technology. The Kent range includes volumetric, multi jet and single jet domestic water meters in sizes 15mm to 40mm and bulk Helical Vane type, both horizontal and vertical types, in sizes 40mm to 500mm. This range is further extended with remote reading meters and combination meters. The company can also supply flow analysing systems and meter test stations.

**KEY INSTRUMENTS INC** 250 Andrews Rd, Trevoze, PA, 19047, USA, Tel: +1-215-357-0893, Fax: +1-215-357-9239, Contact: Joe Papiernik. More than 60 standard 10:1 scales for air and water in SAE or metric indicate flow from 5cm<sup>3</sup> to 23 gpm or tailored to specific DEM requirements for most gas or liquid applications.

**KROHNE AMERICA INC** One Intercontinental Way, Peabody, MA, 01960, USA, Tel: +1-617-535-6060. Manufacture several lines of flowmeters including magnetic, ultrasonic and variable area flowmeters. All of the application engineers and regional sales managers in our five locations are qualified to assist in the application of our equipment.

**KROHNE MESSTECHNIK GmbH & CO KG** Ludwig-Krohne-Str 5, Duisburg 1, D-4100, West Germany, Tel: +49-203-301-0, Fax: +49-203-301-389, Contact: Mr Wilhelm Auf dem Hovel. Produce measuring instruments of highest precision for flow metering, mass measurement, level gauging and density measurement. Production programme is geared to the needs of each market, together with a smoothly functioning worldwide network.

**LEEDS AND NORTHRUP CO** Sunneytown Pike, North Wales, PA, 19454, USA, Tel: +1-215-643-2000, Fax: +1-215-699-5245, Contact: Bill Reed. Manufacturer of analytical instrumentation and sensors for water and waste water treatment. Also manufacture ventry meters and rate-of-flow controllers, liquid and dry chemical feeds equipment, filter bottoms, surface agitators, troughs, digital and analog control systems.

**MARSH-MCBIRNEY INC** 8595 Grovemont Circle, Gaithersburg, MD, 20877, USA, Tel: +1-301-869-4700, Telex: 7108280083, Fax: +1-301-926-6620, Contact: Amy Marsh. Since 1971, Marsh-McBirney Inc has been a manufacturer of flow measuring instrumentation for water and wastewater applications. Several illustrated brochures feature the products offered at Marsh-McBirney. Permanent and portable configurations are available for a variety of applications.

**GEORGE MELLER LTD** Orion Park, Northfield Ave-



## Our 108 specialist products can tell you

Write fax or phone for your copy of our detailed distribution monitoring catalogue of data loggers, sensors, analysis software, etc., and for information on local agents.

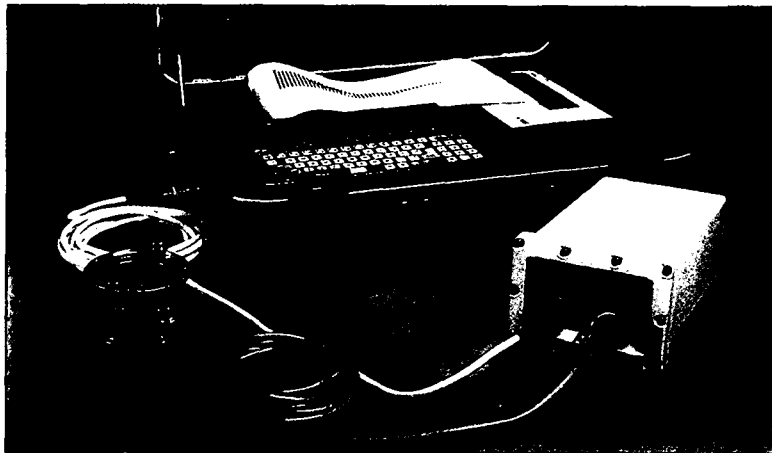
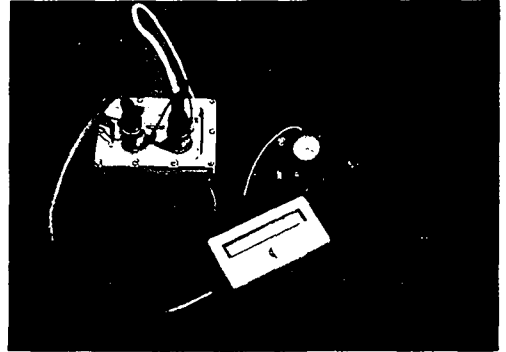
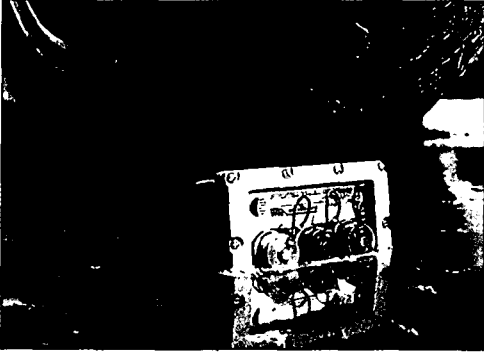

**Spectrascan Limited,**  
42 New Brighton Road, Emsworth,  
Hampshire PO10 7QR, England.  
Telephone: (0243) 379121 (3 lines) Telex: 86402 Fax: (0243) 371471

## METERS - FLOW MEASUREMENT

nue, London, W13 9SJ, UK, Tel: +44-1-579-2111, Telex: 27800/919153, Fax: +44-1-579-7326, Contact: Mr Ansari. George Meller Limited is a supplier of equipment to the process industries. Specifically for the water industry we can supply flowmeters, valves and pumps.

**MILTON ROY CO** 201 Ivyland Rd, Ivyland, PA, 18974, USA, Tel: +1-215-441-0800, Telex: 4761138, Fax: +1-215-441-8620, Contact: Jack Craneg. The coagulant control centre represents the best available technology for coagulant/flocculant dose monitoring and automatic control in treatment of raw surface waters, waste sludge dewatering and process water.

**MILTON ROY COMPANY HARTELL DIVISION** 70 Industrial Drive, Ivyland, PA, 18974, USA, Tel: +1-215-322-0730. Manufacturer of chemical metering pumps.

**MONITEK TECHNOLOGIES INC** 1495 Zephyr Avenue, Hayward, CA, 94544, USA, Tel: +1-415-471-8300, Fax: +1-415-471-8647, Contact: Mary A Betts. Monitek Technologies Inc is a manufacturer of measurement and control instrumentation for industrial and municipal markets. We make products for measuring flow, level, suspended solids, turbidity, sludge blanket level, dissolved oxygen and turbidity. We make both in-line and laboratory models.

**NATIONAL ENGINEERING LABORATORY** East Kilbride, Glasgow, G75 0QH UK Tel: +44-355-220222, Telex: +777888, Fax: +44-355-236930. The National Engineering Laboratory (NEL) has the world's most comprehensive collection of calibration facilities for water/air/oil/multiphase flow metering. The NEL large water flow (up to 1.5m<sup>3</sup>/s) system is the UK primary standard of flow measurement. The facilities of NEL are regarded as major reference points in the traceability of flow measurement both nationally and internationally.

**NBA ENVIRONMENTAL SYSTEMS** Invincible Rd, Farnborough, Hampshire, GU14 7QU, UK, Tel: +44-252-514335, Telex: 858510, Fax: +44-252-521912, Contact: Mr Gittings. With over 22 years experience in environmental monitoring, products include: water level and quality measuring instruments and clean or dirty water flow meters, for open channel and closed conduit application.

**NEPTUNE** 312 Hornsby Drive, Tallahassee, AL, 36078, USA, Tel: +1-205-283-6555. Manufacture and market quality flowmeters, systems and data capture devices for the water utility and water treatment control markets.

**NUSONICS INC** 11391 E. Techimsett St, Tulsa, OK, 74116-1602, USA, Tel: +1-918-438-1010, Telex: 49592, Fax: +1-918-438-6420, Contact: Ranson. Line of transit-time flow meters provide accuracy + 1% no moving parts, no pressure loss. Available with totalizers and flow rate indicators.

**PERFLOW-INSTRUMENTS LTD** Unit 3 Chapman Park, High Rd, London, NW10 2DY, UK, Tel: +44-1-451-4577, Telex: 923620, Fax: +44-1-451-6788, Contact: Terry Gluck. Flow measurement equipment mainly of

orifice plate and local indicator type. Remote reading electronic indication and control is an available option. Small variable area flow meters are also supplied. Materials are rigid plastic and stainless steel.

**PLATON FLOW CONTROL LTD** Platon Park, Viabes, Basingstoke, Hampshire, RG22 4PS, UK, Tel: +44-256-470456, Telex: 858107, Fax: +44-256-63345, Contact: Mrs Bainbridge. Platon manufacture an extensive range of variable area flowmeters with transmitting and alarm options, in glass tube and all metal construction for use in the water and general process engineering.

**PLATON FLOWBITS LTD** Platon Park, Viabes, Basingstoke, Hants, RG22 4PS, UK, Tel: +44-256-460122, Telex: 858107, Fax: +44-256-63345, Contact: D N James. Platon Flowbits offer from stock a wide range of flowmeters, flow alarms, flow control valves.

**PLATON INSTRUMENTATION** Platon Park, Viabes, Basingstoke, Hants, RG22 4PS, UK, Tel: +44-256-470456, Telex: 858107, Fax: +44-256-63345, Contact: D N James. Platon Instrumentation incorporates Platon Flow Control and Platon A & I Ltd, manufacturing instruments for flow measurement and control for liquids and gases, together with design and manufacture of precise pressure measuring devices.

**POLYSONICS** 3221 Marquart, Houston, TX, 77027, USA, Tel: +1-713-623-2134, Fax: +1-713-623-6988, Contact: Bill Smith. Manufacturers of ultra sonic, non-contact flow meters for liquid flow measurement.

**HENRY PRATT COMPANY (A DIVISION OF AMSTED INDUSTRIES INC)** 401 S Highland Avenue, Aurora, Illinois, 60507, USA, Tel: +1-312-844-4000, Telex: 720-424, Fax: +1-312-844-4124, Contact: Mr Glenn Beane. Manufacturers of butterfly valves, rectangular butterfly valves and ball valves to American Waterworks Association Standards. Manufactureres of a line of flow meters and actuators.

**PROCESS STYRNING AB** P O Box 410-135-24, Tyresö, Sweden, Telex: +46-8-742-8330, Fax: 46-8-712-0425, Contact: Peter Swanson. Sensors and transmitters for clean and waste water plants, level meters, flow meters, water samplers, pH-meters, conductivity meters and 0<2>-meters.

**QUADRINA LTD** Flint Rd, Letchworth, Herts, SG6 11IS, UK, Tel: +44-462-673486, Telex: 826726, Fax: +44-462-674666, Contact: Stuart Atkins. Manufacturers of flow measurement instrumentation and associated control and display systems. Specialists in the supply of portable flow monitoring equipment for distribution analysis and waste water detection and permanent flow metering installations.

**B RHODES & SON LTD** Danes Rd, Crow Lane, Romford, Essex, RM7 011R, UK, Tel: +44-708-762333, Telex: 896084, Fax: +44-708-45924, Contact: Alan Murray. Manufacture and supply of sight flow indicators, flowmeters and remote indication/ totalising/ alarm/ batch control etc. Flow alarm switches and water meters.

**ROBAN ENGINEERING LTD** 18 Avenue Rd, Belmont,

## METERS - FLOW MEASUREMENT

Surrey, SM2 6JD, UK, Tel: +44-1-643-8070, Telex: 946918, Fax: +44-1-642-1104, Contact: Mr Keith Buckley. Manufacturers and distributors of liquid handling equipment including pumps and flow meters.

**SAAB PROCESS AUTOMATION** P O Box 608, Sjöfalle, 66100, Sweden, Tel: +46-533-15060, Telex: 5347 SPA AB, Fax: +46-533-16931, Contact: Gony Cronquist. Saab Process Automation is a leading Swedish manufacturer of measurement and control equipment for municipal and industrial water and sewage plants. Product range consists of sophisticated supervisory and control systems as well as measurement equipment for pH, redox, oxygen, flow, level, pressure and temperature.

**PHILIPP SCHENK GESELLSCHAFT mbH & CO KG** P O B 3, Jedlester Strasse 59, Wien, A-1212, Austria, Tel: +43-1-385131/385132. Philipp Schenk was founded in 1930 and specializes in the production of industrial and scientific measuring devices. For water management purposes flow meters of various kinds are turned out guaranteeing precise water measurement both in pipelines of up to 2 m diameter and in open rectangular channels.

**SEBA HYDROMETRIE GmbH** Dessestr 5, Kaufbeuren-Nauqablonz, D-8950, West Germany, Tel: +49-8341-62026, Fax: +49-8341-62029, Contact: Wolfgang Zasche. Seba Hydrometrie is a manufacturer of hydrological, meteorological and sewage measuring instruments. The instruments are installed in more than 90 countries worldwide. Range of production: current meters/winchers, water sampling equipment: 2" and 4" mechanical samplers, 2" submersible pump with 12 l/min capacity, water level recorders and control systems, data loggers and transmission systems and all kind of meteorological sensors.

**SIGNET INDUSTRIAL** 3401 Aerojet Avenue, El Monte, CA, 91734, USA, Tel: +1-818-571-2771. Manufacturer of flows and analytical instrumentation specializing in pH, conductivity/resistivity, temperature and pressure applications.

**SPACE AGE ELECTRONICS INDUSTRIAL LTD** Spalding Hall, Victoria Rd, London, NW4 2BE, UK, Tel: +44-1-203-1132, Telex: 8811085, Fax: +44-1-203-4496, Contact: Mr Pepper. Space Age Electronics offer a range of high quality, low cost process control instrumentation covering ultrasonic level and flow equipment, as well as the new, transducer - radio telemetry range of radio data transmission systems. These have the ability to control the duty cycle of remote transducers, depending upon the state of a switch input, or an analogue level.

**SPARLING INSTRUMENTS** 4097 Temple City Boulevard, El Monte, CA, 91731, USA, Tel: +1-818-444-0571, Fax: +1-818-444-2314, Contact: Mr Dellerson. Manufacturer of high accuracy magnetic, ultrasonic and propeller meters measuring flows in full pipes. These devices are corrosion and abrasion resistant and operate in harsh environments.

**STROUD INSTRUMENTS LTD** Locking Hill, Stroud, Gloucestershire, GL5 1QN, UK, Tel: +44-4536-5433,

Telex: 43621, Fax: +44-4536-4256, Contact: Mr G A Davis. Design, manufacture and sale of flow measurement equipment and process instrumentation including GRP flume liners, signal converters, trip amplifiers, isolators, linearisers, integrators, summators, square root extractors, power supplies, etc.

**TEKFLO SENSORS LTD** Albany Rd, Granby Industrial Estate, Weymouth, Dorset, DT4 9TH, UK, Tel: +44-305-772239, Telex: 41394, Fax: +44-305-772238, Contact: Jeff Rivers. Tekflo Sensors Ltd provide flow, level and differential measurement for the water industry. Can offer single items of equipment or complete measurement loops, from the primary sensor to the microprocessor based control system.

**TUBAFOR INTERNATIONAL** 39 Champs Elysees, Paris, 75008, France Tel: +33-142259342, Telex: +280888, Fax: +33-145638408. Current Meters.

**VALEPORT MARINE SCIENTIFIC LTD** Unit 7 Townstal Industrial Estate, Dartmouth, Devon, TQ6 9LX, UK, Tel: +44-8043-4031, Telex: 42669, Fax: +44-8043-4320, Contact: Andrew Talbot. Valeport manufacture and supply the Braystoke range of hydrological instruments and associated accessories for water flow and level measurement.

**WASSERMESSEFABRIK ANDRAE GmbH & CO** P O Box 1127, Neue Ramtelstrasse 48, Leonberg, D-7250, West Germany, Tel: +49-71-52/4-70-31, Telex: +7-24-182. "Picoflux Superjet", "Modulmeter" and "Mam" water meters and pulse meters.

**WESTINGHOUSE OCEANIC DIV** Box 1488, Annapolis, MD, 21404, USA, Tel: +1-301-260-5491, Fax: +1-301-260-5393, Contact: Pete Cernik. Transit-time leading edge flowmeters-LEFMTM. Available systems include single, two and four path for pipes to 40ft in diameter.

### Microbiological Analysis Equipment

**BIOTECH INDUSTRIAL PRODUCTS LTD** 3 Blenheim Road, Sherwell, Plymouth, Devon, PL4 8LJ, UK, Tel: +44-752-262652, Telex: 45795, Fax: +44-752-261664, Contact: Dr Jones. Design and consultancy on water and waste management, supplier of DBC plus B10 Augmentation Media (Flow Laboratories Inc) and Osprey Oil Spill Recovery Media.

**HACH CO** World Headquarters, PO Box 389, Loveland Co 80539, USA Tel: +3036693050, Fax: +3036692932. Water Testing Equipment: HACH COMPANY offers analytical systems for field, laboratory and on-line water testing: laboratory and on-line turbidimeters and chlorine analyzers; preprogrammed spectrophotometers; pH meters and electrodes featuring advanced Hach One™ Technology; microbiological tests; and over 200 test kits ranging from single-parameter kits to complete portable laboratories, including premeasured reagents and step-by-step instructions.

## MICROBIOLOGICAL ANALYSIS

**MILLIPORE CORP** 80 Ashby Rd, Debford, MA, 01730, USA, Tel: +1-617-275-9200, Telex: 4430066, Fax: +1-508-875-2050, Contact: Linda Roettar. Offers several microbiological analysis kits providing a complete array of filters and equipment for field testing procedures.

**MITCO WATER LABORATORIES INC** P O Box 1435, Winter Haven, FL, 33882-1435, USA, Tel: +1-813-967-4456. Chemicals, equipment and service for treatment of commercial and industrial cooling tower, boiler and potable water systems. Ion exchange, reverse osmosis and filtration process water purification equipment. Full service analytical laboratory.

**TECHNICAL PRODUCTS** Box 990, Lake Placid, NY, 12946, USA, Tel: +1-518-523-2355, Contact: Ebb Kane. EASICULT microbial "do it yourself" test, monitors microbial infections in process water. Microbes contributing to chemical changes, acidic conditions and slime are detected.

### Transducers

**ASHDOWN PROCESS CONTROL LTD** Huntsfield, North Close, Shorncliffe Industrial Estate, Folkestone, Kent, CT20 3UH, UK, Tel: +44-303-40691, Telex: 966355 Ashpc G, Fax: +44-303-40703, Contact: Mrs Higgins. Manufacturers of pressure and differential pressure transmitters and transducers for measurement applications including, flow and level of liquids and slurries, together with the recent addition of a technological advanced insertion flow-meter.

**BAILEY & MACKEY LTD** Baltimore Rd, Birmingham, UK, Tel: +44-21-357-5351, Fax: +44-21-357-8319, Contact: Ms Bach. Bailey and Mackey are involved in the development and manufacture of all types of pressure transducers and gauges from 0-20" of water up to 6000 psi. Also produced are: special materials for wetted parts on dosing equipment.

**BUSH BEACH ENGINEERING LTD** Stanley Green Trading Estate, Earl Rd, Cheadle Hulme, Cheshire, SK9 3RL, UK, Tel: +44-61-485-8151, Telex: 667-548, Fax: +44-61-488-4048, Contact: Mr John Moss. Flow measuring products including orifice plate and Venturi sensors, complete metering runs and flow transmitters and totalisers, temperature sensors, transmitters and indicators for monitoring pumps and machinery.

**DELTA CONTROLS LTD** Island Farm Avenue, East Molesey, Surrey, KT8 0UZ, UK, Tel: +44-1-941-5166, Telex: 27109, Fax: +44-1-783-1163, Contact: Richard Wigmore. Manufacturers of standard and custom built pressure, pressure difference, temperature, flow, vacuum and level switches, liquid level transmitters and fibre-optic based sensors for use in all areas. Instrument needle valves and manifolds and pressure transducers.

**DRUCK LTD** Fir Tree Lane Groby, Leicester, LE6 0FH, UK, Tel: +44-533-878551, Telex: 341743 DRUCK G, Fax: +44-533-875022, Contact: Susan Mould. Suppliers of precision depth and level measurement systems. Druck

Ltd also supply transducers, transmitters and related digital indicators.

**DRUCK NEDERLAND BV** PO Box 232, Barendrecht, AE, 2990, The Netherlands, Tel: +31-1806-11555, Telex: 28164, Fax: +31-1806-18131, Contact: John Oosthon. Specialists in level and measuring devices including calibration and pressure measuring equipment.

**DYNAMIC LOGIC LTD** The Western Centre, Western Rd, Bracknell, Berks, RG12 1RW, UK, Tel: +44-344-51915, Telex: 849433, Fax: +44-344-52253, Contact: Mr Barbour. Dynamic Logic offer the complete package solution to all telemetry and instrumentation problems in the water industry. From a single level transducer to a complete regional telemetry scheme, using PSTN radio or private wire.

**INSTRUMENTAL NORTHWEST INC** 14972 NE 31St Circle, Redmond, WA, 98052, USA, Tel: +1-206-885-3729, Fax: +1-206-885-0404, Contact: Robert W Landick. Instrumentation Northwest Inc, produces a complete line of submersible pressure transducers for use in harsh environments. Transducers are constructed from 300 series stainless steel. All components are warranted for a period of one year.

**INTERFACE INC** 7401 E Butherus Drive, Scottsdale, Arizona, 85260, USA, Tel: +1-602-948-5555, Fax: +1-602-948-1924, Contact: David A Riggs. Interface is one of the world's leading manufacturers of strain gauge load cells, which are transducers used in force measurement. In business for more than 20 years, exporting all over the world. Load cells range in capacity from 0 - 3 lbs to 0 - 200,000 lbs.

**MASSA PRODUCTS CORPORATION** 280 Lincoln St, Hingham, MA, 02043, USA, Tel: +1-617-749-4800, Contact: Fred Straut. Massa Products Corporation is a medium sized manufacturer of ultrasonic air transducers, ranging modules, ultrasonic proximity systems used in a variety of industrial, medical and consumer applications.

**SPACE AGE ELECTRONICS INDUSTRIAL LTD** Spalding Hall, Victoria Rd, London, NW4 2BE, UK, Tel: +44-1-203-1132, Telex: 8811085, Fax: +44-1-203-4496, Contact: Mr Pepper. Space Age Electronics offer a range of high quality, low cost process control instrumentation covering ultrasonic level and flow equipment, as well as the new, transducer - radio telemetry range of radio data transmission systems. These have the ability to control the duty cycle of remote transducers, depending upon the state of a switch input, or an analogue level.

**THOR INTERNATIONAL INC** 13751 Lake City Way NE, 201, Seattle, WA, 98125, USA, Tel: +1-206-361-8467, Fax: +1-206-367-1721, Contact: Peter Thordauson. Ground water monitoring instruments for level/flow/temperature, electronic transducers, data loggers, multiplexers, pocket computer and hand held read out. Data loggers have a memory of 32,000 readouts. We also manufacture pH temperature, pressure meters.

**TRANSINSTRUMENTS** Lennox Rd, Basingstoke,

## TRANSDUCERS

Hampshire, RG22 4AW, UK, Tel: +44-256-20244, Telex: 858103, Fax: +44-256-473680, Contact: Sue Taylor. Trans-Instruments manufacture an extensive range of water-proof pressure transducers and transmitters for fluid pressure, level and depth measurement. Designed for easy care, low cost ownership and virtually maintenance-free operation.

**WELWYN STRAIN MEASUREMENT** Armstrong Rd, Basingstoke, Hampshire, RG24 0QA, UK, Tel: +44-256-462131, Telex: 858520, Fax: +44-256-471441, Contact: Mr Window. Specialists in the installation of strain gauges, the company runs regular training courses in strain gauge installation.

### Sampling Equipment

**AMERICAN SIGMA INC** One Elizabeth St, Middleport, NY, 14105, USA, Tel: +1-716-735-3616, Fax: +1-716-735-3711, Contact: William G Hungerford. American Sigma is a manufacturer of automatic liquid samplers and open channel (non-pressurized) flowmeters for a wide variety of regulatory and process control water quality applications. Included are portable battery operated samplers as well as stationary refrigerated units. All Sigma models combine sample integrity with rugged practicality.

**AQUEST INC** P O Box 190, 1980 Route 30, Sugar Grove, IL, 60554, USA, Fax: +1-312-466-7700. Manufacturer of a full line of pure water faucets including Smart® faucets to indicate service required for filter and RO modules. Also has a line of TDS test kits.

**AUTOMATIC LIQUIDS SAMPLERS** Unit 1d, Trumpers Way Industrial Estate Hanwell, London, W7 2QA, UK, Tel: +44-1-571-2388, Telex: 858893 Sletel G, Contact: Mr Measures. Manufacturers and suppliers of liquid sampling equipment to all parts of the world. Both mechanically and electronically operated. Catalogues and prices immediately available by post.

**AZLON PRODUCTS LTD** Towerscroft Rd, Sidcup, Kent, DA14 5EF, UK, Tel: +44-1-300-8886, Telex: 8951810, Fax: +44-1-300-2247, Contact: Mr Thomas. Manufacturers of water sampling equipment for pollution detection and control.

**THE BEN MEADOW COMPANY INC** PO Box 80549, Atlanta, GA, 30366, USA, Tel: +1-404-455-0907, Fax: +1-404-457-1841, Contact: John E Amos. The Ben Meadows Company warehouses and distributes over 8,000 items from 500 different manufacturers. These products are designed to improve the productivity of the professional or worker out in the field. We offer water analysis equipment, sampling and measuring devices, water pollution detection and on-sight sewage lab kits, among many other instruments and equipment your people can use in the field.

**BRILSFORD AND CO INC** 670 Milton Rd, Rye, NY, 10580, USA, Tel: +1-914-967-1820, Fax: +1-914-967-1836, Contact: Robert Drummond. We manufacture portable automatic water sampling instruments, battery or A/C

operated, featuring long battery life good reliability and modest prices.

**CRA Rue Charles Demeer**, 1020 Brussels, 105-117, Belgium, Tel: +32-2-428-7149, Fax: +32-2-425-8813. Waste water flow measurement and sampling equipment technology for industry and waste water plants.

**CRANE PRO-TECH ENVIRONMENTAL INSTRUMENTS** 800 Third Avenue, King of Prussia, PA, 19406, USA, Tel: +1-215-265-7212, Fax: +1-215-265-5432, Contact: E W J Diaper. Samplers are used for collecting samples of wastewater effluent for storage and analysis, flow monitors for measuring flow in open channels such as sewers and drains, distance and level meters are ultrasonic and electro-mechanical, used for measuring liquids and granular materials stored in tanks and bins.

**DUNCAN & ASSOCIATES** Beech Court, Cart Lane, Grange-Over-Sands, Cumbria, LA11 7AS, UK, Tel: +44-4484-3857, Fax: +44-4484-4963, Contact: Linda Holhead. Manufacturers and suppliers of limnological and hydro-biological sampling apparatus.

**EPIC PRODUCTS LTD** Broadway Industrial Area, Salford, M5 2UQ, UK, Tel: +44-61-872-1487, Telex: 665781 Mantel G, Fax: +44-61-848-7324, Contact: Mr Smith. Manufacturers of a complete range of automatic liquid samplers for use with raw sludge, crude sewage, etc and instruments to measure level and open channel flow.

**FLUOROWARE INC** 102 Jonathan Boulevard North, Chaska, Minnesota, 55318, USA, Tel: +1-612-448-6717, Telex: 290010, Fax: +1-612-488-5576, Contact: Cindy Schmiege. Manufacturers of fluid handling products.

**FULTZ PUMPS INC** P O Box 550, Lewistown, PA, 17044, USA, Tel: +1-717-248-2300, Contact: Mona Macknair. Manufacture a ground water sampling pump for 2in diameter wells.

**GCA-PRECISION SCIENTIFIC** 3737 W Cortland St, Chicago, IL, 60647, USA, Tel: +1-312-227-2660, Telex: 4330120, Fax: +1-312-227-8228, Contact: Mr Rousso. Low temperature incubator, primary usage BOD test (five days 20 degrees Centigrade). The sewerage sampler is used to collect water samples at considerable depth. The sampler holds a 250ml or 300ml BOD sample bottle.

**GLOBAL RESOURCE PLANNING** 928 Humphries Avenue, PO Box 149127, Orlando, FL 32814, USA. Complete, turn-key, chemical/environmental laboratory and training of laboratory personnel to use the equipment. Can supply sampling equipment and training for its use, or we can supply the personnel and equipment to do sampling and field testing.

**I-CHEM RESEARCH** 23787-F Eichler St, Hayward, CA, 94545, USA, Tel: +1-415-782-3905. Supplies a complete line of chemically pre-cleaned sample bottles, jars and vials, cleaned and quality control analyzed to exact EPA specifications. (WT)

**MARINE ELECTRICS LTD** Conlin Rd, Killybegs, Co

## SAMPLING EQUIPMENT

Donegal, Rep of Ireland, Tel: +353-733-1054, Telex: 40545, Fax: +353-733-1215, Contact: Mr Sharkey. Water quality monitoring for treatment plants.

**NEOTRONICS LTD** Parsonage Rd, Takeley, Bishops Stortford, Herts, CM22 6PU, UK, Tel: +44-279-870182, Telex: 817126, Fax: +44-279-870377, Contact: Caren Frost. For confined space entry continuous monitoring of asphyxiants, toxic and flammable gases. Neotronics compact EXOTOX multi-gas and NEOTOX pocket-size personal monitors offer protection against the hazardous environments encountered in the water industry.

**NORTON-PERFORMANCE PLASTICS** 150 Derby Rd, Wayne, NJ, 07470, USA, Tel: +1-201-696-4700, Fax: +1-201-696-4501, Contact: Dave Brownstein. Manufacturers of cast nylon sewage sprockets for waste water treatment facilities and a complete range of products for the monitoring and sampling of ground water.

**PROCESS STYRNING AB** P O Box 410-135-24, Tyresö, Sweden, Tel: +46-8-712-0425, Fax: +46-8-742-8330, Contact: Peter Swanson. Sensors and transmitters for clean and waste water plants, level meters, flow meters, water samplers, pH-meters, conductivity meters and 0<2>-meters.

**QUALITY ENVIRONMENT LTD** 27 St George's Rd,

Cheltenham, Glos, GL50 3DT, UK, Tel: +44-242-33220, Telex: 4327188, Fax: +44-242-222779, Contact: Roy Jenkins. QEL design and produce a wide range of automatic samplers and systems, from simple automatic samplers without any power source to highly sophisticated systems for sampling low radioactivity nuclear waste water.

**ROCK AND TAYLOR LTD** 32 Waterfall Lane, Cradley Heath, Warley, W Midlands, B64 6RQ, UK, Tel: +44-21-539-3627/8, Contact: Mr Taylor. Designers and manufacturers of automatic liquid sampling equipment.

**TUBAFOR INTERNATIONAL** 39 Champs Elysees, Paris, 75008, France Tel: +33-142259342, Telex: +280888, Fax: +33-145638408. Borehole Water Samplers.

**YSI INCORPORATED** YSI Scientific, Lysons Avenue, Ash Vale, Aldershot, Hampshire, GU12 5QR, UK, Tel: +44-252-513006, Fax: +44-252-511855, Contact: Lynda Hart. YSI dissolved oxygen and conductivity meters, monitor wastewater treatment, and provide environmental control and enforcement. Other YSI systems help maintain pure water supplies by monitoring temperature, conductivity, pH and ORP in surface water and groundwater as it is pumped from test wells. YSI instruments also assure healthy crops of fish and shellfish in hatcheries and on farms.

DEVELOPING WORLD  
**WATER**

**E**ntries ending in WT are taken from Water Technology Magazine's Planning and Purchasing Handbook. The subscription address is: Water Technology Magazine, 13 Century Hill Dr, Latham, NY 12110, USA. Telephone (518) 783-1281. Entries ending in IAWPRC are reproduced from the 1987-88 Yearbook of the International Association on Water Pollution Research & Control (IAWPRC) with the Association's consent. IAWPRC, 1 Queen Anne's Gate, London SW1H 9BT, England.

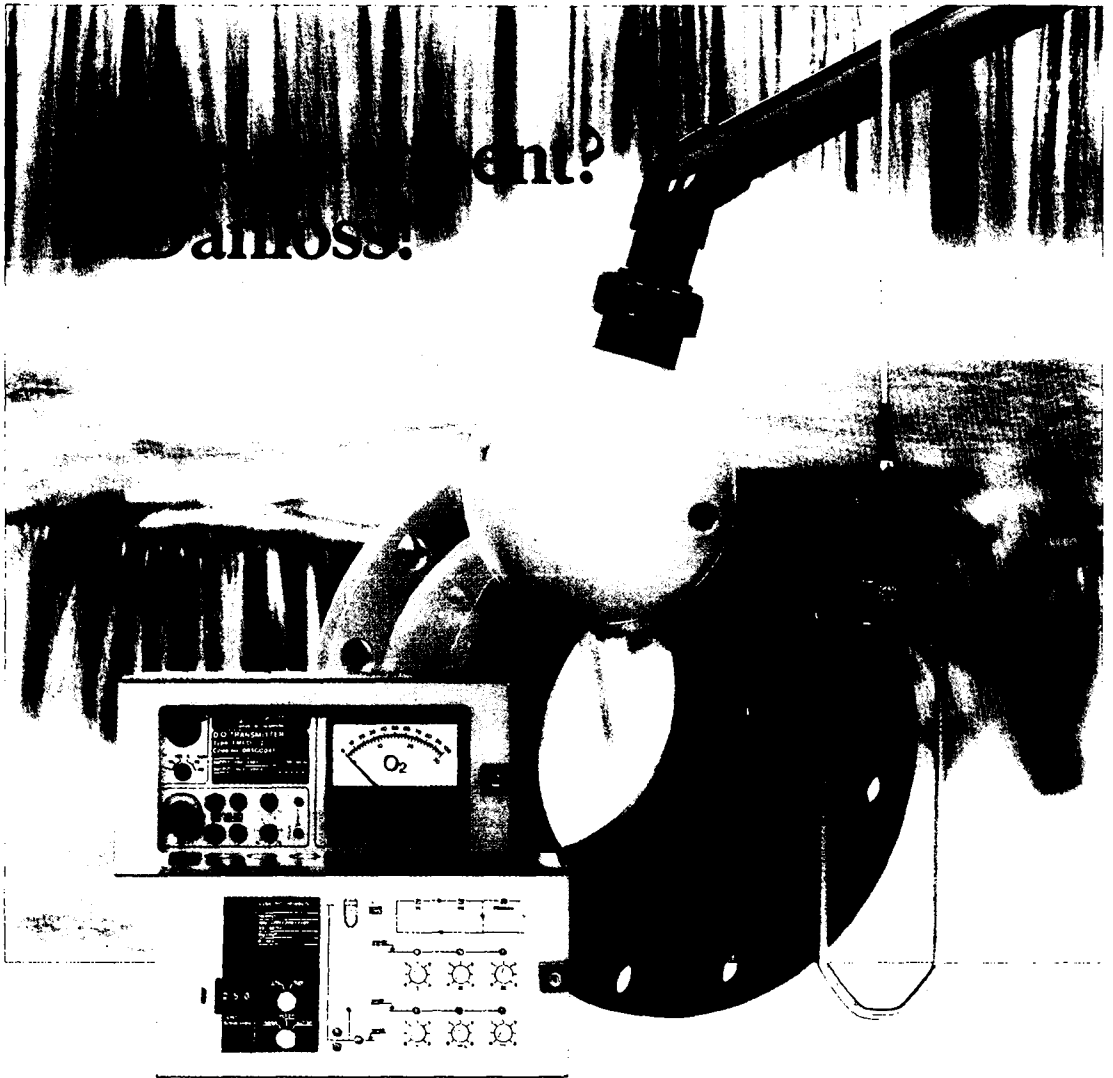

Process optimisation in waterworks for ground water and surface water, in sewerage systems and in purification plant, through the use of the latest technology in the measurement of

# flow, level, and oxygen

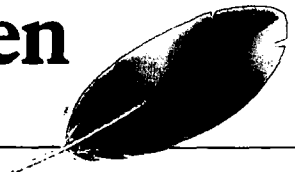

**Danfoss A/S**

DK-6430 Nordborg  
Denmark

Telephone: +45 4 88 22 22

Telefax: 45 4 49 09 49

Telex: 50 599 danfss dk

UNIQUE IN ENGINEERING AND PERFORMANCE



Hydropower

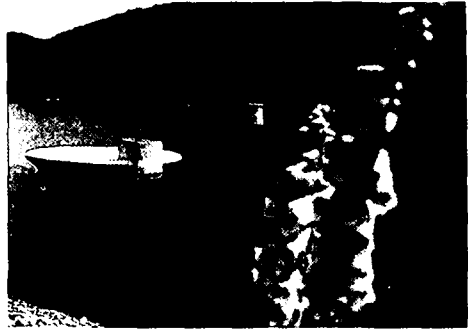

Multipurpose Water Use



Irrigation Design

## Worldwide Partner in Developing Water

- Consulting Services for
- Water Resources Utilization
  - Environmental Engineering
  - Rural Development



Water Treatment and Transport

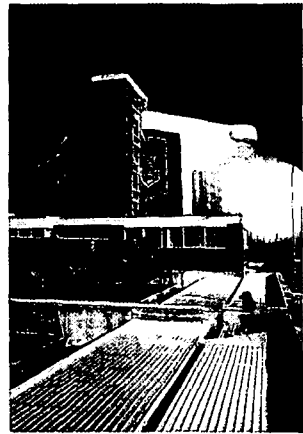

Sewage Treatment



Agricultural Development

 **LAHMEYER  
INTERNATIONAL**

Lahmeyer International GmbH  
PO B 710 651 · D-6000 Frankfurt/M 71  
Tel. (69) 6677-251 · Tx. 413 478 li d · Fax (69) 6677-715

Consulting Engineers for Energy · Water · Environment · Transport





• **Consultants &**  
**Contractors •**

CONSULTANTS & CONTRACTORS

---

# THE ROLE OF EUROPEAN CONTRACTORS IN THE THIRD WORLD

by

Rolf Bollinger  
and  
Ulrich Paetzold

Among the EIC member companies, some have a history of more than 100 years of involvement with the development of water resources and sanitation throughout the world.

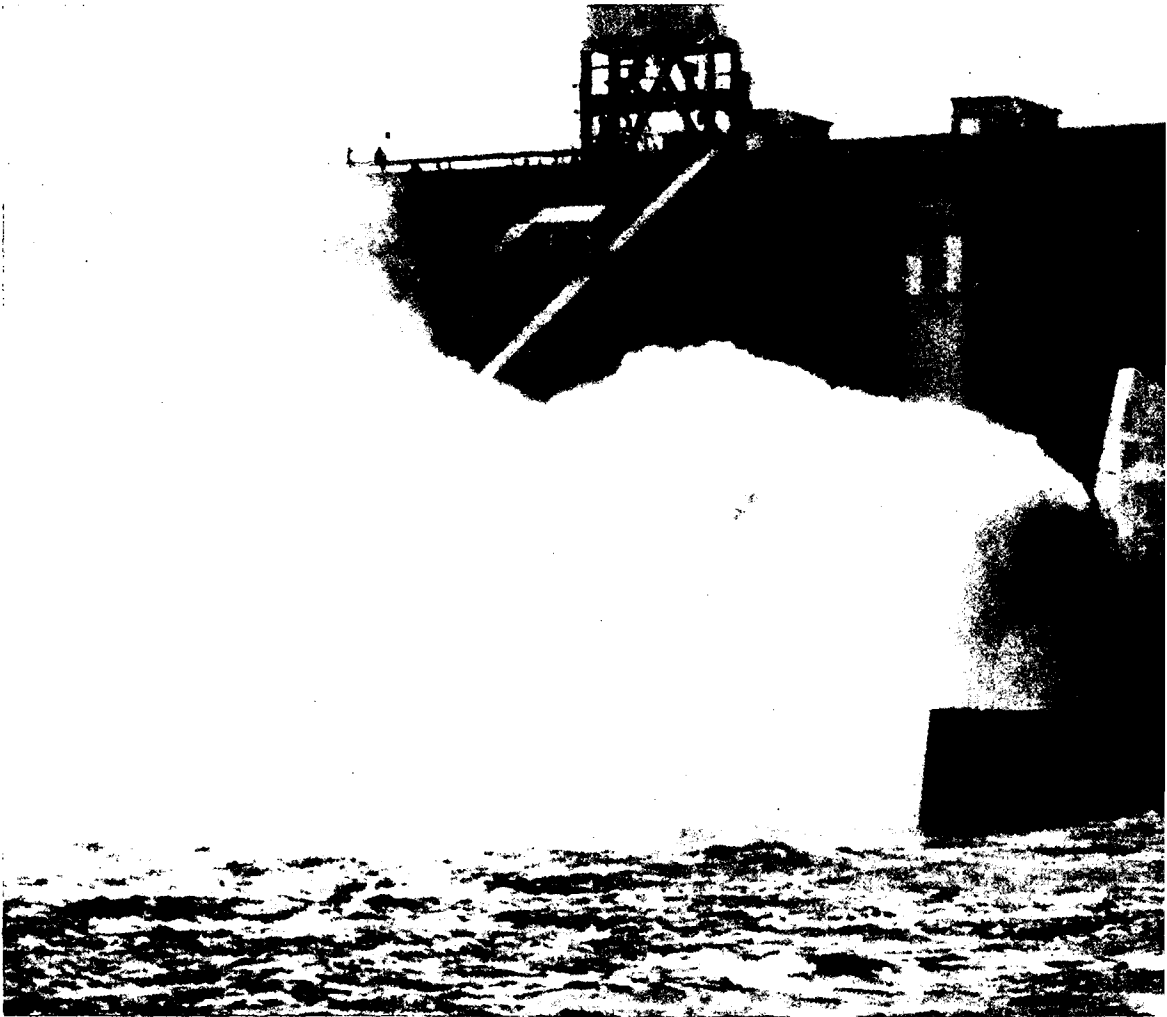

## CONSULTANTS & CONTRACTORS

European International Contractors (EIC), through their national Member Federations from thirteen European countries, represent construction companies engaged in international markets outside the European Community. EIC are associated with FIEC (Fédération Internationale Européenne de la Construction) who deal with the Construction Industry's European activities.

This depth of experience in many countries with widely varying conditions and the expertise developed within their European base have benefitted many countries in solving water and energy supply problems and in providing efficient waste water treatment and environmental control.

Sufficient energy supplies, safe water supplies and efficient sanitation are absolutely essential for a reasonable development of industry, commerce, agriculture and community health care worldwide. Availability of water and treatment of used water are among the prob-

lems of major concern in the future. European Contractors engaged in the water industry have a wealth of experience and are prepared to continue to play their part to the full.

### Pollution Control

Because of Europe's high population density, particularly in the urban industrial areas, a good deal of attention has been focussed on the regulation and control of all sorts of wastewaters. On one hand there are the industrial wastewaters carrying a wide range of dangerous substances or being warmed up by cooling processes. On the other hand there are increasing quantities of wastewaters resulting from changes in the sanitary habits of the population following the Second World War.

Tackling these problems has given the European Contractors (consultants, equipment manufacturers and research laboratories, of course) considerable experience enabling them to build up comprehensive expertise which is equally relevant for application overseas.

### Process Developments

As contractors in the construction industry, the European process contractors and equipment manufacturers have a long history of working overseas. New processes have been developed and well established processes and equipment have been improved to achieve greater throughput or quality from a given site area. The increasing use of agrochemicals and harmful substances in industry stimulates contractors and research institutes continually to develop new and improved techniques. Dissolved air flotation is now used routinely in appropriate circumstances. Scientific and technical work has improved the understanding of granular media filtration. Greater bacteriological densities are now possible in sewage treatment and anaerobic digestion plants.

### Overseas Projects

The European Construction Industry has sought and developed overseas expertise in water development through the implementation of major new energy supply, water supply and public health schemes. New facilities have been created, existing facilities have been maintained and improved and the growing threat of industrial pollution has been tackled.

Some impressive examples of European Contractors' expertise are summarized and illustrated by the following projects:

- 1) **The Karkh Water Supply Scheme** supplies 1,370 million litres of treated water per day in the city of Baghdad, Iraq. The scheme comprises a river intake works and pumping station on the Tigris, a water treatment works one kilometre from the intake incorporating treated water storage tanks and a high lift pumping station. Also included are 40 km of pipelines to a new reservoir and command centre in the north of Baghdad, further new reservoirs and a comprehensive plant monitoring and telemetry system linking seven sites with Baghdad Water Supply Administration's headquarters in the city.

- 2) Part of the expansion and quality improvement programme for the **water supplies to the City of Riyadh, Saudi Arabia**, was the turnkey construction of a

*Nangbéto, Togo hydro electric plant Source: HOCHTILF AG, Germany*



*Tao Paoh, Singapore one of the largest sewage treatment works in South East Asia. Source: British Water Industries Group, United Kingdom*

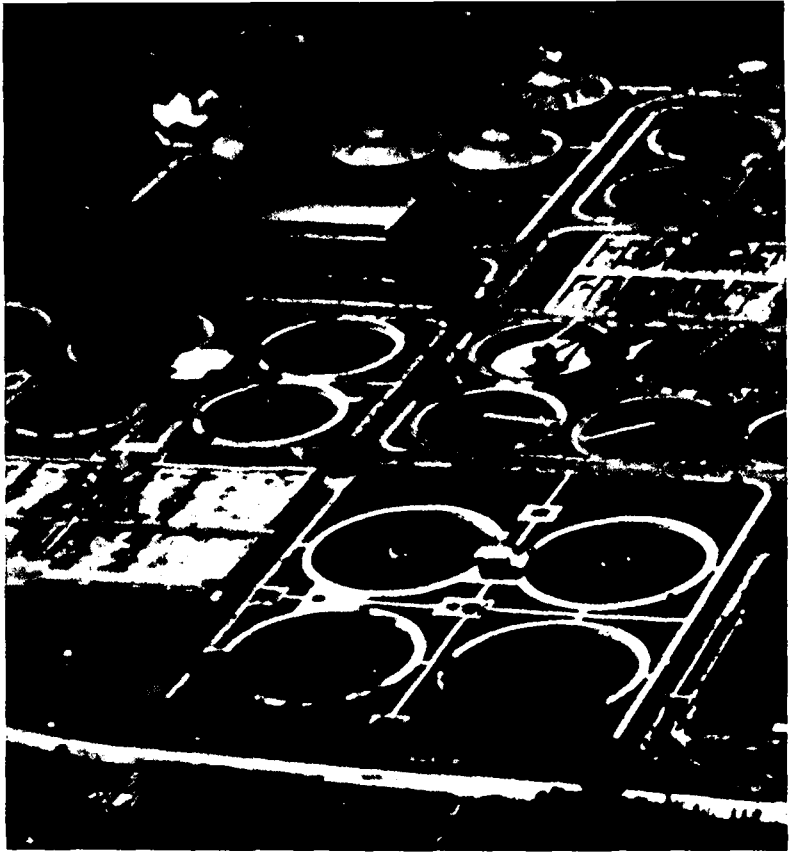

59,000 m<sup>3</sup>/day water treatment facility, a 20 MW diesel power generating station, a 5,000 m<sup>3</sup> on-site reservoir and a 22,000 m<sup>3</sup> high zone reservoir. The contract also included responsibility of technical management, supervision and supply of spare parts and certain consumables for a five year operating period.

A significant component of this project is the desalination stage required to reduce the salinity of the water to a total dissolved solids content of less than 500 mg/l in accordance with World Health Organisation standards. Reverse Osmosis was selected for this critical stage for a number of reasons:

- it gave an economical solution from both capital and running cost viewpoints;
- it allowed a high water recovery rate;
- modular in construction, it could be extended easily;
- reasonable variations in feed water salinity were unlikely to cause major problems;
- it had a proven track record in the large installations.

3) In Tunisia, the **Lac Nord, near the capital, Tunis**, was equipped with a water circulation system not using pumps, but the natural tide. Opening the inlet sluices at the northern half of the lake during the incoming flood tide allows entry of fresh seawater and opening the outlet sluices at the southern half of the lake during ebb tide leads to a discharge of more or less used water. This natural circulatory current will enable the water in the lake to be completely changed once every two to three weeks.

During the dredging operations, which lasted for three years, some special vessels for the collection of algae and for fragmenting the cap rock were developed. By early 1988, President Bourguiba's promise to create a clean lake was fully realised. In addition, the site has been prepared for future recreational areas along the shores of the lake.

4) The first project studies for the **hydro-electric plant at Nangbéto in Togo** took place as long ago as 1947 and geological investigation drilling began in 1964. After

33 months of construction work, the plant was inaugurated on 5th May, 1988.

During construction, which required the temporary diversion of the river Mono, all installations withstood a major flood in September, 1985 when there was a 1,500 m<sup>3</sup>/second outflow.

The plant is a multi-purpose project:

- the 65 MW hydro plant provides one third of the electricity needs of Togo and Bénin;
- the dam and the lake enable protection against flood, the irrigation of 43,000 hectares (106,000 acres) of agricultural fields and the building-up of a fish industry.

This example also demonstrates that, in most cases, major water development projects have a bearing on several vital points in the development of a country, giving the chance of considerably improving both a country's economy and the people's well-being.

It would not be difficult to give many more examples of contractors' outstanding performances helping to develop and exploit water resources in various applications. Each project has its special merits, new techniques or mastering of completely unforeseeable problems. Therefore, it must be pointed out that the choice of the above examples is somewhat arbitrary and does not, in any example, represent a quality judgment on any water development project.

To conclude with a statement already made:

European contractors engaged in the water industry have a wealth of experience and are prepared to continue to play their part to the full.

# THE CHANGING NATURE OF CONSULTANCY WORK

by

Alistair Wray

International consultants have played a very significant role in developing water resources and supplying water for various uses throughout the world.



*The upgrading of services and their operations require carefully targeted assistance.*

Naturally enough, projects for the provision of potable water concentrated initially on the large, well-established urban areas and conventional engineering solutions were applied. The most convenient water sources were tapped, the commercial and established residential sectors of society served and, with increasing water usage, waste-water collection and treatment systems introduced to serve these same sectors. Early irrigation schemes likewise concentrated on serving or developing large, established agricultural areas.

Engineering teams from consultants' head offices undertook the necessary technical work or, where there was sufficient work, local offices were set up to undertake projects. Finished products in the form of reports, contract documents or completed works were delivered to the client, while responsibility for the technical work rested very clearly with the consulting firm.

## **Changing Nature of Work**

The nature of projects has changed over time. In urban

areas, attention has focussed on a sector that had not hitherto been adequately served: the rapidly growing low-income areas and water supply and sanitation solutions that are sound, socially acceptable and affordable have been sought. Investigations into establishing basic levels of service have placed particular emphasis on health, social and economic aspects. Pressure on costs and the importance of operations and maintenance have led to increased community involvement in projects and to an integrated approach to service improvements to ensure all elements are complementary.

Similar concept changes have taken place in rural water supply and sanitation projects and, in many cases, an integrated approach to the development of a rural area has been adopted, considering also transport, irrigation and agricultural improvements.

Major, sophisticated projects are still necessary, particularly in water resources development and treatment, but in recent years there has been a growing

## CONSULTANTS & CONTRACTORS

emphasis on integrated development and small, replicable, community-based schemes. This has required a broader based approach to project development and changes to the composition of the typical project team.

### The Consultant's Team

These project changes have necessitated a wider range of skills to be incorporated into many project teams. Identification of appropriate technologies requires the assistance of social and health workers and, in some cases, anthropologists, in addition to engineers, planners and economists. Integrated development projects require a tailor-made team which may include numerous different engineering and agricultural specialists, for example.

The need to draw on a wide range of different disciplines to form an appropriate project team has led to firms forming joint ventures with other consulting firms, or utilising suitably experienced individuals. Given the time pressures and frequently difficult conditions under which a project team is working, established working arrangements with known firms or individuals must be more satisfactory than ad hoc one-off associations.

Another significant change is the increased use of local consultants, both separately and as a local counterpart to an international firm. This reflects the growing technical skills to be found in many developing countries. Local associations provide valuable local knowledge, a basis for transferring skills and for reducing manpower costs. It is on this basis that local counterpart firms are often insisted upon by the client and the lending agencies. This arrangement works well if local staff are able and committed and again established local associations will assist here while temporary links, often for political expediency, can produce local staff with a lack of project commitment and, in the long run, increased work for the international consultant's team.

The use of local consultants and increasingly complex joint venture arrangements also raises the problem of responsibility for work undertaken. This is further compounded as most project work is now undertaken

in-country. In many respects it is better to anticipate potential problems by defining the division of both technical and financial responsibility as closely as possible at the outset.

### Technical Assistance

These changes, embodying modified approaches to project development rather than new, high technologies, the use of replicable, rolling programmes and the need to transfer skills to key local staff, have led to an increase in work of an advisory nature. Consultants are increasingly asked to second individuals to client agencies to assist local technical teams in project preparation and implementation. These attachments can often be of several years' duration and are very useful in building up local capabilities and developing suitable operations and maintenance systems.

However, this type of assistance is demanding for both the individuals and consulting firms alike. They require individuals with considerable experience, a broad technical background and self-reliance. This means senior staff who are both mobile and flexible, with attendant problems for the consulting firm of finding and keeping such staff, and of training junior staff for similar roles in the future. In this context, it is interesting to note the closing gap between consultancy work and training, with the application of on-the-job training and informal and formal workshops to suit requirements.

### Future Developments

In many respects, international consultancy is a shrinking market. However, firms have responded effectively to changing requirements and, in many cases, have been instrumental in initiating changes in technique and approach. Due to the unique and varied nature of projects, the assistance of consultants, be it in conventional engineering or through composite team-work or via advisory inputs, will continue to be required throughout the world. Developments such as the rapid expansion of urban areas, the staged upgrading of services, the need to build up operations and maintenance capabilities and the growing problems of infrastructure renewal will continue to tax consultants for years to come. •

*Close consultation to determine project requirements.*



## GENERAL CIVIL ENGINEERING CONTRACTORS

### General Civil Engineering Contractors

**BALFOUR BEATTY CONSTRUCTION INTERNATIONAL LTD** Randolph House, Wellesley Rd, Croydon, Surrey, CR9 3QD, UK, Tel: +44-1-686-0555, Telex: 946191, Fax: +44-1-681-2827/688-0878, Contact: Joy Bignall. Balfour Beatty Group with its seven operating companies is engaged in more than 50 countries worldwide. Its extensive range of activities includes the design and construction of water treatment plants.

**BARTHOLEMEW** Rickmansworth, Hertfordshire, WD3 2SJ, UK, +44-923-772674, Tel: +44-923-772674, Fax: 919636, Contact: Mr Worsfold. Civil engineers and construction builders operating specifically in the water industry.

**BIWATER INTERNATIONAL LTD** Biwater House, Station Approach, Dorking, Surrey, RH4 1TZ, UK, Tel: +44-306-740740, Telex: 859529, Fax: +44-306-885233, Contact: Mr John Ball. International civil engineering contractor (reservoir and dam construction, water and sewage projects).

**BLACK & VEATCH INTERNATIONAL** PO Box 8405, 1500 Meadow Lake Parkway, Kansas City, Missouri, 6411, USA, Tel: +1-913-339-8700, Telex: 42523, Fax: +1-913-339-2060. One of the oldest, largest and most diversified engineering-architectural organizations in the USA with experience throughout the world. Extensive management experience and diversified capabilities enable the company to assume total responsibility for a wide range of projects of any size the world over.

**BOHR-UND ROHRTECHNIK GESELLSCHAFT mbH** A-1010 Wien, Gonzagagasse 1, Austria, Tel: +43-222/63-37-95, Telex: +11-4122. Bohr-und Rohrtechnik Gesellschaft mbH have specialised for years in the production of industrial plants, refineries and water pipe systems and undertake complete plant projects including engineering, delivery of products and full installation.

**CAMECO** P O Box 2077, IJelystad, 8203 AB, The Netherlands, Tel: +31-3200-32255, Telex: 47141, Fax: +31-3200-31995, Contact: Mr Sollie. Land reclamation and levelling, laser controlled, dam building and irrigation.

**CONDRIILL AB** Sveavagen 83, Stockholm 113 50, Sweden Tel: +46-8-349560, Telex: +12336, Fax: +46-8-316762.

**JOHN CONNELL GROUP** 60 Albert Rd, South Melbourne, Victoria, Australia, Tel: +61-3-697-8333, Telex: 32071, Fax: +61-3-697-8444. Civil and structural engineering for transport, environment and industry design, planning, earth sciences and implementation in land and water feasibility studies, drainage, wastewater, water supply and distribution.

**CROSS MARINE SERVICES LTD** 565 West 2000 South, Orem, Utah, 84058, USA, Tel: +1-801-225-8355,

Fax: +1-801-226-4108, Contact: Mr Charles Carlin. Equipment erection, turbines and generators. Manufacturers of gates and valves, seals and gaskets. Complete range of services in construction engineering (including underwater).

**DEW GROUP LTD** Po Box 35, Oldham, OL9 6HH, UK, Tel: +44-61-624-5631, Telex: 667473, Fax: +44-61-678-0289, Contact: Mr Kennedy. Civil engineering and building contractors. Sheet piling and landscape contractors.

**GENERALPLAN GESELLSCHAFT BERATENDER UND KOORDINIERENDER INGENIEURE mbH** A-8010 Graz, Austria, Tel: +43-316/792-22, Telex: 32171 gpa. Generalplan GesmbH employ civil engineers, engineers, master builders and technicians qualified in various special disciplines. Of the many projects handled (civil engineering and building, industrial plant and road, rail and bridge construction etc. ) water supply and disposal plants deserve special mention. The company undertakes the planning of complete large-scale projects, including supervision of execution.

**HOCHTIEF** Rellinghauser Strasse 53-57, Essen 1, D-4300, W Germany, Tel: +49-201-8240, Telex: 857778, Fax: 49-201-824-2777, Contact: Mr Martini. Building and civil engineering contractors.

**HYDRO ENGINEERING SDN BHD** 15A Jalan Bachang Batu 2 1/4 off Jalan Ipoh, Kuala Lumpur, 51200, Malaysia, Tel: +60-3-29878142920935, Fax: +60-2432223, Contact: James FC Chong. Established in 1981, Hydro is involved in general civil engineering contracting with local authorities, public work departments and other government agencies in Malaysia.

**KISO-JIBAN CONSULTANTS CO LTD** Mimura Building, Kanda, Jimbo-Cho 1/34, Chiyoda-Ku, Tokyo, Japan, Tel: +81-3294-7261, Fax: +81-3-292-8010. Comprehensive capabilities in the field of geotechnical engineering - subsurface investigation, soil and rock mechanics and groundwater management. International experience in the water fields of agriculture and public utilities.

**LAVALIN INTERNATIONAL INC** 1110 Dorchester Boulevard West, Montreal, Quebec, Canada, Tel: +1-514-876-4455, Telex: 055-61205. Complete engineering and consulting services in many fields of specialization including fisheries, dams, drainage, pipelines, river regulation and control, water supply and distribution, wastewater and desalination.

**JOHN MOWLEM AND COMPANY PLC** Westgate House, Ealing Rd, Brentford, Middlesex, TW8 0QZ, UK, Tel: +44-1-568-9111, Telex: 24414, Fax: +44-1-847-4802, Contact: Jane Sandy. International construction and engineering group. Specialists in tunnelling for sewers and hydro schemes throughout the world. Some of the Mowlem Group subsidiaries are leaders in the field of soil mechanics, laboratory equipment, tankage, pipework and piling.

**NIHON SUIDO CONSULTANTS CO LTD** 2-6 Okubo 2-Chome, Shinjuku-Ku, Tokyo, 160, Japan, Tel: +81-3-

## GENERAL CIVIL ENGINEERING CONTRACTORS

202-0101, Telex: 28670, Fax: +81-3-202-9686. Independent engineering firm specializing in water supply, sewerage, drainage and sanitation. Particular emphasis has recently been placed on system engineering and water quality engineering services aided by computer facilities and central laboratory. Wide international experience.

**PRESS CONSTRUCTION LTD** PO Box 35, Swindon, Wilts, SN1 3AU, UK, Tel: +44-793-28221, Telex: 444419, Fax: +44-793-614929, Contact: Mr Burnett. Civil engineering contractors with total capability to manage and operate systems from water supply through to sewage treatment. Also specialists in distribution works, pipeline cleaning services and pipe replacement systems.

**PURAC AB** P O Box 1146F9Lund, S-22105, Sweden, +46-46-135100, Tel: +46-46-14-69-88, Contact: Mr Eric Sanders. The Purac organization offers all the specialized skills in process, mechanical, electrical and structural engineering, coupled with total project management and assured plant performance.

**QPS PLASTICS** New York Industrial Estate, Summerbridge, Harrogate, North Yorkshire, HG3 4LA. UK. Tel: +44-423-780389, Fax: +44-423-781516. QPS Plastics are suppliers of the "Q-CAP"™ range of sewage distributor-arm end caps. Cast in En-thane™ polyurethane, "Q-Caps" offer many advantages over conventional metal end caps and bungs, including speed of "flushing" and/or "rodding out", no corrosion, less weight, greater resilience, reduced handling, etc. "Q-Caps" are available in a full range of sizes in both BSP threaded and plain tapered.

**REES CONSTRUCTION SERVICES LTD** Westminster House, High St, Old Woking, Surrey, GU22 9LF, UK, Tel: +44-4862-62221, Telex: 859679, Fax: +44-4862-22777, Contact: Mr Clarke. Specialist civil, mechanical and electronic engineers providing systems and services which are particularly appropriate to the water industry in the inspection of repair, renovation and construction of sewers.

**REES/HOUGH (CIVIL ENGINEERING) LTD** Nowhurst Lane, Broadbridge Heath, Horsham, Sussex, RH12 3PL, UK, Tel: +44-403-68722, Telex: 878366, Fax: +44-403-210072, Contact: Mr Deacon. Undertake specialist tunnelling, shaft sinking, jacking pipes also square or rectangular box sections used for culverts, subways or foundations. Geotechnical services are in-house for chemical ground stabilization techniques.

**SBBM & SIX CONSTRUCT SA** Boulevard Louis Mettwie 74/76, Brussels, 1080, Belgium, Tel: +32-2-520-40-20, Telex: 63391/BESIX B, Fax: +32-2-521-00-42. General contractor for infrastructure development including water supply networks, highways, railways, undergrounds, hydraulic and harbour schemes, industrial projects, buildings. Active in Europe, Africa, the Middle East and Central America.

**SHEPHARD, HILL & CO LTD** Cedar House, Vine Lane, Hillingdon, Middlesex, UB10 0BX, UK, Tel: +44-895-36471, Contact: Humphrey Pocock. Shephard, Hill & Co Ltd ranks among the most respected of British

civil engineering concerns and this reputation has been won by completing contracts on or ahead of programme and by producing high quality work.

**TAMS-PIRNIE INTERNATIONAL** 655 Third Avenue, New York, NY, 10017, USA, Tel: +1-212-867-1777, Telex: (ITT)422188/(RCA)233055, Fax: +1-212-697-6354. TPI was formed to offer environmental planning, sanitary engineering and water resources development on a worldwide basis. Fields of specialization include water supply systems (all types), wastewater systems and industrial water and pollution control.

**TARMAC CONSTRUCTION** Construction House, Birch St, Wolverhampton, WV1 4HY, UK, Tel: +44-902-22431, Telex: 336057, Fax: +44-902-316430, Contact: Peter Hudson. Major building and civil engineering contractor with experience both in UK and internationally in all aspects of the current construction market.

**TEERBAU GESELLSCHAFT FUR STRASSENBAU MbmH - SONDERBAU** Rheinbabenstr 75 Bottrop D-4250 West Germany Tel: +49-2041-993-1, Telex: 17-20-41-31, Sonderbau has longterm experience in the execution of hydraulic engineering work, and its specialists are able to develop applications and methods which comply with technical and economical requirements already in the planning stage, working in collaboration with clients at home and abroad.

**VISSER & SMIT HANAB B V** P O Box 305, Papendrecht, 3350 AH, The Netherlands, Tel: +31-78-417222, Fax: +31-78-155163, Contact: Martin Visser. Construction of networks for domestic gas and water supply, construction of transmission pipelines for gas, water, oil and products. River crossings, horizontally drilled crossings, installation of power cables, and so on.

### Procurement Specialists

**ANSALDO SISTEMI INDUSTRIALI** Via Pieragostini 50, Genoa, 16151, Italy, Tel: +39-10-41031, Telex: 281311, Fax: +39-10-420451. Ansaldo Sistemi Industriali is a contracting and engineering company operating in, among others, the field of water technology systems. Specifically the company is involved in the study, design, engineering, procurement, marketing and implementation activities in water technology systems. This includes supply, installation commissioning, start-up, technical assistance and training in the areas of water distribution and sewerage systems, water treatment systems, irrigation systems and all mechanical and electrical equipment.

**HEAP & DIGBY** 78 Manor Rd, Wallington, Surrey, SM6 8RZ, UK, Tel: +44-1-669-5971, Telex: 946729, Fax: +44-1-773-3110, Contact: Mr Lewis. For over 70 years Heap & Digby have assisted water/sewage treatment undertakings. Consultants and contractors in specifying, procuring, commissioning machinery, electrics, controls and instrumentation for all forms of treatment and pumpings.

**QPS PLASTICS** New York Industrial Estate, Summer-



## PROCUREMENT SPECIALISTS

bridge, Harrogate, North Yorkshire, HG3 4LA. UK. Tel: +44-423-780389, Fax: +44-423-781516. QPS Plastics are suppliers of the "Q-CAP"<sup>TM</sup> range of sewage distributor-arm end caps. Cast in En-thane<sup>TM</sup> polyurethane, "Q-Caps" offer many advantages over conventional metal end caps and bungs, including speed of "flushing" and/or "rodding out", no corrosion, less weight, greater resilience, reduced handling, etc. "Q-Caps" are available in a full range of sizes.

### Project Management

**ANSALDO SISTEMI INDUSTRIALI** Via Pieragostini 50, Genoa, 16151, Italy, Tel: +39-10-41031, Telex: 281311, Fax: +39-10-420451. Ansaldo Sistemi Industriali is a contracting and engineering company operating in, among others, the field of water technology systems. Specifically the company is involved in the study, design, engineering, procurement, marketing and implementation activities in water technology systems. This includes supply, installation commissioning, start-up, technical assistance and training in the areas of water distribution and sewerage systems, water treatment systems, irrigation systems and all mechanical and electrical equipment.

**R W BECK AND ASSOCIATES** Fourth & Blanchard Building, 2121 Fourth Avenue, Seattle, Washington, USA, Tel: +1-206-441-7500, Fax: +1-206-441-4962. Services span the disciplines of civil, mechanical, electrical, sanitary and structural engineering, computer systems, economics, environmental sciences and construction management with the complete range of feasibility, planning, design, project and programme management, start up and operations assistance.

**CROOKS MITCHELL PEACOCK STEWART PTY LTD** 2 Thomas St, Chatswood, NSW, 2067, Australia, Tel: +61-2-412-9999, Telex: AA 120557, Fax: +61-2-411-6230. Engineering and management services for industrial, resource development and infrastructure projects. Work undertaken ranges from pre-feasibility studies, through to project implementation and beyond to commissioning and plant maintenance. Fields of specialization include drainage, pipelines, wastewater and water supply.

**GEOTECNICA SA** Rua Moura Brasil 44-Laranjeiras, Rio De Janeiro, CEP 22231, Brazil, Tel: +55-21-265-3312, Telex: 23874. Experience in project planning, design, management construction and supervision in irrigation, water supply, sanitation etc.

**HIDROSERVICE** Rua Afonso Celso, Sao Paulo, 04119, Brazil, Tel: +55-11-549-3344, Telex: 1123596, Fax: +55-11-549-1590. Hidroservice perform all aspects of project planning, investigation, design and construction management. Fields of specialization include dams, pumping stations, water resources development, flood control, drainage, irrigation, water treatment and supply.

**ILF CONSULTING ENGINEERS** A-6020 Innsbruck, Framsweg 16, Austria, Tel: +43-5222/63-3-33, Telex: +53733 laibk a. Special activities of ILF include water

management studies, long-distance water pipelines with pumping stations, reservoirs and auxiliary facilities, water supply, water treatment, sewage clarification and sewage disposal.

**JOHNSTON IRRIGATION INC** Post Office Box 2076, Fort Pierce, FL, 34954, USA, Tel: +1-407-466-4500, Fax: +1-407-466-6081, Contact: Matthew M Johnston. Johnston Irrigation serves the US and the international marketplace with complete irrigation services including overhead and drip irrigation systems, engineering/design, project management/installation, wholesale materials, pump design, and consulting. Johnston Irrigation is one of the largest agricultural irrigation contracting companies in the United States.

**LLOYD'S REGISTER INDUSTRIAL DIVISION** Lloyd's Register House, 29 Wellesley Rd, Croydon, CR0 2AJ, UK, Tel: +44-1-681-4040, Telex: 28636, Fax: +44-1-681-6814, Contact: Mr Skewins. Project management, quality assurance and independent third party inspection.

**MERALCO INDUSTRIAL ENGINEERING SERVICES CORP** 3rd-5th Floors, TSC Building, Meralco Cmpo, Ortigas Avenue, Pasig, MM, Phillipines, Tel: +63-721-9951, Telex: 14730. Broad-based operations including most aspects of water distribution and use. Services include design, planning, implementation, construction management and supervision, purchasing and project management.

**JAMES M MONTGOMERY CONSULTING ENGINEERING INC** PO Box 7009, 250 North Madison Avenue, Pasadena, California, 91109/7009, USA, Tel: +1-818-796-9141. Recognised internationally for expertise and unique capabilities in water and wastewater engineering. Offer a complete range of services including master plans and feasibility studies, detailed design, construction management services and facilities start-up and operation. Experience in aquaculture.

**MORRISON-KNUDSON ENGINEERS INC** 180 Howard St, San Francisco, CA, 94105, USA, Tel: +1-415-442-7300, Telex: (WUI)677058/(ITT)470040/(RCA)278362/(WUD)34376. Full-service engineering, procurement and construction management company offering single-source responsibility for the design and management of large and small projects worldwide. The water resources field is a major aspect of the company's expertise.

**NEI POWER PROJECTS LTD** P O Box 13, Saltmeadows Rd, Gateshead, Tyne & Wear, NE8 1YZ, UK, Tel: +44-91-477-6666, Telex: 53116, Fax: +44-91-477-8200, Contact: Mr Hibbett. Project engineering and project management for turnkey water utility contracts.

**OBERMEYER PROJECT MANAGEMENT GmbH** Hansastrasse 40, Munchen 21, D-8000, West Germany, Tel: +1-49-89-5799/1, Telex: 6-323-566 and 898-588, Fax: +1-49-89-5799/3333. Provides integrated planning services for overseas clients in the sectors of regional and urban planning, infrastructure and detailed projects, operational organization and data handling and undertakes project management.

**PRC ENGINEERING INC** 1505 Planning Research Drive, McLean, Virginia, 22102, USA, Tel: +1-703-556-1000, Telex: 248372, Fax: +1-703-556-1174. Serves government and industry in planning, engineering, architecture, construction management and the design, commissioning, operation and maintenance of a diverse range of facilities. Irrigation, flood control, river regulation, dams, drainage, wastewater, water supply and distribution, hydroelectric power.

**PURAC AB** P O Box 1146, Lund, S-22105, Sweden, Tel: +46-46-135100, Telex: 8305083, Fax: +46-46-14-69-88, Contact: Mr Eric Sander. The Purac organization offers all the specialized skills in process, mechanical, electrical and structural engineering, coupled with total project management and assured plant performance.

**TAMS CONSULTANTS INC** 655 Third Avenue, New York, NY, 10017, USA, Tel: +1-212-867-1777, Telex: (ITT)422188/(RCA)233055, Fax: +1-212-697-6354. Consulting firm of engineers, architects and planners providing professional services for projects throughout the world. Fields of specialization include water resources - planning, design and construction supervision services for dams, hydroelectric power, flood control, irrigation systems and river basin planning.

### Treatment Plant

### Equipment Installation

**ANSALDO SISTEMI INDUSTRIALI** Via Pieragostini 50, Genoa, 16151, Italy, Tel: +39-10-41031, Telex: 281311, Fax: +39-10-420451. Ansaldo Sistemi Industriali is a contracting and engineering company operating in, among others, the field of water technology systems. Specifically the company is involved in the study, design, engineering, procurement, marketing and implementation activities in water technology systems. This includes supply, installation commissioning, start-up, technical assistance and training in the areas of water distribution and sewerage systems, water treatment systems, irrigation systems and all mechanical and electrical equipment.

**AQUA TECH GESELLSCHAFT mbH & CO KG** A-5020 Salzburg, Ferdinand-Porsche-Strasse 1, Austria, Tel: +43-662/77-1-30/78-6-71, Telex: 632618 aquat a. Aqua-Tech specialises in the planning, construction and installation of water treatment plants. To meet the demand for proven and economical technology, reliable operation and quick and easy plant installation, Aqua-Tech have developed prefabricated waterworks which are tested before shipment and can be put into operation as soon as they reach the building site.

**BALFOUR BEATTY CONSTRUCTION INTERNATIONAL LTD** Randolph House, Wellesley Rd, Croydon, Surrey, CR9 3QD, UK, Tel: +44-1-686-0555, Telex: 946191, Fax: +44-1-681-2827/688-0878, Contact: Joy Bignall. Balfour Beatty Group with its seven operating companies is engaged in more than 50 countries worldwide. Its extensive range of activities includes the design and construction of water treatment plants.

**BIWATER SEWAGE TREATMENT** Milltown St, Radcliffe, Manchester, M26 9NU, UK, Tel: +44-61-723-3821, Telex: 669834, Fax: +44-61-724-5605, Contact: Mr Geoff Spencer. Specialists in the manufacture and installation of sewage and industrial effluent treatment plant worldwide.

**BIWATER TREATMENT LTD** Biwater Court, Station Approach, Dorking, Surrey, RH4 1TF, UK, Tel: +44-306-740740, Telex: 859529, Fax: +44-306-889298, Contact: Mr Phil Cowley. Potable plant specialist contractors for large and medium sized urban and rural developments.

**CROSS MARINE SERVICES INC** 565 West 2000 South, Orem, Utah, 84058, USA, Tel: +1-801-225-8355, Fax: +1-801-226-4108, Contact: Mr Charles Carlin. Equipment erection, turbines and generators. Manufacturers of gates and valves, seals and gaskets. Complete range of services in construction engineering (inc. underwater).

**CROSSLINK SDN BHD** P O Box 11157, 55-1, Lorong Hj Hussein 1, Off Jalan Raja Muda, Kuala Lumpur, 50738, Malaysia, Tel: +60-3-29246013-2981326, Fax: +60-3-2910190, Contact: Alex Goh. Contractor to install, supply and maintain water treatment plant and equipment like: water deioniser, softener, carbon and sand filter, clarifier, chlorination (gas) system and special ton-exchanger also the sole representative of 'PURO-LITE' ton-exchange resin for Malaysia.

**DELTA ENGINEERING BV** P O Box 227, Vlaardingen, 3130 AE, The Netherlands, Tel: +31-10-46-00-000, Telex: 24536, Fax: +31-10-46-00-898, Contact: Mr Verwey. Designers and contractors for complete water treatment installations.

**EBARA CORPORATION** 11-1 Haneda Asahicho, Ohtaku, Tokyo, 144, Japan, Tel: +81-3-743-6716, Telex: EBARATYOJ 22988, Fax: +81-3-745-3576, Contact: Mr R D Jones. London Office: Regal House, London Rd, Twickenham, Middlesex, Tel: +44-1-892-89712. A large systems engineering department of over 200 people in the role of main mechanical electrical contractors, which include water pumping stations, sewage and water treatment.

**EMPRESA AUXILIAR DE LA INDUSTRIA AUXINI S A** Padilla 46, Madrid, 28006, Spain, Tel: +34-91-431-42-20, Telex: 49090 AXNI E. Project and construction of water treatment plants through peat bed system. Construction of sewage treatment plants. Project and construction of industrial water treatment plants.

**ENERGY & WASTE SYSTEMS LTD** EWS House, Station Rd, Westbury, Wilts, BA13 4HT, UK, Tel: +44-373-858090, Telex: 445672, Fax: +44-373-827223. EWS undertake turnkey projects in the waste treatment industry and offer a range of package treatment plants, including packaged sludge digestion and sewage plants. Products include fine screen and handling systems, fine air bubble diffuser systems and combined heat and power generation.

**ESSENER HOCHDRUK - ROHRLEITUNGSBAU** P O Box 120124, Essen 12, D-4300, West Germany, Tel:

# HANDRAILING FLOORING STAIRCASES LADDERS ACCESS & SAFETY EQUIPMENT

IN ALUMINIUM

STAINLESS STEEL  
MILD STEEL GRP



# Mark Rainer

Mark Rainer International Ltd

Leamore Close  
Leamore Industrial Estate  
Walsall, West Midlands  
WS2 7NL ENGLAND

Tel 0922 401408  
0922 401433  
Telex 334173 MARAIN G  
Fax 0922 495958

Mark Rainer International Ltd. specialises in the design and manufacture of handrailing, flooring, staircases and associated steelwork. The company's products are in use world wide in the Water, Gas, Petrochemical and Electricity industries.

Mark Rainer International Ltd

Overseas Agencies

P.O. Box 4231  
Limassol, CYPRUS

Tel (051) 79493  
Telex 5219 NTGRALECY  
Fax 357-51-25950

MAN LFE  
Mechanical Engineering Ltd  
Room 1113, Nan Fung Centre  
264-298, Castle Peak Road  
Tsuen Wan, HONG KONG

Tel 0-4163640, 0-4921928  
Telex 40678 KINGK HX  
Fax 0-4997747

# ADVERTISEMENT FEATURE

## SOCIETE DES EAUX DE MARSEILLE

**Company description.** A public service such as drinking water supply has two basic aspects between which those in charge of Marseille region policies have had to distinguish. One is the political and social aspect. This determines the choice of and the control over the investments as well as the distribution of the financial cost between different users. Then there is the "industrial" aspect in the areas of administrative and financial management techniques. SEM is responsible for this last aspect.

From 1943, when it was formed, until 1960, SEM devoted itself to providing improved techniques to drinking water supply installations in Marseille. As of 1960 it began to expand its operations to other communities and other types of business, including purification, waste water treatment and collection.

The high quality of its service has resulted in the fact that its operations and know-how are recognized throughout France. Its engineers are often called upon to carry out various tasks involving expertise, diagnosis or consultancy either in similar organizations, in consulting firms, or in international assistance or financing firms in the following areas:

- Resources, treatment and supply of drinking water;
- Collection, purification and removal of domestic or industrial used waters;
- Collection and treatment of solid wastes of domestic or industrial origin.

It has thus acquired a great deal of experience in the management of public water and purifications services:

- Technical operations (operation, maintenance, rehabilitation of structures);
- Administrative and financial procedures (billing, collection, accounting, investment program);
- Staff training;
- Organization of institutional policy and growth structures.

**Studies and supervision of such works** as hydraulic and

- hydrogeological research.
- Water savings, checking and monitoring quality;
- Water treatment, treatment plants, pumping stations, storage, transport and supply networks, remote and centralized control of plants.

**Services.** Structural organization and staff training.

- Assistance in the operation and management of technical services;
- Consulting tasks or technical assistance.

**SEM's main achievements** essentially involve three areas:

- studies, technical assistance and training.  
Studies: expansion of the capacity of the Marseille transit canal from 6 to 17m per second over a 100km section length. The study and production of a water treatment plant in Sainte Marthe-Vallon Dol which can provide a flow of 6m per second (flocculation, rapid filtration, ozonization), as well as many pumping stations.

The technical development of a remote control system for transport, production and distribution installations.

Technical assistance: worldwide contracts (network management, administrative procedures, management techniques and training).

Training: the development of a feasibility study in the water techniques training centre in Damascus. Syria: facilities for trainees abroad; and courses on specific topics involving

urban waterworks, treatment and general operations.

One of SEM's best co-operative resources involves providing tools for management. It can be achieved through an original strategy of using staff training to teach the following:

"To know"; "To know how to do"; "To know how to teach what needs to be done".

Learning "to know" means supplementing basic education with additional information, either for young high school graduates or for on-the-job agents by providing them with a practical education.

Obtaining "know-how" means learning how to use knowledge both in daily management as well as in planning management.

"To know how to teach what needs to be done" is being able to fill the role of a supervisor and instructor in a given structure.

This means that for us, training is a special management tool which makes it possible not only to modify a given level of knowledge, but also a range of approaches which are of value not only in terms of the individuals' overall experience, but in terms of his innate qualities as well.

**Client references.** **Libya:** submarine resurgence collection project in the Benghazi region. Client: FAO-GWA (July, 1975). **Cuba:** research on the waste water network interceptor using the Gulf of Havana. Client: D.A.P. (January, 1976). **Venezuela:** technical assistance for maintaining the Caracas supply system and for administrative and commercial problems. Client: INOS (from January, 1976 to February, 1979). **Italy:** research on submarine resurgence along the Sicilian coast. Client: F.S.A. (August, 1976). **Ethiopia:** extension of the treatment station and the water supply system. Client: Addis-Ababa/WSA (August to October 1976). **Greece:** studies and research on submarine resurgence along the Gulf of Corinth. Client: Ministry of Public Works (September, 1977). **Yemen:** technical assistance for maintaining the water supply network. Client: Public Water Corporation (1978/1979). **Tunisia:** technical assistance. Client: ONAS (1980). **Mauritius:** study of a master plan (1980/1982). Short term mission for water management. Client: SIGMA (1982). **Spain:** technical assistance within the framework of co-operative relations between Palma and Provence-Alpes/Côtes d'Azur region. Diagnosis, pipe location, leak detection. Client: EMAY/Palma de Mallorca (1982). **Panama:** technical assistance for the maintenance of the water supply network of Panama City. Administrative problems. Client: IDAAN (1980 to 1983). **Algeria:** technical assistance for water supply networks in the city of Alger. Client: SONADE. Technical assistance missions. Client: SEDAL (1980 to 1983). **Algeria:** technical personnel training programme. Client: EPEAL (1984 to 1985). **Guatemala:** diagnosis on the pumping stations in order to prepare the technical assistance programme for the rehabilitation of the network in Guatemala City. Client: EMPAGUA (1985). **Coast of Ivory:** study on the centralized control of the water supply network of Abidjan realized by SAFEGE. Client: ABIDJAN (1984 to 1985). **Panama:** Rehabilitation and improvement of the water supply and sewerage network of Panama and Colon. Client: IDAAN (1984 to 1986). **Panama:** master plan of water supply for Panama City in association with BCEOM. Client: IDAAN (1985). **Honduras:** institutional strengthening and investment programme in S.A.N.A.A. Client: S.A.N.A.A. (1985 to 1986). **Coast of Ivory:** supervision of works for the remote control system of water supply. Client: Direction of Water of Abidjan (1986 to 1987). **Senegal:** feasibility study for the Canal of Cayor in order to strengthen the water supply in the region of Dakar and the irrigation of the areas along the canal. Client: Ministry of Hydraulics (1986 to 1987). **Algeria:** master plan of water supply network for Oran City in association with BCEOM (1986 to 1987). **Panama:** study for the extension of the improvement of the water treatment plant of Chulbre. Client: IDAAN (1986 to 1987). **Colombia:** rehabilitation and improvement of the water supply and sewerage network of Cucuta. Client: EMCUCUTA (1988 to 1989).

# SOCIETE DES EAUX DE MARSEILLE

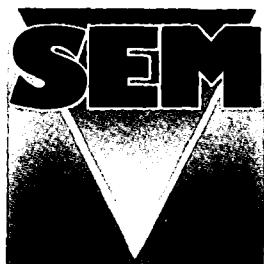

WATER SUPPLY  
and  
SANITATION  
COMPANY

CONSULTANCY  
TRAINING  
TECHNICAL  
ASSISTANCE

SOCIÉTÉ DES EAUX DE MARSEILLE  
25, rue Edouard Delanglade  
B.P. 29-13254 MARSEILLE CEDEX 6  
FRANCE

Telephone: (91) 57 60 60  
Telex: SEMARSL 440884 F



## TREATMENT PLANT EQUIPMENT INSTALLATION

+49-201-349-25, Fax: +49-201-351423. Planning, engineering, prefabrication, assembly and maintenance, erection of plants for water technology in power stations, industrial and municipal enterprises: complete water and waste water treatment plants.

**HOUSEMAN BV** P O Box 190, Van Konijnenburgweg 141, Antwerp, Bergen op Zoom, 4600 AD, The Netherlands, Tel: +31-1640-55000, Telex: 78376, Fax: +31-1640-59587, Contact: Mr Huijgenis. Contractors for well water treatment, cooling water treatment and chemical cleaning.

**HYDRO ENGINEERING SDN BHD** 15A Jalan Bachang Batu 2 1/4 off Jalan Ipoh, Kuala Lumpur, 51200, Malaysia, Tel: +03-2987814 & 2920935, Fax: +2432223, Contact: James F C Chong. Established in 1981, Hydro is involved in treatment plant equipment installation and projects with local authorities, public work department and other government agencies in Malaysia. They are expanding and hope to have dealings in overseas markets.

**JOHNSON FILTRATION SYSTEMS** Johnson House, Browells Lane, Feltham, Middlesex, TW13 7EQ, UK, Tel: +44-1-751-4424, Telex: 935479, Fax: +44-1-890-1533. Johnson Filtration Systems undertake the installation of complete water treatment schemes as well as refurbishment of existing works. Generally, this is carried out in the UK but the package nature of our designs allows easy installation together with ancillary equipment.

**KIPSZER** PO Box 28, Budapest X, Faszberenyi ut 36, H-1475, Hungary, Tel: +36-1-575-122, Telex: +22-5328, Fax: +36-1-572-958. Treatment plants for drinking water, boiler feed water, industrial process water, water for agricultural use, cooling water and secondary purification of waste waters.

**LEE POLLUTION CONTROL LTD** 1 Station Rd Four Ashes, Wolverhampton, WV10 7DQ, UK, Tel: +44-902-791616, Telex: 335684, Fax: +44-902-791772, Contact: Mrs Juggins. Contractors for custom - designed and built water and effluent treatment plant.

**MAHON & MCPHILLIPS (STRATFORD) LTD** Holford Way, Witton, Birmingham, West Midlands, B6 7AX, UK, Tel: +44-21-356-7606, Telex: 334041, Fax: +44-21-356892, Contact: Mr Hatt. Mechanical plant contractors, designers and manufacturers in the field of municipal and industrial water and waste water treatment.

**NIO-PLAN** A-1060 Wien, Amerlingstrasse 17, Austria, Tel: +43-1-57-11-43, Telex: 113587. Nio-Plan undertake studies, general and detailed planning of large-scale water supply plants as well as invitations to tender and awarding of contracts and direction and supervision of building.

**OÜSTERREICHISCHE BROWN BOVERI-WERKE AG** POB 184, Wien, A-1101, Austria, Tel: +43-1-601090, Telex: 131760. Oüsterreichische Brown-Boveri-AG are backed by 70 years of experience in the production of electrical plants and systems for industry. For the water

technology sector they project, supply and erect electrical distribution, installation and telecontrol systems, electrical drives, medium-high-voltage plants, etc. for water treatment, water supply, irrigation and drainage plants, sewage clarifiers and pumping stations.

**PORTALS WATER TREATMENT** Oldfield Lodge, 156 Bridge Rd, Maidenhead, SL6 8DG, UK, Tel: +44-628-771444, Telex: 849067, Fax: +44-628-771567, Contact: Mr Hunter. Process design and engineering of water, effluent, sewage and process liquids treatment project. PWT undertake contracts of any size throughout the world, and supply their own fully proven range of pre-engineered products and protect systems with a comprehensive range of speciality chemicals.

**QPS PLASTICS** New York Industrial Estate, Summerbridge, Harrogate, North Yorkshire, HG3 4LA. UK. Tel: +44-423-780389, Fax: +44-423-781516. QPS Plastics are suppliers of the "Q-CAP"<sup>TM</sup> range of sewage distributor-arm end caps. Cast in En-thane<sup>TM</sup> polyurethane, "Q-Caps" offer many advantages over conventional metal end caps and bungs, including speed of "flushing" and/or "rodding out", no corrosion, less weight, greater resilience, reduced handling, etc. "Q-Caps" are available in a full range of sizes in both BSP threaded and plain tapered.

**MARK RAINER INTERNATIONAL LTD** Leamore Close Leamore Industrial Estate, Walsall, West Midlands, WS2 7NL, UK, Tel: +44-922-401408/401433, Telex: 334173 MARAIN G, Fax: +44-922-495958. Mark Rainer International Ltd specialise in the design and manufacture of handrailing, flooring, access equipment and associated steelwork. All products are available in a variety of materials to suit different installation requirements. These materials include aluminium, galvanised mild steel, stainless steel and GRP. The company's products are in use throughout the world and comply with relevant safety standards or specifications in all installations.

**S O G E A** Tour American International, Paris La Defence, Cedex 55, 92079, France, Tel: +33-1-47-52-41-95, Fax: +33-1-47-52-41-84, Contact: Francois Hanus. Sogea is a 23000 people company, working through branches or affiliated companies in 50 countries around the world. Over the years Sogea has developed a strong position in water treatment and associated waterworks and services as a contractor. From process design to performance guarantees, Sogea's responsibilities include the following specialities: Engineering: process, hydraulic, mechanical, electrical, civil, Design: process, control, chemical.

**SIMON - HARTLEY LTD**, Stoke-On-Trent, ST4 7BH, UK, Tel: +44-782-202300, Telex: 363055JIMHARG, Fax: +44-782-261494, Contact: Bob Foxley. Manufacturers of a full range of mechanical equipment for the treatment of sewage and industrial effluents. Also full turnkey facilities for erection and supply of complete plants for sewage and industrial effluent treatment. Penstock and valves in metals and plastic construction.

**UNOX EFFLUENT TREATMENT SYSTEMS (WIMPEY ENGINEERING)** 27 Hammersmith Grove, Lon-



TESCO Organization for International  
Technical and Scientific Cooperation  
Hungary/Budapest  
1054 Budapest V., Rosenberg hp. u. 21.  
1367 P.O.B.5/101 Telex: 22-4642 Phone: 110-850  
Telegramm: TESCO - Budapest

If you need a reliable partner in consulting, engineering, or contracting, why not contact TESCO and its associated companies?  
TESCO has references in more than 30 countries of the world in the field of

- municipal and regional projects
  - agriculture and food industry
  - water management
- in this latter specialization we would like to draw your attention to
- industry
  - civil engineering



ZALAEGRSZEG SEWAGE  
TREATMENT PLANT (HUNGARY)



KŐSZÖRŰVÖLGY RESERVOIR  
(HUNGARY)



CONSULTING CO. FOR  
WATER ENGINEERING  
FOUNDED: 1954



DJERID OASES'S IRRIGATION AND  
PALM REHABILITATION (TUNISIA)

Head office:  
Budapest, V. Münnich Ferenc u. 36. HUNGARY  
Postal address: H-1397 Budapest P.O.B.527  
Tel.: (-36-1-) 317-550, 319-170 Telex: (-61-) 225584  
Cable: VIZITERV Budapest

**PROFESSIONAL SERVICES**

- Preliminary investigations - studies - and designs
- Feasibility studies - Pre-investment studies
- Master plans - Reports - Final designs
- Construction engineering
- Systems engineering
- Engineering cost estimation
- Tender and contract documents
- Management and on-job training
- Project supervision - Technical advice

**MAIN FIELDS OF ACTIVITY**

- Municipal and Industrial Water Supply
- Sewage Collection Systems, Sewage Treatment and Disposal
- Agricultural Water Development
- River Engineering, Flood Control

**FACILITIES**

- hydrology - hydraulics
- surveying - hydrogeology
- laboratory testing, geotechnical - water - and sewage analyses
- computer technology

## TREATMENT PLANT EQUIPMENT INSTALLATION

don, W6 7EN, UK, Tel: +44-1-748-2000, Telex: 25666, Fax: +44-1-748-0076/748-6083, Contact: Amanda Powell. Contractors and specialist process and equipment suppliers to the water and sewage treatment industry.

### **WASSERTECHNIK GESELLSCHAFT mbH & CO KG**

A-5020 Salzburg, Rücklbrunnerstrasse 41, Austria, Tel: +43-6222/72-4-25 26 27, Telex: +633499. Wassertechnik undertakes the planning and production of water purification and supply plants from design to start-up, the line-up embracing softening, full desalination plants, condensate and cooling water treatment facilities, waste water purification plants, ultrafiltration and reverse osmosis plants for industrial and municipal requirements.

### **WATER AND POWER DESIGN - ENGINEERING**

(LTD) Glenthorne House, Hammersmith Grove, Hammersmith, London, W6 0ND, UK, Tel: +44-1-846-9111, Telex: 268760 ETIWAP G. Contractors and designers for water and sewage treatment plant: turnkey water works design and construction, clarifying equipment, control panels and systems, data logging systems, filters, flocculating equipment, pollution control systems and telemetry systems.

### **WATER ENGINEERING LTD**

Aynho Rd, Adderbury, Banbury, Oxon, OX17 3NL, UK, Tel: +44-295-810581, Telex: 83655, Fax: +44-295-811997, Contact: John Mee. Design and supply of municipal effluent and water treatment plants worldwide, either on a project management basis or as individual products and process - extending to installation and commissioning.

## Turnkey Services

### **ADS SERVICES INC**

2227 Drake Avenue S W, Suite 26, Huntsville, AL, 35805, USA, Tel: +1-205-883-9323, Telex: 4933400, Fax: +1-205-882-6765, Contact: Bess Boon. Process control and remote monitoring with telemetry using distributed digital approach. ADS provides turnkey services, including equipment, installation, operation and service.

### **ANSALDO SISTEMI INDUSTRIALI**

Via Pieragostini 50, Genoa, 16151, Italy, Tel: +39-10-41031, Telex: 281311, Fax: +39-10-420451. Ansaldo Sistemi Industriali is a contracting and engineering company operating in, among others, the field of water technology systems. Specifically the company is involved in the study, design, engineering, procurement, marketing and implementation activities in water technology systems. This includes supply, installation commissioning, start-up, technical assistance and training in the areas of water distribution and sewerage systems, water treatment systems, irrigation systems and all mechanical and electrical equipment.

### **AQUA ENGINEERING GESELLSCHAFT mbH**

A-5020 Salzburg, Moserstrasse 29, Austria, Tel: +43-662/33-5-11-15, Telex: 632679. Aqua Engineering are active as general contractors for the erection of turnkey water treatment plants and as planners and suppliers of mechanical equipment on a joint venture basis with

local building and erecting companies. The firm undertakes the building of water treatment plants and waterworks for drinking and industrial service water supply, for agricultural purposes, sewage and industrial waste water.

### **BAUMEISTER KASTNER**

A-8911 Admont, Weng 127, Austria, Tel: +43-3613/2772. The Admont-based engineering office Kastner (other offices in Graz and Kapfenberg) was founded in 1970 and is engaged in the planning, invitation to tender, building supervision and operation of municipal water supply plants, sewage disposal systems, clarification plants and refuse disposal facilities. The company undertakes the execution of complete projects from the planning stage onwards and paying special attention to operating costs.

### **BIWATER AMES CROSTA**

Hexwood, Lancashire, OL10 2DX, UK, Tel: +44-706-67555, Telex: 63410 AMES G, Fax: +44-706-65598, Contact: David Lord. Biwater Ames Crosta is a leading process contractor specializing in complete turnkey or equipment supply services for all areas of water and wastewater treatment, including desalination by reverse osmosis.

### **JOHN BROWN ENGINEERING LTD**

Clydebank, Dunbartonshire, G81 1YA, UK, Tel: +44-41-952-2030, Telex: 778395, Fax: +44-41-952-4895, Contact: Mr Dickens. Turnkey contractor offering a range of services for water and effluent treatment including: design, construction and finance packages, process engineering and refurbishment works.

### **CANADIAN APPLIED TECHNOLOGY**

10 Plantehet Rd, Unit 21, Concourse, Ontario, L4K 2C8, Canada, Tel: +1-416-738-8205, Telex: 06-964-887, Fax: +1-416-738-6964, Contact: Margaret Walker. Produces guaranteed turnkey environment systems for governments and industries.

### **DEEP SHAFT TECHNOLOGY INC**

801 York Mills Rd, Don Mills, Ontario, M3B 1X7, Canada, Tel: +1-416-391-5616, Fax: +1-416-391-1326, Contact: Paul G Daly. Deep Shaft Technology Inc, are a drilling company and process engineering firm specializing in a unique wastewater treatment process. The Deep Shaft process is a biological treatment system utilizing a totally enclosed steel cased reactor 200-500 ft deep. This process treats both municipal and industrial wastewater.

### **ENERGOPOL CONTRACTORS & DESIGNERS**

Vl. Nowogrodzka 21, Warsaw, 00-930, Poland, Tel: +48-22-298081, Fax: +48-299997, Contact: J M Lesnikowski. Energopol is a contracting company specialized in: maritime and inland hydroengineering projects such as harbours, docks, piers, breakwaters, dams, reservoirs, canals, etc. Water and sewage economy: water supply systems for municipal and industrial purposes, water and sewage treatment plants, water intakes, irrigation and drainage schemes. Energopol possesses experience of over 40 years and its references include projects in Poland, USSR, GDR, Iraq, Cyprus, Greece.

### **ENERGY & WASTE SYSTEMS LTD**

EWS House, Station Rd, Westbury, Wilts, BA13 4HT, UK, Tel: +44-373-858090, Telex: 445672, Fax: +44-373-827223. EWS



## TURNKEY SERVICES

undertake turnkey projects in the waste treatment industry and offer a range of package treatment plants, including packaged sludge digestion and sewage plants. Products include fine screen and handling systems, fine air bubble diffuser systems and combined heat and power generation.

**ENVIRONMENTAL ENGINEERING LTD** Little London, Spalding, Lincs, PE11 2UE, UK, Tel: +44-775-68964, Fax: +44-775-710294, Contact: John Douglas. Environmental Engineering Ltd supply and install on a turnkey basis industrial and domestic effluent treatment plants both in the UK and overseas. Hardware consists of screens, presses, wedge wire clarifiers, dissolved air units, sludge dewatering, effluent treatment and flotation cells.

**ESSENER HOCHDRUK-ROHRLEITUNGSBAU P O** Box 120124, Essen 12, D-4300, West Germany, Tel: +49-201-349-25, Fax: +49-201-351423. Planning, engineering, prefabrication, procurement, transportation, assembly/laying and construction works, commissioning and start-up plus personnel training for large turnkey plants and complex plant components.

**GENERAL FILTER COMPANY** 600 Arrasmith Trail, Ames, Iowa, 50010-9761, USA, Tel: +1-515-232-4121, Fax: +1-515-232-2571. General Filter's engineering department handles your kind of water problem - industrial or municipal. Preliminary consultation, development and final construction of treatment plant to meet your needs. Based on thorough field and laboratory examination, General Filter engineers will see your problem through from start to finish - supervising the installation and training your personnel in proper operation.

**HIDROSERVICE** Rua Afonso Celso, Sao Paulo, 04119, Brazil, Tel: +55-11-549-3344, Telex: 1123596, Fax: +55-11-549-1590. Hidroservice perform all aspects of project planning, investigation, design and construction management. Fields of specialization include dams, pumping stations, water resources development, flood control, drainage, irrigation, water treatment and supply.

**HYDROTECHNIK GESELLSCHAFT mbH** A-5033 Salzburg, Alpenstrasse 54, POB 14, Austria, Tel: +43-662/22-4-72, Telex: 633821 hydro a. The company's lineup includes the planning, production, installation and sale of water treatment plants, reverse osmosis, desalination and water supply facilities and waste water purifying plants for industrial and municipal use. Hydrotechnik turn out turnkey water treatment plants with the cooperation of experienced building firms, or supply merely the necessary mechanical and electrical equipment.

**ICI BIOLOGICAL PRODUCTS** PO Box 1, Billingham, Cleveland, TS23 1LB UK Tel: +44-642-523786, Telex: +587443 ICIAGH G, Fax: +44-642-522676. ICI has a worldwide network of licensees who can provide design, construction and commissioning of its Deep Shaft process technology. The Deep Shaft process is increasingly used to treat a range of effluents, including domestic, industrial, food, alcohol, pulp and paper etc. Low running cost, low capital cost, high oxygen

transfer rate and low land area are just some of the advantages.

**IRRIGATION SYSTEMS CO** West Lodge, Adsdean, Funtington, Chichester, Sussex, UK, Tel: +44-243-575708, Telex: 86333, Fax: +44-243-786930, Contact: Mr Usher. Design, supply and installation of sprinkler and drip irrigation systems, for agriculture and horticulture etc. Turnkey contracting, management contracts and feasibility studies.

**JOHNSON FILTRATION SYSTEMS** Johnson House, Browells Lane, Feltham, Middlesex, TW13 7EQ, UK, Tel: +44-1-751-4424, Telex: 935479, Fax: +44-1-890-1533. Johnson Filtration Systems possess resources to handle complete turnkey water treatment projects, including civil works, pipelines, building and ICA, as required for a particular project. Work has been undertaken for Yorkshire Water and Welsh Water on both green field and refurbishment projects. These involved a wide range of equipment.

**KLOECKNER INDUSTRY ANLAGEN GmbH** PO Box 100852, Kloeckner Haus, Duisburg, D-4100, West Germany, Tel: +49-203-181, Telex: 085581870 RC D, Fax: +49-203-340095, Contact: Herr Hillerf. Provide a complete turnkey service to the waste water industry. Also complete mechanical and electrical packages including engineering, start up and operation maintenance.

**METCALF & EDDY INTERNATIONAL INC** PO Box 4043, Woburn, Massachusetts, 0188-4043, USA, Tel: +1-617-246-5200, Telex: 6817067, Fax: +1-617-245-6293. Full range of services from planning and financing and design and construction to operations and maintenance. The firm has worked to provide cost-effective, technologically sound solutions for water, wastewater, solid waste and hazardous waste management, natural resource utilization and the infrastructure crucial to industrial and agricultural development.

**MILLARS WELLPOINT (INTERNATIONAL) LTD** Barnham, Thetford, Norfolk, IP24 2PD, UK, Tel: +44-842-89451, Telex: 81361, Fax: +44-842-89645. Suppliers of pumps, wellpoint dewatering, irrigation and sewerage control systems. Engineering consultancy service supplying turnkey engineering packages.

**ML ENGINEERING (PLYMOUTH) LTD (INDUSTRIAL CONTROLS GROUP)** Estover Close, Plymouth, PL6 7PU, UK, Tel: +44-752-702525, Telex: 45383, Fax: +44-752-701653, Contact: Mr Heaton. Manufacturers of turnkey projects in SCADA, data and telemetry systems.

**NEI POWER PROJECTS LTD** P O Box 13, Saltmeadows Rd, Gateshead, Tyne & Wear, NE8 1YZ, UK, Tel: +44-91-477-6666, Telex: 53116, Fax: +44-91-477-8200, Contact: Mr Hibbett. Project engineering and project management for turnkey water utility contracts.

**NICHOLAS DATA SERVICE** 2497 E Bay Drive, Largo, FL, 33541, USA, Tel: +1-813-535-4627. Provide turnkey computer systems to water conditioning companies.

**POLLUTION ENGINEERING SDN BHD** BG-C

## TURNKEY SERVICES

Happy Mansion Jalan 17/15, Petaling Jaya, Selangor, 46400, West Malaysia, Tel: +60-3-7553182/7, Contact: Tony Y C Liew. Turnkey contractor for industrial wastewater and domestic sewage treatment systems.

**QPS PLASTICS** New York Industrial Estate, Summerbridge, Harrogate, North Yorkshire, HG3 4LA. UK. Tel: +44-423-780389, Fax: +44-423-781516. QPS Plastics are suppliers of the "Q-CAP"™ range of sewage distributor-arm end caps. Cast in En-thane™ polyurethane, "Q-Caps" offer many advantages over conventional metal end caps and bungs, including speed of "flushing" and/or "rodding out", no corrosion, less weight, greater resilience, reduced handling, etc. "Q-Caps" are available in a full range of sizes in both BSP threaded and plain tapered.

**RESOURCES CONSERVATION COMPANY** 3006 Northrup Way, Bellevue, WA, 98004, USA, Tel: +1-206-828-2400, Fax: +1-206-828-0526. RCC Services range from feasibility and engineering studies to the design and installation of complete turnkey systems. RCC provides training for plant personnel and operations support long after system start-up. The company also maintain extensive analytical computer capabilities, laboratory facilities and testing equipment to support process development, applications engineering and operations.

**SIEMENS AG ÖSTERREICH** Siemensstrasse 88 - 92, Wien, A-1210, Austria, Tel: +43-1-25010, Telex: 134-268-34 si a. Siemens AG offer planning and building supervision relating to the installation of pumping stations, water supply plants, reservoirs and tanks, pipelines and sag crossings, gallery and irrigation systems.

**WASSERMESSERFABRIK ANDRAE GmbH & CO** PO Box 1127 Neue Ramtstrasse 48, Leonberg, D-7250, West Germany, Tel: +49-71-52/4-70-31, Telex: +7-24-182. Industrial engineering - consulting and projection, turnkey projects, meter testing equipment and manpower training.

**WATER AND POWER DESIGN - ENGINEERING (LTD)** Glenthorne House, Hammersmith Grove, Hammersmith, London, W6 0ND, UK, Tel: +44-1-846-9111, Telex: 268760 ETIWAP G. Contractors and designers for water and sewage treatment plant: turnkey water works design and construction, clarifying equipment, control panels and systems, data logging systems, filters, flocculating equipment, pollution control systems and telemetry systems.

**YIT CORPORATION** Ratemest Arinkatu, Helsinki, SF-00520, Finland, Tel: +358-0-15051, Telex: H121416, Fax: +358-0-150528, Contact: Mr Nuudineu. YIT Corporation specialises in all types of water and sewage projects ranging from rural water supply schemes to complete turnkey plants including planning, supplies and civil/mechanical/electrical execution on site.

### Consultants

**A I B CONSULTING ENGINEERS** P O Box 1315, Solna, S171 25, Sweden, Tel: +46-8-734-5500, Fax: +46-

8277684, Contact: Mr Lond. Consulting engineers with a broad experience of water supply and sewage treatment in Sweden and in developing countries master plans, feasibility studies, detailed design, supervision, operation and maintenance.

**ACT CONSULTANTS CO LTD** 7th Floor, Kong Boonma Building, 699 Silom Rd, Bangkok, 10500, Thailand, Tel: +66-234-7190 ext 30-32, Telex: 82041, Fax: +66-2-236-8020. Consulting services in all fields of architecture, engineering, planning and marketing research. Fields of specialization include aquaculture and fisheries, land and water feasibility studies, drainage etc.

**AECC (AQUA ENGINEERING AND CONTRACTING COMPANY)** Altenburgerstrasse 49, Brugg, CH-5200, Switzerland, Tel: +41-56-41-69-61, Telex: 825139 ingh ch, Fax: +41-56-41-15-75, Contact: Mr Schlub. The specialist for: general planning, detail design, consulting, supervision, including civil works, general contracting for mechanical-electrical equipment, for all potable, industrial, waste water facilities, wells, pumping, treatment cooling and distribution.

**AKZO-FIBRES AND POLYMERS DIVISION CIVIL ENGINEERING AND INDUSTRIAL SYSTEMS** P O Box 9300, Arnhem, S B, 6800, The Netherlands, Tel: +31-85-66-4593, Telex: 45-204, Fax: +31-85-66-3727, Contact: Ms De Wit. Civil Engineering & Industrial Systems Division of Akzo is active in agriculture, the building industry, environmental protection, erosion control, geotechnics, hydraulic engineering and industry. The activities range from consulting during the design stage to assisting with the realization of projects.

**ALLOTT & LOMAX** Fairbairn House, Ashton Lane, Sale, Manchester, M33 1WP, UK, Tel: +44-61-962-1214, Fax: +44-61-969-5131, Contact: D Slack. Allott & Lomax provides consulting services in the fields water of engineering in the design and project management of water abstraction, treatment and distribution systems, service reservoirs, sewerage, sewage treatment and pumping stations.

**ALPENCONSULT PLANUNGSGESELLSCHAFT mbH** A-9020 Klagenfurt, Hoffmannngasse 12, Austria, Tel: +43-4222/55-1-25, Telex: 42109 alpco a. Alpenconsult are a team of independent consulting engineers. In the water technology field Alpenconsult's activities embrace studies and investigation, planning and design, tender documents, building supervision and acceptance, personnel training, technical consultation and management.

**ANGLIAN WATER** Ambury Rd, Huntingdon, Cambridgeshire, PE18 6NZ, UK, Tel: +44-480-56181, Telex: 32175, Fax: +44-480-59784, Contact: Mr John McAngus. Anglian Water is one of the largest geographical water authorities in England and is keen to expand its overseas consulting activities.

**ANTWERP WATER CONSULTING** Mechelsesteenweg 64, Antwerp, B-2018, Belgium, Tel: +32-3-238-7830, Telex: 32139, Fax: +32-3-237-9766, Contact: Van Den Denrydt. An interdisciplinary partnership firm



# AGRAR- UND HYDROTECHNIK GMBH

Beratende Ingenieure Consulting Engineers Ingénieurs-Conseils Ingenieros Consultores

For almost 30 years AHT has been conducting studies, carrying out planning, construction supervision and management duties in specialized fields both at home and abroad. AHT's work is carried out primarily for governments, national and international development agencies and financial institutions.

The company's field of activities was greatly broadened by the founding or acquisition of affiliated companies two of which, GAF and AEW Plan, complement the activities of the mother company in the fields of remote sensing, water development, water use and treatment.

AHT and its affiliated firms now permanently employ over 300 specialists in all fields of engineering and water development.

## ACTIVITIES IN THE FIELDS OF WATER MANAGEMENT AND HYDRAULIC ENGINEERING

Hydrological and hydrogeological investigations; water management planning; flood protection; water supply for all purposes; water treatment; water well drilling; hydraulic engineering, irrigation and drainage; swamp reclamation; salinization control.

### AGRAR- UND HYDROTECHNIK GMBH

Consulting Engineers · Postfach 100132

Huyssenallee 66-68 · D-4300 Essen 1

Phone (0) 201-2016-0 · Telex 857557 aht d

Cable agrartech essen · Telefax (0) 201-2016-211

### Direct Lines — Regional Departments:

Europe/South America (0) 201-2016-222

North/West Africa 2016-220

East/South Africa 2016-223

Middle East/Asia 2016-250



ABFALL ENERGIE WASSER WASTE ENLHGY WATLH DECHLIS ENERGIE EAU

AEW Plan was chartered in 1983 by amalgamating Abwassertechnik GmbH (founded in 1960), Abfalltechnik GmbH (founded in 1962) and the energy sector of Schmidt & Reuter Ingenieurgesellschaft mbH & Co. KG (founded in 1964). The firm was acquired by Agrar- und Hydrotechnik GmbH in 1987 to complement the range of activities of the mother company in the water, sewerage and waste sectors.

### FIELDS OF ACTIVITY

AEW Plan specializes and integrates the field of Water Management, Water Supply and Waste Water Treatment to Energy and Waste because they are related with each other in many projects. Thus the solution of problems with an overlapping of different fields demands not only the optimization of the total system, but also the best design of details from engineering and economic points of view.

### AEW PLAN GMBH

Graeffstrasse 56

D-5000 Köln 30

Phone (0) 221-574022-0

Telex 8885295

Telefax (0) 221-5740-211



GAF was founded by AHT and two other partners in 1985 to complement the mother company's activities in remote sensing, especially in the fields of satellite digital image processing, and interpretation and analysis.

### FIELDS OF ACTIVITY

The services offered by GAF range from consultancy services in the field of practical application of remote-sensing data, interpretation methods, data gathering, on to selection and processing. GAF undertakes digital processing for standard image products and thematic image processing of remote-sensing data (NOAA, MSS, TM, SPOT, aerial photos, radar).

GAF has been appointed official representative of EOSAT which operates the LANDSAT system and can therefore guarantee direct and fast worldwide data survey.

### GESELLSCHAFT FÜR ANGEWANDTE FERNERKUNDUNG MBH (GAF)

Leonrodstrasse 68/II

D-8000 München 19

Phone (0) 89-188044

Telex 5218713 gafm d

Telefax (0) 89-1233148

## CONSULTANTS

providing services in drinking water supply and treatment, wastewater treatment, including consulting and expertise, feasibility studies, design and engineering, technical assistance, education and training.

**ASHACT** 11 Wycombe Rd, Prestwood, Great Missenden, Bucks, HP16 0NG, UK, Tel: +44-2406-6014, Fax: +44-2406-5395, Contact: Mr Sidwick. Ashact is an Environmental Management Consultancy working mainly in the fields of water, wastewater and solid wastes. The company is independent and it has extensive experience in the developing world.

**ASPINWALL & CO LTD** 5 Swan Hill Court, Shrewsbury, SY1 1NP, UK, Tel: +44-743-231391, Telex: 35447, Fax: +44-743-53267, Contact: Charles Levington. Aspinwall and Co is an independent professional company offering a comprehensive range of consultancy, research and planning services, covering the natural (including aquatic) and built environments.

**W S ATKINS AND PARTNERS** Woodcote Grove, Ashley Rd, Epsom, Surrey, KT18 5BW, UK, Tel: +44-3727-26140, Telex: 266701 AtkinsG, Fax: +44-3727-77328, Contact: Paul Jowers. Consulting services in water and public health engineering projects including water resources, hydrology, dams, water supply/distribution/treatment, leak control, sewerage, stormwater drainage, sewage treatment, effluent re-use, irrigation and ICA.

**ING BÜRO ASHAUER UND PARTNER GmbH** Alfred-Nobel-Strasse 24, Kerpen, 5014, West Germany, Tel: +49-2237-7011, Fax: +49-2237-61637, Contact: Dr Behruz Edalat. Our company has 24 years experience in the fields of geotechnics, hyrotechnics, environmental technics, waste and hazardous waste technology and geophysics. We undertake planning, complete conceptions and management through to complete turnkey projects.

**BABTIE SHAW & MORTON** 95 Bothwell St, Glasgow, G2 7HX, UK, Tel: +44-41-204-2511, Telex: 77202, Fax: +44-41-226-3109, Contact: Mr Brown. Resource studies, system analysis, hydrology, hydrogeology, geotechnical investigations, design and inspection of dams, treatment works, distribution systems, service reservoirs, sewage process design and treatment works, sewers, pollution control. Design and supervision of construction of water and public health works.

**BALFOURS** Yeoman House, 63 Croydon Rd, London, SE20 7TW, UK, Tel: +44-1-659-2221, Telex: 946448, Fax: +44-1-659-5702, Contact: Mr Race. Consulting engineers specialising in water treatment and supply, drainage and sewerage, treatment and disposal of sewage, solid and hazardous wastes, air pollution control, environmental impact assessment.

**BASSETT CONSULTING ENGINEERS** 70 Albert Rd, South Melbourne, Victoria, 3205, Australia, Tel: +61-3-699-2411, Telex: 32185, Fax: +61-3-690-5596. Specialists in mechanical, electrical and industrial engineering installations for commercial, institutional and industrial buildings, design, planning and implementation in many field, including pipelines, wastewater collec-

tion and treatment, water supply and distribution. International experience includes, Bangladesh, China, Nigeria, Indonesia and Brazil.

**RWF6BECK AND ASSOCIATES** Seattle, Washington, USA, +1-206-441-7500, Tel: +1-206-441-4962, Fax: 4990402. Services span the disciplines of civil, mechanical, electrical, sanitary and structural engineering, computer systems, economics, environmental sciences and construction management with the complete range of feasibility, planning, design, project and programme management, start up and operations assistance.

**BELCONSULTING N V** Oude Stationsstraat 144, Tiel, 8880, Belgium, Tel: +32-51-40-36-71, Telex: 81-728, Fax: +32-51-40-05-13. Environmental engineering: water and wastewater treatment, waste treatment, waste gas- and air treatment, environmental and safety audits. Energy: energy management of building groups, energy audits. Infrastructure: design of drains, roads and sewerage, land reclamation and improvement works. Hydraulic Engineering. Structural Engineering. Industrial facilities.

**BETECH N V** Vestinglaan 32-34, Mortsel, 2510, Belgium, Tel: +32-3-440-5930, Telex: 73290, Fax: +32-3-440-48-47, Contact: Mr Goossen. BETECH is an engineering company, providing services for water treatment and disposal projects. The scope of activities includes: feasibility studies, design and engineering and construction supervision.

**BHRA - THE FLUID ENGINEERING CENTRE** Cranfield, Bedford, MK43 0AJ, UK, Tel: +44-234-750422, Telex: 825059, Fax: +44-234-750074, Contact: Dorothy Thompson. Physical and computer modelling to prove and optimise the hydraulic design of structures for: irrigation, water supply, reaeration, sewage and pollution control, drainage, flood control, energy dissipation and leisure uses.

**BINGHAM COTTERELL LTD** Scholes Hall, Scholes Lane, St Helens, WA10 3PA, UK, Tel: +44-744-55151, Telex: 628607 BNG BLAG, Fax: +44-744-612011, Contact: Mr Campbell-Little. Civil and structural engineering consultants, (water supply and treatment, sewage treatment, trade and industrial waste treatment, flood alleviation, river bank and flood protection).

**BINNIE & PARTNERS (HONG KONG)** 51st Floor, Hopewell Centre, 183 Queens Rd East, Hong Kong, Tel: +852-5-292961, Telex: 74679, Fax: +852-5-272560. Specialists in all aspects of water resources, supply and treatment with experience in Brunei, China, Hong Kong, Macau, South Korea and Taiwan.

**BINNIE & PARTNERS** Grosvenor House, 65 London Rd, Redhill, Surrey, RH1 1LQ, UK, Tel: +44-737-774155, Telex: 24552, Fax: +44-737-72767, Contact: Rosalind Coverley. Provides comprehensive worldwide consulting engineering services in water resource development including water and waste water treatment, low cost sanitation, pollution control, environmental protection, irrigation and power, technology transfer.

**BIOTECH INDUSTRIAL PRODUCTS LTD** 3 Blen-

# Advice on water management across the world



Thames Water is a leading U.K. water undertaking of international stature. It manages water and sewage services in an area of 5000 square miles, serving the daily requirements of many millions of people.

Thames Water invested around £6.6 million in 1987/88 in research and development and has invested in the application of advanced technology.

Thames Water has been active internationally since 1979.

Since 1986 the overseas business has been handled by Thames Water International. It can assist with technical and scientific advice on the following:



- Water quality
- Treatment
- Distribution
- Leakage control
- Flood protection
- Pollution control
- Land drainage
- Sewerage
- Sewage treatment
- Sludge disposal
- Institutional development
- Finance
- Personnel
- Computing
- Resource planning

Training of staff from overseas is a significant part of Thames Water International's work. Formal courses are presented in the UK and overseas and work attachments are arranged in the UK.

For further information contact Thames Water International, Nugent House, Vastern Road, Reading RG1 8DB UK. Tel +44 734 593353. Fax +44 734 593747.

**Advice on water management across the world.**

## CONSULTANTS

---

heim road, Sherwell, Plymouth, Devon, PL4 8LJ, UK, Tel: +44-752-262652, Telex: 45795, Fax: +44-752-261664, Contact: Dr Jones. Design and consultancy on water and waste management, supplier of DBC plus B10 Augmentation Media (Flow Laboratories Inc) and Osprey Oil Spill Recovery Media.

**BIRWELCO LTD** Mucklow House, Mucklow Hill, Halesowen, W Midlands, B62 8DG, UK, Tel: +44-21-550-4777, Telex: 337027, Fax: +44-21-550-7946, Contact: Malcolm Ward. Birwelco, part of Compagnie Generale des Eaux is a leading international contractor and consultancy for all water treatment applications. The company executes multimillion pound turnkey contracts and has strong technical resources especially in chemical and control engineering.

**BKH CONSULTING ENGINEERS (BONGAERTS KUYPER AND HUISWAARD)** P O Box 93224, The Hague, 2509 AE, The Netherlands, Tel: +31-70-471414, Telex: 32070, Fax: +31-70-45-89-03, Contact: Mr S Mederhorst. BKH Consulting Engineers is an independent firm, established in 1918. The staff comprises approximately 125 professionals in the head office and a total of 625 including associated offices abroad, mainly in the field of civil, sanitary and environmental engineering. Projects are carried out both in the Netherlands and abroad. Fields of specialization: water supply, sanitary engineering and environmental engineering. Services include studies, design, planning supervision, contract management, institutional support and training. International experience: Bangladesh, India, Indonesia, Japan, Kenya, Malawi, Malaysia, Pakistan.

**BLACK & VEATCH INTERNATIONAL** PO Box 8405, 1500 Meadow Lake Parkway, Kansas City, Missouri, 64114, USA, Tel: +1-913-339-8700, Telex: 42523, Fax: +1-913-339-2060. One of the oldest, largest and most diversified engineering-architectural organizations in the USA with experience throughout the world. Extensive management experience and diversified capabilities enable the company to assume total responsibility for a wide range of projects of any size the world over.

**BOND ASSOCIATES** 150 Willard Avenue, Newington, CT, 06111, USA, Tel: +1-203-233-5109, Fax: +1-203-233-1268, Contact: Thomas E Bond. Bond Associates are professional engineers specializing in water and wastewater treatment, its distribution or disposal by percolation or irrigation. They have done work in Africa, Central America, Asia, the Caribbean and USA.

**BRIANT & HARMAN LTD** Black Swan Yard, 73-77 Bermondsey St, London, SE1 3RX, UK, Tel: +44-1-407-1041-2, Telex: 912881, Fax: +44-1-357-6544, Contact: Mr Pope. Consulting and analytical chemists. Analyses of water and effluents, assessment of problems and recommendations for treatment, negotiation on behalf of clients with authorities and contractors, limited contract research.

**BULLEN & PARTNERS** 188 London Rd, Croydon, CR9 1PT, UK, Tel: +44-1-686-2622, Telex: 8811965, Fax: +44-681-2282, Contact: Mr Williams. Consulting engineers - undertake design of water supply and drainage products.

**CLOTTI AND ASSOCIATES** Via del Fiume 14, Rome, 00186, Italy, Tel: +39-6-3613341, Telex: 611113, Fax: +39-6-3607298, Contact: Mr M Marotta. Consulting engineering firm operating in the field of water resources development and management, large hydraulic works, hydroagriculture infrastructure, transport, building industry and urban infrastructure and environment engineering.

**CAMERON MCNAMARA PTY LTD** 299 Coronation Drive, Milton, Queensland, Australia, Tel: +61-7-368-9228, Fax: 41529. Broad-based organization with multi-disciplinary skills in engineering, planning, economics, management and environmental and computer services. Varied fields of specialization include fisheries, irrigation and flood control, dams, water storage and hydropower, drainage, wastewater, water supply and distribution.

**CAMP DRESSER & MCKEE INTERNATIONAL INC** One Center Plaza, Boston, Massachusetts, 02108, USA, Tel: +1-617-742-5151, Telex: 94-0120, Fax: +1-617-227-3995. Ranks among the largest consulting firms in the environmental field. Worldwide experience ranges from complete engineering services for water supply and sewerage for urban areas to rural sanitation for developing countries.

**CFG (COMPANGNIE FRANCAISE DE GEOTHERMIE)** B P 6429, Orleans, Cedex 2, 45064, France, Tel: +33-38-64-3991, Telex: 782343, Fax: +33-38-64-32-83, Contact: Monsieur Tonnon. Consulting engineers at all stages from feasibility studies to construction, environmental scientists, geotechnical consultants, rock and soil consultants.

**CHUO KAIHATSU CORPORATION INTERNATIONAL** 3-12-3 Nishi-Waseda, Shinjuku-Ku, Tokyo, 160, Japan, Tel: +81-3-207-1711, Telex: 232-4365, Fax: +81-3-732-3625. Wide international experience in many aspects of the water industry including fisheries, irrigation, flood control etc.

**CH2M HILL INTERNATIONAL** 2020 SW 4th Avenue, Portland, Oregon, USA, Tel: +1-503-224-9190, Telex: 474-2047, Contact: Otto Vydra. CH2M Hill International has been supplying services to public and private clients in about 50 countries worldwide. The international operation is backed by a 3,000-employee firm, one of the largest in the USA.

**CLAYTON BOSTOCK HILL & RIGBY LTD** 288 Windsor St, Birmingham, B7 4DW, UK, Tel: +44-21-359-5951, Telex: 337273, Fax: +44-21-3597606, Contact: Mr Colin Appleyard. Provide analytical services and consulting chemical engineering services related to water and waste water plant design, including process design, troubleshooting, environmental impact appraisal, contaminated land assessments, air emission monitoring control and associated environmental services.

**CLINTON BOGERT ASSOCIATES** 2125 Center Avenue, Fort Lee, NJ, 07024, USA, Tel: +1-201-944-1676, Fax: +1-201-944-6914, Contact: Toni Viscio. Clinton Bogert Associates, Consulting Engineers, have been



# Global Strategies for Safe Drinking Water

Water is the common denominator of life on earth. The development, protection, care, and conservation of safe drinking water supplies are paramount concerns of societies worldwide.

CDM has been solving urgent water supply problems in developing nations through four decades of expanding practice. We have completed projects in more than 60 countries on six continents, including landmark programs that have advanced the state-of-the-art of engineering technology.

To meet client demands, our strategies are often complex. But our goal is always simple: to answer the basic human need for water.

**CDM** *environmental engineers, scientists,  
planners, & management consultants*

**CAMP DRESSER & MCKEE INTERNATIONAL INC.**

One Cambridge Center  
Cambridge, Massachusetts 02142  
617 621-8181, Fax: 617 577-7504, Telex: 211967

**Camp Dresser & McKee International Inc. is a worldwide provider of environmental engineering, scientific, planning, and management services. We focus our professional activities on the management of water resources, hazardous and solid wastes, wastewater, infrastructure, and environmental systems for industry and government.**



epd

## Water Resource Development

- Economic analysis
- Environmental impact
- Surface water conservation
- Irrigation & agriculture
- Dams, reservoirs & flood control
- Hydroelectric power
- Wastewater treatment
- Sewerage
- Desalination

EPD  
Balfour Beatty  
Group  
Water  
Resource  
Development  
Company  
Limited

## The WHO? and WHAT? of Water Resource Development

- Q. **WHO** is reconstructing a sizeable part of the wastewater system in the city of CAIRO?
- A. Balfour Beatty (as a member of the Anglo-Egyptian Wastewater consortium).
- Q. **WHAT** other sorts of water management projects is Balfour Beatty involved with?
- A. Hydroelectric installations, like Mrica in Indonesia and Samanalawewa in Sri Lanka, and irrigation projects such as Balanga Dam in Nigeria.
- Q. **WHAT** sort of track record has the Company in water resource development?
- A. Balfour Beatty's engineering workforce have long been involved in overseas projects. In Kenya, for example, the successive Seven Forks hydroelectric developments over 60 years originally started with a safari, through unmapped territory, by a Balfour Beatty engineer. The firm **EPD Consultants** was created some twenty years ago from this same multi-disciplinary workforce.
- Q. **WHAT** projects have **EPD Consultants** been tackling recently?
- A. They have been carrying out engineering work on the major projects already referred to in Indonesia, Sri Lanka and Nigeria. The Company also has considerable project management capability, as illustrated by a substantial management and engineering contract to provide new water supplies to three towns in Plateau State, Nigeria.
- Q. **WHAT** about the rehabilitation of run-down systems?
- A. The Company has undertaken the rehabilitation of a variety of long-service installations overseas. Such cost-effective refurbishment and modification projects can enable old systems to match up to present day and future requirements.
- Q. **WHAT** then, is there so special about **EPD's** background?
- A. In addition to an in-house capability to undertake hydrological surveys and geomorphological studies, the full representation of all relevant civil, mechanical and electrical disciplines within the one organisation is a significant advantage in project implementation. Combined with the backing of the **Balfour Beatty Group** and its parent, **BICC plc**, this makes participation in complex projects, where time is of the essence, and where the business-like management of risk is a critical ingredient of successful performance, a speciality of **EPD Consultants**.



## CONSULTANTS

assisting various agencies and communities in developing and upgrading water supplies, treatment facilities and distribution systems since 1924.

**BRIAN COLQUHOUN & PARTNERS** 22 Upper Grosvenor St, London, W1X 0AP, UK, Tel: +44-1-491-4864, Telex: 21179, Fax: +44-1-409-3505, Contact: Mr R H Pilcher. The multi-disciplinary consultancy undertakes feasibility studies, detailed engineering design, preparation of contract documents, evaluation of tenders and supervision of construction for all aspects of water supply and sanitation engineering.

**JOHN CONNELL GROUP** 60 Albert Rd, South Melbourne, Victoria, Australia, Tel: +61-3-697-8333, Telex: 32071, Fax: +61-3-697-8444. Civil and structural engineering for transport, environment and industry design, planning, earth sciences and implementation in land and water feasibility studies, drainage, wastewater, water supply and distribution.

**CONSULTCO PROJEKTIERUNG UND KOORDINATION VON BAUTEN UND ANLAGEN GmbH** A-1030 Wien, Zaunergasse 4, Austria, Tel: +43-222/75-21-65, Telex: +132277. The engineers and technicians of Consultco plan installations and equipment for water supply and sewage disposal purposes, including all the necessary infrastructure. Consultco also undertake to supervise the installation and operation of the plants.

**CONSULTING ENGINEERING SERVICES (INDIA) PRIVATE LTD** 57 Nehru Place (5th Floor), New Delhi, 110 019, India, Tel: +91-641-5284/5264, Fax: 31-65844. Independent consultancy organisation providing planning, architectural and engineering services in multi-disciplinary fields. Wide experience in water resources, irrigation, flood control and drainage etc.

**COODE BLIZARD CONSULTING ENGINEERS** Royal Oak House, Brighton Rd, Purley, Surrey, CR2 2BG, UK, Tel: +44-1-668-0711, Telex: 947020 Coode G, Fax: +44-1-668-4216, Contact: Margaret Brown. The Coode Blizard Group, consulting engineers, provide consulting services for investigation, design and construction of water supply, public health and water resource development projects in developing countries worldwide.

**COODE BLIZARD** Telford House, Hulse Rd, Southampton, SO9 3JQ, UK, Tel: +44-703-228455, Telex: 47338, Fax: +44-703-639665, Contact: I. M. Hughes. Full consultancy services offered in: irrigation, drainage and flood alleviation, sewerage, wastewater and trade effluent treatment, water supply, treatment and distribution, mechanical/electrical services, ports, harbours and coast protection.

**COOPER MACDONALD & PARTNERS** Loxford House, East St, Epsom, Surrey, KT17 1HC, UK, Tel: +44-3727-28511, Telex: 928439, Fax: +44-3727-42129, Contact: Mr Manning. From UK and overseas offices a full consulting service is offered in most branches of civil engineering including water supply and distribution, sewerage and sewage disposal irrigation.

**COSTAIN INTERNATIONAL LTD** Costain House,

West St, Woking, Surrey, GU21 1EA, UK, Tel: +44-4862-27911, Telex: 859371, Fax: +44-4862-21351, Contact: Mr Robinshaw. Site investigation, land and marine geological and geotechnical consulting, soils and materials testing, grouting, mineral and water exploration drilling.

**CROOKS MITCHELL PEACOCK STEWART PTY LTD** 2 Thomas St, Chatswood, NSW, W, 2067, Tel: Australia, Telex: +61-2-411-6230, Fax: +61-2-412-9999. AA 120557 Engineering and management services for industrial, resource development and infrastructure projects. Work undertaken ranges from pre-feasibility studies, through to project implementation and beyond to commissioning and plant maintenance. Fields of specialization include drainage, pipelines, wastewater and water supply.

**C3 INTERNATIONAL** 2019 W County Rd, St Paul, MN, 55113, USA, Tel: +1-612-631-8082, Telex: 298414, Fax: +1-612-647-1870, Contact: Tom Cartwright. C3 International is a consulting engineering company specializing in water purification, waste treatment, food and chemical process. Our areas of expertise are micro filtration, ultra-filtration, reverse osmosis, electro dialysis, absorption and ion exchange.

**DAMES & MOORE** Suite 3500, 445 South Figueroa St, Los Angeles, CA, 90071-1665, USA, Tel: +1-213-683-1560, Telex: 910-380-3067. Specialists in engineering and applied earth sciences, planning, economics and environmental studies. International experience in groundwater studies, water supply and wastewater treatment studies. Specialize in most aspects of the water industry.

**DAMES & MOORE** Booth House, 15-17 Church St, Twickenham, TW1 3NJ, UK, Tel: +44-1-891-6161, Telex: 929861, Fax: +44-1-891-447, Contact: Suzanne Somers. International consultants in environmental and applied earth sciences, planning and economics, with offices worldwide. Services include investigation and management of water resources, hazardous wastes, pollution control, geotechnical and structural engineering, civil design etc.

**DANISH AQUACULTURE INSTITUTE** 11 Agern Alle, Horsholm, DK, 2970, Denmark, Tel: +45-42-57-28-11, Fax: +45-42-76-66-19. The Danish Aquaculture Institute (DAI) is an autonomous nonprofit institution affiliated to the Danish Academy of Technical Sciences. The DAI offers consultancy services on all aspects of aquaculture, and amongst its clients, are private fish farms, local authorities and industrial companies both in Denmark and abroad. The institute consists of three divisions, the head office situated north of Copenhagen, an experimental fish farm in conjunction with a power plant in the southern part of Jutland and a Far East Pacific Division in Singapore.

**DANUBE HYDRO AUSTRIA** P O Box 88, Parkring 12, Vienna, A-1011, Austria, Tel: +43-222-515-38-0, Telex: 111-366 do 1 a, Fax: +43-1-515-38-3900. Consultancy services like preliminary investigations, feasibility studies, engineering design and cost estimates, tendering and procurement, detailed drawings, supervision and

## CONSULTANTS

coordination of construction and erection, commissioning, operation, training,

**DATA WEST CORPORATION** Box 2064, Durango, CO, 81302, USA, Tel: +1-303-259-2330, Fax: +1-303-247-1454, Contact: David Fountain. Computer software for utility billing and accounting management. **BILLMASTER** is an advanced billing and information system.

**DHV CONSULTANTS ENGINEERS** P O Box 85, Amersfoort, 3800 AB, The Netherlands, Tel: +31-33-6891-11, Telex: 79348, Fax: +31-33-615047, Contact: Mr Wagenaar. Complete service in research, surveying, engineering, project management and supervision and financial engineering for irrigation, water treatment, sewerage, sanitation, drinking water and process water projects.

**DINENNA IRRIGATION** 3235 Pine Valley Drive, Sarasota, Florida, 34239, USA, Tel: +1-813-924-8963, Fax: +1-813-644-9794, Contact: Frank J Dinenna. Irrigation specialist dealing in the service as designer, consultant and supervisor of irrigation systems for golf courses, playing fields and landscaping of commercial hotels. Also designs and builds drip and mist systems for agriculture nurseries. Well versed in all irrigation components.

**DORSCH CONSULT INGENIERGESELLSCHAFT mbH** Hansastrasse 20, POB 210243, Muenchen 21, München, D-8000, West Germany, Tel: +49-89-57970, Telex: 5212862, Fax: +49-89-5797-223, Contact: Dr Werner. Complete consultancy service for all aspects of water supply treatment and hydropower.

**DUNN BURT AND PARTNER** Thames House 58, Southwark Bridge Rd, London, SE1 0AS, UK, Tel: +44-1-620-1388, Fax: +44-1-620-1481, Contact: Mr Millex. Civil, structural, claims and water engineering consultancy.

**DUNN GEOSCIENCE CORPORATION** 12 Metro Park Rd, Albany, NY, 12205, USA, Tel: +1-518-458-1313, Fax: +1-518-458-2472, Contact: Mr Clark. Consulting hydrologists and geologists in the field of ground water development, analysis, polluted water cleaning, contaminate movement and re-mediation studies.

**EASTERN IRRIGATION CONSULTANTS INC** 13229 Ronehill Drive, Beltsville, Maryland, 20705, USA, Tel: +1-301-572-7674, Fax: +1-301-572-5306, Contact: Brendan E Lynch. Boston office: 12 Pine St, Pepperell, Mass 01463. Brian E Vinchesi Irrigation consulting for: residential, estate, commercial, agricultural, golf and waste water. Seminars, water management, master planning of irrigation systems for staged development.

**ENGINEERING & POWER DEVELOPMENT CONSULTANTS LTD** Marlowe House-Station Rd, Sidcup, Kent, DA15 7AU, UK, Tel: +44-1-300-3355, Telex: 25588, Fax: +44-1-300-5735. EPD Consultants have extensive international experience in civil, electrical and mechanical engineering for water management projects. The company undertakes regional water resources development studies, embracing all aspects of water resource utilisation. Current engineering assignments range from

minihydro power developments and local water supply and treatment schemes to major multipurpose installations, catering for long-term economic development requirements.

**ESPEY HUSTON AND ASSOCIATES** PO Box 519, Austin, Texas, 78767, USA, Tel: +1-512-327-6840, Telex: 1561212, Fax: +1-512-327-6453, Contact: Ms Barker. A full service environmental and engineering consulting firm specializing in all areas of water related services, with offices throughout the USA and in the UK.

**FERGUSON & MCILVEEN** Beechill House, Beechill Rd, Belfast, BT8 4RP, N Ireland, Tel: +44-232-705111, Fax: +44-232-795651, Contact: Mr Perrin. The practice's experience covers all aspects of public health engineering and in particular the design of impounding dams, reservoir safety inspections and leakage detection and control in water supply systems.

**GERAGHTY & MILLER INC** 7 Atlantic St, Hackensack, NJ, 07601, USA, Tel: +1-201-646-1400, Fax: +1-516-249-7610, Contact: Maureen McPartland. Services address all aspects of groundwater, including resource development, supply and management, contamination investigations, monitoring, closure plans, contamination cleanup/containment, permits, and expert testimony.

**GROVE CONSULTANTS LTD** 26 Hammersmith Grove, London, W6 7EN, UK, Tel: +44-1-846-3272, Telex: 22436, Fax: +44-1-748-0076, Contact: Mr Biddle. A multidiscipline consultancy for survey, civil, structural and infra-structure engineering, also town planning and architecture.

**HAISTE GROUP LTD** Newton House, Newton Rd, Leeds, LS7 4DN, UK, Tel: +44-532-620000, Telex: 557131, Fax: +44-532-620737. Established in 1920, the company has gained extensive experience in many fields of civil engineering - water supply, sewerage, liquid and solid waste treatment and disposal, harbour works, jetties, coastal defences and land drainage.

**HALDERMAN ENGINEERING** P O Box 12397, Tucson, AZ, 85732, USA, Tel: +1-602-886-7449, Contact: Allan D Halderman. Planning, design, evaluation and management of onfarm irrigation systems in arid climates. Water requirements, water supply, pumping, storage, conveyance, measurement and application with surface, sprinkler, bubbler and drip systems.

**HARZA ENGINEERING COMPANY** 150 South Wacker Drive, Chicago, Illinois, 60606-4288, USA, Tel: +1-312-855-7000, Fax: +1-312-236-8010, Contact: Mr Jim Trawinski. Full construction and architectural engineering service, project development for dams, hydro-electric power, agricultural development (especially irrigation and drainage). Specialists in the management of waste including hazardous waste.

**CHARLES HASWELL AND PARTNERS** 99 Great Russell St, London, WC1B 3LA, UK, Tel: +44-1-580-2412, Telex: 299544, Fax: +44-1-631-4602, Contact: Mr Hinchliffe. Charles Haswell & Partners are international consulting engineers offering planning, engineering and project management services for a wide range of water

## **INTERNATIONAL LABORATORY DESIGN AND DEVELOPMENT SERVICES**

---

**COMPLETE ASSISTANCE IN PLANNING,  
DESIGNING, OUTFITTING, STAFFING,  
TRAINING, MANAGING AND OPERATING,  
A LABORATORY, SMALL OR LARGE,  
MOBILE OR PERMANENT.**

---

**GLOBAL RESOURCE PLANNING, INC.  
P.O. BOX 149127-ORLANDO, FL 32814-USA  
PHONE (407) 896-6645 FAX (407) 898-6588  
A WHOLLY OWNED SUBSIDIARY OF ORLANDO  
LABORATORIES, INC.**

## **INTERNATIONAL ENVIRONMENTAL ANALYTICAL LABORATORY SERVICES**

---

**ENVIRONMENTAL AUDITS-CONSULTING**

---

**ANALYSIS OF WATER AND SOIL FOR:  
VOLATILE ORGANICS, PESTICIDES, PCB'S,  
SEMIVOLATILE ORGANICS, HERBICIDES,  
METALS, CYANIDE, PHENOLS, RADON.**

---

**ORLANDO LABORATORIES, INC.  
P.O. BOX 149127-ORLANDO, FL 32814-USA  
PHONE: (407) 898-6588**

## CONSULTANTS

supply and public health engineering projects.

**HEAP LAVERACK & PARTNERS** 44 Wallington Square, Wallington, Surrey, SM6 8RY, UK, Tel: +44-1-647-1025, Telex: 265871, Fax: +44-1-669-0713, Contact: Mrs Campbell. Consulting and inspecting engineers, electrical and mechanical plant, instrumentation, control systems, telecommunications and telemetry. Computer and plc software, water treatment and distribution.

**HOWARD HUMPHREYS & PARTNERS** Thorncroft Manor, Dorking Rd, Leatherhead, Surrey, KT22 8JB, UK, Tel: +44-372-376190, Telex: 929333, Fax: +44-372-377605, Contact: Jean Harwood. Established in 1899 with a present staff of 500, this international consulting practice specialises in water supply, pollution control, transportation and structural development.

**SIR HERBERT HUMPHRIES & MCDONALD** Rookery Park, Kingsbury Rd, Erdington, Birmingham, B24 9SF, UK, Tel: +44-21-377-6515, Fax: +44-21-377-6516, Contact: Ms Masefield. Consulting engineers specialising in water supply, sewerage and sewage treatment.

**HYDRAULIC MODELS LTD** Hawksworth Rd, Horsforth, Leeds, LS18 4JP, UK, Tel: +44-532-581613, Fax: +44-532-588163, Contact: Brian Smith. An independent company specialising in the use of scale models to develop and test hydraulic structures such as sewage treatment works. Pumping stations, spillways, storm overflows and other associated structures.

**I M E S LTD** Marring Hill, Ramsbury, Wilts, SN8 2HE, UK, Tel: +44-672-20412, Telex: 449203, Fax: +44-672-20053, Contact: Mr Keleher. Consulting, design and installation for water supply, water treatment, sewage treatment, pumping, distribution and collection.

**ILF CONSULTING ENGINEERS** A-6020 Innsbruck, Framsweg 16, Austria, Tel: +43-5222/63-3-33, Telex: +53733 laibk a. Special activities of ILF include water management studies, long-distance water pipelines with pumping stations, reservoirs and auxiliary facilities, water supply, water treatment, sewage clarification and sewage disposal.

**INTERAQUA VERFAHRENSTECHNIK** A-1070 Wien, Kirchengasse 39, Austria, Tel: +43-222/93-81-26, Telex: +135830 iaqua a, Contact: Walter Raxendorfer. Interaqua are specialists in water treatment and waste water purification. They offer consultation, planning, delivery and servicing of water-handling equipment and plants of different sizes for various purified water grades and automatic or manual operation. Fields of use: treatment of boiler feed water for power stations and industry, condensate of conventional and nuclear power plants, high-purity water for hospitals and electronics industry, drinking and service water, heating, cooling circuit and moistening water, industrial waste water (recycling), brewing and process water, etc.

**JAMES AND PARTNER** 6 Lower Grosvenor Place, London, SW1W 0EW, UK, Tel: +44-1-828-7733, Telex: 917864 RTJLON G, Fax: +44-1-828-4148, Contact: John Archer. Civil and structural engineers with specialist

design experience in trade effluent treatment works, drainage systems, gravity and pumped sewage schemes, pipeline and associated structures. Also experience in total project management.

**JOHNSTON IRRIGATION INC** Post Office Box 2076, Fort Pierce, FL, 34954, USA, Tel: +1-407-466-4500, Fax: +1-407-466-6081, Contact: Matthew M Johnston. Johnston Irrigation serves the US and the international marketplace with complete irrigation services including overhead and drip irrigation systems, engineering/design, project management/installation, wholesale materials, pump design, and consulting. Johnston Irrigation is one of the largest agricultural irrigation contracting companies in the United States.

**KELLER-BLIESNER ENGINEERING** 95 W 1005 #320, Logan, UT, 84321, USA, Tel: +1-801-753-5651, Fax: +1-801-753-6139, Contact: Ron Bliesner. Keller-Bliesner Engineering is a consulting engineering company specializing in irrigation and agricultural development. Our specialties include: computerized project development analysis from a multi-disciplined view point, emphasizing optimization of nearly any set of goals, vast experience in advanced technology irrigation, evaluation of existing projects and second opinion consulting and project reviews.

**KENNEDY & DONKIN SYSTEMS CONTROL LTD** Chatsworth House, 19 Lever St, Manchester, M1 3LT, UK, Tel: +44-61-228-6282, Telex: 668972, Fax: +44-61-228-3031, Contact: Mr Viney. Kennedy & Donkin Systems Control provides consulting services to the water industry on a worldwide basis. Services range from feasibility/planning studies through procurement to full implementation of telemetry, SCADA and communications schemes.

**KILLAM ASSOCIATES** 27 Bleeker St, Millburn, New Jersey, 07041, USA, Tel: +1-201-379-3400, Fax: +1-201-376-1072, Contact: Eugene J DeStefano. Activities: civil, sanitary and environmental planning, design and management services, domestic and industrial wastewater (collection, treatment, disposal, plant operations and maintenance, I/I studies), water resources (supply, treatment, transmission).

**KISO-JIBAN CONSULTANTS CO LTD** Mimura Building, Kanda, Jimbo-Cho 1/34, Chiyoda-Ku, Tokyo, Japan, Tel: +81-3294-7261, Telex: J28457, Fax: +81-3-292-8010. Comprehensive capabilities in the field of geotechnical engineering - subsurface investigation, soil and rock mechanics and groundwater management. International experience in the water fields of agriculture and public utilities.

**I KRÜGER AS** 363 Gladsaxevej, Søborg, DK 2860, Denmark, Tel: +45-1690222, Telex: 27033, Fax: +45-1690806, Contact: Birdit Hansen. I Krüger AS are consulting engineers and contractors in the fields of water resources development, water supply, sanitation and sewage treatment.

**KRTA LTD** Quay Tower, 29 Customs St West, Auckland, New Zealand, Tel: +64-9-795-700, Telex: NZ 21385, Fax: +64-9-393-876. Specialist services in all the major

## CONSULTANTS

exploration and development disciplines. Specialist project skills also include water supply and sanitation. Worldwide experience.

**KTA-TATOR INC** 115 Technology Drive, Pittsburgh, PA, 15275, USA, Tel: +1-412-788-1300, Telex: 510697333, Fax: +1-412-788-1306, Contact: Kurt Smith. KTA consulting services provide assistance in coating specifications, material selection and failure analysis.

**INGENIEURBUÜRO PROF DR ERWIN LANG A-2700** Wiener Neustadt, Wiener Strasse 12, Austria, Tel: +43-2622/33-76/45-07. Engaged in planning and calculation, but not installation work. There are two main areas of activity. The first, water management and hydraulic engineering. The second, domestic water supply and disposal, covers sewer and sewage treatment plant construction (mechanical and biological), wells for water supply and water treatment plants.

**LAHMEYER INTERNATIONAL GMBH POB 710** 651 Lahmeyer Strasse 22, Frankfurt/Main 71, D-6000, West Germany, Tel: +49-69-6677-0, Telex: 0413-478 li d, Fax: +49-69-6677-572. Lahmeyer International is your worldwide partner in developing water and offers all required consulting and planning services. Water resources utilization, environmental engineering and rural development form only part of a comprehensive scope of engineering services for the energy, water, environmental and transport sectors. Interdisciplinary co-operation between departments enables the company to provide the appropriate solutions to challenging problems of different magnitudes under a single responsibility.

**LAVALIN INTERNATIONAL INC 1110** Dorchester Boulevard West, Montreal, Quebec, Canada, Tel: +1-514-876-4455, Telex: 055-61250. Complete engineering and consulting services in many fields of specialization including fisheries, dams, drainage, pipelines, river regulation and control, water supply and distribution, wastewater and desalination.

**LOGICA 64** Newman St, London, W1A 4SE, UK, Tel: +44-1-637-9111, Telex: 27200, Fax: +44-1-637-8229, Contact: Margret Spooner. Logica has worked in the water industry for many years contributing to improved methods of water management. Services offered include consultancy, systems specification and design, project management, software and electronics engineering and systems supply.

**M MCDOWELL CO-PARTNERSHIP** Bailey House 215, Barnett Wood Lane, Ashted, Surrey, KT21 2DH, UK, Tel: +44-372-277771, Fax: +44-372-276668, Contact: Mr Cryer. Consulting civil and structural engineers and surveyors specialising in sewerage and drainage, sewage treatment, water supply, infrastructure design, building drainage and manhole location surveys.

**MASON PITTENDRIGH CONSULTING ENGINEERS** Norham House, 12 New Bridge St, Newcastle-upon-Tyne, NE1 8AR, UK, Tel: +44-91-232-4383, Telex: 537681/2/3 ALWRLD G FOR MPI., Fax: +44-91-261-0986, Contact: Mr Williams. Consultants for civil, mechanical and electrical engineering associated

with sewage treatment, water and effluent treatment.

**MAUNSELL CONSULTANTS ASIA 1** Kowloon Park Drive, Kowloon, Hong Kong, Tel: +852-3-695-251, Telex: 44458, Fax: +852-3-7224070. Established to provide civil engineering consultancy throughout South East Asia. Predominantly engaged in civil and structural engineering and offers a full consultancy service for all projects - irrigation and flood control, river regulation, drainage, wastewater, water supply and water distribution.

**MELLING AND ARDEN 451** Lower Broughton Rd, Salford, M7 9FX, UK, Tel: +44-61-792-1822, Contact: Mr Jones. Public analysts and consulting chemists. Examination of food, drugs, waters, sewage and trade effluents.

**MERALCO INDUSTRIAL ENGINEERING SERVICES CORP** 3rd-5th Floors, TSG Building, Meralco Cmpo, Ortigas Ave, Pasig, MM, Tel: Philippines, Fax: +63-721-9951. 14730 Broad-based operations including most aspects of water distribution and use. Services include, design planning, implementation, construction management and supervision, purchasing and project management.

**METCALF & EDDY INTERNATIONAL INC PO Box** 4043, Woburn, Massachusetts, 01888-4043, USA, Tel: +1-617-246-5200, Telex: 6817067, Fax: +1-617-245-6293. Full range of services from planning and financing and design and construction to operations and maintenance. The firm has worked to provide cost-effective, technologically sound solutions for water, wastewater, solid waste and hazardous waste management, natural resource utilization and the infrastructure crucial to industrial and agricultural development.

**JAMES M MONTGOMERY CONSULTING ENGINEERS INC PO Box** 7009, 250 North Madison Avenue, Pasadena, California, 91109/7009, USA, Tel: +1-818-796-9141. Recognised internationally for expertise and unique capabilities in water and wastewater engineering. Offer a complete range of services including master plans and feasibility studies, detailed design, construction management services and facilities start-up and operation. Experience in aquaculture.

**MORGAN MOORE ENGINEERING LTD** Pennine House, 48 West St, Middlesborough, Cleveland, TS2 1LZ, UK, Tel: +44-642-218171, Telex: 587362, Fax: +44-642-224215, Contact: Gordon Joyce. Morgan Moore Engineering Limited comprises of a team of highly specialised people providing a comprehensive service to the water industry in the disciplines of instrument, electrical and environmental engineering. The company has a full turnkey capability and specialises in the manufacture of full microprocessor based control and monitoring systems, telemetry, environmental and water quality products and monitoring services.

**MORRISON-KNUDSEN ENGINEERS INC 180** Howard St, San Francisco, CA, 94105, USA, Tel: +1-415-442-7300, Telex: (WU1)677058/(ITT)470040/(RCA)278362/(WUD)34376. Full-service engineering,

## CONSULTANTS

procurement and construction management company offering single-source responsibility for the design and management of large and small projects worldwide. The water resources field is a major aspect of the company's expertise.

**MOTOR COLUMBUS CONSULTING ENGINEERS** INC Parkstrasse 27, Baden, CH-5401, Switzerland, Tel: +41-56-20-11-21, Telex: 825-045, Fax: +41-56-22-1828, Contact: Mr Fentzal. Water related fields are: Resources inventories and master planning, water resources development and management, hydraulic engineering, water power and dams, sanitary engineering, environmental impact assessment and risk analysis.

**MOUCHEL AND PARTNERS** West Hall, Parris Rd, West Byfleet, Weybridge, KT14 6EZ, UK, Tel: +44-9323-41155, Telex: 261309, Fax: +44-9323-40673, Contact: Mr Knight. Civil engineering consultants covering all aspects of public health engineering including water source development, water distribution, water treatment, sewerage and sewage treatment.

**NATIONAL ENGINEERING LABORATORY** East Kilbride, Glasgow, G75 0QU, UK, Tel: +44-3552-20222, Telex: 777888, Fax: +44-3552-36930, Contact: Mr Leishman. NEL holds the UK national standard for flow measurement and is also an international centre for the testing/approval of water turndustry with expertise and facilities in fluid mechanics, flow measurement, manufacturing technology, materials, stress analysis, reliability and control applied to flow-meters, pumps, turbines, valves and other pipeline components.

**NCL STEWART SCOTT LTD** 192-8 Vauxhall Bridge Rd, London, SW1V 1DX, UK, Tel: +44-1-834-5781, Telex: 91750, Fax: +44-1-630-6971, Contact: Mr Jennings. Independent consulting engineers engaged in design and construction supervision of civil/structural work for reservoirs, pipelines, treatment works, pumping stations, river and coast protection works and hydraulic structures.

**NIHON SUIDO CONSULTANTS CO LTD** 2-6 Okubo 2-Chome, Shinjuku-Ku, Tokyo, 160, Japan, Tel: +81-3-202-0101, Telex: 28670, Fax: +81-3-202-9686. Independent engineering firm specializing in water supply, sewerage, drainage and sanitation. Particular emphasis has recently been placed on system engineering and water quality engineering services aided by computer facilities and central laboratory. Wide international experience.

**NITRO NOBEL AB**, Gyttorp, Nora, 71382, Sweden, Tel: +46-587-85000, Telex: 73260 nobele, Fax: +46-587-25535, Contact: Mr Kanto. Manufacturers of explosives for civil applications. Blasting consultants. Nitro Nobel organise training courses in the blasting field.

**NORCONSULT** Kjørboveln 20, Sandvika, 1300, Norway, Tel: +47-2-47-10-00, Telex: 72075, Fax: +47-2-54-70-10, Contact: Mr Movik. Norconsult International AS is a Norwegian consulting firm providing a wide range of multidisciplinary services in the sectors of infrastructure and energy, with particular specialisations in hydrogeology, water supply, sanitation, hydro-

power, small-scale hydropower and power transmission.

**NORTHCROFT NEIGHBOUR AND NICHOLSON** 1 Horse Guards Avenue, London, SW1A 2HU, UK, Tel: +44-1-839-7858, Fax: +44-1-930-2594, Contact: R Spicer. A long established firm of quantity surveyors and construction cost consultants with extensive experience in the field of pipelines over the last 25 years. Experience has been gained both at home and overseas.

**OBERMEYER PROJECT MANAGEMENT GmbH** Hansastrasse 40, Munchen 21, D-8000, West Germany, Tel: +49-89-5799/1, Telex: 5-212-466 and 898-588, Fax: +49-89-5799/3333. Provides integrated planning services for overseas clients in the sectors of regional and urban planning, infrastructure and detailed projects, operational organization and data handling and undertakes project management. Please contact direct for further details.

**ORLANDO LABORATORIES INC** PO Box 19127, Orlando, Florida, 32814, USA, Tel: +1-407-896-6645, Fax: +1-305-898-6588, Contact: Ms C J Madden. Analysis of water and waste water for radio chemicals, nutrients, minerals and organics.

**OVE ARUP AND PARTNERS** 13 Fitzroy St, London, W1P 6BQ, UK, Tel: +44-1-636-1531, Telex: 295341 OVAR PT G, Fax: +44-1-580-3924, Contact: Mr Marsh. Ove Arup & Partners is the largest UK engineering consultancy with some 37 offices overseas. The firm has a wide range of skills and capabilities appropriate to the needs of water engineering for the developing countries.

**PANNONPLAST WORKS** P O Box 30, Budapest, H-1400, Hungary, Tel: +36-1-225-849, Fax: +36-1-229-228, Contact: Jozsef Lazar. Consultancy in water supply projects, especially in clarifiers and sedimentation.

**PARKMAN CONSULTANTS** Cunard Building, Liverpool, L3 1ES, UK, Tel: +44-51-236-6066, Fax: +44-51-236-1276, Contact: Barrie White. Consultants in water resources and supply, irrigation and public health engineering providing technical, economic and environmental studies, engineering design, contract documentation, bid evaluation, construction management and supervision and computer services.

**PENCOL ENGINEERING CONSULTANTS** 20 Grosvenor Place, London, SW1X 7HP, UK, Tel: +44-1-235-4300, Telex: 27515, Fax: +44-1-235-5695, Contact: Mr Peter Lloyd. Multi-disciplinary consultancy providing services for water, sewage and liquid waste, public health, oil and gas engineering, with particular emphasis on pipeline and high technology applications for mechanical, electrical, control and communication systems.

**POSFORD DUVIVIER** Rightwell House, Bretton Centre, Peterborough, PE3 8DW, UK, Tel: +44-733-262468, Telex: 32651, Fax: +44-733-262243, Contact: Mr Ortnier. Consulting engineers offering a full range of services in the fields of water resources, water supply, sewerage, sewage treatment, waste disposal, land

## CONSULTANTS

drainage, flood alleviation, irrigation and coastal works.

**PRC ENGINEERING INC** 1505 Planning Research Drive, McLean, Virginia, 22102, USA, Tel: +1-703-556-1000, Telex: 248372, Fax: +1-703-556-1174. Serves government and industry in planning, engineering, architecture, construction management and the design, commissioning, operation and maintenance of a diverse range of facilities. Irrigation, flood control, river regulation, dams, drainage, wastewater, water supply and distribution, hydroelectric power.

**PURAC LTD** MCD House Birmingham Rd, Kidderminster, Worcs, DY10 2SH, UK, Tel: +44-562-820010, Telex: 338472, Contact: Mr Hunt. Purac Ltd are project managers and process engineers to the water and effluent treatment industry. Main areas of operation are in the construction of major potable/industrial water and effluent treatment schemes incorporating dissolved air flotation, filtration and ion exchange processes.

**RENDEL PALMER & TRITTON LTD** 61 Southwark St, London, SE1 1SA, UK, Tel: +44-1-928-8999, Telex: 919553, Fax: +44-1-928-5566, Contact: K Bedell-Harper. Planning, design and implementation of water engineering schemes including flood protection, irrigation and hydropower together with public health engineering from tunnelling, underground structures and sewer rehabilitation, through to pollution control.

**RESOURCES CONSERVATION COMPANY** 3006 Northrup Way, Bellevue, WA, 98004, USA, Tel: +1-206-828-2400, Fax: +1-206-828-0526. RCC Services range from feasibility and engineering studies to the design and installation of complete turnkey systems. RCC provides training for plant personnel and operations support long after system start-up. The company also maintains extensive analytical computer capabilities, laboratory facilities and testing equipment to support process development, applications engineering and operations.

**ROFE KENNARD & LAPWORTH** Raffety House, 2/4 Sutton Court Rd, Sutton, Surrey, SM1 4SS, UK, Tel: +44-1-643-8201, Telex: 946688, Fax: +44-1-642-8469, Contact: Mrs Sheila King. Consulting engineers specialising internationally in water engineering and management, including water resources, dams & reservoirs, ground water, treatment, dam safety, operations and institutional management. Schemes have been designed in all continents.

**S O G E A** Tour American International, Paris La Defense, Cedex 55, 92079, France, Tel: +33-1-47-52-41-95, Fax: +33-1-47-52-41-84, Contact: Francois Hanus. Sogea is a 23000 people company, working through branches or affiliated companies in 50 countries around the world. Over the years Sogea has developed a strong position in water treatment and associated waterworks and services as a contractor. From process design to performance guarantees, Sogea's responsibilities include the following specialities: Engineering: process, hydraulic, mechanical, electrical, civil, Design: process, control and chemical.

**SAFEGE CONSULTING ENGINEERING FIRM** 76 Rue des Suisses, Nanterre, 92000, France, Tel: +33-1-47-

24-72-55, Fax: +33-47-24-77-88. Consultants in: water supply, public utilities management, collection and treatment of waste water, geology - hydrogeology, hydrology and river control, irrigation and drainage, environmental protection, civil engineering, development of urban, tourist and industrial areas power.

**SANDWELL SWAN WOOSTER INC** 700-1190 Hornby St, Vancouver, BS, V6Z 2H6, Canada, Tel: +1-604-684-9311, Telex: 04-51275, Fax: +1-604-688-5913. Comprehensive international experience in services related to the study, design, construction and operation of resource and infrastructure projects: irrigation and flood control, drainage, pipelines, wastewater, water supply and water distribution.

**SAUR AFRIQUE** 1 Avenue Eugene Freyssinet, Sain Quentin Yvelines Cedex, 78064, France, Tel: +33-1-30-60-22-60, Telex: +689-291, Fax: +33-1-30-60-27-89. Created by the French Group Saur in 1973, Saur Afrique is involved in all fields of the water sector across the African continent. Saur Afrique aims to play an active role in helping African countries build for the future.

**SAUR** 50-56 Rue de la Procession, Paris Cedex 15, 75737, France, Tel: +33-1-48-56-45-00, Telex: +206-196. For Saur, managing drinking water and sewage installations means providing a consistent level of quality, output and safety at every step of the cycle. More than 1,000,000 tons of water are distributed every day to 5,000,000 users in France.

**SCHUFFL & FORSTHUBER CONSULTING ENGINEERS** Reichenhallerstrasse 6, Salzburg, A 5020, Austria, Tel: +43-662-845221, Telex: 633892, Fax: +43-662-845221-8, Contact: Mr Wutscher. The company can offer experience and know-how for projects such as: water prospecting, water distribution, water-loss analysis, water treatment, sewage systems, pumping stations, treatment plants for domestic and industrial wastewater, refuse composting.

**SENSONICS LTD** Chartridge, Chesham, Buckinghamshire, HP5 2SH, UK, Tel: +44-494-774251, Fax: +44-494-791094, Contact: Mr Armson. Vibration, condition and displacement monitoring.

**SEVERN-TRENT INTERNATIONAL** Abelson House, 2297 Coventry Rd, Sheldon, Birmingham, B26 3PU, UK, Tel: +44-21-722-4000, Telex: 339333, Fax: +44-21-722-4000 ext 4503, Contact: Jackie Hardy. FAX-Night - 44-21-722-4503 Branch of Severn-Trent water providing engineering and design services and advice.

**SGI - CONSULTING ENGINEERS** P O Box 158, 71 Avenue Louis-Casai, 1216 Cointrin, Geneva, Switzerland, Tel: +41-22-986611, Telex: 22044, Fax: +41-22-980800, Contact: Mr Vuilleumier. SGI provide a complete range of consultancy services (feasibility studies, design and supervision) in the field of water engineering, covering water supply and treatment, water resources development, sewage treatment, irrigation and drainage and hydro-power schemes.

**SNOWY MOUNTAINS ENGINEERING CORPORATION** P O Box 356, Cooma, NS W, 2630,

# EXPERTS IN THE WORLD OF WATER.

We are URS International, one of the world's leading experts in the design and construction management of safe and efficient systems of water supply, distribution and treatment. Our decades of experience in creating these facilities that are essential to all economic and social development extends from the United States to the Philippines, Indonesia, Korea, Taiwan, Hong Kong, Singapore and South America. URS International water projects completed or under way in those areas of the world include the most modern wastewater treatment facilities, entire municipal systems involving new and rehabilitated underground transmission and distribution mains as well as storage facilities, mini-hydro power plant installations, floodplain and watershed management, and dam and reservoir construction. Most importantly, when you retain URS International for your water project, you have instantly available the skills of more than 1,600 engineers, scientists, planners and other professionals who staff 40 U.S. and international offices – a delivery system for technology that is unsurpassed in the world professional services industry. For further information contact

HEADQUARTERS  
150 Fourth Street  
San Francisco, California 94103  
Tel: (415) 957-5300  
Fax: (415) 495-8533

# URS International



# URS INTERNATIONAL

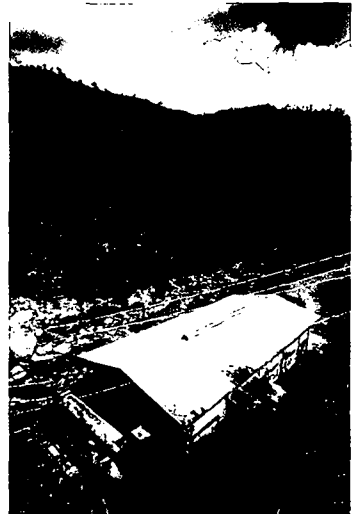
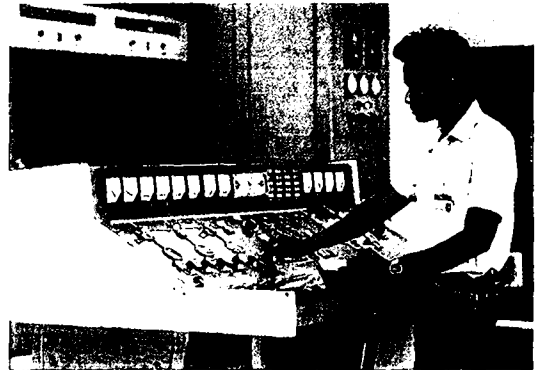
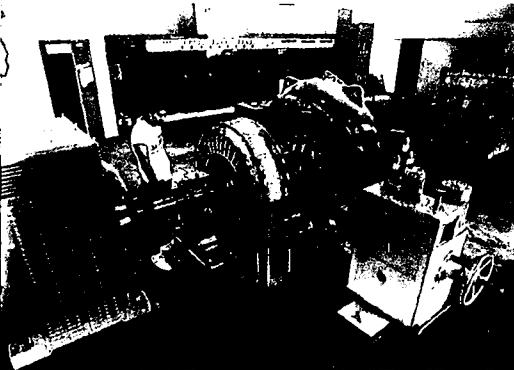
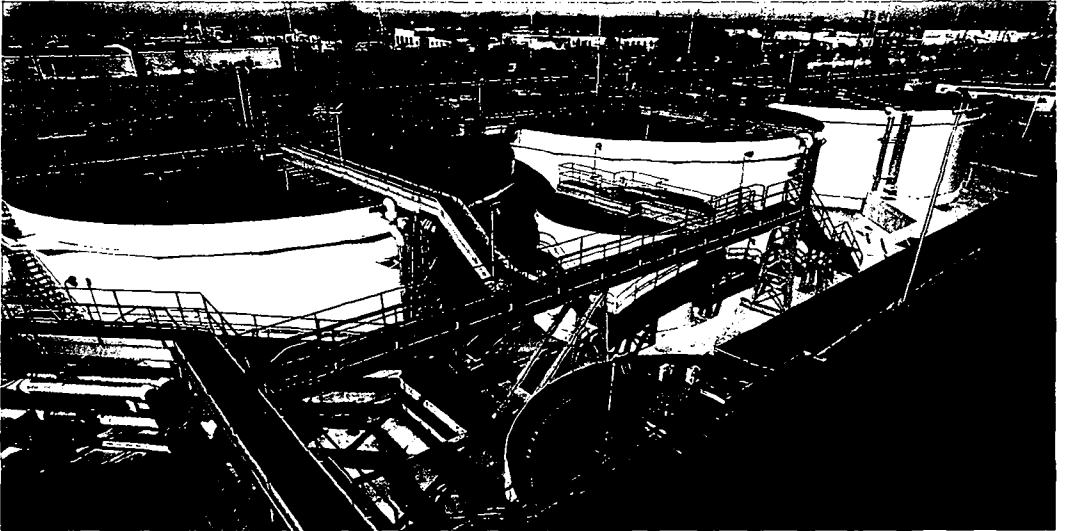

*URS International provides the full range of professional services required for the building of major water systems through a network of 56 U.S. and international offices.*

## CONSULTANTS

Australia, Tel: +61-64-520445, Fax: +61-64-520400, Contact: Arthur J Watts. The Snowy Mountains Engineering Corporation (SMEC) provides engineering consulting services for feasibility studies, field investigations, laboratory studies, design, contract documentation, contract management, construction supervision, operation and maintenance training for hydro electric and multipurpose water resources development, river basin studies, irrigation and flood control, roads and bridges, tunnels and underground works.

**SOGREAH CONSULTING ENGINEERS** BP 172-X, Grenoble Cedex, 38042, France, Tel: +33-76334000, Telex: 980876, Fax: +33-76-33-42-96, Contact: M Dartout. SOGREAH Consulting Engineers in hydraulics and development: regional development, agricultural development, urban and industrial hydraulics, dams and hydro power, port and coastal engineering, river engineering and water resources, hydraulic scale model studies.

**SOIL AND WATER LTD** Italahdenkatu 2, Helsinki, SF-00210, Finland, Tel: +358-0-670121, Telex: 121963, Fax: +358-0-692-3454. Independent firm of consulting engineers providing engineering services in the fields of water engineering, traffic and transportation planning, soil mechanics and foundation engineering, mapping and surveying, environmental, urban and regional planning as well as construction management. Experience in all aspects of the water industry.

**SOUTHERN WATER** Guildbourne House, Worthing, West Sussex, BN11 1LD, UK, Tel: +44-903-205252, Fax: +44-903-30511, Contact: Andrew Panting. One of England's 10 water authorities serving 4,000,000 in the South and Southeast of the country. Offer a wide range of expertise in technical and training matters.

**SWECO** P O Box 5038, Linnegatan 2, Stockholm, S-102 41, Sweden, Tel: +46-8-663-03-70, Telex: 17597, Fax: +46-8-660-9217, Contact: Mr Hallmans. Sweco is a company of consulting engineers, working worldwide in all fields of urban, industrial and infrastructure development. Important fields of activities are: water resources, water conveyance, water treatment including desalination and water distribution.

**SWEDPOWER** P O Box 34, Stockholm, S-101 20, Sweden, Tel: +468-24-81-00, Telex: 8106225, Fax: +468-21-33-06, Contact: Mr Mats Waltra. Swedpower is a subsidiary of the Swedish state power board and offers an expert consultancy service in respect of the rehabilitation, refurbishing, upgrading, operation and maintenance of hydro power stations and dams.

**TAMS CONSULTANTS INC** 655 Third Avenue, New York, NY, 10017, USA, Tel: +1-212-867-1777, Telex: (ITT)422188/(RCA)233055, Fax: +1-212-697-6354. Consulting firm of engineers, architects and planners providing professional services for projects throughout the world. Fields of specialization include water resources - planning, design and construction supervision services for dams, hydroelectric power, flood control, irrigation systems and river basin planning.

**TAMS-PIRNIE INTERNATIONAL** 655 Third Avenue,

New York, NY, 10017, USA, Tel: +1-212-867-1777, Telex: (ITT)422188/(RCA)233055, Fax: +1-212-697-6354. TPI was formed to offer environmental planning, sanitary engineering and water resources development on a worldwide basis. Fields of specialization include water supply systems (all types), wastewater systems and industrial water and pollution control.

**THAMES WATER INTERNATIONAL** Nugent House, Vastern Rd, Reading, Berks, RG1 8DB, UK, Tel: +44-734-593353, Telex: 848054 TODTWA G, Fax: +44-734-593747, Contact: John Case. Thames Water International is a division of Thames Water, which is one of the world's largest water undertakings concerned with water resources, treatment and distribution, sewerage, sewage treatment, sludge disposal, pollution control, flood control, river management and recreation. Offers advice and assistance on the above operational matters with particular reference to institutional studies, process optimisation and training.

**TRACTEBEL** Place du Trome 1, Brussels, 1000, Belgium, Tel: +32-2-510-7111, Telex: 21852 tract belgium, Fax: +32-2-510-8200, Contact: Mr Zwaenepoel. Industrial and infrastructural engineering consultants. Engineering for dam and harbour construction.

**TURNER & COATES LTD** Faulkner House Faulkner St, Manchester, M1 4DY, UK, Tel: +4461-228-6420, Fax: +4461-228-6425, Contact: Robert C Smith. Turner & Coates Limited offer a comprehensive package which addresses all aspects of a total quality management approach. We offer expertise installing quality management systems, establishing quality strategy, corrective action projects such as statistical process control and statistical defect control systems. Comprehensive training is available for all these services and other employee involvement programmes.

**WAKUTI KARL K G** Loehr Strasse 15, Siegen, D5900, West Germany, Tel: +49-271-55085, Telex: 0872934, Contact: Mr Hellwig. Specialists in water resources development, wastewater treatment, pollution control, full project development from preliminary studies to project management. Registered: World Bank, ADB, UNDP, WHO, etc. Established 1953. More than 10,000 water and sanitation projects in Germany and overseas.

**WALLACE EVANS AND PARTNERS** Plymouth House, Plymouth Rd, Penarth, Glamorgan, CF6 2YF, UK, Tel: +44-222-704321, Telex: 497338, Fax: +44-222-709793, Contact: Mr Lewis. Consulting civil and structural engineering services including water supply, sewerage and sewage treatment, irrigation, roads and bridges etc.

**WARDROP ENGINEERING INC** 77 Main St, Winnipeg, Manitoba, R3C3H1, Canada, Tel: +1-204-956-0980, Telex: 07-57487, Fax: +1-204-957-5389, Contact: Mr Holmes. Engineering consultants with 20 years' experience in the developing world with specialists in the field of rural and urban water supply including ground-water and surface water development.

**WATER QUALITY INSTITUTE** 11 Agern Alle, Hoersholm, 2970, Denmark, Tel: +45-2-8652-11, Telex: 37874,

## CONSULTANTS

Fax: +45-2-86-72-73, Contact: Mr Simonsen. Consultants undertaking water, waste water and pollution studies, baseline studies and monitoring, water quality modelling and ecotoxicological testing, environmental impact assessments and chemical analysis.

**WATER RESOURCE MANAGEMENT** P O Box 2444, Lakeside, California, 92040, USA, Tel: +1-619-561-5936, Contact: Mr Richard K Willis. Water Resource Management is an international, full service consulting firm specializing in Drip/Micro Irrigation. Services available include design, layout and planning of all sizes of projects. Professional staff to supervise installation and implementation. Complete evaluations of existing systems as well as product evaluations. Filtration requirements and equipment recommendations. Drip irrigation seminars and presentations to all levels.

**WATER SUPPLY COMPANY OF MARSEILLES** 25 Rue Edouard Delanglade, Marseille, 13006, France, Tel: +33-91-57-60-87, Telex: 440884, Fax: +33-91-57-60-97. Water supply and sanitation company specialist in consultancy, training and project design for water supply networks, sewerage, water treatment and distribution and master plans.

**WATER-INTERNATIONAL LTD** PO Box 49, Oakland House, Talbot Rd, Old Trafford, Manchester, M16 0QY, UK, Tel: +44-61-848-0683, Telex: 665682, Fax: +44-61-872-5581, Contact: Brian Lightell. Water International Ltd is the overseas consultancy company formed by three of the UK's largest water undertakings - North-west, Welsh and Yorkshire Water. Key activities are: institutional development, resource management, water and sewage treatment, distribution and disposal, operation contracting, training.

**WATERMATION LTD** Monument Way E, Woking,

Surrey, GU21 5LY, UK, Tel: +44-4862-70303, Fax: +44-483-755082. Contact: Mrs E Hawthorn. Manufacturers of irrigation equipment for sports turf, landscape and dust control. Contractors for installation of irrigation schemes. Maintenance division for repairs and maintenance and, consultancy for design of irrigation schemes.

**WATSON HAWKSLEY** Terriers House, 201 Amersham Rd, High Wycombe, Bucks, HP13 5AJ, UK, Tel: +44-494-26240, Telex: 83439 Watson G, Fax: +44-494-22074. Consulting engineers specialising in water supply, wastewater and environmental protection. Services worldwide include water resource studies, water storage, treatment and distribution design, sewerage, drainage, wastewater treatment and effluent disposal advice.

**WESSEX WATER** Wessex House Passage St, Bristol, Avon, BS2 0JQ, UK, Tel: +44-272-290611, Fax: +44-272-293137, Contact: Mr John Tinkler. General consultancy for the water industry: management services, operational and environmental management, quality control and scientific services, technical designs, specialist advice in information technology, and training.

**WIMPEY LABORATORIES LTD** Beaconsfield Rd, Hayes, Middlesex, UB4 0LS, UK, Tel: +44-1-573-7744, Telex: 935797, Fax: +44-1-848-1554, Contact: Mr John K Green. Specialist civil engineering, grouting, site investigation, materials testing, environmental surveys, structures testing and hydrogeological surveys.

**WOODWARD-CLYDE CONSULTANTS** 6000 Montgomery St, San Francisco, California, 94111, USA, Tel: +1-415-945-3000, Fax: +1-415-956-4929, Contact: Boyd Miller. Consultants in the field of water resources development, modelling and numerical analyses, groundwater monitoring.

DEVELOPING WORLD  
**WATER**

**E**ntries ending in WT are taken from Water Technology Magazine's Planning and Purchasing Handbook. The subscription address is: Water Technology Magazine, 13 Century Hill Dr, Latham, NY 12110, USA. Telephone (518) 783-1281. Entries ending in IAWPRC are reproduced from the 1987-88 Yearbook of the International Association on Water Pollution Research & Control (IAWPRC) with the Association's consent. IAWPRC, 1 Queen Anne's Gate, London SW1H 9BT, England.

# AUTHORITATIVE GUIDES TO WATER MANAGEMENT FROM VAN NOSTRAND REINHOLD

## **NEW** **DESIGN AND CONSTRUCTION OF WATER WELLS – A Guide for Engineers**

By the National Water Well Association

In clear, nontechnical language, this reference explains all the details of water-well design, construction, development, and operation. It examines different methods of well drilling and demonstrates how to determine proper intake design, test for yield and quantity, and maintain wells. There is also valuable information on ground-water geology, ground-water flow, and the most accessible ground-water supplies in the United States. A thorough examination of consolidated rock-well designs is also included.

1988 256pp illus. Hardback 0 442 26907 2 £26.95

"Up-to-date, comprehensive one source reference" – *Public Works*

## **HANDBOOK OF PUBLIC WATER SYSTEMS**

By Culp/Wessner/Culp

Now the highly praised and successful consulting and engineering firm of Culp/Wessner/Culp spells out how to handle system reconstruction, water quality protection and monitoring, and storage and distribution facility rehabilitation and expansion. Special topics include trihalomethane (THM) removal and control... small water-treatment systems... energy conservation techniques... sludge handling and disposal... and source development. Here is complete information on pumping systems, upgrading existing water treatment plants, and pretreatment processes for surface water supplies. Virtually every facet of the water-supply process is covered – from the source to the consumer's tap.

1986 1,032pp 435 illus. Hardback 0 442 21597 5 £66.95

"The author should be congratulated in presenting a readable, short, and sweet introduction to the field." – *American Water Resource Association*

## **GROUNDWATER TREATMENT TECHNOLOGY**

By Evan K. Nyer

Cleaning up polluted groundwater is a detailed, specialized process – and information about it is in great demand. Here is the first comprehensive source on how to apply new technologies and engineering methods to groundwater contamination. This practical guide emphasizes the removal of specific contaminants, illustrating design and application methods for pure compound removal, air stripping, carbon absorption, biological methods for organic containment and much more.

1985 188pp illus. Hardback 0 442 26706 1 £27.95

"One of the most comprehensive texts on this subject" – *Journal of Aquaculture & Aquatic Sciences*

## **WETLANDS**

By William J. Mitsch and James G. Gosselink

This is the only currently available work to probe the structure and function of more than just a few types of wetlands. It covers tidal salt and freshwater marshes, mangrove wetlands, freshwater marshes, peatlands and bogs, southern deepwater swamps, riparian wetlands, and more. Fully analyzed are the individual hydrological and biochemical characteristics as well as common principles of each of the ecosystems. "One of the first of its kind, this textbook focuses on the scientific and management aspects of both freshwater and coastal wetlands." – *National Wetlands Newsletter*

1986 560pp illus. Hardback 0 442 26398 8 £34.95

These titles and other titles of interest are available from:

- Van Nostrand Reinhold, Chapman and Hall, 11 New Fetter Lane, London EC4P 4EE. Phone: (01) 583 9855, Telex: 263398, Fax: (01) 583 0701 for UK, Europe, Middle East, Africa.
- Van Nostrand Reinhold, 115, 5th Avenue, New York, NY 10003, USA. Phone: (212) 254 3232, Telex: 272562, Fax: (212) 254 9499 for North America.
- International Thomson Publishing – International Division, 10 Davis Drive, Belmont, California 94002, USA. Phone: (415) 598 0784, Telex: 348383, Fax: (415) 598 9953 for Asia (inc. Japan), India, S. America, Central America, The Caribbean, The Pacific Islands.
- Nelson-Wadsworth, 480 La Trobe Street, Melbourne 3001, Victoria, Australia. Phone: (613) 329 5199, Telex: AA33088, Fax: (613) 329 1204 for Australia, New Zealand.

Also available from your bookseller.

## **NEW** **CURRENT TRENDS IN WATER-SUPPLY PLANNING – Issues, Concepts & Risks**

By David W. Prasifka

Anyone involved in water supply planning and management will value this practical planning guide to water supplies that meet social, economic, and political requirements. You will find a tested strategy for accurately predicting community water demands and criteria for designing water supply facilities to meet community needs as cost effectively as possible. Prasifka also gives you a procedure for implementing a self-sustaining water-pricing policy, identifies natural and human-made hazards to water supplies, and evaluates their social and economic consequences.

1988 224pp illus. Hardback 0 442 27511 0 £25.95

"Monumental work... highly recommended" – *Public Works*

## **HANDBOOK OF CHLORINATION Second Edition**

By George Clifford White

Extensively revised and updated using the author's own ongoing worldwide experience as a consulting engineer, this current edition provides the very latest information on the chlorination of potable water, wastewater, and industrial water. This comprehensive guide to the chlorination/dechlorination process clearly explains new developments and alternative methods for disinfection, including the uses of ozone, bromine, iodine, and UV radiation.

1986 1,088pp Hardback 0 442 29285 6 £67.95

## **NEW** **ADVANCED DAM ENGINEERING FOR DESIGN, CONSTRUCTION, AND REHABILITATION**

Edited by Robert B. Jansen

Whether you need to design a new dam or improve an existing one, you will achieve better results by tapping the expertise of today's foremost authorities, brought to you exclusively in this one convenient source. You can plan projects more efficiently by accessing state-of-the-art instruction on refinements in dam instrumentation, earthquake resistant construction, advances in designs for spillways and outlets, hydrology and geology considerations, new methods for rockfill dam construction, design and construction of roller-compacted concrete dams, arch dam design analysis, and much more.

1989 832pp illus. Hardback 0 442 24397 9 £68.95



**Van Nostrand Reinhold**

**Research, Training  
& Publications •**

# SUSTAINING THE IMPETUS OF THE DECADE

by

John Pickford



*Community participation -- mobilizing village people in Nigeria.*

**As we turn our thoughts from the International Drinking Water Supply and Sanitation Decade to "Health for all by the year 2000" it is interesting to look back over the years to see the part played by research, training and publications.**

These three aspects of software always tend to be linked. In universities and colleges in developing and developed countries alike, academic staff are continually exhorted to carry out more research as a basis for their teaching. The rule "publish or perish" is being rigorously applied.

During the years leading up to the launching of the Decade, a major topic of research was the relationship of disease to bad quality and insufficient water supplies. Old ideas about "waterborne" diseases were replaced by a new understanding of disease transmission, with emphasis on the faecal-oral route. This led to appreciation of the role of sanitation and to the addition of the word "sanitation" to what had originally been planned as the "Water Decade." The World Bank, with support from UNDP, set about disseminating the results of this research in a series of publications on the theme of appropriate technology.

**Appropriate technology** was no new idea. Years before, Dr. E. F. Schumacher had published "Small is Beautiful" and had launched the Intermediate Technology Development Group. Technology, he claimed, should be intermediate between advanced high-tech and the aged-old traditional inefficient technology of the villages of

Africa and Asia. The significance of the term "appropriate technology" gradually changed. The idea became generally accepted that appropriate technology should be low in cost. As far as the Decade was concerned, that was a correct interpretation. Most of those who needed water in 1981, and most of those who still need it, live in poor countries. They are often the poorest of the poor in the poor countries.

So a lot of research and a lot of publications were devoted to the type of facility that can be provided with minimum expenditure. Much research was sound. For example, Peter Morgan at the Blair Institute near Harare in Zimbabwe developed the ventilated improved pit (VIP) latrine. The World Bank later took over handpump testing from ODA (the U.K. Overseas Development Administration). Supplementing laboratory evaluation of many different manufacturers' products were field tests on hundreds of pumps in Africa. The results of this research were made available in the World Bank publications.

**Community participation** has received a great deal of attention throughout the Decade. There have been numerous publications stressing its importance although research has been sporadic. It is comparatively easy to

## RESEARCH, TRAINING & PUBLICATIONS

investigate the performance of a handpump or a waste stabilization pond. In fact, there are few large departments of mechanical engineering in Third World universities and technical colleges that have not at some time produced a "new" type of pump. Meaningful study of the effect of community participation is not so easy. Apart from anything else, it is difficult to isolate the influence of communities' involvement in projects from other factors such as external input of resources and the quality of institutions and management.

High among the constraints preventing full achievements during the Decade have always been the shortage of trained professionals and sub-professionals. It is now admitted that training alone is not enough to ensure employees involved in water supply and sanitation programmes work effectively. Pay scales, conditions of service and other supportive measures are as important as the inculcation of knowledge and skills through training. Since well before the start of the Decade a few educational institutions provided training for engineers that is appropriate and orientated towards the community. Among these have been the All India Institute of Hy-

giene and Public Health (AIIPH) in Calcutta and the Water, Engineering and Development Centre (WEDC) at Loughborough in England. Training of engineers elsewhere has often emphasized technology. The conventional sophisticated variety is usually preferred.

As with research and publications, the World Bank (financed by UNDP) has supported training initiatives. Comprehensive training modules were prepared. The International Training Network (ITN) was launched, although setting up ITN Centres has not proved an easy undertaking.

Towards the end of the Decade particular attention has been given to sustainability. Too many handpumps break down. Too many programmes fail to maintain their initial impetus. From the technical point of view, good operation and maintenance are essential. To sustain programmes, important facets are real mobilization and participation of communities at every stage. The Decade's efforts in the provision of good water supply and sanitation schemes can and must be sustained throughout the 1990s to provide health for all by the year 2000.

*Sustainable technology — slum improvement in Hyderabad, India.*



### Book Publishers

**AMERICAN WATER WORKS ASSOCIATION** 6666 W Quincy Avenue, Denver, CO, 80325, USA, Tel: +1-303-794-7711, Telex: +45-0895, Fax: +1-303-794-7310. AWWA's publications cover the water supply industry. More than 350 titles are available on water source, quality, treatment and distribution, utility management, employee training and safety. Catalogue available.

**AMERICAN WATERWORKS ASSOCIATION** 6666 W Quincy Avenue, Denver, CO, 80235, USA, Tel: +1-303-794-7711, Fax: +1-303-794-7310, Contact: Mark Abusamra. The world's water information leader, AWWA's publications cover the water supply industry. More than 350 titles cover water source, quality, treatment and distribution, utility management, employee training and safety. Catalogue available.

**APPLIED BIOCHEMISTS INC** 5300 West County Line Rd, Mequon, WI, 530902, USA, Tel: +1-414-242-5870, Telex: 910-2763618, Contact: Ruth Gifford. Publishers of "How to identify and control water weeds and algae".

**CHAPMAN AND HALL** 11 New Fetter Lane, London, EC4P 4EE, UK, Tel: +44-1-583-9855, Telex: +263398, Fax: +44-1-583-0701. Distributors in Africa and the Middle East for Van Nostrand Reinhold Books, which include "Handbook of Chlorination", "Design and Construction of Water Wells", "Greenhouse Effect and Sea Level Rise", "Groundwater Treatment Technology" etc.

**INTERMEDIATE TECHNOLOGY DEVELOPMENT GROUP** Myson House, Railway Terrace, Rugby, Warwickshire, CV21 3HT, UK, Tel: +44-788-60631, Telex: +317466. ITDG is a British charity dedicated to increasing the income generating capabilities of poor people in rural areas of the developing world. The Group gives advice in the choice of appropriate technologies and provides technical assistance to local development projects aimed at improving the productivity of communities and small enterprises. Developed the IT windpump and publishes "Waterlines" quarterly journal and several relevant books. IT Development Techniques Ltd is the Group's marketing channel.

**INTERNATIONAL THOMPSON PUBLISHING** 10 Davis Drive, Belmont, CA, 94002, USA, Tel: +1-415-598-0784. Distributors in South America, S E Asia and the Far East, for Van Nostrand Reinhold Books, many on the Water Industry.

**THE IRRIGATION ASSOCIATION** 1911 North Fort Myer Drive, # 1009 Arlington, VA, 22209, USA, Tel: +1-703-524-1200, Telex: 910-250-8332, Fax: +1-703-524-9544, Contact: Mark Williams. The Irrigation Association is a non-profit trade organization representing the irrigation industry at the national and international levels. Its primary purpose is to provide members with comprehensive programs and services helping them keep pace with the rapidly changing technology of the industry.

**JOHNSON FILTRATION SYSTEMS** Johnson House,

Browells Lane, Feltham, Middlesex, TW13 7EQ, UK, Tel: +44-1-751-4424, Telex: 935479, Fax: +44-1-890-1533. Publishers of the classic information source book on groundwater entitled, "*Groundwater, Water and Wells.*" This excellent technical reference book, revised in 1986, now contains over 1,000 pages including sections on water treatment and surface water intakes.

**KRIEGER PUBLISHING CO** Box 9542, Melbourne, FL, 32902, USA, Tel: +1-407-724-9542, Fax: +1-407-951-3671, Contact: Anne Krieger. Publish many scientific and technical books, such as "And the desert shall rejoice - Conflict, Growth and Justice in Arid Environments" and "Industrial Water Pollution".

**MACMILLAN PUBLISHING OVERSEAS** Houndmills, Basingstoke, Hampshire, RG21 2XS, UK, Fax: +0256-479-476, Contact: Joanne Scofield. Publishers of books for education and training in the Developing World at all levels. Publishing emphasis on health, agriculture and technology, including water technology. We are involved in collaborative publishing venture with international aid agencies and organisations in the Developing World.

**MIDDLE EAST AND WORLD WATER DIRECTORY** PO Box 135121, Beirut, Lebanon. This directory comprises two volumes: A. 10,000 listings for public and private sector firms, mainly import/export bureaus, distributors, contractors, wholesalers, engineering firms and sellers of water and sewage equipment in 53 countries located in the Middle East and Africa. B. 9,000 listings for leading manufacturers, contractors, consulting engineers and suppliers of water equipment in the Americas, Europe, Australia and East Asia. (Published by: MEWWD. (IAWPRC))

**PERGAMON PRESS PLC** Headington Hill Hall, Oxford, OX3 0BW UK Tel: +44-865-64881, Telex: +83177, Fax: +44-865-60285. Pergamon Press, one of the largest STM publishers in the world, is the official publisher for the International Association on Water Pollution Research and Control (IAWPRC). Free sample copies of the IAWPRC journals *Water Research*, *Water Science and Technology*, and comprehensive IAWPRC Publications Catalogue, are available from our Oxford office. Please write for further information.

**THE IRRIGATION ASSOCIATION** 1911 North Fort, Myer Drive, #1009 Arlington, VA, 22209, USA, Tel: +1-703-524-1200, Telex: +910-250-8332, Fax: +1-703-524-9544, Contact: Mark Williams.

**VAN NOSTRAND REINHOLD** Chapman and Hall, 11 New Fetter Lane, London, EC4P 4EE, UK, Tel: +44-1-583-9855, Telex: 263398, Fax: +44-1-583-0701. Van Nostrand Reinhold has an established reputation for books which draw together the expertise of professionals in the field to produce authoritative, state-of-the-art handbooks. In the field of water management, civil engineers and environmental engineers will find a range of reputable titles, from *Design and Construction of Water Wells* and the *Handbook of Chlorination to Greenhouse Effect and Sea Level Rise*.

**VULKAN-VERLAG GmbH, HAUS DER TECHNIK**





## PUBLICATIONS

**\*SEND FOR A FREE SAMPLE  
COPY OF THESE  
PUBLICATIONS**

### WATER SCIENCE AND TECHNOLOGY

A Journal of the International Association on Water Pollution Research and Control

Editorial enquiries to: **ELIZABETH IZOD**, IAWPRC, 1 Queen Anne's Gate, London SW1H 9BT, UK

Published on behalf of the International Association on Water Pollution Research and Control (IAWPRC) this important review journal records the proceedings of IAWPRC biennial conferences, international specialized conferences on topics and developments in all fields of water pollution control of current importance and seminars devoted to a detailed study of important subjects.

Some Recently Published Conference Proceedings:

**Design and Operation of Sewage Treatment Plants in Coastal Tourist Areas**, Conference held in Limassol, Cyprus, 3-4 November 1987.

**Water and Wastewater Microbiology**, Conference held in Newport Beach, California, USA, 8-11 February 1988.

**Waste Management in Petrochemical Complexes**, Seminar held in Porto Alegre, Rio Grande do Sul, Brazil, 26-28 October 1987.

#### Subscription Information

1989: Volume 21 (12 issues)

Price available on application

ISSN: 0273-1223

Each issue is also available for purchase separately.

### WATER RESEARCH\*

The Journal of the International Association on Water Pollution Research and Control

Executive Editor: **K J IVES**, IAWPRC, 1 Queen Anne's Gate, London SW1H 9BT, UK

This journal publishes refereed, original research papers covering all aspects of the pollution of marine and fresh water and the management of water quality as well as water resources.

A Selection of Recent Papers:

**C PRAT, M VINCENTE & S ESPLUGAS** (Spain),

Treatment of bleaching waters in the paper industry by hydrogen and ultraviolet radiation.

**C N HAAS** (USA), Maximum likelihood analysis of disinfection kinetics.

**J G COOKE & R E WHITE** (UK), The effect of prolonged exposure to acetylene on denitrification in a laboratory stream sediment system.

**E KORSHOLM & H SOGAARD** (Denmark), An evaluation of direct microscopical counts and endotoxin measurements as alternatives for total plate counts.

**H RANJIE** (FRG) & **L HUI MIN** (China), Modelling of BOD-DO dynamics in an ice-covered river in northern China.

#### Subscription Information

1989: Volume 23 (12 issues)

Price available on application

ISSN: 0043-1354

### WATER QUALITY INTERNATIONAL\*

The News Magazine of the International Association on Water Pollution Research and Control

Editor: **WENDY HOROBIN**, IAWPRC, 1 Queen Anne's Gate, London SW1H 9BT, UK

*Water Quality International* is a quarterly news digest containing news and information from IAWPRC conferences and Specialist and Task Groups, plus general news items from around the world. Included are specific technical features, a research and development section, new products, listing of books and reports, display advertising, international conference diary and full news of IAWPRC current activities.

#### Subscription Information

1989: Volume 3 (4 issues)

Price available on application

ISSN: 0892-211X



**PERGAMON  
PRESS**

Fairview Park, Elmsford, New York 10523, USA  
Headington Hill Hall, Oxford OX3 0BW, UK

PO Box 10 39 62, Hollestr 1G, Munich, Tel: +49-201/8200-2-0, Fax: +49-201/8200-2-40. Specialized technical publications for the supply industry. Most publications carry advertising by producers and service companies and are therefore efficient platforms for international marketing.

### Exhibition and Conference Organisers

**INTERNATIONAL WATER POWER AND DAM CONSTRUCTION** Quadrant House, The Quadrant, Sutton, Surrey, SM2 5AS, UK, Tel: +44-1-661-3500, Telex: 892084, Fax: +44-1-661-8904, Contact: Carolyn Price-Alexander. Organize conferences annually on hydroelectric power.

**THE IRRIGATION ASSOCIATION** 1911 North Fort Myer Drive, # 1009 Arlington, VA, 2209, USA, Tel: +1-703-524-1200, Telex: 910-250-8332, Fax: +1-703-524-9544, Contact: Mark Williams. The Irrigation Association is a non-profit trade organization representing the irrigation industry at the national and international levels. Its primary purpose is to provide members with comprehensive programs and services helping them keep pace with the rapidly changing technology of the industry.

### Research Organisations

**CEDRE** Pointe de Diable, Plouzane - BP 308, Brest, F-29274, France, Tel: +33-98-491266, Telex: 940145 F. Centre de Documentation de Recherche et d'Experimentations sur les Pollutions Accidentelles des Eaux. This Organisation, in addition to carrying out research, will respond to pollution alerts and will initiate cleaning-up operations. (IAWPRC)

**CONCAWE** Babylon - Kantorena, Koningin Julianaplein 30-9, 2595 AA Den Haag, The Netherlands. CONCAWE is the oil companies' international study group for conservation of clean air and water. (IAWPRC)

**FORSCHUNGSINSTITUT FUR ENERGIE UND UMWELTPLANUNG WIRTSCHAFT UND MARKTANALYSEN** Gymnasiumstrasse 42/5, Wien, A-1180, Austria, Tel: +43-222-34-01-27, Telex: 111010 tzst a. The institute prepares various studies relating to the environment and to alternative energy. Activities include the drawing up of emission registers, assessment of environmental impact, sanitary planning, redevelopment planning, urban and regional environmental planning, investment planning, regional energy development planning, alternative energy surveys (eg energy from biomass), market and economic studies and feasibility studies etc.

**GENERAL FILTER COMPANY** 600 Arrasmith Trail, Ames, Iowa, 50010-9761, USA, Tel: +1-515-232-4121, Fax: +1-515-232-2571. General Filter has designed and patented a number of today's universally accepted methods of water treatment and maintains a research

laboratory where new ideas, techniques and equipment for water treatment are developed and tested.

**HYDRAULICS RESEARCH LTD**, Wallingford, Oxfordshire, OX10 8BA, UK, Tel: +44-491-35381, Telex: 848552, Fax: +44-491-32233, Contact: Mr Simms. Research and project studies in civil engineering hydraulics: river engineering, tidal engineering, maritime engineering, irrigation and soil water problems.

**INSTITUTE OF HYDROLOGY** Maclean Building, Crowmarsh Gifford, Wallingford, Oxfordshire, OX10 8BB, UK, Tel: +44-491-38800, Telex: 849-365, Fax: +44-491-32256, Contact: Mr Griffin. Part of the government grant-aided Natural Environment Research Council, the Institute carries out hydrology research in catchment areas, for the transformation of rain or snow into flowing rivers, and applied studies. Involved in the development and testing of new methods and instrumentation. Carry out extensive commissioned research on behalf of governments and private companies.

**INTERNATIONAL ASSOCIATION FOR GREAT LAKES RESEARCH** Large Lakes Research Station 9311 Groh Rd, Grosse Ile, Michigan, 48138, USA. This Association is a multidisciplinary body whose objectives are to promote, publish and present results on the North American Great Lakes and other large lakes of the world. (IAWPRC)

**INTERNATIONAL ASSOCIATION ON HYDRAULIC RESEARCH** PO Box 177 Delft Hydraulics Laboratory, Rotterdamseweg 185, Delft, 2600 M H, The Netherlands, Tel: 31-15-569353, Telex: 30176 HYDEL, Contact: IAHR Secretariat. IAHR is a worldwide independent organization of engineers and scientists interested in or working in the field of hydraulic research. Its activities include: meetings, conferences and organization and co-ordination of special scientific and experimental research. (IAWPRC)

**INTERNATIONAL INSTITUTE FOR ENVIRONMENT AND DEVELOPMENT-EARTHSCAN (IIED)** 3 Endsleigh St, London, WC1H 0DD, UK, Tel: +44-1-388-2117. IIED is a unique policy research centre focusing on environment and development issues in the belief that sustainable economic, social, and human development is dependent on environmental policies.

**INTERNATIONAL INSTITUTE FOR HYDRAULIC AND ENVIRONMENTAL ENGINEERING** PO Box 3015 Oude Delft 95, 2601 DA Delft, The Netherlands, Tel: +31-15-783402. Cable: INTERWATER Delft (IAWPRC)

**NATIONAL ENGINEERING LABORATORY** East Kilbride, Glasgow, G75 0QH UK Tel: +44-35-522-0222, Telex: +777888, Fax: +44-35-523-6930. The National Engineering Laboratory (NEL) is the UK's leading research organisation in mechanical engineering. In water technology NEL undertakes research on flow meters, water turbines, valves, pumps, pipe line components and systems. NEL has also researched oscillating water column wave energy devices.

**THE NETHERLANDS WATERWORK'S TESTING**



# **LEADERS IN WATER AND WASTEWATER TECHNOLOGY & ENVIRONMENTAL MANAGEMENT**

WRC provides integrated research, technology and services for the water industry worldwide.

- Water treatment technology
- Sewage treatment technology
- Environmental toxicology
- Analysis and monitoring
- Industrial wastewater treatment
- Pollution management
- Drinking water quality
- Sewer and water mains operation and rehabilitation
- Sludge treatment technology
- Solid waste disposal

*For further information on these areas please contact Mike Slipper, Business Development Manager*

WRC SWINDON, P O BOX 85, FRANKLAND ROAD, BLAGROVE, SWINDON, WILTSHIRE SN5 8YR.

TELEPHONE: (0793) 511711. TELEX: 449541. FAX: (0793) 511712.



SWINDON

## RESEARCH ORGANISATIONS

**AND RESEARCH INSTITUTE KIWA LTD** Sir Winston Churchill-Laan 273, Postbus 70, Rijkswijk, 2280 AB, The Netherlands, Tel: +31-70-95-35-35. The Institute's task is the promotion of the use of reliable appliances and materials in the water industry and to carry out scientific research in this field.

**OVERSEAS SPRAYING MACHINERY CENTRE (OSMC)** Imperial College at Silwood Park, Sunninghill, Ascot, Berks, SL5 7PY, UK. OSMC provides advice, training and research on the application of pesticides and spraying machinery.

**SOUTHEAST ASIAN FISHERIES DEVELOPMENT CENTRE (SEAFDEC)** P O Box 4, Phrapradeng, Samutprakarn, Thailand. SEAFDEC has three major departments for training in fisheries, (Thailand), for marine fisheries research, (Singapore) and for fish culture (Philippines).

**UNITED STATES TESTING CO INC** 1415 Park Avenue, Hoboken, NJ, USA, Tel: +1-201-792-2400, Fax: +1-800-777-TEST, Contact: Daniel Drozdowski. Environmental and microbiological analysis of water and wastewater. Inspection and testing of materials and products. Engineering, chemistry, industrial sciences, environmental and life sciences.

**WRC** P O Box 16 Henley Rd, Marlow, Bucks, SL7 2HD, UK, Tel: +44-491-571531, Fax: +44-491-579094. WRC is a company working at the forefront of technology in drinking water supply, wastewater and environmental management. Its current annual turnover of over 20 million pounds generates a comprehensive research and development programme, covering all aspects of the water cycle. This provides a broad base of expertise, products and services for an advancing industry both in the United Kingdom and worldwide.

### Technical Journals

**ADVANCES IN WATER RESOURCES** CML Publications, Ashurst Lodge, Ashurst, Southampton, SO4 2AA, UK. Designed to act as an international forum for the exchange of scientific and technical information, this journal is an alternative for those who are interested in the more quantitative aspects of the water sciences. It publishes papers on basic developments and simulation techniques, and papers that emphasize practical applications. (IAWPRC)

**AFRICAN WATER AND SEWAGE** Queensway House 2 Queensway, Redhill, Surrey, RH1 1QS, UK, Tel: +44-737-68611, Telex: 948669 TOPINL. Published (quarterly) by: Fuel and Metallurgical Journals Ltd This journal aims to provide readers with a detailed account of the water industry in Africa through major articles, project studies, on-site reports and features. It contains a news section detailing latest projects, contracts and tenders, in addition to a section on products and services. Published (quarterly) by: Fuel and Metallurgical Journals Ltd. (IAWPRC)

**AQUA - PERGAMON PRESS LTD** Headington Hill

Hall, Oxford, OX3 0BW, UK, Fax: +44-865-64881. 83177 Aqua publishes refereed scientific and technical papers, and special authoritative features from international experts covering all aspects of water supply and techniques for the protection of water sources.

**AQUALINE ABSTRACTS** Headington Hill Hall, Oxford, OX3 0BW, UK, Tel: +44-865-64881, Telex: 83177. A guide to recently published information on water, wastewater, associated engineering services and the aquatic environment. Each issue provides up to 210 summaries of articles, reports and conference papers, selected for their relevance to engineers, scientists and managers engaged in water supply or wastewater disposal. Available from: Pergamon Press Ltd. (IAWPRC)

**AQUATECHNIC INTERNATIONAL - AQUATECHNIC PUBLICATIONS LTD** 75 Lower Camden, Chislehurst, Kent, BR7 5JD, UK. A trade journal describing products and services for the water and wastewater industries. It offers a computer-based reader enquiry service which provides further information on products and services mentioned in the journal. It also includes an indexed buyer's guide and an international diary of events. (IAWPRC)

**ARAB WATER WORLD** PO Box 135121, Beirut, Lebanon. This journal contains news and trends, contracts let or to be let, coming tenders, news on newly developed equipment and services, and reports on forthcoming exhibitions and conferences. It has a bilingual Arabic/English format. (IAWPRC)

**ARGUS BUSINESS PUBLICATIONS** Queensway House, 2 Queensway, Redhill, Surrey, RH1 1QS, UK, Tel: +44-737-768611, Telex: 948669 topjnl g, Fax: +44-737-760564, Contact: Neil Nixon. Publishers of: Middle East Water and Sewage (bimonthly) Far East Water and Sewage (bimonthly) Water Services (monthly). All of these journals are aimed at those involved in all aspects of the water industry.

**ASIAN ENVIRONMENTAL JOURNALS** PO Box 900 MCC, Makati, Phillipines. The official journal of the Pollution Control Association of the Philippines, and the Philippine Society of Sanitary Engineers. The journal includes book reviews, equipment news and feature articles in addition to refereed papers. It is also a supplementary journal of the Indonesian Society of Sanitary Engineers and the Indian Association on Water Pollution Control. (IAWPRC)

**ASIAN WATER AND SEWAGE** PO Box 20014, Hennessy Rd, Hong Kong, Tel: +852-5-278399, Telex: 72727 ASAMM. Short research articles, product news, information on forthcoming projects, and news of general interest - mainly on countries in the SE Asian region - are carried in this journal. Published (monthly) by: Asia Trade Journals Ltd.

**AWT NEWSLETTER (ADVANCED WATER TECHNOLOGY CONSULTING SERVICE)** Water Research Centre, PO Box 85, Frankland Rd, Blagrove, Swindon, Wiltshire, SN5 8YR, UK, Tel: +44-793-488301. This Newsletter is produced by a consortium of consultant



The National Engineering Laboratory is one of the largest independent mechanical engineering research establishments in the UK. An extensive range of services for contract research and development, feasibility and design studies and consultancy are available to industry.

The laboratory holds the UK national flow measurement standard and can provide expertise in the testing of water turbines, pumps, pipe line systems and components including flowmeters, valves and filters. NEL can also offer consultancy and test facilities on tidal power components and wave energy systems.

Facilities are available which can handle:

- \* Flowmeters up to 1.5cu.m. per sec, pipe sizes up to 1m diameter.
- \* Gas turbine driven pumps up to 10MW
- \* Electrically driven pumps up to 3MW
- \* Turbine testing up to 0.5m diameter.

*For further information contact:*

National Engineering Laboratory  
East Kilbride Glasgow G75 0QU

Tel: (03552) 20222 Fax: (03552) 36930 Telex: 777888

**National Engineering Laboratory**

engineers in the water technology field. Its coverage is international, and includes information on projects, conferences and publications. (IAWPRC)

**CHEMICAL DETERMINAND DICTIONARY** Department of the Environment, 2 Marsham St, London, SW10 3EB, UK, Tel: +44-1-212-3434. Provides standard nomenclature, coding systems and units of measurement for the exchange of chemical quality data. There are several classes of materials: gases, environmental water, water supply, sewage, trades, percolation, sludge, solids and biota. (IAWPRC)

**CHEMOSPHERE** Headington Hill Hall, Oxford, OX3 0BW, UK, Tel: +44-865-64881, Telex: 83177. An international journal designed for the rapid publication of original and important communications in English, French and German as well as review articles in English. The scope of the journal is broad, covering chemistry, biology and toxicology as related to environmental problems. Published (monthly) by: Pergamon Press. (IAWPRC)

**CONFLUENCE** Water Resources Section, ESCAP Natural Resources Division, United Nations Build, Bangkok, 10200, Thailand, Tel: +66-2-282-9161/282-9200, Telex: 82392 and 82315 ESCAP. This publication is designed as the chief medium for disseminating information to the agencies and governments participating in ESCAP's (Economic and Social Commission for Asia and the Pacific) information exchange activity in the field of water resources development. Published by: ESCAP, Water Information Exchange Service. (IAWPRC)

**DECADE WATCH 1** United Nations Plaza, New York, NY 10017, USA, Tel: +1-212-7544790, Telex: UNDEVPRO New York. A news-sheet, containing items relating to the progress of the International Drinking Water Supply and Sanitation Decade. Published by: United Nations Development Programme. (IAWPRC)

**DICTIONARY OF WASTE AND WATER TREATMENT** Borough Green, Sevenoaks, Kent, TN15 8PH, UK. Definitions of around 6000 terms are contained in this dictionary, in the fields of: water treatment and supply, sewerage, sewage treatment and disposal, solid waste disposal and reclamation, pollution prevention, toxic and hazardous waste disposal. Published (1983) by: Butterworths. (IAWPRC)

**DICTIONARY OF WATER AND SEWAGE ENGINEERING** Crown House, Linton Rd, Barking, Essex, IG11 8JU, UK, Tel: +44-1-594-7272. Contains some 8000 technical terms and synonyms relating to water supply and wastewater disposal, and providing each in German, English, French and Italian. Within the broad scope, engineering terminology is particularly well represented, whilst adequate (IAWPRC)

**DIR OF ORGNIZATIONS INVOLVED IN COMM EDUC & PARTICIPATION IN WATER SUPPLY & SANITATION** P O Box 5500, WHO Collaborating Centre, Rijswijk, HM, 2280, The Netherlands. This publication presents data on 124 organizations from 56 countries and 10 international organizations, regarding

their work in community education and participation in the field of water supply and sanitation in developing countries. Published by: The International Reference Centre for Community Water Supply & Sanitation. (IAWPRC)

**EFFLUENT AND WATER TREATMENT JOURNAL** Omega Lodge, Troutstream Way, Rickmansworth, Herts, WD3 4JN, UK, Tel: +44-923-775391. Contains news, comments and articles on new processes and products in the fields of: industrial water and its re-use, treatment and disposal of trade and municipal liquid wastes, and new developments in water management and the conservation of water resources. Published (monthly) by: Thunderbird Enterprises Ltd. (IAWPRC)

**ENVIRONMENTAL EQUIPMENT NEWS** Rue Verte 216, Brussels, 1030, Belgium, Tel: 32-2-242-2992, Telex: 25828. A supplement to International Equipment News, which is published bi-monthly and circulated in Europe, the Middle East and oil states to qualified buyers and specifiers of industrial products. Details are given of products for environmental protection of water, air and soil. Published by: International Equipment News. (IAWPRC)

**ESTUARINE COASTAL AND SHELF SCIENCE** 24-28 Oval Rd, Camden Town, London, NW1, UK. Published (monthly) by: Academic Press. Refereed papers on all aspects of this subject are published in this journal. Book reviews are also included. Published (monthly) by: Academic Press. (IAWPRC)

**EUROPEAN WATER AND SEWAGE** Queensway House 2 Queensway, Redhill, Surrey, RH1 1QS, UK, Tel: +44-737-68611, Telex: 948669 TOPJNL. This journal contains articles on: sewage treatment and sludge disposal, water treatment and distribution, sewer renovation, river quality and control, pumping technology, desalination, and effluent treatment and its reuse. All major articles have synopses in French and German. Published (quarterly) by: Industrial and Marine Publications. (IAWPRC)

**GUIDE TO US BASED AGENCIES INV IN WATER & SANITATION PROJ IN DEV COUNTRIES** 2121 Virginia Avenue NW, Washington DC, 20037, USA. The Guide is designed to encourage information exchange and co-operation among voluntary organizations and other groups. Published by: National Council for International Health (NCIH). (IAWPRC)

**INQUINAMENTO** Via Nuova Rivoltana 952F9, Limite, Milano, 20090, Italy, +39-2-92771, Fax: 331342 ETASKOI. The articles in this journal are all concerned with aspects of pollution, particularly air and water pollution. In addition, there are items on new products and a reader inquiry service. Published (In Italian) by: Etas Kompass SpA. (IAWPRC)

**INTERNATIONAL DRINKING WATER SUPPLY AND SANITATION DECADE DIRECTORY** PO Box 124, Liverpool, L69 2LQ, UK. This edition contains entries for 136 developing countries, and policy statements from almost 100 external support agencies. Information under each country includes details of popu-

## TECHNICAL JOURNALS

lation, GNP, health statistics, present water and sanitation facilities and future plans. The Directory aims to provide a link between those in need of technical or financial assistance and those with the means to provide such assistance. Published (2nd edition, 1984) by:World Water. (IAWPRC)

**INTERNATIONAL JOURNAL OF WATER RESOURCES DEVELOPMENT** 6 Crofton Terrace, Dun Laoghaire, Co Dublin, Eire. A multi-disciplinary journal covering all aspects of water development and management. It contains state-of-the-art review articles, case studies and reports on the applications of the latest research results. Published (quarterly) by:Tycooly International Publishing Ltd. (IAWPRC)

**INTERNATIONAL TRADE PUBLICATIONS LTD** Queensway House 2 Queensway, Redhill, Surrey, RH1 1QS, UK, Tel: +44-737-768611, Telex: 948669, Fax: +44-737-761989, Contact: Peter Goodwin. Publishers of "Middle East Agribusiness", "Asian Agribusiness", "Far East Water and Sewerage" and "Middle East Water and Sewerage". International business magazines aimed at purchasers and specifiers in the regions covered by the titles.

**INTERNATIONAL WATER REPORT** North Shore Atrium, 6800 Jericho Turnpike, Syosset, NY, 11791, USA. An American newsletter on developments in products, research, pollution and waste control, water supply and treatment and legislation in Europe, Asia, Africa, South America and Oceania. Published (bimonthly) by:Water Information Centre Inc. (IAWPRC)

**IRRICAB - CURRENT ANNOTATED BIBLIOGRAPHY OF IRRIGATION** Headington Hill Hall, Oxford, OX3 0BW, UK, Tel: +44-865-64881, Telex: 83177. Several thousands of journals, monographs, books, conference proceedings and other non-periodical literature are covered for this publication. In particular, it contains abstracts of material related to on-farm water management. Published (quarterly) by:Pergamon Press Ltd. (IAWPRC)

**IRRIGATION EQUIPMENT MANUFACTURERS DIRECTORY** Headington Hill Hall, Oxford, OX3 0BW, UK, Tel: +44-865-64881, Telex: 83177. A listing of over 400 manufacturers of irrigation equipment, intended for all those working in the field who regularly purchase this type of equipment. Published by:Pergamon Press. (IAWPRC)

**IRRIGATION:INTERNATIONAL GUIDE TO ORGANISATIONS AND INSTITUTES** Headington Hill Hall, Oxford, OX3 0BW, UK, Tel: +44-865-64881, Telex: 83177. This publication is intended for policy-makers, planners, managers, research and teaching staff interested in locating organizations concerned with irrigation - 864 organizations in 109 countries are listed. Published by:Pergamon Press Ltd. (IAWPRC)

**MARINE ENVIRONMENTAL RESEARCH** Crown House, Linton Rd, Barking, Essex, IG11 8JU, UK, Tel: +44-1-594-7272. Papers on all aspects of the marine environment in the fields of biology, chemistry and oceanography are published in this journal. It is par-

ticularly intended to provide a forum for work on marine monitoring with an emphasis on methods and results. Published (quarterly) by:Elsevier Applied Science Publishers. (IAWPRC)

**MARINE POLLUTION BULLETIN** Headington Hill Hall, Oxford, OX3 0BW, UK, Tel: +44-865-64881, Telex: 83177. This bulletin contains news, comment, reviews and research reports, not only on the threat of noxious substances to marine life, but also on the management and productivity of the marine environment in general. Published (monthly) by:Pergamon Press Ltd. (IAWPRC)

**MIDDLE EAST AND WORLD WATER DIRECTORY** PO Box 135121, Beirut, Lebanon. This directory comprises two volumes: A. 10,000 listings for public and private sector firms, mainly import/export bureaux, distributors, contractors, wholesalers, engineering firms and sellers of water and sewage equipment in 53 countries located in the (IAWPRC)

**MIDDLE EAST WATER AND SEWAGE** Queensway House 2 Queensway, Redhill, Surrey, RH1 1QS, UK, Tel: +44-737-68611, Telex: 948669 TOPINL. This journal contains technical articles, concentrating on matters of relevance to the Middle East, items of general news, a calendar of forthcoming events, and a publications section. Published (quarterly) by:Fuel and Metallurgical Journals Ltd. (IAWPRC)

**MUNICIPAL WASTEWATER REUSE NEWS** 6666 West Quincy Avenue, Denver, Colorado, 80235, USA. A 24 page newsletter publishing items on forthcoming conferences, seminars and courses. It contains a section on published literature, with some articles printed in full. Half of the publication is taken up with a section on Water Reuse Plans and Demonstrations, looking at various plants in operation and different techniques, from all over the world. Published by:American Waterworks Association (AWWA). (IAWPRC)

**OEBALIA** A Cerruti, Via Roma 3, Taranto, 74100, Italy, Tel: +99-25434. This journal is concerned with all aspects of marine biology and oceanography. It publishes research papers in English or French, with particular emphasis on scientific and technological innovations in the field of marine biology. Published by: Istituto (IAWPRC)

**OIL AND PETROCHEMICAL POLLUTION** Crown House, Linton Rd, Barking, Essex, IG11 8JU, UK, Tel: +44-1-594-7272. A wide range of subjects within the field of oil pollution control are covered by this journal. Key issues include techniques for the prevention and control of oil pollution, the effects of oil and petrochemicals on the environment, human health and safety hazards, economic aspects of pollution control, and legal issues relating to pollution. Published (quarterly) by: Elsevier Applied Science Publishers. (IAWPRC)

**OZONE SCIENCE AND ENGINEERING** Headington Hill Hall, Oxford, OX3 0BW, UK, Tel: +44-865-64881, Telex: 83177. The latest and most important information on ozone, its reactions, applications, engineering design of reactors, plants and other ozone facilities, operating data, and plant experience are

published in this journal. Published (quarterly) by Pergamon Press (IAWPRC)

**PERGAMON PRESS PLC** Headington Hill Hall, Oxford, OX3 0BW UK Tel: +44-865-64881, Telex: +83177, Fax: +44-865-60285. Pergamon Press, one of the largest STM publishers in the world, is the official publisher for the International Association on Water Pollution Research and Control (IAWPRC). Free sample copies of the IAWPRC journals *Water Research*, *Water Science and Technology*, and comprehensive IAWPRC Publications Catalogue, are available from our Oxford office. Please write for further information.

**REED BUSINESS PUBLISHING LTD** Quadrant House, The Quadrant, Sutton, Surrey, SM2 5AS, UK, Tel: +44-1-661-3500, Telex: 892084, Fax: +44-1-661-8904, Contact: Alan Manchester. Publish "International Water Power and Dam Construction".

**REVUE INTERNATIONALE D'OCEANOGRAPHIE MEDICALE** Parc de la Côte, 1 Avenue Jean Lorrain, Nice, 06300, France. Papers on marine pollution topics are published in this journal, in either French or English. Published by: CERBOM. (IAWPRC)

**THE URBAN EDGE** Room N-231 1818 High St, NW, Washington DC, 20433, USA, Tel: +1-202-477-5476, Telex: IT 440098 WORLDBANK. Published in English, Spanish and French for the World Bank, this journal is concerned with practical approaches to urban problems in developing countries. Water supply and sanitation are of particular concern. Published (10 times a year) by: The World Bank. (IAWPRC)

**VULKAN-VERLAG GmbH, HAUS DER TECHNIK** PO Box 10 39 62, HOLLERSTR 1G, Munich, Tel: +49-201/82-00-2-02, Fax: +49-201/82-00-2-04. Specialized technical publications for the supply industry. Most publications carry advertising by producers and service companies and are therefore efficient platforms for international marketing.

**WATER QUALITY BULLETIN** Box 5050, Canada Centre for Inland Waters, 867 Lakeshore Rd, Burlington, Ontario, L7R 4A6, Canada, Tel: +1-416-637-4374. This journal includes articles ranging from pure research on problems of water quality to papers describing the administration of the water industry in different countries, and the progress of such schemes as the International Drinking Water Supply and Sanitation Decade. Published mthly by: WHO Collaborating Centre on Surface & Ground Water Quality. (IAWPRC)

**WATER RESOURCES JOURNAL** United Nations Building, Rajadamnern Avenue, Bangkok, 10200, Thailand. This is a review journal of the Natural Resources Division of ESCAP (Economic and Social Commission for Asia and the Pacific). The contents include news of current developments of regional interest, accounts of national experience applicable elsewhere in (IAWPRC)

**WATER SUPPLY** Headington Hill Hall, Oxford, OX3 0BW, UK, Tel: +44-865-64881, Telex: 83177. This journal publishes most of the papers submitted at meetings sponsored by the IWSA, including the biennial con-

gresses, specialized conferences and workshops, and some regional conferences. Published by: Pergamon Press Ltd. (IAWPRC)

**WATERFRONT** 866 United Nations Plaza, Room A415, New York, NY, 10017, USA, Tel: +1-212-754-3270, Telex: 62346 Cable. This newsletter is produced by UNICEF, and contains information on recent developments in the fields of water supply and sanitation techniques in the Third World. It carries detailed information on new methods, which can be used by field workers, and on the progress of various programmes connected with the Water Decade. Published by: UNICEF Water and Environmental Sanitation Team (WET). (IAWPRC)

**WATERLINES** 9 King St, London, WC2E 8HW, UK, Tel: +44-1-836-9434. A publication dealing with appropriate technologies and appropriate solutions in the field of water supply and sanitation in developing countries. It contains papers from fieldworkers, often describing specific items of equipment which are low-cost and can be easily assembled and maintained. Published by: Intermediate Technology Publications Ltd. (IAWPRC)

**WORLD WATER** P O Box 101, Telford House, 26 Old St, London, EC1, UK, Tel: +44-1-253-9999. A journal concerned mainly with civil engineering aspects of the water industry containing news, papers, book reviews, articles on new technology, and information on latest loans, contracts and tenders. Published (monthly) by: Thomas Telford Ltd. (IAWPRC)

## Training Establishments

**ARMFIELD TECHNICAL EDUCATION COMPANY LTD** Bridge House, West St, Ringwood, Hampshire, BH24 1DY, UK, Tel: +44-425-478781, Fax: +44-425-470916, Contact: Georgina Froud. Armfield design and supply educational engineering equipment for irrigation, water management, water treatment, hydraulics and fluid mechanics. Armfield produce two shortform brochures which describe the full range of equipment available.

**SOUTHEAST ASIAN FISHERIES DEVELOPMENT CENTRE (SEAFDEC)** P O Box 4, Phrapradeng, Samutprakarn, Thailand. SEAFDEC has three major departments for training in fisheries, (Thailand), for marine fisheries research, (Singapore) and for fish culture (Philippines).

**SPRINKLINK** PO Box 45054, Garland, TX, 75045-0054, USA, Tel: +1-214-530-3631. Basic landscape irrigation seminars.

**WATER TRAINING** Tadley Court Tadley Common Road Tadley, Basingstoke, Hants, RG26 6TB, UK, Tel: +44-7356-3011, Telex: 846067, Fax: +44-7356-77000, Contact: Brian Phillips. Water Training, owned by the UK public sector water industry, provides a comprehensive training service covering every aspect of the water industries. Over 600 customer organisations have benefitted from this service.





**Institutions &  
Organisations.**

# A DIPLOMATIC APPROACH TO DEVELOPMENT

by

Richard Franceys

**Water supply and sanitation projects are fashionable among the Non-Governmental Organisations (NGOs) and Voluntary Agencies (VAs). At the smaller end of the aid and development business, money and personnel can usually be found to assist in the provision of clean drinking water.**

And the more informed agencies also become involved with the not-so-glamorous safe disposal of excreta.

The supporters of NGOs, usually private individuals in the OECD countries, have learned the linkage — clean water leads to improved health.

It may be boreholes from Swedish Free Mission in Sudan or concrete-lined, hand-dug wells from Wateraid in Ghana. It could be rainwater catchment tanks from the Church of the Province of Kenya in Nakuru or gravity flow distribution systems with VSO personnel



*OXFAM  
emergency water  
treatment plant*

*Rainwater catchment tank.*



in Nepal or rural sanitation from IVS in Lesotho. Size of project can range from a hydroelectric scheme with over 1.5 kilometres of tunneling aided by the United Mission to Nepal down to the sale of an improved pit latrine slab by Oxfam in Juba.

The International Council for Voluntary Agencies, a worldwide grouping of NGOs, has stated: "Voluntary service and giving by individuals and groups to meet the needs of those suffering the consequences of natural or man-made disasters, and to strengthen their ability to keep themselves, is one of the more humane chapters in the history of international relations. Some of its characteristics have not changed for centuries."

In 1985 the major NGOs contributed \$2,885 million for development and relief activities with an additional \$1,510 million given by governments through the NGOs. This funding goes to a wide range of projects but is generally aimed at improving the lives of the poorest through an emphasis on integrated rural and peri-urban development projects. Health, education, agriculture, training and community developments are the major sectors with water supply and sanitation playing a prominent role within different sectors.

So the projects continue to the general satisfaction of the beneficiaries who are usually pleased to have the convenience of increased quantities of water closer to their homes. While they themselves usually disregard any supposed health benefits.

Alistair White, in his book on community participation in village water supply, comments that "volun-

tary agencies are not under the same political constraints which government agencies may be under, for other groups.

This usually leads to attempts to hand over responsibility to the intended beneficiaries in a more truly participative manner. Rather than telling people: "Here is your hand pump — now you must prepare the site for the drilling rig by next Tuesday," the agency representative asks: "How is the situation of your water supply? Are you happy with your facilities for sanitation?" Depending on the response, the agency and the community can then begin to explore different approaches to solving the perceived problems. With the resources generally available to the people. At the timing convenient to the people. With the skills and technology transfer necessary to give power to the people.

This takes time and it takes skilled development workers. It takes a commitment to meet people where they are and not simply to impose the instant technological fix.

But it is in these areas where the NGOs have the greatest potential to demonstrate their commitment to the poorest by listening to them and then passing on that experience to those who control the more massive governmental projects. ◦

#### References

- Community Participation In Water and Sanitation*, Alistair White, IRC 17, 1981.  
*The Courier*, No. 104, July-August, 1987.

# UNITED NATIONS AGENCIES

## United Nations Agencies

**ECONOMIC AND SOCIAL COMMISSION FOR ASIA AND THE PACIFIC (ESCAP)** The United Nations Building, Rajadamnern Avenue, Bangkok 2, Thailand. Activities include the establishment of regional centres for training and research purposes, the promotion of schemes and projects for regional co-operation, the distribution of information and the provision of advisory services over a wide range of subjects.

**ECONOMIC COMMISSION FOR LATIN AMERICA AND THE CARIBBEAN (ECLAC)** Casilla 179-D, Santiago, Chile, Tel: +56-2-485051, Telex: +240077. Activities include collecting information for research, recommending government and inter-governmental action and offering advisory services. Has a permanent water resource unit within the secretariat.

**ECONOMIC COMMISSION FOR AFRICA (ECA)** P O Box 3001, Addis Ababa, Ethiopia. Activities include collecting information for research, recommending government and inter-government action and offering advisory services. It also promotes studies into the economic and technological development of the region.

**ECONOMIC COMMISSION FOR WESTERN ASIA (ECWA)** P O Box 27, Baghdad, Iraq. Initiates and participates in measures for facilitating concerted action for the economic reconstruction and development of Western Asia.

**FOOD AND AGRICULTURE ORGANISATION (FAO)** Via delle Terme di Caracalla, Rome, 00100, Italy. A specialised agency of the UN, founded in 1945, it aims to increase the efficiency of the production and distribution of all food and agricultural products, to improve the condition of rural populations and to raise levels of nutrition in the developing nations.

**INTERNATIONAL BANK FOR RECONSTRUCTION AND DEVELOPMENT** 1818 H St, Washington D C, NW, 20433, USA, Tel: +1-202-477-1234.

**UNITED NATIONS CENTRE FOR HUMAN SETTLEMENTS (HABITAT)** PO Box 30030, Nairobi, Kenya, Tel: +254-2-520380, Telex: +22992. Technical co-operation projects in all developing regions, including technologies for urban and rural water supply and sanitation systems. Also covers such areas as low-cost building technology, rural and urban housing and infrastructure development and urban and regional planning.

**UNITED NATIONS CHILDREN'S FUND** 866 United Nations Plaza, New York, NY, 10017, USA, Tel: +212-754-1234, Telex: 127895 or 239521. Cable: UNICEF, New York The primary objective of UNICEF is to improve the situation of children everywhere, particularly those in developing countries who are in the greatest need. Water supply and sanitation are often a major priority. (IAWPRC)

**UNITED NATIONS DEVELOPMENT PROGRAMME** 1 United Nations Plaza, New York,

NY, 10017, USA, Tel: +1-212-754-4790, Telex: 983-22345. CABLE: UNDEVPRO (NEW YORK) The world's largest agency for technical co-operation. Its funds are distributed to developing countries to aid technical and financial planning, particularly national and regional development planning. (IAWPRC)

**UNITED NATIONS EDUCATIONAL SCIENTIFIC AND CULTURAL ORGANIZATION** 7 Place de Fontenoy, Paris, F-75700, France, Tel: +33-1-4577-1610, Telex: 270602/204461. CABLE: UNESCO PARIS UNESCO has developed various forms of intergovernment co-operation concerned with the environmental sciences and research on natural resources. One example is the International Hydrological Programme (IHP), dealing with the scientific aspects of water resources assessment and management. (IAWPRC)

**UNITED NATIONS ENVIRONMENT PROGRAMME** PO Box 30552, Nairobi, Kenya, Tel: +254-2-333930/332383, Telex: 22068 or 22173. CABLE: UNITERRA, Nairobi Among the programmes administered by UNEP is the initiative on environmental assessment called Earthwatch. Earthwatch has three main components: the International Referral Service for Sources of Environmental Information (IRS), the International register (IAWPRC)

**UNITED NATIONS INDUSTRIAL DEVELOPMENT ORGANISATION (UNIDO)** P O Box 300, Vienna International Centre, A-1400 Vienna, Austria. Promotes the industrialisation of developing countries and co-ordinates UN activities in this field. It is an operational as well as advisory body and derives the bulk of its technical co-operation funds from the United Nations Development Programme and from voluntary contributions.

**WHO - WORLD HEALTH ORGANIZATION** 20 Avenue Appia, Geneva 27, 1211, Switzerland, Tel: +41-22-912111, Telex: 27821 OMS GENEVA. WHO is a specialized agency of the United Nations with primary responsibility for international health matters and public health. It is co-operating with other international organizations to implement the United Nations International Drinking Water Supply and Sanitation Decade, which runs from 1981 to 1990. Regional offices for Africa, Eastern Mediterranean, South East Asia, Western Pacific, Europe and the Americas. (IAWPRC)

## Bilateral Development

### Organisations

**AGENCY FOR INTERNATIONAL DEVELOPMENT** Office of Health Room 709, U S Agency for International Development, Washington DC, 20523, USA, Tel: +1-703-235-8926, Telex: +44-00-01. Four regional bureaux - for Africa, near East, Asia and Latin America. AID will consider funding projects where less than 20 litres of safe drinking water per person is not available and where significant health problems are caused by poor domestic water

**AUSTRALIAN DEVELOPMENT ASSISTANCE BUREAU** P O Box 887, Canberra City, ACT 2601,

## BILATERAL DEVELOPMENT ORGANISATIONS

Australia, Tel: +61-62-49-57-33, Telex: +62631. Grant aid in response to specific requests. ADAB has assisted water supply and sanitation schemes in S E Asia.

**BELGIAN ADMINISTRATION FOR DEVELOPMENT CO-OPERATION** Place Du Champ De Mars 5, Brussels, 1050, Belgium, Tel: +32-2-519-02-11, Telex: +21-376. Maintains co-operation missions in Algeria, Burundi, Ecuador, Gabon, Indonesia, Ivory Coast, Kenya, Malaysia, Morocco, Niger, Peru, Rwanda, Senegal, Sudan, Suriname, Tunisia, United Republic of Cameroon, Vietnam, Zaire and Zambia. Acts directly on a bilateral basis through loans and participation.

**CAISSE CENTRALE DE COOPERATION ECONOMIQUE** Cité Du Retiro, 33/37 Boissy Dangles, Paris, Cedex 08, 75379, France, Tel: +33-1-42-66-93-66, Telex: +212632, Fax: +33-1-42-66-03-31. Bilateral aid in grants or loans. Considerable experience in financing water supply projects in developing countries.

**CANADIAN INTERNATIONAL DEVELOPMENT AGENCY** 200 Promenade du Portage, Hull, Quebec, K1A 0G4, Canada, Tel: +1-819-997-3803, Telex: 053-4140. CIDA was established in 1968 as a successor to the External Aid Office. Through this agency, a wide spectrum of assistance is supplied to developing countries, including financial and technical assistance, capital equipment and the services of experts. (IAWPRC)

**COMMONWEALTH DEVELOPMENT ASSOCIATION (CDC)** One Bessborough Gardens, London, SW1V 2JQ, UK, Tel: +44-1-828-4488, Telex: +51-21431 VELOP G, Fax: +44-1-828-6505, Contact: Nicola Sampson.

**DANISH INTERNATIONAL DEVELOPMENT AGENCY** Ministry of Foreign Affairs, Asiatisk Plads 2, Copenhagen K, DK-1448, Denmark, Tel: +45-1-920000, Telex: 31292 ETR DK. Danish assistance to developing countries through this agency is divided almost equally between grants and loans on highly concessional terms. Most of the grants are disbursed for project aid, another major component being technical (personnel assistance). (IAWPRC)

**ECONOMIC AND SOCIAL COMMISSION FOR ASIA AND THE PACIFIC** National Resources Division United Nations Building Rajadamnerne Avenue, Bangkok, 10100, Thailand, Tel: +66-2-282-9161/282-9200, Telex: 82392 or 82315 ESCAP. A regional arm of the United Nations, with a headquarters in Thailand. The Water Resources Section of the natural resources programme of ESCAP promotes a comprehensive approach to development and management of national water resources. The section's programme concentrates on improvement of water resources data systems, water policy and legislation, technical advisory services, efficiency in water use and dissemination of technical information through its publications - Confluence and Water Resources (IAWPRC)

**FEDERAL MINISTRY FOR ECONOMIC COOPERATION** Karl Marx Strasse 4-6, Bonn 1, 53, Federal Republic of Germany, Tel: +49-228-5351, Telex: +8-869-452.

**FINNISH INTERNATIONAL DEVELOPMENT AGENCY** Mannerheimintie 15c, Helsinki 26, 00260, Finland, Tel: +358-0-40607, Telex: +124636. Water supply and sanitation has figured strongly in recipients' use of FINNIDA'S bilateral aid.

**FONDS D'AIDE ET DE COOPERATION** Ministère de la Coopération et Développement, 20 Rue Monsieur, Paris, 75700, France, Tel: +33-14-783-1010, Telex: +202-363, Fax: +33-43-06-97-40.

**GERMAN AGENCY FOR TECHNICAL CO-OPERATION** Dag-Hammarskjöld-Weg 1, PO Box 5180, Eschborn 1, D-6326, German Federal Republic, Tel: +49-6196-401-265, Telex: 417405 GTZ D. This agency is responsible for the execution of technical co-operation on behalf of the German government. Under technical co-operation, support is provided mainly for advisory services by seconded experts and by consulting firms for technical equipment supplied to these experts (on a grant basis). (IAWPRC)

**GERMAN APPROPRIATE TECHNOLOGY EXCHANGE** Postfach 5180, Eschborn 1, D-6236, West Germany, Tel: +49-6196-79-0, Telex: +41-523-0.

**ITALIAN MINISTRY OF FOREIGN AFFAIRS FOR DEVELOPMENT COOPERATION** Farnesia, Rome, 00100, Italy. In the main, Egypt, sub-Saharan and East African countries, China, Pakistan, Thailand, Malaysia, Colombia and Peru receive Italian aid for water supply and sanitation projects.

**JAPAN INTERNATIONAL CO-OPERATION AGENCY** Shinjuku Mitsui Building, 2-1-1 Nishi-shinjuku, Shinjuku-ku, Tokyo, Japan, Tel: +3-346-5311, Telex: +J22271.

**MINISTERIE VAN BUITENLANDSE ZAKEN** Bezuidenhoubeweg 67, 'S Gravenhage, Fb, 2500, The Netherlands, Tel: +31-70-48-64-86, Telex: +31326.

**MINISTRY OF WORKS AND DEVELOPMENT** P O Box 12-041, Wellington, , New Zealand. New Zealand has been giving considerable support and aid in the fields of water and sanitation since 1974, and projects aided have included hydro-electric development, well drilling and rainwater catchments.

**NORWEGIAN AGENCY FOR INTERNATIONAL DEVELOPMENT** Victoria Terrasse 7, Oslo 3, , Norway, Tel: +47-2-314055, Telex: 16548. Norway's aid aims at improving life for the poorest section of the population in the recipient countries. Thus, water supply and sanitation has for a long time been a priority sector. Aid is supplied mainly in the form of funds and personnel. (IAWPRC)

**OVERSEAS DEVELOPMENT ADMINISTRATION** Eland House, Stag Place, London, SW1E 5DH, UK, Tel: +44-1-213-4937/4954/4963, Telex: 263907/8. The Overseas Development Administration is part of the Foreign and Commonwealth Office of the UK. It provides the framework through which the UK gives capital aid, technical co-operation on a project basis, emergency aid and other components, including training, which

## BILATERAL DEVELOPMENT ORGANISATIONS

go to make up an integrated overall development plan. (IAWPRC)

**SWEDISH INTERNATIONAL DEVELOPMENT AUTHORITY (SIDA)**, Stockholm, S-105 25, Sweden, Tel: +46-8-15-01-00, Telex: +11450, Fax: +46-8-32-21-41. Domestic water supply activities supported by SIDA should be partnered by measures to prevent water-related diseases. Funds have been made available for special programmes including low-cost technology.

**SWISS DEVELOPMENT COOPERATION, DIRECTORATE OF DEV CORP & HUMANITARIAN AID**, Berne, 3003, Switzerland. Generally, Swiss aid to water supply projects includes financial assistance for buying equipment and materials as well as technical assistance. Support in this field is seen as long-term, involving the training of local personnel.

**THE OVERSEAS ECONOMIC COOPERATION FUND** Takebashi-Godo Building, 1-4-1 Otemachi, Chiyoda-Ku, Tokyo, Japan, Tel: +3-215-1311.

**WATER AND SANITATION FOR HEALTH PROJECT** Co-ordination and Information Center, 1611 N Kent Street Room 1002, Arlington, Virginia, 22209, USA, Tel: +1-703-243-8200, Telex: WUI 64552. Cable address: WASHAID The WASH project is a contractor-operated technical assistance service unit under the management of the Bureau for Science and Technology which is part of the Agency for International Development in the USA (US AID). The areas of support available from WASH are primarily focused on rural and urban-fringe water supply and sanitation improvement and include: general technical assistance, technology transfer, human resource development and training, community education and participation and technical and development information. (IAWPRC)

**WATER SUPPLY AND ENVIRONMENTAL SANITATION DEPARTMENT** 1-2-2 Kasumigaseki, Chiyoda-Ku, Tokyo, Japan, Tel: +3-503-1711.

### International Organisations

**AIDIS - INTER-AMERICAN ASSOCIATION OF SANITARY AND ENVIRONMENTAL ENGINEERING** Apartado Aereo-5820, Bogota, Colombia, Tel: +57-1-244-6597, Telex: 45328. Aidis is an international professional association, with regional branches in all the countries in the Americas. It publishes technical documents, journals and newsletters and organizes conferences and seminars on various topics in water pollution research and control, including a regular biennial Latin American conference, the venue for which alternates north and south of the equator. (IAWPRC)

**COMMONWEALTH SCIENCE COUNCIL (CSC)** Marlborough House, Pall Mall, London, SW1Y 5HX, UK. Established in 1946, the CSC aims to promote scientific collaboration between member countries of the Commonwealth and to increase the capabilities of individual nations to use science and technology for their economic, social and environmental development.

Membership is open to all members of the Commonwealth.

**HYDRAULICS RESEARCH LTD (HRL)**, Wallingford, Oxfordshire, OX10 8BA, UK, Tel: +44-491-35381. The Overseas Development Unit conducts research into problems arising in developing countries in the field of water resources, irrigation and estuarine and coastal hydraulics. The Unit also carries out contract investigations for governments of developing countries, it provides staff for advisory visits for technical co-operation projects and organises training for overseas engineers.

**ICID - INTERNATIONAL COMMISSION ON IRRIGATION AND DRAINAGE** 148 Nyaya Marg, Chanakypuri, New Delhi, 110021, India, Tel: +91-11-376-837. This organization has members in 77 countries. Its activities include a programme of conferences and various publications. (IAWPRC)

**INTERNATIONAL ASSOCIATION ON WATER POLLUTION RESEARCH AND CONTROL** 1 Queen Anne's Gate, London, SW1H 9BT, UK, Tel: +44-1-222-3848, Telex: 918518, Fax: +44-1-222-1811. International Association on Water Pollution Research and Control (IAWPRC) - international membership organisation with members in 75 countries worldwide, for professionals working on water pollution control and water quality management problems. Publishes journals (Water Research, Water Science and Technology), books, scientific and technical reports and a magazine (Water Quality International). Organizes some 15-20 conferences worldwide each year. Has 20 expert groups working on a wide range of projects.

**INTERNATIONAL ASSOCIATION ON WATER POLLUTION RESEARCH AND CONTROL (IAWPRC)** 1 Queen Anne's Gate, London, SW1H 9BT, UK, Tel: +44-1-222-3848, Telex: +918518, Fax: +44-1-222-1811. International Membership Organisation with members in 75 countries, for professionals working on water pollution control and water quality management problems. Publishes journals (Water Research, Water Science and Technology), books, scientific and technical reports and a magazine (Water Quality International). Organises 15-20 conferences worldwide each year. Has 20 expert groups working on a wide range of problems in water pollution control. Wide range of member benefits. Individual, corporate (companies) and student membership available.

**INTERNATIONAL COMMISSION ON LARGE DAMS** 151 Bld Haussmann, Paris, 75008, France, Tel: +33-1-4764-6733. This Commission has a programme of triennial congresses. It produces various publications and 71 countries are now represented in its membership. (IAWPRC)

**INTERNATIONAL COMMISSION ON IRRIGATION AND DRAINAGE THE INST OF CIVIL ENGINEERS** 1-7 Great George St, London, SW1P 3AA, UK, Tel: +44-1-630-0726, Fax: +44-1-222-7500, Contact: Mr Tyler.

**INTERNATIONAL COUNCIL OF SCIENTIFIC UNIONS** 51 Bld de Montmorency, Paris, 75016, France,

## INTERNATIONAL ORGANISATIONS

Tel: 33-1-4525-0329, Telex: ICSU 630553 F. The principal objective of ICSU is to encourage international scientific activity for the benefit of mankind. It does this by initiating, designing and co-ordinating international scientific research projects. ICSU acts as a focus for the exchange of ideas, the communication of scientific information and the development of standards in methodology, nomenclature, units etc. Its activities include conferences, seminars, workshops and a wide range of publications. (IAWPRC)

**INTERNATIONAL DEVELOPMENT ASSOCIATION, EUROPEAN OFFICE** 66 Avenue d'Iena, Paris, 75116, France, Tel: +33-1-47-23-54-21.

**INTERNATIONAL IRRIGATION MANAGEMENT INSTITUTE (IIMI)** P O Box 2075, Colombo, Sri Lanka. IIMI is funded by a number of donor countries and organisations. The Institute concentrates on irrigation problems and carries out its operational activities through a network of programmes.

**INTERNATIONAL OZONE ASSOCIATION** Waserversorgung Zurich, Hardhof 9, Postfach, Zurich, CH-8023, Switzerland, Tel: +41-1-435-2111. The IOA assembles and disseminates information about ozone technology. It arranges seminars and workshops on the subject and several publications. (IAWPRC)

**INTERNATIONAL REFERENCE CENTRE FOR COMMUNITY WATER SUPPLY AND SANITATION** P O Box 93190, The Hague, 2509 AD, The Netherlands, Tel: +31-70-814911, Telex: 33296, Contact: Dick de Jong.

**INTERNATIONAL REFERENCE CENTRE FOR COMMUNITY WATER SUPPLY & SANITATION** P O Box 5500, 2280 HM Rijswijk, The Hague, The Netherlands, Tel: +31-70-949322, Telex: 33296 IRC NL. Cable: WORLDWATER, The Hague An information-oriented organization with an emphasis on support to national programmes for rural and urban-fringe water supply and sanitation. IRC operates through a worldwide network of national and regional institutions both in developing and industrialized countries. IRC is a non-profit foundation and a WHO collaborating centre for community water supply. (IAWPRC)

**INTERNATIONAL UNION FOR CONSERVATION OF NATURE** Avenue du Mont-Blanc, 1196 Gland, Switzerland, Tel: +41-22-647181. The main aim of IUCN is to promote action directed toward sustainable use and conservation of natural resources. It operates a Conservation Monitoring Centre and an Environmental Law Centre, and publishes various books and papers on conservation-related topics as well as environmental policy and law papers. (IAWPRC)

**INTERNATIONAL UNION OF PURE AND APPLIED CHEMISTRY** Bank Court Chambers, 2-3 Pound Way, Cowley Centre, Oxford, Oxfordshire, OX4 3YF, UK, Tel: +44-865-717744, Telex: 83147 ATTN IUPAC. The objectives of IUPAC are to promote continuing co-operation among chemists of its member countries, to study topics of international importance to pure and applied chemistry which need regulation, standardization, or codification, to co-operate with other interna-

tional organizations which deal with topics of a chemical nature, to contribute to the advancement of pure and applied chemistry in all its aspects. (IAWPRC)

**INTERNATIONAL UNION FOR CONSERVATION OF NATURE AND NATURAL RESOURCES (IUCN)** Ave Du Mont-Blanc, CH-1196 Gland, Switzerland, Tel: +41-22-64-71-81. Promotes scientifically-based action directed towards the sustainable use and conservation of natural resources.

**INTERNATIONAL WATER SUPPLY ASSOCIATION** 1 Queen Anne's Gate, London, SW1H 9BT, UK, Tel: +44-1-222-8111, Telex: 918518 WASSOC ATTN IWSA. IWSA aims to improve knowledge of public water supplies - technical, legal and administrative - and to encourage a maximum exchange of information on research, methods of water supply, statistics, ect. To this end it organizes seminars, conferences and workshops, and produces various publications. (IAWPRC)

**THE IRRIGATION ASSOCIATION** 1911 North Fort Myer Drive, # 1009 Arlington, VA, 22209, USA, Tel: +1-703-524-1200, Telex: 910-250-8332, Fax: +1-703-524-9544, Contact: Mark Williams. The Irrigation Association is a non-profit trade organization representing the irrigation industry at the national and international levels. Its primary purpose is to provide members with comprehensive programs and services helping them keep pace with the rapidly changing technology of the industry.

**ISWA - INTERNATIONAL SOLID WASTES AND PUBLIC CLEANSING ASSOCIATION** AGHTM 9 Rue de Phalsbourg, Paris, F-75017, France. An international professional society concerned with all aspects of city cleaning, waste collection, treatment, recycling and disposal. It operates as a membership organization and publishes a technical journal: Waste Management and Research. (IAWPRC)

**IWRA - INTERNATIONAL WATER RESOURCES ASSOCIATION** University of Illinois, 208 North Romine Street, Urbana, Illinois, 61801, USA. (IAWPRC) Reproduced from the 1987-88 Yearbook of the International Association on Water Pollution Research and Control (IAWPRC) with the Association's consent. IAWPRC, 1, Queen Anne's Gate, London, SW1H 9BT, England.

**SOCIETY FOR INTERNATIONAL DEVELOPMENT (SID)** Palazzo Civiltà del Lavoro, Rome, 00144, Italy. SID, with headquarters in Rome, is the largest and geographically most extensive international, non-governmental and non-profit-making development organisation in the world. A quarterly journal, 'Development', is published in three languages together with a regular newsletter, 'Compass'. Please contact direct for further details.

**TECHNICAL CENTRE FOR AGRICULTURAL AND RURAL CO-OPERATION (CTA)** POB 380, 6700 AJ Wageningen, The Netherlands. The Centre was established under the Second Lome Convention to facilitate the exchange of scientific and technical information between the European Community and African, Caribbean and Pacific states.

## INTERNATIONAL ORGANISATIONS

**THE IRRIGATION ASSOCIATION** 1911 North Fort, Myer Drive, #1009 Arlington, VA, 22209, USA, Tel: +1-703-524-1200, Telex: +910-250-8332, Fax: +1-703-524-9544, Contact: Mark Williams. The Irrigation Association is a non-profit trade organization representing the irrigation industry at the national and international levels. Its primary purpose is to provide members with comprehensive programs and services helping them keep pace with the rapidly changing technology of the industry.

**WELL DRILLERS ASSOCIATION** P O Box 13, Market Harborough, Leicestershire, LE16 9SJ, UK, Tel: +44-858-32054, Contact: John Bush. Major objectives are to group within the association for the benefit of industry and clients, all efficient and reputable drilling undertaking. To encourage members to collaborate in reducing costs and consequently charges to clients. To encourage the training of skilled technicians.

**WORLD FEDERATION OF ENGINEERING ORGANIZATIONS** 19 rue Blanche, Paris, 75009, France, Tel: 133-1-526-3482, Telex: 650594 FIWO. WFEW was founded in 1968 under the sponsorship of UNESCO. Its main activities are: promotion of training in the scientific and technical professions, instigating co-operation between national members and other international bodies, and assuring efficient (IAWPRC)

**WORLD METEOROLOGICAL ORGANIZATION** 41 Avenue Guiseppe-Motta, Case Postale 5, 1211 Geneva 20, Switzerland, Tel: +41-22-346400, Telex: 23260. The objectives of the WMO are: worldwide co-operation in making meteorological and hydrometeorological observations and in standardizing their publication, promotion of rapid weather information services, encouragement of research and training in meteorology, and promotion of activities in operational hydrology. (IAWPRC)

### Other Relevant Non-Governmental Organisations

**AMERICAN WATER WORKS ASSOCIATION** 6666 W Quincy Avenue, Denver, CO, 80325, USA, Tel: +1-303-794-7711, Telex: +45-0895, Fax: +1-303-794-7310. AWWA's publications cover the water supply industry. More than 350 titles are available on water source, quality, treatment and distribution, utility management, employee training and safety. Catalogue available.

**BRITISH WATER INTERNATIONAL LTD** 9 Harley St, London, W1N 2AL, UK, Tel: +44-1-436-7541, Telex: 937400, Fax: +44-1-436-7393, Contact: Mr Prestridge. Co-ordinating role for UK water industry. Promotion of overseas water and sewage projects, sponsorship and organisation of overseas and inward trade missions 100 member companies comprising consultants, contractors, public sector authorities and research organisations.

**CATHOLIC FUND FOR OVERSEAS DEVELOPMENT (CAFOD)** 2 Garden Close, Stockwell Rd, Lon-

don, SW9 9TY, UK. CAFOD is the national overseas aid fund of the Catholic Church in England and Wales and works through local Catholic churches. It provides grants without distinction of race or creed for developing communities overseas.

**CEDRE** Pointe de Diable, Plouzane - BP 308, Brest, F-29274, France, Tel: +33-98-491266, Telex: 940145 F. Centre de Documentation de Recherche et d'Experimentations sur les Pollutions Accidentelles des Eaux. This organization, in addition to carrying out research, will respond to pollution alerts and will initiate cleaning up operations. (IAWPRC).

**CHRISTIAN AID** PO Box 1, London, SW9 8BH, UK. The official relief and development agency of the 22 member churches of the British Council of Churches, of which it is a division. It co-ordinates with the World Council of Churches Division of inter-Church Aid. Refugee and World Service, it also works through UN agencies.

**CONCRETE PIPE ASSOCIATION** 60 Charles St, Leicester, LE1 1FB, UK, Tel: +44-533-536161, Fax: +44-533-514568, Contact: Ms Bahrey. Promotion, development and advisory service for design, specifications and construction of pipelines for sewage, service water, highway and agricultural drainage, consisting of pre-cast concrete pipes, bends and junctions, pipes for jacking manholes, soakaways and road gulleys.

**ENVIRONMENTAL LIAISON CENTRE** PO Box 72461, Nairobi, Kenya, Tel: +254-2-24770/340849. The aims of the ELC are to strengthen Non-Governmental Organizations working in the fields of environment, sustainable development and connected issues, particularly in the Third World, through the provision of information, financial assistance and training, and to build links between environmental NGOs around the world. It disseminates information through the Environmental Data System, publications, conferences and symposia. Advice is provided to Third World NGOs on project design and implementation, administration, fund raising and media relations. Water management is a main issue for the ELC. (IAWPRC)

**GROUP OF EXPERTS ON THE SCIENTIFIC ASPECTS OF MARINE POLLUTION** Via delle Terme di Caracalla (F10-F5315), Rome, I-00100, Italy. An advisory body consisting of specialized experts nominated by various sponsoring agencies (IMCO, FAO, UNESCO, WMO, WHO, IAEA, UNEP, UN). Its principal task is to provide scientific advice on marine pollution problems to the sponsoring agencies and to the Intergovernmental Oceanographic Commission (IOC). (IAWPRC)

**HYDROPLAN ASSOCIATION** 2 Rue Henri Barbusse, Marseille, Cedex 01, 13241, France, Tel: +33-9108-6115, Telex: 441-247. Hydroplan, originally a trade association for agricultural and urban water supply and rural development, Hydroplan now comprises of 65 firms specialising in hydraulics which employ 100,000 people, with a turnover of 2.5 billion dollars - of which a third is on for foreign markets.

**INTERMEDIATE TECHNOLOGY DEVELOPMENT**



## OTHER RELEVANT NON-GOVERNMENTAL ORGANISATIONS

**GROUP Myson House, Railway Terrace, Rugby, Warwickshire, CV21 3IT, UK, Tel: +44-788-60631, Telex: +317466.** ITDC is a British charity dedicated to increasing the income generating capabilities of poor people in rural areas of the developing world. The Group gives advice in the choice of appropriate technologies and provides technical assistance to local development projects aimed at improving the productivity of communities and small enterprises. Developed the IT windpump and publishes "Waterlines" quarterly journal and several relevant books. IT Development Techniques Ltd is the Group's marketing channel.

**INTERNATIONAL ASSOCIATION FOR GREAT LAKES RESEARCH** Large Lakes Research Station 9311 Groh Rd, Grosse Ile, Michigan, 48138, USA. This Association is a multidisciplinary body whose objectives are to promote, publish and present results on the North American Great Lakes and other large lakes of the world. (IAWPRC)

**INTERNATIONAL ASSOCIATION OF LIMNOLOGY (SIL)** Althanstrasse 14, Vienna, A-1090, Austria. (IAWPRC)

**OXFAM** 274 Banbury Rd, Oxford, OX2 7DZ, UK. An independent voluntary organisation campaigning to involve as many people as possible in the cause of world development and raising funds for the relief of poverty and suffering among under-privileged communities anywhere in the world.

**SAPP** P O Box 5513, Stockholm, S-11485, Sweden, Tel: +46-8-783-85-00, Telex: 19620 export s, Fax: +46-8-662-90-93, Contact: Mr Slodh. SAPP is the semi-official organization for collaborating Swedish companies specializing in the provision of services, technology, plants and equipment for agro-industry and agriculture, including water resources assessment and water supply.

**WAR ON WANT** Three Castles House, 1 London Bridge St, London, SE1 9SG, UK. War on Want seeks to inform both the public and decision-makers of the needs of the poor world and to mobilise support: this involves raising funds, education and campaigning in Britain and giving practical support to development programmes overseas.

**WATERAID** 1 Queen Anne's Gate, London, SW1H 9BT, UK, Tel: +44-1-222-8111, Telex: 918518, Fax: +44-1-222-1811, Contact: Annie Fokard. charity commission reg no 288701 Wateraid (a charity) assists local partners in Africa and Asia, with technical advice and materials, for domestic water supply and sanitation projects for poor communities. Projects supported must involve self-help.

### Financial and Insurance Institutions

**ABU DHABI FUND FOR ARAB ECONOMIC DEVELOPMENT (ADFAED)** P O Box 814, Abu Dhabi, UAE, Tel: +971-2-82-28-65, Telex: +22287. The ADFAED

was established in 1974 with the objective of "participating in the provision of loans and economic assistance to Arab, Asian and African countries, to support their economies and to aid their development projects so that they may achieve prosperity, security and a satisfactory standard of living".

**AFRICAN DEVELOPMENT BANK** 01 BP 1387, Abidjan 01, Ivory Coast, Tel: +225-32-07-11, Telex: +3717-3263-3498, Fax: +225-22-7004/33-21-72. A regional development bank which began operating in 1966. Its purpose is to contribute to the economic development and social progress of its regional members through a partnership of African and non-African countries.

**ARAB BANK FOR ECONOMIC DEVELOPMENT IN AFRICA (BADEA)** P O Box 2640, Mehdi Avenue, Abdel Ramman EL, Khartoum, Sudan, Tel: +249-11-73645/6, Telex: +22248. Established under the auspices of the League of Arab States in 1974, the Bank's aims are to collaborate in the economic development of African countries which are not members of the Arab League, encourage participation of Arab capital from other sources in their development and provide the necessary technical assistance.

**ARAB FUND FOR ECONOMIC AND SOCIAL DEVELOPMENT** P O Box 21923, (Safat) Kuwait City, Kuwait, Tel: +965-241-6470. Promotion of economic and social development of Arab countries through financing development projects, promoting investment and providing technical assistance.

**ARAB FUND FOR TECHNICAL ASSISTANCE TO AFRICAN AND ARAB COUNTRIES** c/o League of Arab States, 37 Khairaldin Basha St, Tunis, Tunisia. Coordinates finance technical assistance programmes of the LAS and other Arab agencies.

**ASIAN DEVELOPMENT BANK** P O Box 789, Manila, 2800, Philippines, Tel: +63-2-711-3851, Telex: +(RCA)-23103 (ITT)-40571 (ETPI)-63587, Fax: +63-2-741-7961. Regional development bank to promote economic and social development in the region by lending funds and providing technical co-operation to the developing member countries of Asia and the Pacific. The Asian Development Fund was set up in 1974 as the prime source for concessional lending. The Technical Assistance Special Fund finances project preparation, sectorial studies, development planning and other aspects of technical co-operation.

**ATLANTIC COMMUNITY DEVELOPMENT GROUP FOR LATIN AMERICA ADELA**, Luxembourg. A private investment trust founded in 1963 by commercial firms and banks in the United States, Canada, Japan and a number of European countries.

**CARIBBEAN DEVELOPMENT BANK (CDB)** PO Box 408, Wildey, St Michael, Barbados. A regional development bank which was established and came into operation in 1970 with headquarters at Bridgetown, Barbados. The Bank's aims are to contribute to the economic growth and development of member countries in the Caribbean, and to promote their economic co-operation and integration.

## OTHER RELEVANT NON-GOVERNMENTAL ORGANISATIONS

**CENTRAL AFRICAN STATES DEVELOPMENT BANK** B P 117, Brazzaville, People's Republic of the Congo, Tel: +242-81-02-12/21, Telex: +5306. The CASDB was established in 1975 by the governments of the Central African Customs and Economic Union to promote the economic and social development of member states.

**CITICORP INSURANCE BROKERS LTD** St Clare House, 30-33 Minorities, London, EC3N 1DD, UK, Tel: +44-1-488-1388, Telex: 883485, Fax: +44-1-480-5111, Contact: Mr Bovis. Insurance brokers for construction and engineering.

**EUROPEAN DEVELOPMENT FUND (EDF OR FED)** Directorate General VIII, 200 rue de la Loi, Brussels, 1049, Belgium. The instrument of financial and technical co-operation between the European Community and the African, Caribbean and Pacific states (ACP countries) which signed the Lome Conventions.

**EUROPEAN INVESTMENT BANK**, L-2950, Luxembourg, Tel: +352-4379-1, Telex: 3530 bnkeu lu, Fax: +352-43-77-04.

**INTER-AMERICAN DEVELOPMENT BANK (IDB/BID)** 808-17th St NW, Washington DC, 20577, USA. A regional development bank established in 1959 whose aims are to promote the development of member countries through financial assistance and technical co-operation.

**INTERNATIONAL BANK FOR RECONSTRUCTION AND DEVELOPMENT** 1818 H St, Washington D C, NW, 20433, USA, Tel: +1-202-477-1234.

**INTERNATIONAL MONETARY FUND** 700 19th St NW 2F9 Washington DC, 20431, USA, +1-202-623-7000, Tel: +1-202-623-4661, Fax: 248331 IMF UR.

**IRAQI FUND FOR EXTERNAL DEVELOPMENT** PO Box 2257, Alwaia, Baghdad, Iraq. Loans for, and participation in development projects in Arab states and other developing countries.

**ISLAMIC DEVELOPMENT BANK (IsDB)** P O Box 5925, Jeddah, Saudi Arabia. The stated purpose of the Bank is 'to foster the economic development and social progress of member countries and Muslim communities individually as well as jointly in accordance with the principles of Shariah'.

**LLOYD'S REGISTER INDUSTRIAL DIVISION** Lloyd's Register House, 29 Wellesley Rd, Croydon, CR0 2AJ, UK, Tel: +44-1-681-4040, Telex: 28636, Fax: +44-1-681-6814, Contact: Mr Skewins. Project management, quality assurance and independent third party inspection.

**MIDLAND BANK PLC** Walker Hse, 67 Queen Victoria St, London, EC4V 4AP, UK, Fax: +44-1-623-9393. 887305 Established in 1836, Midland Bank plc is one of the "Big Four" UK Clearing Banks. The Group itself is one of the largest bank organisations in the world and includes companies which offer comprehensive services in all aspects of trade and international finance. In

the United Kingdom there is an extensive network of around 2,700 branches, whilst the Bank conducts its business internationally through branches, offices, subsidiaries and affiliates in all five continents, and through its worldwide network of correspondent banks.

**OPEC FUND FOR INTERNATIONAL DEVELOPMENT** PO Box 995, 1011 Vienna, Austria, Tel: +43-1-515-640, Telex: +1-131734 1-34831. Grants for technical assistance and research and project loans or programme loans for developing countries except OPEC members.

**SAUDI FUND FOR DEVELOPMENT (SFD)** P O Box 5711, Jeddah, Saudi Arabia. The Fund's objectives are to participate in financing projects in developing countries. The Fund provides loans only for capital projects but has also provided money for feasibility studies, although its generally favoured sector is infrastructure.

**WEST AFRICAN DEVELOPMENT BANK** B P 1172, Lome, Togo, Tel: +228-21-59-06/21-42-44/21-01-13, Telex: +5289/5336. In promoting the development of its member states (Benin, Burkina Faso, Ivory Coast, Mali, Niger, Senegal and Togo) the Bank has provided assistance for village, rural and small town water supplies.

**WORLD BANK** 1818 H St, Washington DC, NW, 20433, USA, Tel: +1-202-477-1234. The World Bank is made up of three separate institutions - the International Bank for Reconstruction and Development (IBRD), the International Development Association (IDA) and the International Finance Corporation (IFC) - which share a common goal: helping to raise standards of living of the people in the developing countries by channelling financial resources from developed countries to the developing world.

### WATER, ENGINEERING AND DEVELOPMENT CENTRE (WEDC)

WEDC offers a wide range of courses for professionals involved in water supply, wastewater engineering and other aspects of urban and rural infrastructure. Duration from two weeks to two years. The Centre also provides in-country training and consultancy in developing countries.

Contact: **John Pickford.**  
**WATER, ENGINEERING AND  
DEVELOPMENT CENTRE (WEDC)**

Loughborough University of  
Technology, Leics LE11 3TU,  
UK, Tel: +44-509-222390, Telex:  
34319, Fax: +44-509-610231.

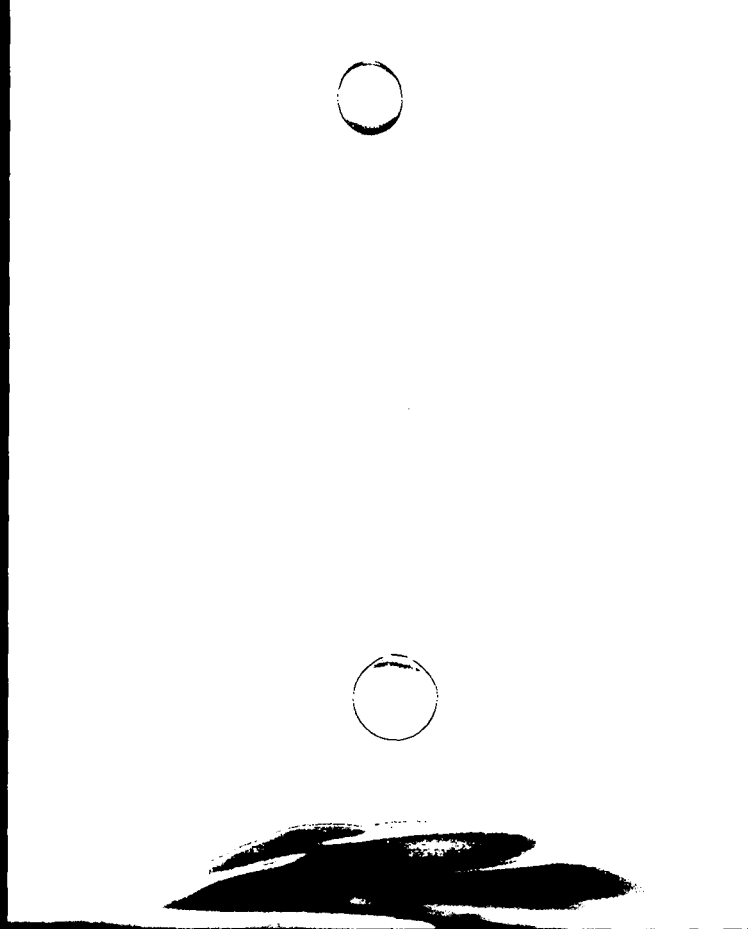

• General •

# 'BEYOND THE DECADE'

by

Alexander H. Rotival

**The goal : 'To provide all people with water of safe quality and adequate quantity and basic sanitary facilities by 1990.'**

The Decade, now in its eighth year, is rapidly approaching its 1990 deadline. Conceived at the United Nations Water Conference in Mar del Plata, Argentina, in March 1977, the International Drinking Water Supply and Sanitation Decade (IDWSSD) was formally launched by the General Assembly of the United Nations in November 1980 with the goal "To provide all people with water of safe quality and adequate quantity and basic sanitary facilities by 1990."

The goal pronounced by the Member States presupposed an increase by four times investments in water and sanitation projects in developing countries. This goal, although admirable, was highly optimistic and unrealistic. As a result, coverage levels by 1990 in water and sanitation for urban and rural populations, will fall short from the established goal of full coverage at the end of the Decade.

The World Bank estimates that coverage of rural and urban populations in potable water supply is unlikely to increase to more than 68% coverage in 1990 — a two percent increase from 1985. Similarly, coverage in cities will increase from 35% in 1985 to some 40% in 1990. With respect to rural water supply, coverage was 32% in 1981 and will probably not exceed 45% in 1990. The most alarming statistic refers to rural sanitation where fourteen percent of the population had coverage in 1981 and where the anticipated coverage increase during the Decade will be an insignificant one percent.

World Bank estimates are, by and large, comparable with WHO statistics based on reporting by Member States. The only major discrepancy relates to urban sanitation where WHO statistics postulate a coverage of 64% in 1990. What is particularly sobering is that by 1990 the number of unserved populations will increase in all domains except rural water supply. Simply put, less than 50% of developing country populations have access to adequate water supplies and only twenty percent adequate sanitation facilities.

A major factor in the present situation relates to the continuing population explosion. The increase in developing country populations is, however, not the whole story. An important influence has been the phenomena of rural exodus and, concomitantly, the dramatic increase in urban populations. The World Bank estimates that the developing world's urban population will increase from 1.2 million or 31% of the total population in 1985 to slightly more than 2 billion or 43% of the total population by the beginning of the 21st Century with more than 50% urban by 2125. On the other hand, rural populations during the same period will increase from 2.5 to 2.75 billion. While developing country rural population represented 69% of the total population in 1985, it

will represent only 57% in the year 2000.

Another major contributing factor to the gap between expectations at the beginning of the Decade and the approaching reality has been and continues to be economic stagnation in developing countries in the '80s. Declining or static per capita income and a growing debt burden severely affecting domestic investment hit hardest investments in the non-productive or social sectors of the national economy. Macro economic constraints translate themselves down to the communities' or individuals' ability to allocate resources. The World Bank estimates that the total investment required to meet the modest levels of coverage forecast for water and sanitation in developing countries is approximately US \$9 billion annually. This assumes the utilization exclusively of low cost technologies.

In judging the Decade, the quantitative yardstick of coverage should be balanced by the major strides, indeed, breakthroughs from a qualitative viewpoint due to a quantum leap in the improvement of sector programmes by developing country governments and donor agencies. This involved, enhanced co-ordination at a global and country level, the formulation of country sector strategies and action plans combined with rationalization of the management of the sector and, perhaps, most significantly and certainly most visibly the increasing adoption of low cost, sustainable and replicable technologies interfaced with a recognition of the pivotal role of software issues. The commitment both of the donor community and the developing countries to this approach is, perhaps, best exemplified by the "Abidjan Statement" of 30 African countries and 15 donor agencies at the *All Africa Seminar on Low-Cost Rural and Urban-Fringe Water Supply* at Abidjan, Côte d'Ivoire in October, 1986:

"Lasting health and economic benefits for the rural and urban-fringe populations of Africa can be achieved through increased community management of water supply and sanitation systems based on proven low-cost technologies. African Governments and donors are urged to identify and commit adequate resources and to provide all necessary support for the direct involvement of the communities in choosing, managing and paying for their water and sanitation systems".

## BEYOND THE DECADE



External donor support of this approach has been spearheaded by the UNDP/World Bank and the UNDP/WHO Decade programmes undertaken in close collaboration with major bilateral donors. The UNDP/World Bank Programme has played a catalytic role in developing and demonstrating low cost and easily maintainable water supply and sanitation technologies. This is, perhaps, most visibly exemplified by the Village Level Operation and Maintenance/Management (VLOM) handpump. The strides made in developing low cost technology can best be underscored by the estimate that across the board adaptation by developing countries of proven and available low cost technologies would result in global investment, to reach full coverage, being reduced by US \$400 billion.

The commitment to a sustained and replicable approach to DWSS was progressively forged during The Decade by six regional consultations of developing countries including the Abidjan Seminar and by three major consultations of donors or ESAs. The International Drinking Water Supply and Sanitation Consultation at Interlaken, Switzerland, in October 1987, attended by 30 external funding agencies had as its prime objective the carrying forward of co-ordinated strategies and resource mobilization activities, based on the Methodology — translated into an Action Agenda — outlined above, not only during the final years of The Decade but with respect to *Beyond the Decade*.

A notable accomplishment of the Interlaken Consultation was the proposed Framework For Global Cooperation Beyond The Decade which took cognizance of the work that remains to be accomplished, building upon the lessons learned which need much wider application. Specifically, this means a further integration of activities beyond community participation and hygiene education to include such major environmental concerns as wastewater reuse, solid wastes management, drainage and hazardous water manage-

ment. The broadening of the sector into environmental health and protection is a recognition of the critical importance of checking environmental deterioration in urban and peri-urban slums and squatter communities.

The Interlaken Consultation recognized "that collaboration among ESAs involved in this sector is essential if the remaining unserved populations are to be reached and if the Health for All goals are to be achieved by the end of this century. It was concluded that a collaborative framework should be established to support expanded efforts in accelerating and widening the scope of activities through to the year 2000."

The establishment of a Collaborative Council no later than the end of 1988 was specifically recommended in which, in addition to the concerned U.N. Development System Organizations, multilateral and bilateral agencies would be strongly represented. The Consultation proposed the inclusion of NGOs and underlined, as a matter of principle, that developing countries "... must be brought into the consultative process and participate in The Council's activities."

Interlaken, as a means of strengthening co-ordination and harmonization of programmes in close consultation with developing country partners, is an important benchmark in The Decade. Its recognition of the necessity to carry on the campaign with strengthened policy, programmes and resources until the end of the century is a pragmatic recognition of the magnitude of the tasks and goals to be achieved.

Since Interlaken, the principles and proposals agreed to in October, 1987 have been further refined in anticipation of the follow-up consultation taking place at The Hague in the Netherlands in November, 1988 which has, as its principal objective, the approval of the Collaborating Framework and its mechanisms allowing the initiation of a strengthened programmes built on breakthroughs achieved under a Beyond The Decade banner.

# COMMUNITY INVOLVEMENT IN UGANDAN WATER PROJECTS

by

Graham Piper

## Background

In Kigezi in South West Uganda many villages currently have water supplies which are either inadequate or of poor quality. This is despite a high annual rainfall of about 1000mm.

The hilly nature of the terrain in this area gives rise to many springs just above the floor of the network of valleys. In some areas springs are found at a higher level because of the different rock formation and the occurrence of fissures in the rock strata. The latter lend themselves as potential sources for gravity-fed piped water schemes.

The government of Uganda has historically attempted to give assistance to communities wanting to protect their own spring. However, the political problems the country has experienced over the last 20 years have meant that successively fewer resources have been available, until more recently.

Population growth has meant that existing communities have created a greater demand for water, making the existing supplies insufficient. It has also prompted some migration to new locations on the upper hill slopes which were originally forested. These communities are now having to look for new water sources.

Bad communications and the high price and scarcity of project materials have slowed down the progress of most rural programmes. In Kigezi there are still hundreds of springs which require protection for the first time, or which are in need of repair. There are also many communities that are not suitably served by a natural spring. Where these are located at more than 200 feet (70 metres) above the valley floor the main alternative to spring sources is to provide means of rainwater catchment. The government was originally involved in a borehole drilling programme for this area during the 1970s but many of the boreholes are now in need of maintenance. It is often only in the towns where the cost of a pumped water supply can be justified.

## Community Involvement

For each project undertaken with outside assistance it has been stressed to the community from the outset that the venture is to be a self-help project. This is based on the understanding that the local people want the project; the project is to be their project and the water engineer is simply available as an adviser. This means the local community is responsible for carrying stones to the spring site and subsequently for breaking some of these to form aggregate. The local community is also asked to provide sand and clay when available nearby. The local people have also to turn up on the allocated work days to dig the foundations for the spring retaining walls, mix the concrete, puddle the clay, etc, on a voluntary basis. The water engineer normally visits the spring site ini-

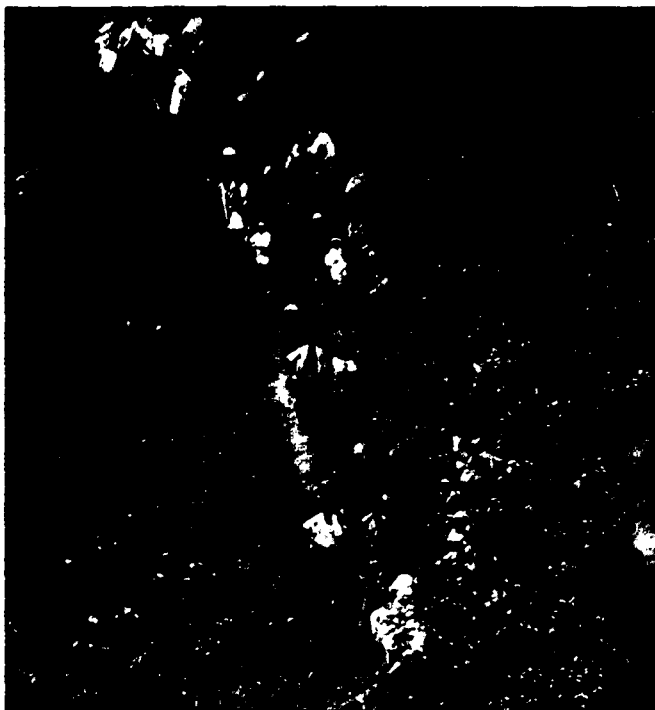

*Community involvement in digging the pipe trench.*

## COMMUNITY INVOLVEMENT – SMALL WATER PROJECTS

tially at the invitation of the local people and then returns with the cement and a mason when they have confirmed that the locally occurring materials have been amassed at the worksite. All this requires careful planning, and adequate notice has to be given because communication is so slow. Some of the most successful projects have been where the local leader is dynamic and holds the command and the respect of his people. The local leader may be a parish pastor, Church teacher, resistance council chairman, headmaster or health assistant. Personality plays a large part in the success of the project.

In larger self-help ventures such as gravity-fed piped schemes it is essential to have a general meeting of the potential beneficiaries of the project to explain the implications of the scheme and to ask for comments. The community are then asked to elect a water committee and a comprehensive contract is drawn up outlining the roles of the interested parties — the donors, the technical advisers and the beneficiaries. This may seem very formal but is absolutely necessary and can avert any possible future misunderstandings. Experience has shown that it is very useful for the water engineer to have two paid co-workers who help to co-ordinate the work and the workforce, e.g. ensuring people turn up at the right location with sufficient tools, marking out the pipe trenches or arranging people to carry materials. The two co-workers are chosen by the water engineer who then makes sure that his proposal is ratified by the water committee. Originally it was agreed that a penalty clause be included in the contract, whereby anyone failing to turn up to work should pay a fine, the magnitude of which was set by general consensus. However, the water committees have to date unfortunately been unable to invoke this in the way it had been hoped.

### **The Dilemmas Facing the Water Engineer**

Despite the overwhelming need for good water supplies and the warm welcome and hospitality of the local people, the water engineer will invariably find himself facing a number of dilemmas.

In the first place, the arrival of a Western water engineer on the scene brings high, if not excessive,

expectations. The people have waited and prayed for years for good water and with that hope materialising they can become understandably impatient. Yet the engineer still has to ensure that the community carries out its preparation work before he returns with the cement and the mason. Some of the work (e.g., digging foundations) requires careful supervision to ensure a quality structure. If the project eventually fails, the engineer's name will always be linked with it.



*Installing a SWS Rower Pump with filter to help improve the quality and accessibility of the water.*

Understandably, community leaders always want the best for their people. They tend to overlook the excessive cost of desirable, but unreasonable, high technology options and their consequent maintenance problems, the lack of availability of materials or the obstacles of terrain. This brings in the whole question of the appropriate level of technology to be employed. This is where lack of co-ordination between different aid agencies undertaking separate programmes can cause headaches. For instance, a programme of spring protection in a suitable area is often the most cost-effective and quickest form of improving rural water supplies. This may be extended to include shallow wells in adjoining areas, where natural springs are few. However, the extra cost and supervisory effort involved in a shallow well compared to a spring means that each proposed location has to be considered very carefully. This programme, however, can be put into jeopardy by the rumours of another aid agency proposing to carry out a borehole drilling programme in the same area. Boreholes can

## COMMUNITY INVOLVEMENT – DILEMMAS

often be sunk closer to the centre of the community than perhaps the originally proposed shallow well. A borehole may also greatly reduce the distance the community has to walk to its source compared to its nearest natural spring. There are instances in another country where a perfectly good and recently installed hand-dug well was smashed up, so becoming useless, because the local community thought it would mitigate against their chances of obtaining a borehole under a newly-launched programme. Hence careful planning and good communication are essential.

Another problem can occur if an influential resident is campaigning for a fairly sophisticated pumped water supply for his home village, which was originally to be supplied by springs and roof catchments, when the main town for the area can only supply piped water to less than half its inhabitants and institutions.

### Conclusion

For a water engineer working for a mission or aid agency it is important that he maintains a good liaison with the relevant government department, and he provides them with information regarding his work.

He will ultimately find he needs to develop skills of diplomacy, communication and co-operation when dealing with such projects. Often there will be a need for perseverance and patience and a need to exhort and encourage the local people. In every situation he will need to listen and seek comments and advice, to be willing to accept his mistakes and be corrected. But in the end he will have been taught so much and will have been rewarded by the expressions of delight when at least some of the projects succeed. •

*Construction work in progress at a spring site.*





# THE VALUE OF EDUCATING TANZANIAN WOMEN FOR THEIR ROLE IN WATER DEVELOPMENT

by

Mrs. E. J. Chaggu

Women in Tanzania constitute more than 50% of the total population, according to the 1978 national census. The total population and that of women have shown the same increasing trend over the last decade.

The Arusha Declaration of 1967 aimed to facilitate the country's development. In this respect, one of its main basic objectives was to promote an environment in which women were equal to men, particularly in their training opportunities.

The importance of involving women in water development was emphasized at the United Nations' conference held in Mar de Plata in 1977. To strengthen such involvement in Tanzania, village water authorities have been established with women as active members.

## Women's Role In Water Supply

Apart from their ability to bear children, the basic duties of women in Tanzania include taking care of the household and food production. Tanzanian women at the domestic level are:

- **the key users of water supply systems**  
Women are usually responsible for fetching water. Very rarely do men fetch water in Tanzania because it is traditionally regarded as "womens' work".
- **the primary promoters of hygiene**  
Women are the main handlers of water and waste disposal at household level, hence they are very knowledgeable on the community's needs regarding water supply
- **the informal teachers in the family**  
The first school in any family or society is the home, with women being the main "teachers".
- the generators of any income from agriculture for the entire family, especially in the rural areas
- **the main personnel in child growth and development**  
Women are essentially responsible for provision of clean, safe water, a balanced, nutritious diet and attendance at mother-child health clinics (MCH).
- the primary receptors of government campaigns on clean and safe water for

- improved health
- always willing to provide labour on a self-help basis in water supply projects which require immediate implementation

## The Value of Educating Women

Educating women has numerous benefits for health. Some of them are very specific to areas of individuals but some are more generally applicable. Common practices



*Education for women - including building and maintenance of latrines - affects the whole population*

## VALUE OF EDUCATING TANZANIAN WOMEN

where education would have marked impact on health include:

- walking long distances to fetch water often gives rise to the habit of bathing near or at an unprotected water source. In some cases, for privacy, women bathe upstream of the water collection point without realising the health hazard they may cause.
- washing clothes at an unprotected water collection point is another common practice which can be a health hazard.
- some people defecate at the upstream side of the water collection point, especially if the area is bushy, without knowing that they are contaminating the water supply. This commonly occurs when women go to fetch firewood or go to tend their farms.

Education at this juncture, especially health education, will help to remove or modify the ignorance and negative practices such as those mentioned above. This should promote changes in behaviour that lead to improvements in health.

There are country-wide efforts by the government to provide safe water to all (formally targeted to be by 1990). These require co-operation of the beneficiaries (mostly women) during the implementation of the projects and later, for operation and maintenance. The technology used in some villages, as in the Tanga, Morogoro and Shinyanga regions, is hand-pumps. Educating women on the operation and maintenance of the hand-pumps will increase the life span of the pumps and ensure longer periods if not continuous provision of clean and safe water.

### 'Education Is Power'

Education will:

- create a sense of ownership of the water supply technologies. This will safeguard equipment, such as hand-pumps, as women will be at the forefront to prevent vandalism;
- open up people's (women's) minds on the geological and health implications of siting shallow wells in relation to pit latrines;
- improve conditions of storage of water in homes so that it is no longer stored in dirty vessels which contaminate the water and affect the family's health;
- improve the confidence of women in deliberating on their water supply affairs: for example, establishing a procedure to determine

who cleans the surroundings of the hand-pump and when, etc.;

- increase motivation of women through information gained by reading different newspapers and other sources of data.

### Current Training of Women For Water Supply In Tanzania

Above the village level training which is offered in Tanzania, the Rwegarulila Water Resources Institute, under the Ministry of Water, trains water technicians at Full Technician Certificate Level. The following table indicates the percentage of females who have so far qualified from this institute. The number is very small, however, when compared to the number of women in Tanzania and to the required amount of water points to be serviced in the country.

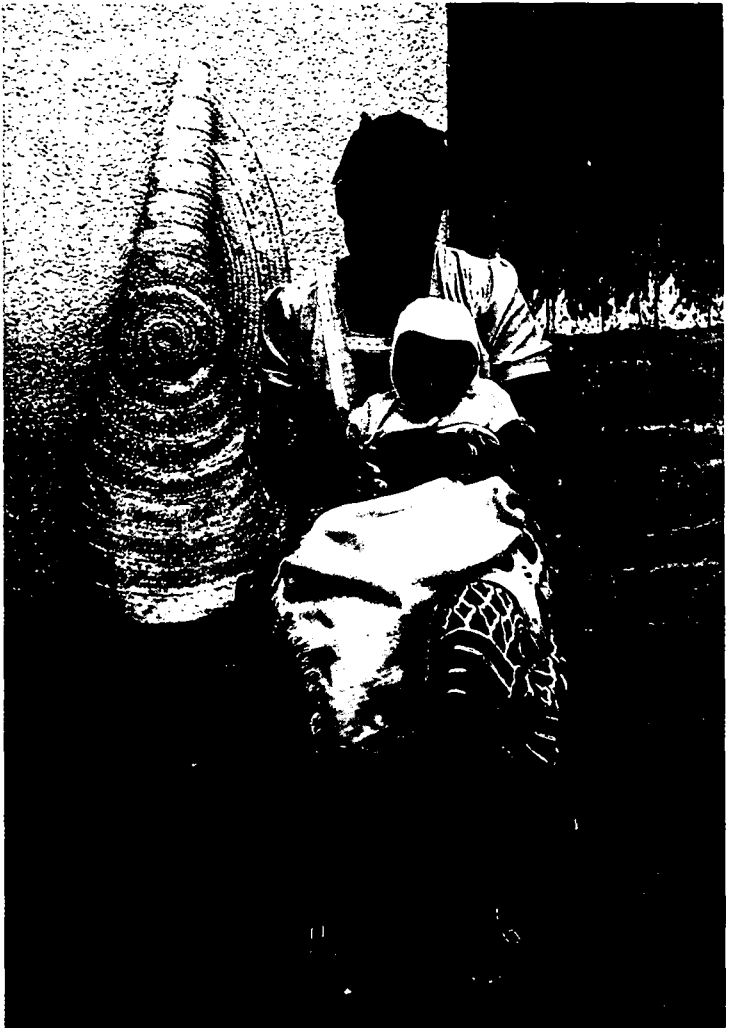

*A clean, well-kept yard is a safer place for women and children*

# VALUE OF EDUCATING TANZANIAN WOMEN

## SUMMARY OF STUDENT GRADUATES FROM RWEGARULILA WATER RESOURCES INSTITUTE

Year	Female Graduates	Male Graduates	Total Number of Graduates	% of female Graduates
1976	0	34	34	0%
1977	0	62	62	0%
1978	0	84	84	0%
1979	NO EXAMINATIONS - MOVED TO MAY 1980			
1980	7	98	105	6.7%
1981	20	98	118	16.9%
1982	12	96	108	11.1%
1983	13	115	128	10.1%
1984	7	104	111	6.3%
1985	13	113	126	10.3%
1986	11	56	67	16.4%
1987	5	50	55	9.1%
1988	9	50	59	15.3%
TOTAL	97	960	1057	9.2%

### Conclusion

"Educating women in water supply in Tanzania is educating the society." Women are still the primary handlers of water, water which can adversely affect health if it is carelessly managed or mishandled. If women are taught the values of keeping the water supply and storage points clean and safe, incidences of water-related diseases should be reduced and people will learn to equate adequate and continuous water supplies with well-maintained and operated systems. °

### Bibliography

- Elmendorf, M. (1981). "Women, Water and The Decade"; USAID.  
 IDRC (1984). "Women's Issues in Water and Sanitation: Attempts to Address an Age-Old Challenge"; IDRC Canada.  
 Muro, A., et al. (1988). "Women's Position in Economic and Social Development in Tanzania".  
 A seminar with the National Council, Ministers of the Government of the United Republic and members of the Zanzibar Revolutionary Council, Dar es Salaam, Tanzania.  
 Zandstra, I (1987). "Participation of Women in Water Supply and Sanitation Programs"; IDRC Canada.



A female student happily entering classes at Dar es Salaam University

# COMMUNAL WATER POINTS

by

Bob Reed

Many people in the developing world obtain their water from one form of communal water point or another. Often it is a communal tap but it may equally well be a handpump, well or springbox. In many cases large amounts of money and time have been expended on providing new water supplies in the hope that they will bring health benefits to the communities concerned. If, however, the collection point is ankle deep in mud and surrounded by stagnant pools of water the resultant health hazards may be greater than those associated with the original polluted water source.

The main problems associated with communal water points are:

- Access
- Congestion
- Vandalism
- Drainage

## Access

The problems associated with poor access are fairly obvious. Water points should be on public land as near as possible to the centre of the area they are intended to serve. Allowance should be made for the road and footpath layout so that the maximum walking distance is less than 250 metres. In the case of handpumps it may be necessary to arrange vehicular access for maintenance.

## Congestion

Providing a single tap or handpump to serve a population of a thousand is bound to lead to congestion. The number of people who can use a single water outlet depends on the per capita water consumption, the water discharge rate and the social customs of the community. It can be calculated using the formula:

$$P = Q \times H / C$$

P = Maximum population served by a single water outlet

Q = Average discharge from the water point (litres per hour)

H = Number of hours that water is collected each day

C = Per capita water consumption (litres)

*Congestion around communal water points in a refugee camp*



## COMMUNAL WATER POINTS



*A shallow well without an apron. The waste water around the well is a health hazard for the users and will contaminate the well.*

Congestion also occurs if the area around the water point is not large enough for the functions usually carried out. In many parts of the world people bathe and do their laundry at the water point rather than carry the water home. Such activities require a large impermeable surface (apron) around the water point. The edge of the apron should have a channel or small upstand to direct the waste water into the drainage ditch.

### **Vandalism**

Vandalism is a problem all over the world but in many cases water points have been damaged because they were not robust enough to withstand the daily wear and tear inflicted by the users rather than any deliberate damage. Robust heavy duty construction is a must if the water point is to last any length of time.

### **Drainage**

Poor drainage is probably the most common fault associated with water points and it is also the biggest health hazard. Pools of stagnant muddy water encourage the breeding of mosquitoes, make the ground slippery to walk on and contaminate water containers and possibly the water source. Because of its importance, drainage is often the controlling factor when locating the water point. If possible the waste should be channelled to a drain or natural water course. Should this not be possible then the next option is to infiltrate the waste into the ground through a soakpit. Where the water source is a shallow well or handpump, the soakpit should be located far enough away from the source to ensure that it does not cause pollution. In fine, granular soils 15 to 30 metres is usually enough. In coarse gravels and fissured rock, however, the distance may have to be much fur-

ther. The size of the soakpit is also important. The amount of waste water produced at a large water point is considerable, especially if the area is used for bathing and laundry. The soakpit should be designed such that the side wall area is large enough to infiltrate a full day's waste production. If the ground is impermeable then other possibilities, such as evaporation pans or irrigation, could be considered. However, they are difficult to control and it may be easier to try to reduce the amount of water wasted.

Communal water points are an important part of many new water supplies. It is a great pity if their potential benefits are not achieved because of a lack of consideration and effort in designing the most important part of the scheme, i.e. the point where the scheme comes in contact with the consumer. ◦

# INVOLVEMENT OF FARMERS IN SMALL SCALE IRRIGATION PROJECTS

by

Ian Smout

**Farmers worldwide have been constructing small scale irrigation schemes and operating them successfully for centuries. Indeed, this type of irrigation covers large areas in Africa (including 800,000 ha in Nigeria), Asia and South America.**

However, we are now seeing attempts by governments and aid agencies to promote small scale irrigation through development projects. This results in the involvement of professional staff, from government, non-governmental organisations, and consultants in the planning and implementation of small scale irrigation, instead of this being carried out by the farmers alone. But it is important that farmers continue to be involved, especially as the crucial daily operation and maintenance tasks will normally have to be carried out by the community for cost and logistical reasons. Participation of farmers in earlier stages helps to ensure that they will be able to carry out these tasks successfully.

### Planning

At the planning stage, farmers can describe the existing problems which need attention and their priorities. They can comment on the boundaries of the command area and on which farmers' land is to be included or excluded.

Development workers can try to establish a community consensus about the scheme at an early stage; this requires that they clearly explain their difficulties — for instance, over-working on the scheme at certain times or problems with land or water rights. It is important to determine whether there is real interest in the scheme, or if it is just being pushed by one or two powerful individuals without community support.

On a hill irrigation project in Bhutan, the villagers are required to submit an application for the scheme in which they provide details of the farmers and irrigated areas on the channel, request improvement works, say how much unpaid labour they can provide each month and commit themselves to maintain the works in future. This application helps to provoke discussion at the planning stage and later the villagers can be reminded of the commitments they made to provide labour, etc.

It may also be useful to set up a committee at the planning stage, which can become a construction committee and then a water user association. This has been done on some small schemes in Nepal where the committee has to raise a certain proportion of the estimated cost of the scheme and deposit the cash in a construction committee account.

In the author's experience, the command area boundary can be a major issue, e.g. in hill irrigation in

Nepal and Bhutan and tubewell irrigation in Indonesia and Bangladesh. In the project in Bhutan the farmers were concerned that each channel should continue to serve the same group of beneficiaries as in the past and they would not consider combining small command areas with an improved supply channel. In the Indonesian tubewell project the farmers' main concern was that the command area should be all in one village to prevent the administrative problems which arose if two villages were involved. It may be noted that the engineers recognised the merits of the farmers' point in each case but they could not comply with it without farmer participation — the relevant information was not shown on the maps.

This is an example of the general issue of land and water rights. If these are not clear, farmers may be reluctant to participate. This happened on a small village scheme in Tanzania which was constructed to irrigate a particular area of uncultivated land but it was unclear which villagers would eventually farm the land. Sometimes, of course, a project can change access to water and it is interesting that Indonesian engineers in East Java are reluctant to construct new diversion structures in the hill areas because of the consequences for downstream users.

Community participation in irrigation may be more complicated and difficult than in other community development projects such as water supply, because some people may benefit much more than others from the scheme.

### Design

At the design stage, the project staff can discuss with the farmers the detailed works to be carried out. Particularly sensitive issues are the alignment of canals (which will govern who loses land and who has best access to the water) and the position of outlets. There is a lot of scope here for conflict between farmers and no easy way to overcome this. Again, a representative committee can help this process, but it is wise to involve as many farmers as possible. The issues can best be discussed by walking the canal line with the farmers and trying to reach agreement on site.

### Construction

Farmers can work on construction of the scheme, either as paid labourers or as volunteers. They may contribute

## IRRIGATION PROJECTS

to the capital costs of the works by providing unpaid labour or cash. Sometimes it may seem that the implementing agency's main interest in community participation is to make use of unpaid labour. However, farmers may only provide the labour if they approve of its purpose and so they get an effective veto on the works constructed. Also, the agency is obliged to use unsophisticated construction techniques and materials and train the villagers in using them, all of which make for slow construction but easier operation and maintenance later.

Other major advantages of using farmers for construction are:

— they are more likely to regard the works as their own after working on them, rather than as belonging to the agency;

— they have a direct interest in the quality of the works.

However, labour management can be very difficult in these circumstances because farmers have many other demands on their time — farming, domestic, social and other development projects. In particular, unpaid labour may arrive late, leave early, take long holidays at times of festivals and funerals and generally be much less productive than paid labour on contract work. In some situations families may try to meet their obligations to provide labour by sending children to do the work rather than adults. It may be best to make an

elected construction committee or leader responsible for labour management, including resolving these problems. Nevertheless, delays and slow progress can be anticipated.

Farmers' limited construction skills mean that they can only do some parts of the works — indeed, if they could do all of it, why have they not done this previously? So, outside skills may need to be employed for some tasks. But the unreliability of the farmers' labour can then result in delays and waste of skilled employees' time. On the Bhutan project an attempt was made to overcome these problems by giving the beneficiaries their own independent tasks, such as collecting a volume of stone or clearing a length of canal and delaying the work of the project's masons until the beneficiaries' task was complete. But it proved very difficult to persuade the farmers to work on their own.

### Conclusions

Operation and maintenance of small scale irrigation schemes are commonly seen as the farmers' responsibilities, but if these are to be carried out successfully, participation is also needed in planning, design and construction of the scheme. To be successful, this participation needs to be integrated into the various engineering activities in a way that takes account of the farmers' own interests; this can be time-consuming of both technical and skilled labour. ◦

*Visit to a demonstration site with improved irrigation facilities, Madura, Indonesia*



# SOCIAL ASPECTS OF SULABH SHAUCHALAYA

by

Bindeshwar Pathak

**One of Gandhi's often-repeated appeals was for improved sanitation. He deplored the conservancy system (or nightsoil collection from dry latrines by sweepers or scavengers) which was then common throughout the developing world. In India, nightsoil was often collected by women. Whether male or female, the sweepers were almost invariably people outside the caste system whom Gandhi called the Harijan.**

The Government of India has provided massive support for a programme of conversion of dry latrines to pour-flush pit latrines. In several Indian towns and cities the programme has been put in the hands of Sulabh International. This was founded by Bindeshwar Pathak, with a background of sociology and tremendous enthusiasm. Sulabh has developed a range of household latrines, most of which have twin pits. The excreta and washing water pass to one of the pits until accumulated solids occupy most of the space available. Then the other pit is used for two or more years, by which time the solids in the first pit are innocuous and can be safely removed by hand.

Sulabh Shauchalaya is a technology which is a safe and economical alternative to the sewerage and septic tank system for disposal of excreta. The scheme is an improvement upon the pattern rendered obsolescent. Economical, cheaper, convenient and in accordance with the felt needs of the people, it is also in consonance with the existing values, past experiences and needs of the

receivers and is so simple that it is readily understood by people. It puts a heavy premium on smallness and self-sufficiency. Instead of being complex, it is convenient and manageable and ensures maximization of benefits from limited available resources. Its simplicity and smallness make it appropriate to meet local needs.

It is a technology appropriate to the particular situation faced by people of developing nations. Satisfaction of the basic human needs through locally available material and local labour supplies are its broad objectives. In a way it represents the most important means for improving the quality of living.

It brings to an end the traditional system of service latrines which is considered thoroughly unsuitable and unhygienic as it generates problems of odour, insects and insanitary condition. The technology is capable of bringing about a better co-ordination between human needs and aspirations on the one hand and environmental policy and programmes on the other.

Sulabh technology is people's technology or

*Sulabh has also been involved in rehabilitating the scavengers by providing craft training, as shown below and right*





## SOCIAL ASPECTS OF SULABH SHAUCHALAYA

*Sulabh has also built and maintains a number of communal latrines, like that shown here. Users pay a small charge, for which they receive some soap powder*



democratic technology, a technology to which everybody can get admittance, for it is not reserved for those already rich and powerful. It is a technology with a human face. It is compatible with social values. It represents an investment in man as it deals with the welfare of people and amelioration of the down-trodden. A lot of social planning is involved. The choice of Sulabh Shauchalaya for excreta disposal marks the incorporation of social values into the process of technological choice.

This hand-flush pit latrine has made it possible for the scavengers to get redemption from the tentacular grip of the obnoxious practice of carrying night soil on the head. As a system of excreta disposal, it leads to the liberation of scavengers and manages the disposal of human wastage in such a way that scavengers are not required at any stage. It has led to the extinction of the

old disabilities perpetuated on a section of the Harijan community since time immemorial. It has raised hopes of a better future among those who are traditional carriers of nightsoil under the conservancy system. Implementation of the scheme has made it possible for scavengers to give up their traditional sub-human work and to find alternative jobs. In fact, the spread of the technology has challenged the situation of exploitation and has become part of the normative structure of society. In so far as it intends to uplift the lowest, it has challenged the traditional institutionalised stratification based on outdated values. Changes in the economical situation alone could not help them to this extent. The rigidity of the social structure has received a fatal assault through the implementation of this scheme. ◦



### Building Components and Materials

**ABULL STANDARD** 83 Pensnett Trading Estate, Brierley Hill, West Midlands, UK, Tel: +44-384-288030, Telex: 261507, Contact: Allcock. Manufacture and design of handrailing barrier guard rail systems in tubular steel, aluminium, stainless and solid forged. Vertical ladders to BS4211.

**BACO CONTRACTS LTD** Regal House, London Rd, Twickenham, TW1 3QA, UK, Tel: +44-1-892-4488, Telex: 261621, Fax: +44-1-892-4627, Contact: Mr D Green. Design, supply and erection of aluminium structures, clear span and column grid roofs for reservoirs, water tanks and towers and sewage treatment works.

**BAKER PLASTICS INC** 900 Mahoning Avenue, Youngstown, OH, 44502, USA, Tel: +1-215-743-3242. Adhesives, acrylic mirror, plastic glazing materials, skywindows, lighting panels, plastic tubing, rigid and flexible, construction film and fabricated items.

**CLEAVER-BROOKS** P O Box 431, Milwaukee, WI, 53201, USA, Tel: +1-414-962-0100. Complete boiler room and packaged water systems supplier.

**DEEPSEAL WATERPROOFING CO LTD** 11A Epsom Rd, Croydon, Surrey, CR0 5JE, UK, Tel: +44-1-686 6180, Telex: 946133, Fax: +44-1-688-7060, Contact: Mr Madson. Manufacture and supply cement-based waterproofing materials, suppliers of PVC membranes, waterstops, flexible polyurethane grouts and injection hose etc.

**EVERED GRP PRODUCTS** Hoyle St Mancunian Way, Manchester, M12 0HL, UK, Tel: +44-61-273-3341, Telex: 667930, Fax: +44-61-274-3743, Contact: Paul Marvin. Evered's open grid and chequer plate flooring and access ladders offer maintenance-free and corrosion resistant, durable solutions to water industries worldwide. They are already specified by UK water authorities.

**FIBERGRATE CORP** PO Box 814610 Dallas TX 75-381-4610 USA Tel: +1-214-250-1633, Fax: +1-214-2150-1530, Contact: Mr David I. Eberhart. Manufacturer of fiberglass grating, walkways, platforms, bridges, ladders, hand rail and other corrosion-resistant pedestrian facilities, complete concept-to-completion capabilities including design and installations.

**FUNDICIONES METALICAS S A** Barrio Estacion, S/N, Utebo, Zaragoza, Spain, Tel: +34-76-771014, Telex: 58171 FLME E. Gratings and covers: Fundiciones Metalicas S A produce these castings up to 1. 200 x 1. 200mm. For heavy medium and light duty service.

**HONEYWELL BRAUKMANN** 700 Elliocott St, Batavia, NY, 14020, USA, Tel: +1-716-343-6110. Manufacture and market sediment filters with unique impeller backwash capability, pressure regulating valves, ball valves, strainers and non-electric temperature control valves, to the plumbing and heating industry through established wholesalers and distributors.

**LIQUID PLASTICS LTD** P O Box 7 London Rd, Preston, PR1 4AJ, UK, Tel: +44-772-59781, Telex: 67169, Fax: +44-772-202627, Contact: Milham. Liquid Plastics Ltd produce specialist surface and polymer modified concrete repair systems.

**NALCO CHEMICAL CO** 2901 Butterfield Rd, Oak Brook, IL, 60521, USA, Tel: +1-312-887-7500. Water and fuel treatment programs for energy and water conservation and efficiency improvement in building heating and air conditioning systems.

**PROTONGROUT MRA LTD** 2 Town Hill St Edmunds Lane, Bures, Suffolk, CO8 5JL, UK, Tel: +44-787-227508, Telex: 8951182, Fax: +44-787-227169, Contact: Mr Cox. Fluid grouts for crack injection, underwater and wash-out resistant-grouts. Quick strength mortars - 10 N/per mm<S2> at 5 degrees centigrade at 1 hour. Acrylic modified mortars for concrete repairs, cementitious waterproof, flexible membranes and sealers.

**MARK RAINER LTD** Leamore Close Leamore Industrial Estate, Walsall, West Midlands, WS2 7NL, UK, Tel: +44-922-401408/401433, Telex: 334173, Fax: +44-922-495958, Contact: Mr Stretton. Manufacturers of handrailing, open-type flooring, ladders, access and safety equipment in aluminium, mild steel, stainless steel and GRP.

**SCHACHTABDECKUNGEN FIEDERMUTZ** Oberfeldstrasse 119, Wels, A-4600, Austria, Tel: +43-7242-33-4031013, Contact: Philipp Fiedermutz. The firm is engaged in the production of manhole covers. Made to the firm's own designs, they are available in hot galvanised steel, stainless steel and with double aluminium seal, a new system developed by Fiedermutz. In addition to standard models, this small family-run artisan undertaking can also supply custom-built models.

**TROUVAY AND CAUVIN LTD** Aquis House 117-121 New Zealand Avenue, Walton-on-Thames, Surrey, KT12 1QU, UK, Tel: +44-932-245131, Telex: 924261, Fax: +44-932-245080, Contact: Mr Buchanan. Access equipment (including ladders, rungs, flooring and handrails).

**WHEELER MFG** P O Box 688, Ashtabula, OH, 44004, USA A, Telex: 980-432, Fax: +1-216-992-2925. Wheeler Manufacturing, division of Rex International USA is a manufacturer of hand and power tools for the installation and maintenance of all types of pipelines. We produce pipe cutters, test pumps, vises, shut-off tools, tubing cutters and pipe handling tools. Our 30 year old reputation has been built on our high quality and prompt service.

### Tools, Clothing and Miscellaneous Small Equipment

**ABBOTT BIRKS (A WHOLLY OWNED SUBSIDIARY OF RCF TOOLS PLC)** Andover Branch, East Partway Trading Estate, Andover, Hants, SP10 3NJ, UK, Tel: +44-922-612336, Telex: 477206, Fax: +44-264-332249,

## TOOLS, CLOTHING AND MISCELLANEOUS SMALL EQUIPMENT

Contact: Mr Billson. Suppliers of tools, equipment and accessories to the gas and water industries. Product range consists of over 10,000 line items, representing over 120 manufacturers.

**THE BEN MEADOWS COMPANY, INC** PO Box 80549, Atlanta, GA, 30366, USA, Tel: +01-404-455-0907, Fax: +1-404-457-1841, Contact: John E Amos. The Ben Meadows Company warehouses and distributes over 8,000 items from 500 different manufacturers. These products are designed to improve the productivity of the professional or worker out in the field. We offer water analysis equipment, sampling and measuring devices, water pollution detection and on-sight sewage lab kits, among many other instruments and equipment your people can use in the field.

**CLEMCO INDUSTRIES CORP** 1657 Rollins Rd, Burlingame, CA, 94010, USA, Tel: +1-415-570-6000, Fax: +1-415-697-0217, Contact: Nancy Haidet. Clemco Industries Corp manufactures a complete line of abrasive blasting equipment for surface preparation. Any size application can be handled from the smallest job to the largest industrial application. Clemco compliments their abrasive equipment line with a complete operator safety package.

**DEBRIACHER** Triglavstrasse 21, Villach, A-9500, Austria, Tel: +43-4242-24-6-76, Telex: 45534. For water management purposes the firm Debrischer produces an energy-saving chain stirrer for use in agriculture and the chemical industry. The device is particularly suitable for jobs in which quick-setting constituents have to be kept in suspension or deposited layers require floating.

**DRAEGER LTD** The Willows, Mark Rd, Hemel Hempstead, Herts, HP2 7BW, UK, Tel: +44-442-3542, Telex: 826093, Fax: +44-442-88-40327, Contact: Mr McCabe. A range of equipment to provide safe working conditions in the water industry. Breathing apparatus - self-contained sets, air line equipment and escape sets, gas detection instruments - chlorine, oxygen, flammable and toxic gasses. Portable and installed

**GILMOUR GROUP** 332 W Broadway, Louisville, KY, 40202, USA, Tel: +1-502-587-5975, Fax: +1-502-587-5142. Pruning shears, loppers, hedge shears, saws, pole pruners and garden hose.

**GLOVER & WOOD LTD** New Victoria Works, Jack Lane, Leeds, LS11 9SY, UK, Tel: +44-532-436071, Telex: 557234, Fax: +44-532-425597, Contact: David Nall. All types of protective clothing and safety workwear especially waterproof clothing.

**W L GORE & ASSOCIATES** Kirkton Campus, Livingston, West Lothian, EH15 7BI, UK, Tel: +44-506-412525, Telex: 727236, Fax: +44-506-420004, Contact: Mr Barne. Gore-Tex fabric is a waterproof, windproof and breathable fabric and is used for protective clothing for water industry.

**HUBERTS BV** PO Box 251, Veghel, AG, 5460, The Netherlands, Tel: +31-41-30-66811/41-30-42275, Telex: 74645, Fax: +31-4130-42029, Contact: Ms Ira Turner.

Import/export wholesale company in mainly wood-working and metalworking machines for semi-industrial purposes: metal lathes, wood lathes, bench grinders, (pedestal) drilling machines, air tools, compressors, water pumps, electric motors, band sawing machines, metal sawing machines, welding equipment and dust exhausters.

**INTEQUI LTD** 6 Christchurch Rd, Northampton, NN1 5LL, UK, Tel: +44-604-250421, Fax: +44-604-233115, Contact: Clifford Young. Suppliers of all types of garage and workshop equipment, hand tools, mobile workshops, safety equipment, clothing.

**TUBAFOR INTERNATIONAL** 39 Champs Elysees, Paris, 75008, France Tel: +33-1-42-25-93-42, Telex: +280888, Fax: +33-1-45-63-84-08. Tubafor International has available tools such as rock bits, down-the-hole hammers and bits as well as drag bits.

### Large Equipment

**AQUATICS UNLIMITED** 2150 Franklin Canyon Rd, Martinez, CA, 94553, USA, Tel: +1-415-370-9175, Fax: +1-415-370-9179, Contact: James R Ziegler. Manufacturer of Aquamog-a multi purpose marine maintenance vessel with many easily interchangeable attachments. Aquamog cuts aquatic weeds deep and fast, rotovates hydrosol and removes rooted vegetation. Aquamog is a powerful suction dredge and bucket dredge. Self propelled, eliminates cables, reduces downtime, reaches under piers, inside boatslips, close to shore and cleans waterways.

**BROWN BEAR CORPORATION** P O Box 148, Lenox, Iowa, 50851, USA, Tel: +1-515-333-4551, Fax: +1-515-333-2592, Contact: David Harder. Diesel powered all wheel drive, all wheel stir, off road rough terrain transport vehicles. Load capacity to 25 tons. Suitable for land applying sludge.

**CAMECO INDUSTRIES B V** P O Box 2077, Lelystad, AB, 8203, The Netherlands, Tel: +31-3200-32255, Telex: 47141 camec nl. Cameco Industries B V, manufacturer and supplier of Agritraco heavy duty implements, Cameco laser controlled land levelling systems and heavy duty construction tractors, Gomaco canal lining machines, trimmer and concrete equipment, Spectra Laserplane laser machine control and survey systems, physics design and survey hardware and software.

**GEORGE COHEN MACHINERY LTD** Dunhams Lane, Letchworth, Herts, SG6 1LU, UK, Tel: +44-462-684226, Fax: +44-462-684226, Contact: Mr Patient. Suppliers of world market-leading lorry loaders with multiple applications in the water industry: drilling, irrigation and pipelines etc.

**P F DOGGETT ENG LTD**, Slane, Co Meath, Republic of Ireland, Tel: +353-41-24143, Telex: 43783, Fax: +353-41-24478, Contact: Mr Bart Cunningham. Manufacturers of Geith range of excavator buckets and attachments for use on modern makes of hydraulic excavators and back-hoe equipment.

## LARGE EQUIPMENT

**DUAL MANUFACTURING COMPANY** 1000 West Cherukée, Sioux Falls, South Dakota, 57117 5041, USA, Tel: +1-605-336-3860, Telex: 437040, Contact: Mr Hanson. Three models of backhoes, digging from 7'6" to 12'9". Two models of trenchers for hydrostatic or Deer driven tractors.

**LIEBHERR - FRANCE S A** 2 Rue de L'Industrie, BP 287, Colmar-Cedex, F68005, France, Tel: +33-89-22-30-30, Telex: 880986, Fax: +33-89-23-30-14, Contact: Dr Mahlmann. The Liebherr-Group of companies consists of 43 companies worldwide. One major product line is earthmoving machinery such as hydraulic excavators (from 12t to 205t operating weight), dozers, crawler loaders, wheel loaders and draglines. Excavators for pontoons are in our standard program. Excavators for trenching as well as large units for earthmoving (for instance for reservoir and dam construction) are employed in water projects worldwide.

**MAMMOET TRANSPORT P O** Box 1960, 40 Westerdoksdijk, Amsterdam, 1000 BZ, The Netherlands, Tel: +31-20-55-73300, Telex: 13681, Fax: +31-20-23-66-79, Contact: Van Leewenen. Mammoet Transport B V specializes in transportation of project cargo by land and by sea. Heavy-lift vessels, barges, platform trailers and cranes for the nucleus of world-wide shipping and installation of desalination plants, power stations, refineries, chemical plants and off-shore installations.

**MANMORE ENGINEERING** Dartford Trade Park Hawley Rd, Dartford, Kent, DA1 1NX, UK, Tel: +44-322-72811, Telex: 8951661, Fax: +44-322-93603, Contact: Peter Clark. Design and manufacture of bulk storage and handling equipment for powders and chemicals. Also all types of conveyors.

**JF6MASTENBROEK & CO LTD** Boston, Lincs, PE21 7JG, UK, +44-205-65459, Tel: +44-205-310016, Fax: 377296. UK-based J Mastenbroek & Co Ltd designs and manufactures a wide variety of trenching machines and ancillary equipment. The company is well-known for its comprehensive range of chain trenchers, 'V' plows and single leg plows which are exported worldwide.

**R B (LINCOLN) PLC** Excavator Works, Lincoln, LN6 7DJ, UK, Tel: +44-522-25261, Telex: 56191, Fax: +44-522-511230, Contact: Terry Wigsell. Manufacturers of crawler mounted cranes and excavators.

**RANSOMES & RAPIER PLC** P O Box No 1, Waterside Works, Ipswich, Suffolk, IP2 8IL, UK, Tel: +44-473-690383, Telex: 98176. Dragline excavators and crawler cranes for work on dam, barrage and irrigation, canal construction worldwide.

**SMALLEY EXCAVATORS LIMITED** Cherry Holt Rd, Bourne, Lincs, P10 9TQ, UK, Tel: +44-778-426426, Telex: 32225, Fax: +44-778-393007, Contact: Mrs Smalley. Producers of a range of wheeled and mini excavators, dredgers, gravediggers, low ground-pressure drainage machines, sand skimmers, trash rakes, mining and material pumping machines. All equipment is designed and produced in Bourne and sold direct from the factory to a worldwide market. Please contact for further details.

**TAMPELLA LTD TAMROCK** PO Box 279, 33101 Tampere, Finland Tel: +358-31-241-4111, Fax: +358-31-312-152. Tampella Ltd Tamrock is a leading supplier of rock drilling equipment for various drilling jobs in the fields of mining and construction.

## Cooling Towers and Equipment

**B&L CONTROL SERVICE INC** PO Box 399, Saratoga Springs, NY, 12866, USA, Tel: +1-518-587-5350. Manufacturer of water treatment boilers and cooling towers. (WT)

**BALTIMORE AIRCOIL INTERNATIONAL** Industriepark, Heist-op-den-Berg, 3100, Belgium, Tel: +32-15-244770, Telex: 24006, Fax: +32-152-44779, Contact: Mr Pardekooper. Baltimore Aircoil Company is one of the world's largest manufacturers of factory assembled cooling towers, evaporative condensers and closed circuit industrial coolers, thermal storage units and heat exchangers. Serving the airconditioning, industrial refrigeration and process cooling industries by 15 manufacturing facilities and over 200 sales offices worldwide.

**CAMBRIDGE SCIENTIFIC INDUSTRIES** PO Box 265, Cambridge, MD, 21613, USA. Pioneer in the manufacture of automatic bleed (cooling tower) and blowdown (boiler) equipment. Also makes proportionate chemical feed systems, portable conductivity testers, pH controllers, microbiocide controllers, bypass (shot) feeders, sample coolers and high quality water monitors and controls. (WT)

**CARTER INDUSTRIAL PRODUCTS LTD** Bedford Rd, Birmingham, W Midlands, B11 1AY, UK, Tel: +44-21-772-4300, Telex: 339219, Fax: +44-21-772-3672. Manufacturers of industrial water cooling towers, water purification and effluent treatment plants.

**CHEMICAL TESTING CORP** 35 Commerce Rd, Stamford, CT, 06902, USA, Tel: +1-203-357-9800. Manufactures water conditioning chemicals and equipment for boilers and cooling systems. (WT)

**DELTA COOLING TOWERS INC** P O Box 952, 114 Clinton Rd, Fairfield, NJ, 07006, USA, Tel: +1-201-227-0300, Fax: +1-201-227-0458, Contact: John Halligan. Manufacture a line of factory assembled packaged cooling towers from 10 tons to 1,000 tons. We also manufacture a line of pack air strippers for removal of toxic organic contamination from water.

**ECODYNE COOLING TOWER SERVICES** P O Box 1267 5355 Skylane Boulevard, Santa Rosa, CA, 95402-1267, USA, Tel: +1707-544-5833, Fax: +1707-544-9118, Contact: John Giambastiani. Ecodyne Cooling Tower Services is a full service manufacturer of cooling towers: wood and concrete, mechanical and natural draft, counterflow and crossflow. In-house responsibilities include the design, manufacturing, construction, testing and servicing of cooling towers. Currently hold patents on distribution nozzles, fill media and direct eliminators. Worldwide sales and inspection services

## COOLING TOWERS AND EQUIPMENT

are available. Ecodyne Cooling Tower Services is a research-cottrell company and a member of the Cooling Tower Institute.

**EES CORP** 12850 Bournewood Drive, Sugarland, Texas, 77478, USA Tel: +1-713-240-6770, Telex: +795459, Fax: +1-713-240-6762. Sanilec® Systems are used around the world to generate the biocide sodium hypochlorite for water cooling treatment. The Sanilec® Brine Systems generate sodium hypochlorite from salt, water and electricity. The Sanilec® Seawater Systems need only seawater and electricity to generate sodium hypochlorite for direct injection into the seawater cooling loop or for storage and shock dosing. A Sanilec® System eliminates dangerous chlorine gas or other purchased biocides.

**FILM COOLING TOWERS LTD** 1 South Avenue Kew, Richmond, Surrey, TW9 3LY, UK, Tel: +44-1-940-6494, Telex: 8812277, Fax: +44-1-940-8789, Contact: Mr Clark. For all aspects of water cooling - new systems, re-ramps, design and management - Film Cooling Towers have manufacturing licensees and agents throughout the world.

**FILTRINE MFG CO** Main St, Harrisville, NH, 03450, USA, Tel: +1-603-827-3321. Manufactures water filters, fountains and coolers for process and drinking water applications. (WT)

**FLOWLINE WATERCOOLING LTD** Unit 13, Ashford Industrial Estate, Shield Rd, Ashford, Middlesex, TW15 1AY, UK, Tel: +44-784-247301, Telex: 940 13846 call g, Contact: David Potez. The company is engaged in the manufacture and installation of water cooling systems. Specialities are water cooling tower, air blast units and water treatment.

**IDEAL HORIZONS INC** PO Box 1707, Rutland, Vermont Tel: +1-802-773-4346, Fax: +1-802-773-2538. Ideal Horizons manufacture stainless steel ultra-violet disinfection equipment. Our modular systems allow for versatility over a wide range of applications and flow rates. These systems are engineered for durability and performance.

**I A COTTER & CO LTD** Benholme House Holywell Rd, Malvern Wells, Worcs, WR14 4LF, UK, Tel: +44-684-573654, Contact: Ivan Cotter. Design, manufacture and install water cooling towers using mechanical draught. The design includes induced, forced and cross draught. A full maintenance service is available. Customers include local authority but are mainly industries.

**IDEAL HORIZONS INC** PO Box 1707, Rutland, Vermont, 05701-1707, USA, Tel: +1-802-773-4346, Fax: +1-802-773-2538. Ideal Horizons manufactures stainless steel Ultra-Violet disinfection equipment. Our modular systems allow for versatility over a wide range of applications and flow rates, engineered for durability and performance.

**IMB Mathias-Brüggen** Strasse 17, Cologne 30, Biken-dorf, D-5000, West Germany, Tel: +49-221-58-80-40, Fax: +49-221-58-80-488. Water preparation to supply boiler

feed water and treatment systems to operate cooling towers of open or closed type.

**MARLEY INTERNATIONAL INC** PO Box 2912 5800 Foxridge Drive, Mission, Kansas, 660201, USA, Tel: +1-913-362-1818. Whether your process cooling needs call for mechanical draft cooling towers or MARFAB heat exchangers, Marley has the capability to solve almost any problem.

**MITCO WATER LABORATORIES INC** PO Box 1435, Winter Haven, FL, 33882-1435, USA, Tel: +1-813-967-4456. Chemicals, equipment and service for treatment of commercial and industrial cooling tower, boiler and potable water systems. Ion exchange, reverse osmosis and filtration process water purification equipment. Full service analytical laboratory.

**CARL MUNTERS AB** Box 7093, Sollentuna, S-19107, Sweden, Tel: +46-8-754-7100, Telex: 15921 Munters s, Fax: +46-8-754-5666, Contact: Mr Erik Andersson. Suppliers of de-humidifiers, evaporative cooling systems for animal housing, non-inflammable glass fibre materials, cooling towers, comprehensive moisture control services for post-flood and fire problems. Specialists in the biological treatment of waste.

**PROGRESSIVE EQUIPMENT CORP** 413 East 9th St, Erie, PA, 16503, USA, Tel: +1814-452-4363, Fax: +1814-459-3094, Contact: Andrew J Kaufman. Progressive Equipment Corp manufactures electronic water treatment and filtration systems for industrial applications such as: cooling towers, chillers, boilers. Our systems are an effective alternative to costly chemical treatment methods of industrial and commercial process water. Improves heat transfer, reduced maintenance and down time, environmentally safe and saves money.

**TEMPRITE, DIV OF ELKAY MFG CO** 2222 Camden Ct, Oak Brook, IL, 60521, USA, Tel: +1-312-573-8840. Manufactures a complete line of treated water coolers and dispensers, bottled water coolers, remote chillers, carbonated beverage dispensing systems and under-the-sink chilling and heating equipment. (WT)

**WATER MAINTENANCE SERVICES INC** 8 South 335 Madison St, Willowbrook, IL, 60521, USA, Tel: +1-312-654-8675. Water treatment system and services. Specializing in cooling tower and boiler treatment, reverse osmosis, demineralization, full laboratory.

### Miscellaneous

**ACHESON COLLOIDS COMPANY** Prince Rock, Plymouth, Devonshire, PL4 0SP, UK, Tel: +44-752-266351, Telex: 45549 GLDFG G, Contact: Mr Southerby. Manufacturer of industrial process and service lubricants, oil additives, technical finishes and electrical coatings. Specialised oil greases and dry film lubricants have been designed for dams, penstock, screwthreads, chains, gears and valves.

**EVERY-DENISON LTD** Moor Rd, Leeds, LS10 2DE, UK, Tel: +44-532-708011, Telex: 557526, Fax: +44-532-

## MISCELLANEOUS

712850, Contact: Mr Hunter. Manufacturers of materials testing machines (tension, compression, hardness, impact and spring) aimed at testing plastics, metals, concrete and non-metallics.

**BOWTHORPE EMP LTD** Stevenson Rd, Brighton, Sussex, UK, Tel: +44-273-692591, Telex: 87357, Contact: Mr Hill. Suppliers to the world market of power transmission line equipment for extra high voltage transmission, medium and low voltage distribution and surge arresters.

**BURNHAM PLASTIC PRODUCTS** Unit A, Mildmay Industrial Estate, Foundry Lane, Burnham-on-Crouch, Essex, CM0 8SH, UK, Tel: +44-621-782911, Contact: John Beard. Manufacturers and suppliers of GRP products including access covers in 22 sizes, scumboards, weir plates, storage tanks and tank covers, diffusion drums, and cabinets and kiosks for instrument housing.

**CONSERVATEK** Post Office Box 1678, Conroe, Texas, 77305, USA, Tel: +1-409-539-1747, Fax: +1-409-539-5355, Contact: Nita Bailey. Conservatek designs, fabricates and erects all-aluminum clear-span, selfsupporting geodesic roofs. Our covers are frequently used to cover structures such as water storage reservoirs and wastewater treatment tanks. Our alumadome and alumavault roofs allow new and existing structures to be covered with a permanent roof that will not rust, rot, spall, crack, craze or rip.

**DIAMOND PURE WATER CO LTD** C P O Box #8186, Seoul City, 100-681, Rep of Korea, Tel: +82-2-335-5171-5, Fax: +82-2-335-2151, Contact: Duke J Yoo. Manufacturer of bottled water non carbonated, carbonated water and retail/delivery services.

**EASTERN METAL/USA-SIGN** P O Box 1430 Sullivan St, Elmira, New York, 14903-0188, USA, Tel: +1-607-734-2295, Fax: +1-607-734-8783, Contact: Barbara Beach. Manufacturer of signs and safety equipment for regulatory, parking, warning, construction, guide and park, business directional and custom facilities, posts and accessories for work zone and traffic control.

**ENALON LTD** P O Box 2, Sovereign Way, Tonbridge, Kent, TN9 1RR, UK, Tel: +44-732-358, Telex: 95469, Fax: +44-732-770463, Contact: Mr Baylif. Enalon manufactures the most extensive range of GRP reservoir inspection covers and instrumentation housing. Enalon are also injection moulding specialists with a purpose-built moulding plant, including design/toolmaking facilities.

**EURO-MATIC LTD** Sinclair House, The Avenue, Ealing, London, W13 8NT, UK, Tel: +44-1-991-2211, Telex: 934102, Fax: +44-1-997-5074, Contact: Mr Brown. Hollow plastic balls used as floating covers on tanks or lagoons to stop heat losses, evaporation or smell, oil absorbing booms for oil removals from water.

**FLUIDTECH PRODUCTS INC** 1250 Los Vallecitos, San Marcos, CA, 92069, USA, Tel: +1-619-744-8020. Manufacturing machine shop products in steel, stainless steel and plastic finishes in paint to specification and electro-polish.

**GILMOUR GROUP** 332 W Broadway, Louisville, KY, 40202, USA, Tel: +1-502-587-5975, Fax: +1-502-587-5142. Pruning shears, loppers, hedge shears, saws, pole pruners and garden hose.

**GOTECH TRADING LTD** Boulton Rd, Pingreen, Stevenage, Herts, UK, Tel: +44-438-740400, Telex: 825725, Contact: Mr Gonnermann. Supply a leak detection spray by the name of 'Galutec' which is used for the location of gas and compressed air leaks. Also a chemical and oil absorbent under the name of 'Rench-Rapid' which is designed to deal with almost all types of liquid spillages. Generally active in the export of products in the field of NDT.

**IMMEDIATE BUSINESS SYSTEMS** 3 Clarendon Drive, Wymbush, Milton Keynes, MK8 8DA, UK, Tel: +44-908-568-192, Telex: 825256 IBSMK, Fax: +44-908-561-401, Contact: Alan Senior. The IBS FW60 is a powerful hand held computer, lightweight, rugged, fully programmable and easy to use. Full range of peripheral equipment, features include: watertight enclosure, customised keyboards and supertwist display plus, up to 1mbyte of RAM.

**MATT-SON INC** 28 W 005 Industrial Avenue, Barrington, IL, 60010, USA, Tel: +1-312-628-8766, Contact: Brett Oleskaw. Design, manufacture and distribute plastic components for the water treatment industry. Stock supplier of US water treatment.

**MICRON SPRAYERS LTD** Three Mills, Bromyard, Herefordshire, HR7 4HU, UK, Tel: +44-885-482397, Telex: 35296 Micron G, Fax: +44-885-483043, Contact: Mr Hamer. Manufacturer of ultra low volume hand-sprayers and atomisers based on the principle of rotary atomisation.

**PILKINGTON INSULATION LTD** P O Box 10, St Helens, Merseyside, WA10 3NS, UK, Tel: +44-744-24022, Telex: 628230, Fax: +44-744-612007, Contact: Mr Lomax. Manufacturers of rock and glass wool insulation products, and via Kooltherm, their associate company, sophisticated plastic foam insulants.

**R A M JOINTINGS LTD** Threemilestone Industrial Estate, Truro, Cornwall, TR4 9LD, UK, Tel: +44-872-77648/78846, Telex: 45123, Fax: +44-872-75584, Contact: Mr Hicks. Manufacturers of gaskets in CAF, cork, insertion, neoprene, nitrile, viton, PTFE, silicon and Water Council-approved rubbers. All materials are supplied in sheet or strip form.

**R O E INC** 1307 E Pomona St, Santa Ana, California, 92705, USA, Tel: +1-714-542-2431. R O E Inc is the manufacturer/supplier of "ULTRA" brand cleaning products. We manufacture and supply laundry powders and personal care products that are specifically formulated for use with soft or conditioned water.

**WILLIAM WARNE LTD**, Barking, Essex, IG11 7LL, UK, Tel: +44-1-594-3800, Telex: 23979, Fax: +44-1-594-0517, Contact: Mr Stevens. Specialist manufacturer of industrial rubber products including rubber suction and delivery hose eg for water pumps, rubber rings to BS2494 for sealing concrete pipes.

# Advertisers' Index

A/S de Smithske	322/323	Danube Hydro Austra AG	315
AB Sandvik	78	DDS Filtration	190/191
Abem AB	39	John Deere Engine Group	272
ABS Pumpen AG	342/343	Deeprack	73
Acqua SpA	319	EES Corporation	185
Agrar und Hydrotechnik GmbH	407	Efimex SA	45
Agromachinainpex	120	Energomachexport	296
Al Kawther	170/171	Engineering & Power	
Aluker	160	Development Consultants Ltd	412
Amex Gesellschaft fur Rohrleitungsbauteile und Anlagentechnik mbH	126	Enviro-Care Co	251
Amtrol Inc	130/131	EOTVOS Lorand Geophysical Institute	41
Ansaldo Sistemi Industriali	6/7	Esse BI Plastics S.R.L.	
Aqua-Chem Inc		Inside Front Cover/103/Inside Back Cover	
(Water Technologies Division)	158/159	Fabbrica Turbine e Caldaie	314
Aquafine UK Ltd	142	Fluid Products Co Inc	375
Aquarius Water Purification Ltd	179	Fuxinos Italia SRL	52
Aquasolar	181	Flygt AB	338/339
Armstrong Machine Co	70	Franklin Hodge Industries Ltd	135
Astore SpA	115	Fraste SpA	72
Atlas Copco	71	Global Resource Planning Inc	415
Atochem	152/153	Gorman-Rupp International Co	327
AVK Scan-Wass Group A/S	110/111	Gressbach GmbH	98
Aztec Environmental Control Ltd	199	Grundfos	66/67/336
IMI Bailey Birkett Ltd	140	Hach Co	353
Bailey Control Valves	106	Hagusta GmbH	46/47
Benckiser-Knapsack GmbH	157	Hepworth Building	
Isaac Bentley & Co Ltd	104	Products International	96
Bison Instruments	63	Hurley Chicago Company Inc	196
Bizzi & Tedeschi	337	Hydro Instruments Inc	360
Boode BV	51	Hydrotechnik GmbH	174/175
Boots Microcheck		Hyperfil Industries Inc	225
(Industrial Systems)	154/155	Hypofors	21
Camp Dresser & McKee		ICI Biological Products	238/239
International Inc	411	Ideal Horizons	187
Chapman and Hall	424	ILVA SpA	97/141
Chemolimpex	163	Ingersoll-Rand	4/5/75
Cherne Industries Inc	100	Innova Tech Inc	249
Condriil AB	61	Insituform Group Ltd	125
Cosmoplast Industrial Co	44	Intersigma	62
CSR Humes PTY Ltd	95	IREM SpA	317
CTM Chemotechnik GmbH	22	Irrigation Power Systems Ltd	305
Cynamid International Outside Back Cover		Johnson Controls International Inc	348/359
Danfoss A/S	379/387	Johnson Filtration Systems	49
		Katadyn Products Inc	183/230

Advertisers'  
**Index**

King Lee Chemical Co	167	Re-trac Water Systems SA	278/279
Kipszer	203	SA Carmeuse	209
Konrad Stukerjurgan	37	Saline Water Conversion Corp	144/145
Kronos Titan GmbH	165	Schramm Drilling	79
Krupp Widia GmbH	74	Siemens Solar GmbH	68
Kugler Fonderie & Robinetterie SA	116	Sihi Halberg	123
Lahmeyer International GmbH	388	Societe des Eaux de Marseilles	400/401
Metalna	300/301	Socla International	108/109
Mid-South Pump Co	290	Soilmec SpA	82
Milnes PTY Ltd	102	Spectrascan Ltd	381
Monarflex Ltd	15/25	Stockhausen GmbH	195
Motorenfabrik Hatz GmbH & Co KG	303	Straub Kupplungen AG	114
FE Myers Co	341	Strojexport	80/81
National Engineering Laboratory	433	Suar	18/19
Natural Ecology Water Sciences	197	Sulzer (UK) Pumps Ltd	146/147
Neste Advanced Power Systems	65	Sulzer Brothers Ltd	58/59
Netafim Irrigation Inc	281	Swedepump	54
Nikex Hungarian Foreign Trading Co	286	Tamrock Driltech	30
NRG Enterprises Inc	196	Tamrock Group	10
Nuovo Pignone ENI Group	118/119	Tesco	403
OCV Control Valves	112	Thames Water International	409
Oetiker Inc	289	Torrent Pump Industry	121
Orlando Laboratories Inc	415	Tubafor International	43
Osmonics Inc	205	URS International	420/421
Pannonplast	243/253	V/O Chimashexport	325
Peabody TecTank	133	V/O Energomachexport	308-312
Peeters Drilling	77	Valmont International	268/269
Pegler International	107	Vammalan Konepaja Inc	56
Pergamon Press PLC	429	Viking Johnson Ltd	105
Pfizer Inc	227	Vinilplastika	94
Polar Bear Water		Volvo Penta AB	298/302
Distillers Manufacturing Co Ltd	193	WAB Water & Wastewater Treatment	207
Polcon Italiana SRL	241	Wassertechnik GmbH	246
Polimex-Cekop Ltd	261	Water Research Centre, Swindon	431
Portals Water Treatment Ltd(PWT)	234/5/6	Water Supply Accessories	113
Preussag AG Bauwesen	9	Weaver and Hurt	84
Pumpenboese	38	Wirth Maschinen und	
QPS Plastics Ltd	259	Bohrgerate Fabrik GmbH	83
Quietflo Engineering Ltd	128	Wulfing und Hauck	181
Mark Rainer International Ltd	399	Yellow Springs Instrument Scientific	369



foto lanoni

All our production is designed  
and realized in order to guarantee  
the safety and easiness of use  
in the irrigation of food, drinking water  
and other products.

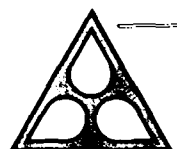
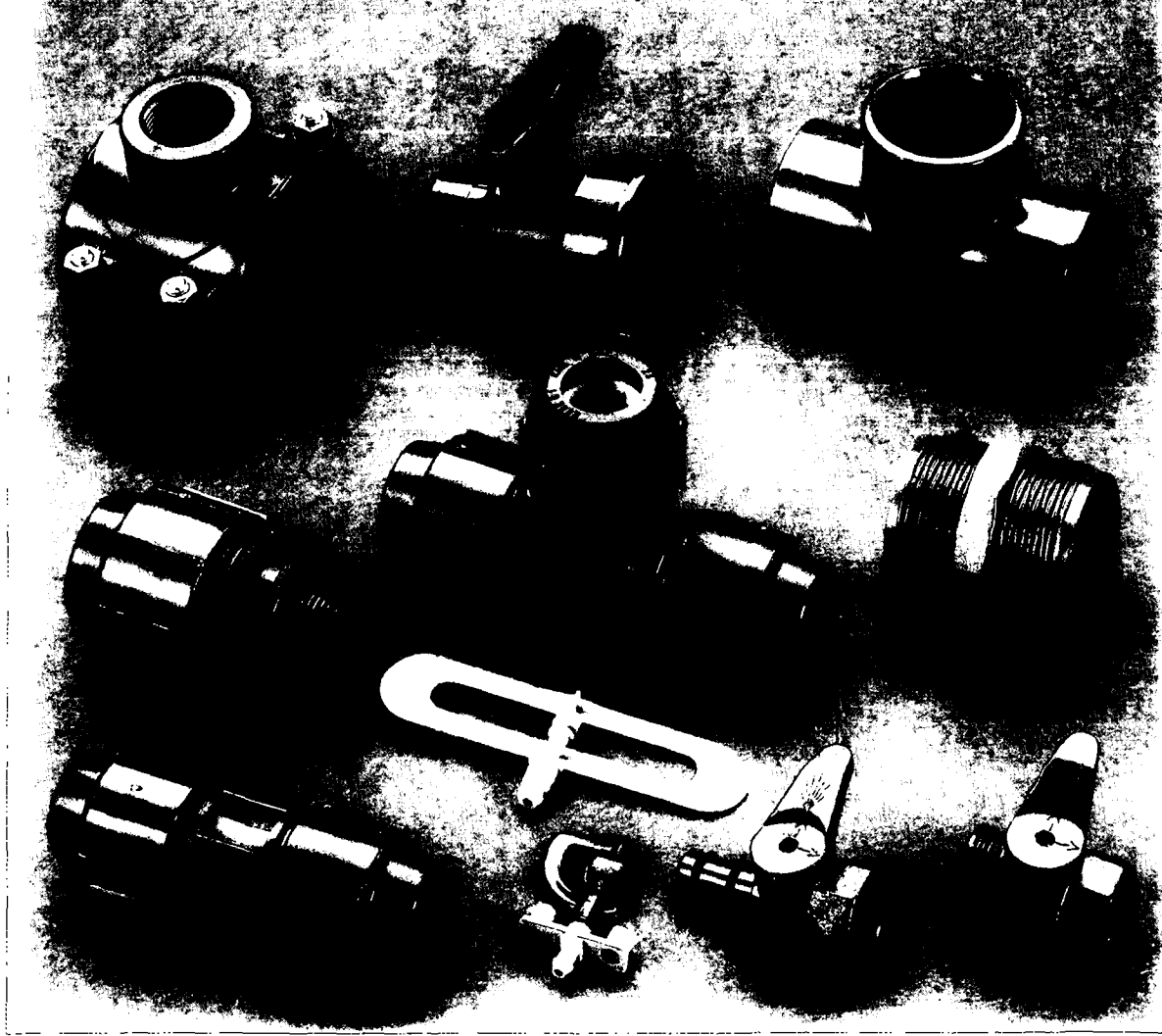

**ESSE BI PLASTIC** s.r.l.

Production of P.P. and P.V.C.  
pipe fittings for irrigation  
and the building industry

Via La Forma, 1  
60020 Sirolo (AN)-Italy  
Tel. 071/7360014-5  
Telex: 560606 HARRAI  
Fax: 071/936787

# Let Cyanamid work with you to help solve your water treatment and wastewater problems.

Cyanamid is a world leader in polymer chemical development for water and wastewater management technology. This research has produced SUPERFLOC\* flocculants — an extensive line of cost-effective products. Available in dry, liquid and emulsion forms, SUPERFLOC flocculants offer a wide range of ionic charges and molecular weights.

SUPERFLOC flocculants have proved

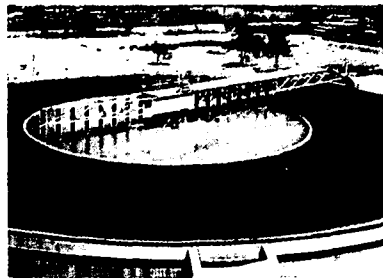

themselves in thousands of applications — from clarification and filtration

to thickening, dewatering and other liquid-solids separation processes.

Another proven Cyanamid product is CYANAMER\* P-80 anti-scalant widely used for inhibiting the precipitation of scale forming materials in industrial water systems and seawater desalination.

For cost effective help in solving your water management needs, contact your nearest Cyanamid office.



## Cyanamid International Chemicals Division

### Cyanamid Latin America Group—Chemicals

One Cyanamid Plaza  
Wayne, NJ 07470 U.S.A.  
Phone: 201-831-2000  
Telex: 219136

Cyanamid Australia, Pty., Ltd.  
Baulkham Hills, N.S.W.  
Phone: 61-2-624-9333

Cyanamid Canada, Inc.  
Markham, Ontario  
Phone: 416-470-3600

Cyanamid of Great Britain, Ltd.  
Bradford, West Yorkshire  
Phone: (44-274) 733891

**Cyanamid  
advances  
water  
management  
technology.  
Again.**

Cyanamid France  
Centre D'Affaires,  
Silig-Rungis, France  
Phone: (33-14) 687-23-19

Cyanamid G.m.b.H.  
Wolfratshausen,  
Federal Republic of Germany  
Phone: (49-8171) 221

Cyanamid (Far East) Ltd.  
Singapore Phone: 65-337-0222  
Hong Kong Phone: 852-5-719281-5

Cyanamid India, Ltd.  
Bombay  
Phone: 91-22-493521

Cyanamid Chimica Italiana SRL  
Milano  
Phone: (39-2) 545-6171

Cyanamid Korea, Inc.  
Kangnam-ku, Seoul  
Phone: 82-2-552-3541

Cyanamid B.V.  
Rotterdam, The Netherlands  
Phone: (31-10) 4116340

Cyanamid Philippines, Inc.  
Metro Manila  
Phone: 63-2-852-970

Cyanamid Iberica, S.A.  
Madrid, Spain  
Phone: (34-1) 653-2900

Cyanamid Taiwan Corp.  
Taipei  
Phone: 886-2-506-3222

Cyanamid Thailand, Ltd.  
Bangkok  
Phone: 66-2-235-5660 (3)

Cyanamid de Argentina S.A.I.C.  
Buenos Aires  
Phone: 54-1-772-4031/39

Cyanamid Quimica do Brasil Ltda.  
Rio de Janeiro  
Phone: 55-21-217-6611

Cyanamid de Chile Ltda.  
Santiago  
Phone: 56-2-225-2345

Cyanamid de Colombia, S.A.  
Bogota  
Phone: 57-1-260-3044/1107

Cyanamid Inter-American Corporation  
San Jose, Costa Rica  
Phone: 506-53-80-66

Cyanamid de Mexico,  
S.A. de C.V.  
Mexico, D.F.  
Phone 525-677-0338

Cyanamid Peruana, S.A.  
Lima, Peru  
Phone: 51-14-42-1517

American Cyanamid Company  
(Caribbean Branch)  
Rio Piedras, Puerto Rico  
Phone: 809-752-3000

Cyanamid de Venezuela, C.A.  
Caracas  
Phone: 58-2-241-0882

\*Trademark