

201
80RU

201-11336

**Republic of the Philippines
NATIONAL WATER RESOURCES COUNCIL**

**ALFREDO L. JUINIO, Chairman
Minister
Ministry of Public Works**

**JOSE J. LEIDO, JR., Member
Minister
Ministry of Natural Resources**

**IMELDA ROMUALDEZ MARCOS, Member
Minister
Ministry of Human Settlements**

**GERONIMO Z. VELASCO, Member
Minister
Ministry of Energy**

**GERARDO P. SICAT, Member
Minister
National Economic and
Development Authority**

**OSCAR I. ILUSTRE, Member
General Manager
Metropolitan Waterworks and
Sewerage System**

**ARTURO R. TANCO, JR., Member
Minister
Ministry of Agriculture**

**GABRIEL Y. ITCHON, Member
President
National Power Corporation**

**FIORELLO R. ESTUAR, Member
Administrator
National Irrigation Administration**

**DR. ANGEL A. ALEJANDRINO
Executive Director**

The National Water Resources Council (NWRC) is the body responsible for coordinating and integrating all activities related to water resources development and management. Its principal objective is to achieve scientific and orderly development and management of all the water resources of the country consistent with the principles of optimum utilization, conservation and protection to meet present and future needs.

g33^{III}

201
80 RU

RURAL WATER SUPPLY OPERATION AND MAINTENANCE MANUAL VOLUME III

LIBRARY, INTERNATIONAL REFERENCE
CENTRE FOR COMMUNITY WATER SUPPLY
AND SANITATION (IRC)
P.O. Box 98722, 2008 AG The Hague
Tel. (DFO) 0748 11 ext. 11142

IRN: 11336
LOC: 201 80RU



REPUBLIC OF THE PHILIPPINES
NATIONAL WATER RESOURCES COUNCIL
8TH FLOOR, NIA BUILDING, E. DELOS SANTOS AVE. Q.C.

17 November 1980

MEMORANDUM

F O R : THE HONORABLE MEMBERS
National Water Resources Council

SUBJECT : Rural Water Supply — Operation and Maintenance Manual

We are pleased to submit herewith the Rural Water Supply Operation and Maintenance Manual which is Volume III of the three-volume Technical Manual on Rural Water Supply Systems.

This manual was prepared to serve as reference for training local engineers and operators on proper operations and maintenance of small water supply systems.

We hope that it would help the national government in its effort to provide water to all our people by the year 2000.

ANGEL A. ALEJANDRINO
Executive Director

FOREWORD

The national government is embarking on a massive program to provide water to all areas of the country by providing technical, financial and institutional assistance to local communities. This will require the adoption of appropriate technologies especially for rural water supply systems and the transfer of such technologies to local engineers that will be involved in the implementation of projects.

There will be a need to develop local expertise on the technical aspects of water supply projects to support the program. Local engineers will have to be trained in the design, construction, operation and maintenance of water supply projects.

With this in mind, the National Water Resources Council, through its Task Force on Rural Water Supply, undertook studies on rural water supply including the preparation of a three – volume technical manual. The three volumes are on Design, Construction and Installation, and Operation and Maintenance.

This manual is intended to be used as reference and training materials for local engineers and operators as a guide in servicing water supply systems serving a population of not more than 4,000. It discusses the operation and maintenance of the different components of a small water supply system.

Although the contents of this manual are the product of many years of experience of and studies made by the consultants and NWRC, it is felt that there is room for further improvement and refinement of this manual.

Comments and suggestions regarding the contents of this manual would be most welcome and should be sent to the National Water Resources Council.

Special thanks and appreciation are due to the World Bank for supporting part of the studies on rural water supply, the DCCD Engineering Corporation for preparing the drafts of the technical manuals, and to Mr. C. D. Sprangler for his review and suggestions on the manuals.

ANGEL A. ALEJANDRINO
Executive Director

TABLE OF CONTENTS

CHAPTER NO.	DESCRIPTION	PAGE NO.
1	MANAGEMENT OF SMALL WATER SUPPLY SYSTEMS	
1.01	Importance of Management.	1
1.02	Function and Duties of Manager/Operator	1
1.03	Personnel Training.	3
1.04	Health and Welfare of Operator.	3
1.05	Records and Reporting System	3
1.06	Operation and Water Rationing During Emergencies Such as Power Failures, Fire Break-Out and Other Calamities	9
2	MAINTENANCE OF WATER SOURCES, AND RELATED FACILITIES	
2.01	General	11
2.02	Maintenance and Repair of Wells.	11
2.03	Maintenance and Repair of Rainwater Catchment and Storage Facilities	18
2.04	Maintenance and Repair of Spring Box	22
2.05	Maintenance and Repair of Infiltration Galleries	22
3	OPERATION AND MAINTENANCE OF PUMPING FACILITIES	
3.01	General	25
3.02	Classification of Pumps according to priming operation	25
3.03	Automatic Operation of Pumps.	25
3.04	Reciprocating Pumps.	26
3.05	Centrifugal Pumps	30
3.06	Jet Pumps	30
3.07	Submersible Pumps	39
3.08	Maintenance of Pump House and Surroundings	41

CHAPTER NO.	DESCRIPTION	PAGE NO.
4.	OPERATION AND MAINTENANCE OF THE WATER DISTRIBUTION SYSTEM	
4.01	General	44
4.02	Pipelines	44
4.03	Valves and Public Faucets	55
5.	MAINTENANCE AND REPAIR OF RESERVOIRS	
5.01	Operation	58
5.02	Cleaning	58
5.03	Detection and Repair of Leaks in Steel Tanks	59
5.04	Detection and Repair of Leaks in Concrete Reservoirs	
5.05	Inspection and Maintenance of Reservoir and Appurtenances	60
5.06	Methods of Repairing Leaks in Reservoirs	60
5.07	Painting of Reservoirs	63
6	OPERATION AND MAINTENANCE OF SLOW SAND FILTER	
6.01	General	64
6.02	Elements of a Slow Sand Filter	64
6.03	Start-Up of a Newly Constructed/Cleaned Slow Sand Filter	66
6.04	Ripening of the Filter	66
6.05	General Operating Procedure	66
6.06	Filter Cleaning	67
6.07	Resanding	68
6.08	Washing of Filter Sand	71
7	OPERATION AND MAINTENANCE OF CHLORINATORS	
7.01	Pot Chlorinators	73
7.02	Plastic Jerrycan Chlorinator	73
7.03	Bottle Solution Feeder	76
7.04	V-Notch Constant Head Solution Feeder	79
7.05	Floating Bowl Chlorinator	79

•

x

CHAPTER NO.	DESCRIPTION	PAGE NO.
8	DISINFECTION	
8.01	General	83
8.02	Disinfection of Water Supplies	83
8.03	Disinfection of Wells and Pumping Facilities	85
8.04	Disinfection of Reservoirs and Storage Tanks	85
8.05	Disinfection of Pipelines	85
	APPENDICES	A- 86
	B- 94
	BIBLIOGRAPHY	95

LIST OF FIGURES

FIGURE NO.	TITLE	PAGE NO.
2.1	Surging by Use of Plunger (Alternative I)	14
2.2	Surging By Use of Plunger (Alternative II)	15
2.3	Rainwater Catchment and Storage Facilities for a Typical Household Requirement.	19
2.4	Typical Spring Intake Box Arrangement	20
2.5	Spring Intake Box Details	21
2.6	Details of An Infiltration Gallery	24
3.1	Detail of Reciprocating Pump and Appurtenances	27
3.2	Detail of Centrifugal Pump and Appurtenances.	31
3.3	Detail of Jet Pump and Appurtenances	36
3.4	Detail of Installed Submersible Pump and Appurtenances	40
4.1	Methods of Repairing Pipe Leaks	51
4.2	Replacement of Damaged Section of Pipelines	52
4.3	Jointing of Polyethylene Pipes	54
5.1	Making a Cut on the Reservoir (For Purposes of Patching-up Cracks)	61
6.1	Essential Parts of Slow Sand Filter	65
6.2	Complete Resanding	69
6.3	Throwing Over Resanding	70
6.4	Cleaning of Filter Sand	72
7.1	Pot Chlorinators	74
7.2	Plastic Jerrycan Chlorinator	75
7.3	Bottle Solution Feeder (Siphon Type)	78
7.4	Bottle Solution Feeder (Liquid Seal Type)	80
7.5	V-Notch Constant-Head Solution Feeder	81
7.6	Floating Bowl Chlorinator.	82
8.1	Water Seal Tank	84

LIST OF TABLES

TABLE NO.	TITLE	PAGE NO.
1.1	List of Customers/Water Users	5
1.2	Yearly Collection Records	6
1.3	Yearly Depreciation Rates for Rural Water Supply Systems	7
2.1	Common Causes of Well Failures and Their Remedies	12
2.2	Interpretation of the Results of Well Testing	13
2.3	Common Causes of Failures in a Spring Box and Their Remedies	22
3.1	Common Troubles in Operating Reciprocating Well Pumps and Their Remedies	28
3.2	Common Troubles in Operating Centrifugal Pumps and Their Remedies	34
3.3	Common Troubles in Operating Jet Pump and Their Remedies	37
3.4	Common Troubles in Operating Submersible Pumps and Their Remedies	42

CHAPTER I

MANAGEMENT OF SMALL WATER SUPPLY SYSTEMS

1.01 IMPORTANCE OF MANAGEMENT

The continuous and successful operation of a water supply system depends largely on the patronage of its consumers. The consumers would only patronize a system if it can provide them safe water in sufficient quantities at all times at a cost within their reach. It should be pointed out that most residents in rural areas belong to the poor or middle income families and therefore will never spend a greater part of their income for water. They will first spend for their primary needs like food and clothing. Hence, there is a great probability that people might use the water readily available in a nearby river or shallow well regardless of whether it is safe or unsafe. This is especially true here in the Philippines where water is readily available in a nearby shallow well, spring or river.

Patronage of consumers can be achieved through good management. A water supply system is said to be well managed if it is properly operated and maintained, if its supplies and materials are wisely used, if its operating expenses are kept to a minimum level without sacrificing efficiency and if it has plans to meet future demands.

1.02 FUNCTION AND DUTIES OF MANAGER/OPERATOR

The number of personnel who will operate the system depends primarily on the number of consumers and the extent of the water supply system. In small systems, a part-time manager/operator is needed and in larger systems it might need a part or fulltime clerk in addition to a manager/operator. It should be pointed out that one form of keeping the operating cost at a minimum is to keep personnel cost low without sacrificing efficiency.

The manager/operator performs both the administrative and technical jobs. His administrative work consists of organizing the system, collection of water bills, handling of finances and supplies, and bookkeeping. His technical work consists of the operation and maintenance of water collection and distribution utilities and pumping equipment. Specifically, the daily, weekly and monthly duties of an operator are:

1 Daily Duties

- a. To start pump operation. Pumps can be started and stopped automatically by a float control in the storage tank and water will then be available for 24 hours per day. In case where the pump operation is not automatic, the operator may operate the pump 3-4 hours in the morning and 3-4 hours in the evening, depending upon the demand and in the water level inside the reservoir. He should check the motor and pump if they are functioning satisfactorily.

- b. To read and record water and electric meters and to determine the total daily water and electric consumption of the area being served. This data is necessary in determining if water is wisely used and for future developmental planning.
- c. To check the operation of chlorinator if it is working properly. He should clean and adjust it in order that the desired chlorine residual (0.5mg/ l) is obtained, if necessary. Also, he should make sure that there is adequate chlorine solution for the days operation.
- d. To keep unauthorized persons away from pumping stations and reservoirs.

2. Weekly Duties

- a. To make a round of the water supply system, investigating conditions of transmission and distribution pipes, public faucets, reservoirs and water sources.
- b. To record and advise the repair crew on defects noted and suggest or execute repairs. Also, he should update the log book on repair works completed.
- c. To perform all routinary maintenance on the pump and motor according to the manufacturer's recommendation including lubrication.

3) Monthly Duties

- a. To collect payments for water bills and to remit collected payments to the authorities or deposit it to the bank.
- b. To send billing notices to delinquent water users.
- c. To review and update monthly water bills and collection records. Also, he should prepare a simple financial statement every month.

4) Semi-Annual Duties

The operator should close and then re-open the main valves in the distribution system every six months. If this is not done, the valve operating system may become corroded and may not close when needed.

5) Annual Duties

The operator should prepare a short annual report listing the number of consumers, average amount of water pumped daily during the wet and dry season, changes in ground water level during the year, revenues and expenditures, list of delinquent consumers, financial statements, recommendations for improvement and other information requested for by the water committee. Also, he should update the list of water users.

1.03 PERSONNEL TRAINING

It should not be expected that highly trained personnel will be found in small rural areas or villages for the administration/management, maintenance and operation of a water system. Most of the time the candidate has little or has no knowledge about the system. However, he can be trained to handle the administrative and operational functions. He should be encouraged to learn how the water system has been constructed and commissioned. It is recommended that the operator attend an operator's training seminar

1.04 HEALTH AND WELFARE OF OPERATOR

The efficiency of the operation of a water supply system is primarily dependent on the health of the operator. Hence, provision should be made to safeguard it. Outlined below are some suggested measures:

- 1) All operators should be medically examined at least once a year. The examination may consist of routine stool test, urine test, x-ray, blood test, etc.
- 2) Any operator suffering from diarrhoea, open sores or other communicable diseases should be sent home for treatment and not be allowed to work as operator until he recovers. In which case, the management should see to it that there is a relief operator to take over in the absence of a regular operator.
- 3) Management should provide operators with protective clothings and other items necessary to protect the health of the worker.

1.05 RECORDS AND REPORTING SYSTEM

Well kept and updated records, plans and maps are indicative of a good water system administration and operation. Without these records, plans, and maps, difficulty will be encountered in operating and maintaining the water system. Efforts should be exerted so that valuable information will be recorded and that retrieval of needed data will not be dependent on the memory of people involved with the water system.

For rural water supply systems, records pertaining to the following aspects should be maintained:

1) Administrative and Financial

Records listing the people served, equipment used, supplies, inventories, billing and accounting.

2) Technical

Records of maps, as-built construction drawings describing the water system and a logbook of defects and repairs made.

3.) Day-to-Day Operation

Records should show the amount of water pumped or delivered, energy or kilowatt consumption, and observations on the operation of the system and disruptions, if any.

These records should be kept on files for easy retrieval. Records are necessary but keeping too many of them can also constitute a burden for the water system management and operation. In general, records should be simple and easy to use.

1. Administrative and Financial Records

For safe keeping, three separate folders each containing copies of the following records are recommended:

- a. Legal Documents, personnel involved with the operation and management of the system, and listing of customers or water users.
- b. Listing of available supplies and equipment, and equipment operation and maintenance manual.
- c. Purchasing, billing, collection of water fees and accounting of funds

A suggested format for the list of water users is shown in Table 1.1. Updating of the list of water users is usually done once a year.

A listing of all available supplies and equipment acquired and maintained by the water system should be in one separate folder. The listing shall indicate the type of equipment, manufacturer, date installed, model and serial number, its purchase cost, the place where it was installed and the person responsible for maintaining the said equipment. Manufacturer's recommendations as to the operation and maintenance of the equipment as well as the name, address and telephone number of nearest shop where it can be serviced should also be on file for easy reference by the operator(s). Inventory of equipment and supplies are usually done once a year.

Financial records of a small water supply system should be as simple as possible when it comes to billing notice, collection of water fees, purchasing of supplies and/or equipment/equipment parts and accounting of funds.

In some areas, collection of water fees may be difficult due to the poor financial status of the water users. Efforts must be exerted to explain that they are paying not for the water but for the services of bringing the water to their households, and that a water supply system can only survive if the water consumers continually contribute a fraction of their earnings for its operation. By involving them, they get a sense of ownership of the system besides the right to demand for better service.

Table 1.1

LIST OF WATER USERS

BARANGAY/MUNICIPALITY:

PROVINCE/REGION:

D A T E :

Head of the Family	Occupation Husband/Wife	Customers by Age Grouping				Total Users	Date Connected to the System
		1-6	7-17	18-25	25-up		
1. Juan dela Cruz	Farmer/none	0	2	1	2	5	March 1980
Total							

Table 1.2

YEARLY COLLECTION RECORDS
For the Year 1980

Water Users	A m o u n t P a i d*											
	Jan.	Feb.	Mar.	Apr.	May	Jun	Jul	Aug	Sept	Oct	Nov	Dec.
1. Juan dela Cruz	7.50	7.50	7.50	-	7.50	7.50	7.50	7.50				
2. Rodolfo D. Ramos	7.50	-	7.50	7.50	7.50	7.50	7.50	7.50				
3. Maria E. Reyes	7.50	7.50	7.50	7.50	7.50	7.50	7.50	7.50				
Totals for the Month												

* This should be checked with the individual card index on file.

Furthermore, billing notices should be made to ensure that service bills are paid for by the water users. They should be issued only to delinquent customers. Collection of water fees is usually done monthly, however, for small water supply systems and low income patrons, weekly collection of fees may be better. Receipts should be issued upon collection of water bills, with the originals being kept by the water users and the duplicates by the collector or operator.

During the first week of each month records showing the list of water users and the amount of their bills/payments and credits/dues must be updated. Table 1.2 shows a sample of the monthly/yearly collection record which can be adopted for a small water supply system. Also, a subsidiary ledger on weekly collections may be set up if found convenient and applicable to a particular community. Invoices and receipts of all purchases of supplies, equipment and parts, electric bills, etc. should also be kept for record purposes.

Accounting of funds is necessary to gauge the financial status of the system and is usually done monthly or quarterly depending upon the time available or work load of the operator. To evaluate the financial status of the water supply system, the following items should be included in the accounting:

- a Operating expenses
- b Reinvestment of capital and depreciation.
- c Cash position and accounts receivables.
- d. Payments to long-term debt or loan
- e Reserve for emergency purchase of spare parts or service pump

Table 1.3

YEARLY DEPRECIATION RATES FOR RURAL WATER SUPPLY SYSTEMS

Component of Waterworks System	Depreciation (in Percentage of Equipment Purchase and Installation or Construction Cost)
1. Reservoir and appurtenances	5
2. Pumping equipment and accessories.	20
3. Distribution system and accessories	5
4. Wells and appurtenances	5

Example 1.1 Determine the annual depreciation cost of the following equipment given the following data:

Equipment/Waterworks Section	Purchasing/Installation/ Construction Cost
1. Reservoir	₱ 10,000.00
2. Pump	3,000.00
3. Pipings, Valves, etc.	10,000.00
4. Well	6,000.00
 Solution:	
	Annual Depreciation Cost
1. Reservoir (0.05 x 10,000)	₱ 500.00
2. Pump (0.2 x 3,000)	600.00
3. Pipings, Valves (0.05 x 10,000)	500.00
4. Well (0.05 x 6,000)	300.00
	<hr/>
Total Annual depreciation cost	₱ 1,900.00 or ₱ 158.33/mo. say ₱200/mo.

Example 1.2 Determine the amount of money to be charged to the water users given the following data-

Data

No. of Water users	100 households
Operating expenses	₱400 per month
Payment to long-term debt (Amortization)	250 per month
Depreciation	200 per month
Reserve for Service (Repairs) Pump/Spare Parts	200 per month

Solution:

$$\begin{aligned} \text{Total Monthly expenses} &= ₱ 400 + 250 + 200 + 200 = ₱1,050.0 \\ \text{Monthly bill/household} &= \frac{₱1,050.00}{100} = ₱ 10.50 \text{ per month} \end{aligned}$$

2. Technical and Day-To-Day Operation Records

A water supply system should have a comprehensive map showing the entire water distribution system. The map should indicate the relative location of water source, reservoirs or storage tanks, water mains and service connections, valves and public faucets and revisions of the water distribution system, if any. If there are any revisions the type of equipment or material, location and date of installation or repair should be reflected in the map. The items usually shown in the map are:

- a. Street names;
- b. Location and sizes of water mains and valves;

- c. Location and volume of reservoirs;
- d. Location and sizes of public faucets;
- e. Approximate location of water users or households;
- f. Location and type of water source;
- g. Orientation arrows;
- h. Scale;
- i. Date last corrected and by whom.

The comprehensive map should be stored in files for easy reference of operators.

In cases where a master water and electric meter is installed to measure the quantity of water produced and the power consumed, it should be read and the readings should be recorded at least once a day.

For the day-to-day operation, the operator should have a log book where he can note down the systems daily condition and pump operation, and the repairs he had effected, if any. Usually the log book contains the following information: date, time when pump starts and stops, reading of master water and electric meter, nature of defects seen, type of repair work or action taken, and observations on the water distribution system as a whole.

1.06' OPERATION AND WATER RATIONING DURING EMERGENCIES SUCH AS POWER FAILURES, FIREBREAK -OUT AND OTHER CALAMITIES

1. Power Failures

The operator should be prepared for and well-informed of the schedule of power failures, and must insure that the reservoirs or storage tank is full of water by the time the power is out. For power failures which take one day or more, the operator should limit the supply of water to drinking purposes only by throttling the reservoir discharge valves. Supply from the individual hand pumps or private wells if available could supplement the stored water supply. On return to normal conditions, partially closed valves should be fully opened.

2. Fire Break-Out

The operator should assist fire fighters in putting out fires. This could be done by manipulating the gate or globe valves, if there are any, to concentrate the flow of water into the vicinity of fire. Another way is to ask users to refrain from opening the public faucets except in places near the fire. This would allow fire fighters to get more water from the nearby public faucets.

3. Calamaties

During big calamities, the operator and water users must work out a scheme to reduce water consumption to a minimum, to conserve water. During strong earthquakes, there is a possibility that pipelines, reservoirs and water

sources will be damaged; hence, the operator must conduct a field survey after the disaster to determine the extent of leakage due to pipe breakages or reservoir cracks, and conduct emergency repairs. In areas where sudden resettlement of large population is expected, the operator should ration water available to evacuees. Drinking water could be obtained from public faucets while water from individual source or sources such as from wells drawn by hand pumps or pail can be used for bathing and washing purposes. All efforts should be exerted not only by the operator but also by the water users to conserve and distribute water to all people in cases of very destructive catastrophes or calamities.

4.) Rationing

Rationing would be necessary during emergencies when there is an acute shortage of water. It is carried out by scheduled closure of distribution valves for groups of users for a certain period of the day. With rationing, people will realize the need and be forced to conserve water.

5.) Continuing Emergencies

If emergency lasts for more than 24 hours, the operator should notify the government agency who could help them. For all emergency cases, he should inform the consumers to conserve water.

CHAPTER 2

MAINTENANCE OF WATER SOURCES AND RELATED FACILITIES

2.01 GENERAL

The water source is the heart of the water supply system. To insure that the whole community has sufficient water at all times, it must be properly maintained. This can be done by periodically checking the water yield and if a defect is detected, this should be examined and corrected at the earliest possible time.

2.02 MAINTENANCE AND REPAIR OF WELLS

Groundwater is one of the widely used water source in the Philippines. Water is usually drawn through wells from the aquifer by pumping. A properly designed and constructed well will give many years of trouble free service. However, if the system fails, the cause of the failure should be determined and remedied immediately. The causes of the malfunction of the system may be due to over-pumping, defective or damaged well casing and/or screen, and incrustation of well screen. These failures are usually indicated by reduced or no pump discharge and/or poor quality of water delivered. Table 2.1 summarizes the causes and remedy for common well defects.

1 Common Causes of Well Failures

- A. **Overpumping** – Overpumping is the pumping of water more than the capacity of the well. Overpumping will result in the pumping of sand and eventually in the clogging of the screen, lowering of the water level in the well and the surrounding groundwater table, consequently reducing well yield or capacity. This problem can be solved by deepening the well or by reducing the pump discharge.

- B. **Corroded Well Casing** – A well casing is employed to prevent the collapse of the hole, entrance of undesirable water and escape of good water from the well. A well casing could be damaged if corrosive gases are present in water, corrosion could also be brought about by the direct reaction between water and casing material. The problem of damaged casing can be solved by one of the following:
 - a. If the diameter of the casing is of minimum size, build a new well in the vicinity.
 - b. If the diameter of the old casing is oversized, insert a new casing (diameter is two sizes smaller than the original) inside the damaged casing.

TABLE 2.1

COMMON CAUSES OF WELL TROUBLES AND THEIR REMEDIES

Indication	Probable Cause	Remedy
1. Incrustation or Clogging of Well Screen	Overpumping	— Reduction of the pumping rate.
	Deposition of suspended matter or fine sand and calcium carbonate	— Surging or acied treatment
	— Formation of slimy layer by bacteria.	— Chlorination
2. Lowering of the water level in the well and the surrounding ground table.	— Overpumping	— Deepening of the well or by reducing the pumping rate
3. Damaged well casing	— Corrosion	— If the diameter of the old casing is of minimum size, drill a new well.
		— If the diameter of the old casing is large, insert a new casing (with diameter two sizes smaller than the original) inside the damaged casing
4. Damaged Well Screen	— Corrosion	— If the casing is still in good condition, pull it out from the hole and replace the screen with a new one.
		— If both the casing and screen are corroded, see subsections B and C for the solution.
5. Deterioration of Water Quality	— Formation of Slimmy Layer by bacteria	— Chlorination
	— Leaks in well casing or infiltration of surface water.	— Grouting and/or Chlorination.

- C. Corroded Well Screen.** – A screen or perforated pipe is required at the bottom of the well to prevent the walls from caving into hole, to exclude fine sand and to permit entrance of water. In case the well screen or perforated pipe is completely damaged, no water can be pumped from the well. Damaged well screens can be corrected by:
- a. If the casing is still in good condition, pull it out from the hole and change the screen with a new one.
 - b. If both the casing and screen are corroded, either drill a new well or insert a new casing and screen (diameter two sizes smaller than the original casing inside diameter – see sub-section B: Corroded Well Casing) into the old one.
- D. Incrustation or Clogging of Well Screen** – Incrustation or clogging of well screen may be caused by direct deposition of suspended matter or fine sand, formation and deposition of calcium carbonate on the screen and deposition of slimy matter resulting from biological activity of bacteria. Calcium carbonate is the principal encrustant which forms scales on the screen and cements deposited particles. Incrustation caused by the deposition of suspended matter and/or scale could be corrected by surging or by muriatic acid treatment. Clogging due to bacteria can be corrected by chlorination.

Well Testing to Determine the Cause of Failure

The measurement of the static and pumping water levels will provide the necessary data which will reflect the condition of a well (The procedure of measurement is presented in Chapter 10 of the Design Manual). These data will reveal the cause of the malfunction. Presented in Table 2.2 is the manner of interpreting the collected data.

TABLE 2.2

INTERPRETATION OF THE RESULTS OF WELL TESTING

Case No.	Static Water Level	Drawdown	Interpretation
1)	Dropping	Unchanged	The water table is falling. This means that the aquifer is being depleted faster than it can recharge itself.
2)	Unchanged	Increasing	The screen or strainer may be clogged and water is not freely flowing into the well.
3)	Unchanged	Decreasing	There is a loss in the efficiency of the pump.

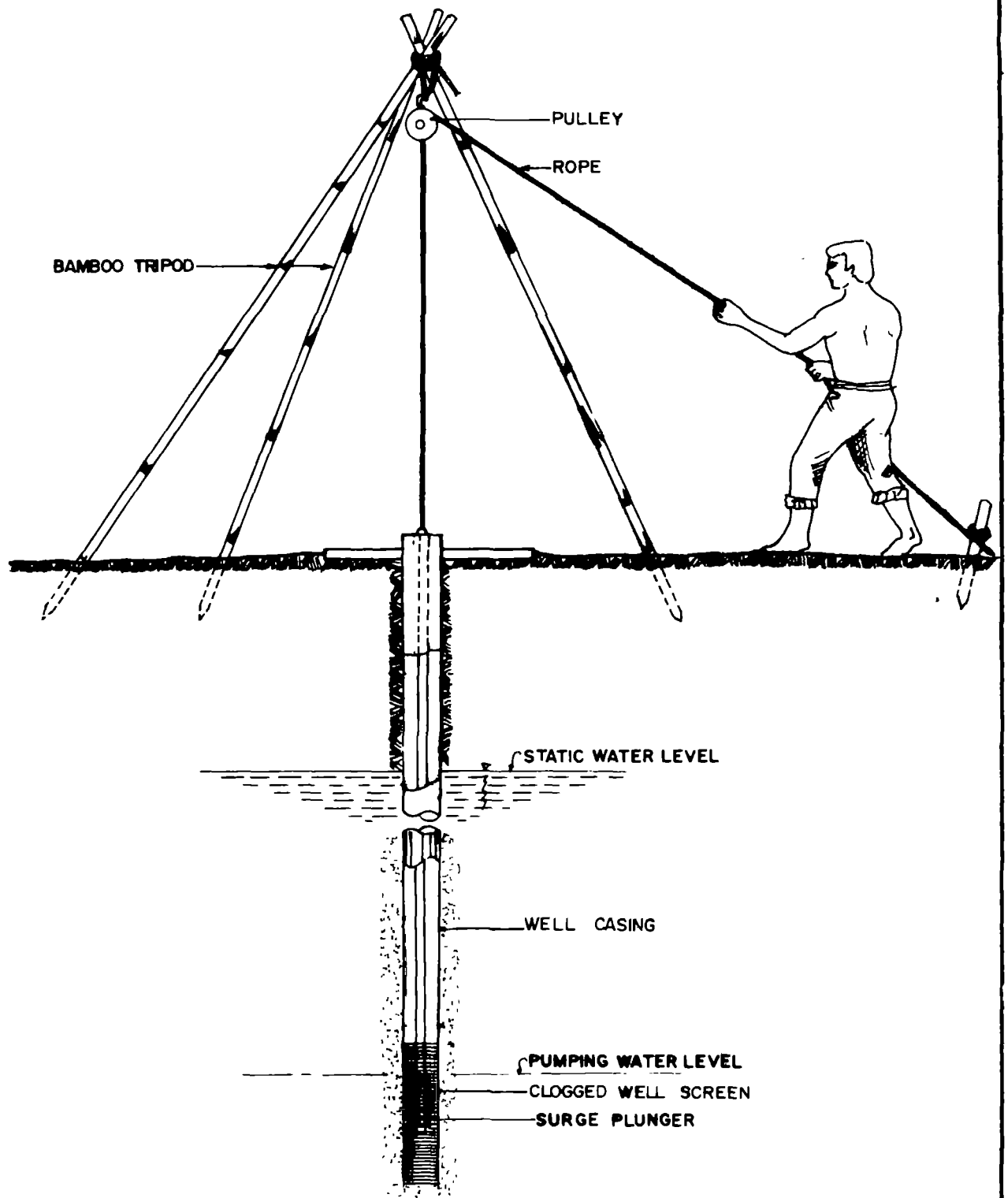

FIGURE 21

SURGING BY USE OF PLUNGER
(ALTERNATIVE 1)

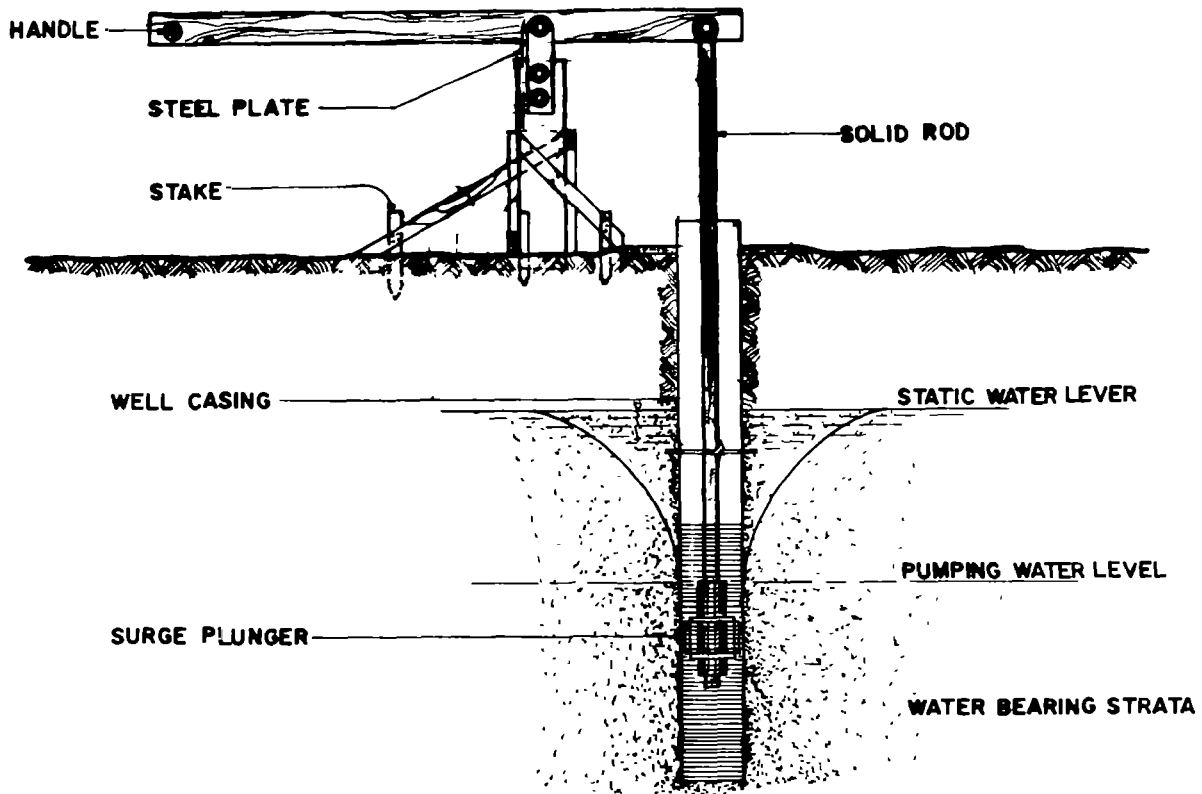

FIGURE 2.2

SURGING BY USE OF PLUNGER
(ALTERNATIVE 2)

3. Removal of Incrusting or Clogging Material

A. **Surging** – Surging is a physical method of removing or displacing the clogging material from the screen. The process consists of allowing water to flow at high velocity and pressure in the well into the aquifer to displace the adhering of deposited materials. Surging may be accomplished by any of these three methods-

a. Surging by Overpumping

- i) Draw water at a volume much greater than the pumping capacity of the well.
- ii) Immediately and forcefully introduce water back to the well to dislodge the clogging material.
- iii) Pump wastewater continuously until all dislodged materials are removed completely.

b. Surging by Use of Plunger

- i) Remove the drop pipe or pump column from the well.
- ii) Attach the upper end of the plunger rod to a well rig or tripod as shown in Figure 2.1. Alternatively, use the set up shown in Figure 2.2.
- iii) Introduce the plunger which loosely fits the wall of the casing and lower it beneath the water table.
- iv) Move the plunger up and down violently. This will cause the water to rush in and out of the well through the screen.
- v) Remove the plunger and install the pumping facilities.
- vi) Pump wastewater continuously until all dislodged materials are removed completely.

c. Surging with the Use of Dry Ice

The use of dry ice or solidified carbon dioxide has been successfully used in removing incrustations. However, precautions must be exercised when using it. Dry ice will cause frozen hands when handled with bare hands; suffocation when the operator has not adequately protected himself from carbon dioxide fumes; and lifting of casing and/or rupture of screen due to excessive pressures when more than enough dry ice is used.

PROCEDURES

- i) Remove the drop pipe or pump column.
- ii) Insert and support near the top of the well casing 25-100 kg. of dry ice. For a 50mm diameter well, 25-40 kg. of dry ice will be sufficient.
- iii) Release and allow the dry ice to fall into the bottom of the well. The dry ice upon contact with water will quickly turn to gas and generate a pressure.
- iv) Quickly screw on top of casing a cap containing a pressure gauge and a release valve. Allow the pressure to build up to 63M (90 PSI) and then open the release valve until the pressure drops considerably. Again close the release valve and allow the pressure to build up to the maximum allowable pressure. Repeat the alternate opening and closing of the release valve until all the dry ice is exhausted.
- v) Install the pumping facilities.
- vi) Pump wastewater continuously until all dislodged materials are removed completely.

B. Removal of Scaling Material (CaCO_3) by Acid Treatment

- a. Remove the drop pipe or column.
- b. Drop a plastic water hose into the well. The bottom end of the hose must be submerged in water to the depth of the screen.
- c. Introduce the commercial muriatic acid (27%) using the hose. 25% of acid applied must reach the screen to dissolve the scale which blocks the screen pores. In cases when well water contains iron, add 30% acetic or citric acid.
- d. Allow the acid to stand in the well from 10 to 24 hours during which time gently surge the well intermittently for short periods of time.
- e. Pump the wastewater out from the well.
- f. Continue the pumping operation until all traces of chemicals applied are removed.

C. Removal of Clogging Material Due to Bacteria by Chlorination

- a. Introduce 50 mg/l High Test Hypochlorite solution or any chlorine – containing compound into the well.
- b. Add enough water to push the chlorine solution down to the well screen.
- c. Allow the chlorine solution to stand for 24 hours.
- d. After 24 hours, pump water out of the well continuously until chlorine odor is no longer noticeable.

3. Chlorination

The well should be disinfected after repair. Chlorination is also used to kill bacteria clogging the well screens. The procedure for disinfection and the dosage of the chlorine containing compound to be used is discussed in Chapter 8.

2.03

OPERATION, MAINTENANCE AND REPAIR OF RAIN WATER CATCHMENT AND STORAGE FACILITIES FOR HOUSEHOLDS'

The quality of rain water collected is affected by the nature and degree of maintenance of the collection surfaces and storage facilities. In cases where the reservoir is not periodically cleaned, the number of bacteria may increase considerably because of the decomposition of organic matter held in suspension or in solution in water stored for long periods. The problems cited can be eliminated through cleaning at regular intervals.

1. Operation

Rain water is collected from roof surfaces of houses. From the roof, it flows to the gutter and then to the storage tank through the downspout by gravity. To remove dead leaves, dirt, dust, and other contaminants, the first five minutes of heavy rains is bypassed to drain by manipulating the flapper valve (Figure 2.3). When not in use, the flapper valve should be bypass position to prevent contamination in case that the rain starts at night and the collecting surfaces are dirty from the reservoir, water is distributed to the taps. Cleanliness of the collected rain-water can be verified by inspection.

2. Maintenance

The collecting surfaces and water conveyance system should be periodically inspected and cleaned. To protect them from corrosion, paint it with bituminous paints once every 5 years or oftener as required. With respect to the storage facilities, refer to Chapter 5 for its maintenance and repair.

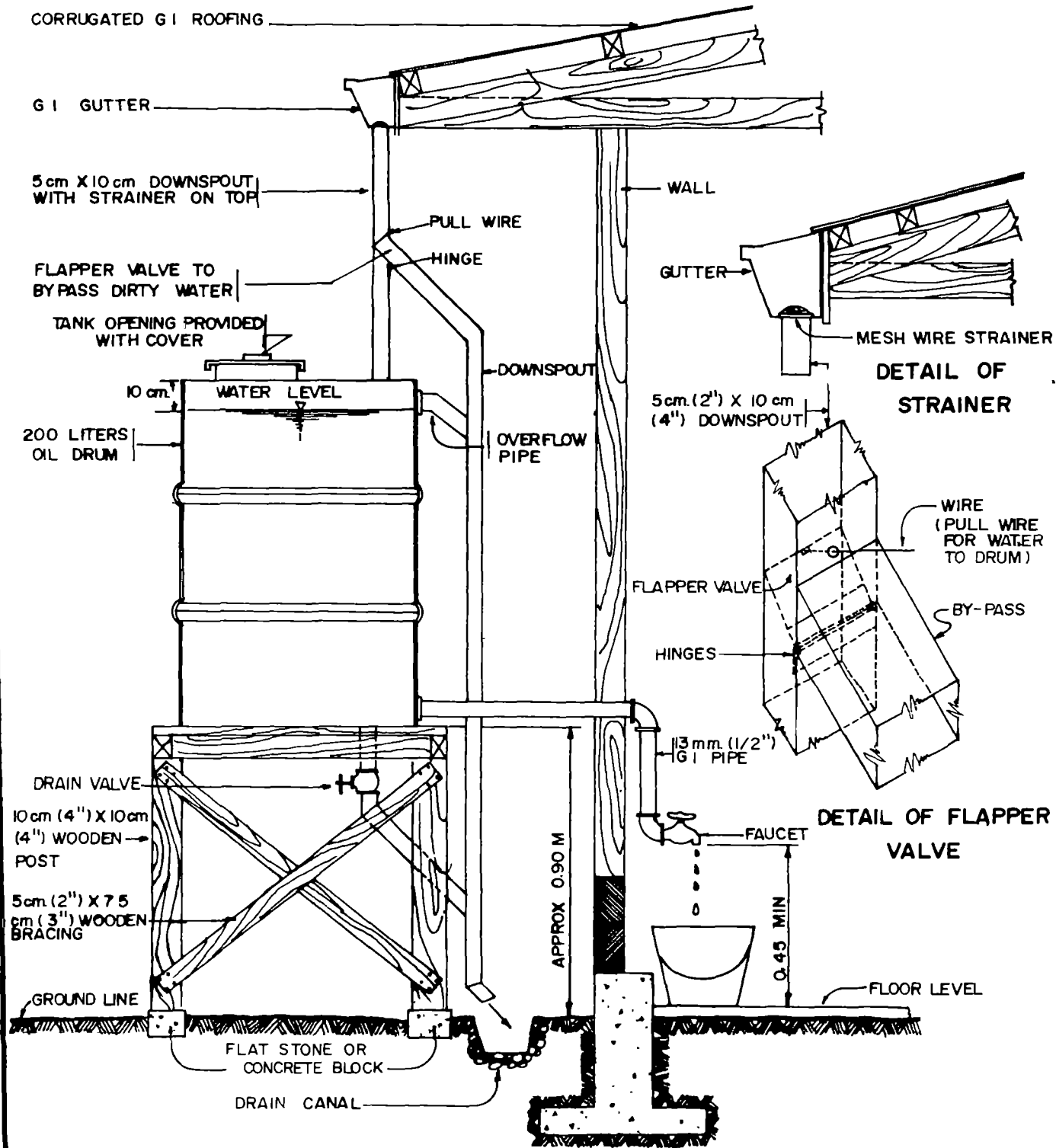
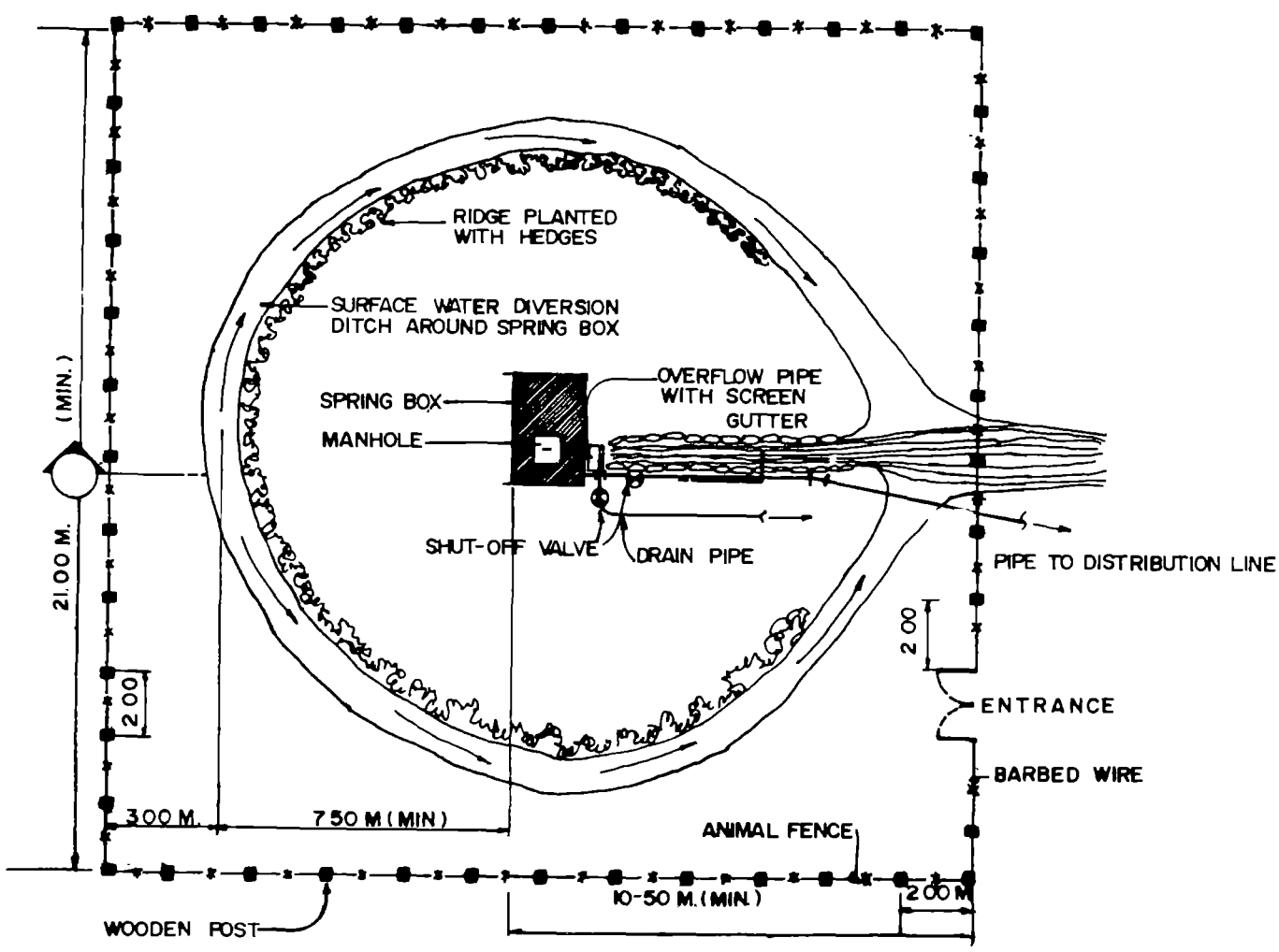

FIGURE 2.3

RAIN SPRING WATER CATCHMENT AND STORAGE FACILITIES FOR TYPICAL HOUSEHOLD REQUIREMENTS



P L A N

FIGURE 2 4

SIMPLIFIED SPRING INTAKE BOX ARRANGEMENT

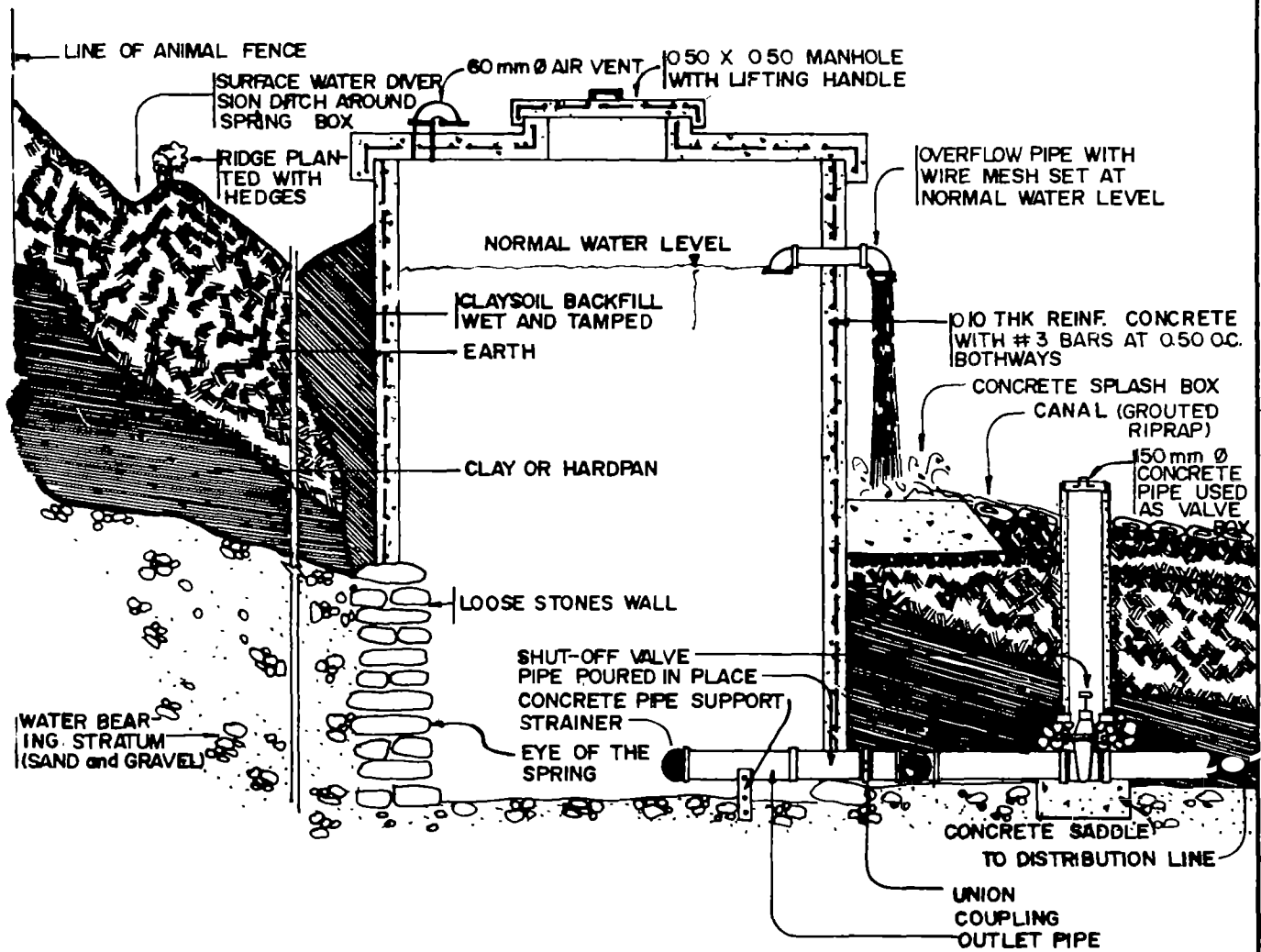

SECTION OF INTAKE SPRING BOX

WITH PROVISION FOR OPERATING T-WRENCH IF MORE THAN 0.45 M DEEP

FIGURE 25

SPRING INTAKE BOX DETAILS

2.04 MAINTENANCE AND REPAIR OF SPRING BOX

Periodic inspection must be conducted on the spring intake box and its surrounding (Figure 2.4) to prevent waterlosses and to protect water quality. Outlined in Table 2.3 are the common causes of failure in the spring box with suggestions for their remedies. It should be pointed out that a spring intake box is a concrete reservoir (Figure 2.5) used in collecting spring water; hence, its maintenance and repair is similar to the maintenance and repair of reservoirs as discussed in Chapter 5, to a much smaller scale.

TABLE 2.3
COMMON CAUSES OF FAILURES IN A SPRING BOX
AND THEIR REMEDIES

Defect	Remedy
1 Crack or Leak	Plug crack/leak with portland cement mortar
2 Damaged screens in overflow and vent	Replace damaged screen with a new one
3. Clogging of drainage canal	Clean drainage canal from all obstruction and check its slope.
4 Dilapidated Fence	Replace all worn out posts and repair fence.
5. Reduction of spring discharge due to clogging.	Clean the "eye" of the spring

2.05 OPERATION, MAINTENANCE AND REPAIR OF INFILTRATION GALLERIES

1. Operation

An infiltration gallery is a horizontal well which is used to collect naturally filtered water. It consists of a main collection sump, and perforated pipe water collectors which are surrounded by a filter blanket of sand and gravel (Figure 2.6)

Water enters the pipe collectors and then flows by gravity to the main collection sump or well. From the main collection sump, water is pumped out either directly to the consumers or to a storage tank and then supplied to the consumers.

2. **Common Causes of Failures of Infiltration Galleries**

- A. **Clogging of Filter Bed** – The clogging of filter blanket surrounding the perforated pipe water collectors is indicated by the lowering of the water level in the main collector sump while pumping at normal rates. This clogging is due to the deposition of fine silt or sand on the filter blanket. The clogging material can be dislodged by surging using compressed air or force pump. If this method will not work, dug up the pipe collectors and clean the sand/gravel blanket.
- B. **Poor Quality of Water Yield** – The most probable cause of the deterioration of water quality is a defective filter bed which allows contaminants to pass through. The water yield may be rendered safe again by either repairing the filter bed or by continuous chlorination.

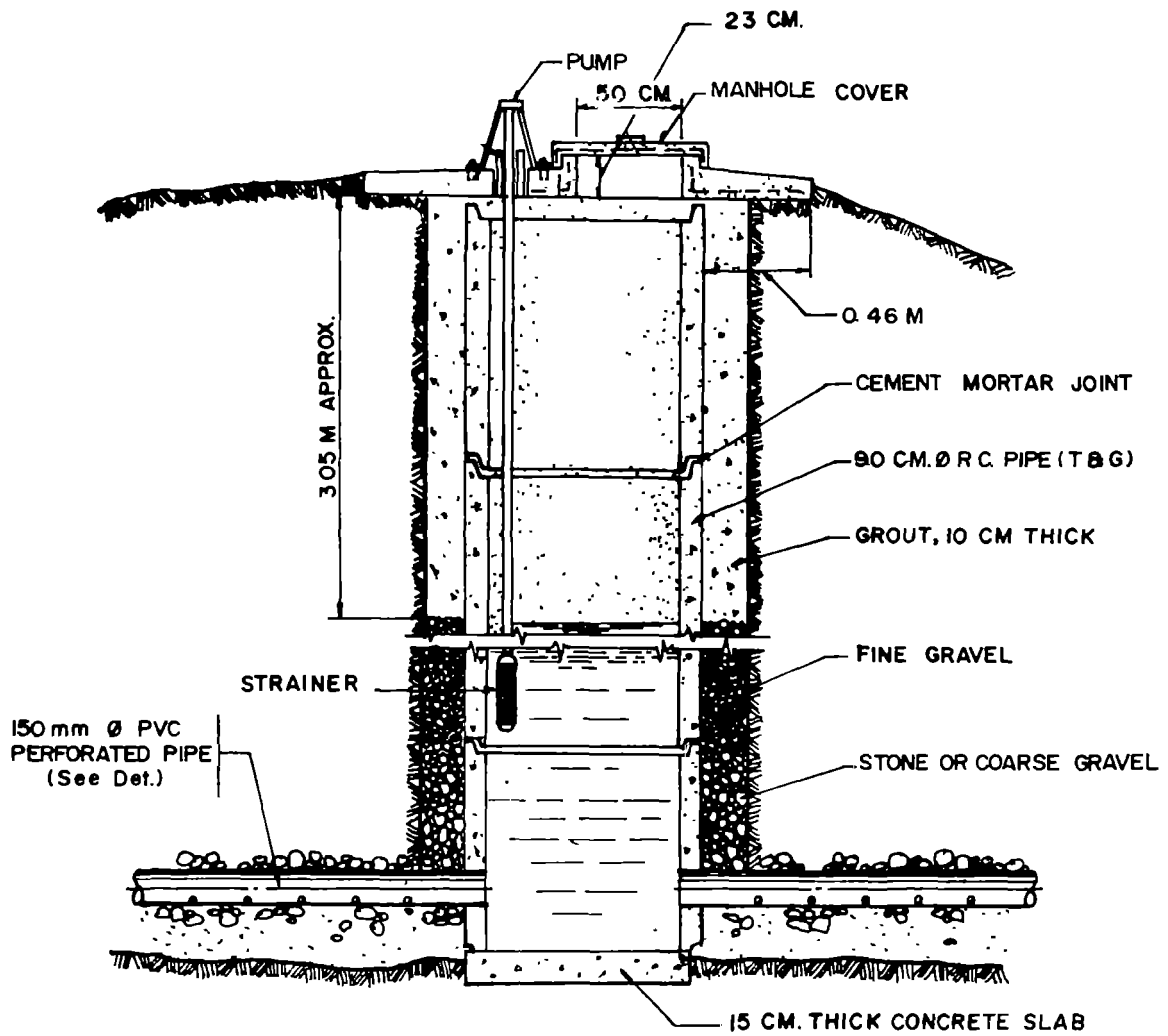

SECTION OF INFILTRATION GALLERY

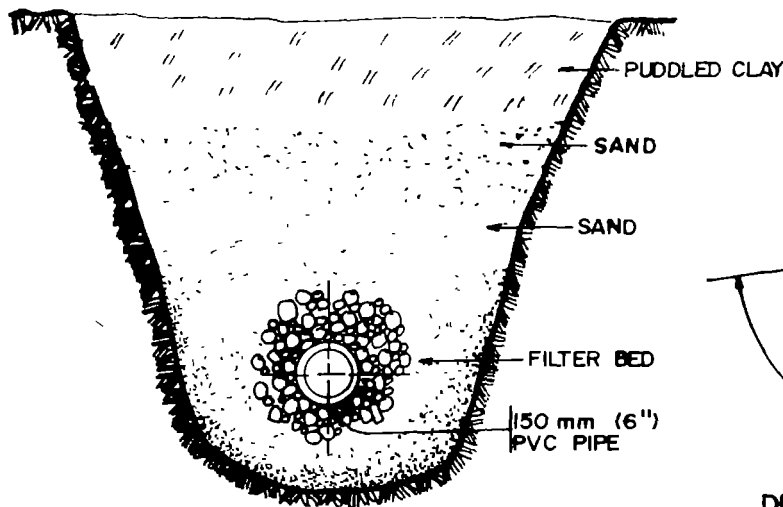

DETAIL OF PIPE COLLECTOR

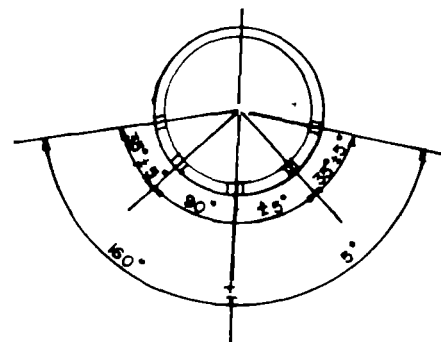

DETAIL OF PIPE COLLECTOR
635 mm (1/4") HOLES AT 76 (3") ON CENTER 4 ROWS PER LENGTH OF PIPE

FIGURE 2 6

DETAILS OF AN INFILTRATION GALLERY

CHAPTER 3

OPERATION AND MAINTENANCE OF PUMPING FACILITIES

3.01 GENERAL

Pumps when used in the water supply system should be properly operated and maintained to insure that water is delivered to users at all times. Generally, pumping facilities can be maintained in good condition if the guidelines presented below are followed.

1. Follow recommendation of the manufacturers on the manner of operating and maintaining the pumps. These recommendations are indicated in the manual which always accompany the purchased pumps.
2. Follow the maintenance schedule. Maintenance operations include greasing, oiling inspection, checking of voltage at power source (if electric motor driven), adjustment and repairs. If during inspection a defect is detected, it should be repaired immediately. The operator should not wait for this defect to become worse and cause other parts or the whole unit to fail.
3. Schedule the running and stopping of well pumps. The desirable schedule can be made by referring the pump capacity to the daily records of the water demand and water levels of the reservoir.

The operation and maintenance of common pumps used in small water supply systems is discussed in detail in succeeding sections.

3.02 CLASSIFICATION OF PUMP ACCORDING TO ITS PRIMING OPERATION

Pumps with motor located above ground may be classified as self priming and non-self priming. Pumps can be self priming by installing a foot valve which will hold the water level within the suction level of pumping facilities. Self priming pumps usually have lower efficiency than non-self priming pumps, however, the convenience in operation could off-set the disadvantages of lower efficiency.

Priming is a process of adding water to displace the air in the suction line or drop pipe of the pump. Air is compressible, hence, water cannot be sucked up because a vacuum could not be created.

3.03 AUTOMATIC OPERATION OF PUMPS

Pumps may be operated manually or automatically. Self-priming pumps can be automated by use of pressure switch, electrodes or a float control switch or time switch. These control devices turn the motor on when the water level drops to the minimum water level in the tank and off when the level reaches the maximum or to desired level of pressure when using hydropneumatic pressure system.

3.04 RECIPROCATING PUMPS

1. General Operating Procedure

A reciprocating pump is a machine which is composed of a vertical or horizontal cylinder, plunger or piston, and valves. Shown in Figure 3.1 are details of an installed reciprocating pump and its appurtenances. Pumping action is accomplished by the forward and backward movement of a piston or plunger inside the cylinder.

- A. Forward or upward stroke of the piston or plunger moves the water from the cylinder to the discharge pipe. This motion decreases the pressure on the liquid behind the piston to below atmospheric. The pressure of the water from the well being atmospheric then lifts the foot valve, and water enters the cylinder.
- B. Reverse stroke transfers the water from the suction to the forward side of the plunger/piston inside the cylinder. Before starting the pumping operation, it is important that the pump must be properly lubricated.

2. Maintenance

The extent of the life and efficiency of pumps depend primarily on the manner it is operated and maintained, and the characteristics of the water being pumped. Outlined in Table 3.1 are troubles often encountered during operation, their causes and remedies.

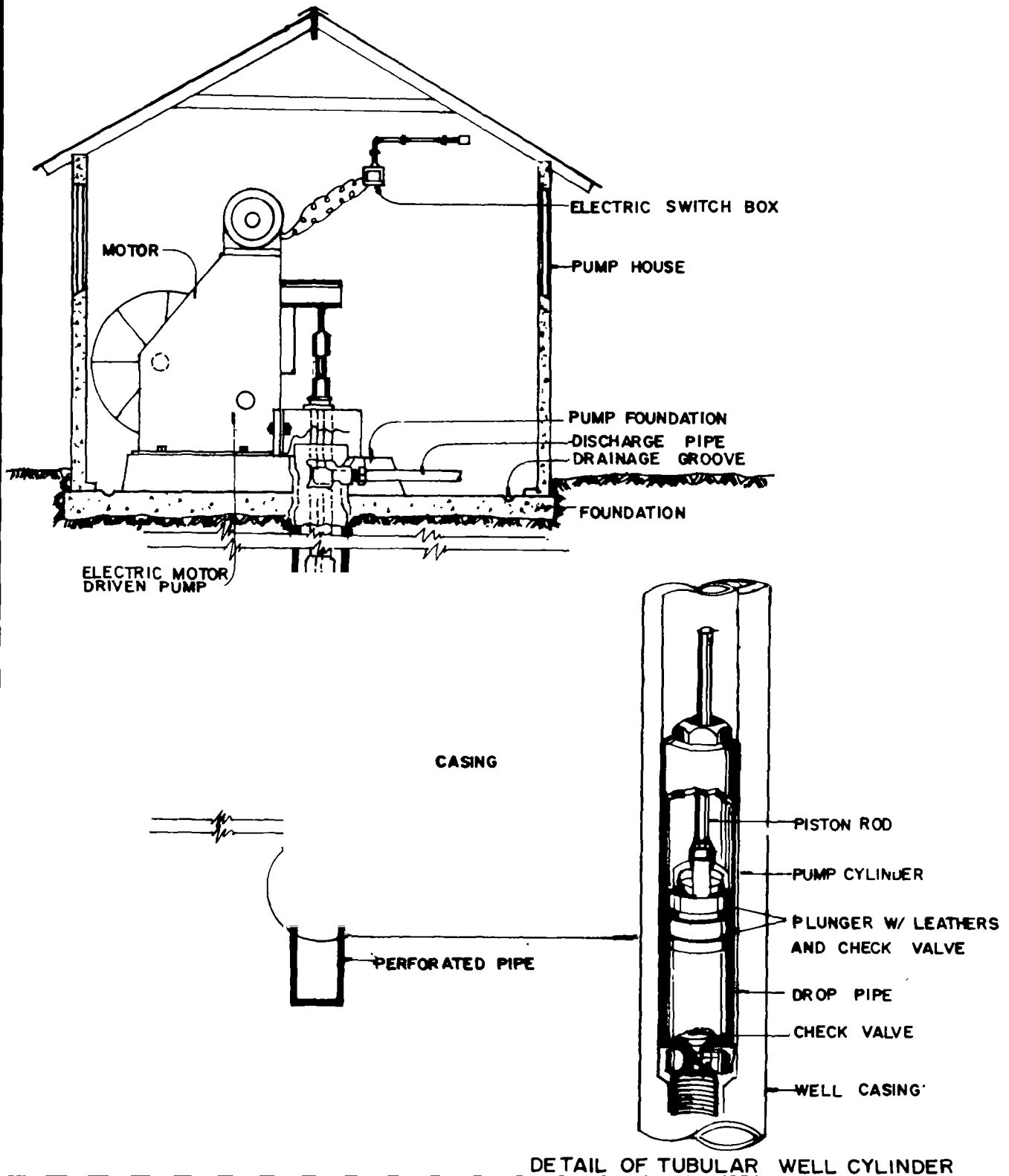

FIGURE 3.1

DETAIL OF RECIPROCATING PUMP AND APPURTENANCES

TABLE 3.1
COMMON TROUBLES IN OPERATING RECIPROCATING WELL PUMPS
AND THE REMEDIES

Trouble	Likely Cause of Trouble	Remedy
1. Pump motor fails to start.	Blown fuse or circuit breaker open.	Replace blown fuse or re-set circuit breaker.
	Motor or starting switch out of order.	Inspect and repair motor or starting switch. Call the equipment supplier or an experienced mechanic or electrician.
	Break in wiring.	Repair the circuit wires.
2. Pump runs but delivers no water.	No water at source due to overpumping.	Refer to Table 2.1.
	Collapse of well casing and screen.	Refer to Table 2.1.
	Complete clogging of well screen.	Refer to Table 2.1.
	Level of water has dropped below the suction of pump	Lower the pump drop pipe.
	Pump lost first priming.	Repeat the priming of pump. Follow manufacturer's instructions for priming.
	Pump repeatedly loses priming due to leaky drop pipe or suction line.	Pull the drop pipe out from the well and seal the leak.
	Pump cylinder has cracks.	Replace the cylinder.
	Plunger leather or gasket is worn out completely	Replace gasket or leather.
	Plunger rod of deep well pump is broken.	This trouble is indicated by pump running more free and without noise. Replace the broken rod.

<u>Trouble</u>	<u>Likely Cause of Trouble</u>	<u>Remedy</u>
3. Pump runs but delivers only a small amount of water.	Loose drive belt.	Tighten the belt
	Well not yielding enough water.	Refer to Chapter 2.
	Air leaks in suction line.	Pull the drop pipe out from the well and seal the leak.
	Incrustation or partial clogging of well screens.	Refer to Table 2.1
4. Leaky Stuffing Box (in horizontal types)	Packing worn out or loose.	Replace or tighten the packing. Leave the packing nut loose enough to allow a slow drip of water which will serve as a lubricant.
5. Pump is noisy	Bearings and/or other working parts of pump is loose.	Tighten and/or replace defective parts.
	Pump motor is loosely mounted.	Tighten mountings.
	Plunger rod may be slapping against the drop pipe.	Install guide for the rods or straighten the drop pipe, if crooked.

3.05 CENTRIFUGAL PUMPS

A centrifugal pump is a device which employs centrifugal force created by the revolving impeller to convey water from one point to another. Shown in Figure 3.2 are the details of an installed centrifugal pump and its appurtenances. Water enters the pump at the center of the impeller and is thrown into the channel between the rim of the impeller and its casing by centrifugal force. Water is then discharged at high velocity and pressure.

1. Manual Operation of Electric-Motor-Driven Centrifugal Pumps

- A. Bearing, gears and other pump moving parts should be properly and regularly lubricated by lubricants recommended by the equipment supplier.
- B. If pump is not self priming (or self priming pumps with defective suction line or foot valve), add priming water. Before starting the motor, make sure that the discharge gate valve is closed.
- C. Start the pump motor.
- D. Allow the pressure to build up; then slowly open the discharge gate valve. This is to avoid water hammer or sudden surge of water which might destroy the valves and pipes (especially the pipe joints). In case pump has been primed with water, waste the water pumped during the first 1-2 minutes by opening the drain valve.
- E. Once the pump has started running, make a routine check for faults in the operation of the system. This includes observing and noting down pump pressures and output, excessive or abnormal noise, vibration, heat and odor.

Should the operator observe any fault in the operation, he should immediately find the cause of the malfunction and then carry out appropriate and necessary actions.

2. Maintenance and Repair of Centrifugal Pumps

Presented in Table 3.2 are the common troubles encountered and their remedies when operating a centrifugal pump.

3.06 JET PUMPS

A jet pump consists of a centrifugal pump and appurtenant jetting equipment. Shown in Figure 3.3. are the details of an installed jet pump and its appurtenances. The centrifugal pump draws the water while the jetting equipment raises the water from the well to within the suction level of the centrifugal pump. Described briefly below are the mechanics of drawing water by jet pumps.

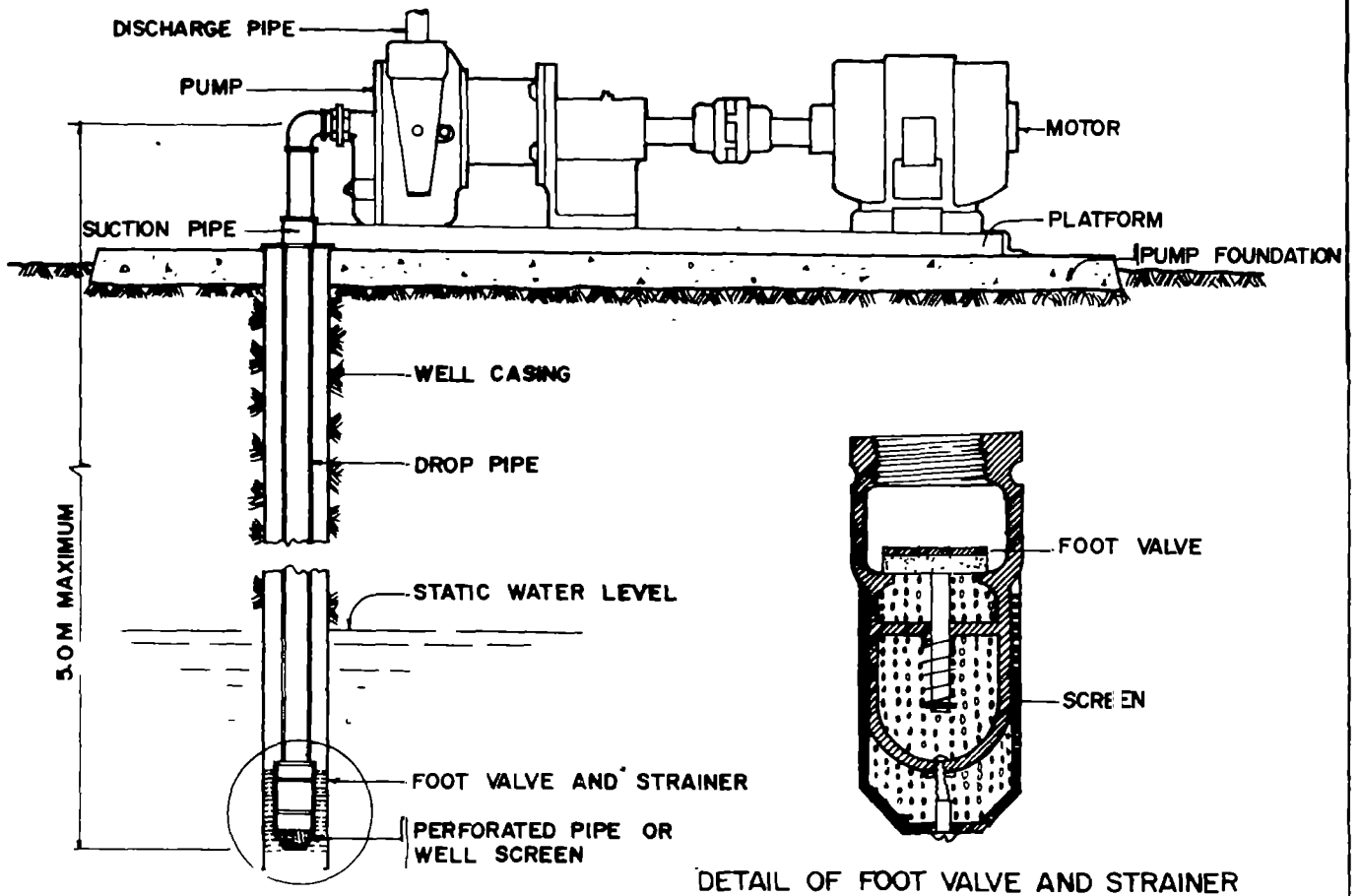

INSTALLED CENTRIFUGAL PUMP IN
A WELL

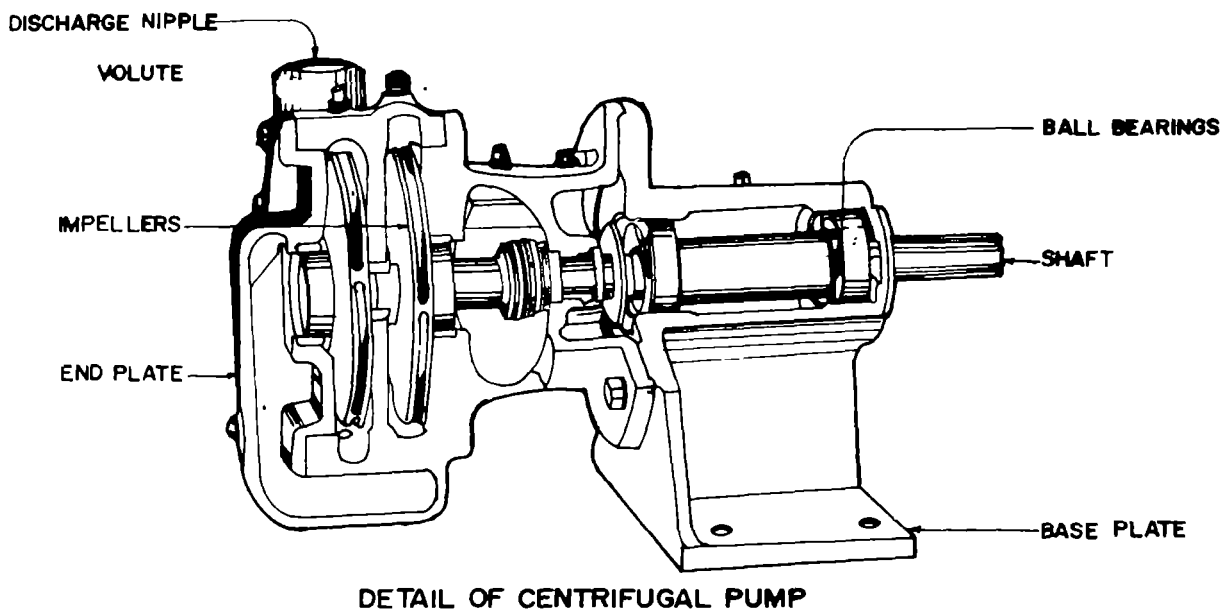

FIGURE 3.2

DETAIL OF INSTALLED CENTRIFUGAL PUMP AND APPURTENANCES

1. Water is drawn to the top by the centrifugal pump. The water drawing mechanism of the centrifugal pump is discussed in detail in Section 3.4.
2. Part of the water drawn is returned to the bottom of the well at high pressure by the jetting equipment. The high pressure water injected causes the rising of a larger volume of water at low pressure to within the suction level of the pump. The process is then repeated.

Considering the water drawing process outlined above, it can be noted that the useful delivery of a jet pump is the difference between the quantity of water pumped and the amount of water recirculated.

1. Operation of Jet Pump

Jet pumps can be operated manually or automatically by use of pressure switch, electrodes or float control switch.

A. Initial Start-up of Non-Self Priming

a. For Shallow Well Installations

- i. Initially inspect the assembly. Make sure that power supply to motor is off.
- ii. Check lubrication. Make sure that the pump rotates fully by manually turning the shaft. For details of this process, refer to the equipment operating manual which always goes with your purchased pump.
- iii. Remove pressure gage bushing and prime pump with clean water. Never start the motor until the pump has been filled with water.
- iv. Replace pressure gage bushing and close the discharge gate valve.
- v. Start the pump motor. Note the build up of pressure in the pressure gage. Open the discharge gate valve slowly.
- vi. If discharge pressure is lost and fails to build up again after a short time, the system still contains air. Stop the pump motor and repeat operating procedures starting from procedure iii. It may be necessary to repeat the procedure several times until the system is completely filled with water.

b. For Deep Well Installation

- i. Initially inspect the assembly. Make sure that power supply to motor is off.
- ii. Check lubrication. Make sure that the pump rotates fully by manually turning the shaft. Refer to equipment supplier operating manual for specific instructions.
- iii. Close pressure control valve and remove gage bushing.
- iv. Fill the system with clean water. If any part of the horizontal piping from the well to the pump is higher than the location of the pump, fill the pipes from the highest point.
- v. Replace gage bushing.
- vi. Start the pump motor. Note the build up of pressure in the pressure gage. Open the discharge gate valve slowly.
- vii. If discharge pressure is lost and fails to build up again after a short time, the system still contain air. Stop the pump motor and repeat operating procedure starting from the procedure iii. It may be necessary to repeat the procedure several times until the system is completely filled with water.

TABLE 3.2
COMMON TROUBLES IN OPERATING CENTRIFUGAL PUMPS
AND THE REMEDIES

Pump Trouble	Likely Cause of Trouble	Remedy
1. Pump motor fails to start.	Blown fuse or open circuit breaker.	Replace blown fuse or reset circuit breaker.
	Motor or starting switch out of order.	Inspect and repair motor or starting switch. Call equipment supplier or an experienced mechanic or electrician.
	Break in wiring.	Repair the circuit wires.
	Stuffing box may be binding or tightly packed (in horizontal types).	Check the packing by manually turning the shaft. Loosen the packing nut just enough to allow a slow seepage of water past the packing; and free the shaft. Water will serve as lubricant.
	Scale or sand in the impeller housing.	Open the pump and remove the scale by acid treatment to scraping. Refer to Table 2.1 for scale removal.
2. Pump runs but delivers no water.	Pump lost first priming.	Refer to Table 3.1
	Pump repeatedly losses priming due to leaky drop pipe or suction line.	Refer to Table 3.1
	No water at source due to overpumping.	Refer to Table 2.1.
	Collapse of well casing and screen.	Refer to Table 2.1.
	Complete clogging of well screen.	Refer to Table 2.1

Trouble	Likely Cause of Trouble	Remedy
3 Pump runs but delivers only a small amount of water.	Well not yielding enough water.	Refer to Chapter 2.
	Air leaks in suction line.	Refer to Table 3.1
	Incrustation or partial clogging of screen.	Refer to Table 3.1
	Impeller is worn out or plugged with scale or trash.	Open the pump and clean/replace impeller.
4 Leaky Stuffing Box (in horizontal types).	Foot valve may be obstructed.	Clean the foot valve.
	Packing is worn out or loose.	Refer to Table 3.1.
5 Pump is noisy.	Bearing and/or other working parts of pump are loose.	Tighten and/or replace defective parts.
	Pump motor is loosely mounted.	Tighten mountings.
	Presence of air in the suction line due to leaks and/or the water level in the well is very low.	Repair air leak and/or avoid pumping well too low.

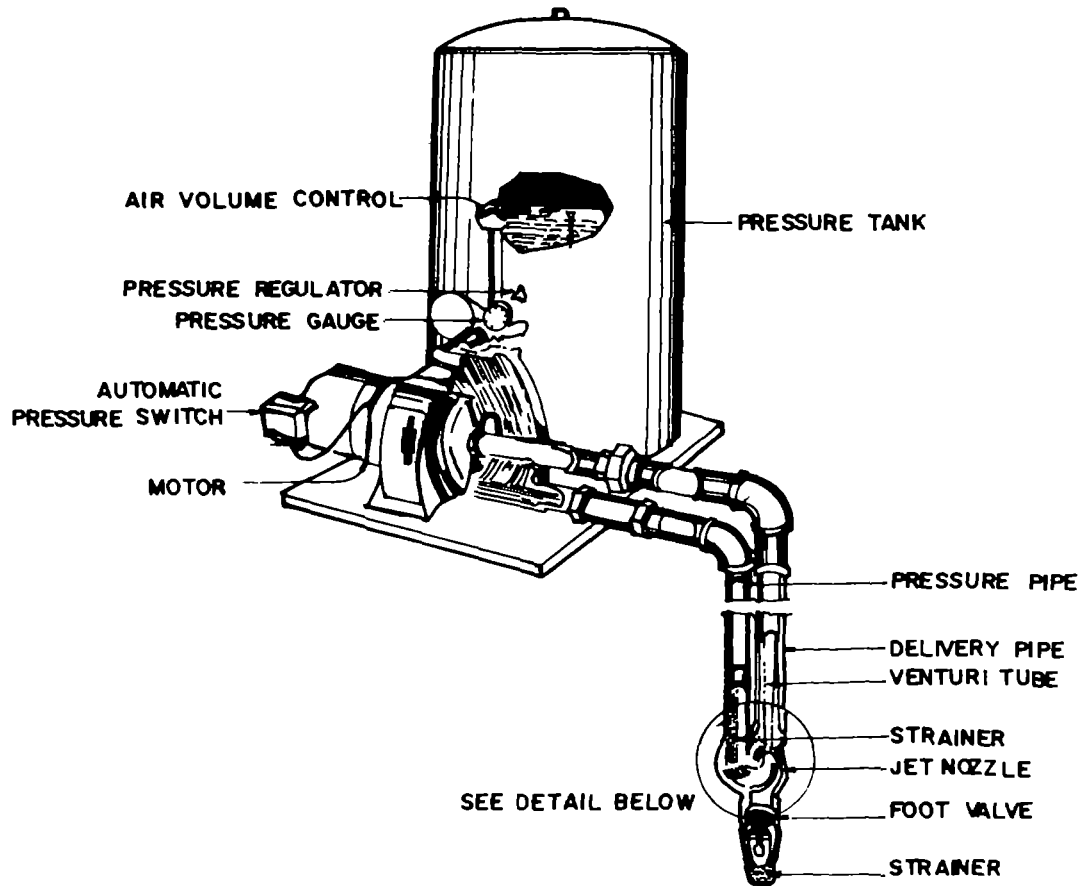

A PRESSURE SYSTEM WITH A DEEP WELL JET PUMP

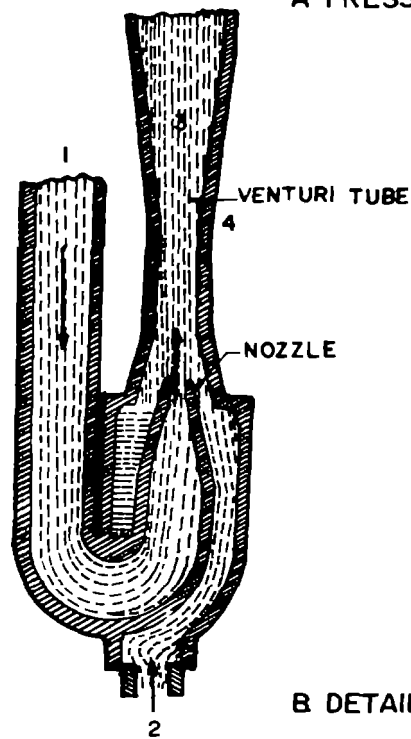

- 1 = WATER BEING RETURNED FROM PUMP ABOVE
- 2 = WATER FROM WELL BEING SUCKED UP INTO THROAT (4) BY HIGH VELOCITY DISCHARGE FROM NOZZLE
- 3 = RISING WATER

B DETAIL OF JET NOZZLE

FIGURE 3.3

DETAIL OF INSTALLED JET PUMP AND APPURTENANCES

**TABLE 3.3
COMMON TROUBLES IN OPERATING JET PUMP AND THE REMEDIES**

Pump Trouble	Likely Cause of Trouble	Remedy
1. Pump motor fails to start.	Similar to centrifugal pumps.	Refer to Table 3.2.
2. Pump runs but delivers no water.	No water at source due to overpumping.	Refer to Table 3.2.
	Collapse of well casing and screen.	Refer to Table 3.2.
	Complete clogging of well screen.	Refer to Table 3.2.
	Pump lost first priming.	Refer to Table 3.2.
	Pump repeatedly loses priming due to leaky drop pipe or suction line.	Refer to Table 3.2.
	Impeller housing may be filled with scales or sand.	Refer to Table 3.2.
3. Pump runs but delivers only a small amount of water.	The nozzle – diffuser or jet may be plugged with scale or trash.	Remove jet and clean.
	Well not yielding enough water.	Refer to Table 3.2.
	Air leaks in suction line.	Refer to Table 3.2.
	Incrustation or partial clogging of screen.	Refer to Table 3.2.
	Impeller is worn out or plugged with scale or trash.	Refer to Table 3.2.
	Foot valve may have obstruction.	Clean foot valve.

Pump Trouble	Likely Cause of Trouble	Remedy
4. Leaky stuffing box.	Nozzle – diffuser or jet may be partially plugged with scale or trash.	Remove and clean.
5. Pump is noisy.	Pressure regulator for jet may be set too low for existing water level.	Set regulator for higher pressure.
4. Leaky stuffing box.	Packing is worn out or loose.	Refer to Table 3.2.
5. Pump is noisy.	Bearings and/or other working parts of pump is loose.	Tighten and/or replace defective parts.
5. Pump is noisy.	Pump motor is loosely mounted.	Tighten mountings.
6. Pump fails to pump up to full pressure and shut off.	Presence of air in the suction line due to leaks and/or the water level in the well is very low.	Repair air leak and/or avoid pumping well too low.
6. Pump fails to pump up to full pressure and shut off.	Jet pressure regulator is too low.	Set regulator for higher pressure.
6. Pump fails to pump up to full pressure and shut off.	Jet nozzle is plugged with scale or trash.	Remove and clean jet.
6. Pump fails to pump up to full pressure and shut off.	Water level in well has dropped too low.	Reduce pumping rate, lower jet or find a new source.

B. Routine Starting of Self-Priming Pump

- a. Initially inspect the assembly. Make sure that power supply to motor is off.
- b. Check lubrication. Make sure that the pump rotates fully by manually turning the shaft. For details of this process, refer to the equipment operating manual which always goes with your purchased pump.
- c. Start the pump motor.

2. Maintenance and Repair of Jet Pump

The manufacturer or equipment supplier always provides the client with the operation and maintenance manual upon purchase of his product. Refer to this manual for the proper operation and maintenance of your pumping facilities. Also presented in Table 3.3. is a general outline of trouble shooting.

3.07 SUBMERSIBLE PUMPS

The pump and motor of a submersible pump are installed in the well below the water level. Shown in Figure 3.4 are the details of an installed submersible pump and its appurtenances. The pump usually employed is of the centrifugal or helical motor type. The motor on the other hand is hermitically sealed to protect it from corrosion and is lubricated for life. Submersible pumps are always self priming.

1. Operation of submersible Pumps

Submersible pumps may be operated manually or automatically. It can be manually started by turning a switch located above ground level or automatically by the use of a pressure switch, electrodes or float control devices.

2. Maintenance and Repair of Submersible Pumps

Familiarity with the most common problems which occur during operation of submersible pumps will enable the operator to immediately locate the trouble. The basic information required to begin a job analysis are as follows:

1. Pump/Motor Unit Size and type.
2. Pumping level and static water level in well.
3. Size of drop pipe.
4. Pump Setting.
5. Discharge pressure required (line or tank pressure).

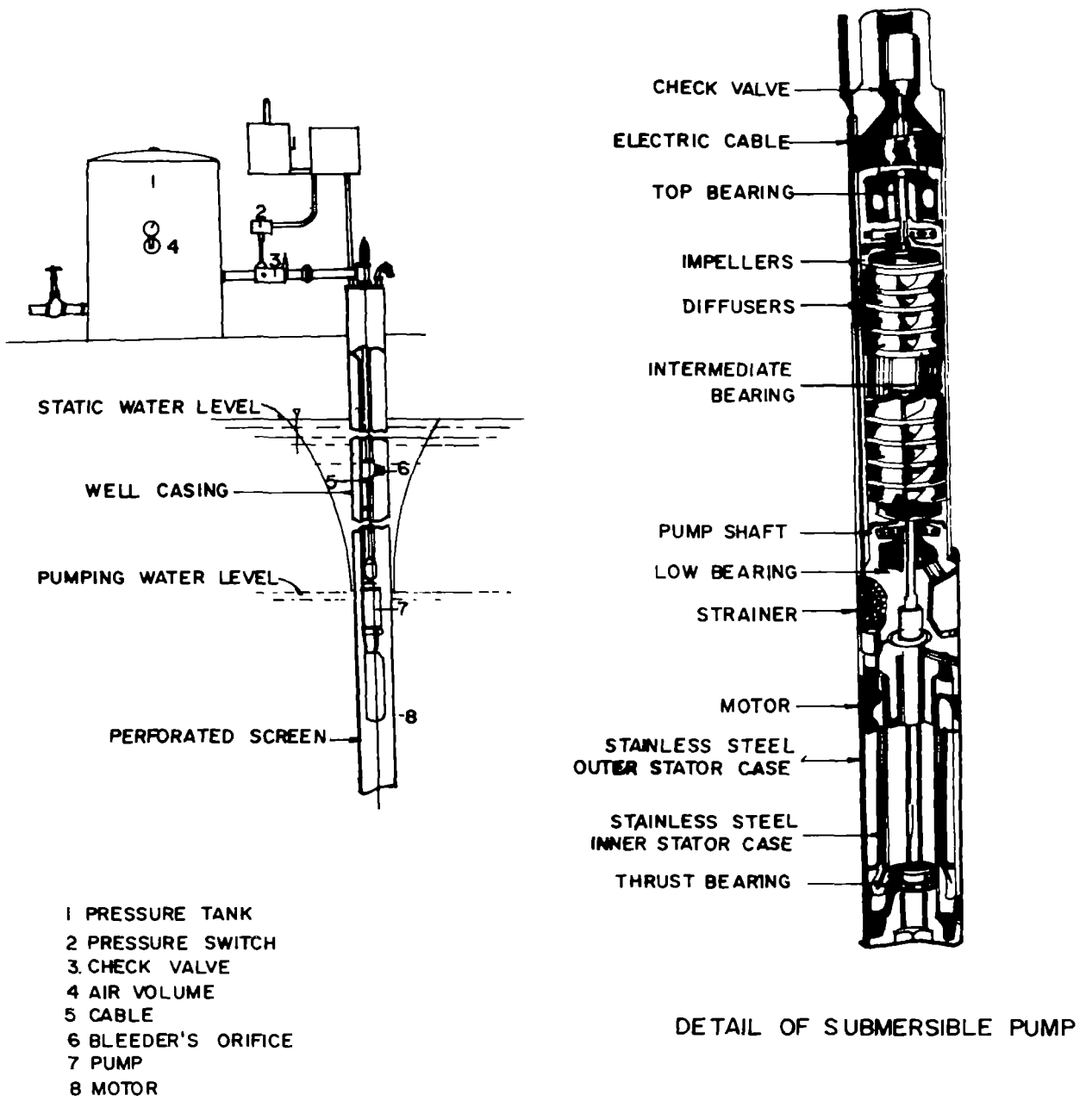

FIGURE 3 4

DETAIL OF INSTALLED SUBMERSIBLE PUMP & APPURTENANCES

6. Capacity pumped.
7. Line Voltage.
8. Operating Instructions

Listed in Table 3.4 are the common troubles and the remedies when operating a submersible pump.

3.08 MAINTENANCE OF PUMP HOUSE AND SURROUNDINGS

The operator should at all times maintain the cleanliness and orderliness of the pump house and its surroundings not only for the aesthetic reasons but also for sanitary reasons. Water users usually associate the quality of water to the condition of these utilities. If these are in poor condition, they may refrain from using the well water.

The pump house and its surroundings may be made pleasing to the eyes by periodically cleaning and sweeping up the rubbish and dust, making repairs, painting the pump house, and by planting ornamental and flowering plants around the house.

**TABLE 3.4
COMMON TROUBLES IN OPERATING SUBMERSIBLE PUMPS AND THE
REMEDIES**

Trouble	Cause of Trouble	Remedy
1. Pump motor fails to start.	Overload of motor causing the protection contacts to open.	Overload contacts will close automatically in a short time; check cause of overload.
	Low voltage.	Check voltage.
	Blown fuse, broken or loose electric connections.	Check fuses, relays, condensers and all electrical connections.
	Motor control box not in proper position.	Make sure box is in right position.
	Damaged cable insulation.	Locate and repair the damaged cable.
	Cable, splice or motor windings may be grounded or wet.	Check the ground by using ohmmeter. If grounded, pull out the unit and inspect cable and splice. Cut the unit loose from cable and check each part separately using an ohmmeter.
	Pump stuck by corrosion or abrasives.	Pull out pump, examine and remove the foreign matter.
2. Pump runs but delivers little or no water.	Pump not submerged.	Lower the unit into the well or reduce pumping rate by replacing smaller capacity pump.

Trouble	Cause of Trouble	Remedy
	Discharge pipe may be leaking.	Examine discharge line by pulling out one joint at a time.
	Check valve in pump if clogged or corroded.	Pull pump and clean. If badly worn, replace check valve.
	Pump badly worn by sand or abrasives.	Pull out pump and install new unit. Do not install new pump until well is thoroughly cleaned of abrasives.
	Strainers or impellers clogged with sand or scale.	Pull out pump unit and remove the scale and sand.
	Scaled or corroded discharge pipe.	Replace pipe or remove scale by acid treatment.
3. Pressure switch fails to shut	Pressure switch may be defective or out of adjustment.	Adjust or replace pressure switch.
	Discharge pipe may be leaking.	Raise unit one joint of a pipe at a time until leak is found. Repair leaks.

CHAPTER 4

OPERATION AND MAINTENANCE OF THE WATER DISTRIBUTION SYSTEM

4.01 GENERAL

The water distribution system is the "arm" of the water supply system. The quantity and quality of water delivered to the consumers depend primarily on the reliability of the system and on its operation and maintenance.

The operator should operate the water distribution system in a manner that enough positive pressure within the pipelines is maintained. This prevents infiltration of contaminated water from the surroundings into the pipelines thru faulty joints.

The maintenance of the water distribution system includes the periodic cleaning or flusing, inspection and repair of pipelines if defects are detected. Cleaning is necessary to remove solids which maybe composed of sediments, algae, scales, bacteria, organic materials, etc. Failure to do this routine job will result in deteriorating quality of water distributed. Leaks should be repaired as soon as detected to prevent loss of costly water to the surroundings and to prevent the entrance of contaminated water into the pipelines via these openings.

4.02 PIPELINES

1. Cleaning of Pipelines

Water conveyed through the pipelines may sometimes carry sand or sediments, organic materials and other objectionable materials. In cases where the velocity of water is low, these materials are deposited inside the pipes. When water contains magnesium and calcium salts (hard water), most of the time scaling of pipelines result due to the precipitation of the salts mentioned. The building up of deposits in the pipelines will result in the decrease of the carrying capacity of pipes, increase in friction loss, proliferation of bacteria, and production of undesirable odors , tastes and color if organic matter is present in the deposits. This problem can be remedied by periodic cleaning of pipelines.

Procedure for Cleaning of Pipelines:

- A. **Flushing with Water at High Velocity** – This method is suitable for removing solids which are not cemented to the inside surface of pipes.
 - a. Isolate the water mains to be cleaned from the whole distribution system.
 - b. Empty the water mains by opening the blow off valve or

other temporary outlet in the lower end of the pipeline. In some cases, compressed air is admitted at the highest point of the isolated system to expedite the emptying of water mains without the need for pumping.

- c. Inject water at high induced velocity (3.0 meters per second or higher).
- d. Disinfect the pipelines. Refer to Chapter 8 for the application procedure and the dosage for chlorine.
- e. Flush the pipeline with clean water until the chlorine odor is hardly detectable.
- f. Put the pipelines back to operation.

B. Use of Mechanical Scrapers – Mechanical scrapers are employed only when flushing of pipelines with water is incapable of removing the deposits. The cleaning procedure is as follows:

- a. Isolate the water mains to be cleaned from the whole distribution system by closing the appropriate control valves.
- b. Empty the pipelines.
- c. Insert the scraper into the empty pipe and allow water pressure to push it to the other end of the pipe. Alternatively, run rough sponge through the pipe. A cable may be attached to the scraper to permit its recovery or to indicate its location in case it gets stuck up.
- d. Flush the pipeline with clean water to remove the scrapings.
- e. Disinfect the pipelines.
- f. Flush the pipelines with clean water until the odor of chlorine vanishes.
- g. Put the pipelines back to operation.

C. Acid Treatment to Remove Scales

- a. Isolate the water mains to be cleaned from the whole distribution system by closing the appropriate control valves.
- b. Empty the pipelines.
- c. Apply dilute muriatic acid into the pipeline. If the pipelines are metallic, add an acid inhibitor like rice bran, flour glue, aniline, oil, etc. Recirculate the dilute acid solution until the scales are dissolved completely. The dilute acid solution is

prepared by mixing 1 part of commercial muriatic acid to 100 parts of water.

- d. Flush the pipelines with clean water.
- e. Disinfect the pipelines.
- f. Flush the pipelines again with clean water.
- g. Put the system back to operation.

2. Location of Water Mains

The exact location of pipes can be determined by referring to records or as-built plans of the water supply system. In cases where records are inadequate or lost, underground pipes may be pin-pointed by inquiring from old residents who witnessed the installation of the pipelines, by the use of pipe locators or by trial excavation.

A. Location of Pipes Using Pipe Locators

The position of water mains can easily be pin-pointed with the use of pipe locators. These devices automatically indicate the location of buried pipelines. This equipment is however very expensive and is not normally owned by small water supply systems. However, a locator can be borrowed from a government agency having one.

B. Location of Pipelines by Trial Excavation

- a. Select any point to serve as the primary reference point in establishing the position of pipelines. Should there be an exposed pipe section or gate valve/gate valve boxes, select this point as the primary reference point. However, in cases where there is no exposed pipe section, select any point at the north or east side of the road and excavate it. Here in the Philippines, water mains are usually installed at the north or east side of the road. Should the first point excavated does not yield the water main, select another point in the north or east side of the road within the section of the distribution system in question and then excavate. Continue the trial and error process until that location selected yields the water main.
- b. Using the water main just located as a reference point, select a second point 50 to 100 meters from the first point and excavate.
- c. If your second point yields the water main, draw an imaginary line connecting points 1 and 2. The connection of the two points is the exact position of the buried pipe.

- d. Repeat the above process making the identified points as reference points until all pipelines are pinpointed.

3. Location of Leaks

Leaks in water mains may be the origin of contamination and the cause of loss of good water to the surroundings. It is caused by the rupture or disintegration of pipe/pipe joint which may be due to corrosion, vibrations from vehicular traffic, stresses generated by expansion and contraction.

A. General Location

The presence of leaks in the water distribution system can be detected through direct observation of the operation of the system or the surroundings of water mains and/or by studying daily water consumption

- a. **Location of Leak by Direct Observation** – This method is the simplest and most applicable leak detection technique for use in small water supply systems. This consists of observing the following signs of leaks:

- i. Appearance of wet spots at early dawn during dry season.
- ii. Greening of patches of ground in areas where plants generally could hardly grow.
- iii. A soft wet spot in the ground during dry season.
- iv. Abnormal drops in pressure

The consumers can help detect leaks by informing the operator should they notice any of these signs. They should be made aware that the reporting of these leaks is a moral and social responsibility which benefits them directly.

- b. **Water Consumption Survey** – The operator should start investigating immediately after he observes that the water consumption is unusually high. This may indicate the presence of leaks in pipelines. The process of pinpointing leakages are as follows:

- i. Divide the entire distribution system into sections.
- ii. Isolate the different sections by closing the appropriate control valves. Observe the water consumption rate in each section and single out the section with abnormal high water consumption rate. The water rate can be measured using a pitometer.

- iii. Divide the pin-pointed section (s) which consume large quantity of water into subsections.
- iv. Isolate these different subsections and study their respective water consumption rates.
- v. Select the sub-section (s) with unusually high water consumption rates and sub-divide further. Isolate the different sub-sections, measure their water consumption rate.
- vi Repeat the above processes until the location of the leak(s) is pin-pointed.

B. Finding the Exact Location of Leaks in Pipelines

After pinpointing the general or approximate location of leaks in the water distribution system, their exact locations are then determined by use of a sounding rod. Leaks in water pipes usually make sound – small leaks cause more noise than large ones.

- a. **Location of Leaks Using a Sounding Rod** – a sounding rod is a sharp pointed metal rod used to relay to the observer the sound caused by leaks in buried pipes. The sounding rod method makes use of the principle that sound travels a hundred times faster through a metal than through porous ground. The leak detection procedure using this instrument is as follows:
 - i. Find the location of buried pipes suspected to have leaks.
 - ii. Push the sounding rod into the ground until its end touches the buried pipe. Be careful not to push it too hard in order not to destroy a PVC water main when its point strikes the pipe.
 - iii. Put your ear at the exposed end of the rod and listen for the sound. Where an unaided ear cannot detect the sound, use a hearing aid such as a stethoscope.
 - iv. Should the sound be very faint, pull the rod out and try the other points. If you hear a sound fainter than the first, it means that you are going away from the exact position of the leak.

4. Repair of Leaks

Leaks in water mains should be fixed as soon as they are detected. The repair job consists of sealing the leaks and/or replacement of the defective pipe section . The different methods of fixing leaks are as follows:

A. Sealing of Leaks

This method is generally used when the leak opening is small. The procedures for sealing leaks are as follows:

- a. Isolate the defective section by closing the appropriate control valves.
- b. Excavate the water main.
- c. Look for the leak opening. If the opening is difficult to find, open the control valve to allow water to flow into the pipe. The leak opening is indicated by water spouting or dripping from the pipe. Close the control valve again.
- d. Seal the leak opening by any of the following methods:
 - i. **Use of Epoxy** – The application procedure for sealing leaks using epoxy is discussed in detail in section 5.06. Briefly, the procedure is as follows:
 - Dry the surface to be treated with epoxy.
 - File the surface to make it rough and enlarge the crack. (Figure 4.1A).
 - Apply epoxy into the leak opening as shown in Figure 4.1B.
 - Allow 24 hours for the setting of epoxy.
 - ii. **Use of Split Sleeves** – Put a split sleeve around the leak opening as shown in Figure 4.1C. This is most applicable for bigger pipes.
 - iii. **Use of Flexible Rubber from “Interior” Rubber Tires**
This is most appropriate for emergency work, if no other repair materials are available.
 - Cut a rubber tire into strips.
 - Wind the rubber around the pipe tightly to cover the leak and its surrounding surfaces (Figure 4.1D)
- e. Open the control valve to allow water to flow into the repaired section. Observe carefully if the leak is completely sealed.

- f. After sealing, backfill and restore the surface excavated back to its former condition.

B. Replacement of the Damaged Section of Pipelines

This method is employed when the damage in a certain section of a water main is extensive. The procedure of repair is as follows:

a. For Galvanized Iron (G.I.) Pipes

- i. Isolate the defective section by closing appropriate control valves.
- ii. Excavate the water main.
- iii. Determine exact location of leaks.
- iv. Cut the defective portion of the water main.
- v. Replace the cut portion with a nipple or short pipe of the same kind, diameter and length of the defective pipe which was cut.
- vi. Thread the ends of pipe to be joined.
- vii. Assemble them as shown in Figure 4.2A.
- viii. Open the control valve to allow water to flow into the repaired section. Observe carefully if the repaired section is not leaking.
- ix. If there is no more leak, backfill and restore the surface excavated back to its former form.
- x. Disinfect the repaired section.

b. For Polyvinyl Chloride (PVC) Pipe

- i. Isolate the defective section by closing the appropriate control valves.
- ii. Excavate the water mains.
- iii. Pin-point the leaks
- iv. Measure and cut the defective portion of the pipeline. The length of the pipe cut should have an equivalent commercially available threaded nipple.
- v. Join the two cut portions of the water main with the

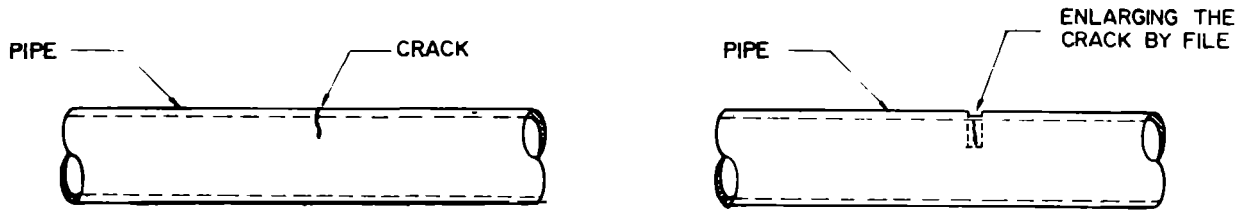

A ENLARGING OF CRACK

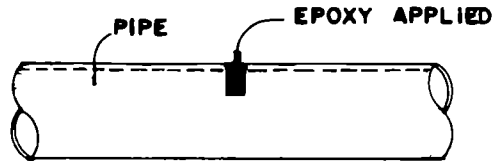

B. REPAIR OF LEAK USING EPOXY

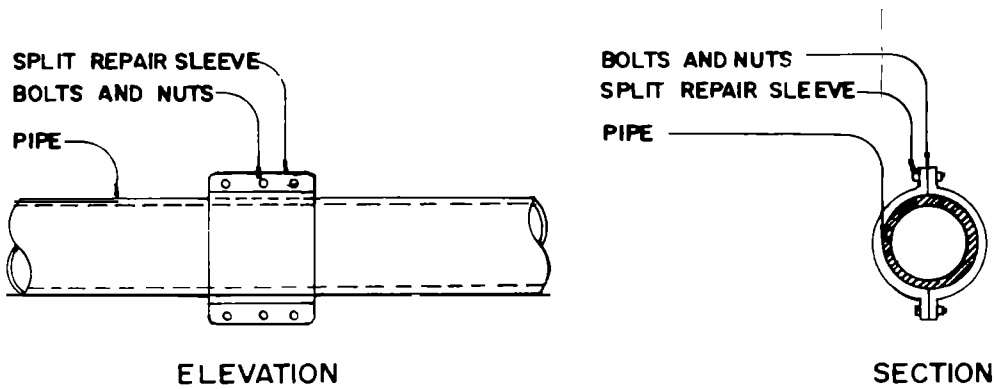

C. REPAIR OF LEAK USING SPLIT REPAIR SLEEVE

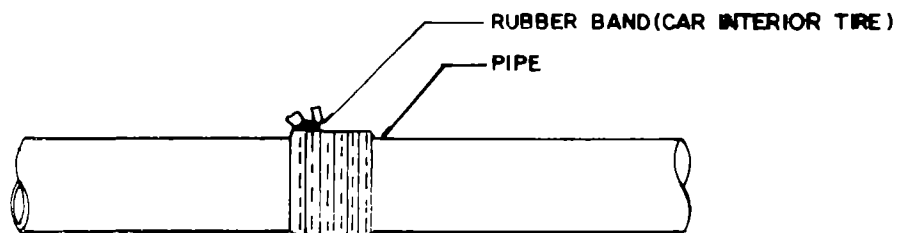

D REPAIR OF LEAK USING RUBBER BAND (CAR INTERIOR TIRE)

FIGURE 41

METHODS OF REPAIRING PIPE LEAKS

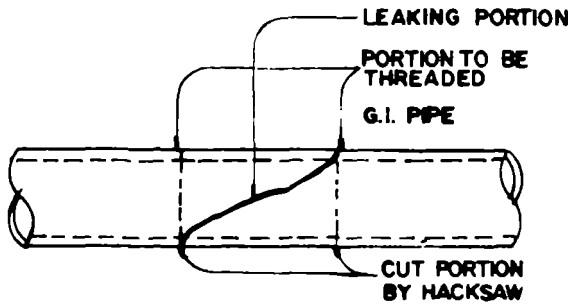

(1) CUTTING OF LEAKING PORTION

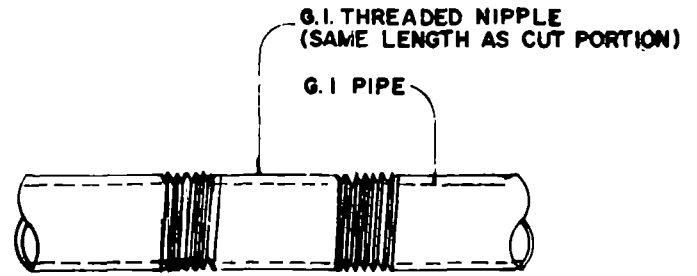

(2) REPLACEMENT OF THE CUT SECTION WITH G.I. NIPPLE

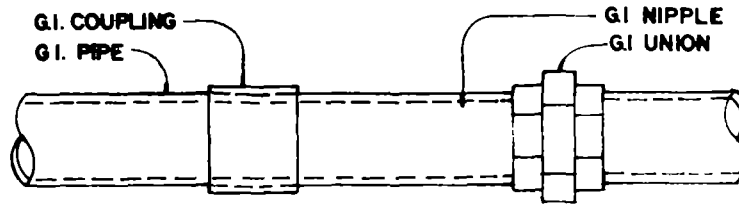

(3.) INSTALLING OF G.I. COUPLING AND UNION

A. REPLACEMENT OF DAMAGED G.I. PIPE SECTION

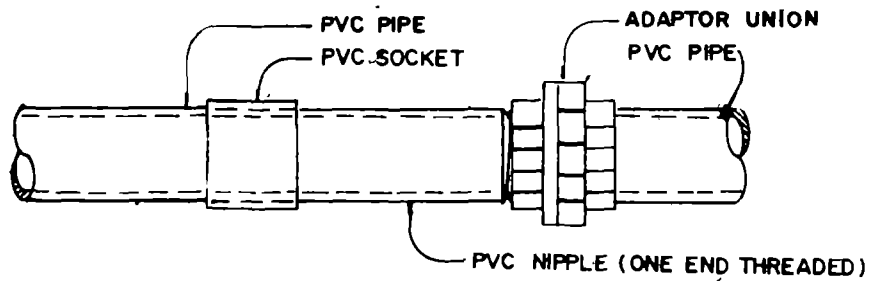

B. REPLACEMENT OF DAMAGED PVC SECTION USING PVC NIPPLE

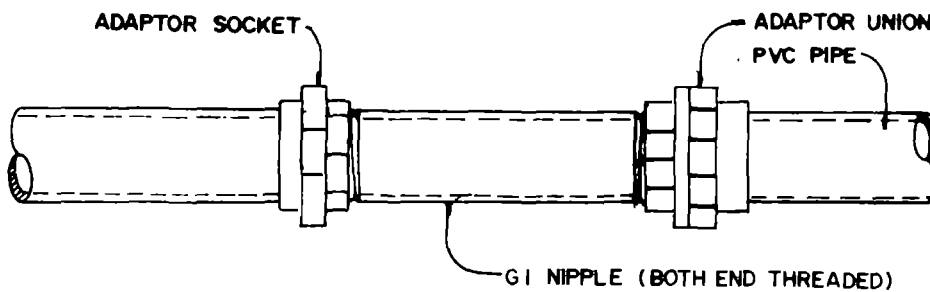

C. REPLACEMENT OF DAMAGED PVC SECTION USING G.I. NIPPLE

FIGURE 4 2

REPLACEMENT OF DAMAGED SECTION OF PIPELINES

nipple in between. The assembly is shown in Figure 4.2B. In cases where PVC threaded nipple is not available, G.I. threaded nipple could be used (Figure 4.2C).

- vi. Open the control valve to allow water to flow into the repaired section and observe if it is not leaking.
- vii. If there is no more leak, backfill and restore the surface excavated back to its former condition.
- viii. Disinfect the repaired section.

c. For Polybutylene (PB) and Polyethylene (PE) Pipes

- i. Isolate the defective section by closing appropriate control valves.
- ii. Excavate the water mains.
- iii. Cut the defective portion of the water mains. Take note that PE and PB pipes are laid in serpentine fashion as shown in Figure 4.3. Hence, the two separated ends might be brought together by pulling them close together. If not, a small section must be inserted.
- iv. Join the two separated ends.
 - For PB pipes, use the flaring method. The jointing procedure is discussed in the Construction and Installation Manual, Volume II. The repaired pipe is shown in Figure 4.3B.
 - For PE pipes, use the butt-welding method. The jointing procedure is also discussed in Volume II. The repaired pipe is shown in Figure 4.3C.
- v. Open the control valve to allow water to flow into the repaired section and observe if it is not leaking.
- vi. Backfill and restore the surface excavated back to its former condition.
- vii. Disinfect the section.

5. Disinfection of Pipelines

After the repair job, the repaired section of the water distribution system should be disinfected with chlorine or chlorine containing compounds. The application procedure is presented in Chapter 8.

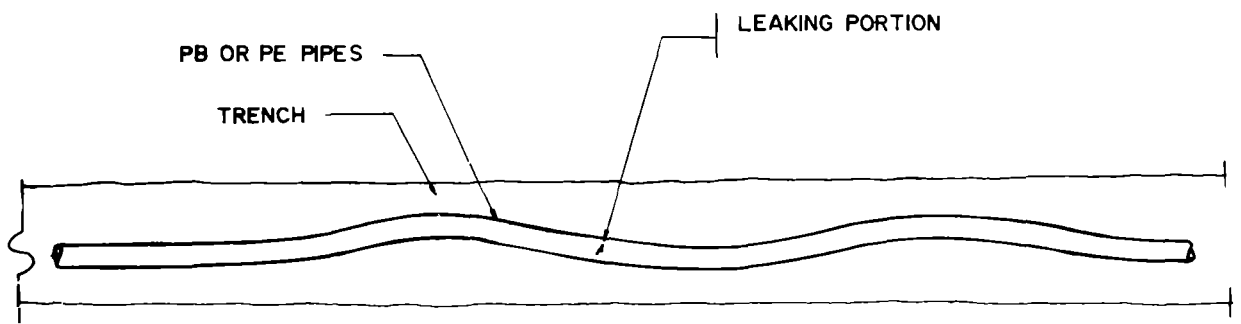

A. PB OR PE PIPES LAID IN SERPENTINE FASHION

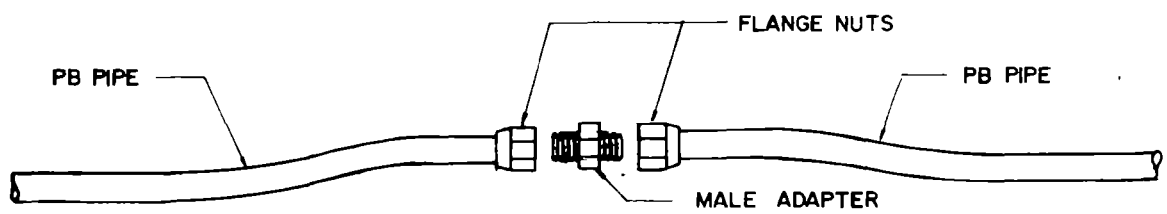

B. JOINTING OF PB PIPE

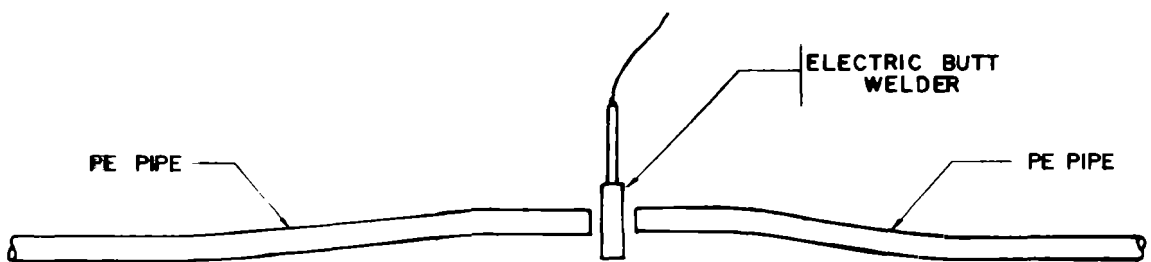

C JOINTING OF PE PIPE

FIGURE 4.3

JOINTING OF POLYBUTYLENE OR POLYETHYLENE PIPES

4.03 VALVES AND PUBLIC FAUCETS

A. General Consideration

Valves and public faucets are flow control devices in the water distribution system. Their useful life depends to a large extent on the manner they are operated and maintained.

Valves installed in small water supply systems may be manual or automatic. The valves commonly used are of the manual type. Globe, gate, angle and blow-off valves are manually operated, while check, air vacuum, foot and float valves regulate the flow of water automatically.

B. Common Causes of Failure and Remedy

1. Corrosion

Valves may become inoperable due to corrosion if they are not operated or lubricated for a long time. If the extent of the damage is not extensive, the valve may be made operable again by pouring kerosene or dilute lubricating oil down the valve key to lubricate the joint between the stem and packing. However, if after the lubrication procedure, the valve is still inoperable, replace the damaged valve with a new one or repair the damaged valve.

2. Closing the Valve Tightly

Closing the valve tightly may either destroy the threads of the valve stem or the valve washer or valve seat causing the water to leak. To avoid this problem, it is suggested to put markers showing the direction of opening and closing, and to close the valve just tight enough to stop the flow of water.

3. Worn out Washer or Loose Packing

Worn out washer or loose packing will cause the loss of good water to the surroundings. This problem can be remedied by replacement of worn out washer and/or packing with a new one.

4. Cavitation

Cavitation will result when the valve is left partially closed or open for a long period. Leaving it incompletely closed or open will cause a partial vacuum or void in the downstream side of the valve which will be eventually filled with low pressure vapors from water. When these vapor pockets collapse, a mechanical shock (cavitation) is created which may produce cavities which after some time will destroy the valve and/or pipelines. Cavitation can be avoided during the operation by keeping the valves fully closed or fully opened at all times.

5. Water hammer

Water hammer is caused by sudden closing of valves. When the flow of water is suddenly stopped, enormous pressure is created which may damage the pipe and/or valves. This problem can be prevented by closing the valve slowly.

C. Repair of Leaking Globe Valves, Public Faucets and Other Related Valves

1. Tools Needed

- a. Flat-jawed or monkey wrench (large enough to fit the packing nut of the valve/faucet).
- b. Rubber sheet or soft cloth (to be placed at the jaws of the wrench for protection of the finish of the faucet/packing nut).
- c. Screw driver.
- d. Faucet seat dresser.

2. Materials Needed

- a. New faucet washer or valve seat and disc.
- b. Lubricated candle wicking for stem packing.
- c. Waterproof grease.
- d. Washer screws.

3. Procedure

- a. Familiarize yourself with the different parts of the faucet or globe valve.
- b. Examine and find out the location of the leak. If water is coming out from the mouth or outlet, the trouble is due to a damaged washer or damaged seat or both. If water is coming out around the stem when valve is open, the stem packing is defective.
- c. Close the control valve to cut off water supply to the defective valve/faucet.
- d. Open the packing nut with a wrench. Place a piece of rubber sheet or cloth over the wrench jaws to avoid marring the valve/faucet finish.

e. **Repair the defective valve/faucet.**

1) Defective Stem Packing

1. If the packing is not badly damaged, the leak could be remedied by adding candle wicking into the old packing.
- ii. If the packing is badly damaged, remove and replace it with a new one

2) Defective Washer – If the washer is badly damaged, remove and replace it with a new one. The dismantling procedures are as follows:

- i. Remove the washer screw with a screw driver. If the screw is too tight or corroded, put kerosene or any lubricating oil.
- ii. Remove and replace the old washer with a new one. The new washer must have the same specifications or better than the old one. A snap-in washer can also be used.
- iii. Put back the washer screw. If the screw is corroded or badly damaged, replace it with a new one.
- iv. Examine the valve seat for defects. This is accomplished by visual check using a flash light or by feeling the seat surface with a finger. Should the check reveal that the surface is sharp or has some defect, correct it immediately using the seat dresser to prolong the life of the new washer.
- v. Repair or replace the valve seat. If the seat is non-renewable, recut it with a seat dresser. If the seat is renewable, replace it with a new one, or a snap-in seat could be used.

4.) Replace the handle and tighten the handle screw.

5.) Turn on the water supply and observe for leaks

CHAPTER 5

MAINTENANCE AND REPAIR OF RESERVOIRS

5.01 OPERATION

Water is pumped from the water source to the reservoir. From the reservoir, water is delivered to consumers by gravity or by pumping depending on the type of reservoir.

5.02 CLEANING

The quality of water coming from storage tanks must be maintained within standard. This is usually done by cleaning and disinfecting it periodically. Failure to do this routine job will result in the accumulation of solids and proliferation of bacteria in the tank making the water unsafe for drinking. Cleaning is usually done at least once a year and/or if it contains appreciable amount of dirt. Outlined below is the suggested cleaning procedure.

1. Check whether the reservoir contains appreciable amount of accumulated dirt. This is accomplished by first lowering the water level up to 15-20 cm. above the bottom of the tank. Stir up the sediments and if the bottom appears to be clean and if there are little or no sediments, there is no need of cleaning. Otherwise, follow the cleaning procedure presented below.
2. Brush the walls, columns, ladders, etc. to remove adhering dirt particles and algae, if any.
3. Open the drain valve to drain the remaining water to waste. While draining, agitate the water to keep the dirt particles from settling by sweeping the floor towards the outlet.
4. Disinfect the tank by any of the following methods.
 - a. Fill the tank with 50 ppm chlorine solution and allow the solution to stand for 24 hours before draining it to waste.
 - b. Alternately, prepare a thin paste by mixing bleaching powder and water in a pail or bucket. Apply the thin paste vigorously using a brush on the interior surfaces of the reservoir. Allow one hour to pass before rinsing tank with clean water.

5. Put the tank back to operation after rinsing the tank with clean water.

During the disinfection process, the working men must be equipped with breathing apparatus and full protective clothing. In case the bleaching powder solution accidentally gets in contact with the eyes, immediately wash eyes with clean water. After the disinfection job, all men involved in the work must take a bath.

5.03 DETECTION AND REPAIR OF LEAKS IN STEEL TANKS

Reservoirs made of steel are usually installed above ground making it possible for the observer to visually detect the leak, if any. Leaks in steel tanks can be repaired by:

1. If the leak is small, cover the leak with epoxy.
2. If the leak is big, cut a steel plate with size a little larger than the hole. Cover the hole with the steel plate and weld it in place.

5.04 DETECTION AND REPAIR OF LEAKS IN CONCRETE RESERVOIRS

Concrete reservoirs may be ground level or elevated. Leaks may be detected by any of the following methods:

1. If the concrete reservoir is elevated, leaks could be detected visually.
2. If the concrete reservoir is on ground level, leaks could be detected by any of the following method:
 - a. Close the discharge pipe control valve. Fill the tank with water up to a certain level and mark the water level. After one or two days, check the water level. Should there be an appreciable decrease in water level, your tank has leak. During the entire process, the outlet control valve should be tightly closed.
 - b. If the tank has an underdrain, observe the discharge in the underdrains. Should there be an appreciable discharge, your tank has leaks. Leaks in concrete reservoirs can be repaired by application of cement mortar or "Waterplug."

5.05 INSPECTION AND MAINTENANCE OF RESERVOIR APPURTENANCES

1. Manhole

Manholes should always be covered to keep out foreign materials which might contaminate the water supply.

2. Overflow Pipe and Air Vents

The overflow pipe and air vent screens should be inspected and if it is defective or rusted, they must be replaced immediately with new ones.

5.06 METHODS OF REPAIRING LEAKS IN RESERVOIRS

1. Repairing of Leaks Using Cement Mortar

- a. Drain the water content of the reservoir.
- b. Using a cold chisel, make a cut on the reservoir leak (Figure 5.1) with the following dimensions: Width 19-25mm and depth, 19-25 mm.
- c. Prepare a stiff cement mortar paste by mixing 1 part of portland cement, 2 parts of fine sand and sufficient water.
- d. Clean and wet the hole cut in the reservoir and apply the cement mortar paste. Allow the mortar to set for 24-28 hours.
- e. Disinfect the tank.
- f. Rinse the tank with clean water.
- g. Put the repaired tank back to operation.

2. Repairing of Leaks Using a "Waterplug"

"Waterplug" is a quick-set non-metallic base compound used in repairing leaks. It could be used to repair cracks either in reservoirs, empty or full of water. Waterplug when applied, sets in 3-5 minutes, depending upon the temperature of the surface into which it is applied. At temperature greater than 38°C waterplug sets immediately resulting in the decrease in structural strength while at temperatures below 5°C, it will not set. Waterplug is available commercially in powder form.

Procedure for Repairing Leaks Using a Waterplug.

- a. Make a cut on the reservoir (Figure 5.1) using a cold chisel with the following dimensions: Width 19-25 mm and depth, 19-25 mm.
- b. Wet and clean the hole from loose particles.

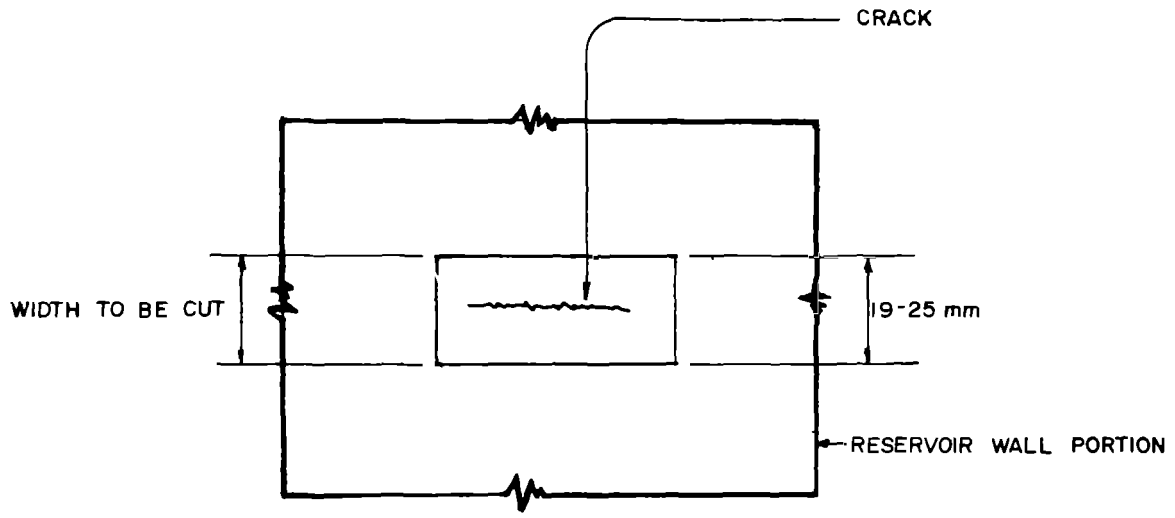

P L A N

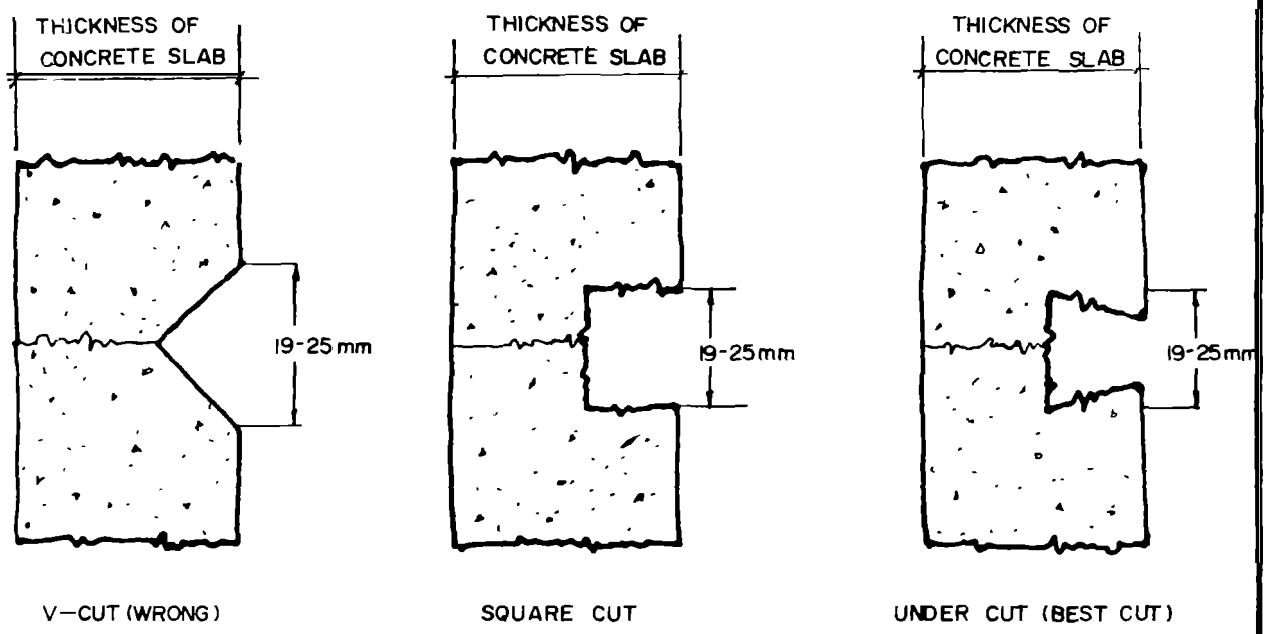

S E C T I O N

FIGURE 51

MAKING A CUT ON THE RESERVOIR
 (FOR PURPOSES OF PATCHING-UP CRACKS)

- c. Mix waterplug with sufficient clean water to make a sticky consistency. The waterplug mixture must be used within 3 minutes after preparation.
- d. Apply waterplug mixture into the crack. Start applying from any edge or corner.
- e. In cases where waterplug is used in sealing leaks in reservoirs full of water, hold the mixture in place using a trowel or hand for 3-5 minutes or until no water passes through the leak.
- f. Shave off the excess waterplug and make the surface even and smooth.
- g. Keep the repaired leak damp for 15 minutes.

3. Repairing of Leaks Using Epoxy

Epoxy is a sticky glue available commercially in plastic packs of 15 grams or more. It consists of two component A (Resin) and B (Hardener). Epoxy is generally used in repairing small leaks. Its application procedure is as follows:

- a. Drain the water content of the reservoir.
- b. Dry the surface to be applied with epoxy.
- c. Squeeze equal amounts of component A (Resin) and B (Hardener) and mix thoroughly.
- d. Apply the mixture immediately to the leak.
- e. Allow 2-4 hours for the setting of epoxy.
- f. Put the reservoir back to operation.

4. Repair of Leaks by Electric or Acetylene Welding for Steel Tanks

- a. Drain the water content of the reservoir.
- b. Dry the surface to be repaired.
- c. Weld the leak of the reservoir. If the leak is quite large, cut a metal plate with size slightly greater than the hole and then weld it in place.

- d. *Make the surface even, smooth and clean.*
- e. *Paint the repaired area.*
- f. *Disinfect the reservoir.*
- g. *Put the reservoir back to operation.*

5.07 PAINTING OF RESERVOIRS

Painting is necessary to prevent corrosion in steel tanks hence, prolonging the service life of reservoirs. Painting is carried out usually once every five years after the annual cleaning and inspection of reservoir. The detailed procedure for the application of paint is presented in Volume II, *Construction and Installation Manual*. A brief outline of the procedure is presented below:

- a. Dry, clean and smooth all surfaces to be painted. Remove all dirt, scale and rust by scraping or fine brushing and oil/grease by use of an appropriate solvent.
- b. Paint the surfaces of the reservoir. The paint to be used should not impart taste nor odor to water and should be free from substances which are deleterious to public health.
- c. Disinfect the reservoir.
- d. Put the reservoir back to operation.

CHAPTER 6

OPERATION AND MAINTENANCE OF SLOW SAND FILTER

6.01 GENERAL

Slow sand filtration is a system of water purification which has been proven to be effective under widely different circumstances since the beginning of the nineteenth century. It is simple, inexpensive, reliable and is still used for purifying water supplies in many cities and municipalities in both developed and developing countries.

Slow sand filtration combines within itself most of the purification functions that occur in nature such as settlement, straining, filtration, chemical change and to some extent, storage, resulting in an effluent with a high degree of quality. It is also efficient in the removal and/or inactivation of organisms because of "Biological Filtration."

6.02 ELEMENTS OF A SLOW SAND FILTER

The various elements that make up a slow sand filter are shown in Figure 6.1 and are described below. This will provide sufficient background for proper operation and maintenance.

- a. Filter Box — is a concrete, open-topped structure which houses the supernatant water reservoir, filter bed and the underdrainage system. It is usually rectangular in shape with a depth from 2.5 to 4.0 meters and built wholly or partly below ground.
- b. Supernatant Water Reservoir — is an upward extension of the walls of the filter box from the sand-bed surface, the principal function of which is to maintain a constant head of water above the filter medium. In practice, a head of between 1.0 M and 1.5 M is usually selected.
- c. Filter Bed — is a bed of sand, usually graded. It should be composed of hard and desirable grains preferably rounded and free from silt, clay, loam and organic matter. Ideally, the effective diameter of the sand lies in the range of 0.3 – 0.5 mm.
- d. Under-drainage System — consists of a false floor of porous concrete or perforated pipes, surrounded and covered with graded gravel to support the sand bed and prevent fine grains from being carried into the drainage pipes.
- e. Filter controls — A system of control valves used to regulate the flow of water through the bed. Figure 6.1 presents two methods of controlling water flow rate.

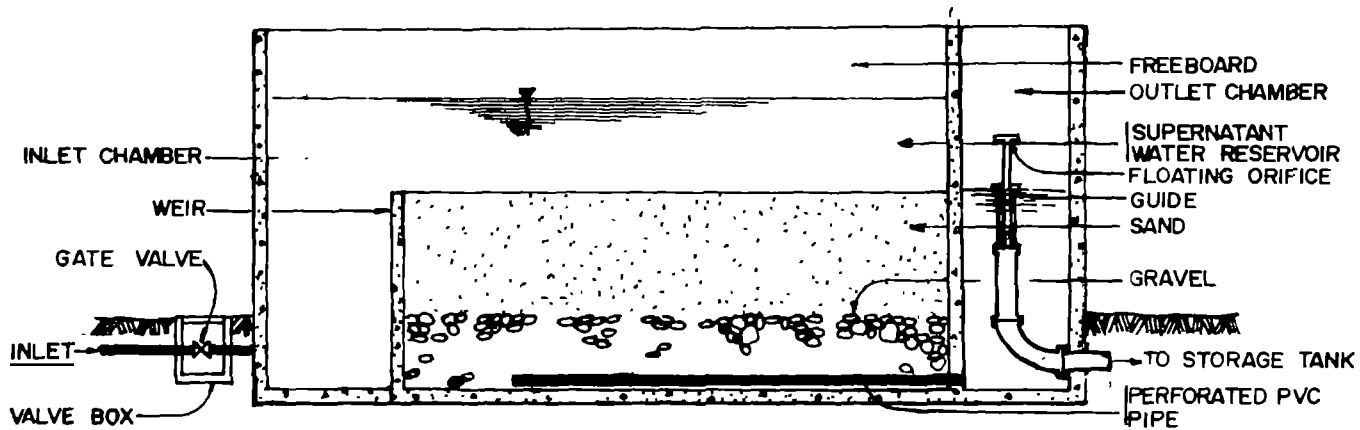

TYPE I SLOW SAND FILTER
 INLET CONTROL - GATE VALVE
 OUTLET CONTROL - FLOAT EQUIPPED WITH ORIFICES

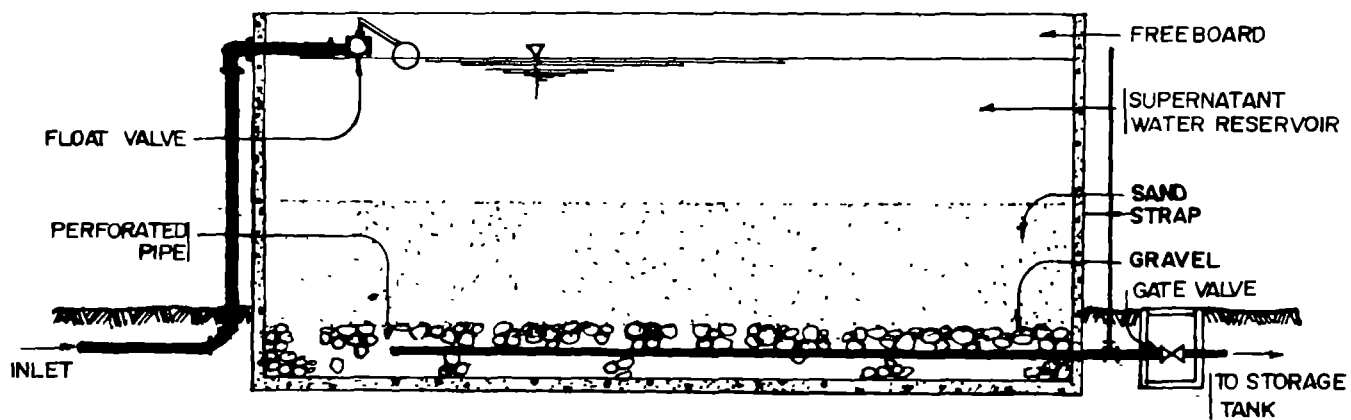

TYPE II SLOW SAND FILTER
 INLET CONTROL - FLOAT VALVE
 OUTLET CONTROL - GATE VALVE

FIGURE 61

ESSENTIAL PARTS OF SLOW SAND FILTER

6.03 START-UP OF A NEWLY CONSTRUCTED/CLEANED SLOW SAND FILTER

1. Introduce water at the bottom of the filter through the outlet chamber. The purpose of adding water from the bottom is to get rid of all entrained air in the sand pores and in the underdrainage system which may cause air binding. Filling should continue until water begins to show on the filter surface.
2. Level the top of the sand by raking.
3. Continue adding water through the outlet chamber until the water level is at least 10 cm above the sand bed. The purpose of raising water up to this level is to protect the sand surface from being scoured out of level when water is introduced from above.
4. Open inlet valve and start feeding water slowly from the top until the maximum water level in the supernatant water reservoir is reached.
5. The outlet valve is then opened and the effluent is run to waste until the filter gives clear water.
6. Start operating the filter.

6.04 RIPENING OF THE FILTER

When first constructed or just after cleaning, the slimy layer on the sand bed is not yet existing. Building up this slimy layer is a slow process called "ripening" and entails running the filter continuously and without interruption discharging filtered water to waste for at least one or two weeks.

As ripening proceeds, there will be a slight increase in the bed resistance as the organisms build up and the formation of the slimy layer will gradually become visible. These are signs that ripening is proceeding satisfactorily but only after comparative chemical and bacteriological analyses of raw and treated water may the waste valve be closed and the effluent be directed to the distribution system. In case water supply distribution is interrupted for a long period, filtration should be continued with the effluent discharging to waste. Any shutdown for an extended period must be followed by further ripening if the quality of the effluent is to be maintained.

6.05 GENERAL OPERATING PROCEDURE

A well designed and constructed slow sand filter requires minimum attention by the operator.

The operation of the filter is determined by the filtration rate, which is controlled at the effluent outlet by a regulating valve. Initially, this valve is partially closed. As the run continues, this valve must be checked and opened fractionally to compensate for the choking of the filter and to maintain a constant filtration rate. In case the valve is already fully opened and yet the design flow rate is still unattainable, the filter operation should be stopped and the filter be cleaned.

Inflow is likewise adjusted by means of a simple manually operated valve so that the level of water in the supernatant reservoir remains constant at all times. The valve will need periodic checking in order not to waste raw water through excessive delivery or to avoid diminishing output through a dropping water level over the filter bed.

6.06. FILTER CLEANING

Filter cleaning will be necessary when top one or two cm. of the filter bed becomes choked up. In cases where the effluent control is a gate valve, choking up of filter bed is indicated when the valve is fully opened and there is a continuous reduction of effluent flowrate or by the use of a pivot tube. If the effluent control used is the floating orifice, choking up will be apparent as the orifice drops significantly (near the level of the mount of the guide) due to the reduction of water level in the outlet chamber. Choking usually takes place after one or two months of continuous filter operation depending on the turbidity of raw water treated.

Cleaning of the filter bed is done as follows:

1. Close the raw water inlet valve and allow the water level in the supernatant water reservoir to drop to the filter bed surface.
2. Close the outlet valve and open the drain valve. Allow the water level to drop further to at least 10 cm below the filter bed surface.
3. As soon as the biological layer is dry enough to handle, immediately start scraping off the upper 25 to 50 mm layer of the filter bed with the use of flat square-bladed shovels. If cleaning is not carried out immediately, scavenging birds will pollute the filter surface and disturb the sand.
4. After removal of the scrapings, smooth the bed to a level surface. Also, try to inspect for the presence of mud balls cracks in the sand which may result to channelling causing the deterioration of efficient quality.
5. The newly-cleaned filter bed may now be put back into operation

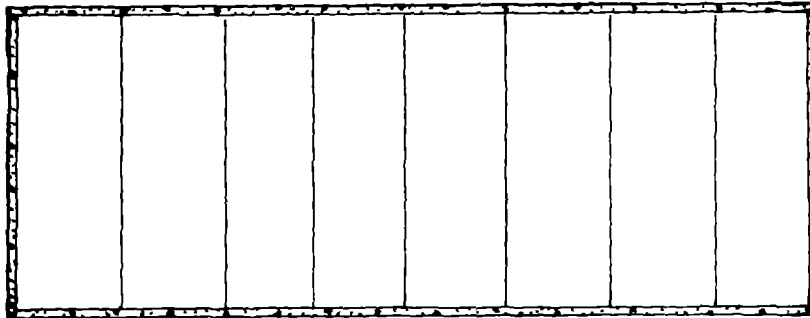

PLAN

A DIVISION OF FILTER BED INTO STRIPS

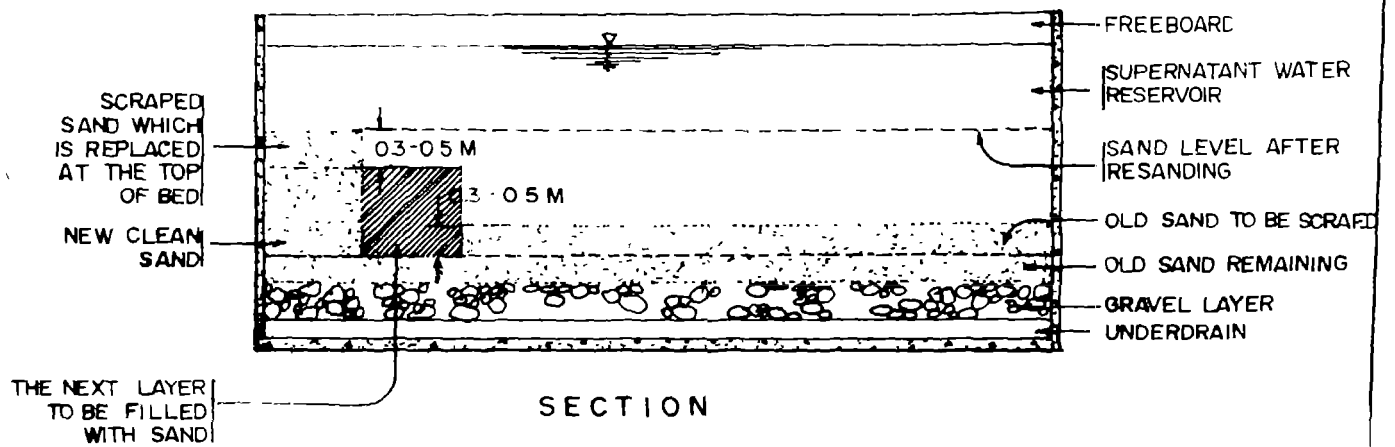

SECTION

B. RESANDING IN STRIPS

FIGURE 63

THROWING OVER RESANDING

- e. Fill the second strip with new sand and scrape 0.3 - 0.5 meter of the adjacent or third strip and place it on top of the second strip.
3. When the whole bed has been resanded, use the material scraped from the first strip to cover the new sand in the last strip.
4. Operate the filter in a manner described in Section 6.03.

6.08 WASHING OF FILTER SAND

In areas where sand is expensive or difficult to obtain, surface scrapings or used sand should be recycled. Scrapings should be washed immediately to remove organic matter in order to prevent its purification. Filter sand may be washed by:

1. Manual Washing

The procedure for manual washing of filter sand is as follows:

- a. Transfer the scrapings to a box shown in Figure 6.4A
- b. Fill the box with clean water.
- c. Stir the sand in the box with a spade or shovel vigorously enough to separate the sand particles from the impurities.
- d. Transfer the sand into the second box and add clear water. Stir the contents of the box to separate the organic matter from sand particles.
- e. Repeat the above procedure until the wastewater is fairly clear.
- f. Store the sand.

2. Mechanical Washing

Shown in Figure 6.4B is the ejector type, mechanical sand washing machine. The machine consists of a cylindrical drum with conical bottom and stirrers. The used sand is fed at the top and at the same time, clean water is injected under pressure at the bottom of the drum. The impurities are removed in the overflow while the clean sand is discharged at the bottom of the drum. The stirrers inside the drum aid in dislodging undesirable substances from the sand particles.

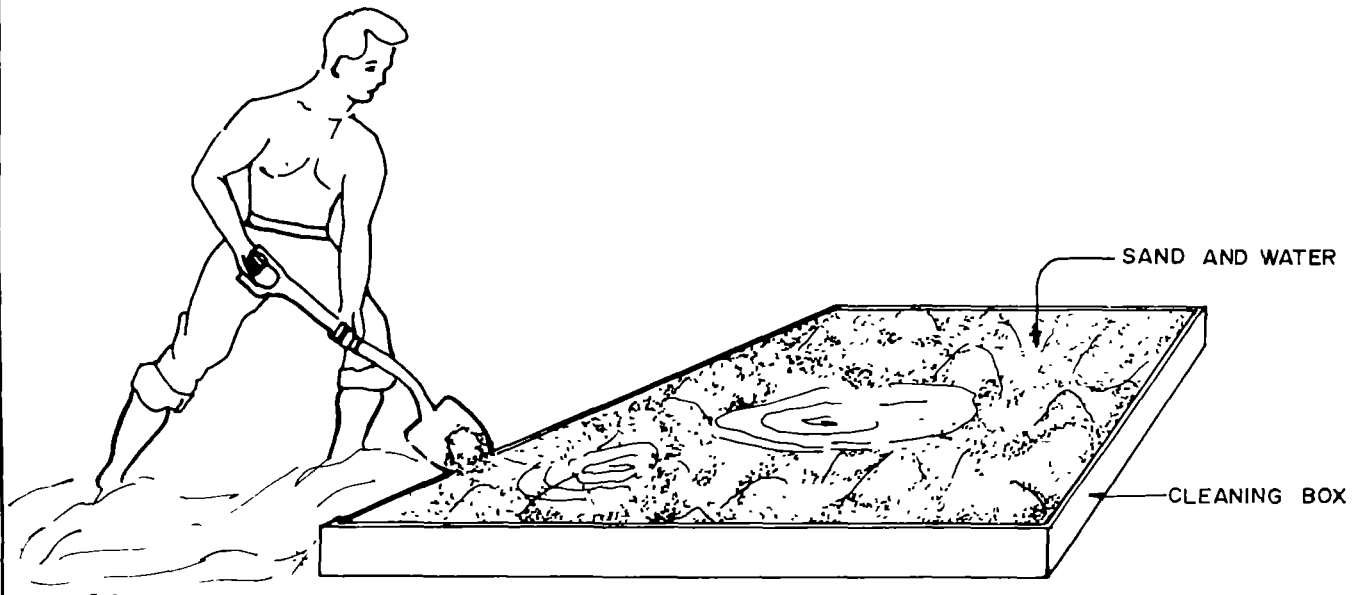

MANUAL CLEANING OF FILTER SAND

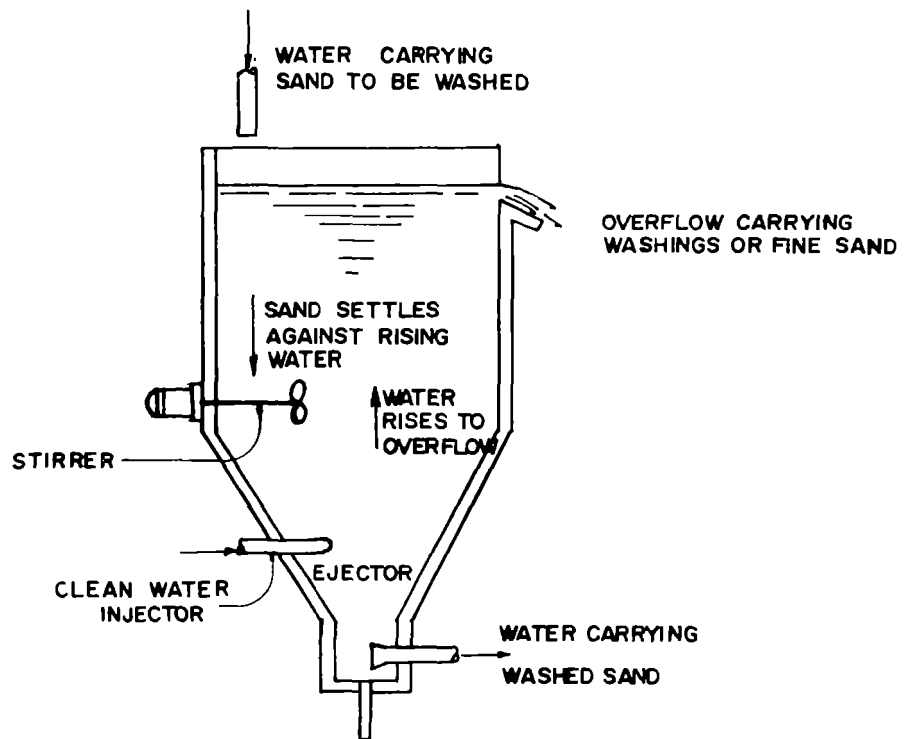

SAND WASHING MACHINE, EJECTOR TYPE

FIGURE 6.4

CLEANING OF FILTER SAND

CHAPTER 7

OPERATION AND MAINTENANCE OF CHLORINATORS

7.01 POT CHLORINATORS

Shown in Figure 7.1 are two alternative designs of pot chlorinators and their installation in wells. Pot chlorinators are usually employed when disinfecting water supplies with solid chlorine containing substances like bleaching powder. The pots are filled up (as shown in Figures 7.1a and 7.1b) with a mixture of a one (1) unit of bleaching powder and two (2) units of coarse clean sand. Replenishment of bleaching powder is usually done once every two or three weeks.

7.02 PLASTIC JERRYCAN CHLORINATORS

The plastic jerrycan chlorinator (as shown in Figure 7.2) consists of an inverted plastic container and a float which holds the orifice in place. The flow of solution in the chlorinator is controlled by the diameter of the orifice and the distance of the orifice below the surface of the liquid. The desired flow rate is obtained by trial and error. This is done by adjusting the diameter of the orifice followed by metering the flow rate until the desired flow rate is obtained. Metering may be done by noting the time required to fill a container of known volume.

1 Procedure of Disinfection

- A. Calculate the required chlorine dosage. The procedure for calculating the required dosages for the disinfection of water supplies and water system components is presented in the Design Manual, Volume 1.
- B. Prepare the chlorine solution in a pail or bucket and allow it to stand idle for one hour for the sediments to settle.
- C. Transfer the chlorine solution into the chlorinator. Make sure that during the transfer, the sediments are excluded
- D. Put the float which houses the orifice in place. The chlorinator is now ready for use.

2. Maintenance

To remove the settled solids and other undesirable substances inside the chlorinator, add water and shake the contents vigorously, remove the cover and drain the contents of the tank. After cleaning, fill the tank with chlorine solution previously prepared in a bucket or pail.

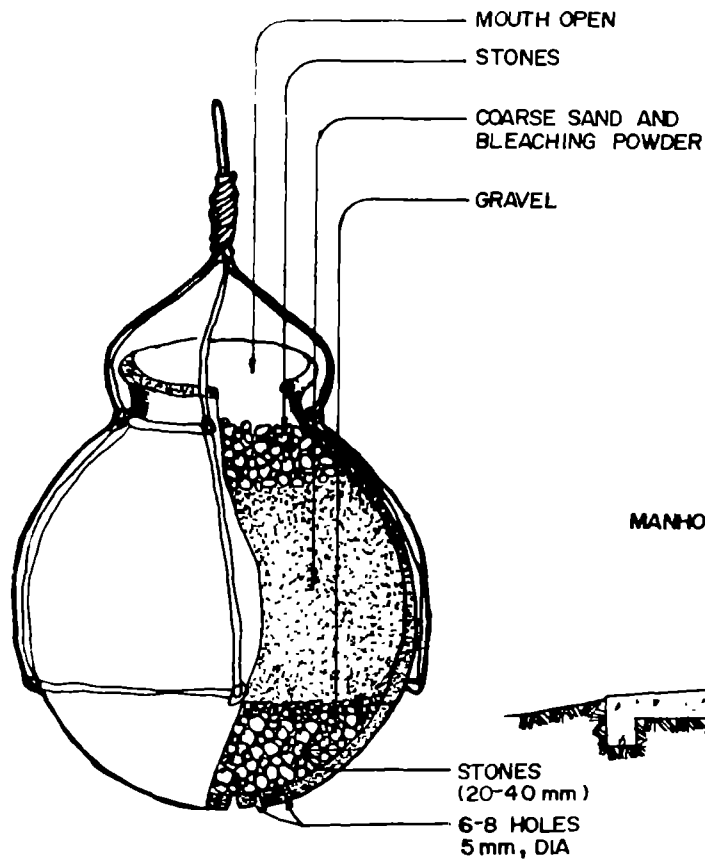

A SINGLE POT SYSTEM

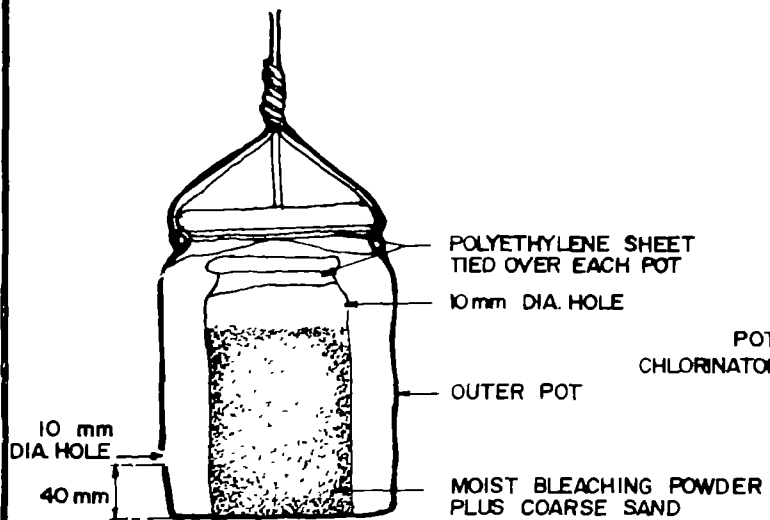

B DOUBLE POT SYSTEM

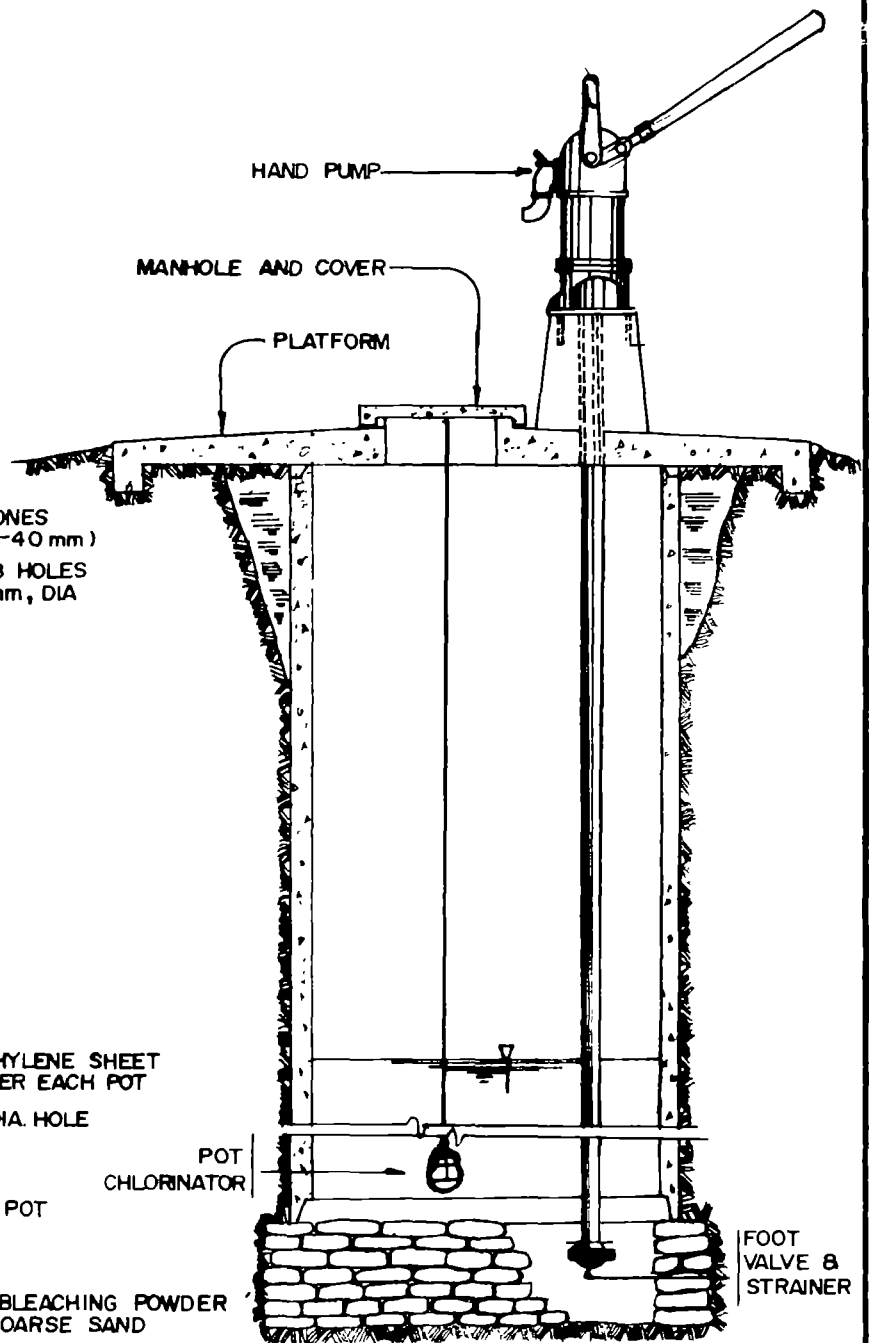

INSTALLATION OF POT CHLORINATOR IN THE WELL

FIGURE 7.1

POT CHLORINATORS

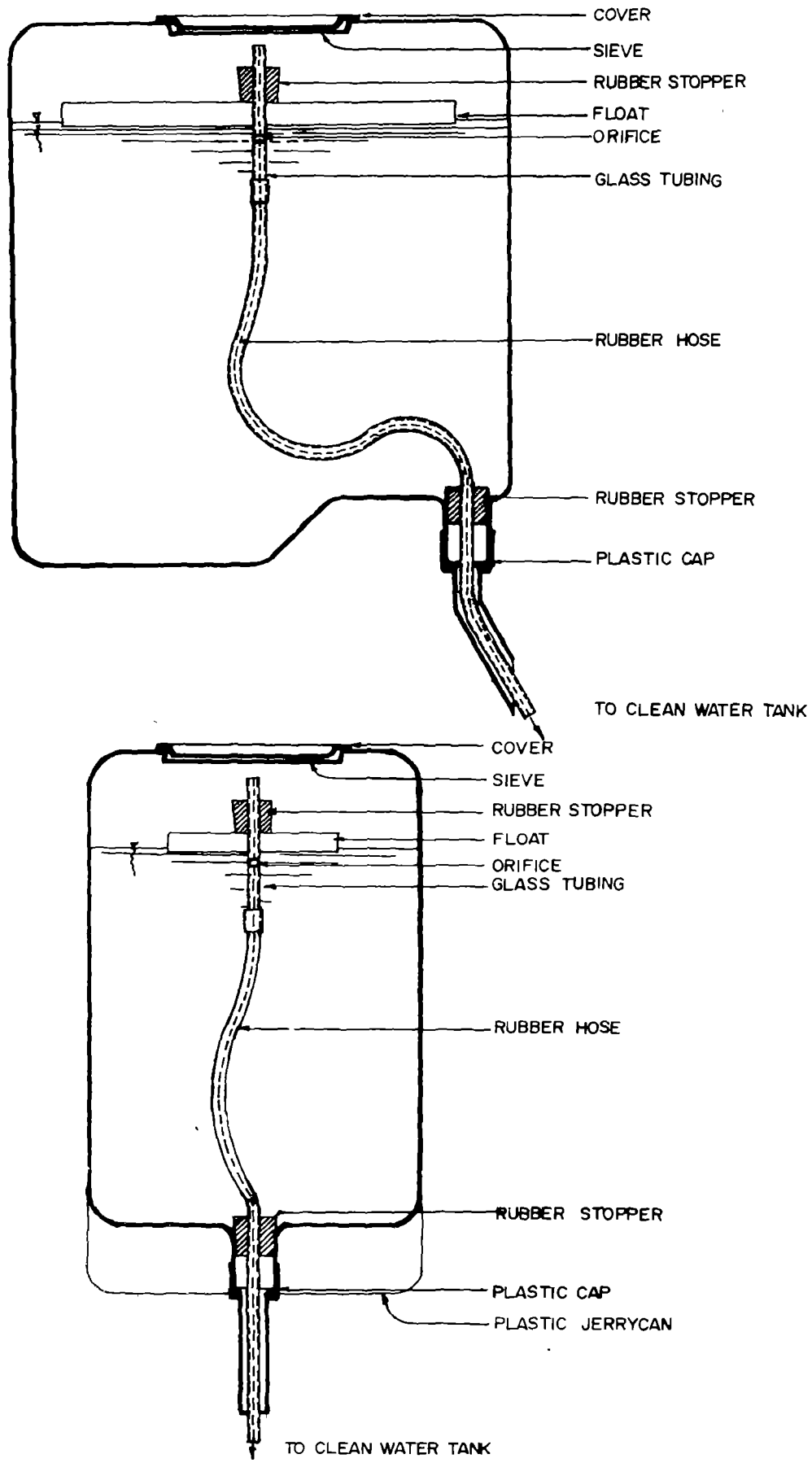

FIGURE 7.2

PLASTIC JERRYCAN CHLORINATOR

7.03 BOTTLE SOLUTION FEEDER

1. Siphon – Type Bottle Solution Feeder

The Siphon Type Bottle Solution Feeder (Figure 7.3) consists of a transparent bottle, inlet and outlet tubings and flow control devices. A transparent bottle is essential for estimating the amount of chlorine solution in the bottle by visual observation.

The procedure of disinfection using this equipment is as follows:

- A. Follow procedures 1, 2 and 3 for using jerrycan chlorinators.
- B. Replace the air tight stopper into the mouth of the bottle.
- C. You are now ready to start chlorination.
- D. Start the flow of chlorine solution by blowing into tube A. The difference in level between the bottom ends of tubes A and D supplies the net head, H for siphon flow through tube D. The rate of flow is controlled by:
 - a. Keeping the stop cock or valve B wide open and adjusting the rates of flow by moving tube D up or down. The rate of flow is determined by measuring the time required to fill a container of known volume. Thus, the flow rate can be a subsequently adjusted as required.
 - b. Fixing the outlet tube D and controlling the inflow of air through valve B.

2. Liquid Seal-Type Feeder

The Liquid Seal-Type Bottle Chlorinator (Figure 7.4) consists of a bottle filled with chlorine solution turned upside down to rest on a glass or wooden container; inlet and outlet tubings, and flow control devices.

The solution in the upper bottle flows into the lower container, raising the liquid level up to the mouth of the upper bottle, thereby sealing it. The solution is then withdrawn through an outlet tubing from the bottom container. It should be observed that as long as there is a solution in the upper bottle, the liquid level will remain fairly constant.

SURVEY/INVENTORY OF WATER IMPOUNDING RESERVOIR

PROGRESS CHART FOR October 31, 1977

ACTIVITY	TOTAL ACTIVITY UNITS FOR PROJECT	% OF TOTAL PROJECT	ACTIVITY UNITS COMPLETED DURING THE MONTH	% OF TOTAL PROJECT COMPLETED TO DATE	1977					
					A	S	O	N	D	
					1	2	3	4	5	
1. PROJECT IDENTIFICATION	25	25	6	17		6	2	6	2	
2. AERIAL INSPECTION	20	20	--	2		6	6	4	2	
3. POTENTIAL FUNCTION EVALUATION	35	35	4	29	4	6	6	4	2	
4. CONSOLIDATION AND REPORT PREPARATION	20	20	4	16	4	4	4	2	2	
TOTAL SCHEDULED	100	100	14 (24)	64 (76)						

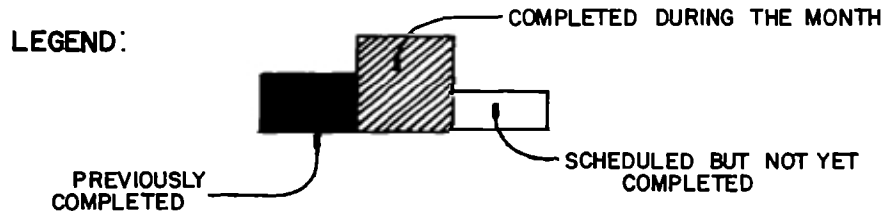

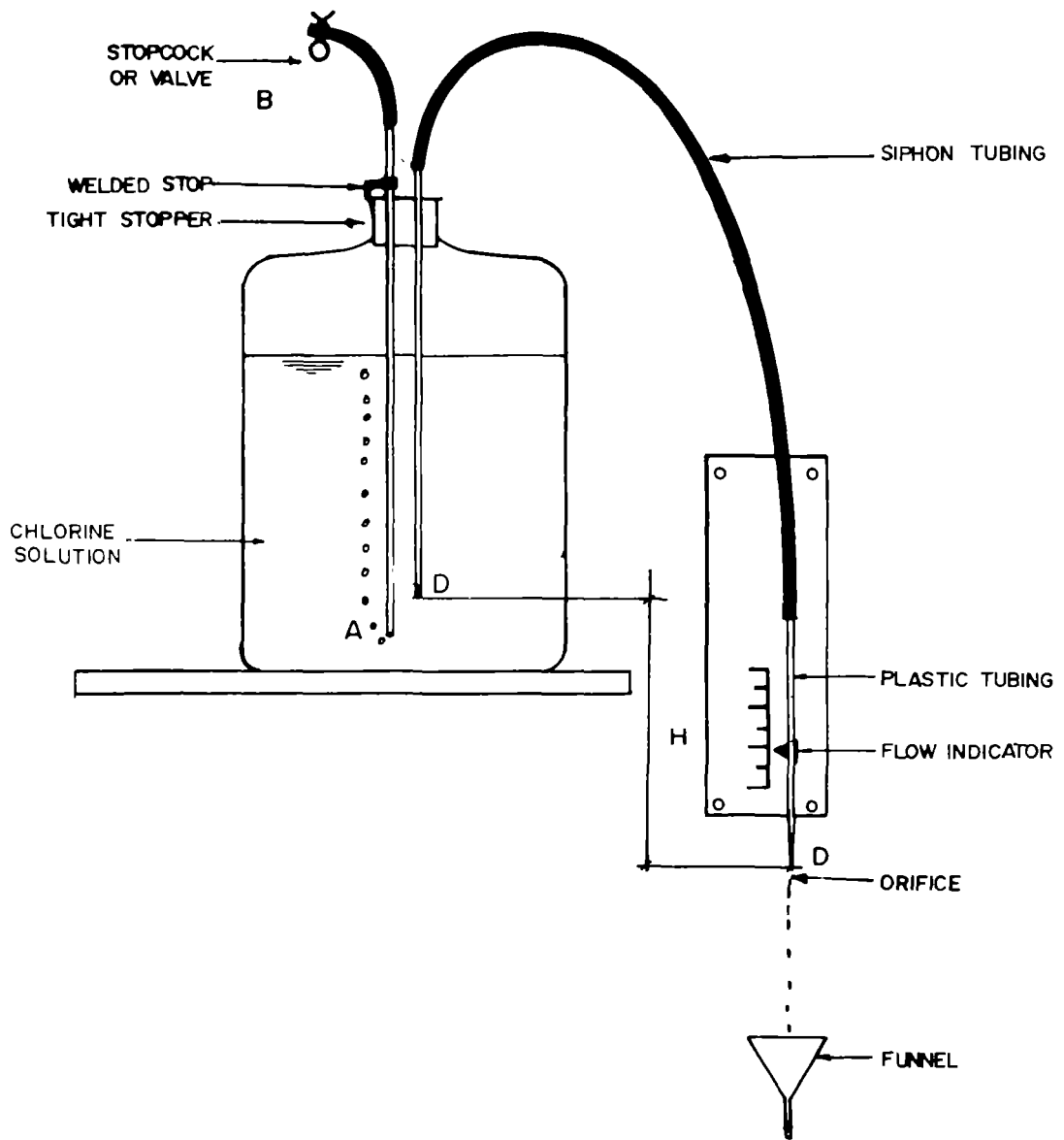

FIGURE 73

BOTTLE SOLUTION FEEDER
(SIPHON TYPE)

From the outlet pipe, the solution drips into the funnel and into the pipe conducting water or into the container to be disinfected. It should be noted that this method will not work if the pressure in the pipelines is greater than the pressure in which the solution is injected.

7.04 V-NOTCH CONSTANT HEAD SOLUTION FEEDER

The V-Notch Constant Head Solution Feeder (Figure 7.5) consists of a solution container, rectangular or circular in shape; a plastic liquid depth sight gauge for checking the liquid level inside the tank; and a float which houses the V-notch feeder.

The procedure for disinfection and the principle of control of solution flow rate are similar to those discussed for Jerry can chlorinators. The flow rate is controlled by adjusting the depth of submergence of the float and opening of the V-Notch. The opening of the V-Notch depends on how far the V-Notch rod is inserted into the drilled hole. In case the problem of clogging of the V-Notch with solids is encountered during the operation, the clogging materials are removed by withdrawing the rod and cleaning it. The flow of chlorine solution is stopped by lifting the float.

1. Maintenance

To clean the tank, remove the float and open the drain valve to allow the liquid to drain. Add water at the same time cleaning the container with a brush and stirring the bottom of the tank to suspend the particles. Water and suspended particles are removed through the drain. After cleaning, close the drain valve and fill the tank with chlorine solution. Re-install the float.

7.05 FLOATING BOWL CHLORINATOR

The Floating Bowl Chlorinator (Figure 7.6) is a modification of the V-Notch Constant Head Solution Feeder. It also consists of a solution container, a plastic liquid depth sight gauge, and a bowl which houses the solution feeder. The procedure for disinfection and the principle of control of flow rate is similar to those of the V-Notch Constant Head Solution Feeder. The flow rate is adjusted by increasing or decreasing the height H , of the inlet tube of the floating bowl and the depth of submergence of the bowl which is regulated by increasing or reducing the amount of dead weight in it

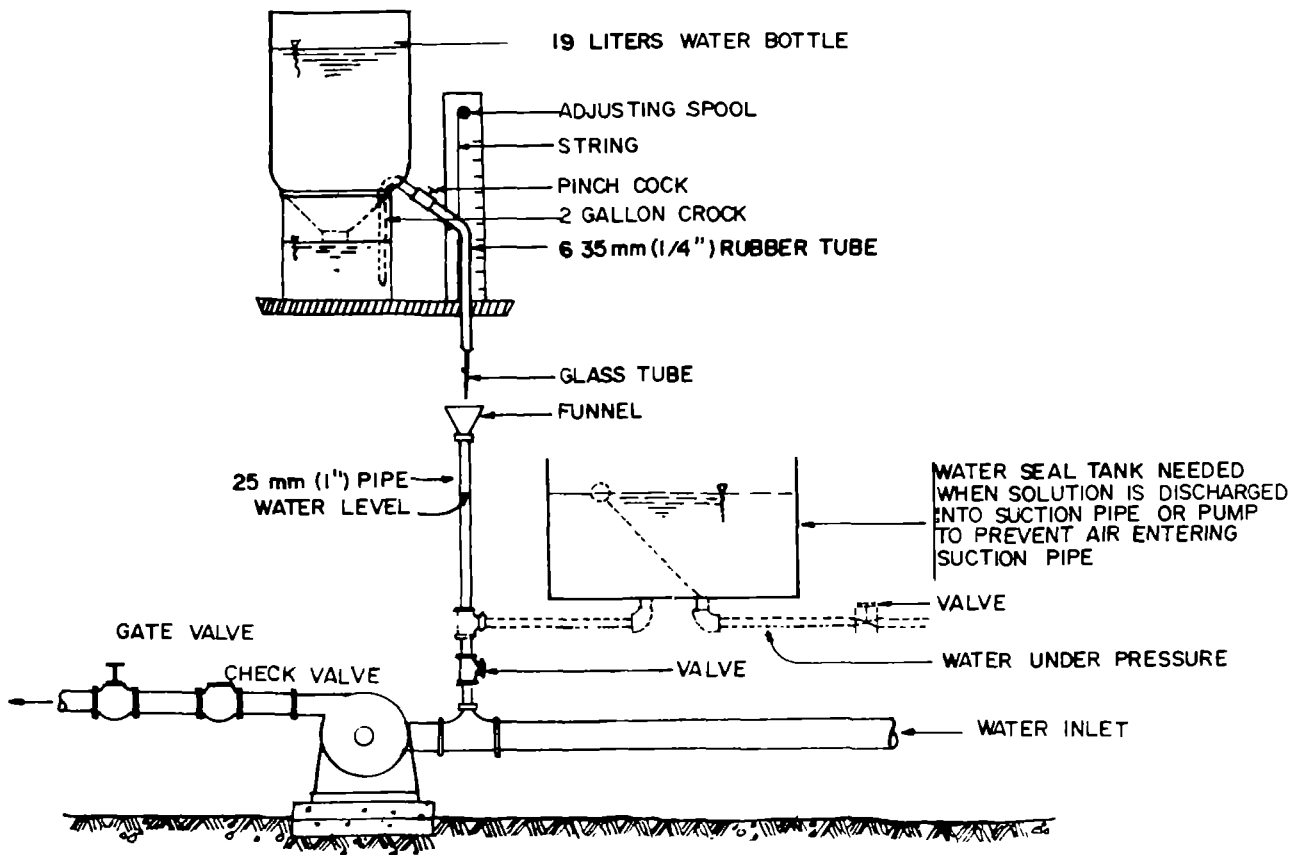

A INSTALLATION OF CHLORINATOR AT THE SUCTION OF PIPE

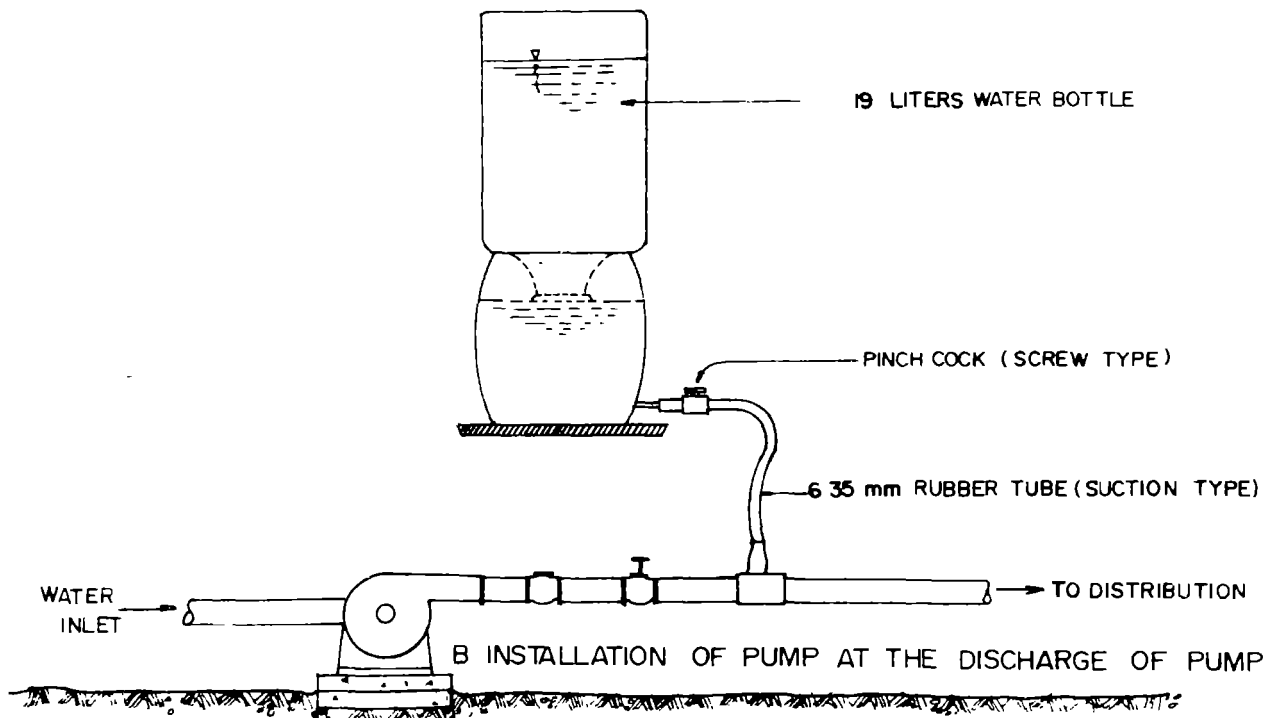
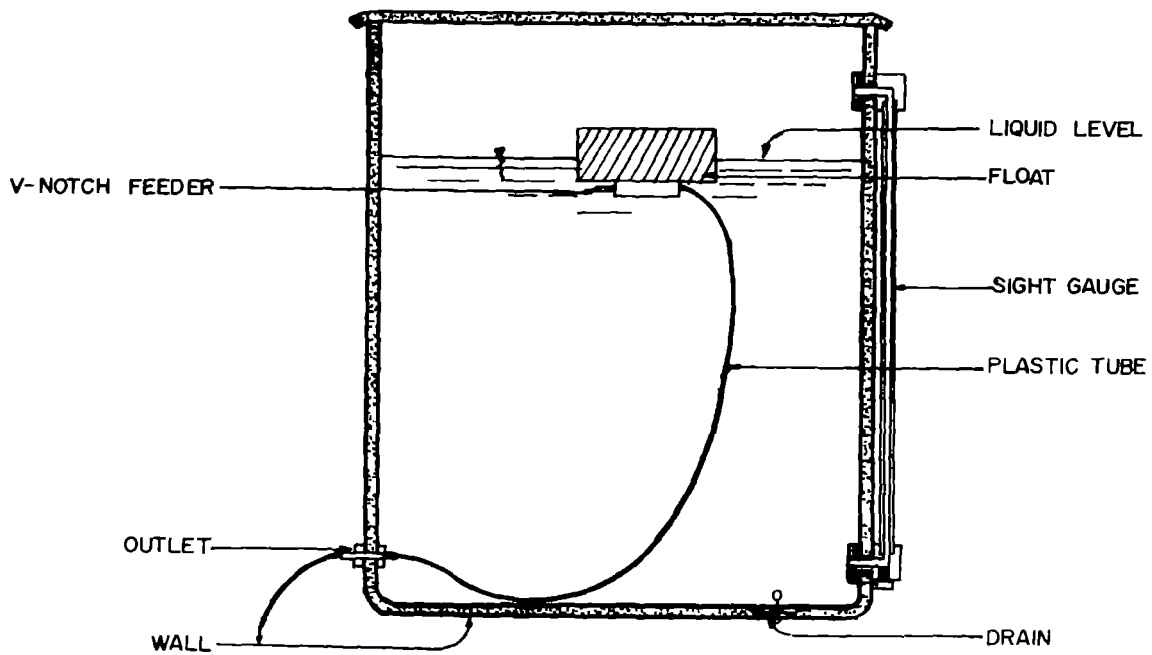
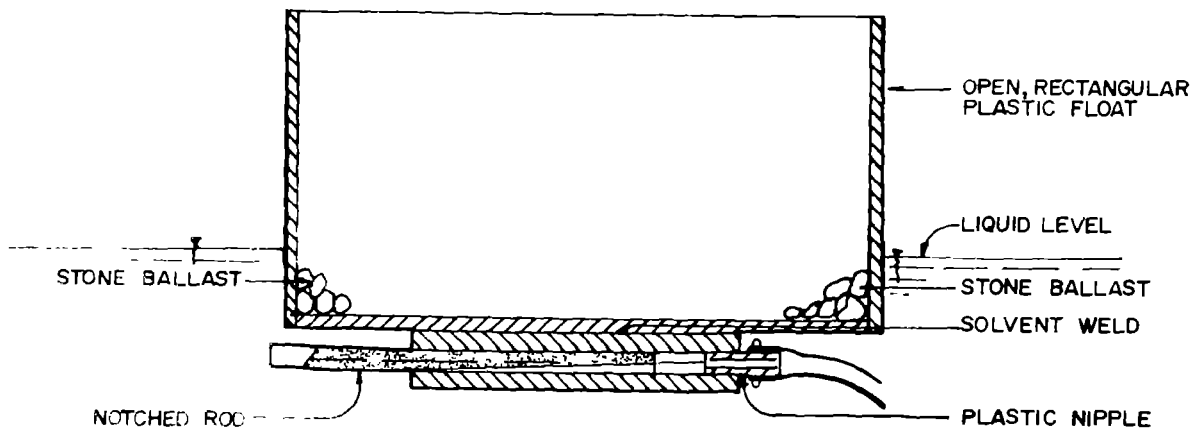

FIGURE 74

BOTTLE SOLUTION FEEDER (LIQUID SEAL TYPE)



SECTION



SECTIONAL DETAIL OF FLOAT

FIGURE 7 5

V - NOTCH CONSTANT - HEAD SOLUTION FEEDER

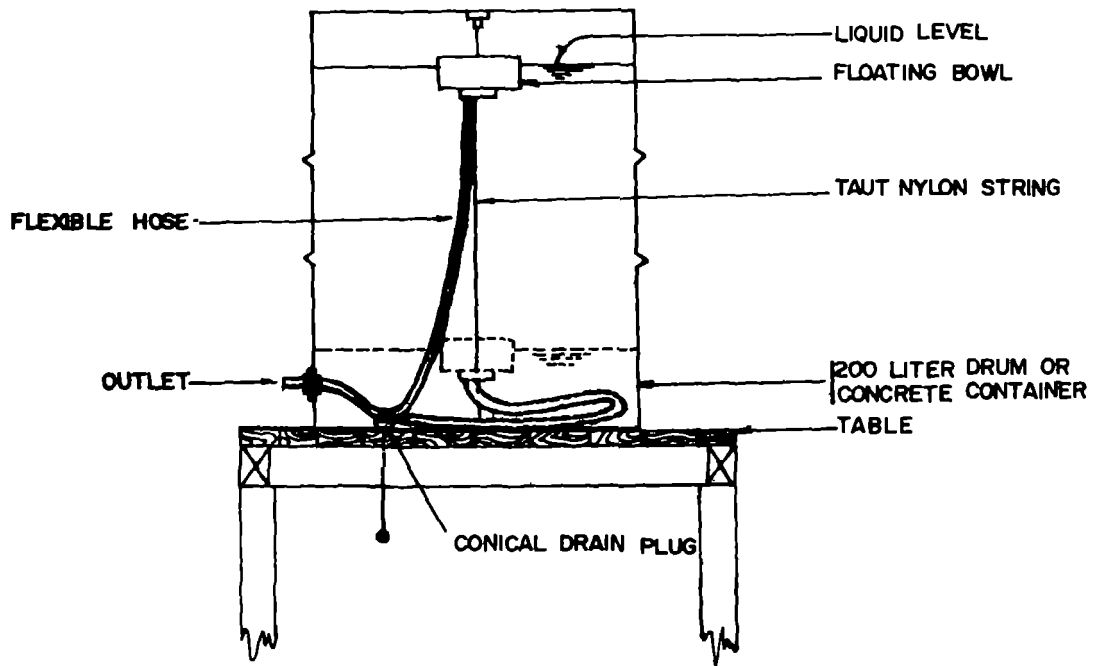

SECTION

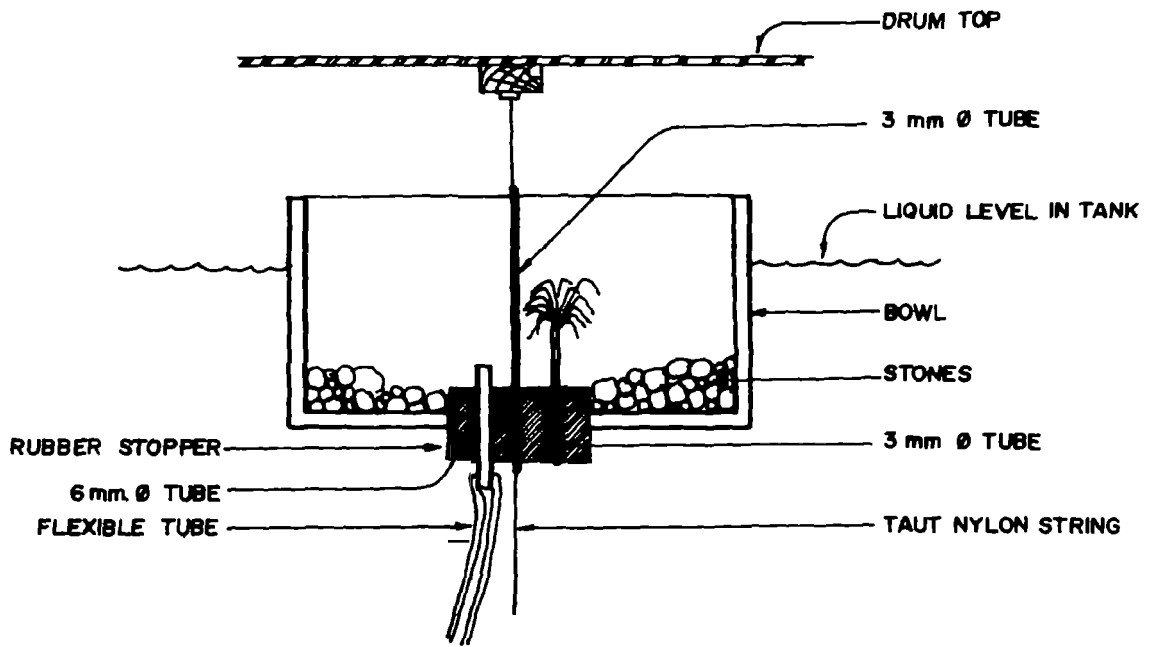

FLOATING BOWL DETAILED SECTION

FIGURE 7.6

FLOATING BOWL CHLORINATOR

CHAPTER 8

DISINFECTION

8.01 GENERAL

Disinfection is a process of killing pathogenic bacteria found in drinking water inside pipes, pumps, reservoirs and other components of the water supply system. It is carried out with the use of chemicals, usually chlorine. The chlorine dosages which are normally employed in disinfection are as follows:

1. **For Disinfection of Water Supplies**

Dosages – 0.2 – 0.7 mg/l
Contact Time – 15 – 30 minutes

2. **For Disinfection of Newly Constructed/Repaired Wells, Storage Tanks, Pipelines, Spring Boxes and Other Components of the Water Supply System**

- a. Dosage – 50 mg/l
 Contact Time – 24 hours

- b. Dosage – 300 mg/l
 Contact Time – 1 hour

The disinfection process and the estimation of the required chlorine dosages are presented in detail in Chapter 6 of the Design Manual, Volume 1.

8.02 DISINFECTION OF WATER SUPPLIES

Disinfection of water supplies is necessary to kill bacteria in drinking water prior to its consumption. These bacteria may have been originally present in water (in the case of untreated water) or may have gained entrance into pipelines through leaks.

At booster pumping stations, chlorine solution may be introduced into the suction pipe or into the main pipe between the pump and reservoir. If chlorine solution is applied into the suction pipe, a water seal tank (Figure 8.1) is necessary to prevent the entrance of air which may cause pump trouble. On the otherhand, if it is injected into the main pipe after the pump, the injection pressure of the chlorine solution feeder must be greater than the pressure in the water main.

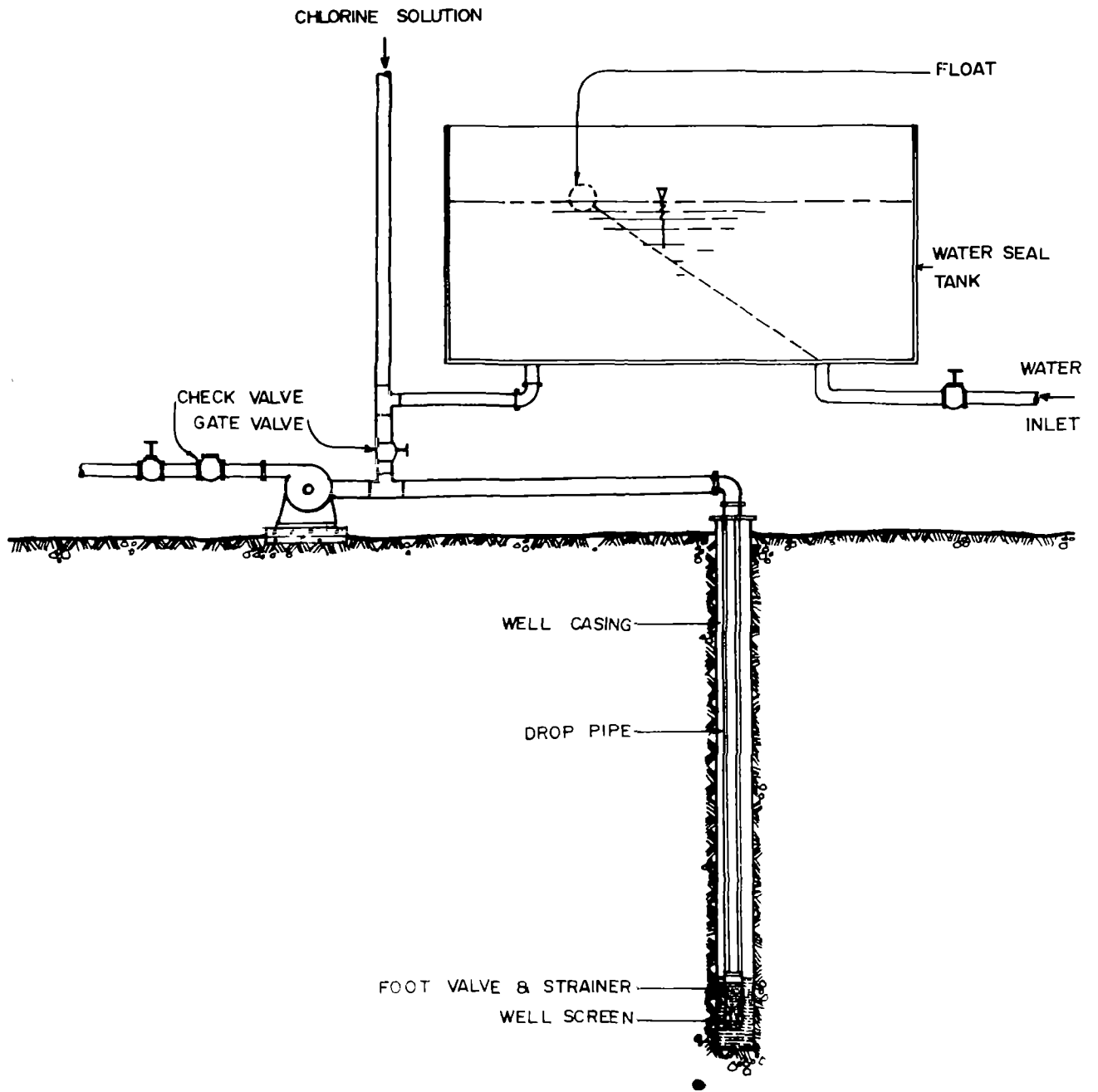

FIGURE 81

WATER SEAL TANK

8.03 DISINFECTION OF WELLS AND PUMPING FACILITIES

Newly constructed and repaired wells and pumps and their appurtenances should be disinfected before usage. The disinfection procedure is as follows:

1. Pour chlorine solution into the well and start the pump. Open the faucets and try to smell the odor of chlorine. When chlorine odor is noticeable, close the faucets and stop the pump. A more convenient procedure is to determine the amount of chlorine solution necessary and then pour the required amount of chlorine solution into the well.
2. Allow the well to stand idle for at least 24 hours.
3. Pump water to waste until the odor of chlorine disappears (During the first 30 minutes, return the heavily chlorinated water back to the well via the space between the casing and the drop pipe to disinfect this area).
4. The well is now ready for normal operation.

8.04 DISINFECTION OF RESERVOIRS AND STORAGE TANKS

Fill the tank with 50 mg/l chlorine solution and drain the solution to waste through the distribution system after 24 hours contact time.

It should be remembered that when disinfecting pressure tanks, it is necessary to open the air relief valve at the highest point so that air is released and the tank could be completely filled with heavily chlorinated water. Air should be readmitted before pumping.

In all cases, the test should show a distinct residual chlorine in the water drained out of the tanks. This is evidenced by a very slight odor of chlorine in the water. If there is no residual chlorine, the disinfection process should be repeated.

8.05 DISINFECTION OF PIPELINES

A 50 mg/l chlorine solution is applied at the beginning of the pipelines until they are full. The pipelines are then allowed to stay idle for 24 hours. After 24 hours of contact time, the chlorine solution is drained through the blow-off valves. The pipelines are then flushed with clean water. The residual chlorine should be less than 0.75 mg/l but more than 0.20 mg/l. This is measured roughly with the aid of a chlorine residual test kit.

APPENDIX A

The operator may do the work performed by a carpenter, an electrician, a plumber or a mason on different occasions. Hence, he should be equipped with at least a minimum number of tools needed to undertake minor repairs on the water system. Presented below are the common tools or equipment with their common name in local dialect or in Pilipino, for easy identification.

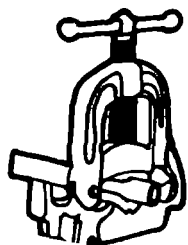

Name: BENCH VISE

Local Name: Gato

Description and Use: A device having two jaws opened and closed by a screw; used for holding firmly an object being worked on pipe rest and bender.

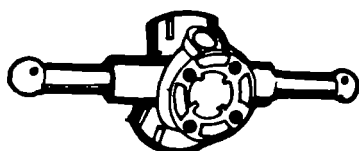

Name: PIPE THREADER

Local Name: Taraha

Usage: For threading



Name: PIPE CUTTER

Local Name: Pamutol ng Tubo

Usage: For Cutting Pipes.

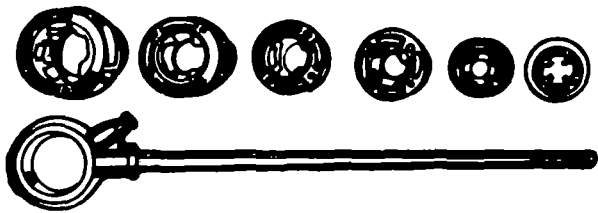

Name: RATCHET THREADER
Local Name: Taraha
Usage: For threading Pipes.



Name: HACKSAW
Local Name: Lagareng Bakal
Usage: for cutting iron pipes.



Name: ADJUSTABLE WRENCH
Local Name: Katala
Usage: For tightening and loosening of bolts and nuts.



Name: PIPE WRENCH
Local Name: Llave de Tubo
Usage: For tightening the joints of pipes.

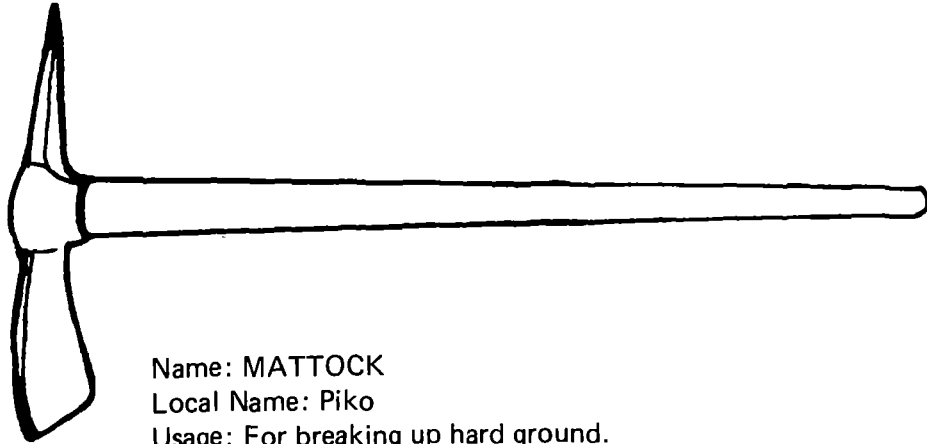

Name: MATTOCK
Local Name: Piko
Usage: For breaking up hard ground.

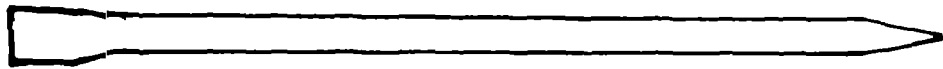

Name: CROWBAR
Local Name: Bareta
Description and Use: Straight, iron bar, usually one-end pointed and the other end bladed, used for digging the ground and as a lever for moving heavy objects.



Name: SHOVEL
Local Name: Pala
Description and Use: A tool with a broad scoop and long handle, used for lifting and moving loose materials.

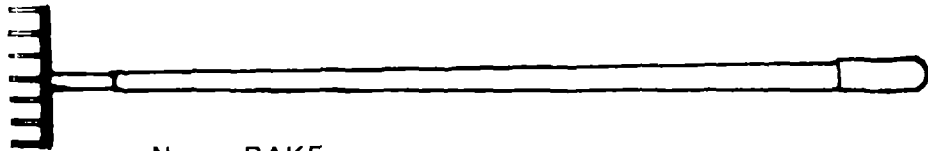

Name: RAKE
Local Name: Kalaykay
Description and Use: A long-handled tool with teeth at one end, for gathering hay, leaves, grass, and other garbage.

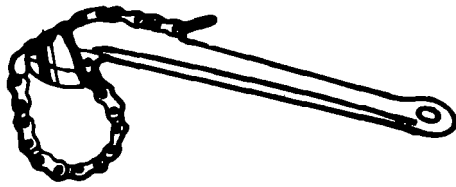

Name: CHAIN WRENCH
Local Name: Llave de Kadena
Usage: For holding pipes.

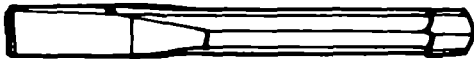

Name: COLD CHISEL
Local Name: Sinsil
Description and Use: Steel tool with a bevelled edge for shaping wood, stone or metal.



Name: WIRE BRUSH
Local Name: Brustsang Alambre
Usage: For polishing the inside surface of fittings.

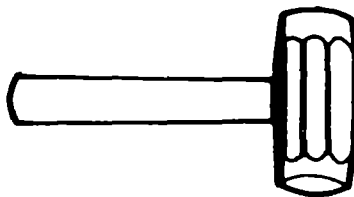

Name: CAULKING HAMMER
Local Name: Maso
Usage: for driving chisels.



Name: HAMMER
Local Name: Martillo
Usage: For driving in nails, chisel and many others.



Name: SCREW DRIVER
Local Name: Disturnillador
Usage: For turning screws.

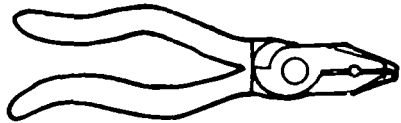

Name: PLIERS
Local Name: Plais
Usage: For holding, bending or twisting.

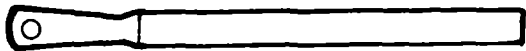

Name: FILE
Local Name: Kikil
Usage: For smoothing rough hard objects.

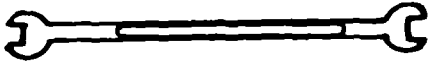

Name: OPEN WRENCH
Local Name: Llave
Usage: For loosening or tightening of nuts.

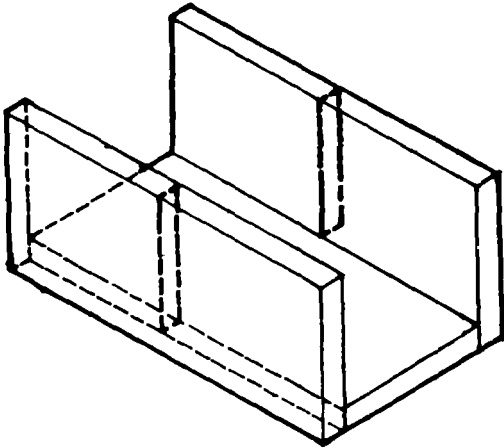

Name: MITER BOX
Local Name: Kalso
Usage: To serve as guide when cutting pipes.

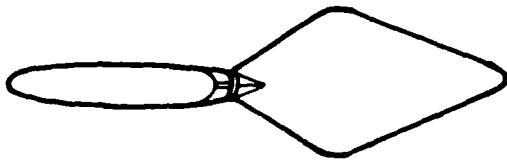

Name: TROWEL
Local Name: Kutsara
Usage: For applying mortar or smoothing plaster.

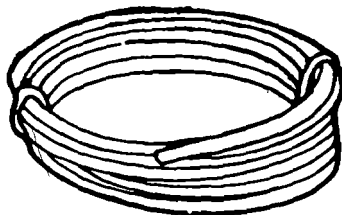

Name: WATER HOSE
Local Name: Hose
Usage: For conveying of water.

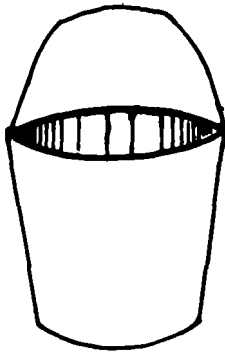

Name: PAIL
Local Name: Timba
Usage: For conveying of water and other materials.

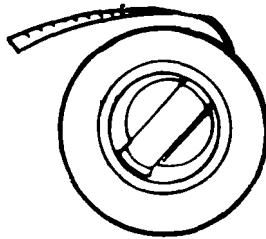

Name: STEEL TAPE
Local Name: Metro
Description and Use: Made of steel usually graduated in centimeters and inches; used as a measuring device.



Name: OILER
Local Name: Panglangis
Description and Use: A container usually with 0.6 liters capacity; used for oiling purposes during the maintenance of pumps.



Name: PLUMB BOB
Local Name: Panghulog
Description and Use: A lead metal weight hung at the end of a plumb line, used to determine whether a wall, etc. is vertical.



Name: REAMER

Local Name: Pangpaluwang

Description and Use: A sharp-edged tool used for enlarging or tapering holes.



Name: YARNING IRON

Local Name: Punson

Description and Use: A hand tool made of hard steel; driven manually into the bell or hole to compress the oakum.

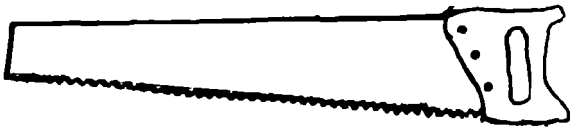

Name: SAW (for wood)

Local Name: Lagare

Description and Use: A wood cutting tool consisting of a thin metal blade or disk with sharp teeth.

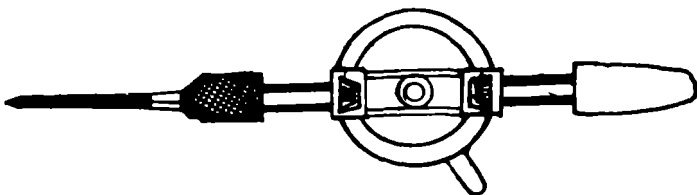

Name: HAND DRILL

Local Name: Barena

Description and Use: A double pinion three-jaw used for boring holes.

APPENDIX B

SUGGESTED GUIDELINES ON PROPER USE OF COMMON TOOLS OR EQUIPMENT

The following are suggested guidelines to prolong the life of tools and equipment.

1. Tools like hammers, shovels, saws, chisels, etc. with cracked handles should not be used. If possible, replace the cracked or deformed handles.
2. Tools should be kept in a safe place especially those with sharp edges. Keep these tools away from children.
3. Tools should be used properly. As an example, a wrench should not be used as a hammer.
4. Avoid using tools on moving machines to prevent hazards.
5. Tools should be cleaned and oiled after use; the work place should be kept in order.
6. Check the clearance at the work place to make sure that there is sufficient space if the tool should slip.
7. Have good support underfoot so that there is no hazard of slipping, stumbling or falling.

BIBLIOGRAPHY

- American Water Works Association: Groundwater, American Water Works Association, New York, 1973.
- American Water Works Association: Water Chlorination Principles and Practices, AWWA, New York, 1973.
- Babitt, H.E. and J.J. Doland: Water Supply Engineering, McGraw Hill Book Company, New York, 1955.
- Cairncross, S. and R. Feachem: Small Water Supplies, The Ross Institute of Tropical Hygiene, London, 1978.
- Clow, J.B.: Pipe Economy, James B. Clow & Sons, Inc., Chicago, 1967.
- Economy Pumps, Inc.: Pump Engineering Data, Economy Pumps, Inc., Hamilton, Ohio, 1948.
- Favi, M.F., J.C. Geyer and D. A. Okun: Water and Wastewater Engineering, John Wiley & Sons, Inc., New York, 1966.
- FMCC: Hydropneumatic Pressure Systems, Peerless Pump Division, Food Machinery and Chemical Corporation, California, 1955.
- Huisman, L. and W.E. Wood: Slow Sand Filtration, World Health Organization, Geneva, 1974.
- Local Water Utilities Administration: Technical Standards Manual, Local Water Utilities Administration Philippines, 1978.
- Manas, U.T.: National Plumbing Code Handbook, Mc. Graw Hill Book Company, New York, 1957.
- Marais, G.V.R. and F.E.Mc. Junkin: Bottle Hypochlorite Solution Feeders, Water Supply and Sanitation in Developing Countries, U.S.A.I.D., 1966.
- Marais, G.V.R. and F.E.Mc. Junkin: Characteristics of the Unknown Pump, Water Supply and Sanitation in Developing Countries, U.S.A.I.D., 1966.
- Marais, G.V.R. and F.E. Mc Junkin: Floating Bowl Hypochlorite Solution, Feeder, Water Supply and Sanitation in Developing Countries, U.S.A.I.D., 1966.
- Marais, G.V.R. and F.E. Mc. Junkin: V-Notch Constant – Head Solution Feeder, Water Supply and Sanitation in Developing Countries, U.S.A.I.D., 1966.
- Mc. Junkin, F.E.: Temporary Chlorination of Small Water Supplies, Water Supply and Sanitation in Developing Countries, U.S.A.I.D., 1967.

- Salvato, J.A.: Environmental Sanitation, John Wiley & Sons, Inc., New York, 1958.
- UNICEF: Rural Water Supply & Sanitation in the Developing Countries
UNICEF, New York, 1975
- Wagner, E.G. and J.N. Lanoix: Water Supply for Rural Areas and Small Communities,
World Health Organization, Geneva, 1959.
- Waterworks Equipment Co.: Waterworks Sewage Treatment, Industrial Supplies,
Tools, Useful Information, Waterworks Equipment Company, Utah, 1960.
- World Health Organization: Slow Sand Filters, Community Water Supply Research
and Development Programme, 1977.
- Wright, F.B.: Rural Water Supply and Sanitation, Robert E. Krieger Publishing Co.,
New York, 1977.