

2 0 1

8 9 S M

Small Community Water Supply (An Illustrative Manual)

Compiled by

**Dr. S. Vigneswaran
Dr. Kiran K. Bhattarai
Mr. Ram Sharma Tiwaree**

**Environmental Engineering Division
Asian Institute of Technology
Bangkok, Thailand
June, 1989**

201-89SM-6125

Small Community Water Supply
(An Illustrative Manual)

Compiled by :

Dr. S. Vigneswaran
Dr. Kiran K. Bhattarai
Mr. Ram Sharma Tiwari

ENVIRONMENTAL ENGINEERING DIVISION
ASIAN INSTITUTE OF TECHNOLOGY
AND UNIVERSITY
P.O. Box 27, Bangkok 10501, Thailand
Tel. (0) 271 8111 ext. 141/142

RR: 6125
LR: 2d 895M

Environmental Engineering Division
Asian Institute of Technology
Bangkok, Thailand
June, 1989

TABLE OF CONTENTS

<u>Title</u>	<u>Page</u>
Title Page	i
Table of contents	ii
List of figures	iii
I. Rainwater collection systems	1
1. Roof catchment	
2. Ground catchment	
3. Collection	
4. Water quality preservation	
II. Groundwater withdrawal methods	3
1. Horizontal method	
2. Vertical method	
III. Surface water Intake	20
1. River water intake	
2. Lake water intake	
IV. Pumps used in water supply	25
1. Hand pumps	
2. Power pumps	
V. Aeration and Chlorination	50
1. Aeration	
2. Chlorination	
References	56

LIST OF FIGURES

<u>Figure</u>	<u>Title</u>	<u>Page</u>
1	Simple roof catchment and storage (Thailand)	2
2	Arrangement for diverting the 'first foul flush'	2
3	Roof catchment and storage of rainwater (withdrawl by handpump)	2
4	Ground catchment	4
5	Underground rainwater storage well (as used in China)	4
6	Beehave structure storage well	4
7	Rainwater storage arrangement	5
8	Venetian Cistern	5
9	Withdrawl of filtered rainwater from storage	5
10	Seepage ditch	6
11	Infiltration drain	6
12	Infiltration tunnel	6
13	Dug well	7
14	Tube well	7
15	Battery of Tubewells	7
16	Radical collector well (Ranney Well)	8
17	Test pumping	8
18	Dug well in rock formation	10
19	Dug well in coarse granular material	10
20	Dug well in fine granular aquifier	10
21	Dug well sealed with sanitary protection	11

22	Dug well built in temporary excavation	11
23	Reinforced concrete curb built on site	13
24	Sinking a dug well by excavation from inside	13
25	Dug well with brickwork lining	13
26	Dug well construction with pre-fabricated rings	14
27	Pre-fabricated concrete rings	14
28a	Dug well construction using a combination of methods	15
28b	Dug well construction using a combination of methods	15
29	Driven well	16
30	Well driving arrangement	16
31	Well driving with inside drive bar	18
32	Well drive point with sliding joint	18
33	Well jetting	19
34	Well jetting with an outside jet pipe	19
35	Unprotected river intake	21
36	River intake structure	21
37	Pumped river water intake	21
38	Bank river intake using infiltration drains	22
39	Variable depth lake water intake	22
40	Intake structure at bottom of shallow lake	22
41	Simple water intake structure	24
42	Float intake	24
43	Typical shallow well lift pump	26
44	Deep well lift pump	26

45	Reciprocating force pumps	27
46	Cross-section of a diaphragm pump	27
47	Cross-section of a rotary pump	27
48	Cross-section of semi-rotary pump	29
49	Cross-section of helical rotor pump	29
50	Bucket pump	29
51	Chain pump	29
52	Hand pump nomenclature	30
53	Battle pumps - Shallow well configuration	31
54	Battle pump - Deep well configuration	32
55	New no. 6 pump (Bangladesh)	33
56	Hydro - pompe Vergnet Schematic arrangement	34
57	U. S. T. (Kumasi) Hand pump	35
58	The Petro pump	37
59	Polyvinyl chloride (PVC) plastic hand pump	38
60	India Mark - II Hand pump	39
61	The "Kangaroo" pump	40
62	The two stroke reciprocating type well pumps	41
63	Centrifugal pump (Volute-type casing)	42
64	Vertical spindle pump motor for driving the multistage bore-hole pump	43
65	Shaft driven multistage bore-hole pump (Harland Engineering Co. Ltd.)	44
66	Helical rotor pump	45
67	Shaft-driven pumps	47

68	Pumpdriven by a close-coupled submersible electric motor	48
69	Submersible pump (exploded view)	49
70	Multitilpe-tray aerator	52
71	Cascade aerator	52
72	Multiple platform aerator	53
73	Hand operated aeration/filtration unit for iron removing	53
74	Indian Iron removal unit	54
75a	Chlorination pot with holes at the bottom	55
75b	Double pot chlorinator	55
75c	Equipment for feeding chlorine solution	55

I. Rainwater Collection Systems

Rainwater collection is an important source of domestic water supply especially where

- the groundwater resources are unavailable or costly to develop.
- rainfall is heavy in storms of considerable intensity, with intervals during which there is practically no or very little rainfall.

Depending upon the situations, the catchment of water is on the ground or the runoff from roofs is collected and stored properly. These are explained below:

1. Roof catchments: Reasonably pure rainwater can be collected from house roofs made of tiles, slates, galvanised iron, aluminium or asbestos cement sheeting. Figures 1 through 3 are few examples of roof catchments.

2. Ground catchments: These are used for collecting rainwater runoff. Better collection of rainwater can be done from the sloping ground catchments covered with impervious materials like tiles, concrete, asphalt or plastic sheeting. Figure 4 is an example of ground catchment.

3. Storage and preservation: Storage facilities should be provided with enclosures to prevent any contamination from human or animals, leaves, dust or other pollutants entering the storage container. To prevent algal growth and the breeding of mosquito larvae, dark storage conditions should be maintained.

Storage facilities can be above ground or below ground. Below ground facilities have the general advantage of being cool, no water loss through evaporation, and space and construction cost is saved. Figure 5 is an example of such a facility where cement may be used for plastering the excavation walls, or simple sheeting.

Another underground tank consisting of bee-hive structures as shown in Figure 6 has been used in many countries including Sudan, Botswana, Brazil etc. Two more examples of rainwater storage are shown in Figures 7 and 8.

The quality of rainwater collected from the roof or ground catchment may deteriorate through the putrefaction of organic material, growth of bacteria and other microorganisms in the water. The following control measures to protect the quality of stored water are necessary: (i) exclusion of light from the stored water (ii) cool storage conditions and regular cleaning, (iii) disinfection of water by the use of simple devices like chlorination pot etc. An example of rainwater preservation is shown in Figure 9.

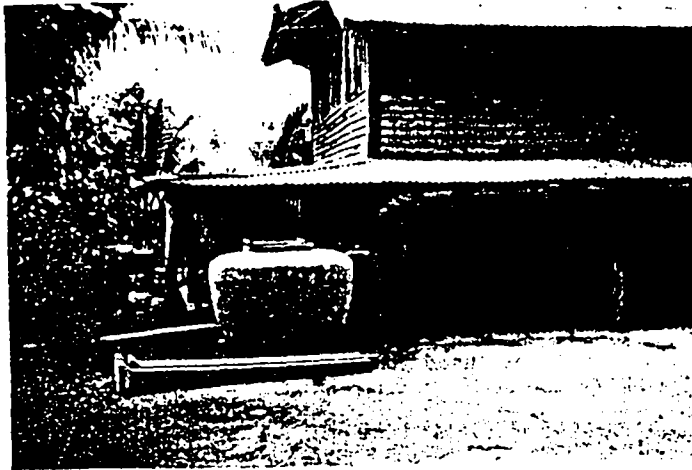

IRC Photo

Fig. 1 Simple roof catchment and storage (Thailand)

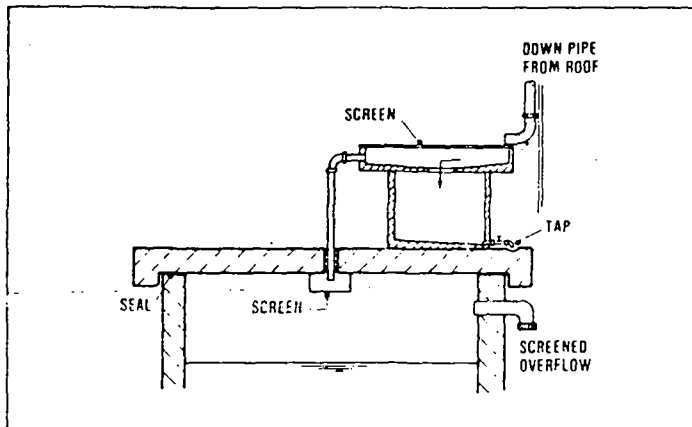

Fig. 2 Arrangement for diverting the 'first foul flush

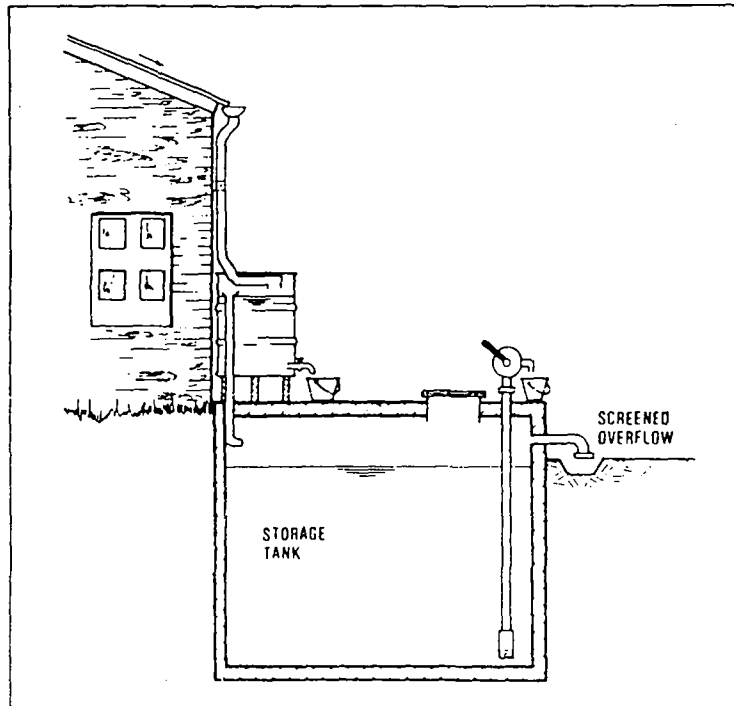

Fig. 3 Roof catchment and storage of rainwater (withdrawal by handpump)

II. Groundwater Withdrawl Methods

Groundwater is always a preferred source for community water supply. Withdrawl of groundwater can be done in the following ways:

1. Horizontal Method: Horizontally extended means for groundwater withdrawl are called galleries. Galleries should only be used where the groundwater table is at a shallow depth (not more than 5-8 m below the ground surface). Galleries may be subdivided as :

(a) Ditches (Figure 10) are easy to construct, can have large capacity, and long useful life. As they are open, water collected in them is unprotected against contamination that makes them less suited for water supply purposes.

(b) Infiltration drains and tunnels (both of them) are costly to build, and their design is complicated. As these collectors are completely underground, the collected water is protected against any contamination from the ground surface. Figures 11 and 12 represent the infiltration drain and tunnel respectively.

2. Vertical Method: Groundwater withdrawl by this method may be subdivided into large diameter dug wells (Figure 13) and small diameter tube wells or boreholes (Figure 14).

The use of dug wells is restricted to individual household and other small-scale water supplies as they have limited capacity. When groundwater table is at a considerable depth below the ground, tubewells have to be used. These are effective in aquifers of sufficient thickness. The capacity of tubewells varies from less than 1 l/sec for shallow small-diameter wells in fine sand aquifers, to over 100 l/sec for large-diameter wells in coarse sand or sedimentary rock deposits. Tube wells are well suited for drinking water supplies as simple precautions will be sufficient to safeguard the water so withdrawn against contamination. A battery of tubewells placed in series pumped as one unit, can be used (Figure 15). When there is unconsolidated ground, radial well collector (also called as Ranney Well) may be considered (Figure 16) although these wells require special design and construction, and this makes them less suitable to small community water supply.

When groundwater is withdrawn at a high rate, there is a possibility of an appreciable lowering of the groundwater table. It is ,therefore, necessary to carry out a test pumping (Figure 17) as an investigation for making an estimation for future drawdown of the water table.

Further discussions of dug wells and tube wells are presented below:

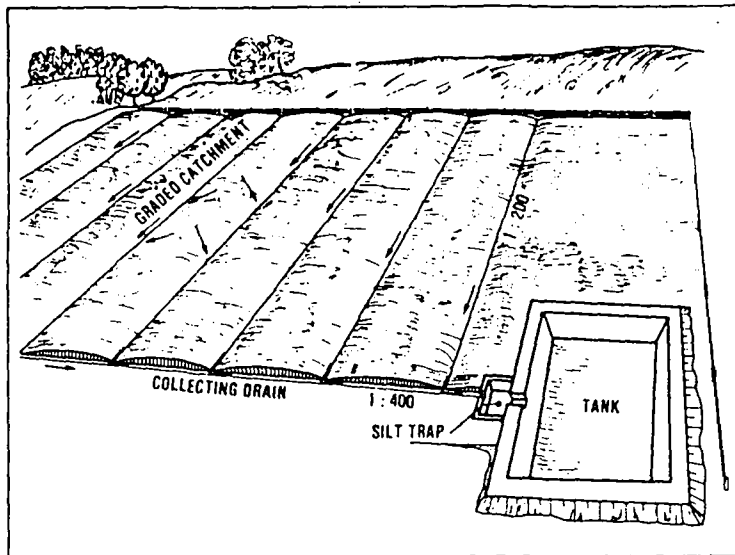

Fig. 4 Ground catchment

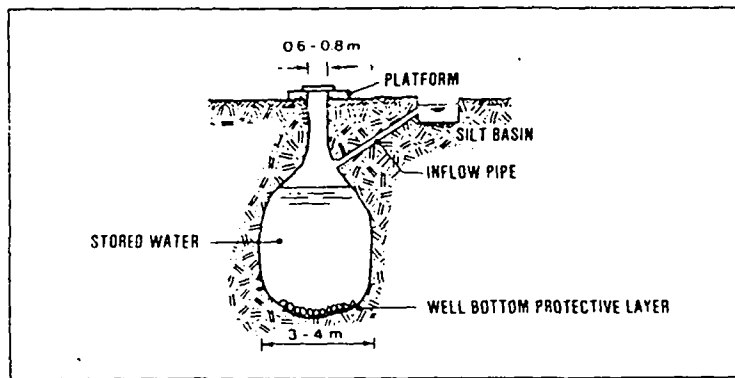

Fig. 5 Underground rainwater storage well (as used in China)

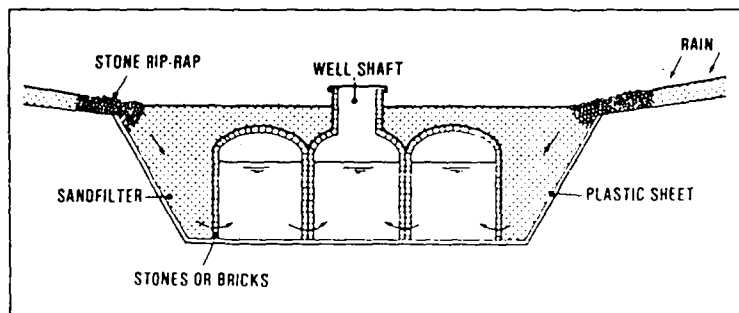

Fig. 6 Beehive structure storage well

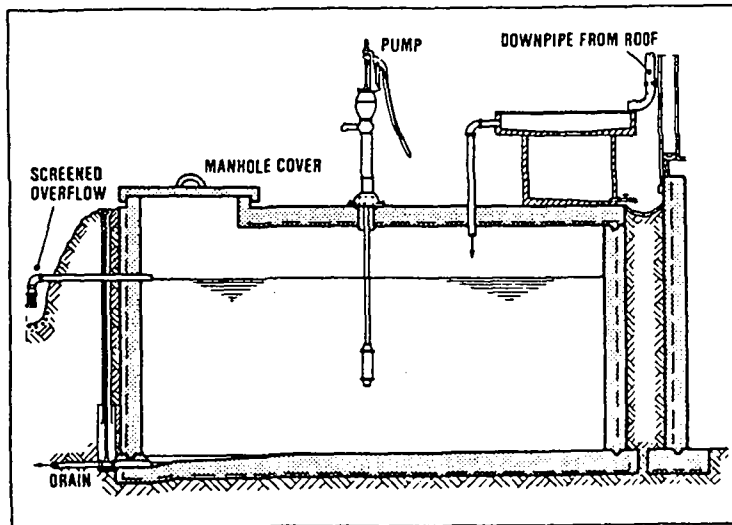

Fig. 7 Rainwater storage arrangement

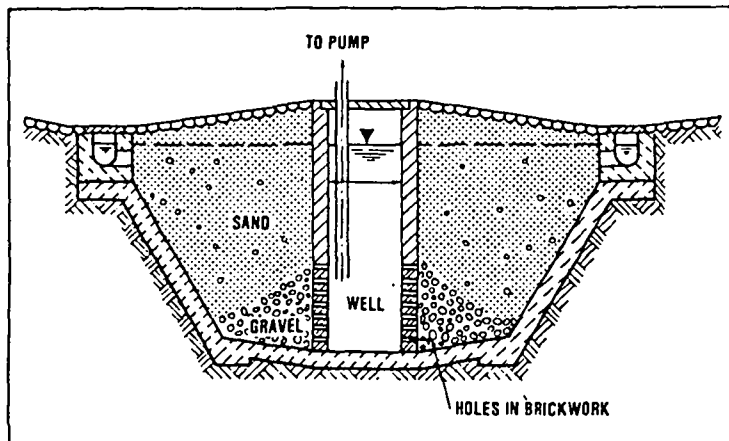

Fig. 8 Venetian Cistern

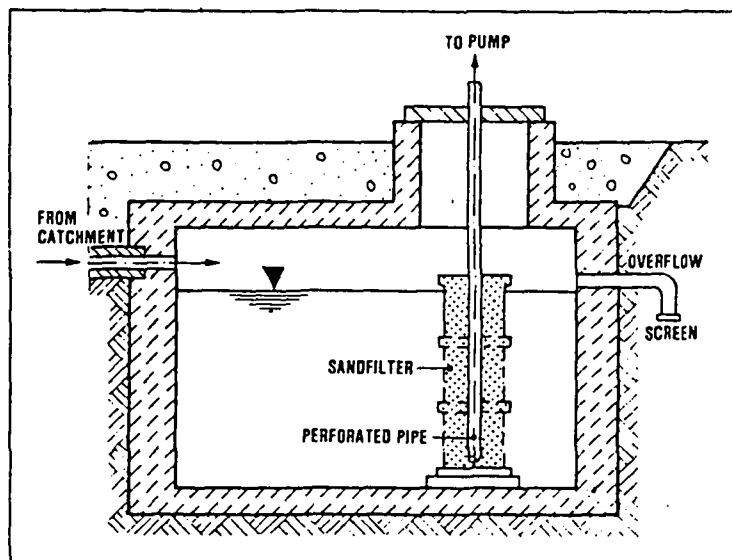

Fig. 9 Withdrawl of filtered rainwater from storage

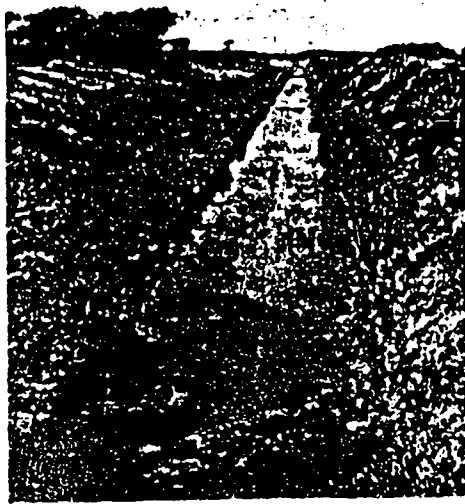

Fig. 10 Seepage ditch

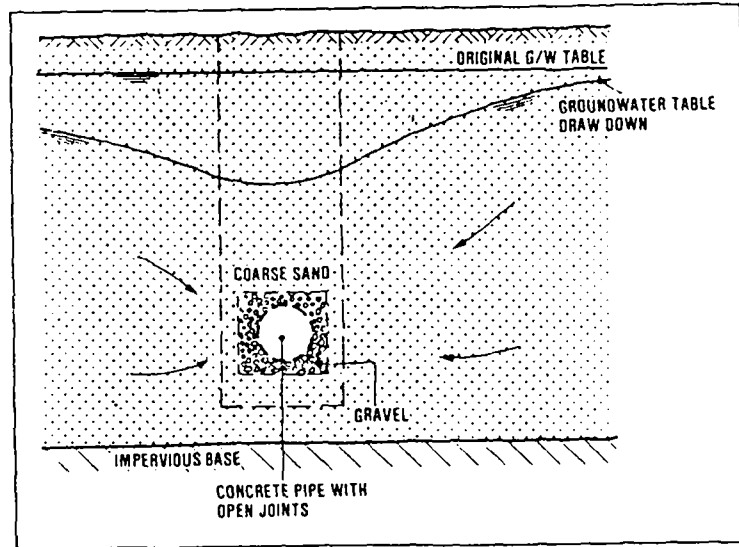

Fig. 11 Infiltration drain

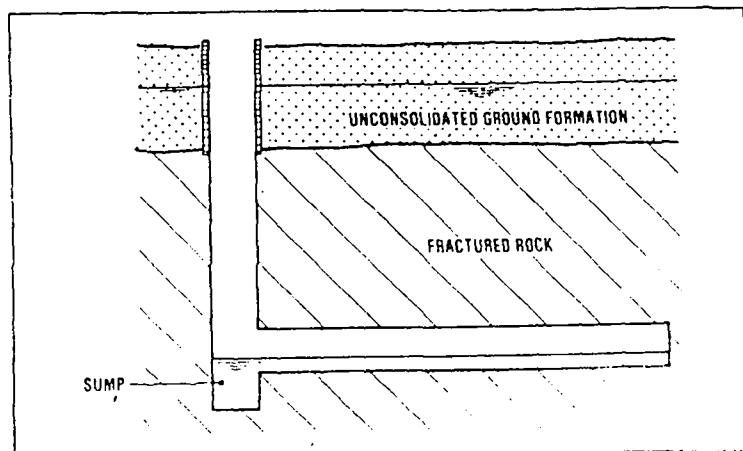

Fig. 12 Infiltration tunnel

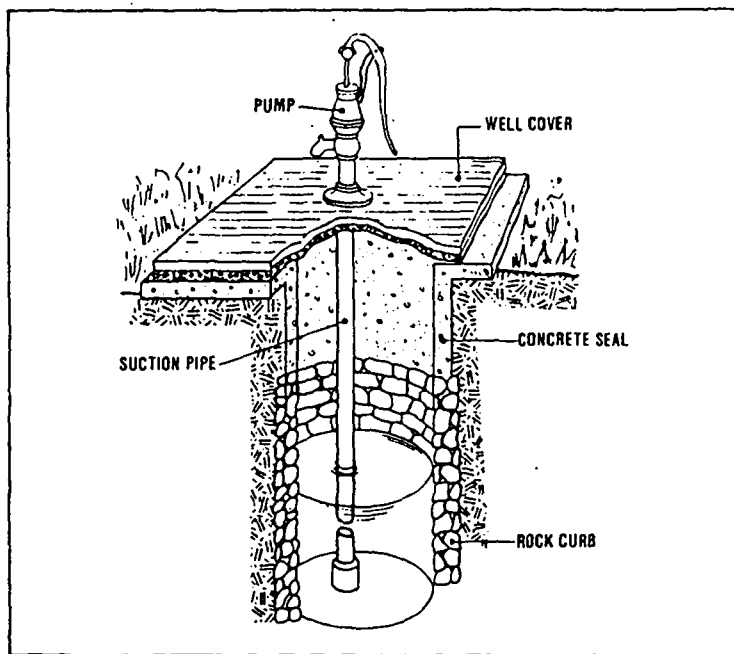

Fig. 13 Dug well

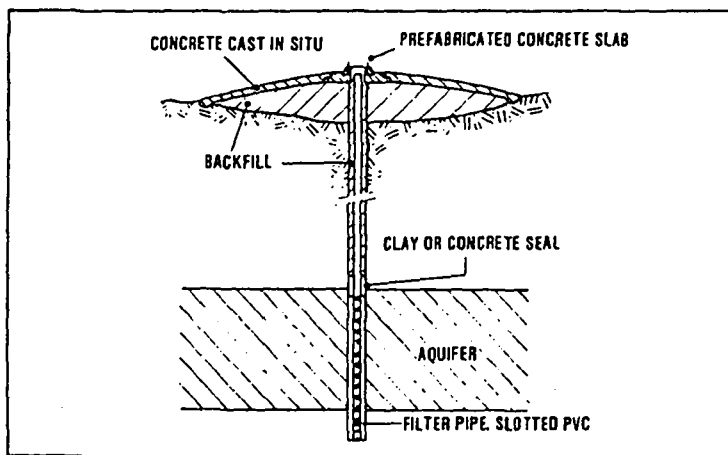

Fig. 14 Tube well

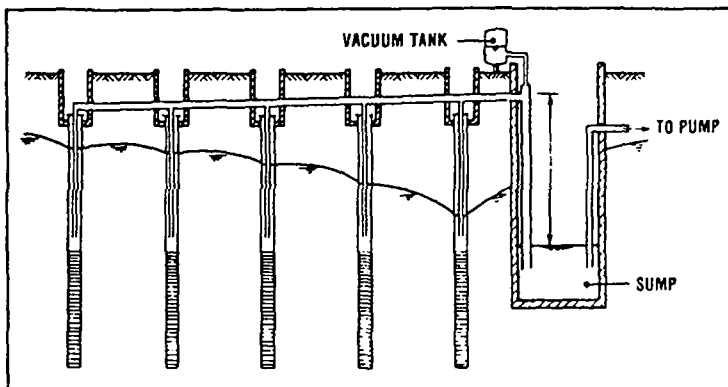

Fig. 15 Battery of Tubewells

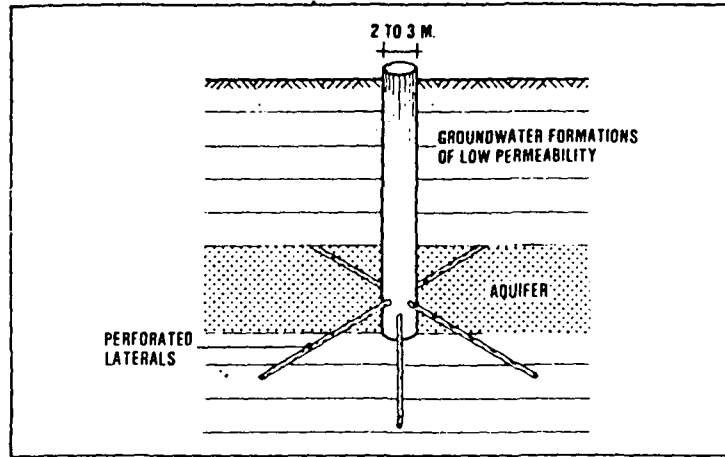

Fig. 16 Radical collector well (Ranney Well)

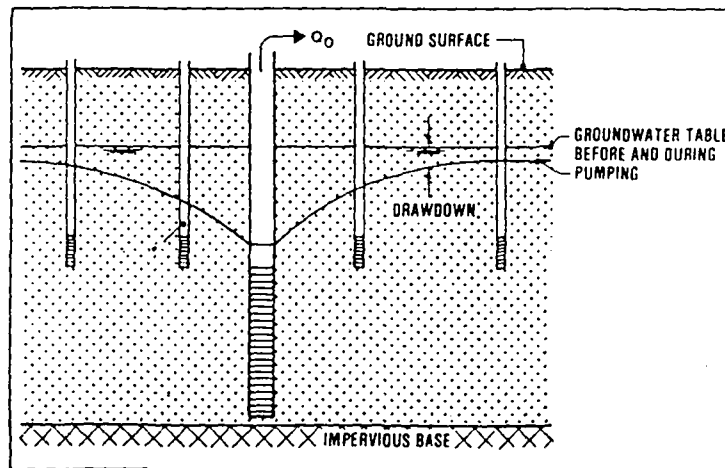

Fig. 17 Test pumping

(a) Dug wells: These are simple, no special equipment are required for construction and thus are widely used for private household and small community water supply in many countries. The diameter of the dugwells is generally considered to be 1.2 m for a farm community and 2.3 m for more people. Because of large diameters and volume, dugwells provide both withdrawal and storage of the groundwater. The depth to which a well can and should be dug largely depends on the type of the grounds and the fluctuation of the watertable. In general, the depth of a private well is considered to be 10 m and that for community water supply as 50 m. Dug wells need an inner lining. The materials used for this are brick, stone, masonry, precast concrete rings etc. During the well construction, lining provide protection against caving and collapse, and prevent crumbling ground from filling up the dug hole whereas after the completion of the construction, linings serve as wall and provide a seal against polluted water seeping from the surface into the well.

Depending on the type of the ground, lining can be done partially or fully. In consolidated ground (e.g. rock), lining of the upper part is sufficient as shown in Figure 18. In case of unconsolidated ground (coarse granular material), the well should be lined entirely such that the section of the well penetrating the aquifer requires a lining with openings or perforations enabling the groundwater to flow into the well (Figure 19). In fine sand aquifers, lining with openings cannot be provided and the groundwater enters the well only from the bottom which is covered with several layers graded gravel keeping down the fine sand of the water-bearing formation (Figure 20).

For complete and satisfactory safeguard of the water (including bacteriological) from a well, the well top should be completely sealed with a watertight slab on which a pump is mounted to draw the water (Figure 21). Here a manhole that can be tightly and securely locked should be provided to allow disinfection of the water in the well by chlorination.

Figure 22 is an example of a dug well constructed in a temporary excavation drained and braced against caving. Masonry and brick-work are widely preferred although any type of building material may be used. The curbs of masonry and brickwork have to be constructed with open joints and to provide openings, short pieces of tin tube or garden hose can be cast in concrete linings.

Digging of a dug well should be done section by section as shown in Figure 23, even for stiff, unconsolidated ground. Each section should be 2-4 m high and is kept in place by the surrounding ground pressing against it.

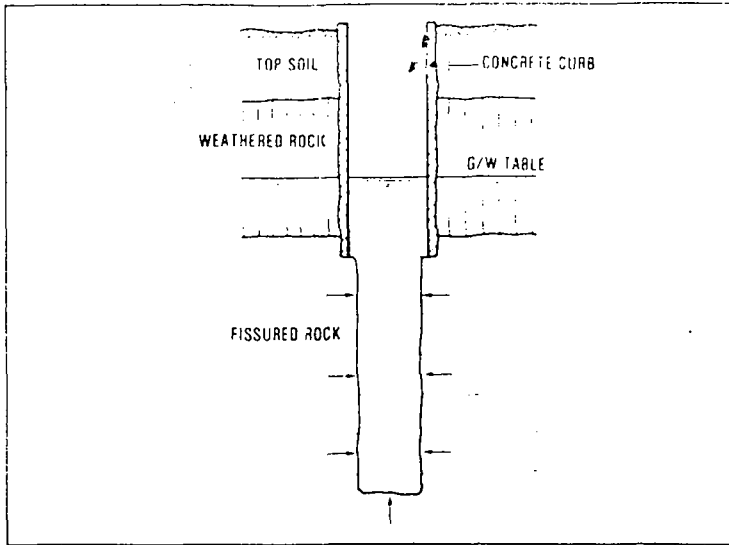

Fig. 18 Dug well in rock fomation

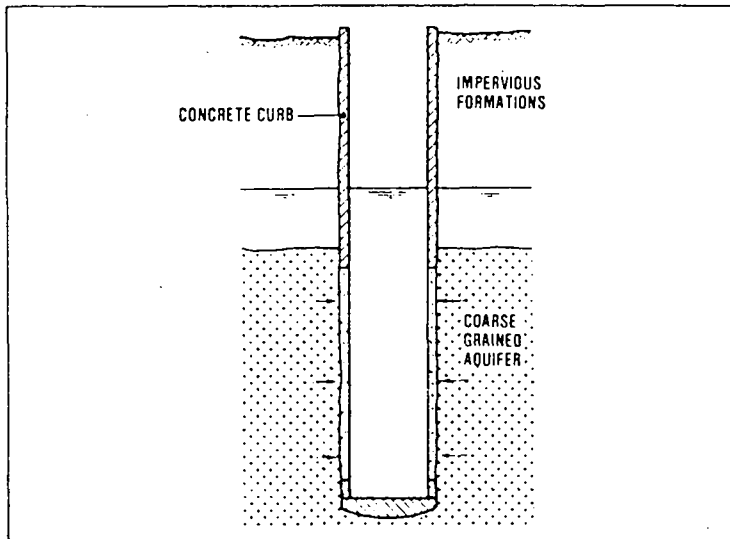

Fig. 19 Dug well in coarse granular material

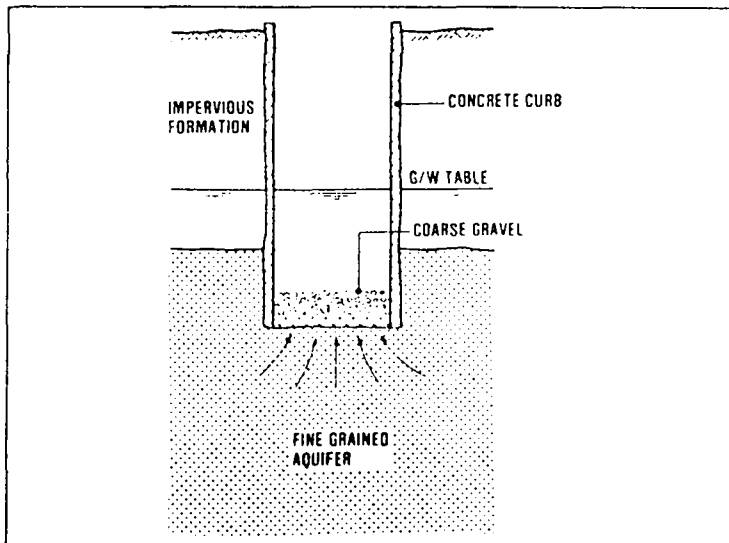
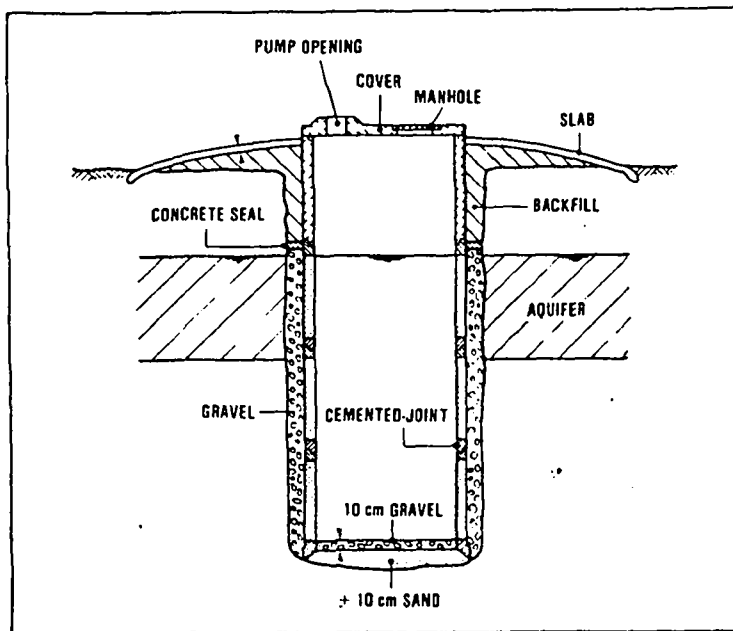

Fig. 20 Dug well in fine granular aquifier



Source: 'Shallow Wells', 1978

Fig. 21 Dug well sealed with sanitary protection

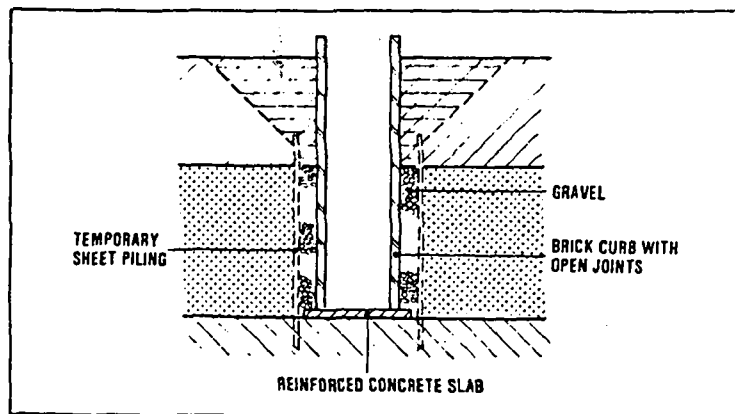

Fig. 22 Dug well built in temporary excavation

The most common method of constructing a dug well is by excavation from the inside, removing the ground at the bottom. As shown in Figure 24, the lining then sinks down due to its own weight. For wells of diameters upto 3-4 m, the digging is carried out frequently with hand tools, otherwise diggers are used. Masonry work of stones, bricks or concrete blocks can be used to build the well lining using a strong steel ring shoe at the base for preventing the lining from settling unevenly which could cause deformation and cracks. Figure 25 is an example of constructing the well lining using a steel ring shoe. Similarly, Figure 26 is an example of using prefabricated rings to form the well lining of a dug well. This material is also widely used especially when other materials like large-diameter pipes of concrete, asbestos, cement or plastic are either not available or costly. Prefabricated rings need no skilled masons, and there is no difficulty in training the unskilled workers to be employed for making them. The three types of prefabricated concrete rings are shown in Figure 27. The first one is the starter ring whose lower end is provided with a shoe having an inside cutting edge; the outer diameter is somewhat larger to facilitate the sinking and to reduce ground friction along the outside. During sinking this ring leaves a space around the curb. The second type of ring (filter ring) is made of no-fines concrete (pea-size gravel and cement without sand) and the last one is known as the seal ring used at the top of the dug well.

The combination of the two methods described above may give a more economic and technically better construction. Figures 28a and 28b are the examples of such combinations. Figure 28a gives an excellent protection against any entry of the polluted seepage whereas Figure 28b has much less construction cost.

(b) Tube wells: Tubewells can be drilled to over 200 m deep, even through hard rock although it cannot be guaranteed that water can be found at this level. It is, therefore, essential to seek the assistance of experienced and qualified persons together with the information of hydrogeology of that region. Tube wells are very suitable for small-capacity water supplies. Small diameter and shallow depth tube wells may be constructed by driving, jetting or boring whereas for larger diameter tube wells drilling is more appropriate to withdraw the large amount of water at greater depths.

A short description of the construction methods for small and shallow tube wells has been presented below:

(i) Driven wells: These wells are made by driving a pointed screen (called a "well point") as shown in Figure 29). The point at the lower end of the screen is made of solid steel usually with a slightly larger diameter (usually 30-50 mm) than the screen itself so that the well point can be prevented from being damaged. The well point is driven into the ground using a simple mechanism for hitting the top of the pipe. A simple example of a well driving arrangement is shown in Figure 30.

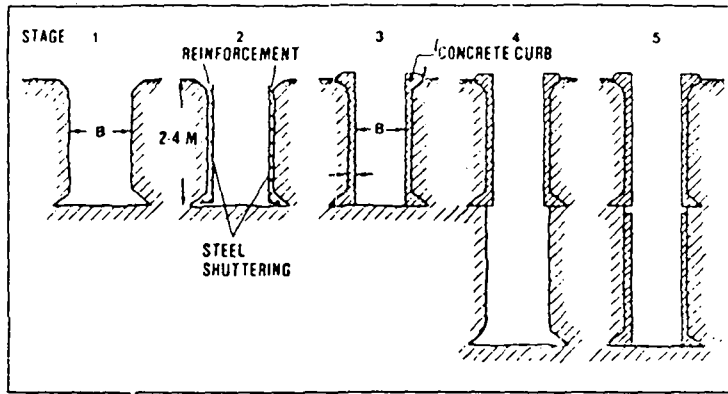

Fig. 23 Reinforced concrete curb built on site

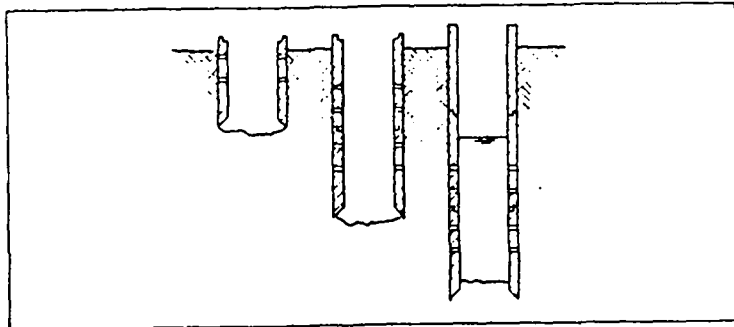

Fig. 24 Sinking a dug well by excavation from inside

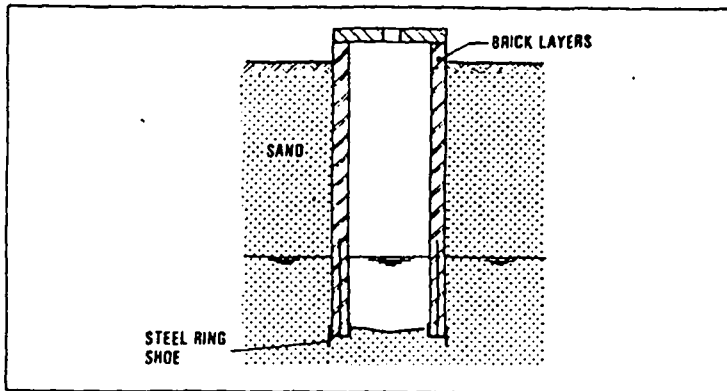

Fig. 25 Dug well with brickwork lining

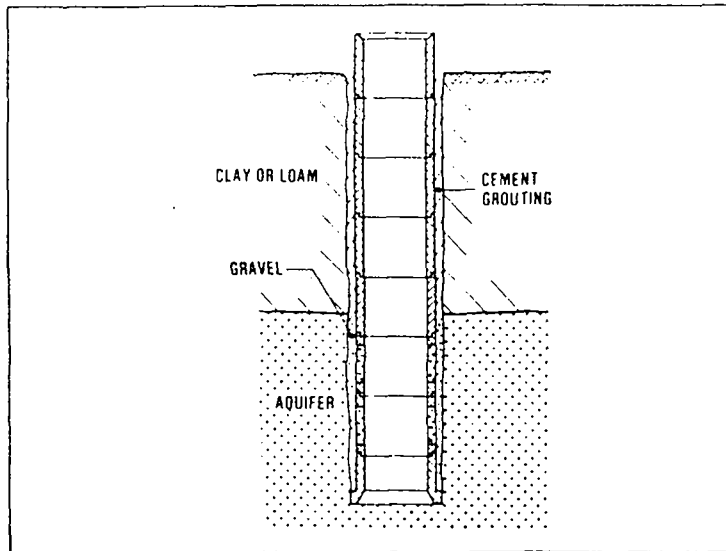

Fig. 26 Dug well construction with
Pre-fabricated rings

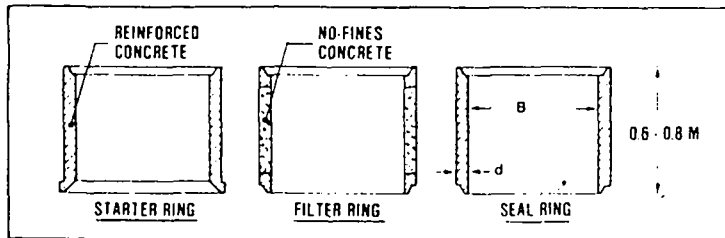

Fig. 27 Pre-fabricated concrete rings

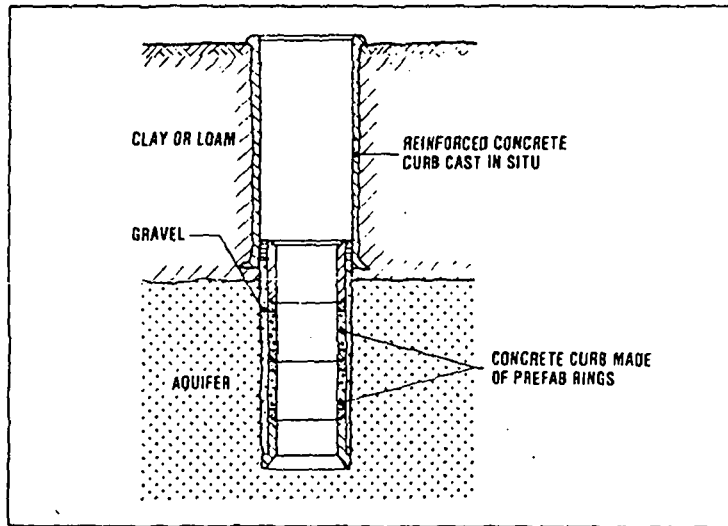

Fig. 28 'a' Dug well construction using a combination of methods

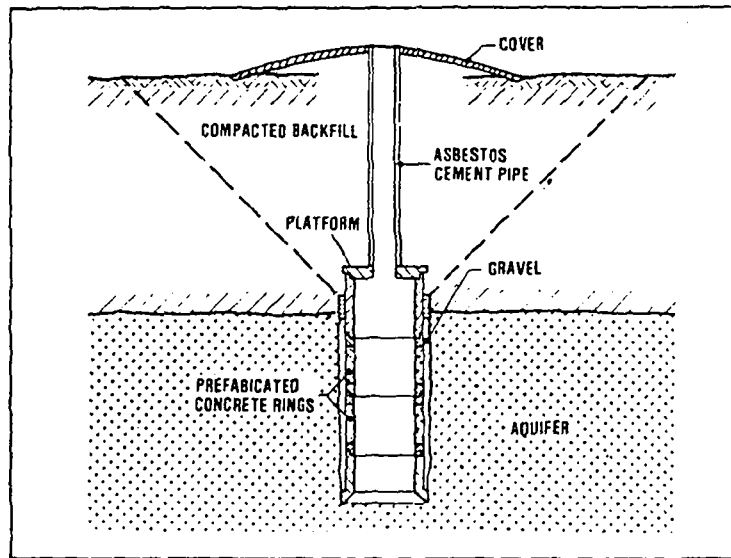

Fig. 28 'b' Dug well construction using a combination of methods

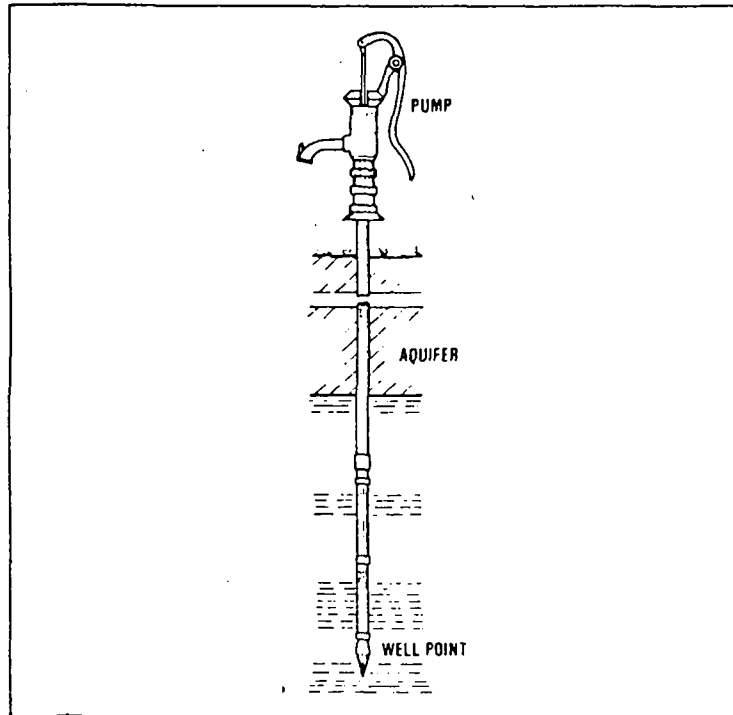

Fig. 29 Driven well

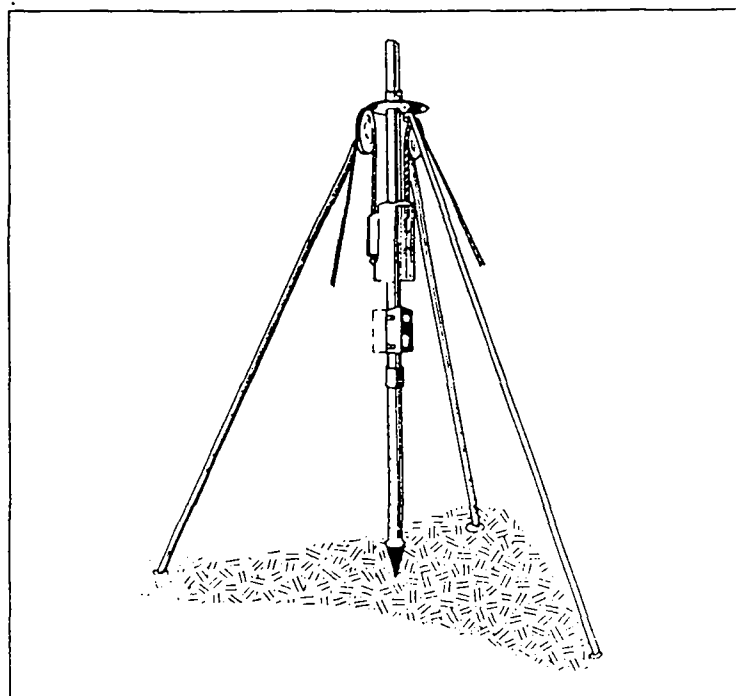

Fig. 30 Well driving arrangement

Figure 31 is an example of a well driving method with an inside drive bar which falls free inside the screen. Here instead of driving the pipe, it is pulled into the ground so that the pipe of normal strength can be used.

Figure 32 is also another example of driven wells where a sliding joint has been used so that clogging of the well screen can be prevented.

(ii) Jetted wells: These are similar to driven wells except that the point at the lower end of the screen is hollow instead of solid, and the well is bored through the erosive action of a screen of water jetting from the point (Figure 33).

Jetted wells have the following advantages over driven wells:

- These are much faster.
- Instead of steel, plastic can be used for casing and strainer as mechanical force is not needed for these wells.
- These wells can only be sunk in unconsolidated formations.
- A simple process to check underground formation beforehand by washing the washing pipe to the desired depth (Figure 34).
- Clogging of the well screen openings is no problem.

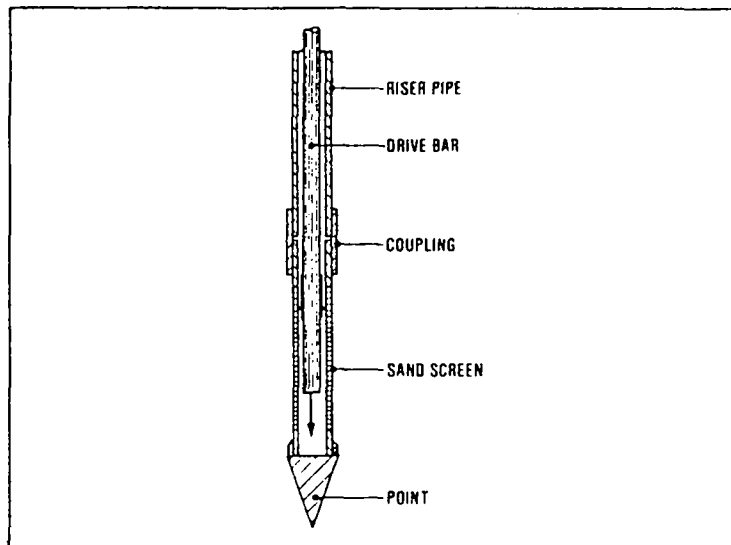

Fig. 31 Well driving with inside drive bar

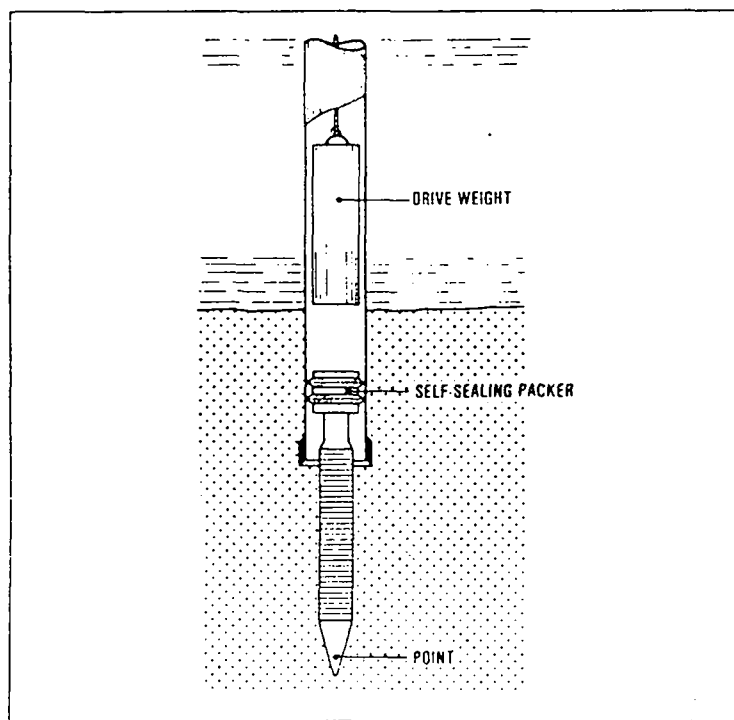

Fig. 32 Well drive point with sliding joint

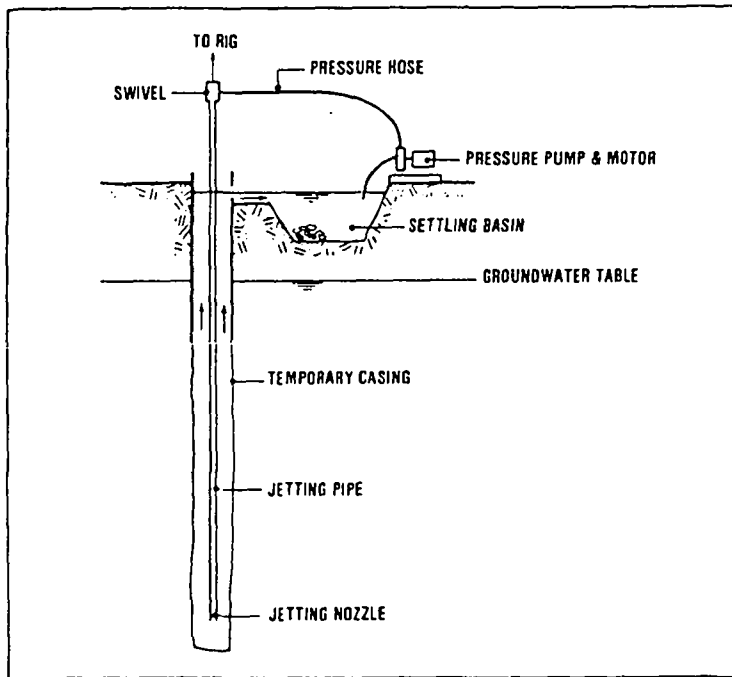

Fig. 33 Well jetting

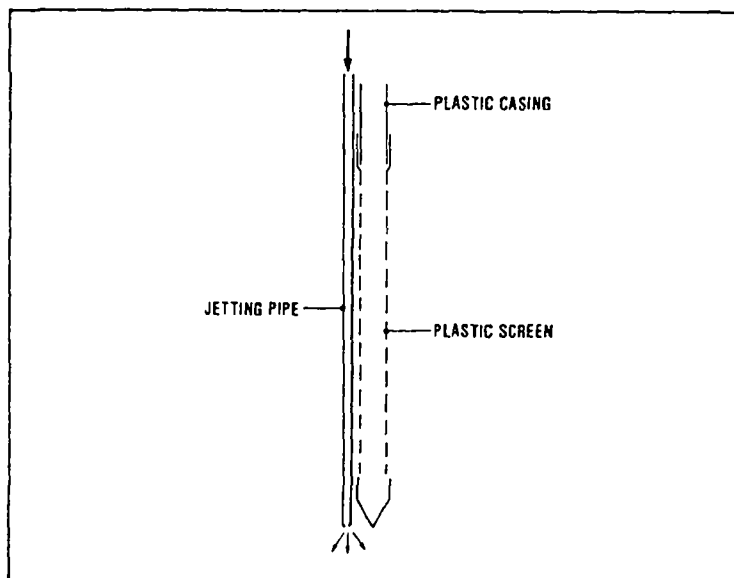

Fig. 34 Well jetting with an outside jet pipe

III. Surface Water Intake

1. River water intake: A river water intake can be sited at any suitable point where water can be withdrawn sufficiently since the quality of the water does not usually differ much across the width and depth of the river bed. One should design the river water intake in such a way that both clogging and scouring will be avoided and its stability should be secured even under flood conditions.

Figure 35 is an example of a river water intake which is unprotected. If the river transports no boulders or rolling stones that will damage the intake, such unprotected intakes may be sufficient.

Intake structures as shown in Figure 36 is suitable where intake protection is necessary. To prevent the entry of any boulders and rolling stones, the bottom of the intake structure should be at least 1 m above the river bed.

Figure 37 is an example of a river water intake using a suction pump. If the variation between the high and low level of water in the river is not more than 3.5-4 m, use of this pump may be sufficient.

If in case the required pumping head exceeds 3.5-4 m, it is better to construct a sump in the river bank where water is collected with infiltration drains laid under the river bed (Figure 38). The water flows into the sump under gravity. The water from the sump is usually drawn with a submersible pump, or a spindle-driven pump (positioned down the sump as shown in the Figure 38) as the lowest water level in the sump will probably be too deep for a suction pump placed above the ground.

2. Lake water intake: Lakes can be deep as well as shallow. In case of deep lakes, the intake of water for water supply should preferably be 3-5 m below the surface. The reason for this is that deep lakes containing water with a high nutrient show a great difference in water quality at different depths and the water should be withdrawn from the upper layer with the highest oxygen content (Figure 39). However, if the nutrient content in lakes is less, water from the deeper strata has the advantage of practically constant temperature for water supply purpose.

In shallow lakes to avoid the entrance of silt, the intake should be sufficiently high above the lake bottom (Figure 40).

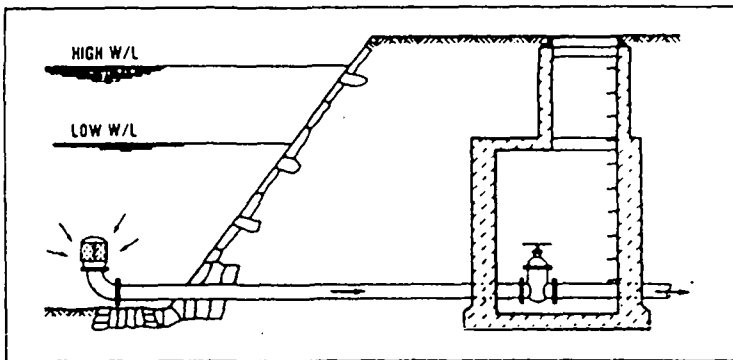

Fig. 35 Unprotected river intake

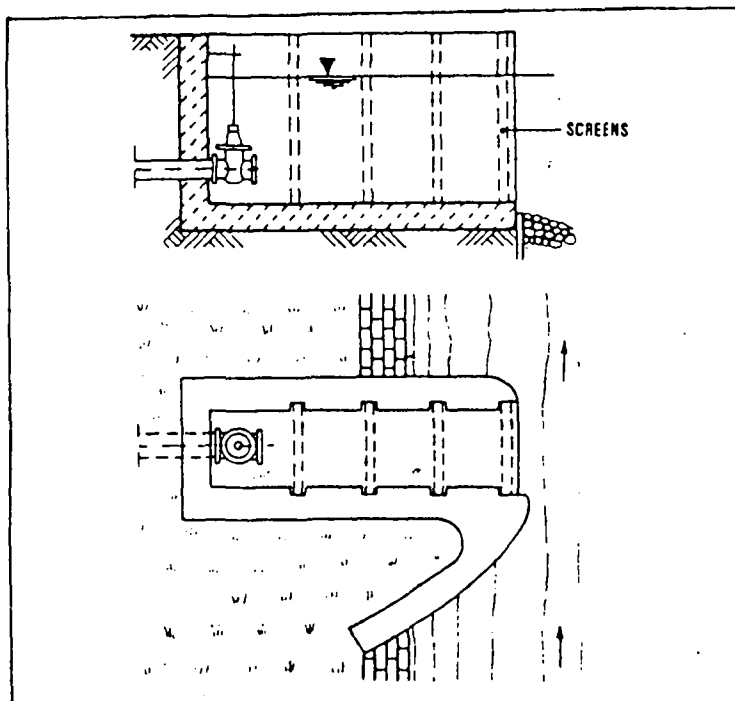

Fig. 36 River intake structure

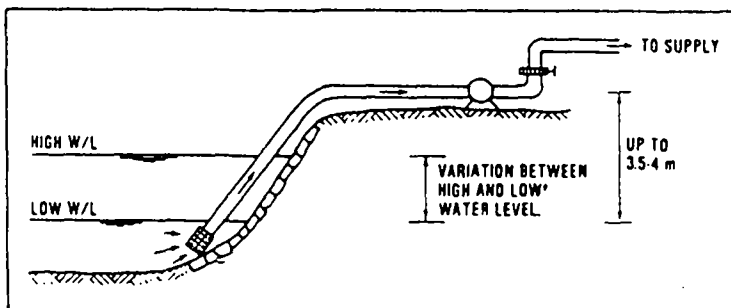

Fig. 37 Pumped river water intake

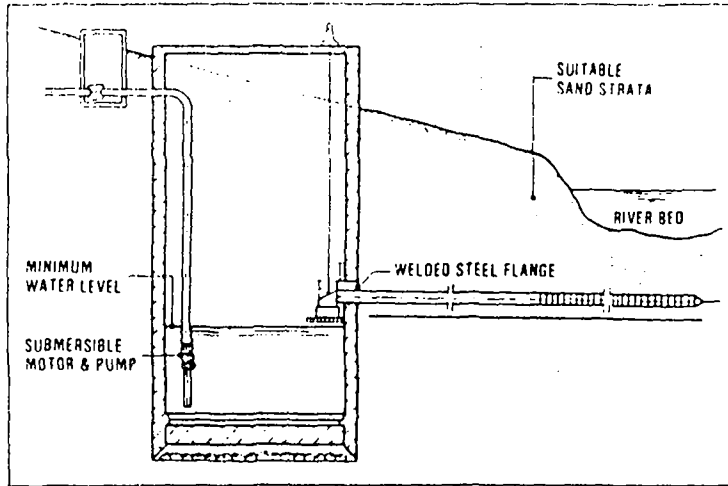

Fig. 38 Bank river intake using infiltration drains

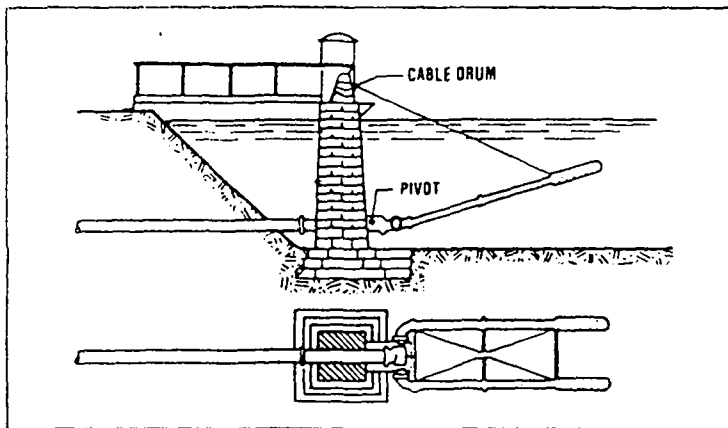

Fig. 39 Variable depth lake water intake

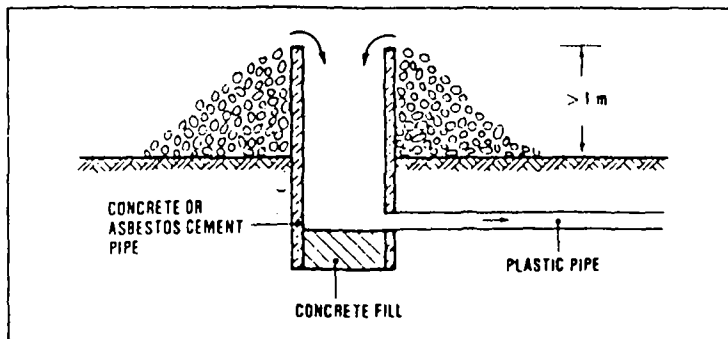

Fig. 40 Intake structure at bottom of shallow lake

For small community water supply the quantity of water needed is less and therefore, construction of a small capacity intake is sufficient. Figure 41 is an example of construction of such intake with simple arrangements using flexible plastic pipes.

Similarly, another type of intake construction using a floating barrel to support the intake pipe, is shown in Figure 42 where the water is pumped from the well sump.

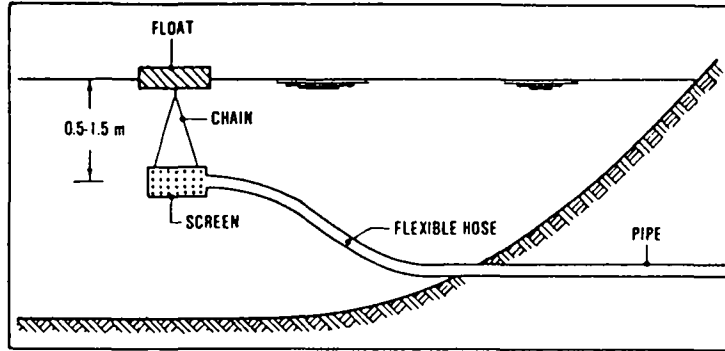

Fig. 41 Simple water intake structure

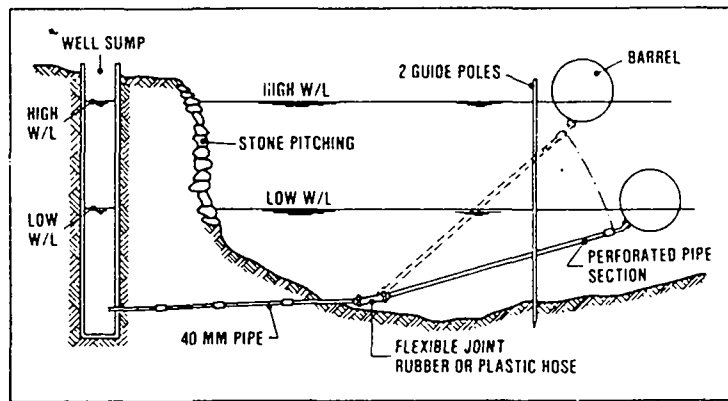

Fig. 42 Float intake

IV. Pumps used in Water Supply

In small community water supply, pumps are used for: (i) pumping water from wells; (ii) pumping water from surface water intake; and iii) pumping water into storage reservoirs and the distribution system, if any.

The power required for the operation of pumps may be human power (e.g. hand pump), animal power, windpower, electric motor and diesel engine. However, pumps based on human power (i.e. hand pumps), and electric motor and diesel engine (often called power pumps) are widely used for community water supply. On the basis of the mechanical principles involved, pumps may be classified as follows: reciprocating, rotary, diaphragm, axial-flow, centrifugal, air lift etc. Characteristics of the various types of pumps have been presented in Table 1. A short description of the above mentioned pumps under the heading of hand pumps and power pumps are presented below.

1. Hand pumps: A hand-operated reciprocating lift pump used in shallow well is shown in Figure 43. Here 'B', the body of the pump contains a valve plunger or piston which moves up and down (i.e. reciprocates).

Similarly, Figure 44 represents a deep well reciprocating lift pump which operates in the same manner as the previous one. The main difference is in the location of the cylinder. In order to prevent loss of priming, the cylinder is usually submersed in the water.

Figure 45 illustrates reciprocating force pumps which are mainly designed to pump water from a source and to deliver it to a higher elevation or against pressure (e.g. reservoirs and pressure tanks). These pumps are available for use on both shallow and deep wells. In Figure 45, 'A' represents a shallow well force pump and 'B' represents a deep well force pump.

A diaphragm pump is another pump which is widely used as an automotive fuel pump. Here the liquid is drawn in through the inlet valve as the diaphragm is lifted (Figure 46) and the liquid is forced out at the right when the diaphragm is depressed.

Pumps which employ high speed rotors within a fixed casing or stator are commonly called rotary pumps. Figure 47 is an example of a rotary pump which consists of two rotating gears meshed together in a housing with close clearances. Power is applied to only one of the gears, which in turn drives the other gear. Hand operated rotary pumps are often used for emptying oil drums and tanks. Figure 48 represents a semi-rotary pump used in water supply. Another rotary pump, the helical rotary, consists of a single thread helical rotor turning within a double thread helical stator (Figure 49).

Table 1
Information on types of pumps

Type of Pump	Usual depth range	Characteristics and Applicability
1. RECIPROCATING (plunger)		low speed of operation; hand, wind or motor powered; efficiency low (range 25 - 60%)
a. Suction (shallow well)	up to 7 m.	capacity range: 10-50 l/min; suitable to pump against variable heads; valves and cup seals require maintenance attention.
b. Lift (deep well)		
2. ROTARY (positive displacement)		low speed of operation; hand, animal, wind powered;
a. Chain and bucket pump	up to 10 m.	capacity range: 3-30 l/min. discharge constant under variable heads.
b. Helical rotor	25 - 150 m. usually submerged	using gearing; hand, wind or motor powered good efficiency; best suited to low capacity - high lift pumping.
3. AXIAL - FLOW	5 - 10 m.	high capacity - low lift pumping; can pump water containing sand or silt.
4. CENTRIFUGAL		high speed of operation - smooth, even discharge; efficiency (range 50-85%) depends on operating speed and pumping head.
a. Single-stage	20 - 35 m.	requires skilled maintenance; not suitable for hand operation; powered by engine or electric motor.
b. Multi-stage shaft-driven	25 - 50 m.	as for single stage. Motor accessible, above ground; alignment and lubrication of shaft critical; capacity range 25 - 10,000 l/min.
c. Multi-stage submersible	30 - 120 m.	as for multi-stage shaft-driven; smoother operation; maintenance difficult; repair to motor or pump requires pulling unit from well; wide range of capacities and heads; subject to rapid wear when sandy water is pumped.
5. AIR LIFT	15 - 50 m.	high capacity at low lift; very low efficiency especially at greater lifts; no moving parts in the well; well casing straightness not critical.

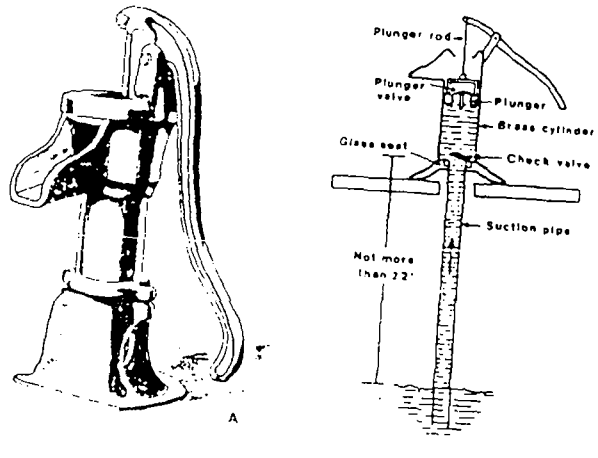

Fig. 43 Typical shallow well lift pump

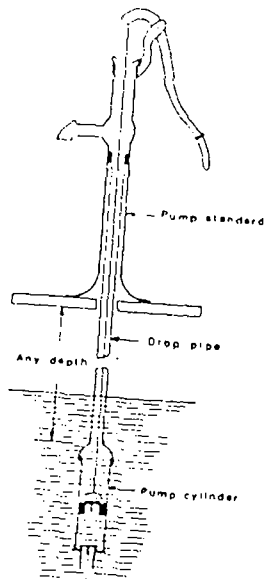

Fig. 44 Deep well lift pump

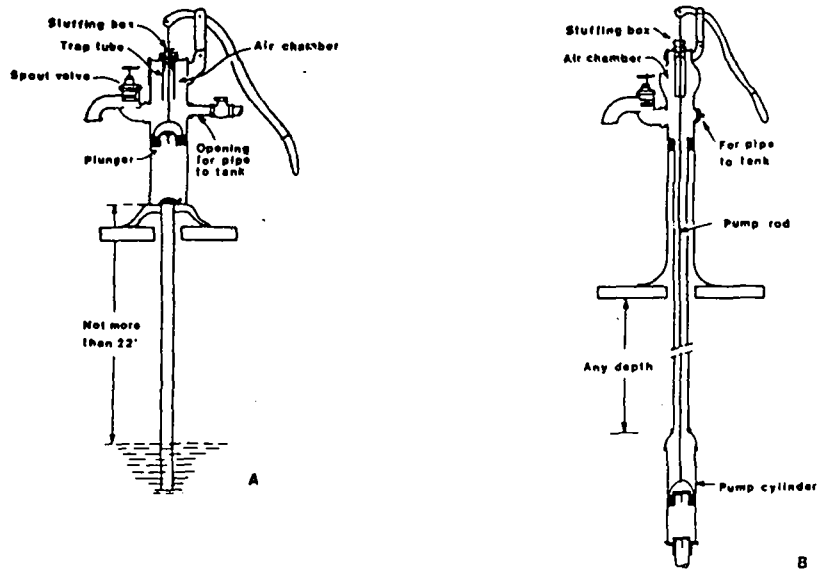

Fig. 45 Reciprocating force pumps

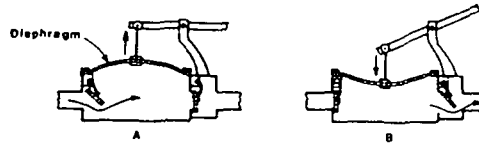

Fig. 46 Cross-section of a diaphragm pump

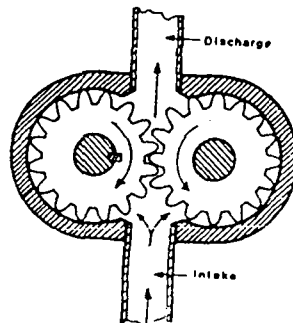

Fig. 47 Cross-section of a rotary pump

Figure 50 is an example of bucket pump which is also used in the field of water supply. Small buckets attached to an endless chain are rotated over sprockets so that each bucket dips from the source at the bottom, carries it to the top, and empties it into the spout as it passes over the top sprocket.

Chain pump is also used in the field of water supply, mainly on cisterns and dug wells. In this pump, rubber discs attached to an endless chain running over a sprocket at the top are pulled upward through a pipe to lift water mechanically upto the spout. Figure 51 is an example of this pump.

Reciprocating hand pumps in use today represents the evolutionary, empirical products of over a century of design modifications. Many of them are copies of commercially successful pumps. A reciprocating hand pump nomenclature is shown in Figure 52. Although the nomenclature of hand pump varies widely by and even within countries, this nomenclature used herein is the common one. This pump nomenclature is composed of three main parts: (i) pump stand assembly (ii) pump cylinder assembly (iii) connecting assembly. In case of deep well, these three assemblies are separately located whereas in case of shallow wells the cylinder assembly and connecting rod may be located within the pump stand. These three component assemblies can be and often are purchased separately. As the result of hand pumps development suitable to the rural conditions of developing countries, a variety of hand pumps are presently available for use. Some of these pumps are presented below:

(i) Battle Hand Pump: This is a hand pump developed by Battle Memorial Institute-Columbus Laboratories as per the contract with USAID in 1966. The Battle pump for deep and shallow well configurations are presented in Figures 53 and 54 respectively. These pumps are in use in Thailand, Nigeria, Bangladesh, Ecuador, Honduras, Guatemala, The Philippines, Sri-Lanka, Tunisia, and also Dominical Republic, Indonesia and Nicaragua. The following advantages of these pumps have been reported: spare parts availability, easy maintenance, low cost, durability, employment creation, increase of local income and the reduction of the foreign exchange outflow.

(ii) New No. 6 Pump: This pump is a combination between the Battle pump and Maya No. 6 pump. It was implemented by UNICEF in Bangladesh. This hand pump is 15% lighter than the Battelle pump. Figure 55 is an example of this pump.

(iii) Hydro-Pompe Vergent: This pump is French made and has a novel operating mode. This pump is widely used in Africa. A schematic diagram of this pump is shown in Figure 56.

(iv) U. S. T. (Kumasi) hand pump: Since 1972, a hand pump suitable for local manufacture was developed at the University of Science and Technology, Kumasi, Ghana. This pump has been shown in Figure 51. Although preliminary testing has been carried out at depths upto 100 ft, testing is still in progress.

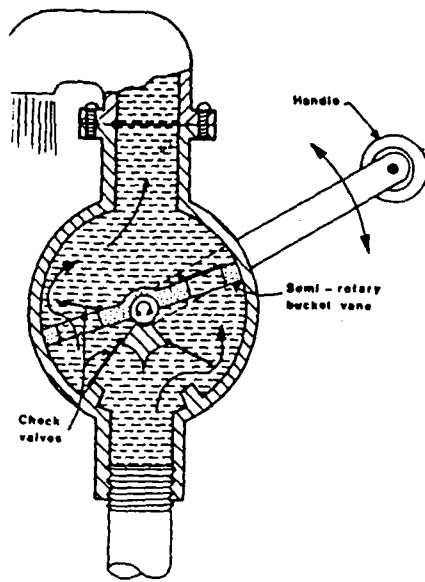

Fig. 48 Cross-section of semi-rotary pump

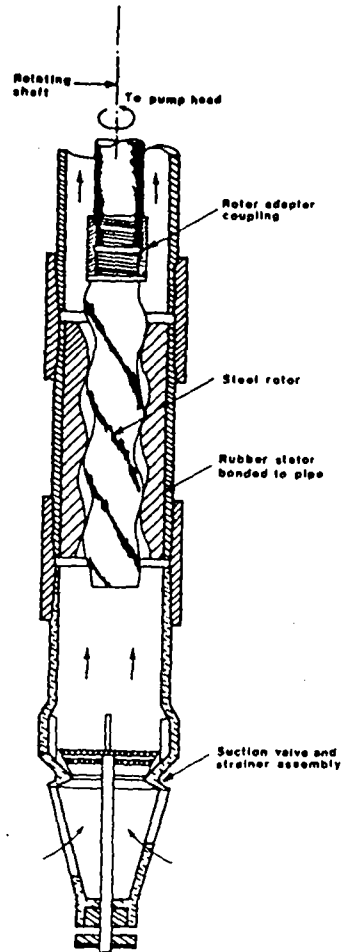

Fig. 49 Cross-section of helical rotor pump

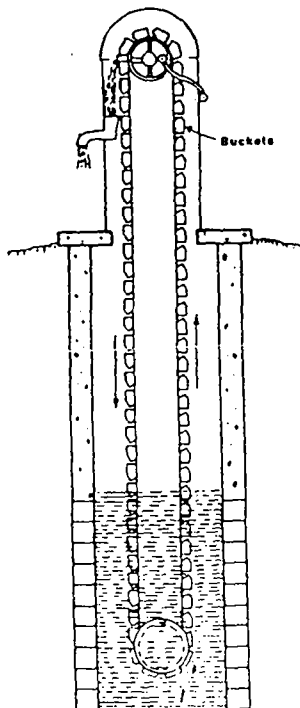

Fig. 50 Bucket pump

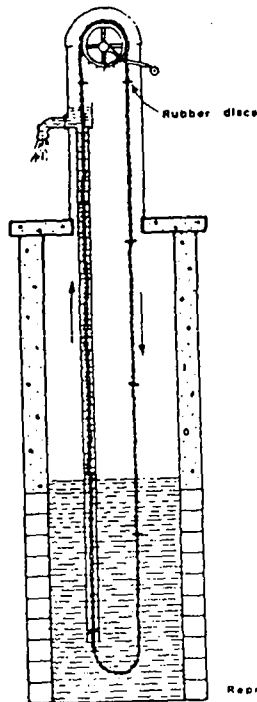

Fig. 51 Chain pump

Reproduced from WHO Monograph No 47

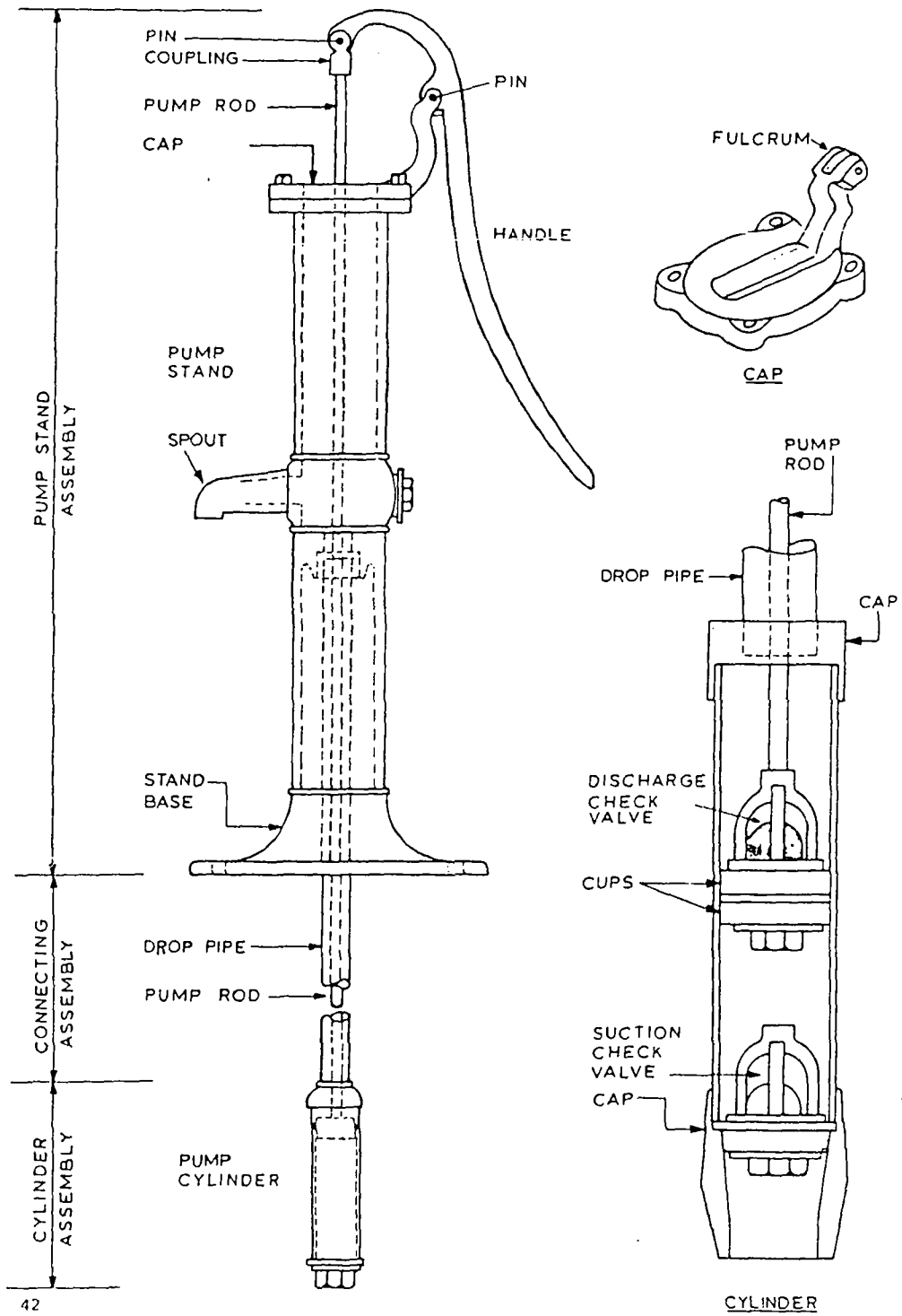

Fig. 52 Hand pump nomenclature

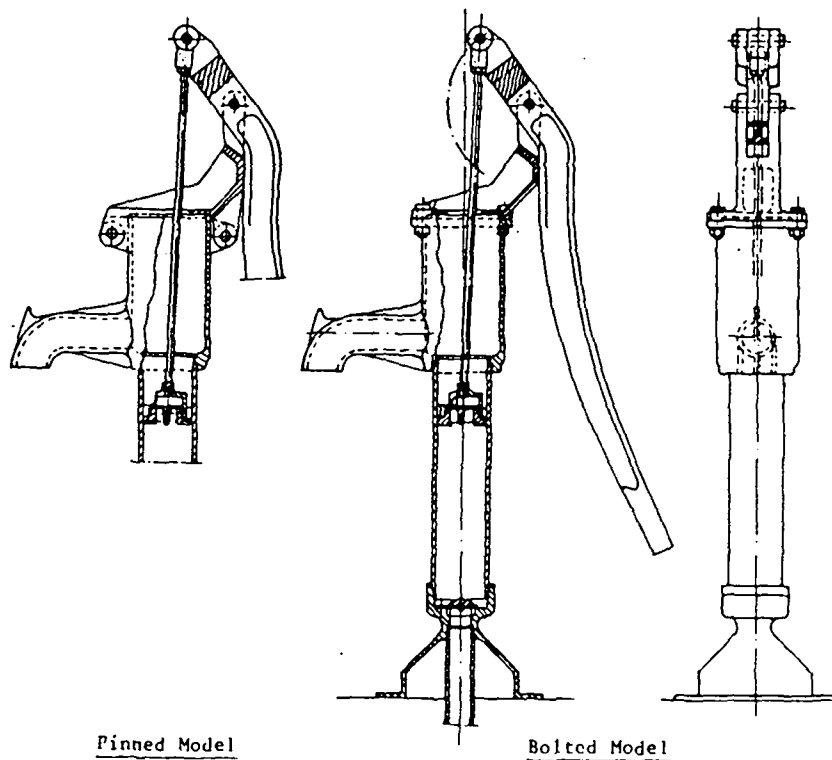

Fig. 53 Battle pumps - Shallow well configuration

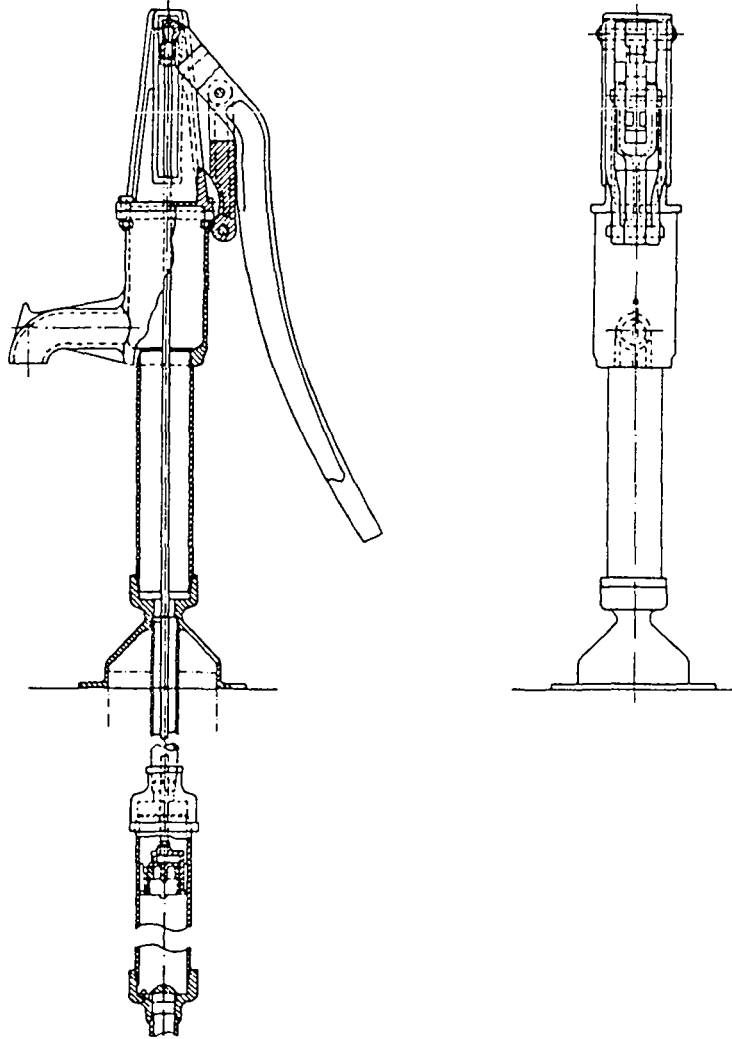

Fig. 54 Battle pump - Deep well configuration

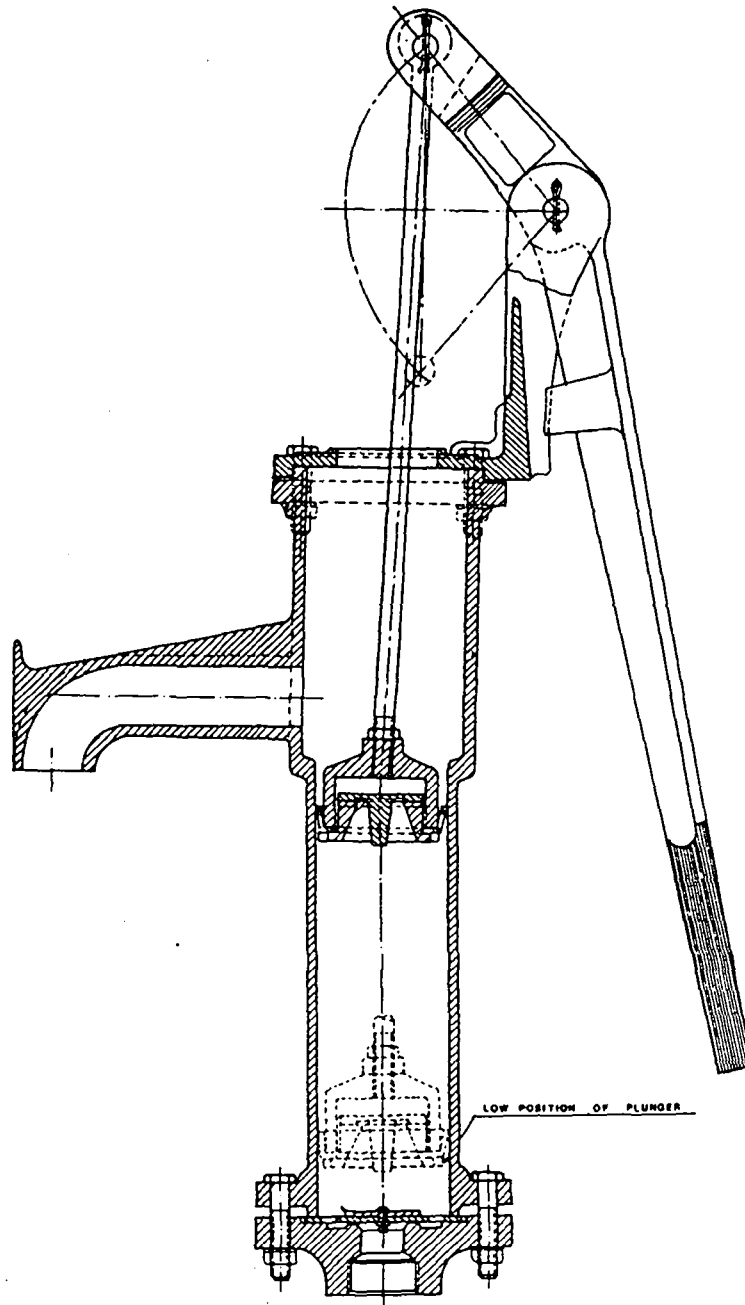

Fig. 55 New no. 6 pump (Bangladesh)

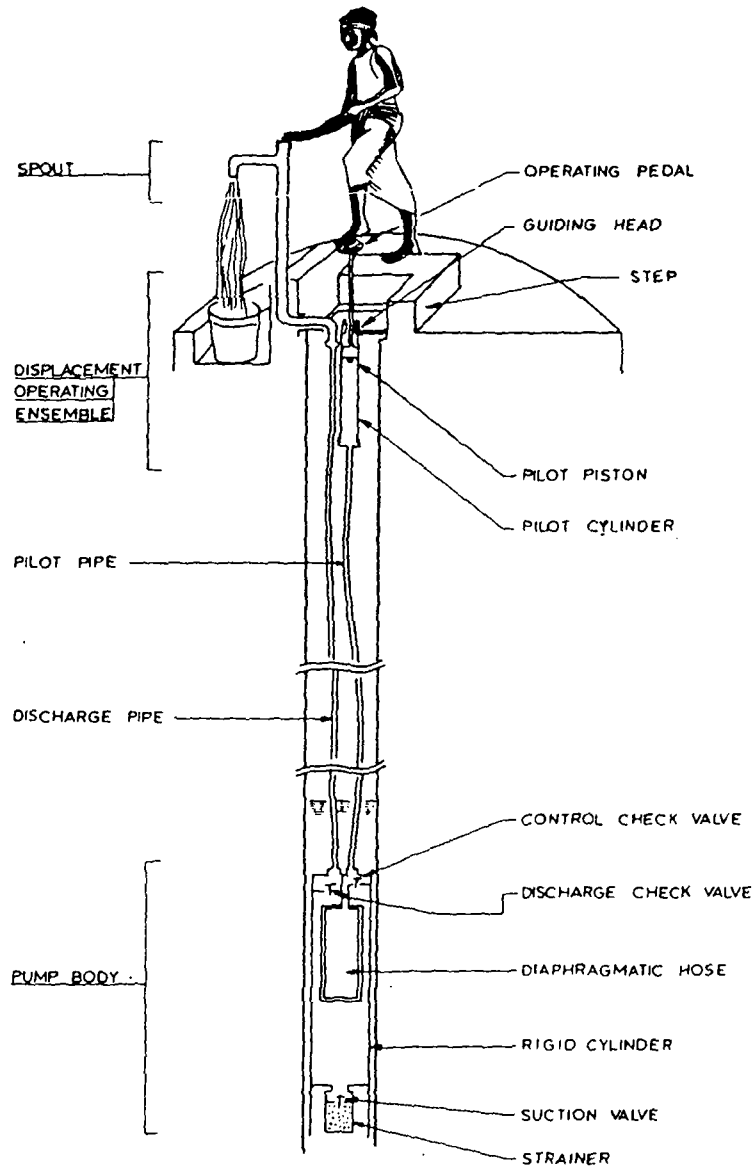

Fig. 56 Hydro - pompe Vergnet Schematic arrangement

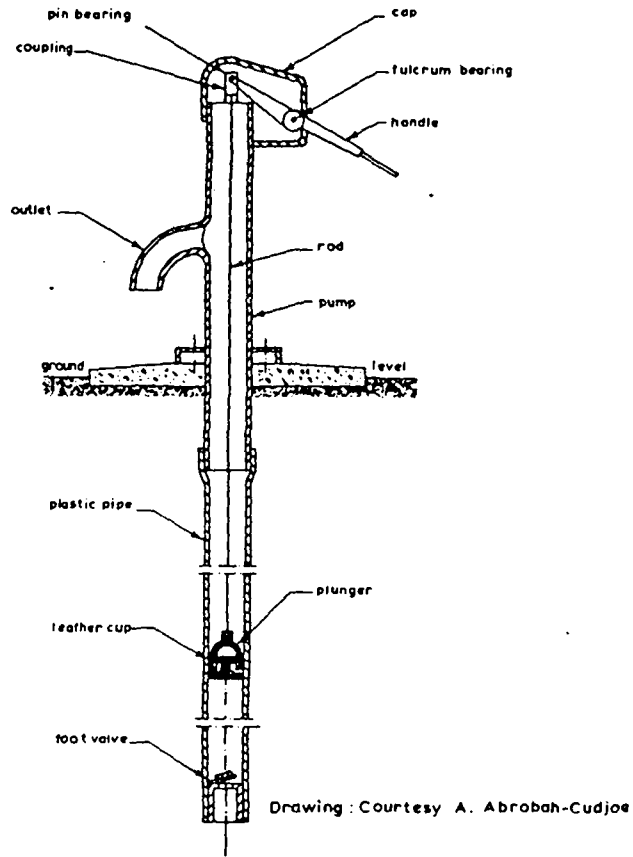

Fig. 57 U.S.T. (Kumasi) Hand pump

(v) The Petro Pump: This pump, a new variation of the diaphragm pump, is suitable for use in deep wells. This is a Swedish made pump (Figure 58) and at present two types of Petro pumps are commercially available.

(vi) PVC Plastic Pipe Pump: Hand pumps have also been made by using PVC pipes. The handle of this pipe is made of wood or bamboo. Figure 59 is an example of such a pump. Although the pump has been considered to be quite economical, this pump has still not been produced in large scale. pump in large scale is still untested.

(vii) India Mark II Hand Pump: It is a deep well type hand pump (Figure 60) manufactured in New Delhi, India. The pump consists of three major assemblies: pump head assembly, cylinder assembly, connecting rod assembly. This pump has the advantages of easy handling, durability, economy, easy availability of spare parts, productivity etc. This pump has been used in many Asian and African countries like Bangladesh, Burma, India, Indonesia, Phillipines, West Indies, Benin, Ethiopia, Kenya, Botswana, Zaire, Volta etc.

(viii) Kangaroo Pump: This is a Tanzanian pump (Figure 61) which operates with a vertical movable pump head and is used for different depths: pump with a four inches cylinder upto a depth of approx. 6 m, pump with a three inches cylinder upto a depth of approx. 10 m and pump with a two inches cylinder upto the depth of approx. 20 m.

2. Power Pumps: They include pumps which use electric motor and/or diesel generator. Such pumps are important if a large quantity of water has to be withdrawn from a considerable deep well. A few of these such pumps are introduced below:

Figure 62 is a two stroke reciprocating well pump used for the withdrawl and supply of groundwater to a overhead tank.

A centrifugal pump used in the area of water supply is shown in Figure 63. The main components of such a pump are an impeller and a casing.

A vertical spindle motor for driving the multistage bore-hole pump (Figure 65) necessary to withdraw a large quantity of water from a deep well is shown in Figure 64. motor is also shown in Figure 65.

Figure 66 represents a helical pump which consists of a single thread helical rotor which rotates inside a double thread helical sleeve (stator). Helical pumps are available for use in 10 cm or larger tube wells and used largely in parts of Asia and Africa where they are known as 'Mono' pumps after the British Manufacturer.

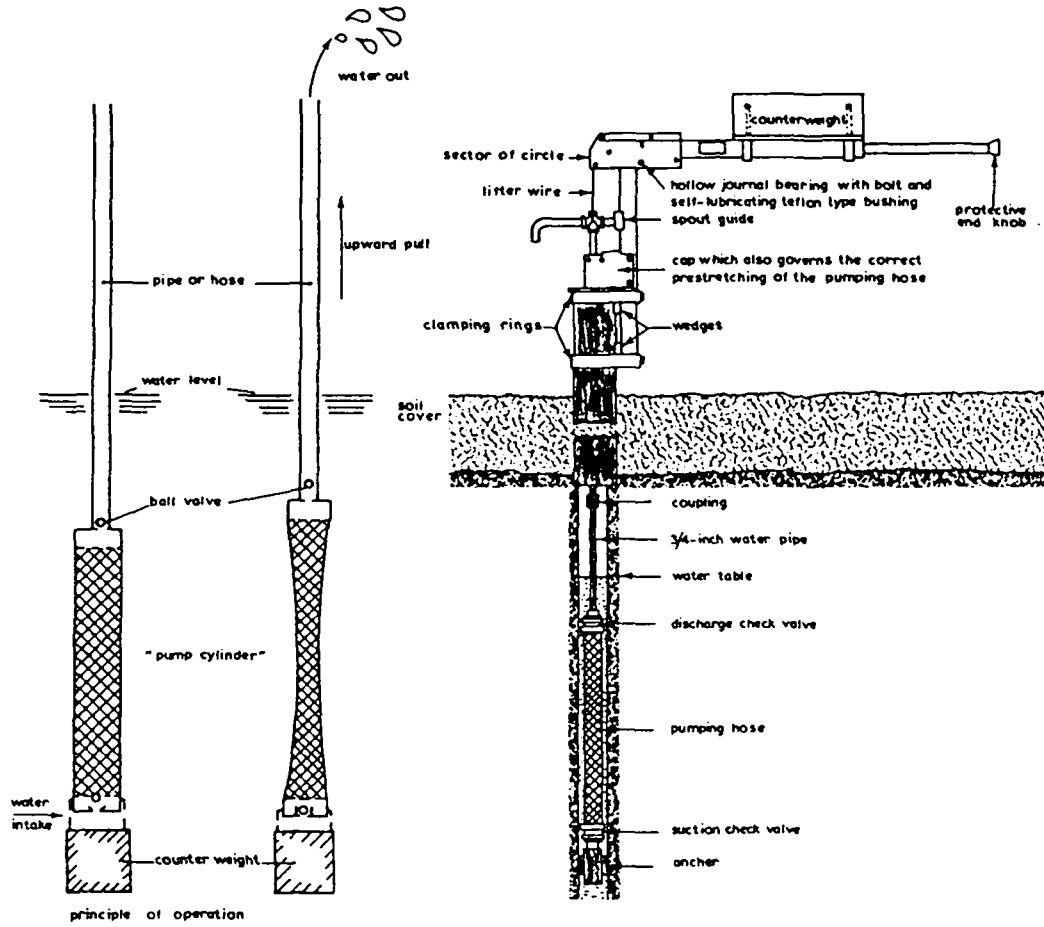

note: alternative method for
fixing lower end of pump
cylinder to well casing
is by use of expanding
wedges or jaws

Fig. 58 The Petro pump

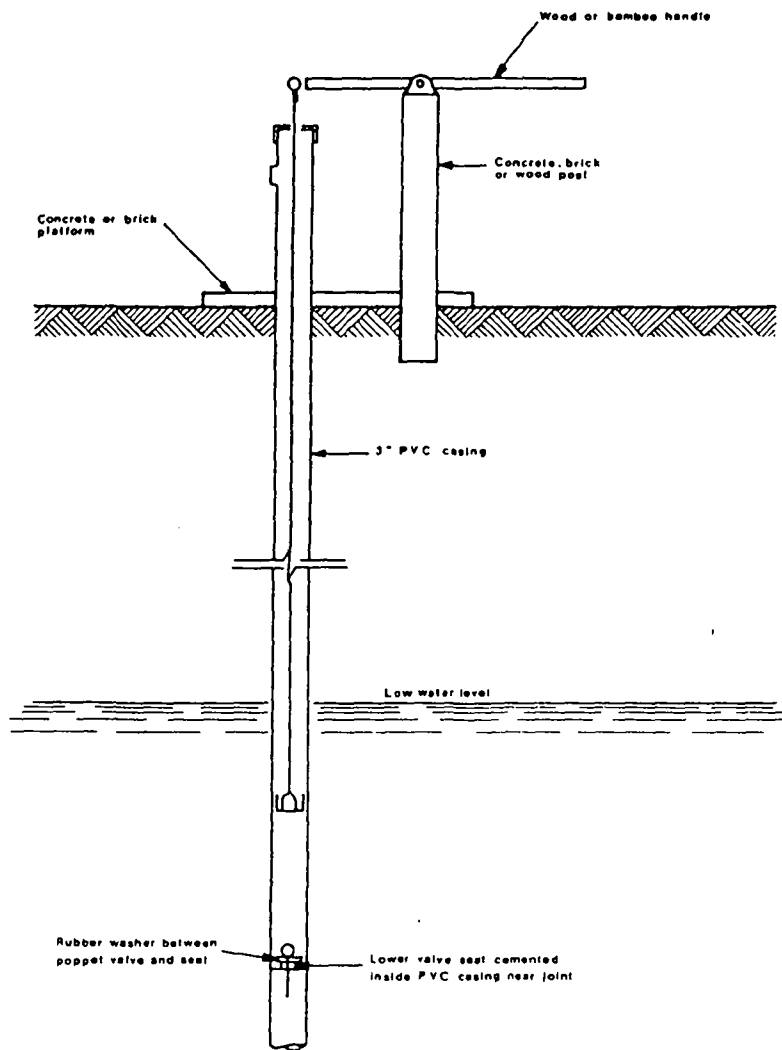

After: Spangler (VITA)

Fig. 59 Polyvinyl chloride (PVC) plastic hand pump

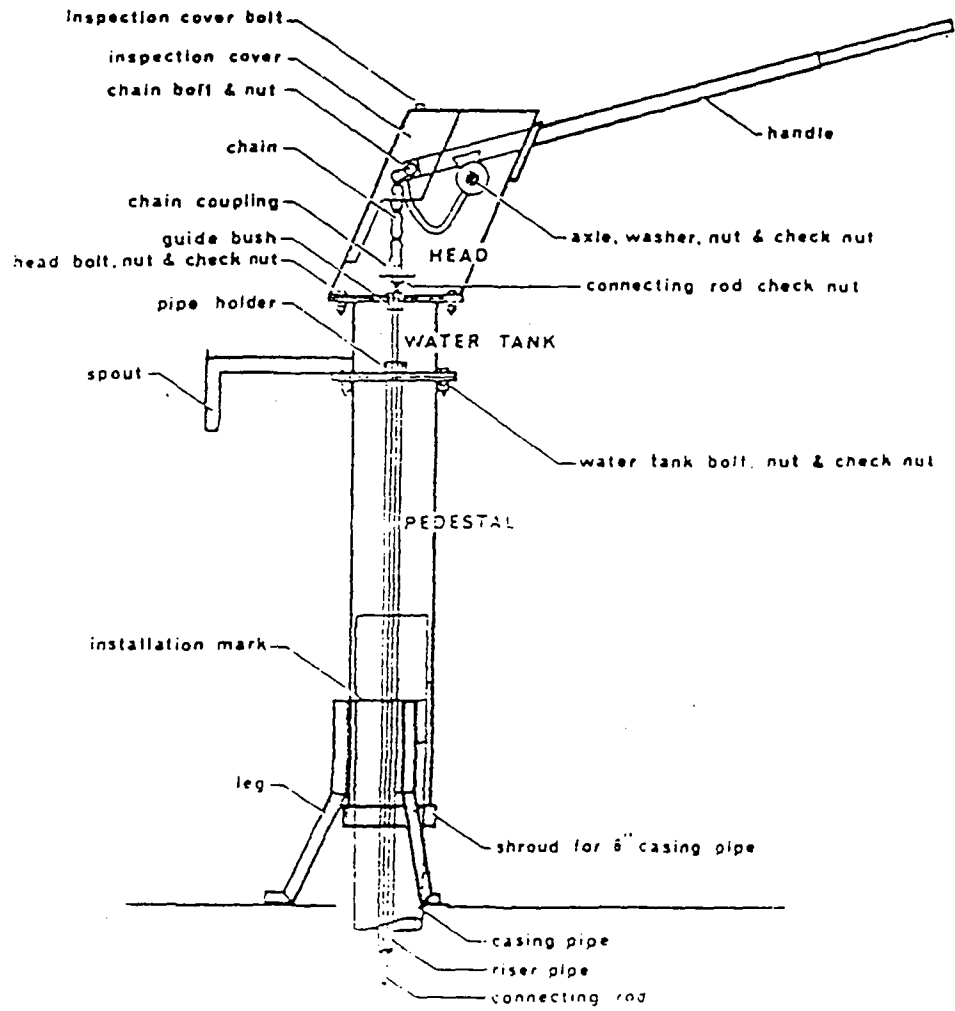

Fig. 60 India Mark - II Hand pump

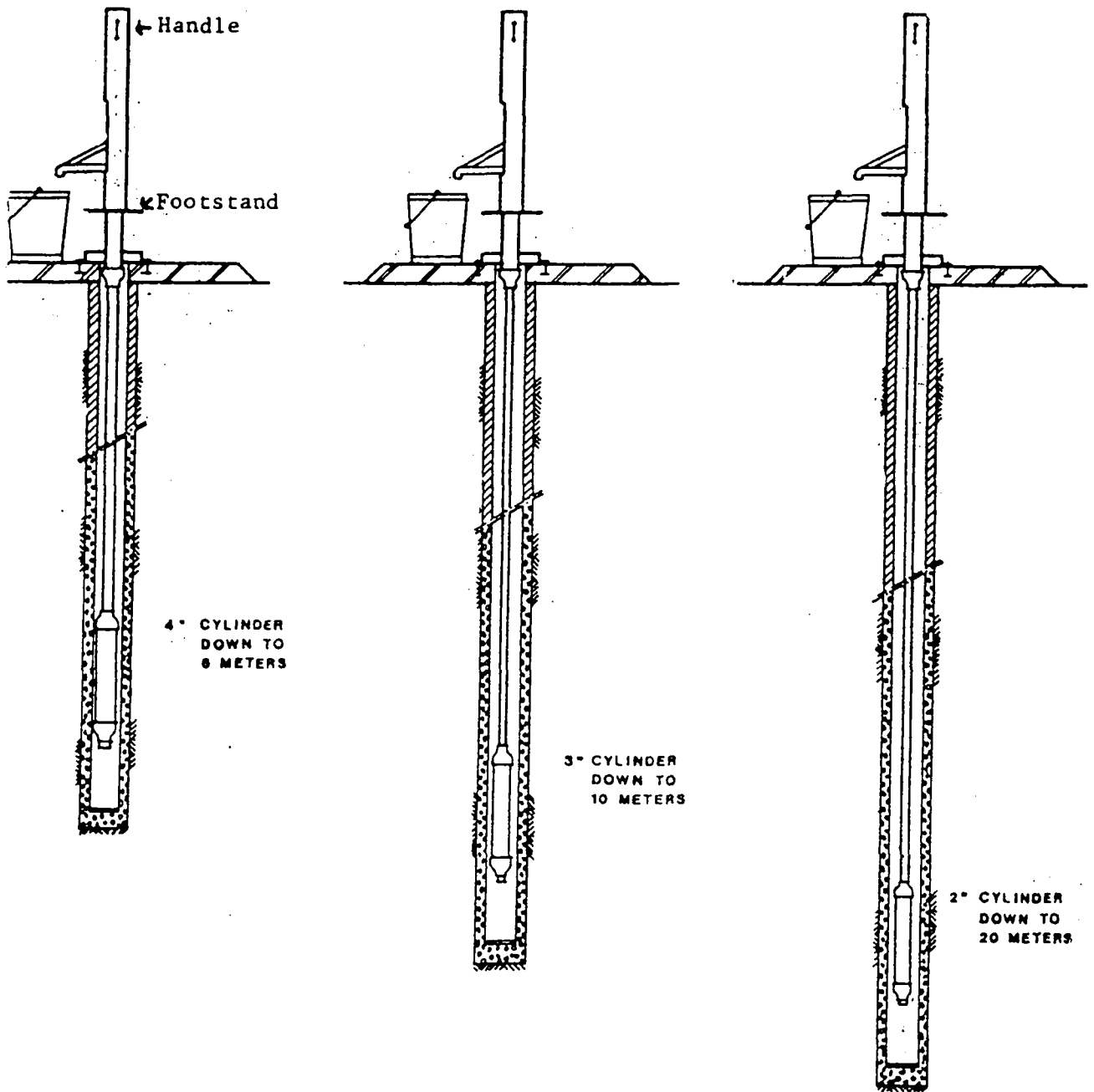

Fig. 61 The "Kangaroo" pump

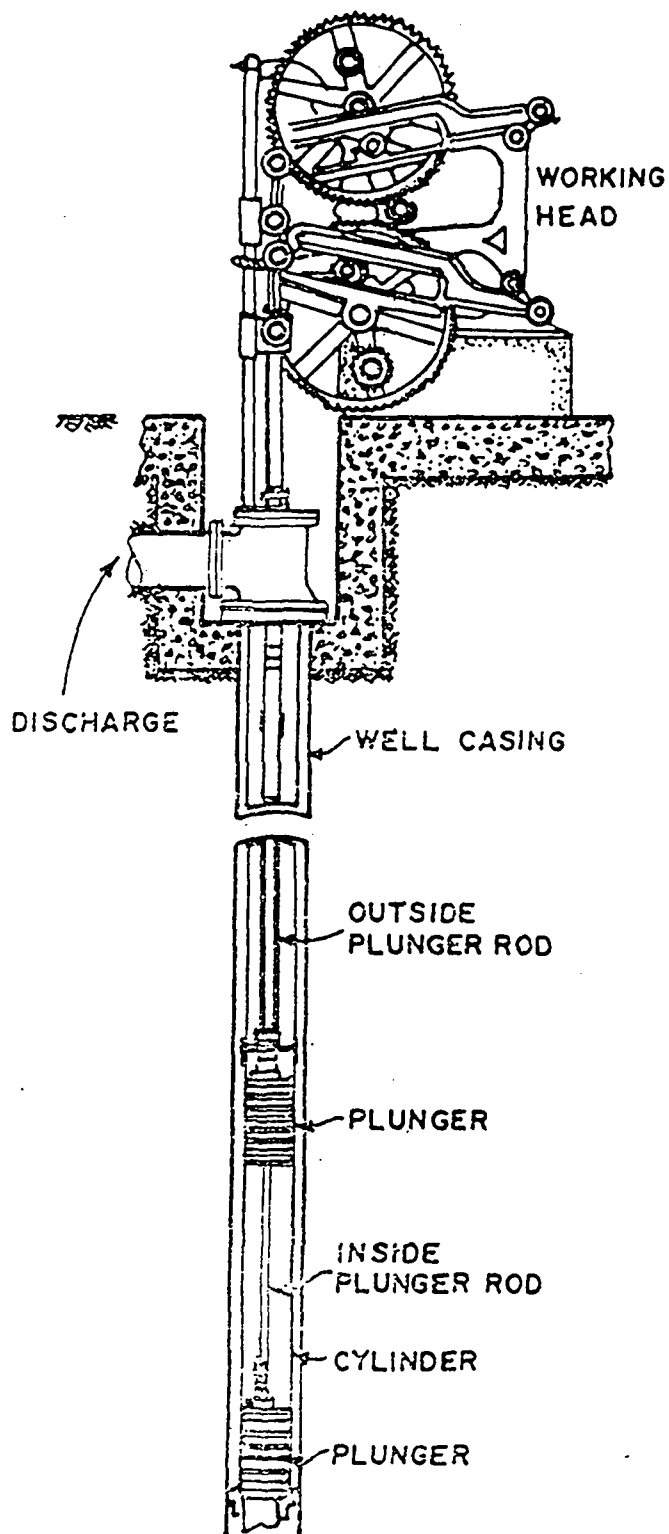

Fig. 62 The two stroke reciprocating type well pump

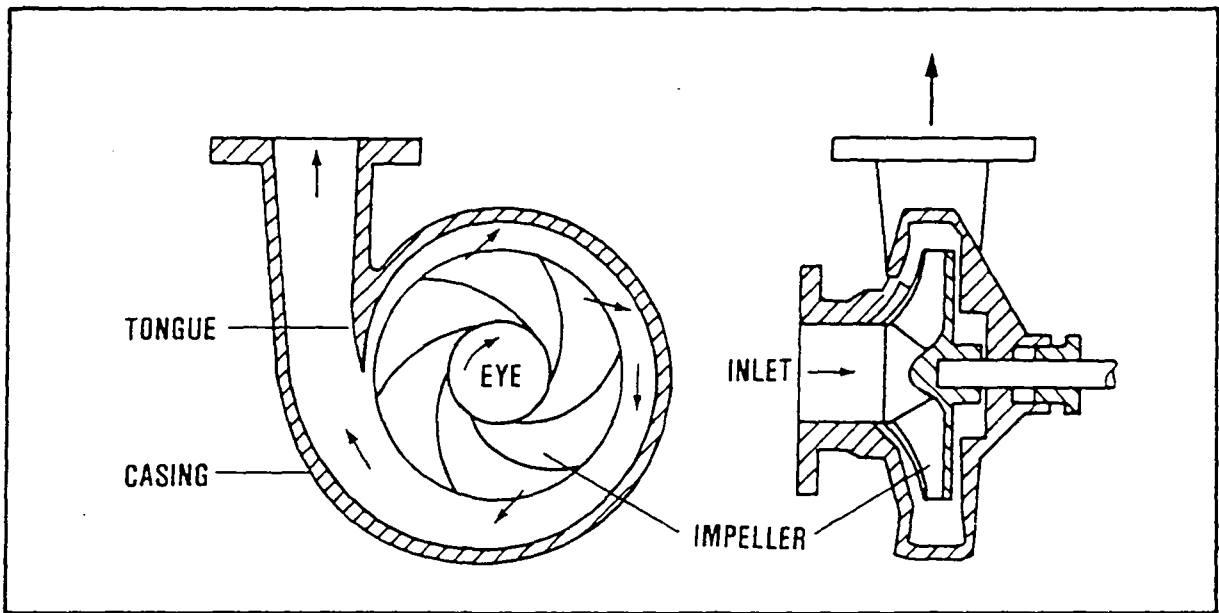

Fig. 63 Centrifugal pump (Volute-type casing)

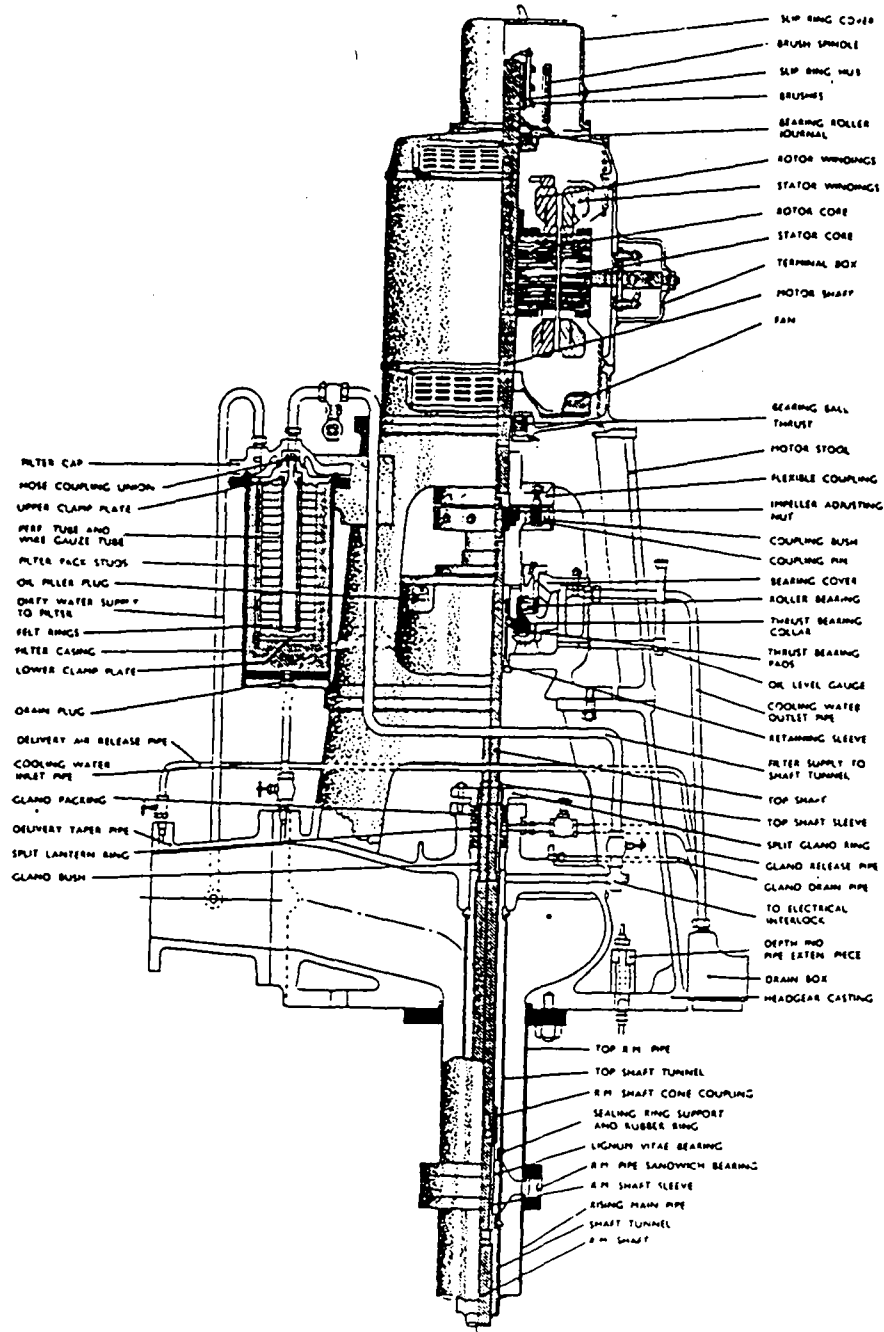

Fig. 64 Vertical spindle pump motor for driving the multistage bore-hole pump

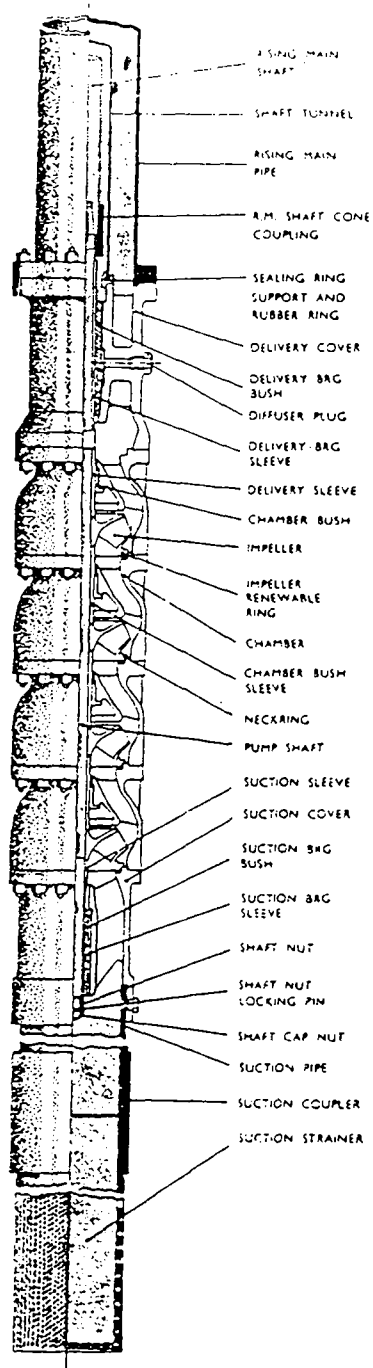

Fig. 65 Shaft driven multistage bore-hole pump
(Harland Engineering Co.Ltd.)

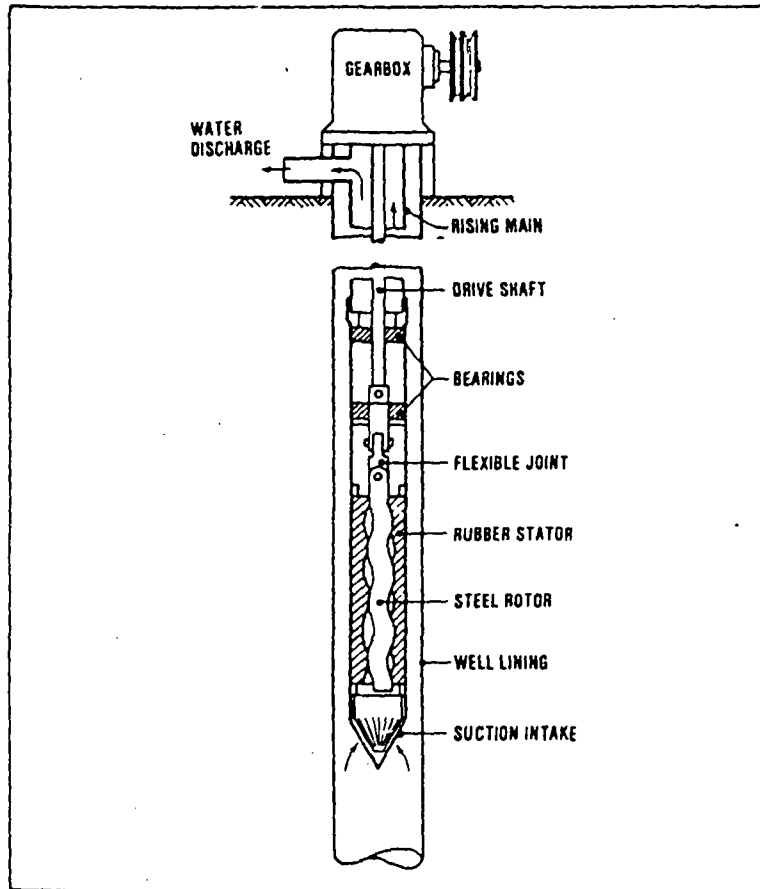

Fig. 66 Helical rotor pump

Similarly a shaft driven pump has been represented in Figure 67. Here crankshaft or motor is placed at the ground surface and powers the pump using a vertical drive shaft or spindle.

Figure 68 is an example of a centrifugal pump that is connected directly to an electric motor in a common housing with a pump and motor as a single unit and Figure 69 represents the exploded view of the submersible pump.

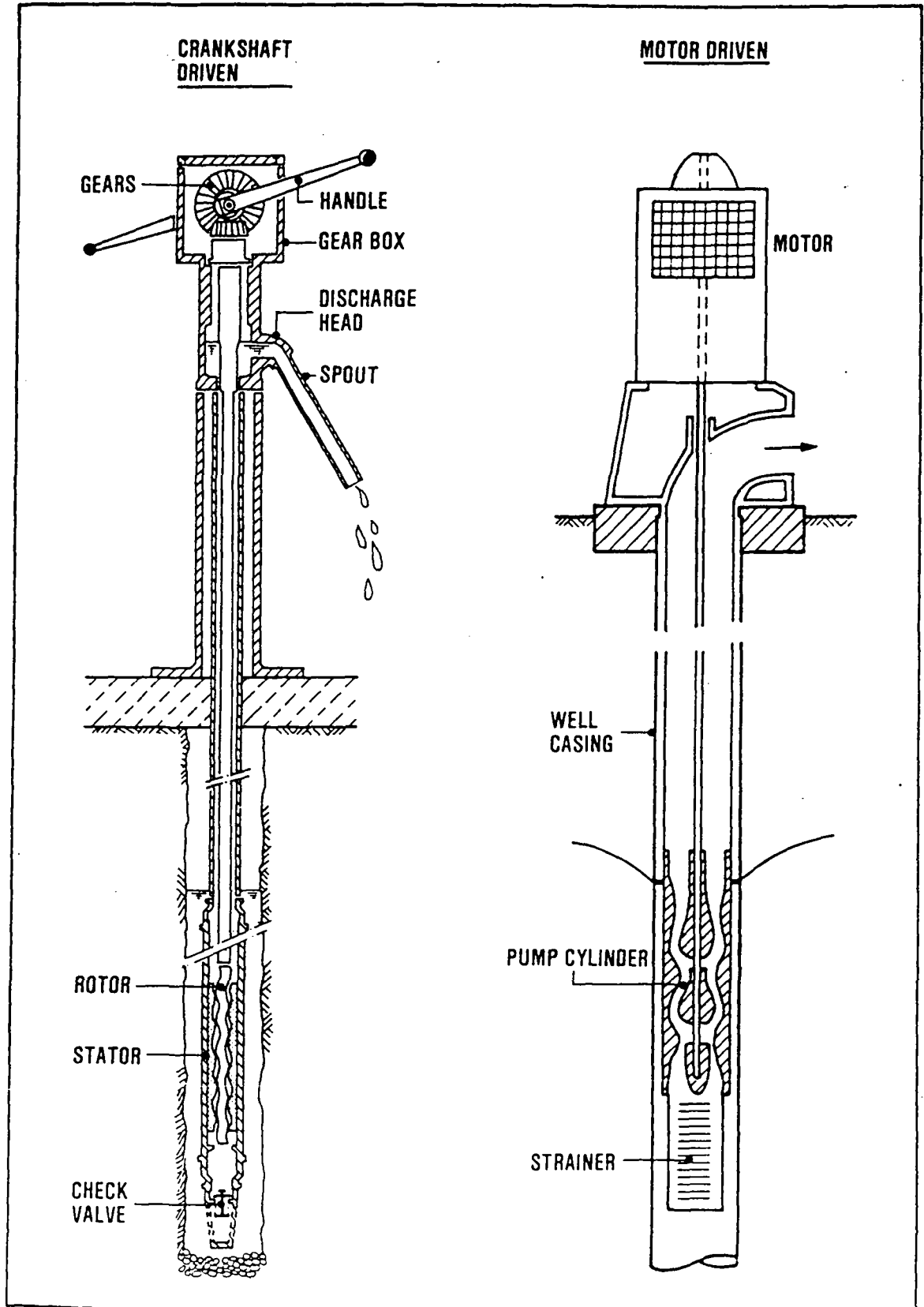

Fig. 57 Shaft-driven pumps

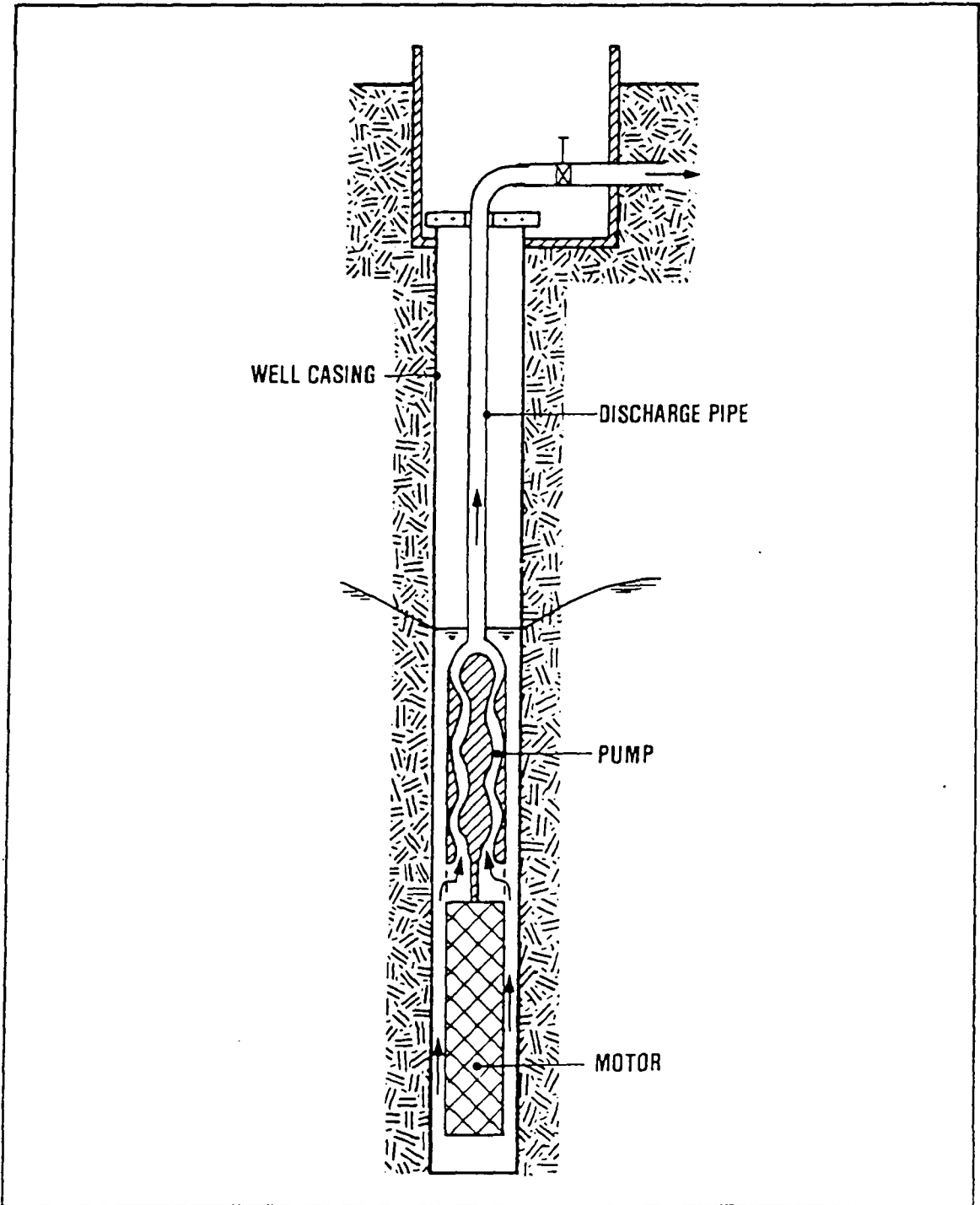

Fig. 68 Pumpdriven by a close-coupled submersible electric motor

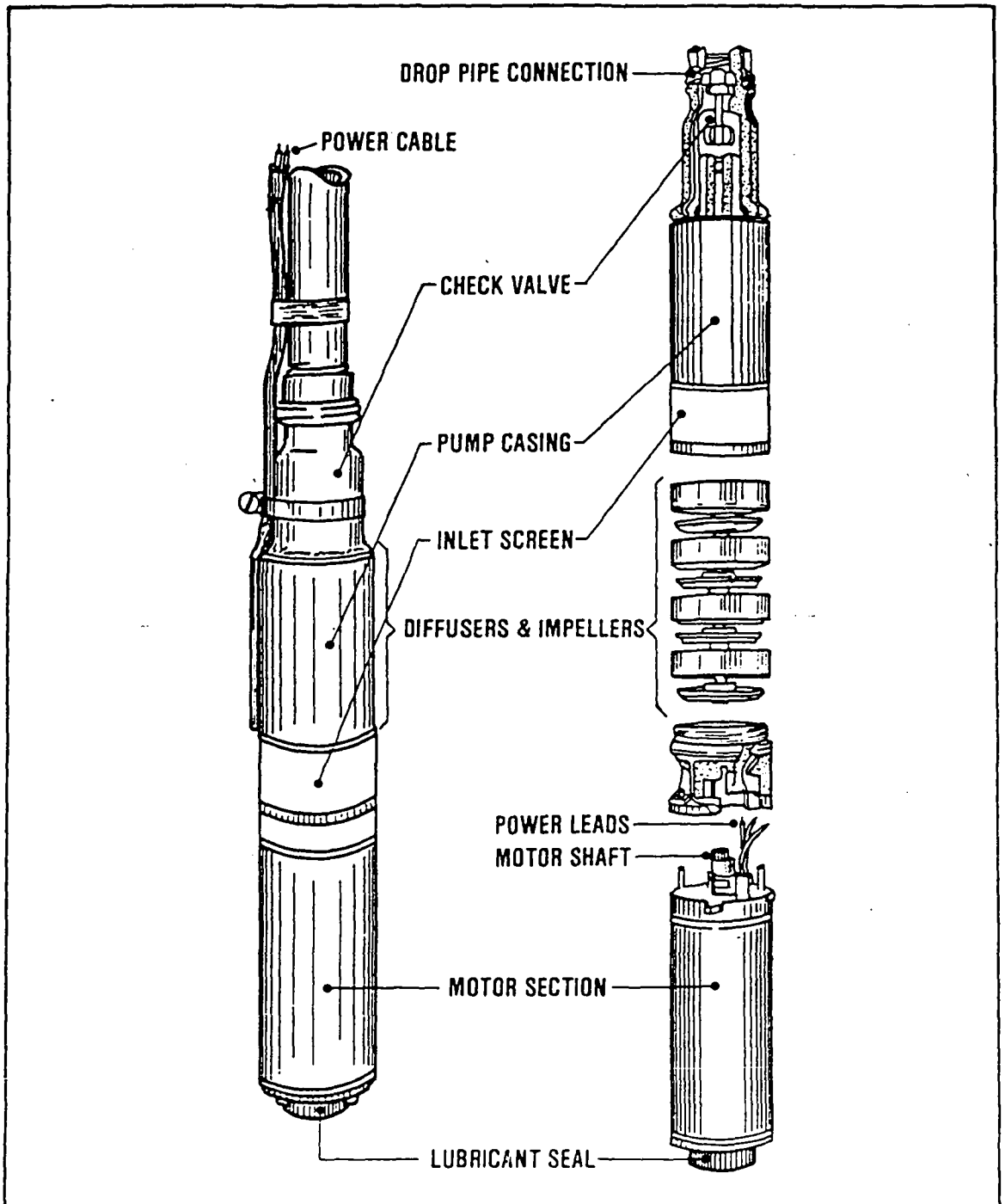

Fig. 69 Submersible pump (exploded view)

V. Aeration and Chlorination

1. Aeration: It is a treatment process whereby the water is brought into intimate contact with air with the objectives of: (i) increasing the oxygen content (ii) reducing the CO₂ content, and (iii) removing hydrogen sulfide, methane and various volatile or organic compounds and (iv) treating water which contains high iron and manganese.

Figure 70 provides a very simple and inexpensive arrangement of the multiple tray aerator which occupies little space. This type of aerator consists of 4 to 8 trays with perforated bottoms at intervals of 30 to 50 cm. Such trays can be made of any suitable material, like asbestos cement plates with holes, small diameter plastic pipes or parallel wooden slates.

Similarly, Figure 71 depicts a cascade aerator with similar features which consists of a flight of 4 to 6 steps, each about 30 cm high with a capacity of about 0.01 m³/s per meter of width. This aerator needs larger space than that for the tray aerator. But the overall head loss is lower in case of a cascade aerator.

A multiple platform aerator also uses the same principles. sheets of falling water are formed for full exposure of the water to the air as shown in Figure 72.

A hand-operated aeration/ filtration unit for the treatment of water having iron and manganese is shown in Figure 73.

Similarly, Figure 71 represents a section through the iron removal plant which has been widely used in the state of Orissa in India.

2. Chlorination: Disinfection of water provides for the destruction or complete inactivation of harmful microorganisms present in the water. In rural water supply, chlorination (use of chlorine as chemical disinfectant) is the simplest means of disinfection. However, disinfection by gaseous chlorine is not feasible for small community water supply as it is difficult to use small quantities of chlorine gas accurately and on a continuous basis. So the use of its compounds like bleaching powder or chlorinated lime is recommended.

Some simple chlorination methods for the disinfection of dug wells are:

(i) Pot Chlorinator is an earthen pot of 7 to 10 litre capacity with 6 to 8 mm diameter holes at the bottom. It is half filled with pebbles and pea gravel (20 to 49 mm size). Bleaching powder and sand (1:2 ratio) is placed on the top of the pea gravel and the neck (Figure 75a). The pot is then lowered into the well with its mouth open. For a well of 1000 to 2000 litre/day withdrawal capacity, a pot containing 1.5 Kg of bleaching powder should provide adequate chlorination for a week.

(ii) Double Chlorination Pot System is a unit consisting of two cylindrical pots one inside the other used for chlorination of small household wells as the single pot chlorinator may give too high a chlorine content to the water. Figure 75b is an example of the double pot chlorinator.

(iii) Drip Type Chlorinator (Figure 75c) is another type of chlorinator which is also used for disinfection of deep wells.

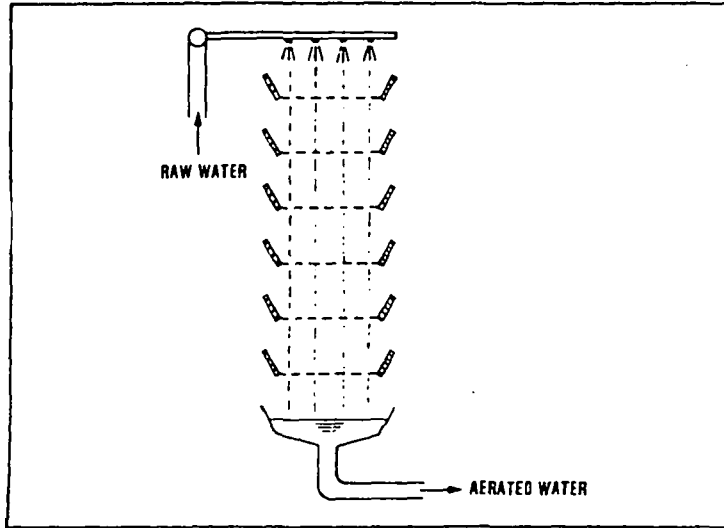

Fig. 70 Multiple-tray aerator

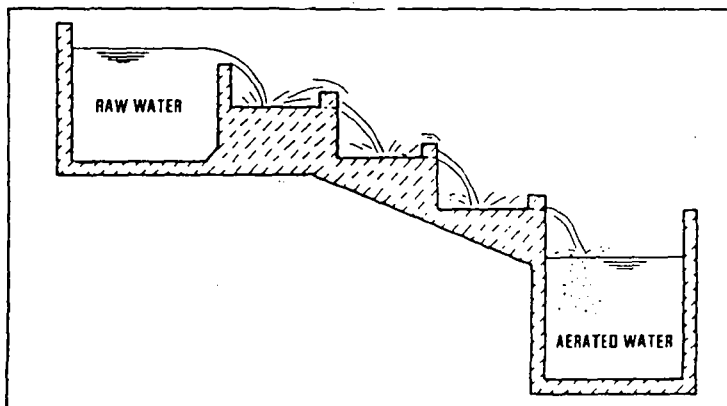

Figure 12.4.
Cascade aerator

Fig. 71 Cascade aerator

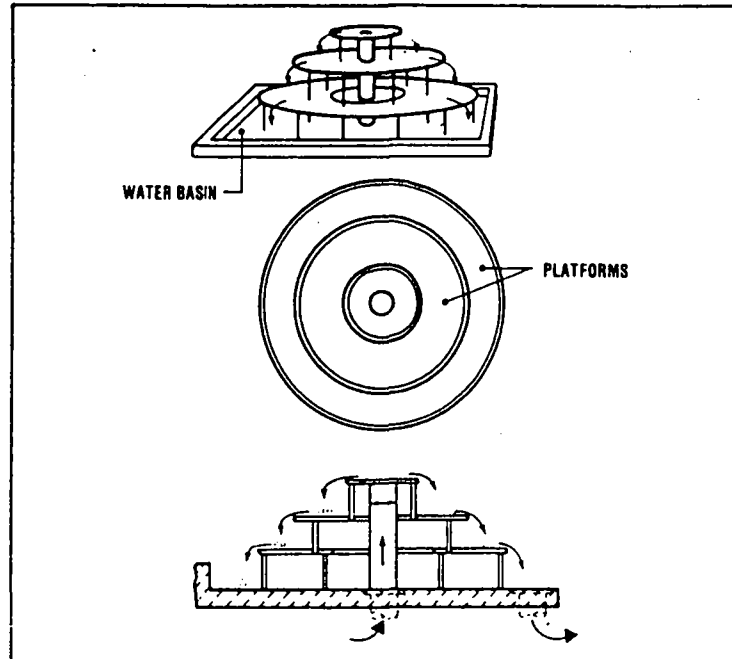
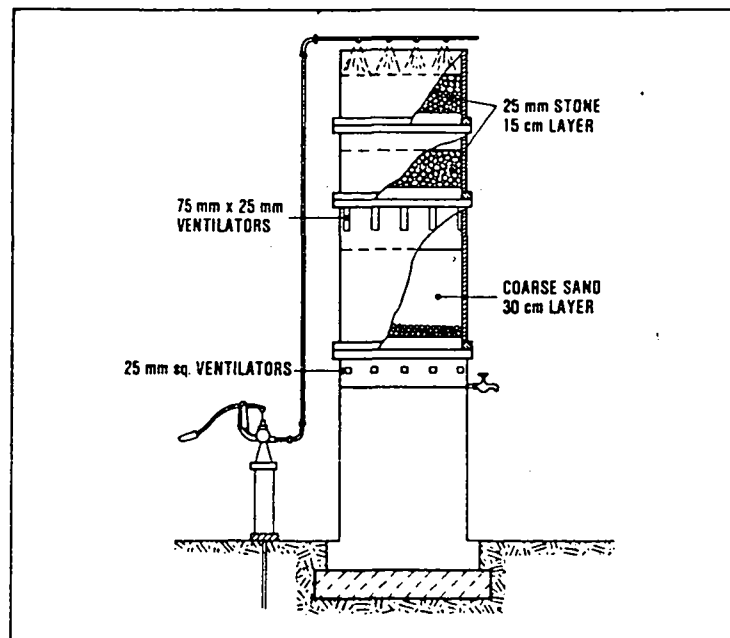

Fig. 72 Multiple platform aerator



Ref.: NEERI, India

Fig. 73 Hand operated aeration/filtration unit for iron removing

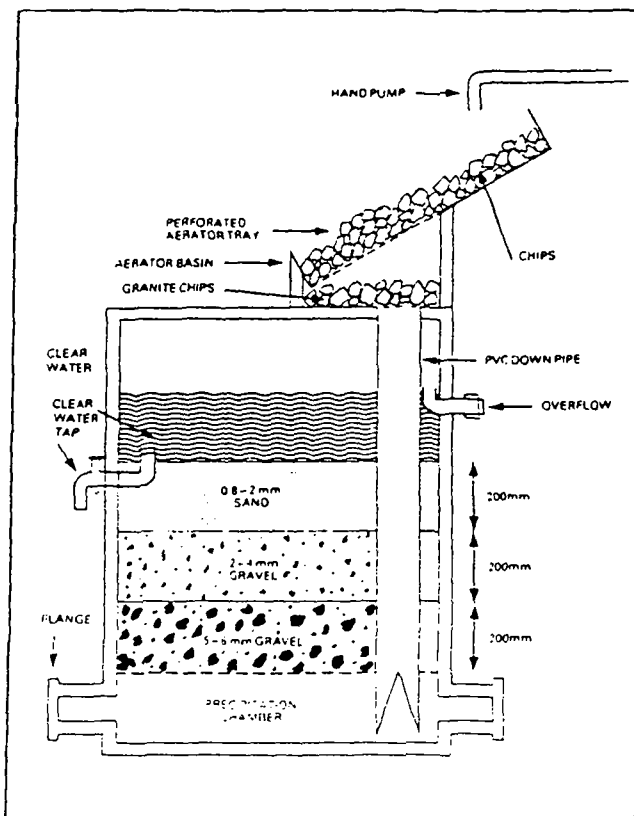
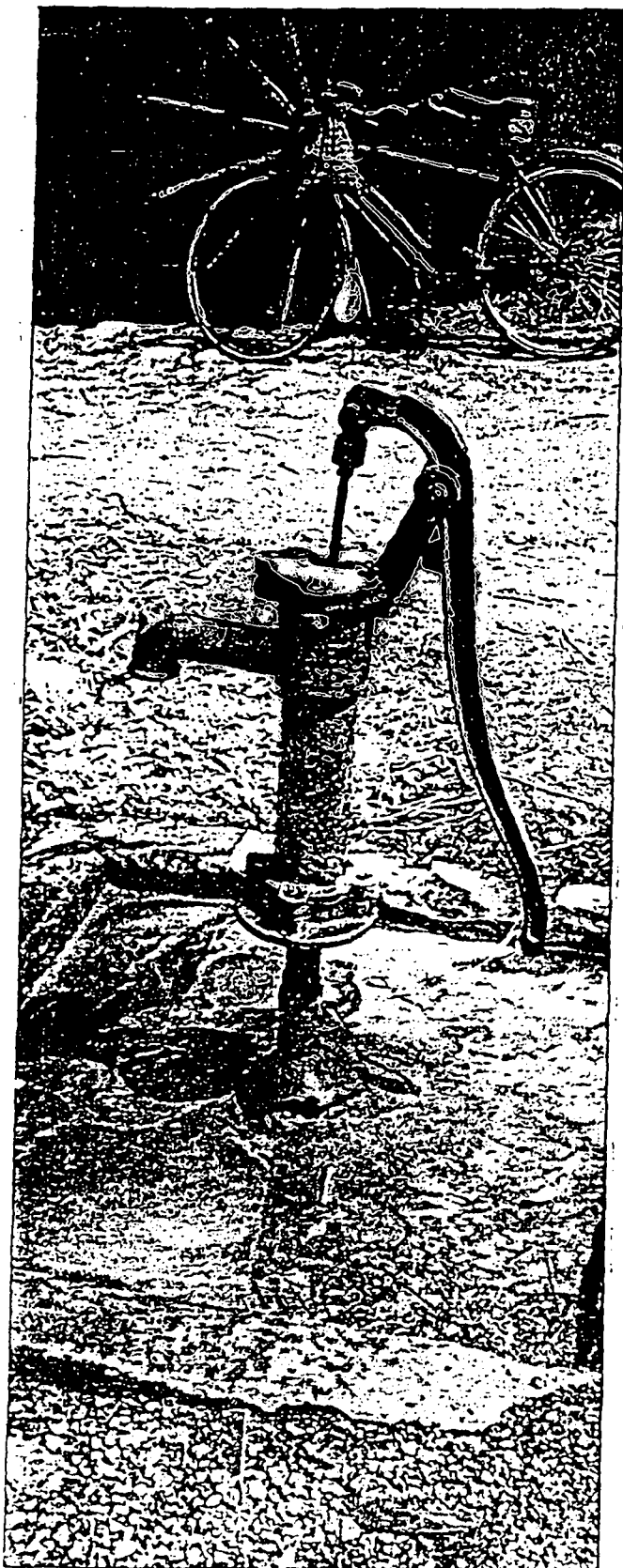

Fig. 74 Indian Iron removal unit

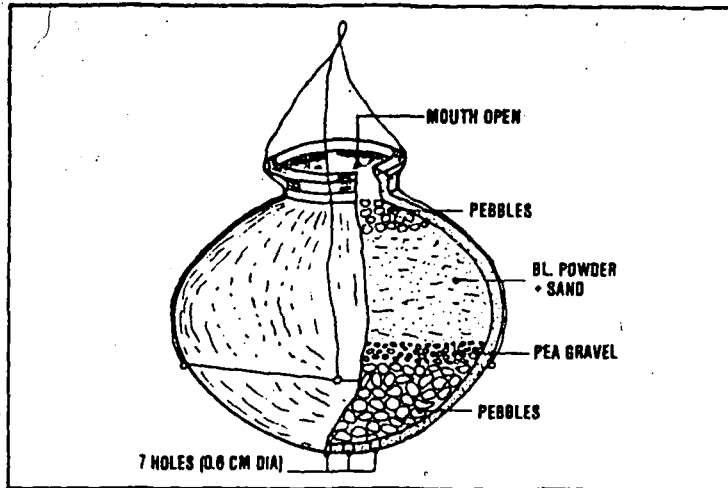
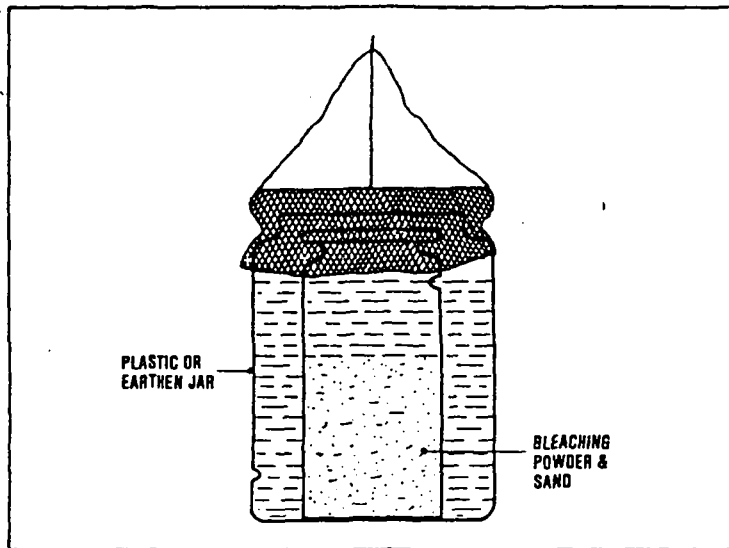

Fig. 75 'a' Chlorination pot with holes at the bottom



After: Raiazopalan & Shiffman

Fig. 75 'b' Double pot chlorinator

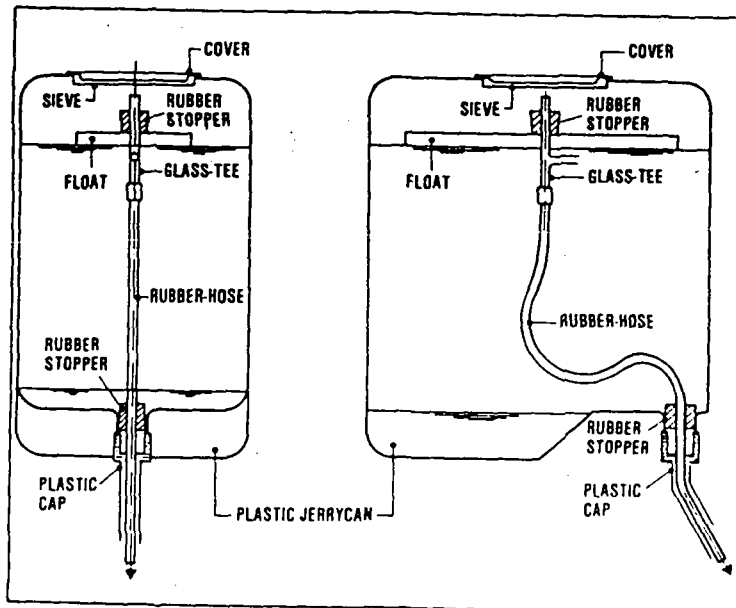

Fig. 75 'c' Equipment for feeding chlorine solution

References

- A. C. TWORT, F M LAW and F M CROWLEY (1985), Water Supply, Edward Arnold, pp. 425, 426
- B. C. PUNMIA (1977), Environmental Engineering (volume 1), Water Supply Engineering, Standard Book House, Delhi, pp. 396
- Developing World Water (1987), Grosvenor Press International Ltd., West Garden Place, London , pp. 218
- Hand pumps (1977), Technical Paper Series 10, International Reference Centre for Community Water Supply, The Hague, The Netherlands, pp. 41-42, 131-134, 147-148
- H. P. BANZIGER (1982), Hand/ Foot Pumps for Village Water Supply in Developing Countries, Part II - Description of pump types, VambuelstraBe 14, CH - 9000 St. Gallen, Switzerland, pp. 5, 7, 30, 35
- Small Community Water Supplies (1981), Technical paper Series 18, International Reference Centre for Community Water Supplies, The Hague, The Netherlands, pp. 59-71, 100-129, 137-143, 167-182, 201-205, 299-307