

232.2 9121

THE ZIMBABWE BUSH PUMP

MANUAL FOR THE INSTALLATION, DISMANTLING
AND MAINTENANCE OF THE "B" TYPE BUSH PUMP



HEALTH RESEARCH LABORATORY
MINISTRY OF HEALTH
P.O. BOX 8105
CAUSEWAY
HARARE

232.2-7148



INTRODUCTION

The "B" type Bush Pump was developed as a result of an initiative by the NAC Technical Sub Committee in 1987 and a combined effort of the DDF, Ministry of Energy, Water Resources and Development and the Ministry of Health.

It was field tested by the Blair Research Laboratory and the DDF from 1987 to 1989 and chosen for the National Handpump tender awarded by the Ministry of Energy, Water Resources and Development in 1989 and 1990. Heavy duty endurance trials continue with the aim of making the pump as durable as possible under extreme conditions of use.

The "B" type Bush Pump was designed to reduce the number of wearing parts in the pump head and to make pumping much easier, especially from deeper boreholes. Special spanners have also been developed for the pump. The pump is compact and easily transported and can be fitted on to wells or boreholes. The pump stand has been developed to provide strength, whilst the time tested hardwood block has been retained as a bearing and lever mechanism. The floating washer system allows for free movement of the pump rods which connect the pump head directly to the piston arrangement below. Normally pumps operate down to depths of 50m, but with extended handles the pump can raise water from depths of up to 100metres. Normally the pump is fitted with a 75mm brass cylinder, 50mm galvanised steel rising mains with 16mm mild steel pump rods. However systems have been developed which enable the piston and seals to be extracted through the rising main - these use 50mm brass cylinders. The water delivery rate for the 75mm system is about 40 litres per minute and about 20 litres per minute for the 50mm system.

The "B" type Bush Pump represents a Zimbabwean initiative to continue the development of its own handpumps suitable for use in Zimbabwean conditions. The development of the pump head has been undertaken with parallel developments of "down the hole" components. These are concentrated on extending the working life of "down the hole" components and also making the maintenance of these components simpler and more suitable for village level maintenance. The standard 75mm diameter brass cylinder and 50mm rising main combination is durable and delivers adequate volumes of water for heavy duty settings, but it is not suitable for village level maintenance initiatives. 50mm extractable systems, are easier to maintain, but do not deliver sufficient volume to cope with heavy duty situations. A combination of both systems will therefore be inevitable in the future. Whilst leather seals are used on the 75mm piston, tests are now being undertaken using nitrile rubber seals on the 50mm piston since these have a longer life than leather. This material will also be tested on 75mm pistons to extend the working life. Trials are also being undertaken with PVC rising mains for shallower depths and in the near future tests will be undertaken with high impact PVC for deeper settings. Currently the "B" type Bush Pump is manufactured by V & W Engineering, P.O. Box 131, Harare, who have developed a mass production line for this unit. The pump is also made in the DDF workshops at Manyame.

The fine illustrations in this manual were drawn by the Dutch artist Kors de Waard, with financial assistance from SIDA. Many thanks are due to them and to all those who have played a part in keeping Zimbabwean technology alive.

Peter Morgan
Blair Research Laboratory
Harare.

February 1991.

LIBRARY, INTERNATIONAL REFERENCE
CENTRE FOR COMMUNITY WATER SUPPLY
AND SANITATION (IRC)
P.O. Box 93190, 2509 AD The Hague
Tel. (070) 814911 ext. 141/142

RN: 15N 7148
LO: 232.2 9121

PARTS OF THE PUMP HEAD

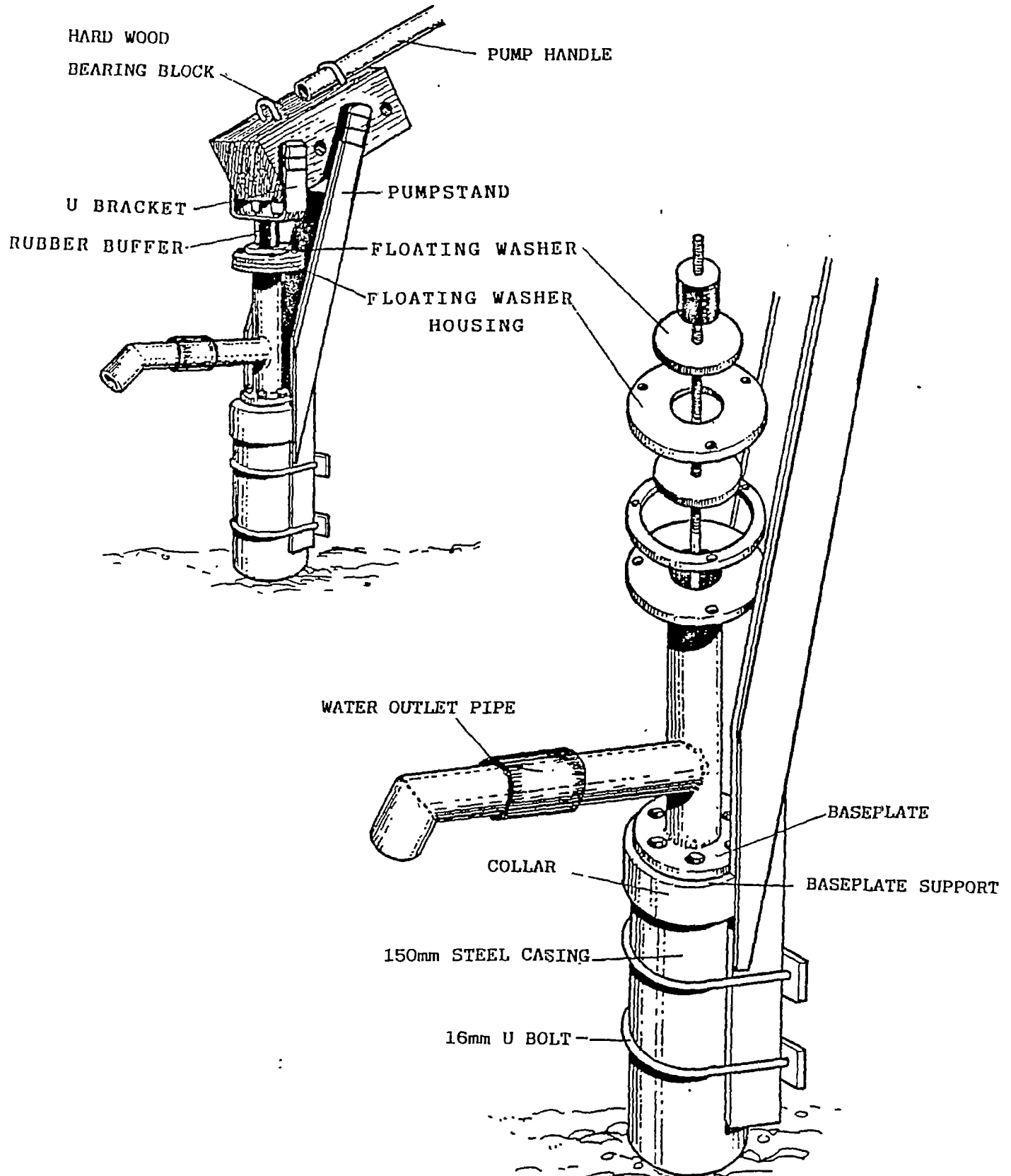

EXPLODED VIEW OF FLOATING WASHER HOUSING

THE "B" TYPE BUSH PUMP HEAD

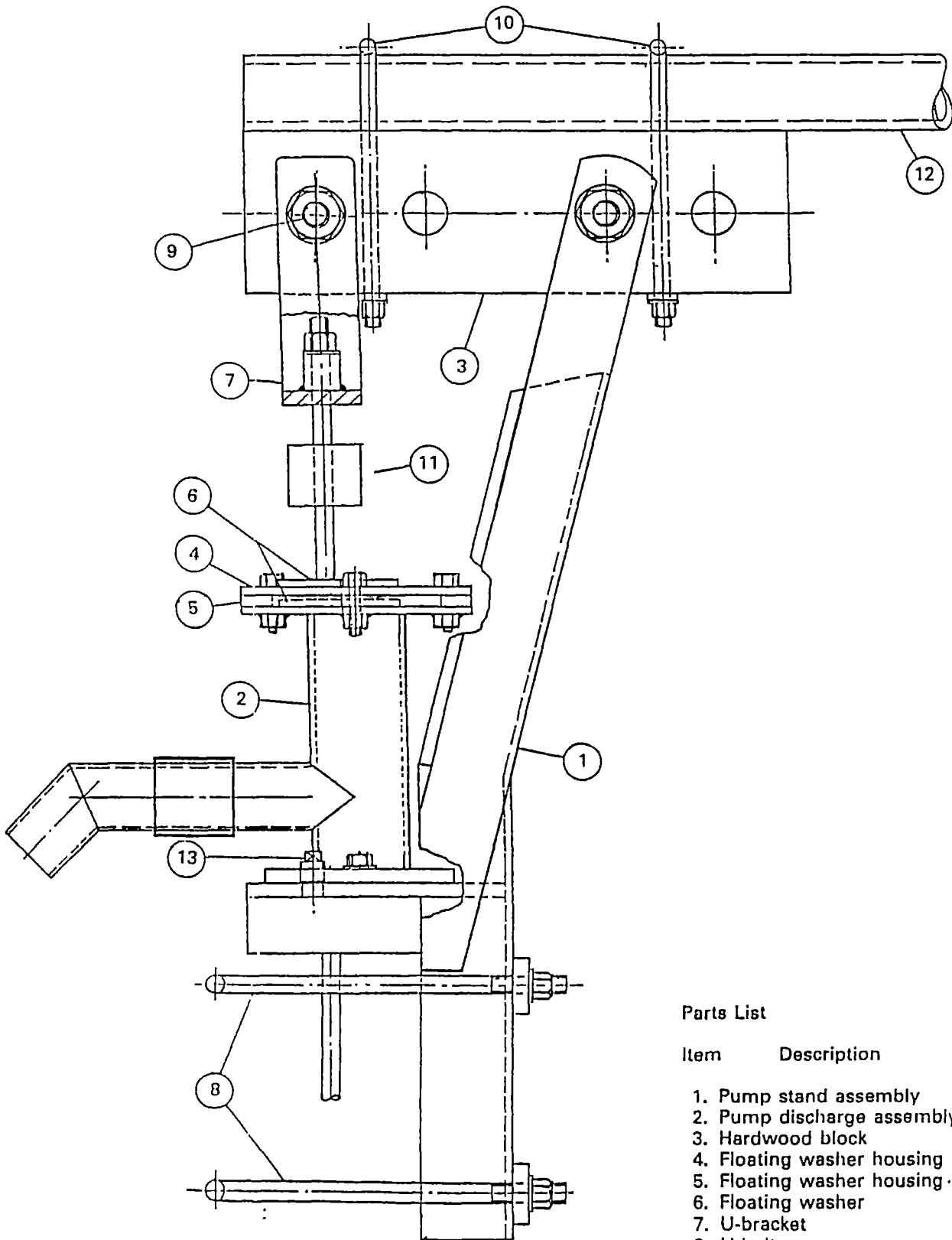

Parts List

Item	Description
1.	Pump stand assembly
2.	Pump discharge assembly
3.	Hardwood block
4.	Floating washer housing
5.	Floating washer housing
6.	Floating washer
7.	U-bracket
8.	U-bolt
9.	Hinge pins
10.	U-bolt
11.	Rubber buffer
12.	Handle
13.	M20 plug

50mm GI RISING MAIN PIPE

75mm x 600mm BRASS CYLINDER

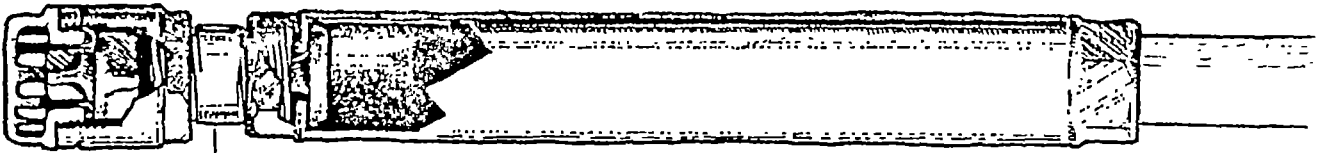

FOOTVALVE

BARREL NIPPLE

EXPLODED VIEW OF PLUNGER

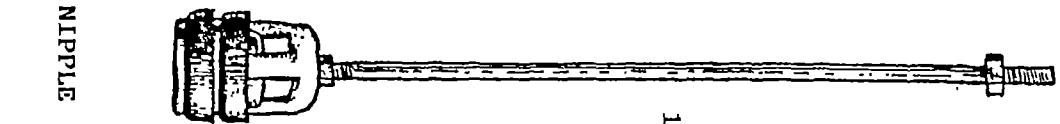

16mm ROD

PLUNGER

16mm ROD

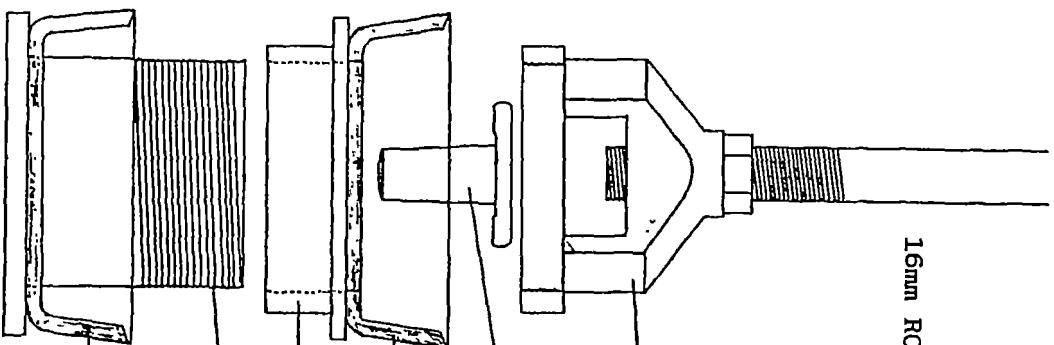

VALVE CAGE

VALVE POPPET

LEATHER CUP

PLUNGER FOLLOWER

CUP LEATHER FOLLOWER

LEATHER CUP

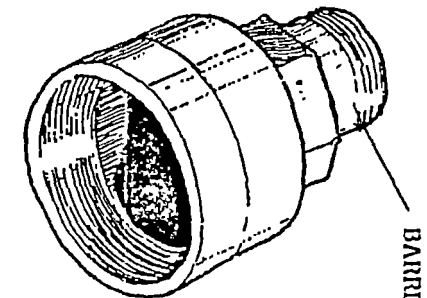

BARREL NIPPLE

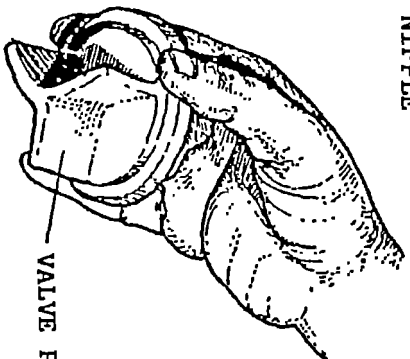

VALVE POPPET

PARTS OF FOOTVALVE

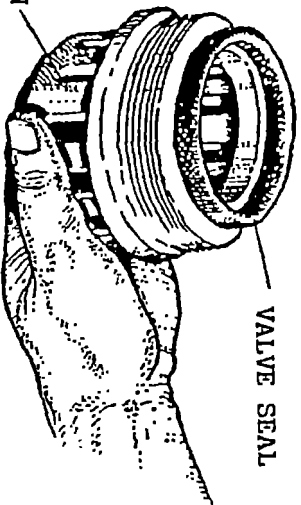

VALVE SEAL

SCREEN

"DOWN THE HOLE" COMPONENTS

PREPARING THE STEEL CASING FOR PUMP INSTALLATION

The Bush Pump is designed to clamp on to a 150mm diameter steel borehole casing. In the case of a borehole installation, this is clamped directly on to the casing itself, in the case of a well installation a section of casing must be mounted in the well cover.

BOREHOLES: When fitted to a borehole the Bush Pump is attached directly to the borehole casing which should be cut off 500mm above ground level. A concrete apron is cast around the casing to a depth of 100mm leaving 400mm of casing for pump attachment.

WELLS: When the pump is fitted to a well a 600mm length of 150mm diameter steel borehole casing is partly embedded in the well slab. The slab should be sufficiently wide to span the well and the collar/ lining. The slab should be made in strong reinforced concrete using a mixture of 4 parts stone, 2 parts river sand and 1 part cement. The slab should be made 100mm thick overall and thickened to 200mm around the casing as shown in the diagram. The final height of the slab above ground level should not exceed 300mm. A protective apron is constructed around and below the raised well slab.

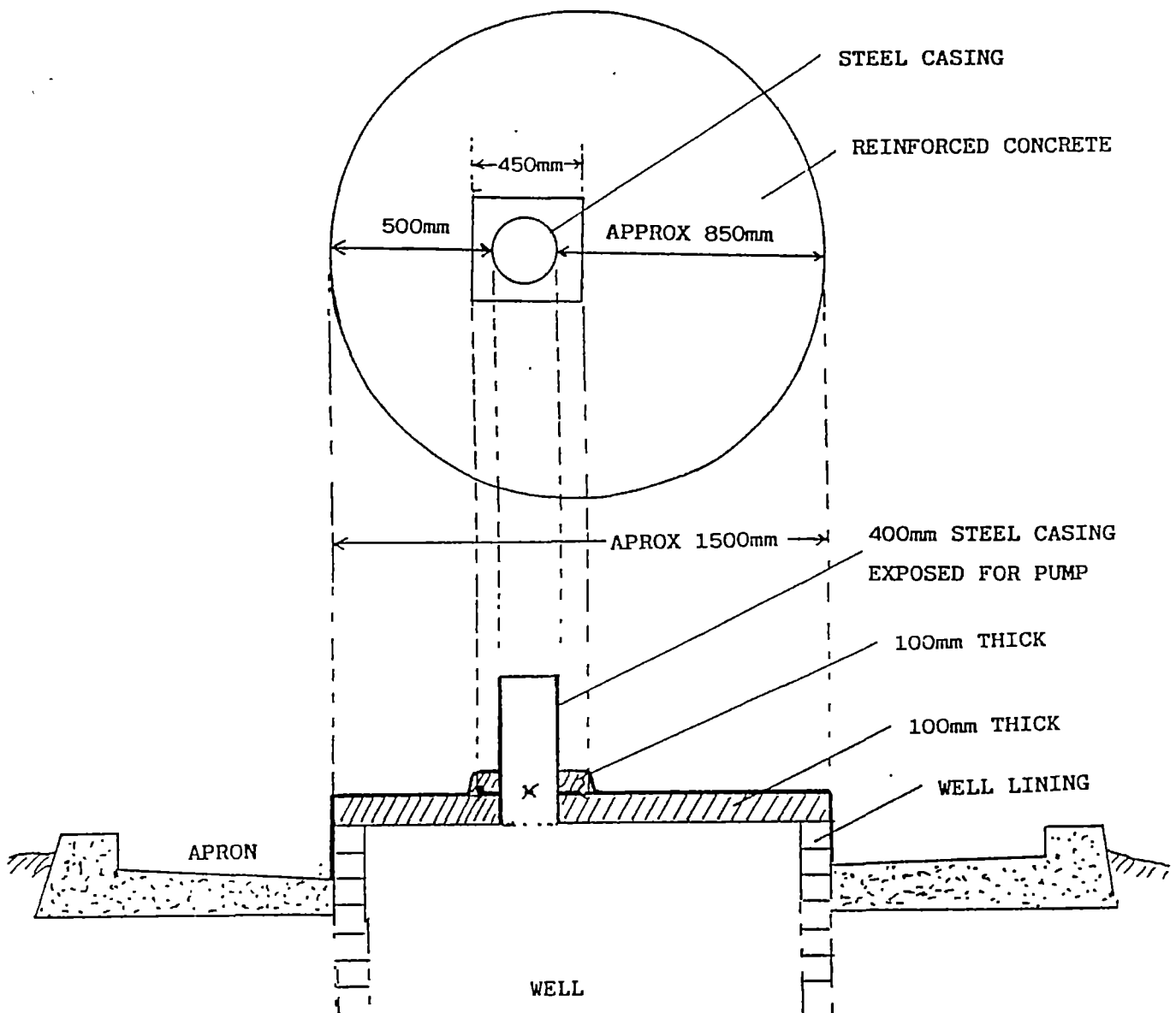

INSTALLING THE "B" TYPE BUSH PUMP

STEP BY STEP

STAGE 1.

LEAVE 500mm OF THE 150mm DIAMETER STEEL CASING ABOVE GROUND LEVEL IN A BOREHOLE.

LEAVE 400mm OF THE 150mm DIAMETER STEEL CASING ABOVE SLAB LEVEL IN A WELL



MEASURE THE DEPTH OF THE BOREHOLE OR WELL

(All Wells and boreholes should be protected with a strong concrete apron and water run-off)

STAGE 2.

FIT THE PUMP STAND TO THE CASING

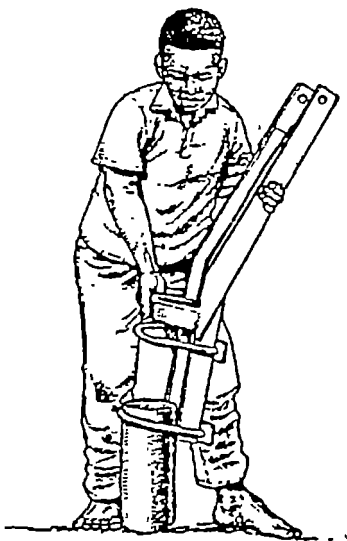

STAGE 3.

THOROUGHLY CLEAN THE FOOTVALVE AND CYLINDER



Ensure seal is correct size

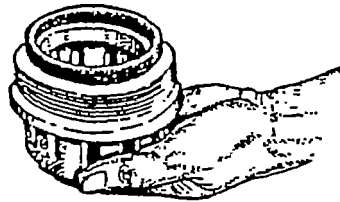
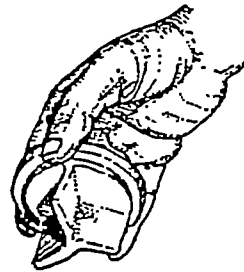
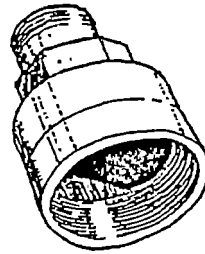

STAGE 4.

CONNECT THE FOOTVALVE TO CYLINDER WITH A BARREL NIPPLE (PREFERABLY BRASS) AND TIGHTEN

Use the type of footvalve shown in the diagram



STAGE 5.

CLEAN ALL THE 3 METRE LENGTHS OF 50mm GI PIPES AND 16mm MILD STEEL RODS

NOTE: WITH THE "B" TYPE BUSH PUMP 50mm PIPE SHOULD BE USED THROUGHOUT. IF 40mm PIPE IS CHOSEN THE UPPERMOST PIPE SHOULD BE 50mm WITH A REDUCING SOCKET BEING USED TO CONNECT TO THE LOWER 40mm PIPES.

USE WIRE BRUSH FOR CLEANING PIPE AND ROD THREADS

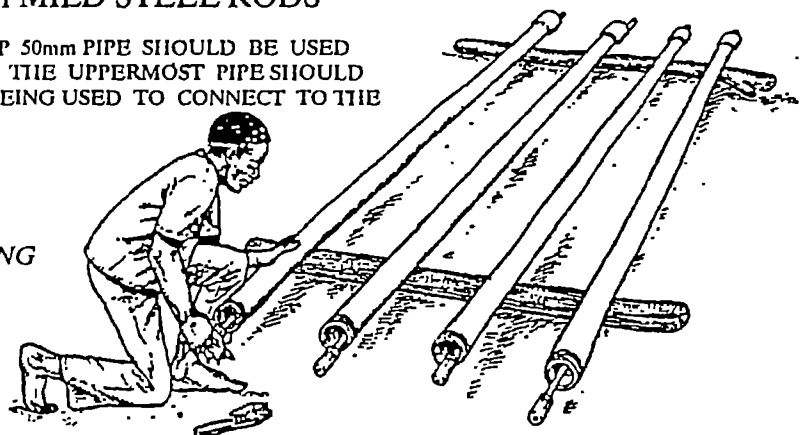

STAGE 6.

CONNECT PLUNGER ROD TO LOWEST PUMP ROD.
ENSURE LOCK NUTS ARE DONE UP TIGHTLY.

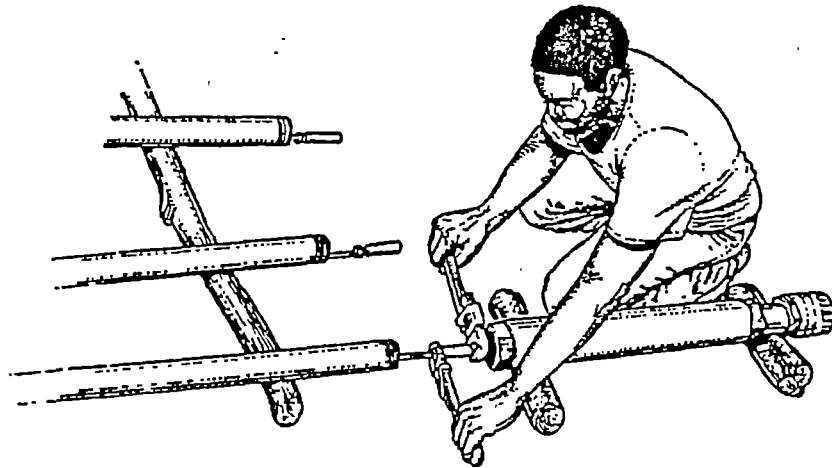

ALWAYS TAKE GREAT CARE WITH THE BRASS CYLINDER

STAGE 7.

CONNECT THE CYLINDER TO THE
LOWEST PIPE.

ALWAYS USE PLUMBERS PASTE ON JOINTS

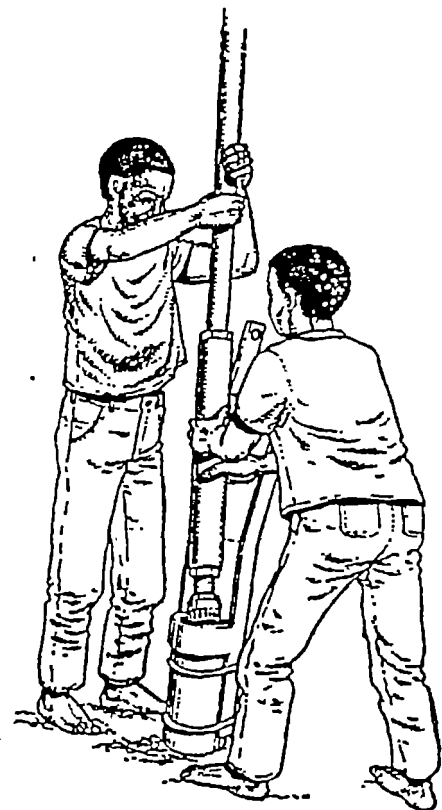
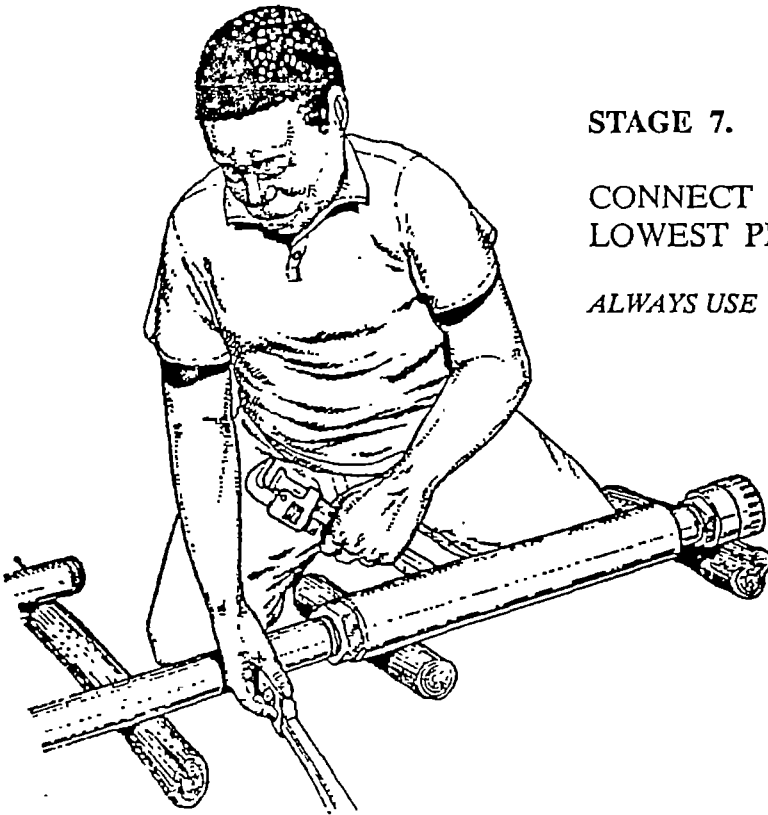

STAGE 8.

LOWER CYLINDER AND FOOTVALVE AND
FIRST LENGTH OF PIPE AND CLAMP

*THIS IS USUALLY PERFORMED WITH
A BLOCK AND TACKLE*

STAGE 9.

CLAMP PIPE AND MOVE NEXT ROD AND PIPE INTO POSITION. JOIN THE RODS TOGETHER SO THAT EACH ROD IS HALF-WAY IN THE SOCKET. TIGHTEN BOTH LOCK NUTS.

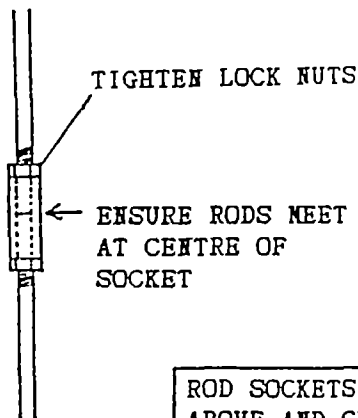

ROD SOCKETS MUST STAND ABOVE AND CLEAR OF PIPE SOCKETS

A rectangular text box with a line pointing to the upper part of the pipe assembly in the illustration to its right.

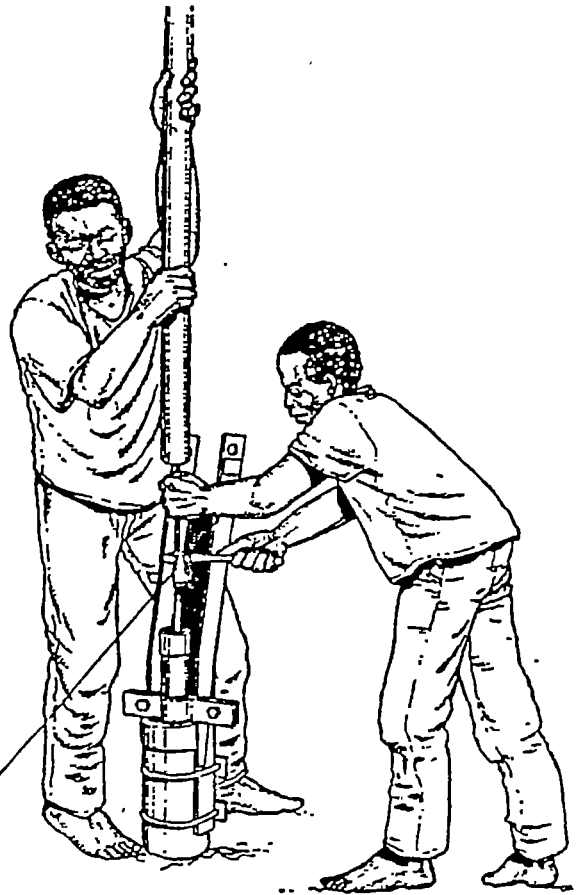

STAGE 10.

JOIN UPPER AND LOWER PIPES. THREAD TOGETHER TIGHTLY. ALWAYS USE PLUMBERS PASTE AT THE JOINTS.

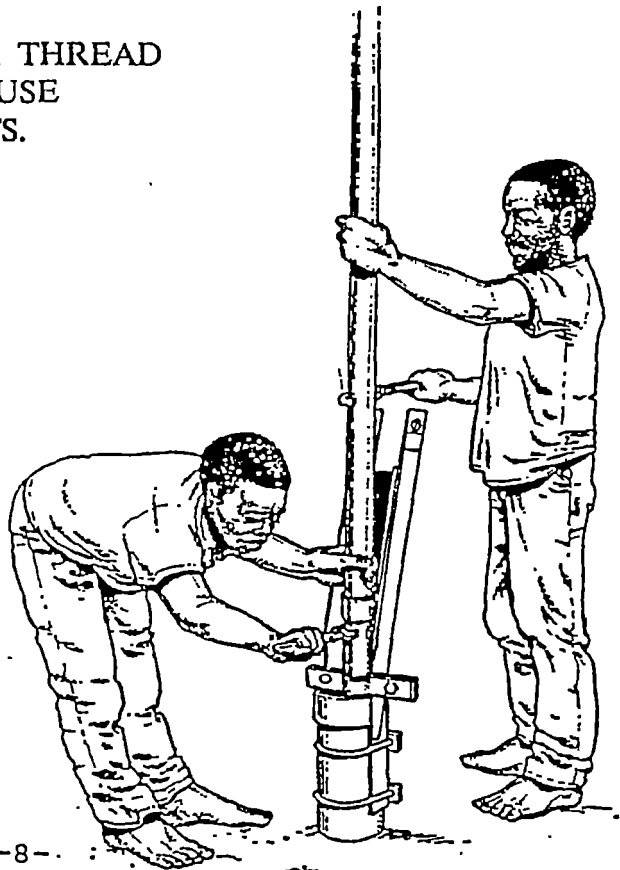
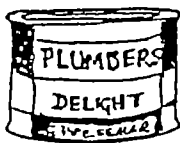

STAGE 11.

LOWER ALL PIPES AND RODS UNTIL THE LAST ROD AND PIPE REMAINS.

STAGE 12.

ADD THE 280mm LENGTH OF 16mm ROD DELIVERED WITH THE PUMP TO THE LOWER END OF THE UPPERMOST ROD AND CONNECT THIS SMALL SECTION TO THE ROD BELOW.

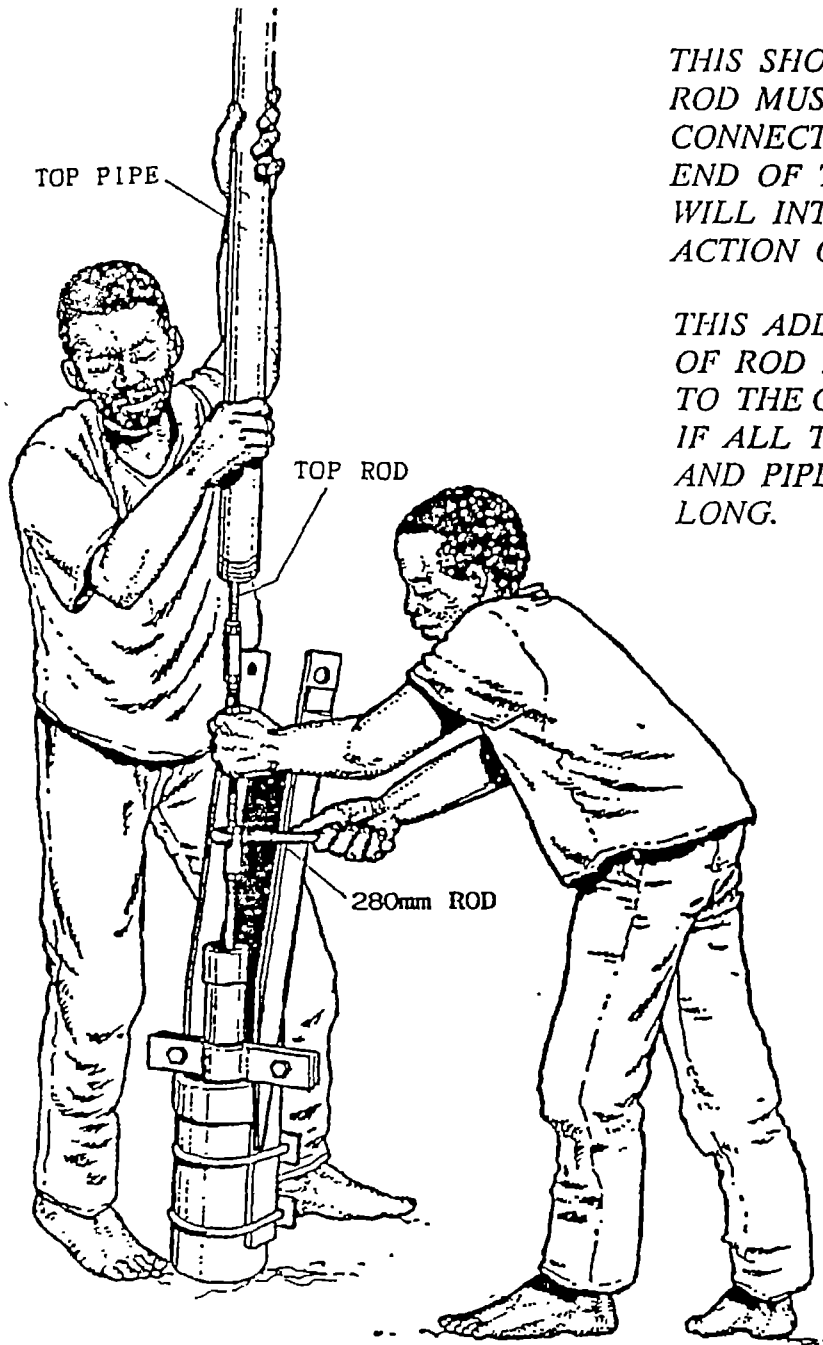

THIS SHORT SECTION OF ROD MUST NOT BE CONNECTED TO THE UPPER END OF THE RODS AS IT WILL INTERFERE WITH THE ACTION OF THE PUMP.

THIS ADDITIONAL LENGTH OF ROD BRINGS THE RODS TO THE CORRECT LENGTH IF ALL THE OTHER RODS AND PIPES ARE 3 METRES LONG.

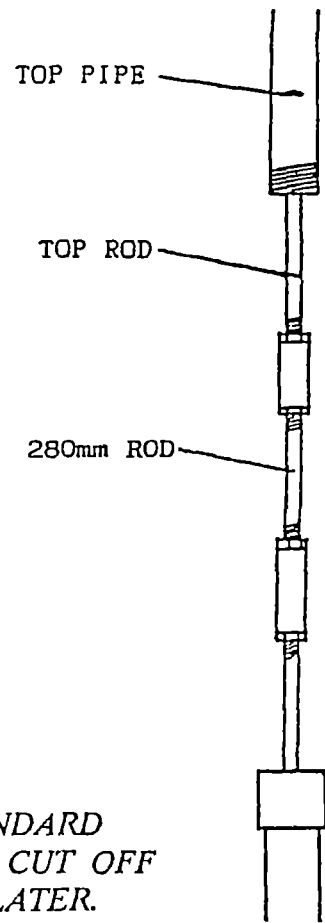

IF THE PIPES ARE SHORTER THAN STANDARD 3 METRE LENGTHS, THE ROD MUST BE CUT OFF AT THE CORRECT LENGTH AS SHOWN LATER.

STAGE 13.

CONNECT THE FINAL LENGTH OF PIPE. LOWER THE PIPE AND CONNECT THE WATER DISCHARGE UNIT OF THE PUMP HEAD.

THE PIPES ARE SUPPORTED BY A ROPE ATTACHED TO A BLOCK AND TACKLE AND TRIPOD.

IN THE MOST RECENT PUMPS A 50mm SOCKET IS FITTED TO THE OUTLET PIPE. WHERE WATER IS REQUIRED FOR A CATTLE TROUGH OR OTHER FACILITY, THIS IS REPLACED BY A TEE JUNCTION AND A SECOND OUTLET PIPE FITTED

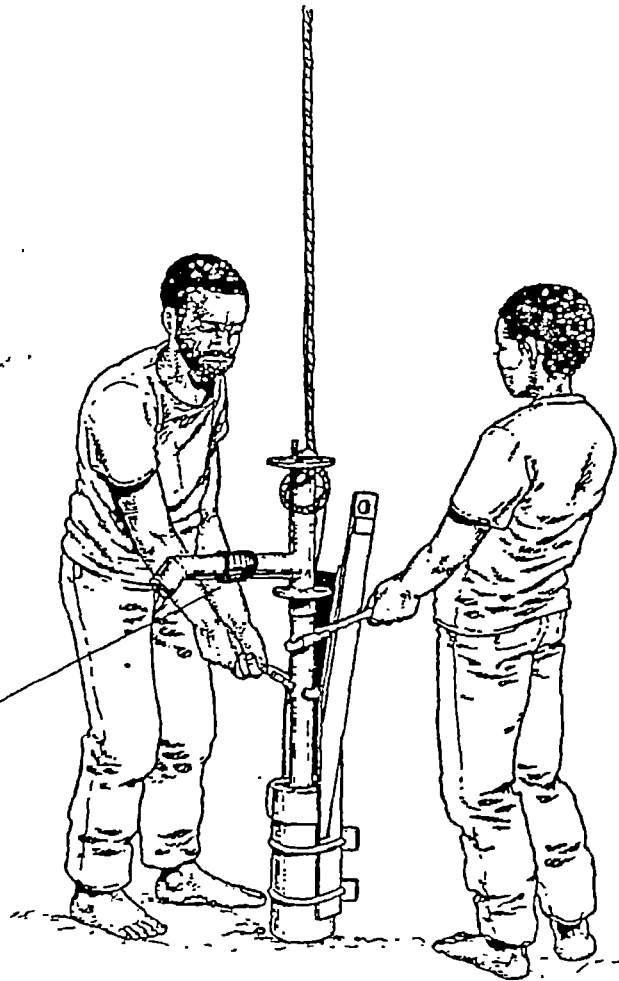

STAGE 14.

BOLT THE WATER DISCHARGE UNIT IN PLACE

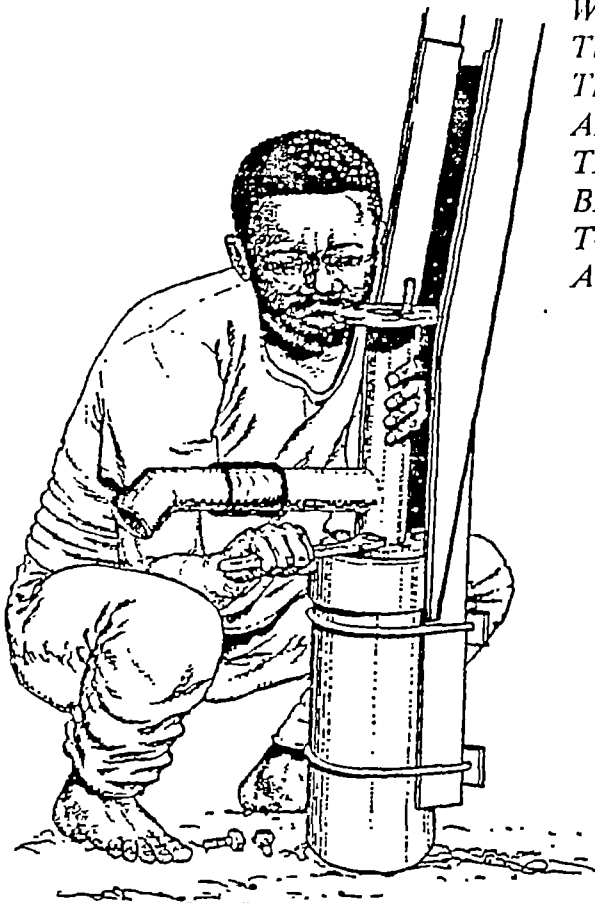

WHEN THE PLUNGER IS AT THE LOWER END OF ITS STROKE THE ROD SHOULD JUST SHOW ABOVE THE RUBBER BUFFER. IF THE ROD IS LONGER IT SHOULD BE CUT OFF LEVEL WITH THE TOP OF THE RUBBER BUFFER AND THREADED.

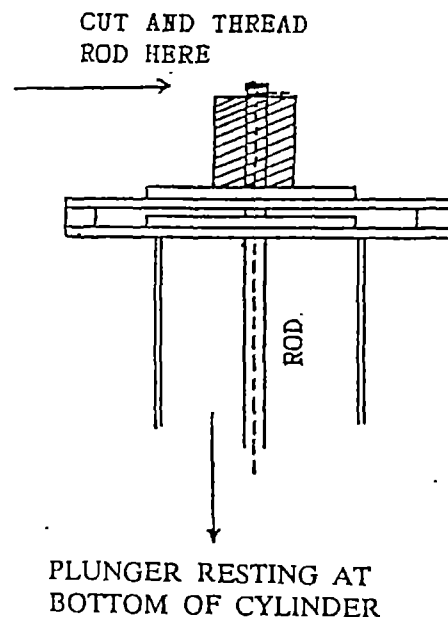

STAGE 15.

PULL UP THE RODS USING THE PUMP HEAD U BRACKET. HOLD THE ROD WITH VICE GRIPS

TAKE CARE: DO NOT BEND THE ROD. THE SPANNER SHOULD NOT BE USED TO LIFT THE ROD, SIMPLY TO HOLD IT IN PLACE. THE ROD SHOULD BE LIFTED EITHER WITH THE U BRACKET OR A SPECIAL ROD LIFTING TOOL.

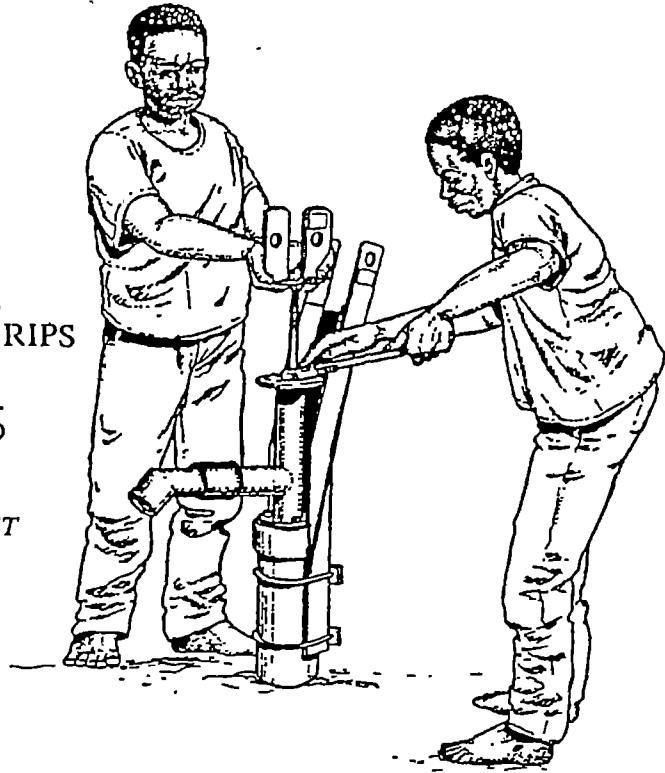

STAGE 16.

ASSEMBLE THE FLOATING WASHER HOUSING AND WASHERS AS SHOWN, SO THAT THE LOWER FLOATING WASHER LIES INSIDE THE HOUSING AND THE UPPER WASHER LIES ABOVE THE HOUSING.

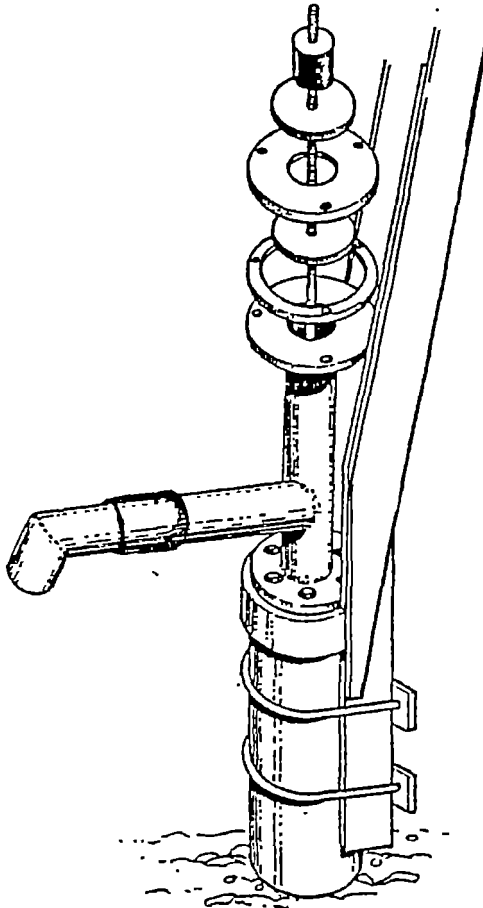

ADD THE RUBBER BUFFER AND THE U BRACKET. TIGHTEN ROD LOCK NUT ON U BRACKET.

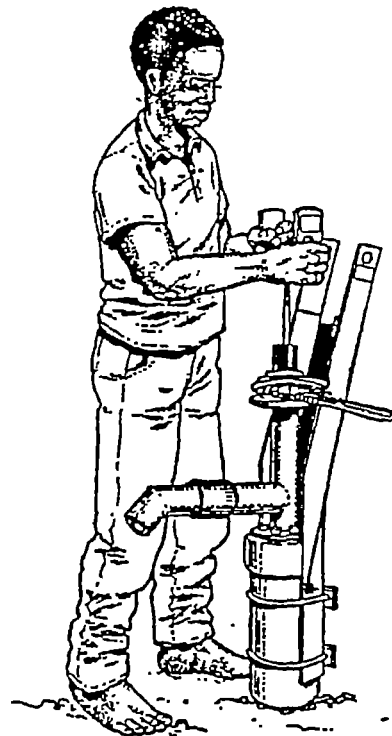

STAGE 17.

BOLT THE FLOATING WASHER HOUSING TOGETHER

NOTE: THE ILLUSTRATIONS IN THIS MANUAL SHOW THE PUMP BEING FITTED BEFORE THE APRON AND WATER RUN-OFF HAVE BEEN MADE. HOWEVER, IT IS NORMALLY ESSENTIAL TO FINISH THE HEADWORKS BEFORE THE PUMP IS FITTED.



STAGE 18.

POSITION THE WOODEN BLOCK AND THE TWO LARGE HEAD BOLTS AFTER APPLYING A THIN LAYER OF GREASE TO EACH. TIGHTEN THE NUTS OF EACH HEAD BOLT AGAINST THE SPRING WASHERS.

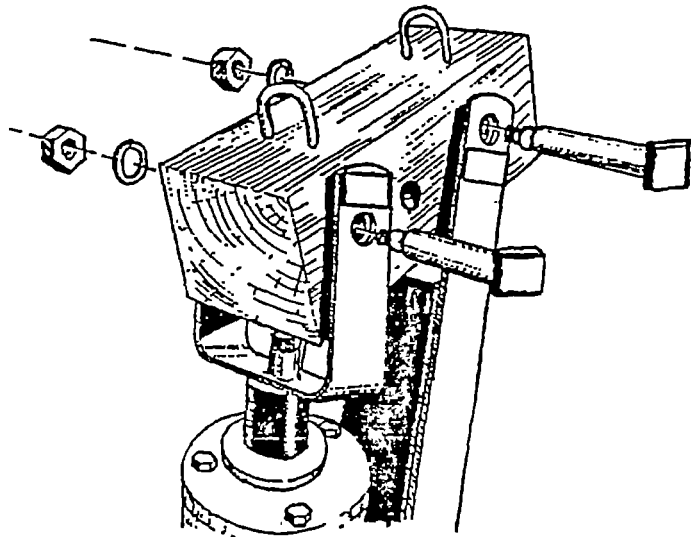
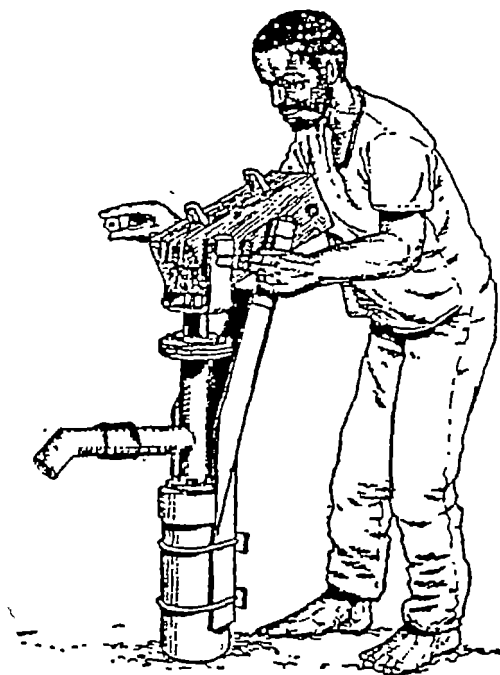

NOTE: AFTER A THIN LAYER OF GREASE HAS BEEN APPLIED TO THE HEAD BOLT AND ALSO WITHIN THE HOLE IN THE BLOCK, THE BOLT IS INSERTED AND ROTATED A NUMBER OF TIMES TO SPREAD GREASE EVENLY

STAGE 19.

ATTACH THE STEEL HANDLE AND TIGHTEN THE HANDLE U BOLTS.

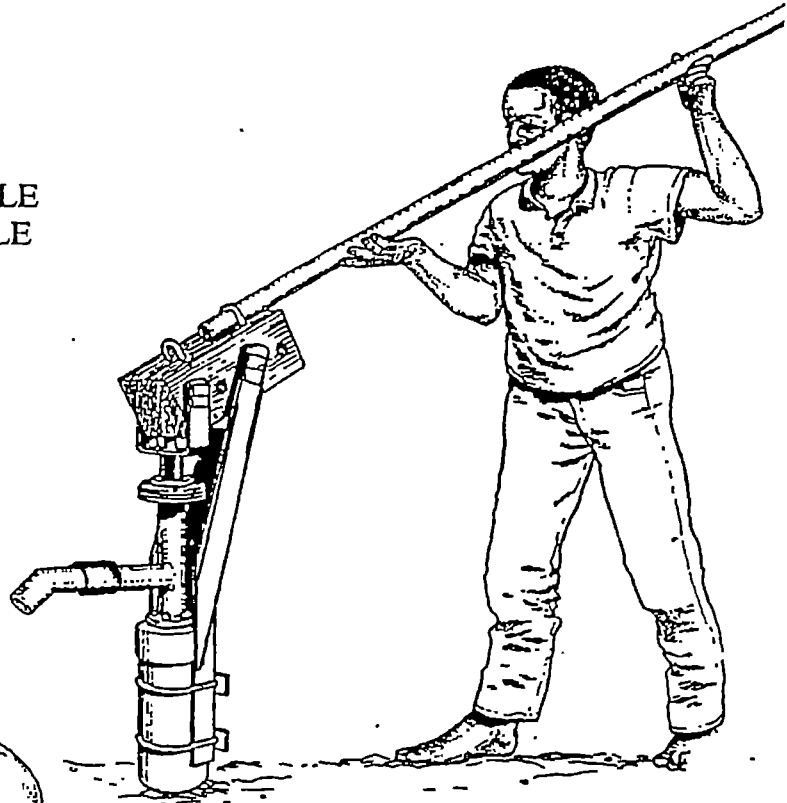
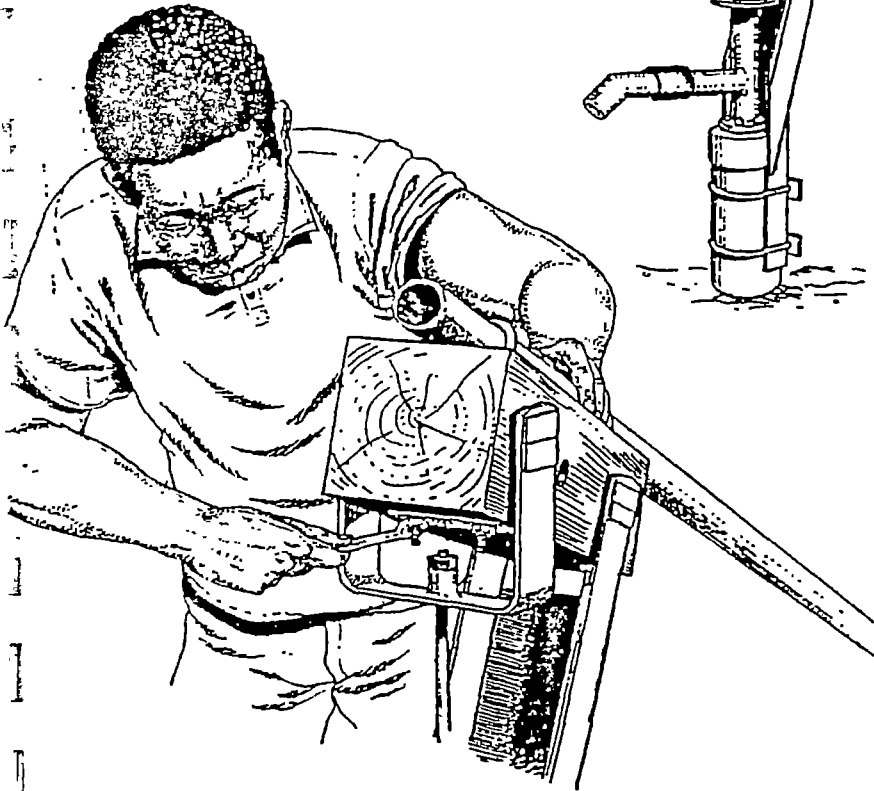

RECOMMENDED HANDLES		
PUMP DEPTH	HANDLE DIAMETER	HANDLE LENGTH
1 -15m	40mm	2.5m
16-45m	50mm	2.5m
45+ m	50mm	3.0m

NOTE: On very deep boreholes the handle should be filled with concrete to add weight to the handle.

STAGE 20.

TEST THE PUMP.

ADD WOODEN PUMP HANDLE STOPPER BEYOND EDGE OF APRON IF GROUND LEVEL UNDER THE HANDLE IS LOWER THAN THE STEEL CASING.

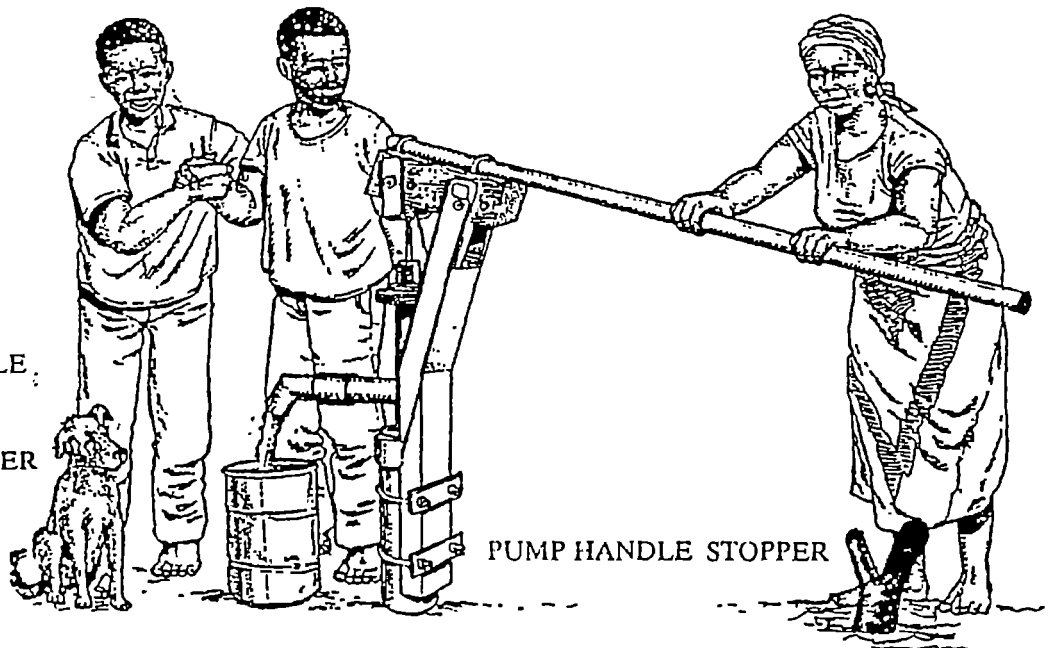

PUMP HANDLE STOPPER

DISMANTLING THE "B" TYPE BUSH PUMP

STEP BY STEP

STAGE I.

REMOVE TWO LARGE HEAD BOLTS FROM PUMP HEAD & REMOVE BLOCK AND HANDLE.

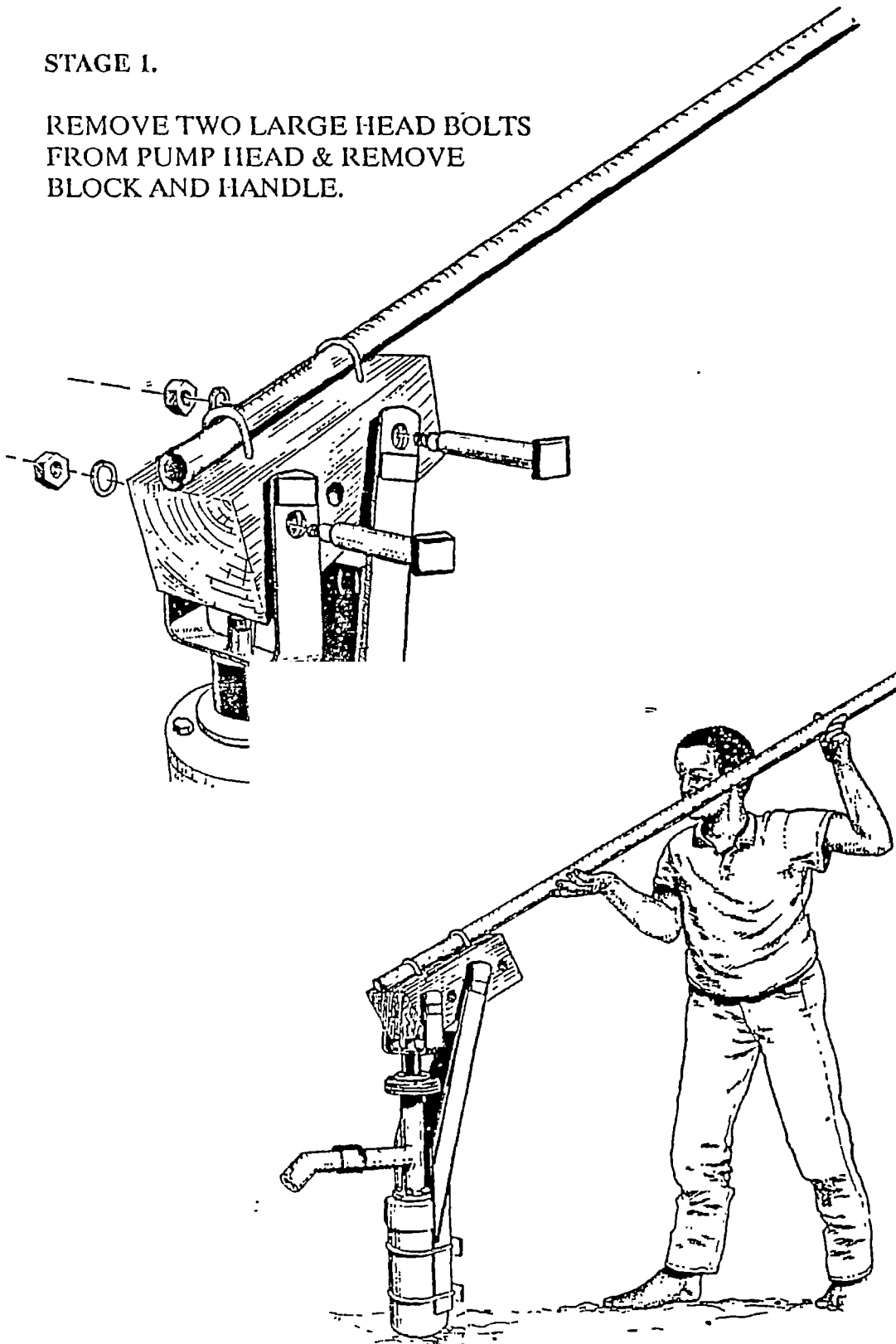

STAGE 2.

REMOVE BOLTS ON FLOATING WASHER HOUSING

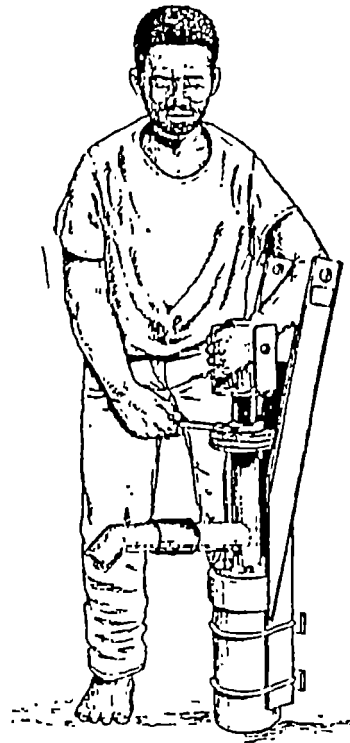
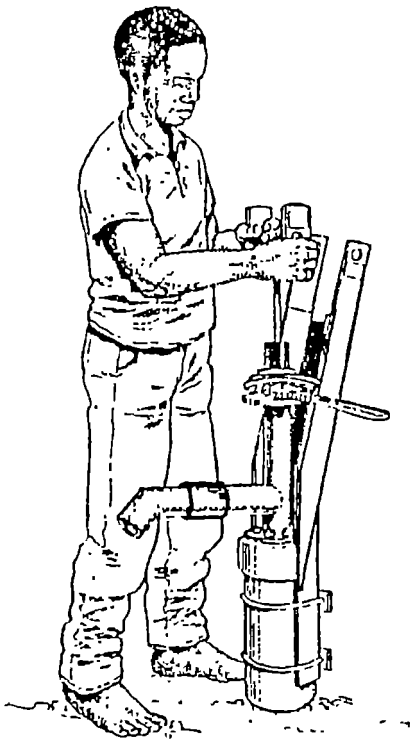

STAGE 3.

PULL UP ROD WITH U BRACKET
HOLD ROD WITH CLAMP

EXPLODED VIEW OF
FLOATING WASHER
AND WATER OUTLET
SYSTEM

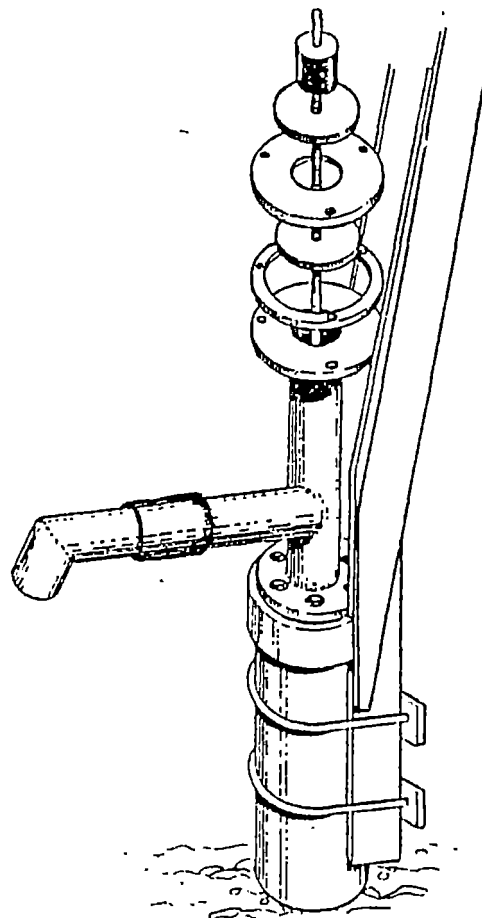

STAGE 4.

UNSCREW U BRACKET & REMOVE
REMOVE FLOATING PARTS OF THE
WASHER HOUSING & WASHERS

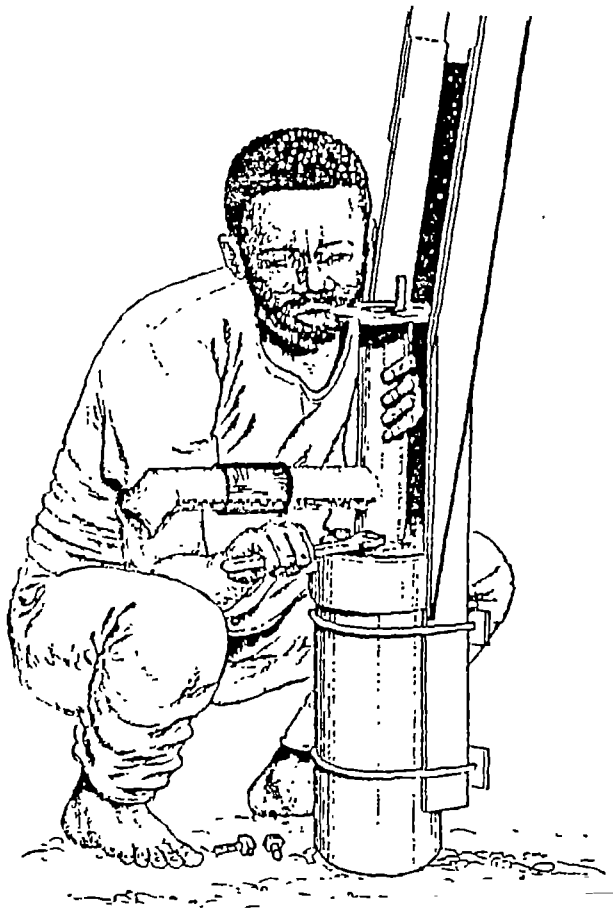

STAGE 5.

REMOVE BOLTS SECURING BASEPLATE
TO PUMP HEAD

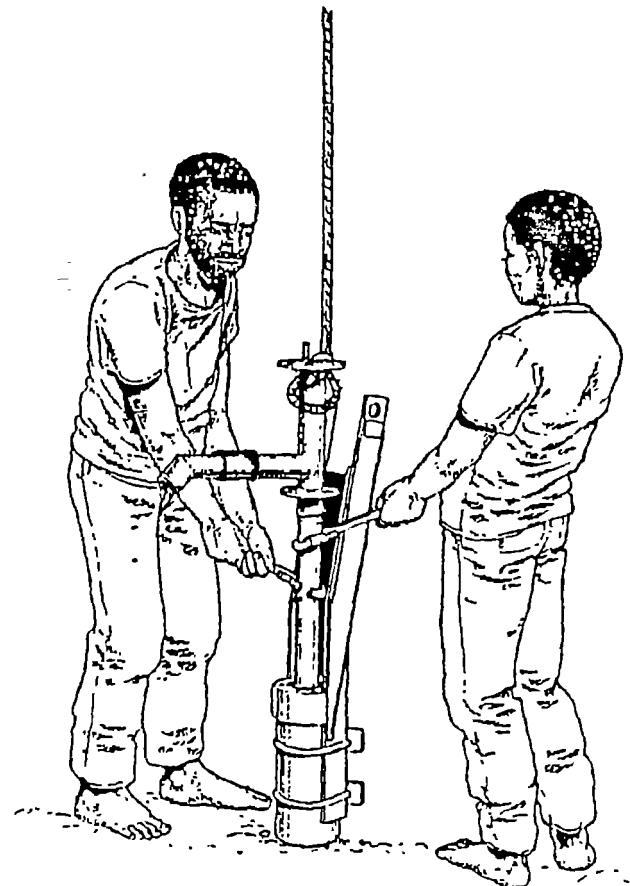

STAGE 6.

LIFT PIPE OUT WITH SUITABLE
LIFTING GEAR.

THE PIPES SHOULD BE LIFTED OUT WITH
A ROPE SUPPORTED BY A BLOCK AND TACKLE
AND A TRIPOD. DDF HAS ALSO DEVELOPED A
SIWIL LIFTING TOOL WHICH SHOULD BE TRIED.

STAGE 7.

**SEPARATE PIPE FIRST & THEN
SEPARATE ROD INSIDE PIPE.**

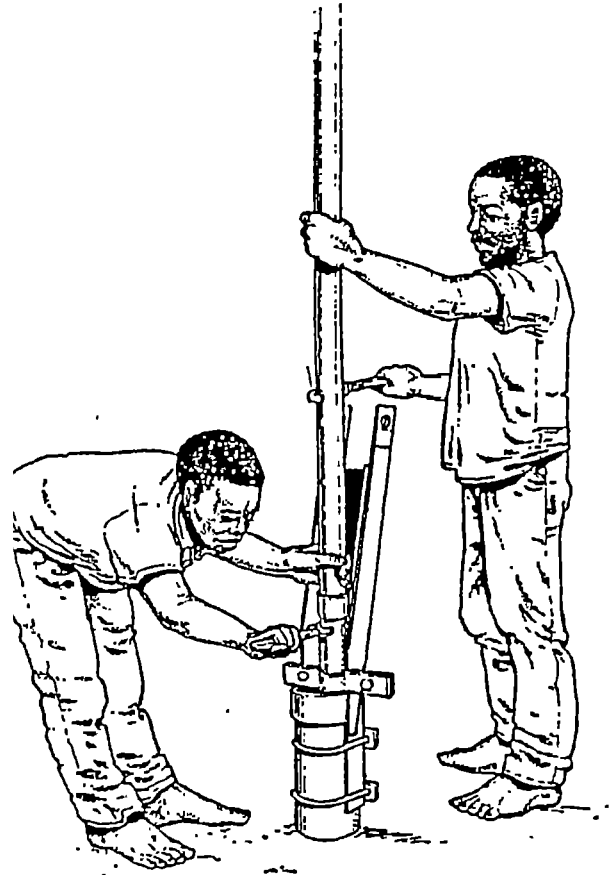
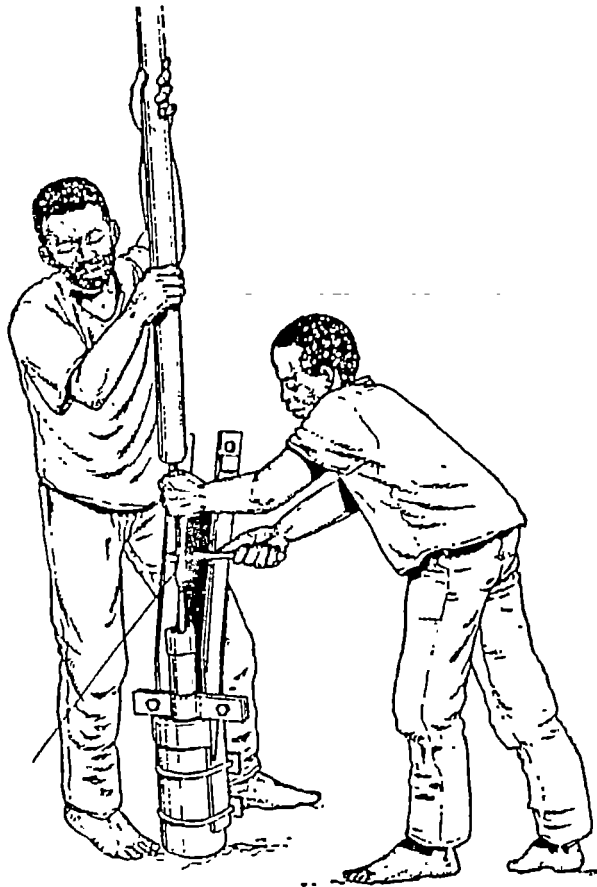

STAGE 8.

**LIFT ALL PIPES & RODS &
SEPARATE THESE. PLACE ON
CLEAN GROUND NEAR PUMP
FOR INSPECTION**

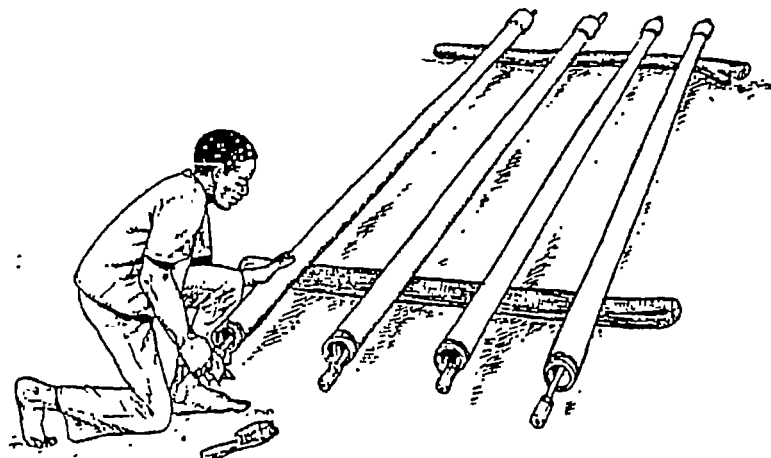

STAGE 9.

REMOVE LAST PIPE &
CYLINDER

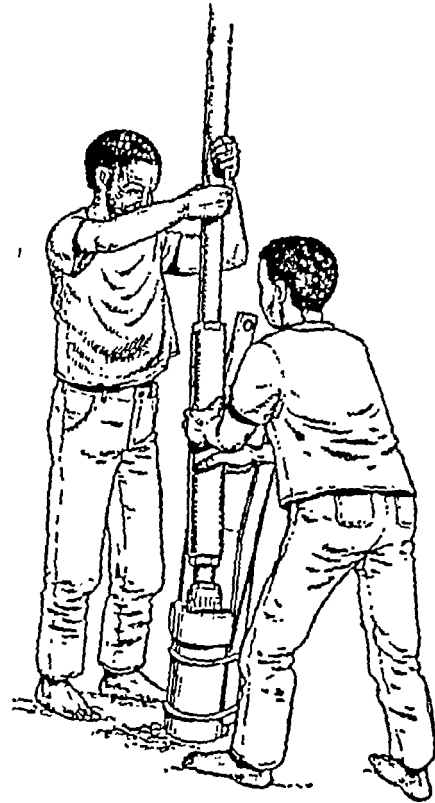
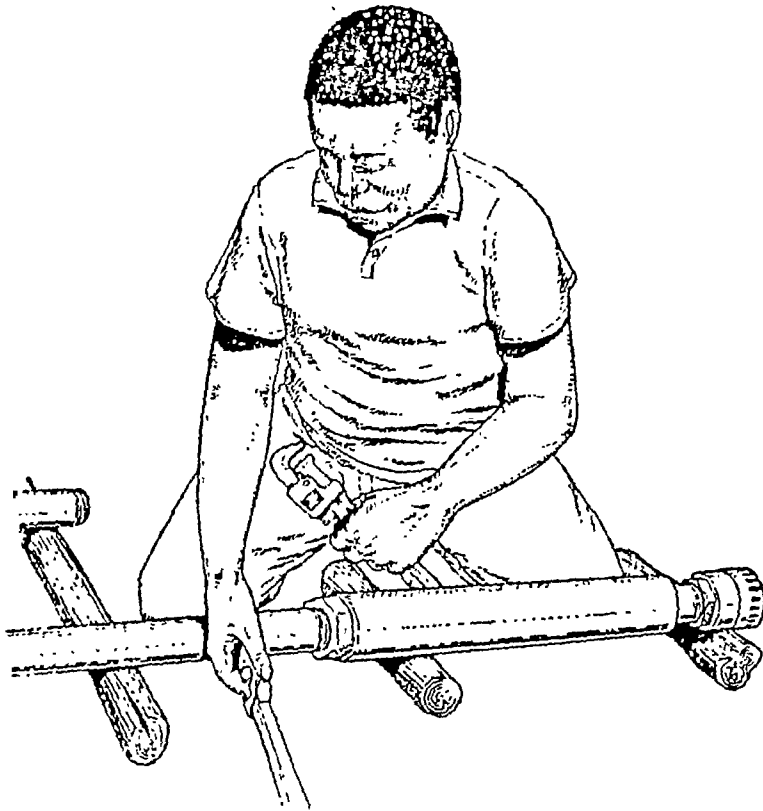

STAGE 10.

SEPARATE CYLINDER FROM
PIPE

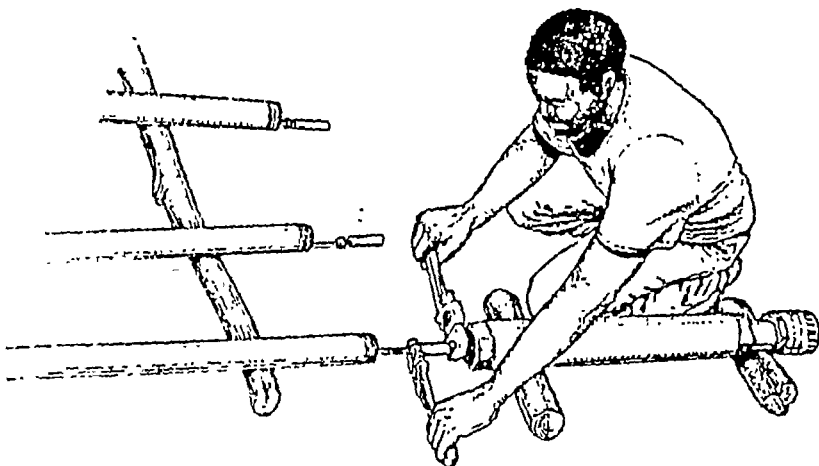

STAGE 11.

SEPARATE PUMP ROD
FROM PISTON ROD

STAGE 12.

**INSPECT ALL PIPES & RODS
CLEAN & REPLACE IF NECESSARY**

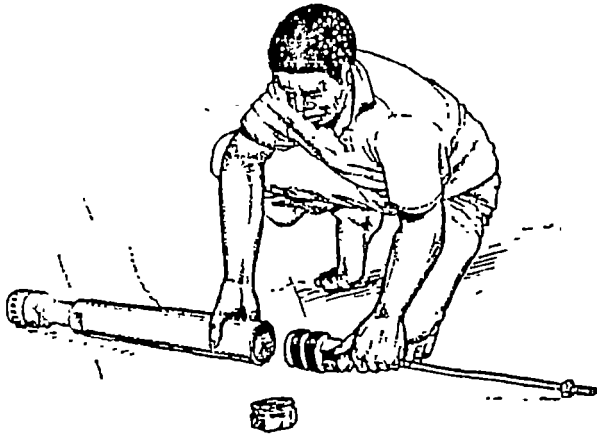
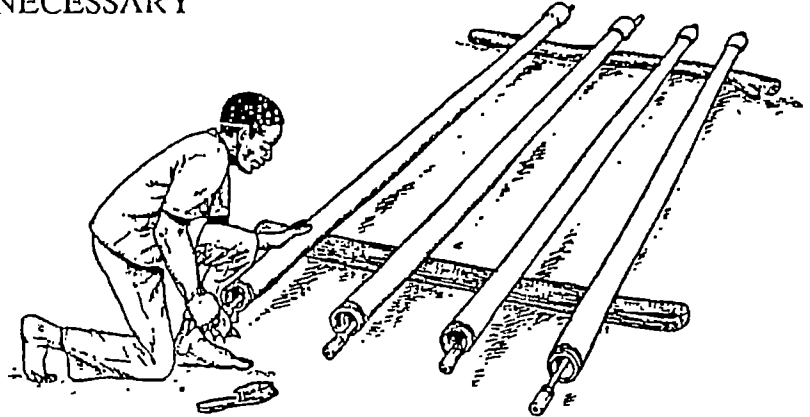

STAGE 13.

**INSPECT PISTON & CYLINDER
REPLACE WORN SEALS**



STAGE 14.

**REMOVE FOOTVALVE
REPLACE BARREL NIPPLE
IF CORRODED**

STAGE 15

**INSPECT FOOTVALVE.
THE ONE SHOWN IN DIAGRAM
IS RECOMMENDED**

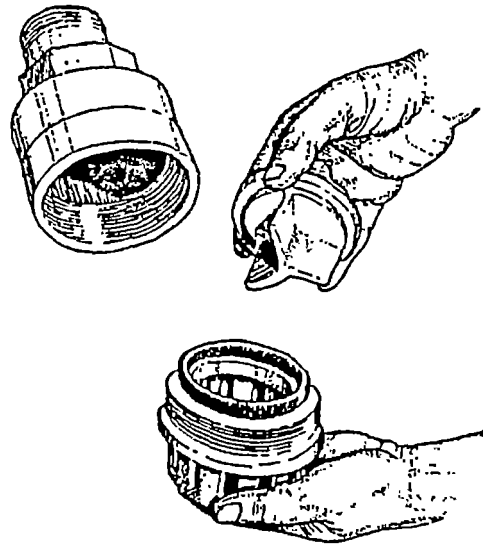

STAGE 16.

**CLEAN ALL PARTS BEFORE
REASSEMBLY**

STAGE 17.

**IF THE PUMP REQUIRES
REMOVING LOOSEN U BOLTS
& REMOVE PUMP HEAD**

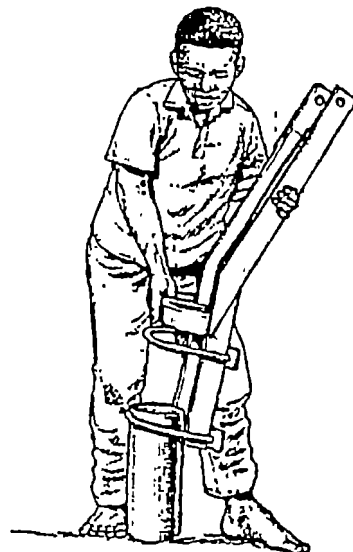

MAINTENANCE

Bush Pumps, like all machines require maintenance if they are to function at their best. In Zimbabwe, Bush Pump maintenance and repair is normally undertaken by the DDF, but certain parts of the maintenance can be undertaken by the community or pump caretaker who lives near the pump.

Pump Head

The Bush Pump has a robust head, and the main requirement is to keep all the nuts and bolts on the head tight. The two main head bolts around which the wooden block rotates should be kept tight at all times. They are secured with a spring washer and single nut, but do need tightening from time to time. This should be carried out with a special pump spanner which has been made for the pump, and should be sold with the pump. Every Pump Caretaker should keep such a spanner.

Over a period of years the floating washers will begin to wear and when the central hole becomes too large the washers should be replaced. This may take several years however.

The holes in the wooden block will also wear very slowly, and when the first set of holes is worn out the block should be moved so that the head bolts work in the second set of holes. This may take many decades. The wooden block works more easily if the main head bolts are smeared with a thin layer of grease from time to time.

Down the hole components.

Most of the maintenance of the Bush Pump is concerned with parts which lie below ground level. Maintenance and repair of down the hole parts includes:

1. Replacement of worn seals
2. Attention to faulty or worn rising mains
3. Attention to faulty or worn pump rods
4. Attention to leaky footvalves
5. Attention to faulty piston/valves
6. Attention to faulty/worn cylinder and barrel nipple

Many problems occur because the parts are not properly cleaned and fitted together carefully and tightly. The pipe threads should be always be cleaned and plumbers paste should always be used on the threaded joints. When the paste is used the pipes are also easier to separate when the pump is dismantled.

1. REPLACEMENT OF WORN LEATHER SEALS

Most seals in Zimbabwe are made of leather, and this forms an excellent material for the piston seals. In most installations, 75mm leather seals may last for 1 - 2 years and then will require replacement. In non-extractable units the rods and rising mains must be withdrawn to gain access to the piston and cylinder. Seals should always be replaced by new leathers and not by partly worn ones as this will shorten their service life and increase the overall costs of maintenance. The following description of leather seals has been provided by Leatherseal Products of Bulawayo.

LEATHER SEAL CUPS

Leather is a unique manufactured product, produced by "tanning" through chemical processes to preserve the hide permanently, whilst at the same time, retaining the natural fibrous structure from which leather's ultimate strength and pliability are derived. During the manufacture of "Leatherseal" borehole cups, the leather is impregnated with oils which fill the fibres and yet still allow water to be absorbed into the microscopic spaces between the fibres. Thus the seal remains flexible for the whole of its life unless it dries out. Leather absorbs and takes in particles of sand and grit and so preserves the smooth finish of the cylinder bore.

HINTS FOR FIELD TRIPS

Always check to see that your tool kit is complete and you have enough replacement parts.

1. **CYLINDER:** Open the cylinder and check to see if the check footvalve is jammed open. Always use correct tools on the cylinder and be very careful that the cylinder is not damaged in any way. Never grip the cylinder in a vice or Stilson wrench.

2. **PISTON:** Dismantle the piston and check piston valve is seating properly. Examine the leather cups. Discard old leather cups. "Leatherseal" borehole cups are usually supplied punched. However, if the cup is not punched a simple method of ensuring that the hole is cut correctly is to insert the plunger follower into the cup and using a sharp narrow knife blade cut along the inside of the plunger follower. This will give a perfectly round hole of exactly the right size. Once the seals are fitted, tighten up the piston assembly. Ensure that the pump rod is screwed into the piston head and secured tightly with a lock nut.

PLUNGER
FOLLOWER

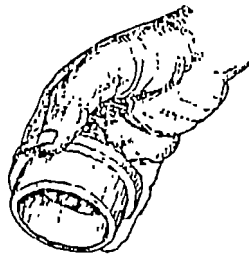

CUTTING THE
LEATHER SEAL

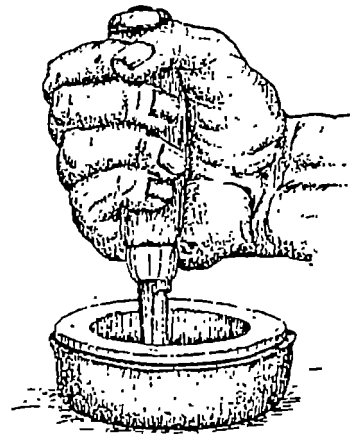

LEATHERSEAL
CUP



3. **ASSEMBLY:** Ensure that the cylinder bore is clean and undamaged. Clean the piston assembly and insert the piston into the cylinder.

4. **TESTING:** Place the entire cylinder/piston assembly upright in a bucket of water and check for the correct operation by lifting and lowering the rod. With the cylinder full of water, ensure that the footvalve is seating - water should not run out of the cylinder base.

2. ATTENTION TO RISING MAINS

Galvanised steel rising mains can last for many years in non-aggressive waters, and this is the case for large numbers of wells and boreholes in Zimbabwe. Where the water is more aggressive GI rising mains will corrode more rapidly. On average at least 10 years of service life should be expected from a good length of GI rising main.

Several factors influence the life of the rising main. Pipes vary in quality and thickness and obviously the best should always be chosen if there is a choice. Occasionally a hole develops in the seam of the pipe. However most pipes deteriorate at the joints where they are threaded. This is because the protective galvanisation is worn off at this point, and is most subject to the effects of corrosion. This is also the part which suffers the most damage during dismantling and assembly of the pump, due to physical wear and tear. **Both these effects can be reduced by using plumbers paste (*Plumbers Delight*) at each joint.** Care should be taken each time the lengths of rising main are connected and disconnected. When the joints are done up - do them up tightly.

Where extractable pistons are used, and the piston seals can be replaced without removing the rising mains, then rising main life will be extended.

3. ATTENTION TO PUMP RODS

The most common problem with pump rods is separation at the joints. This often due to loose and worn threads on the rods and rod sockets (connectors).

The pump rods which are normally made of 16mm mild steel, should be straightened if they are bent, and the threads inspected for wear or corrosion. If the threads or rod sockets are worn the string of rods will separate with constant use of the pump. Old worn threads should be sawn off and a new thread made. On conventional rods the socket is held tight to the rod with a lock nut, but in time this may loosen. This may result from the effect of corrosion which usually begins at the threaded joint. Rod separation is not unusual and is accelerated by the vibration of the pumping action. It is possible to reduce the chances of separating rods and corrosion at this point by applying fast setting epoxy cement at the joints and ensuring that this covers any exposed threaded surface. However such a technique will rarely be performed.

Rods do wear and erode away and become thinner with time. Obviously 16mm rods will last longer than 12mm rods and are also stronger.

It is obviously important to ensure that all the joints are done up tightly and that each rod occupies half of the socket. If the rod is only partly screwed into the socket the joint will separate earlier. It is also important to ensure that the rod joints and the pipe joints do not meet at the same point as this will lead to unnecessary friction and wear.

4. ATTENTION TO LEAKY FOOTVALVES

If footvalves leak, the pump will produce less water per stroke, and will require some priming on every occasion it is used. This may take some time especially on deeper boreholes. This extra pumping will place extra strain on the pump head and all other parts. It is essential to choose a good footvalve in the first place. The best footvalve in Zimbabwe is made by Radiator and Tinning of Bulawayo. This should always be chosen.

The footvalve should be dismantled inspected and cleaned. Check that the neoprene seat and the brass valve make a good seal. The unit should be carefully assembled and screwed up tightly.

Footvalves are normally connected to the lower part of the cylinder with a 50mm GI barrel nipple. This part may corrode away however and render the footvalve ineffective. A better joint can be made by using a brassbarrel nipple at this point. Radiator and Tinning, Bulawayo, who also make the cylinders, have been asked to supply a brassbarrel nipple for use at this point. A footvalve with a male thread for direct attachment to the base of the cylinder is also being tested.

5. ATTENTION TO FAULTY PISTON

Usually the piston fails because the seals are badly worn or other parts of the unit unscrew and fall apart. The piston unit itself may unscrew and separate from the rod. It is very important to ensure that the piston unit is put together correctly and tightly. The lock nut used to secure the piston and the rod should also be done up tightly. Very occasionally the valve itself may fail but this is unusual. Check to see if the valve and its seat make a water tight seal.

It is important to ensure that the seals are in good condition and the right size for the cylinder.

6. ATTENTION TO FAULTY CYLINDERS.

Cylinders rarely give trouble but occasionally the cylinder leaks because the end caps have been screwed up with too much force, and the end of the cylinder may crack. Cylinders wear out more quickly if the water is very turbid or filled with sand, but a properly drilled borehole or dug well should not give this sort of trouble. The cylinder is made of soft brass and should always be handled with care and never held in a vice or pipe wrench. The end caps should be used to attach spanners whilst the rising main and the footvalve are fitted. Potential problems with the barrel nipple attached to the base of the cylinder have already been described.

GENERAL

The Bush Pump is a robust and hard working pump, and if it is installed correctly should give very little trouble. However as the parts become older, they are more subject to fatigue and collapse as in any machine. When a part is worn out it should be replaced. However it is often the case that an existing worn part will be reintroduced back, and the pump expected to perform. Bush Pumps are quite good at providing service with worn parts, but even they have their limits!

FUTURE TRENDS

The trend in the future is to supply those pumps which are less heavily used with extractable 50mm pistons which can be removed through the rising main. This means that it is unnecessary to remove the rising main to change a seal and is a much simpler and quicker operation. Such pumps have a reduced water output compared to pumps fitted with non extractable 75mm pistons. Tests are currently being carried out with 16mm rods which have flexible joints and also non threaded joints which can be disconnected with ease. Experiments are also underway with nitrile rubber seals which are reputed to have a longer service life than leather seals. The replacement of the GI barrel nipple with a brass unit is also being encouraged. The use of PVC for shallow settings is now also being considered, with high impact PVC being considered for deeper settings. It is hoped that these developments will ensure that the Bush Pump continues to provide a good service in Zimbabwe and wherever else it is used.

BUSH PUMP MAINTENANCE

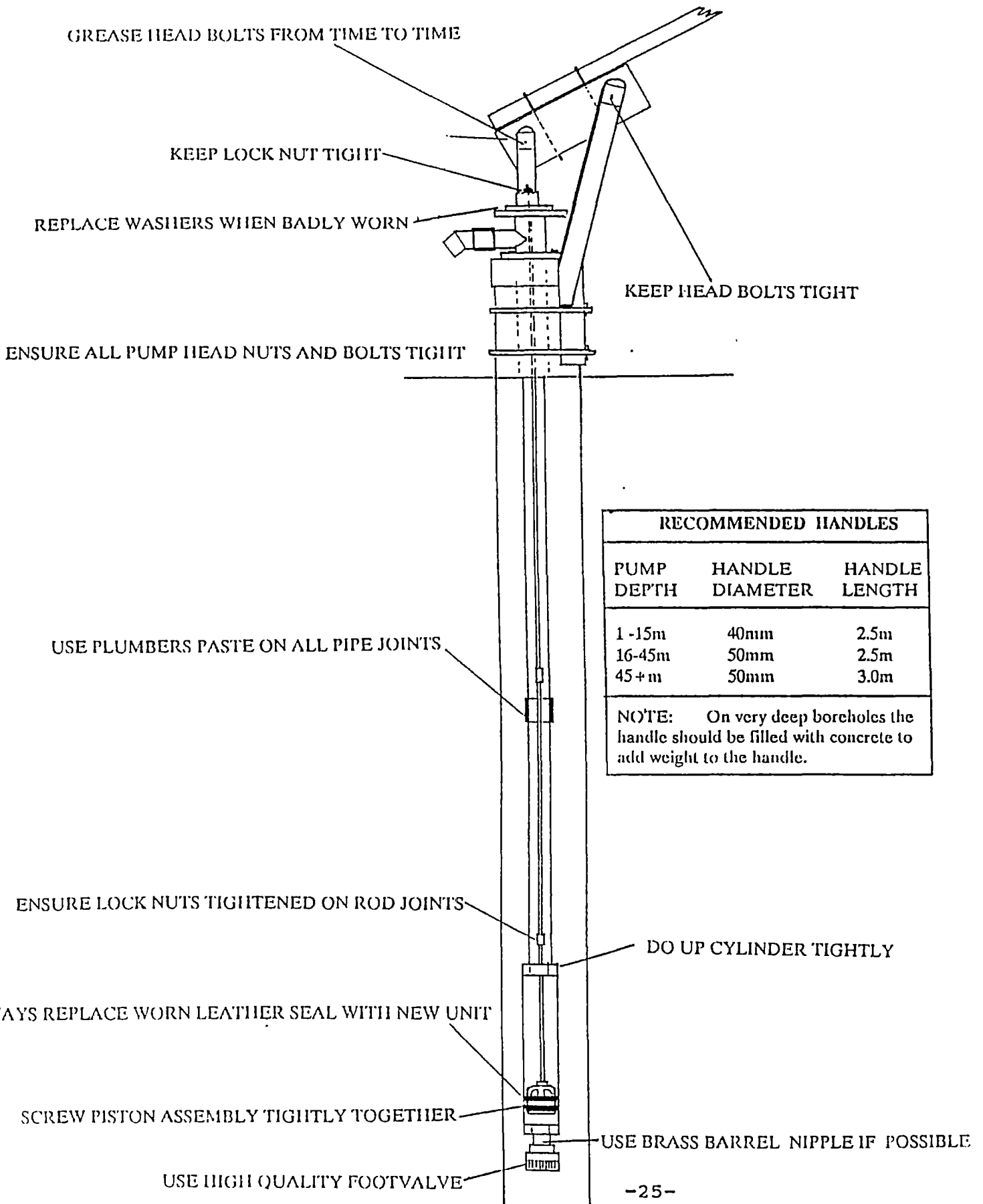

TOOLS

It is essential that Bush Pumps are serviced and repaired with an adequate set of tools. The illustrations below show what tools are required.

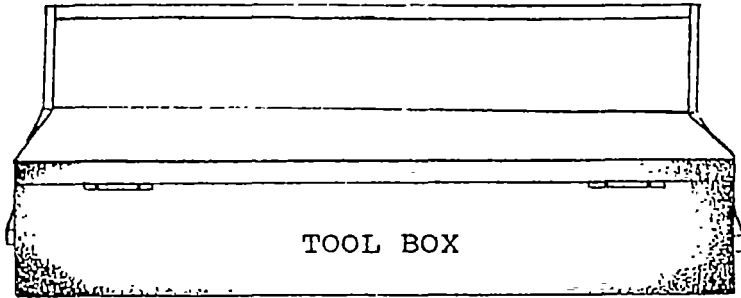

VICE GRIP

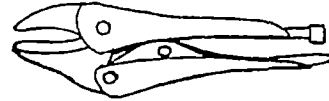

STILLSON PIPE WRENCH AT LEAST 3 SIZES, 610MM, 450MM, 350MM AND IF POSSIBLE 1000MM.

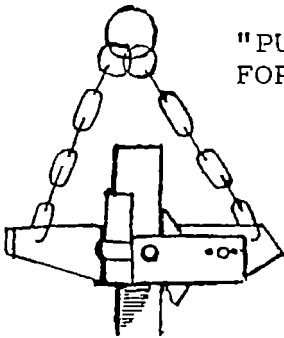

"PULLTITE" CHAIN TONGS FOR 40MM AND 50MM PIPE

A PIPE CLAMP IS USED TOGETHER WITH THE "PULLTITE"

OPENED ENDED SPANNER 19MM AND 24MM

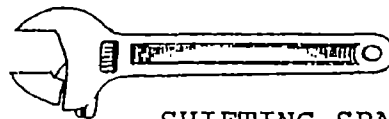
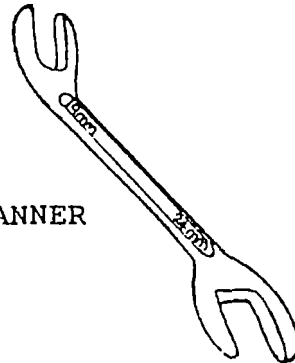

SHIFTING SPANNER 200MM



ROD LIFTING TOOL



ROD DIES, ADJUSTABLE FOR M12 AND M16 PUMP RODS



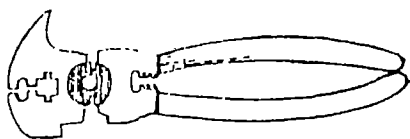

FENCING PLIERS



WATER PUMP PLIERS
240MM



HAMMER

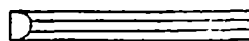

COLD CHISEL



RASP HALF ROUND

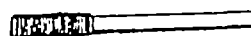

FILE HALF ROUND



WIRE BRUSH

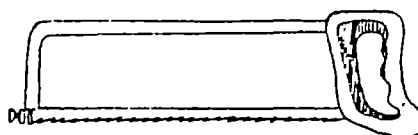

HACKSAW WITH
SPARE BLADES



STRING LINE

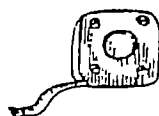

TAPE MEASURE
3 METRES LONG



PIPE JOINTING
COMPOUND

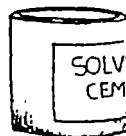

PVC SOLVENT CEMENT



SMALL OIL BOTTLE

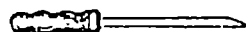

SMALL SCREWDRIVER
FOR ADJUSTING ROD DIES

The "B" type Bush Pump was designed to reduce the number of wearing parts in the pump head and hence the cost of maintenance. The main wearing parts in the head are the floating washers and the wooden block. The floating washers move freely according to the movement of the 16mm rod itself and are not subject to excessive wear. Normally replacement is required after 2 - 4 years of work. The pump will still operate with worn floating washers. The 16mm rods connect the wooden block to the piston directly and this reduces the friction and wear seen in older Bush Pumps. The head bolts are solid steel and designed so they cannot rotate, thus reducing metal to metal surfaces. The wood to metal bearing surface is maintained. Two sets of holes have been retained in the wooden block, which should have a life of at least 20 years. A stroke of 230mm can be achieved with the pump, although the normal stroke is less than this. The bolt holes in the wooden block are closer together compared to earlier Bush Pumps and this provides a greater mechanical advantage which is especially useful for pumping from deeper boreholes. Reduced friction and greater mechanical advantage make for easier pumping. The pump handle should be adjusted to suit the depth of the borehole. On the deeper boreholes a 3m length of 50mm GI pipe should be used and filled with concrete. Spanners should ideally be provided with every pump so that head bolts can be tightened on the spot. The head bolts should also be greased from time to time to ensure a free motion of the block on the pump stand. When properly installed the pump should have a smooth and relatively silent action and there should be no "end knock." The pump is normally fitted with standard 50mm GI rising mains and 16mm mild steel pump rods with a 75mm cylinder, but other down the hole components can be fitted. These will normally be 50mm extractable pistons which also use 50mm GI pipe and 16mm rods.





1

