

- Interface  
for Decision
- Appropriate  
Technology
- Prediction  
and Selection  
Methodologies
- State of the Art
- Reid•Coffey•Editors

## APPROPRIATE METHODS OF TREATING WATER AND WASTEWATER IN DEVELOPING COUNTRIES



THE UNIVERSITY OF OKLAHOMA  
BUREAU OF WATER AND ENVIRONMENTAL RESOURCES RESEARCH

Sponsored by: U.S. AGENCY FOR INTERNATIONAL DEVELOPMENT  
WASH DC 20548  
250-78AP-5177

CONTRIBUTORS

L. W. CANTER	KUNG-CHEH GEORGE LI
KAY COFFEY	J. F. MALINA
RICHARD DISCENZA	MICHAEL I. MUIGA
WILLEM VAN GORKUM	GEORGE W. REID
L. HUISMAN	SOETIMAN
KEES KEMPENAAR	THAILAND MINISTRY OF PUBLIC HEALTH
SUE LIN LEWIS	GAYLE TOWNLEY

479 250  
2nd copy 78AP

# APPROPRIATE METHODS OF TREATING WATER AND WASTEWATER IN DEVELOPING COUNTRIES

LIBRARY  
International Reference Centre  
for Community Water Supply

Edited by  
George Reid  
Kay Coffey

LIBRARY, INTERNATIONAL REFERENCE  
CENTRE FOR COMMUNITY WATER SUPPLY  
AND ENVIRONMENT (IRC)  
PO. Box 13186, 2509 AD The Hague  
Tel. (379) 314911 ext. 141/142  
RN: bn 5177  
LO: 250 78AP  
2nd copy



BUREAU OF WATER AND ENVIRONMENTAL RESOURCES RESEARCH  
THE UNIVERSITY OF OKLAHOMA, NORMAN, OKLAHOMA, 1978  
Sponsored by: U. S. AGENCY FOR INTERNATIONAL DEVELOPMENT  
WASHINGTON, D. C.





# Foreword







# Abstract

For many years developing countries have been working, with external assistance, to promote development of water treatment and waste disposal systems in their cities and towns. Adequate quantities of safe water and adequate sanitation measures are considered to be a necessary but not a sufficient condition for social and economic development; however, up to this time programs simply have not succeeded in keeping pace with the problem of water and sanitation in LDC's. A breakdown has occurred where there have been direct technology transfers which resulted in the selection of treatment processes too sophisticated or costly for in-country construction, maintenance, or operation.

A basic problem, then, relates to site-specific selection of appropriate technology in LDC's. This volume, in part the result of an in-depth study sponsored by the United States Agency for International Development and in part the result of additional and related efforts, is concerned with this problem. Chapters I and II outline the difficulties encountered in donor/client relationships and technology transfer. Chapter III explains a methodology for selecting the most appro-

priate technology for water and wastewater treatment for a particular LDC site and at a particular time, according to the material and manpower resource capabilities available. Chapter IV presents a mathematical model for LDC's in Africa, Asia, and Latin America; to predict water and wastewater demand, as well as construction and operation and maintenance cost estimates for slow sand filters; rapid sand filters; stabilization lagoons; aerated lagoons; activated sludge systems, and trickling filters. The basic technique used in developing this model was step-wise multiple regression working from LDC in-country cost data. Chapter V presents a methodology for setting priorities among LDC water supply programs. Chapters VI; VII, VIII; IX; and X constitute state of the art chapters (for application particularly to LDC's) on past, present, and future technologies for water and wastewater, including on-site disposal and treatment concepts.

The purpose of this volume is to support donor/client efforts to reduce health problems through proper selection of processes and projects, realizing that much of the solution is educational in nature.

# Acknowledgments

This volume evolved from a University of Oklahoma/United States Agency for International Development (OU/USAID) study on "Lower Cost Methods of Water and Wastewater Treatment in Less Developed Countries," under the direction of Regents Professor George W. Reid. Much is owed to a number of people who have helped to develop and implement the project and to prepare this book.

Initially, the OU/AID project was conceived by Dr. Albert Talboys, Dr. Lee M. Howard, and A. Dale Swisher of USAID, Office of Health, Washington, D.C. Without their vigorous and continuous support, the work simply would not have been undertaken. Weyburn D. Davies of USAID was also very helpful. Upon the retirement of Dr. Talboys and Dale Swisher, James F. Thomson and Victor Wehman took over these roles and were particularly helpful in the later stage of the project and in the preparation of this volume. Dr. Silas Shau-Yee Law, formerly Assistant Director, University of Oklahoma Bureau of Water and Environmental Resources Research, and Ralph Martin, Director of Program Development, OU, provided invaluable assistance to the project, helping to facilitate and promote its goals in every possible way.

Dale Swisher, Dr. Talboys, and Ralph Martin assisted in many of the field visits necessary to the project. Individual field studies on the use of particular technologies were directed by Dr. Reynaldo M. Lesaca, Commissioner, National Pollution Control Commission, Manila, the Philippines; Dr. Erasto Muga, the University of Nairobi, Kenya; Odyer A. Sperandio, Director of the Centro Panamericano de Ingenieria Sanitaria y Ciencias del Ambiente (CEPIS), Lima, Peru; Mei-Chan Lo, Director, Taiwan Institute of Environmental Sanitation; Charu Chandr Praphorn, Thailand Ministry of Public Health; and Dr. S. Erol Ulug, Chairman, Environmental Engineering Department, Middle East Technical University, Ankara, Turkey.

A review of the OU/AID project, and in particular the forecasting model for selection of suitable water and wastewater processes, was accomplished through a global conference held in Voorburg, the Netherlands. The conference was jointly sponsored by the University of Oklahoma and the World Health Organization International Reference Centre (WHO/IRC) for Community Water Supply. Numerous world experts were brought to the conference for the review, among them, Professor S. J. Arceivala, WHO Regional Office, Ankara, Turkey; Dr. J. M. de Azevedo Netto of the University of Sao Paulo, Brazil; Dr. B. H. Dieterich, Director, Division of Environmental Health, World Health Organization, Geneva; David Donaldson, Pan American Health Organization, Washington, D.C.; Professor L. Huisman, Delft University of Technology, the Netherlands; Dr. Michael G. McGarry, International Development Research Centre, Ottawa, Canada; Dr. Wilfredo L. Reyes, WHO Regional Office for Southeast Asia, New Delhi, India; and T. K. Tjiok, WHO/IRC for Community Water Supply. Others observing the conference included Willem van Gorkum and Kees Kempenaar, Delft University of Technology, the Netherlands. In addition,



Dr. J. M. G. van Damme, Manager of the WHO/IRC for Community Water Supply, collaborated in the review conference and assumed responsibility for preparation of the original project publications on water supply which were completed at the Delft University of Technology, the Netherlands, as well as a mailing to identify unpublished material on drinking water supply and waste disposal for developing countries.

Numerous individuals helped in the project research which led up to this book, and they deserve special thanks. Dr. Graham G. Don, London School of Hygiene and Tropical Medicine, the University of London, and H. Weber and H. R. Wasmer of the World Health Organization International Reference Centre for Wastes Management, Dübendorf, Switzerland, supplied useful background material on historical methods of water and sewage treatment. Dr. George M. Ayoub, Professor of Civil Engineering, American University of Beirut, Lebanon, provided valuable assistance. Work on some of the initial process matrices was carried out by Dr. Ivon H. Lowsley Jr., University of Missouri -- Rolla, and Dr. Kenneth Govaerts, the University of Nebraska at Omaha, and formerly Associate Director, Technical Programs, U.S. Peace Corps, Kenya.

Others who helped in the project research include Dr. Richard Discenza, Northern Arizona University, and Dr. Michael Ikua Muiga, Federal University of Paraiba, Brazil. Chan Hung Khuong, currently research assistant with the University of Oklahoma Bureau of Water and Environmental Resources Research, assisted in compiling a catalog of water supply and waste disposal methods for individual units. Juan H. Diaz, currently Environmental Officer for the U.S. Army in the Canal Zone, Panama, contributed much of the material on stabilization ponds found in the chapter on wastewater disposal and treatment. Franz C. Lauffer,

a graduate research assistant with the University of Oklahoma Bureau of Water and Environmental Resources Research, contributed many helpful ideas to the chapter dealing with on-site treatment. Andy Law and Weigun Yang, doctoral students with the University of Oklahoma School of Civil Engineering and Environmental Science, helped develop the test kits and manuals to be used for the examination of water and wastewater in the field. Kay Coffey, research assistant with the OU Bureau of Water and Environmental Resources Research, contributed to the project research, and also served as coeditor of this volume.

Chou Gene-Pai, a doctoral student with the University of Oklahoma School of Civil Engineering, assisted in preparing illustrations and in providing technical advice for this volume. Brenda Skaggs typed the entire manuscript.

The following persons were asked to review the preliminary draft, and much is owed for the patience and constructive critiques. They are:

Dr. R. C. Ballance, Division of Environmental Health, World Health Organization, Geneva;

Dr. Martin G. Beyer, Drinking Water Programmes, UNICEF, New York;

Dr. Graham G. Don, London School of Hygiene and Tropical Medicine, the University of London;

John M. Kalbermatten, Water and Wastes Advisor, International Bank for Reconstruction and Development, Washington, D.C.;

William J. Mills, Water Resources Branch, United Nations, New York;

F. W. Montanari, Parsons Brinckerhoff Quade & Douglas, Vienna, Virginia;

Dr. Wilfredo L. Reyes, WHO Regional Office for Southeast Asia, New Delhi, India;

Dr. Abel Wolman, Johns Hopkins University, Baltimore, Maryland;

Dr. F. Yanez, Centro Panamericano de Ingenieria Sanitaria y Ciencias del Ambiente (CEPIS), Lima, Peru;

Dr. Shafiq Yunis, Economic Commission for Western Asia, United Nations, Beirut, Lebanon.

To the contributors of the material which is included in this volume goes credit for much of what is good about this book. However, the editors must take responsibility for the organization and the form in which the material is presented here.

George W. Reid



# Contents

FOREWORD, . . . . .	v
ABSTRACT . . . . .	ix
ACKNOWLEDGMENTS . . . . .	xi
CHAPTER I. INTRODUCTION: INTERFACE FOR DECISION, George W. Reid .	1
CHAPTER II. TECHNOLOGY TRANSFER, ADAPTATION AND UTILIZATION, George W. Reid . . . . .	23
CHAPTER III. PREDICTION METHODOLOGY FOR SELECTION OF SUITABLE WATER AND WASTEWATER PROCESSES . . . . .	39
III.1. Prediction Methodology for Suitable Water and Wastewater Processes George W. Reid and Richard Discenza . . . . .	41
III.2. Prediction Methodology for Suitable Water and Wastewater Processes: Data Requirements . . . . .	73
III.3. Prediction Methodology for Suitable Water and Wastewater Processes: Manual Computation Method George W. Reid and Richard Discenza . . . . .	82
CHAPTER IV. METHODOLOGY FOR PREDICTION OF WATER AND WASTEWATER VOLUMES AND TREATMENT COSTS . . . . .	95
A Mathematical Model for Predicting Water Demand, Wastewater Disposal and Cost of Water and Wastewater Treatment Systems in Developing Countries Michael I. Muiga and George W. Reid . . . . .	97
CHAPTER V. METHODOLOGY FOR ESTABLISHING PRIORITIES AMONG WATER SUPPLY PROGRAMS: A CASE STUDY . . . . .	167
A Priority Setting for the Rural Water Supply Program in Indonesia Soetiman . . . . .	169

CHAPTER VI. IMPLICATION OF PAST DEVELOPMENTS IN WATER AND WASTE- WATER TECHNOLOGY . . . . .	231
Historic Implication for Developing Countries of Developed Countries' Water and Wastewater Technology Kay Coffey and George W. Reid . . . . .	233
CHAPTER VII. WATER SUPPLY AND TREATMENT . . . . .	323
VII.1. Part One. Water Supplies in Rural Areas of Developing Countries (Part One) L. Huisman . . . . .	326
VII.1. Part Two. Water Supplies in Rural Areas of Developing Countries (Part Two) Willem van Gorkum and Kees Kempenaar . . . . .	359
VII.2. Study of an Existing Water Treatment Plant of Simple Design and Operating System for Supplying Drinking Water to Rural Communities in the Lower Mekong Basin Countries: Study of a Slow Sand Filter Thailand Ministry of Public Health, Department of Health, Rural Water Supply Division . . . . .	381
VII.3. Small Wells, Slow Sand Filtration, and Rapid Sand Filtration for Water Supplies in Developing Areas Kung-cheh George Li . . . . .	406
CHAPTER VIII. WASTEWATER DISPOSAL AND TREATMENT . . . . .	437
VII.1. Sewage Treatment in Developing Countries L. W. Canter and J. F. Malina . . . . .	439
VII.2. Aerated Lagoons Kung-cheh George Li . . . . .	483
VII.3. Land Application of Wastewater Sue Lin Lewis . . . . .	491
CHAPTER IX. ON-SITE DISPOSAL AND TREATMENT . . . . .	519
Cost-Effectiveness of the Socio-Cultural and Health Benefits of Sewerless Alternatives for Domestic Waste Disposal in Developing Countries Gayle Townley . . . . .	521
CHAPTER X. EXPEDIENT TECHNOLOGIES, George W. Reid . . . . .	621
APPENDIXES . . . . .	631
SELECTED BIBLIOGRAPHY . . . . .	727

## CHAPTER I

# Introduction: Interface for Decision

George W. Reid

A 1971-72 survey by the World Health Organization of community water supply and excreta disposal conditions in developing countries revealed that nearly one-third of the world's population (over one billion people) have no adequate water supply, and only 0.8 percent of the total population of developing countries is served by sewage treatment facilities (53). As a result of this survey the United Nations Second Development Decade goals included the supplying of all urban populations with water, either by house connections or by public standpipes, and the provision of reasonable access to safe water for one quarter of the population in rural areas by 1980. Based on achievements by 1975, percentage goals were increased to thirty-six percent of the rural population, and excreta disposal targets were established for the first time. However, despite great efforts, populations have increased more rapidly than new facilities can be installed.

In 1975, the Global Workshop on Appropriate Water and Wastewater Treatment Technology for Developing Countries was held. This was a collaborative effort between the University of Oklahoma and the WHO International Reference Centre for Community Water Supply. The objectives of this workshop were:

- to assess the state of the art and to identify the role that appropriate technology can play in the development of water supply and sanitation in developing countries;
- to formulate technical and organizational recommendations and to agree upon priorities for studies, projects or other activities; and
- to discuss the development of internationally coordinated programs and the operation mechanisms for implementing the activities planned as a result of the meeting.

In addition to confirming the WHO survey, the Global Workshop focused on many of the types of failures in the planning and provision of water supply and sanitation in developing countries which result from imported technology, and the Workshop indicated the need for appropriate technologies consonant with local socio-economic conditions. Some of the factors which severely handicap programs to provide safe drinking water and efficient sewage disposal are:

- shortage of resources (including trained personnel and finances),
- lack of governmental support within the developing countries,
- inadequate institutional structures (insufficient organization and administration),
- lack of local interest and acceptance of the project.



It was the consensus of the group that water supply and sanitation must be considered an integral part of the development process, and national, overall plans should be formulated. Each country should be urged to establish its own water resources agency to collect pertinent data and to plan with a regional approach rather than a case-by-case approach. Strong ties should be established between water agencies and universities. Efforts should be made to motivate governments to implement water supply and sewage schemes. Frequently, proper sewage treatment and excreta disposal have been given such a low priority that pollution control has been postponed until the problem was too great for solution with available community resources. Hopefully, a national plan and greater governmental involvement would help to alleviate this problem.

The Workshop concluded, however, that it would be necessary to assist developing countries to improve their strategies for increasing the rate of rural water and sanitation coverage, if they were to be able to provide even the most basic water and sanitation services to all those who need them within any reasonable time frame. More international funds should be devoted to the rural sector and to low-income groups which are most in need of assistance. Although dispersed populations are among that group which is in great need, actions to alleviate the situation could be made more effective if they were concentrated on groups such as nucleated units or villages.

The Workshop suggested that when equipment or technology is supplied, it should be only after a means of supply for repair parts and maintenance equipment is known to be available. Many existing facilities are in bad condition due to poor selection of technology, inappropriate

priate design, insufficient maintenance including preventive maintenance, a lack of spare parts, and a lack of trained personnel. Locally obtainable materials should be utilized whenever possible, and maintenance of equipment should be manageable by local people.

Experiences in Latin America, India, and elsewhere have shown that besides lower levels of technology, a high level of technology may also be useful in a developing area, where an advanced technology often may be applied and adapted using local materials.

Frequently, it has been the case that local professionals prefer to rely on a foreign consultant rather than risk a possible failure or introduce techniques based on their experience but without established records of performance. To encourage the use of lower levels of technology an effective approach seems to be the training of local engineers who in turn would train other local people. A "barefoot engineer" scheme analogous to the "barefoot doctor" concept was suggested.

Involvement of the people concerned from the beginning of a water supply or treatment project is important. Sometimes much persuasion and education are necessary to get people to use safe water. Local decision makers need to understand the basic principles of the various processes and support the ideas introduced. Some suggestions to help bring this about were handbooks in simple language for laymen, pilot demonstration plants, short courses, and experimental plants connected with plants in operation.

It was emphasized that groundwater should be given greater attention as a source of water supply because it usually does not require extensive treatment. Slow sand filtration has proven to be an effective

treatment method in developing areas. Solution feeders are preferable to dry feeders in these locations because they are less expensive, more reliable and efficient and do not have to be imported. For flocculation and sedimentation all mechanical devices should be discouraged. It was emphasized that in summary, an appropriate technology is one which is accepted by the users and can be maintained by the community.

The importance of the quality and quantity of a water supply to human and economic health has been clearly demonstrated and has been the target of international development efforts in less developed countries (LDC's). Experience has shown that international investments have not been efficiently or effectively used where selection and use has been made of inappropriate technology. The genesis of this text was the recognition of these failures. Chapter II deals specifically with technology transfer, adaptation, and utilization.

Developed countries (DC's) have generally supplied DC engineering which represented what was conceived to be the latest technology, and often LDC decision makers have wanted to be identified with the latest technology. Unfortunately, this has not always been the most appropriate choice for a particular situation. Engineers working on water supplies for low-income countries, have had "safe" water in mind as one objective. However, for the great majority of the world's population who live in rural communities or densely populated and unorganized urban areas with grossly inadequate access to safe water, there is little possibility that available financial and human resources would be able to give them the same high standards of water provision as that enjoyed by most people living in more developed areas. Because resources are very limited, it is necessary to examine closely the goals of

water supply in order that what resources are available may be allocated in the most rational and effective manner. If a very high standard of water provision is unattainable, that does not mean there is nothing worth attempting. There are usually many improvements possible which, though falling short of the ideal, may have a very considerable impact on health or on other problems of the local community.

The approach presented in this text to aid in the resolution of this problem is (1) to assist the consultant in using a systems approach and in identifying the major alternatives; (2) to devise ways to present the alternatives to LDC decision makers, thus facilitating diffusion; and (3) to assist LDC's in developing self-sufficiency in the selection or producing of appropriate technology. In 1973, the University of Oklahoma undertook a study which resulted in a methodology to select appropriate low cost treatment methods for specific LDC sites. The methodology has been tested for user and consumer acceptance through exposure to engineering consultants, a global conference of LDC decision makers, international agencies, and financial institutions. During the study, it was necessary to acquire information on transfer failures, on the state of the art of LDC processes and LDC process costs, from literature and from on-site sources. Also undertaken were detailed studies of selected global sites as well as a historic study of the use of processes in DC's. It was found useful to develop a system of analytical tests that would be adequate for quality control and would be supportable in-country. These efforts resulted in several publications under the sponsorship of the United States Agency for International Development (US AID) and by the World Health Organization International Reference Centre for Community Water Supply in the Netherlands (IRC/NL). (See Bibliography p. 727.)

In studying the problem of technology transfer, the engineer/client relationship was seen to be of critical importance:

In the design of water supplies the choice of components, materials and dimensions is often governed by codes of practice or by professional conventions which engineers trained in the West too readily take for granted. And not only do these conventions tend to limit the adaptation of design to local needs, but like the WHO standards for water quality, they are suited to the needs of urban water supply in Europe rather than to village water supply in the tropics. Thus codes of practice may lead to the choice of unnecessarily expensive materials or equipment, or may discourage an engineer from improvising when the "correct" components are not available. Every village deserves the best possible engineering design for meeting all the immediate objectives, but given the kind of objectives which seem right for rural water supply, the "best possible" may not always look a good solution when measured against Western codes of practice.

Some engineers are conscious of this dilemma, but feel that if they chose an unorthodox solution to a specific problem and the equipment failed and led to an outbreak of disease, they would carry an undue burden of responsibility; but if they had followed the "correct" design conventions, they would not be blamed (21).

The engineer working to bring technology to an LDC works in an alien, and in many ways, a very complicated environment. Pictorially, one can identify at least eight separable, frequently conflicting elements which he must take into consideration or deal with in his work. (See Figure I.1.) In his role of selecting appropriate technology, the engineer operates to meet national health standards and perhaps international standards. The plan must fit into larger water schemes; usually it must be designed without any sort of long-term physical data or national or local funding, and donors must be located. The environment must be able to support operation and maintenance, and local political and business interests exercise special requirements in many instances.

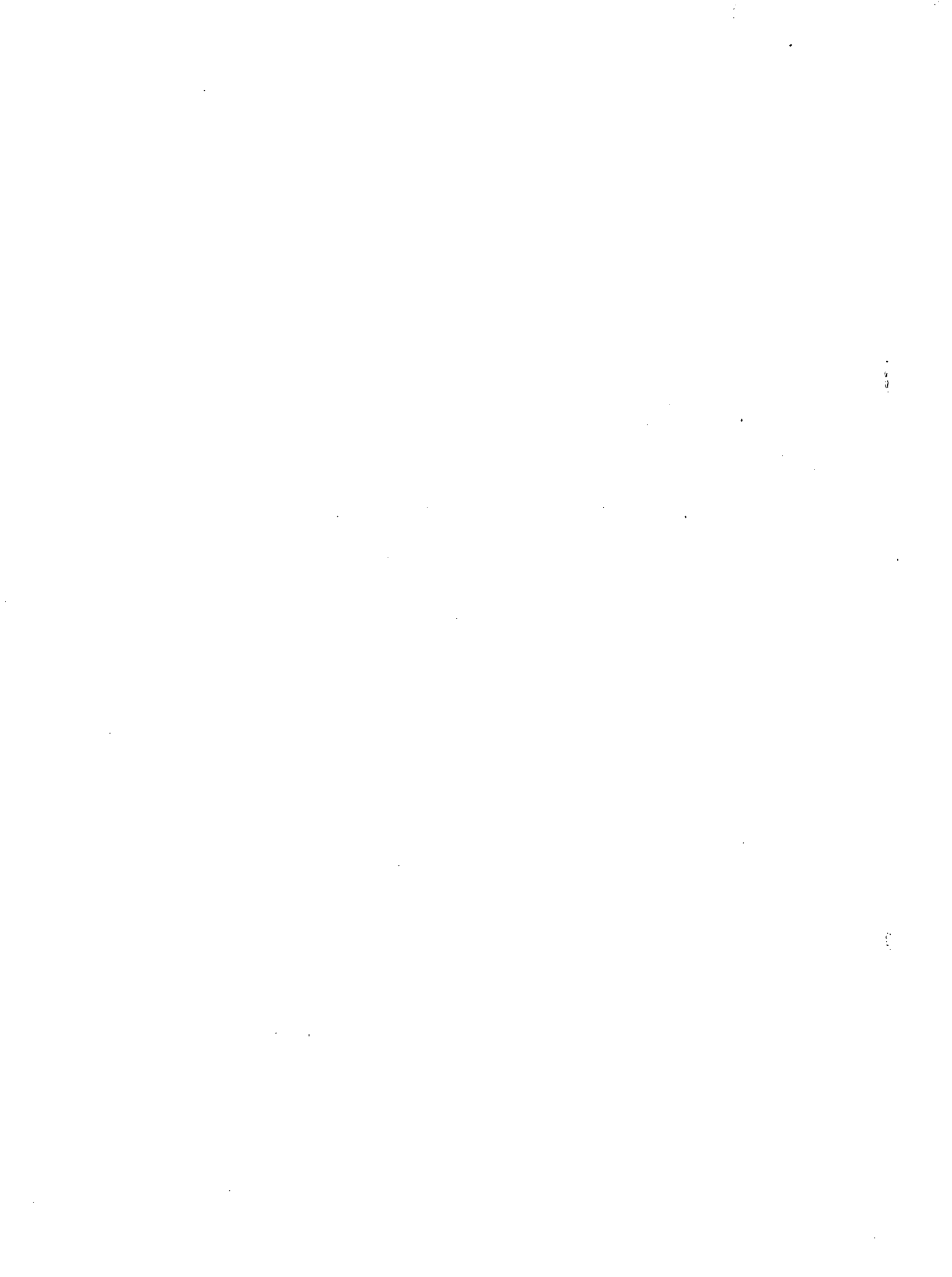

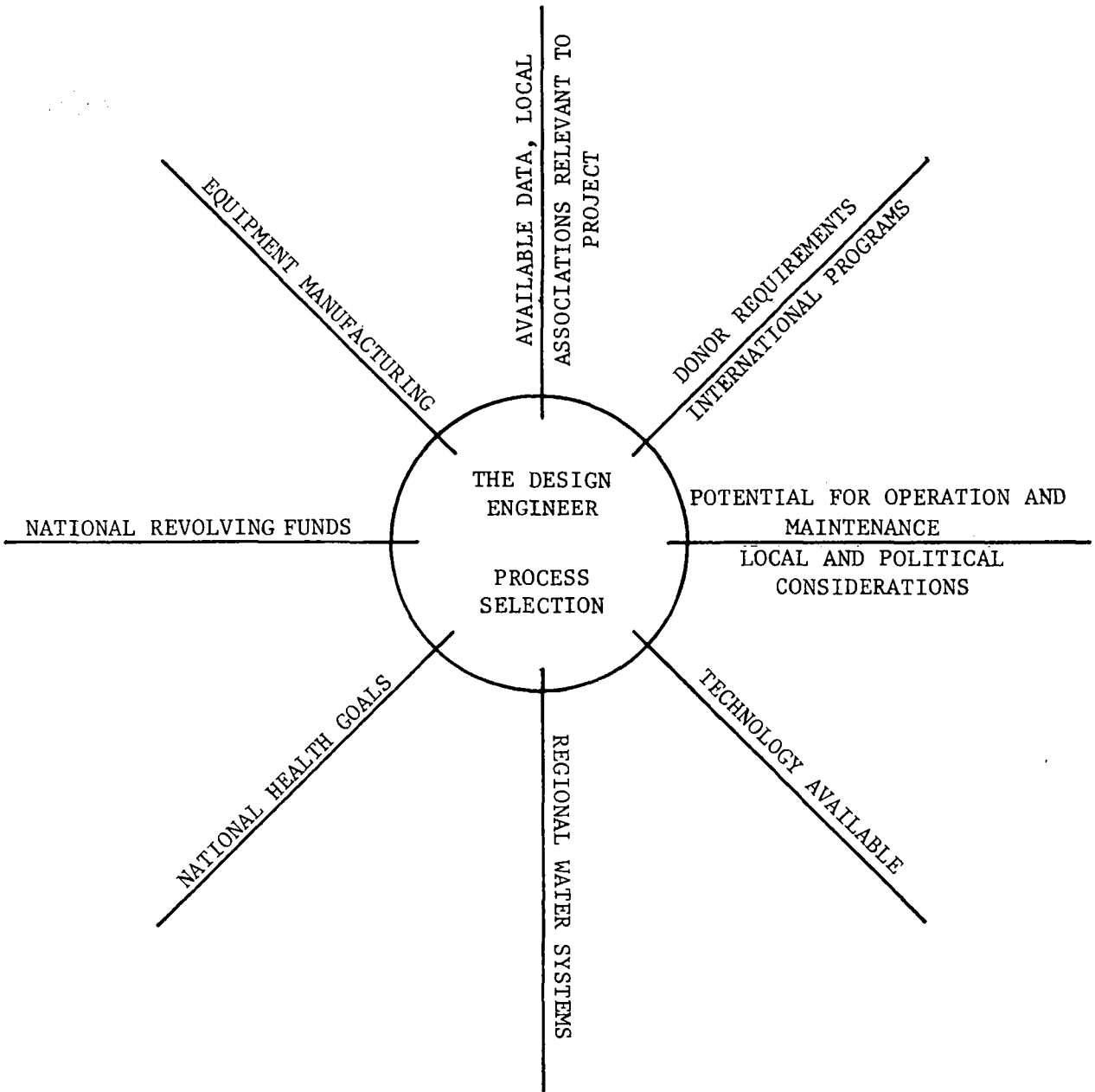

Fig. I.1. Conflicting elements which affect the engineer working in an LDC situation.

A study made by Reid for the Avco firm and the American Society of Civil Engineers included research on the types of technology most often preferred by decision makers. The results showed that eighty percent of the decision makers wanted what everyone else was currently using; fifteen percent wanted older, cheaper solutions; and only five percent would consider newer, innovative solutions. The decision maker was concerned about the present, and the problems of the future and problems associated with operation and maintenance were considered to be problems for future decision makers. The engineer's interest, too, was shown to be limited to the immediate task of getting the plant built. This meant that neither the decision maker nor the engineer appeared to be interested in the ability of the site to keep the process going. In response to this common problem, there have been attempts to require the engineer to provide operational follow-ons for completed projects, such as including in the contract certain requirements for supervision and training for an initial period.

Quite often plants have been over-designed technologically. Financing has been based on capital costs only (ignoring operation and maintenance costs). Proper operation has been lacking and replacement parts and materials non-existent. If a piece of equipment failed, it was replaced rather than repaired. If enough parts failed so that the plant stopped functioning, a new plant was planned and built. One remedy sought by international agencies for this situation has been the provision of short-term training for operators and a more formal education for in-country engineers.

It has often been the case that the in-country engineer has preferred to transfer design responsibility to an out-of-country expert, someone who would come in, execute the job, and leave. This has



increased the difficulty of arriving at an appropriate selection of technology. In general, the international engineer would be unfamiliar with the local situation, involved in keeping people happy and in getting the job done, and little concerned about what happened after he left. The local engineer quite often would identify with out-of-country technology for reasons of prestige, and the client was in an insecure position, being approached by various equipment salesmen vying for contracts.

The following paragraphs present nine specific problems associated with the use of expatriate advisers in developing countries.

The Promoters--These are people who present themselves as seasoned investors who sell grandiose projects to the government through contacts at high official levels. These schemes usually result in low returns or outright losses which are often borne entirely by the government. The solution offered is to "know your investors," admittedly a difficult task.

The Biased--Misallocation of resources may result because of biases in the experts' appraisal of investments. This problem can be solved by insuring that a careful economic feasibility study be carried out.

The Vacationers--This problem refers to foreign specialists whose professional interest is dominated by their desire to see the world. The nationals are often very sensitive to the degree of sincerity of the advisor and their attitudes and cooperation are influenced accordingly. Careful screening of candidates for foreign assignment is required to circumvent this problem.

The Impossible--This problem occurs when the advisor has been charged with a task that is too difficult to accomplish effectively, given the constraints under which he must perform. Recognition that the advisor does not possess all knowledge, especially as concerns intimate details of the country, and cooperation of resident specialists can alleviate this problem.

The Irrelevant--Donor countries may offer financial and technical assistance for a particular project that would be a misallocation of effort for the developing country. Development, in most cases, should be confined to a country's more obvious and immediate needs.

The Confusion--Too many advisors on the same project can cause confusion and result in inappropriate actions. The solution offered is for the developing country to be more selective and able in the use of foreign specialists.

The Out-of-Place--Technology of an advanced nation cannot be imposed upon the developing country unless it has been appropriately adapted to local conditions.

The Sophisticates--This problem arises when highly refined techniques of analysis or application are used when simpler procedures are in order. This is a special case of the previous problem category. A clear understanding of local issues and conditions will greatly aid the selection of appropriate techniques and procedures.

The Old Timers--After long tours of duty, some advisors may become out of date, complacent, and non-progressive, and, therefore, ineffective in accomplishing the objectives. These characteristics do not apply to all "old timers" of course. (33)

The engineer/client relationship is important in technology transfer. There is also a need for an improvement in communication linkages between the LDC areas of need and sources of technology in DC's and LDC's. To develop in-country competence and self-sufficiency, it will be helpful to establish local and regional centers of technology. The extent to which LDC's use research and technology developed abroad is directly related to the "absorptive capacity" of these countries, that is, the readiness and capability of specialists and institutions to adapt, apply, and disseminate the technology. This capacity is important whether the technology is being transferred in the form of equipment, as technical information, or through exchanges of people. It embodies a capability to recognize the alternative technical approaches that are or could be available; to choose the technology that makes the most sense technically, economically, and socially; if necessary, to be able to adapt the technology to local conditions; to understand the direct impact and the more subtle long-term impacts of the technology; and to operate and maintain the technology.

Institutional orientation is often the decisive aspect of a developing country's capability to absorb technology. For example, there are a large number of LDC students at most DC universities. But

are their courses of study truly of relevance to interests back home, or will they give further impetus to the brain-drain? While it is difficult for a United States university on an institutional basis to make sudden changes in the orientation of the content of its academic curriculum, individual professors and instructors can introduce elements into their courses which will enrich the experiences of developing country specialists and allow them to return home better prepared to face the realities of development. Many of our university professors maintain collaborative linkages with a large number of researchers abroad. The substantive aspects of those linkages, exchange of technical reports and joint research efforts, can do much to influence the orientation of research activities in developing countries.

It is difficult for a country that does not itself possess a reasonable number of trained scientific and technical personnel to know what usable technology exists elsewhere, to understand it, to adapt it to the country's special needs or peculiar conditions, to repair and maintain the necessary equipment, or indeed to operate it. If a country builds up its own scientific and technical capacity, it is in a much better position to utilize what exists elsewhere. Lack of appropriately trained persons is often an obstacle to the wider application of technology that is already known and to some extent used in a country. In addition, each country is better able to hold its place in international competition if it has the capacity itself to introduce innovations (new products or less costly methods of production) based on existing technology.

In the chapters which follow an attempt is made to describe an ordered method of selecting for a particular site and at a particular

time, the most appropriate technology from those available in the LDC's as well as in the DC's. To develop such a scheme it was necessary to select certain limits. In this instance, the concern is drinking water and wastewater for organized communities (villages, towns, or cities, extending from the smallest nucleated settlement to perhaps all but the very large LDC cities which usually can afford water and wastewater treatment and have available a variety of high level expertise). This is not to say that rural areas without community systems are not important in LDC's, but certain limitations must be made, and as dispersed rural areas become nucleated, non-structural systems of water supply and waste disposal or treatment are of special interest. It is for this reason that a management system of on-site processes is examined.

There is a need to differentiate between that which is nucleated and that which is not, as concepts of community differ, particularly among professions (such as engineers, ecologists, sociologists, health workers, or economists). It is proposed here that a nucleated settlement begins at or above that population concentration level where there exists a physical water system and an associated managerial system. In general, the management system in a nucleated settlement will no longer be a volunteer operation, and this breakpoint occurs at a population of about 300 or more. At a higher population level of about 3000 persons, piped water becomes cheaper than unpiped water (21). Piped water requires a distribution system and a higher level of technology than does a system of unpiped water. Population density is a significant factor in determining the cost of a piped system. For a piped system to be preferred on a cost basis, the population density should be

about 1.7-2.0 people/acre or more. (See Figure I.2.)

In LDC settlements with a population of less than about 300, the technology of concern will be related to protection of the supply, provision of pumps, storage, and treatment, all of which will probably be manageable on a local, volunteer manpower basis. There is no room for sophistication. There is usually no liquid sewage and no water oriented industry. On the other hand, in a nucleated settlement with a system of piped water, unit use will be greatly escalated and benefits expanded.

In a non-nucleated situation, health is usually protected through supply protection, not through treatment. With nucleated settlements, the settlements which are of primary concern in this text, larger volumes of water are usually involved, and treatment and distribution will be factors of importance. Also, there will be the potential of a considerable health risk because of the volumes of wastewater produced and the possibility of pollution of raw supplies by the effluents. Water treatment and sewage treatment begin to be of real concern at a population level of from about 2000 to 3000 people. Consideration is also given in this text to a special case of the low density settlement, where on-site sewage disposal or treatment is used or water distribution is accomplished through a vending system, and a managerial system is required.

In this text, the primary concern is with a safe domestic supply of water and disposal of wastewater in LDC cities and towns. The entire process could involve technologies ranging from a dam and intakes, pipes and pipelines, to treatment and distribution followed by sewerage systems,



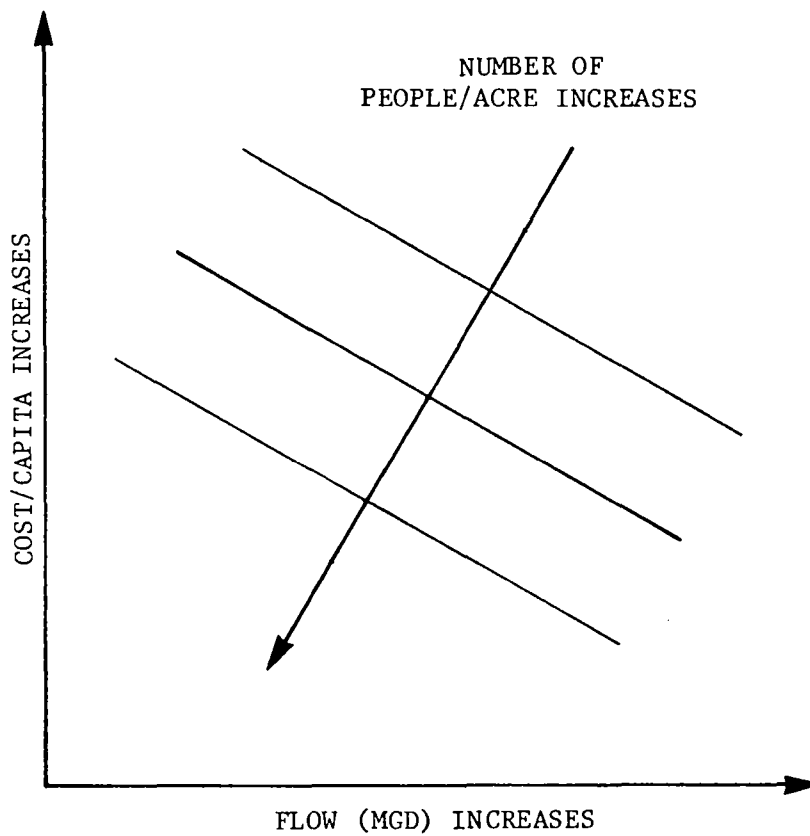

Fig. I.2. The effect of population density and economy of scale on the unit cost of piped water. As the flow required increases, the unit cost decreases. Increased population density also decreases the unit cost.

treatment, and discharge. However, the main emphasis here is limited to treatment with the other components being left for examination by other interests.

The selection methodology is described in Chapter III. It involves the systems approach and aggregate modelling. The systems approach permits the analyst to look at various interrelationships and decision options at one time. Aggregation models use attributes expressed as averages, such as the level of education, the age, or the state of health of an average but non-existent representative of a population. For example, the average United States male might be described as a person who is five feet eleven inches in height, weighs 170 pounds, earns \$14,000 per year, and uses two liters of water and 2,500 calories per day. The attributes for LDC modelling must be representative and must be based on available data on the LDC site either obtained directly or through the aid of a surrogate. Judgment in application is absolutely necessary.

Formally, the selection methodology includes the following components:

1. model: a symbolic representation of the problem;
2. metrics: specific goals such as parts per million (ppm), biochemical oxygen demand (BOD), and Most Probable Number (MPN);
3. alternative solutions: different processes or combinations of processes;
4. validation and diffusion.

In developing the methodology, it was necessary to describe sites and processes, identifying their efficiencies, costs, and manpower requirements. Resources had to be identified and goals and quality standards articulated. A system of socio-economic site



classification had to be devised based on aggregate attributes of the site. In the use of the selection process the methodology proceeds as in Figure I.3.

Details are given in Chapter IV on the assembling of cost and demand figures for water and wastewater treatment systems. Chapter V presents a methodology for setting priorities for water supply programs. Chapter VI is a historical study of DC water and wastewater technologies and their impact upon the societies that made use of them. This material can assist in the application of historically used methods where they are found to be compatible to LDC sites. It can also help LDC sites to avoid the problems which occurred in the process of DC development in the field of water supply and sanitation. Chapters VII, VIII and IX comprise the state of the art of technologies for LDC's for water supply and treatment, wastewater treatment and disposal, and on-site disposal and treatment devices, respectively. Performance data are also assessed in these chapters. Chapter X presents expedient technologies which either were not included in the more formal classifications of Chapters VII, VIII, or IX, or which it seemed beneficial to introduce from the point of view of application in village or individual dwelling situations, where maintenance is often accomplished on an individual or purely voluntary basis.

Table I.1 presents a suggested classification of levels of economic growth in terms of gross national product per capita. This is related to the socio-economic system of site classification used in the methodology described above. There are several world agencies concerned with development that are attempting to provide people with opportunities for a better life. Although economic growth is an

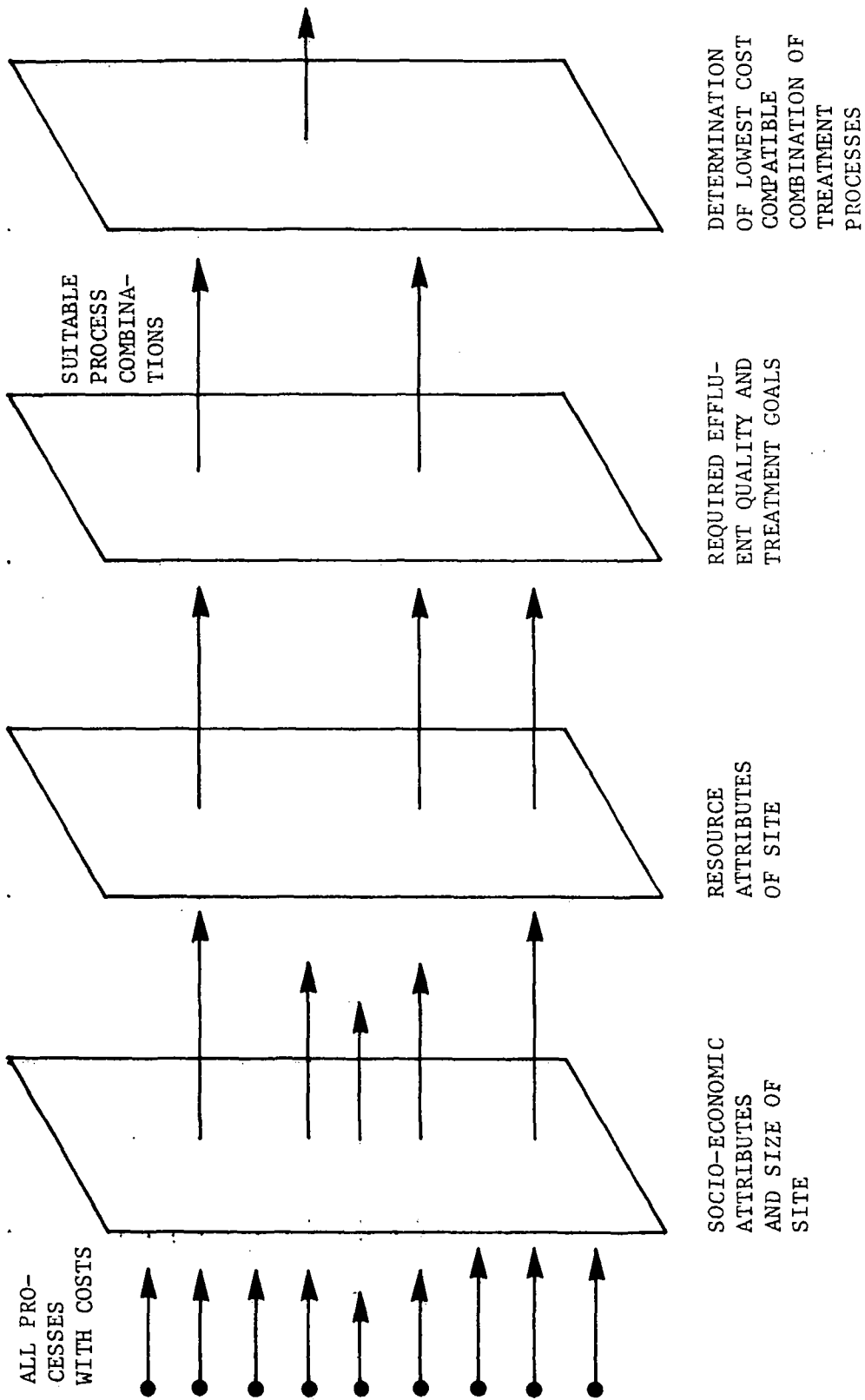

Fig. 1.3. Types of screening involved in the selection of a compatible lowest cost combination of treatment processes.

TABLE I.1

THE STAGES OF ECONOMIC GROWTH BY GROSS NATIONAL  
PRODUCT (GNP) PER CAPITA IN SELECTED COUNTRIES

Country	GNP Per Capita (1971-1972 \$U.S.)	Level
1. Haiti	93	I (underdeveloped)
2. Bolivia	234	
3. Ecuador	260	
4. Honduras	268	
5. Paraguay	273	
6. El Salvador	304	
7. Colombia	328	
8. Guatemala	365	II (partially developed)
9. Guyana	365	
10. Dominican Republic	404	
11. Brazil	452	
12. Nicaragua	474	
13. Peru	493	
14. Costa Rica	579	
15. British Honduras	580	
16. Uruguay	686	
17. Mexico	717	
18. Honduras	729	
19. Surinam	750	
20. Chile	796	III (semi-advanced)
21. Panama	804	
22. Trinidad and Tobago	933	
23. Venezuela	1,010	
24. Argentina	1,138	
25. United States	5,073	IV (developed)

SOURCE: U.S., Agency for International Development, Economic Data Book (Washington, D.C.: U.S. Department of State, Statistics and Reports Division, 1973).

ultimate objective in development, the essence of the development process is human development. Modern concepts of development closely interrelate economic and social activities; they are inseparable and of equal importance. Social development deals with education, health, welfare, and public utilities.

Because of the desire to shorten the time needed for development, as compared to the time taken by countries such as the United States, Canada, and Australia, a great deal of attention is being paid to the selection of the most effective development investments among the many choices which are possible. The basic criterion, in most cases, is the economic return to the country concerned, and expenditures for services such as public health, malaria control, hospitals, and water resources must compete for priority with numerous other investment opportunities in fields such as transportation, agriculture, industry, and education.

In the past, health services have been promoted on the basis of their social rather than their economic benefits. Recognizing the current emphasis placed on economic development, the World Health Organization and the World Bank have accepted the impracticability of financing public health projects on a wide scale based on social benefits alone. However, there is a serious lack of reliable information on the relationship between health and economic development. In accordance with modern theories of economic development, capital investment in public waste treatment and water supply, like the investments in malaria eradication or public health in general, should be considered as part of the social-overhead capital needed to develop and maintain a society.

The environment in which one attempts to make a selection of appropriate technology for water or sewage treatment has been described, and a methodology based on the systems approach and an aggregate model suggested. Here, as elsewhere in the material contained in this text, a need for the diffusion of information and ideas in the LDC's as well as in-country self-reliance, is suggested and emphasized.



## CHAPTER II

# Technology Transfer, Adaptation, and Utilization

George W. Reid

The technological development process, which was in effect a revolution, enabled more people to be supported at a higher standard of living. Unfortunately, this process did not develop uniformly throughout the world. Therefore, there came to be tremendous gaps between different areas. The transfer of technology from developed countries to less developed countries has shortened the time required for LDC's to reach more advanced levels of technological development. However, the direct transplanting of water and wastewater treatment technology has not led to satisfactory utilization of either foreign or domestic resources. The approach needed is an innovative use of known technology as well as the devising of new technology in order to arrive at the simplest and cheapest treatment methods possible while taking advantage of local manpower, materials, and socio-economic goals.

The purpose of this text was to present a method for selecting the technology suitable for maintaining simple, lower cost water and waste treatment facilities for small as well as larger communities in developing countries. This involves selection and assembly of the most useful and pertinent contributions from the world's technical literature on low cost approaches; the obtaining of design criteria, operation requirements, and actual test data; and the assembling of cost figures on past and current technology for water and waste treatment. The ultimate objective is to harmonize this material with the human resources, skills, technology acceptance, as well as the culture, economics, and other conditions prevailing in representative areas in Asia, Africa, Latin America, and the Near East.

The key elements of this approach are: (1) systematic evaluation of the importance and interrelationships of all relevant aspects of the problem, such as technical, economic, social, political, and cultural factors; (2) assessment of alternative courses of action; and (3) analysis of benefits and costs or cost effectiveness on the basis of which policies can be determined and decisions made. Emphasis, then, is on obtaining a grasp of the total picture, putting the pieces together in a practical and usable way, so that international health organizations, lending agencies, and regional, national, and local institutions will have a viable planning tool.

For some time now, water has been recognized as a high level priority for LDC's, and the principal reasons given for past failures in this area, have involved problems associated with inappropriate technology. Concentrating on the mechanics of technology transfer



(including problems of implementation) should improve the situation for donor investments in LDC water systems. In order for proper overall development of a country to take place it is necessary for that country to have the ability to feed its own people and provide for social services such as health and education. Pure water is then a necessary but not a sufficient condition for development. If this ability to provide for these basic elements is not realized, technological transfer can lead to a type of colonialism.

Technological transfers can be conceived of as going both ways. For example, DC's are learning more about the use of aqua culture from experiences in LDC's; however, the major exchange is in the opposite direction as is shown in Table II.1.

The simple transplant and utilization of developed countries' technology at developing world sites is seldom the answer, whereas viable solutions can be provided by the unique application of DC science to LDC problems, or by an intermediate position, where DC technology is modified or adapted to LDC countries. The following diagram (Figure II.1) indicates the way in which these problems and their solutions can be interrelated with science and technology.

Whereas scientific research is concerned with the increase of knowledge and understanding and usually results in publication, technology is directed toward application to a new use or user. It may be a direct application, or there may be a need for adapting or tailoring. Innovation is initiated not just through the generation of an idea or invention, but it can also be stimulated by recognition of a need or technical opportunity. Most successful innovations derive from need recognition rather than from idea generation or inventions;

TABLE II.1  
TECHNOLOGICAL BALANCE OF PAYMENTS  
ESTIMATES FOR 1964

	Receipts (percentage of world total) <sup>a</sup>	Payments (percentage of world total) <sup>a</sup>
U.S.A.	57%	12%
U.K.	12%	11%
Germany (F.R.)	6%	14%
France	5%	11%
Other Western European Countries	18%	25%
Japan	1%	13%
Other Developed Countries	1%	6%
Developing Countries	1% <sup>b</sup>	8%

SOURCE: C.D.G. Oldham, C. Freeman, and E. Turkcan, Transfer of Technology to Developing Countries, Study of the Science Policy Research Unit of the University of Sussex, for the U.N. Conference on Trade and Development, Second Session, TD/28/Supp. I (November 10, 1967). (Based on Office of Economic Cooperation and Development data.)

<sup>a</sup>Excluding transactions among socialist countries and between those countries and developing countries.

<sup>b</sup>Receipts of developing countries were negligible and in any case less than 1 percent.

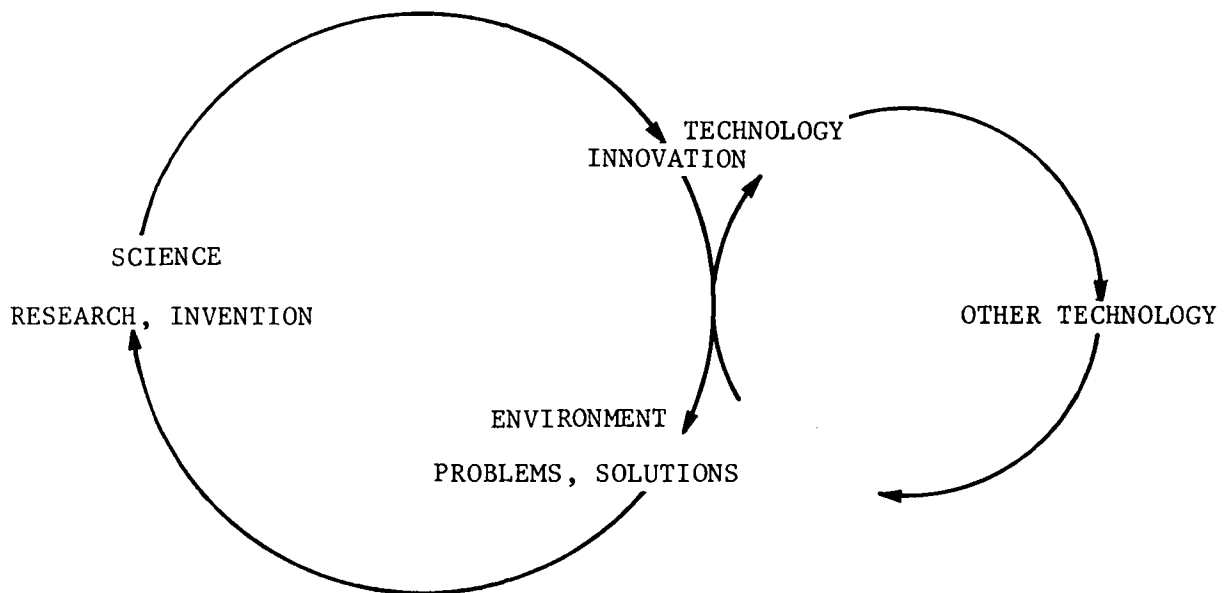

Fig. II.1. Interrelationships among science, technology, and problems and solutions in the environment.

that is, innovations come about as a result of demand rather than simply from the results of scientific research. Thus, environmental factors can be seen to determine to a large degree the chances for a success or failure of a particular innovation, and the chances for successful innovation are greatly enhanced if environmental conditions conducive to innovation are established.

In addition, there is usually a lag between science or invention, and subsequent application. As illustration, there is the example of pasteurization, which was discovered in the 1880's by Pasteur. It was later applied to prevent the spoilage of wine (France), permit the export of cheese (Holland) and beer (Germany), and many years later to prevent bovine tuberculosis (United States). The process of technology development historically has followed a series of "S" curves, responding to increasing urbanization and resource use. See Figure II.2. When applied to the development of water and sewage treatment, the patterns (greatly abbreviated) would appear as in Figure II.3. Where new technologies were required, they were developed. Since water is a reuse commodity, water treatment and wastewater treatment are closely related. Frequently over the years water treatment has been given priority over sewage treatment. That is, the filtration and chlorination of water supplies was thought to be a more certain way to protect public health and also a cheaper way than sewage treatment. With the enormously increasing water requirements of DC's, methods for direct reuse have come in for serious consideration.

One other concept should be examined, namely, that of economy of scale. With economy of scale, the unit cost of a process decreases with increased size of operation up to the point of diminishing returns

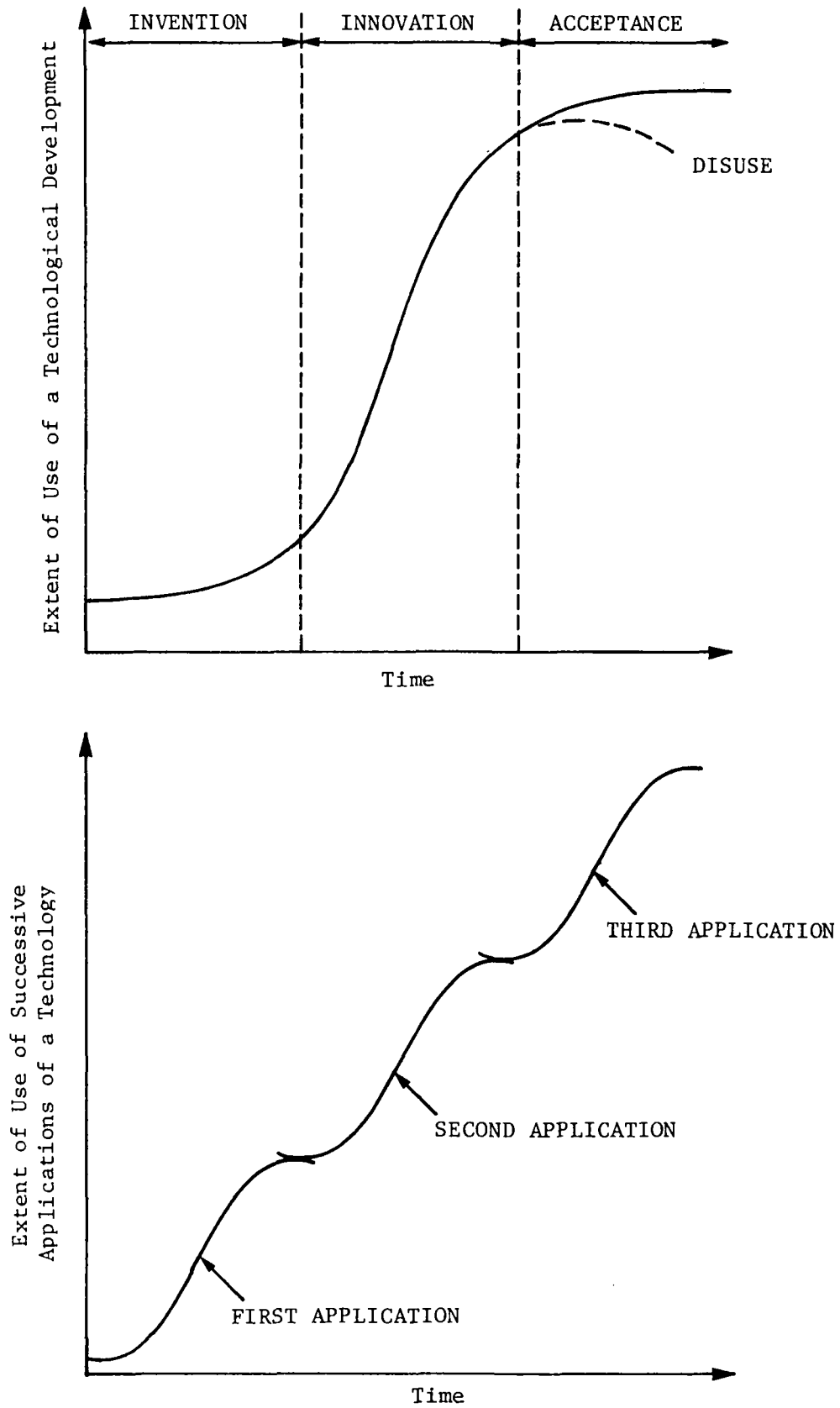
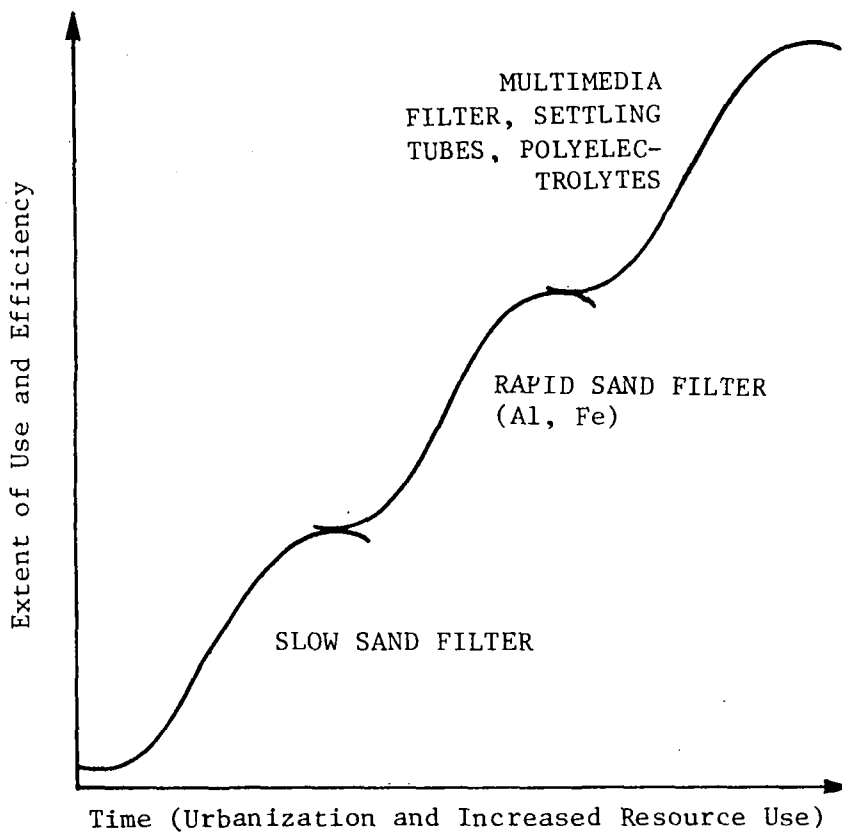

Fig. II.2. Process of technology development.

WATER  
TREATMENT  
TECHNOLOGY



WASTEWATER  
TREATMENT  
TECHNOLOGY

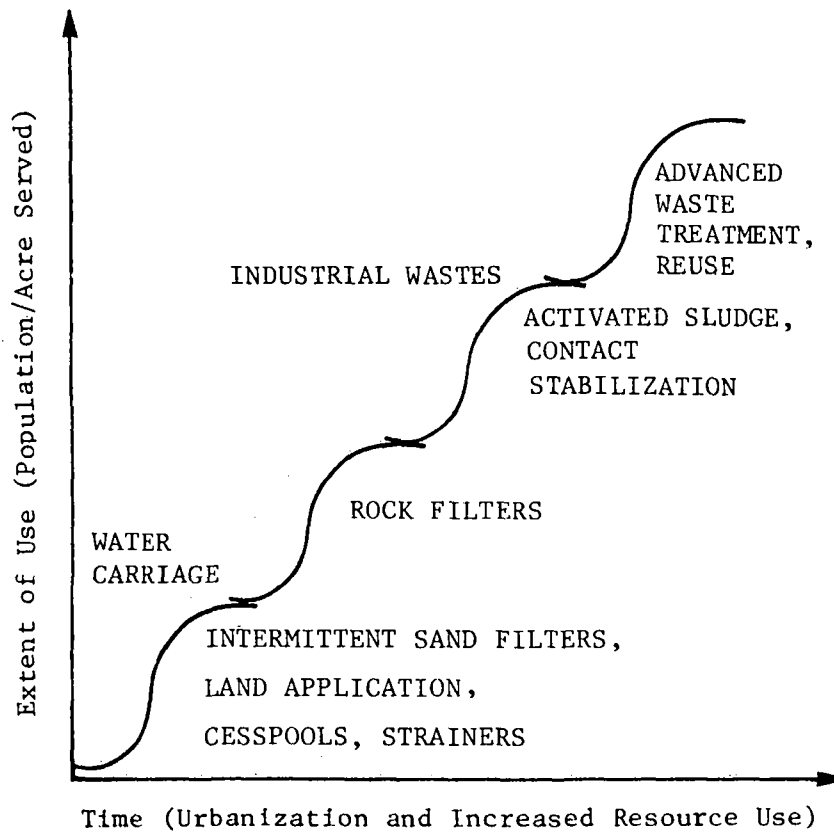

Fig. II.3. Development of water/sewage treatment technology.

or marginal return, at which time a new process becomes more appropriate. An example of the operation of this concept in the area of water treatment may be seen in Figure II.4. In achieving economies of scale in DC's, increasing amounts of resources, energy, and population have been brought together.

Increased urbanization and industrialization, whether in LDC's or DC's, can be expected to elicit new and responsive technologies, even though they cannot be specifically predicted in all instances. As a society develops and passes through the progressive stages of hunting and fishing, subsistence agriculture, manufacturing, mass production, and post-mass production, alterations occur in its religious, governmental, and other human organizations, as well as in its utilization of energy, food, water, and technology. Evidence indicates that a technology which is appropriate for certain levels of development of a particular society, may also be found appropriate for other societies at comparable levels of development.

The industrial technologies in use in developed countries have been designed to suit their conditions, that is, high-cost skilled labor, adequate supplies of capital and of technical and managerial skills, relatively large high-income markets, and virtual full employment. Large markets in the DC's offer opportunities to take advantage of economies of scale, and there is strong pressure to economize on labor as a means to increased productivity. In LDC's the situation is very different. Capital and skilled labor are in limited supply. Often there is an abundance of unskilled labor and a high level of unemployment and under-employment. Domestic markets in LDC's tend to be small with low purchasing power. Without well developed internal

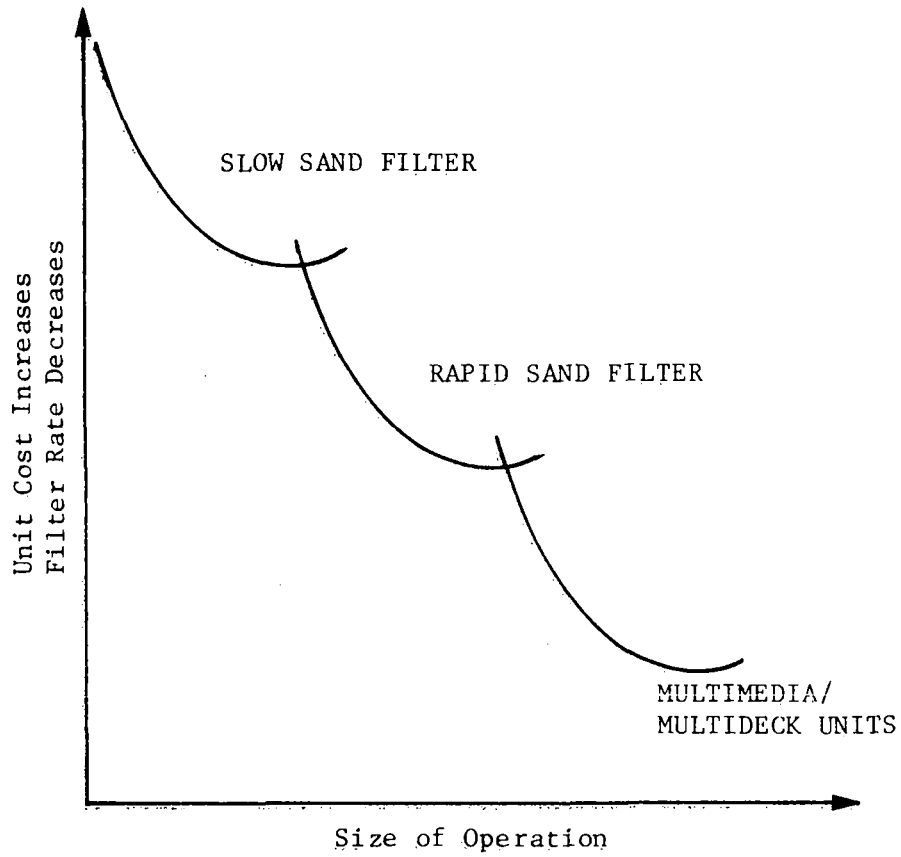

Fig. II.4. The effect of economy of scale in water treatment.



or external markets, these countries cannot normally take full advantage of economies of scale. The best use of resources in LDC's requires the development of both efficient capital-saving and efficient labor-intensive techniques. This is essential if capital is to be used more effectively and if the labor force is to be given useful employment.

In changing from their traditional methods, developing countries often have to use the immediately available technologies, even when they are unsuited to their economic and social conditions. This occurs because they might otherwise forego important development opportunities when they lack the capability (skills or infrastructure) for devising an indigenous technology or for appropriately adapting one from foreign sources. In response to such situations direct technology transfers have been suggested which include training programs. An example would be the installation of a high technology plant accompanied by the training of local manpower in its operation. In such a case, the problem of retention of trained operators arises. For example, a person trained as a water chemist might not remain with the water plant because of an in-country shortage of chemists and the possibility of a larger salary elsewhere. When technically trained people are in short supply, industry, not government, gets first choice. Thus, this system has a "leak." This problem can be resolved as the educational level progresses to a point where skilled personnel such as the water chemist become more generally available. It is possible, also, that a process requiring technicians or engineers will require that both wages and training be augmented. In Figure II.5, the availability of in-country technicians is shown to rise from a position of deficit to a position of surplus, with the passage of time.

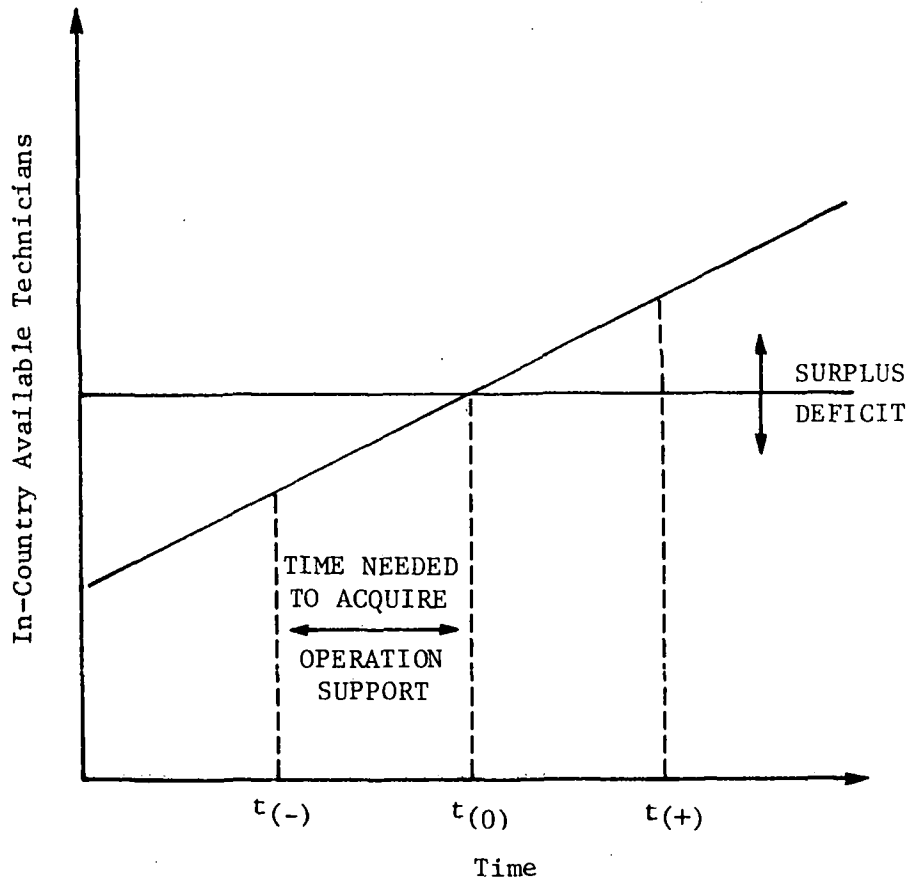

Fig. II.5. Change in availability of in-country technicians with time.

If a process is only slightly advanced beyond the LDC's current capability for maintenance and operation, these functions could be externally supported for a period of time. Unfortunately, the problem is more extensive, including the entire web of support materials and parts. Most failures in transfer are accredited to shortages in operation and maintenance and the unavailability of reasonably priced spare parts. LDC's frequently seek assistance in the form of personnel and parts for maintenance and operation; however, this does not lead to self sufficiency.

In early stages of development there is a need to rely almost entirely on imported technologies, with local efforts concentrated on adaptation to suit local conditions, resources, labor skills, and social institutions. Manufacturers will generally expect a profit from their technology if it is successfully adapted, and there are real problems of rights and patents to be resolved as transfers are accomplished. The donor does stand to risk the loss of markets. As development proceeds, local resources can be increasingly allocated to research and development (R and D) and local manufacture, and dependence on imported technology can be reduced. DC's expend considerably more money on research than LDC's, 100 to 1000 times as much, but at any stage it would be wasteful to apply severely limited resources to reinventing technologies already in existence and available through copying or licensing. Imported technology and local R and D are not alternative policies; they must complement each other.

The words hard and soft are used to distinguish different types of technology. Hard technology refers to forms which are expensive,

capital-intensive, complex, not readily adaptable to materials other than highly precise standardized ones. In contrast, a technology is called soft when it is relatively inexpensive and labor-intensive, flexible and adaptable to local materials of non-standard quality. It can be installed, repaired, and maintained by people of modest technical training. The concepts of low, high, or intermediate technology are also used. In any system of concepts, the problem is in the selection of a compatible or appropriate technology. In an LDC this could mean a technology on any level, including at times a hard or high technology. On the other hand, soft as well as intermediate or low technologies are frequently the most appropriate. Considering choices of technology, Schumacher has said that "for developing countries there is, on the one hand, a very low level of technology which does not keep people going except in relative misery, and, on the other, the rich man's high-level technology which is outside their reach." (36) This statement re-emphasizes the importance of finding alternative, compatible and appropriate technologies for these situations, and intermediate technology is often the answer.

The main obstacles to application of a new technology are economic and social, including education, communications, acceptability of new ideas, administrative effectiveness, business enterprise, and political leadership. The client/engineer/bank interface is an important problem in implementation. Social and cultural traditions are often positive barriers to change. In general, technological transfer and diffusion is a cultural, social, and political process, and not just the imitation of manufactures. Given the inherent difficulties,

transfer and diffusion cannot be expected as a spontaneous process, but require institutionalized channels of action.

Technical change affects the way men make a living, their social habits, their entire way of life, and it is inevitably disruptive of established attitudes and practices. All societies have some built-in resistance to change and a strong inclination to maintain the status quo. The capacity of a society to assimilate new technology depends on both its capacity to adapt the technology to its own conditions and its capacity to adapt itself to the needs of technology. Some technologies are readily accepted, but others may require a massive education program. It has been observed by sanitary engineers for several decades, that water plant designs based on current DC practice which do not take into account local conditions are doomed to failure.

The formulation of water resources strategies requires a full knowledge and close personal contact with the basic facts, traditions, and goals of the overall social and economic development of the region. It is also an endless iterative process in which continuity may be maintained only through a reasonable stability in the top leadership. All this suggests that the most important criteria for policy formulation should stem from experts native to the region, whose personal judgement and knowledge can benefit from the experiences of regions more chronologically advanced (through studies, visits and personal contacts prior to and during their term of service). Decisions on basic questions of water resources policy should be based on a well balanced consideration of many elements covering almost all sectors of the region's economic structure. Inputs should be made from the advances in many different fields of science and technology. When

it is difficult to include specialists in the decision process, consultation should be carried out utilizing input from experts having broad orientations in water resource problems.

There is an advantage for LDC's in using technology which has been developed and used in DC's for a sufficient period of time so that societal impacts will have matured and been observed, and this type of technology use has a retrospective aspect. As the process continues, barriers which may have contributed to failures will be reduced by the development of centers of applied research, information systems, and in-depth local expertise.

The rapidly changing patterns of water use, and more particularly its increased use for waste disposal, indicate that man is currently in a transition phase from the days of assumed water plenty to the time in the immediate future when the use of water will be governed by much greater care and efficiency. Although subsidies from local, regional, or national budgets for certain water uses will certainly remain significant features of water resources policies, there should be an increasing awareness and adaptation to the fact that the efficient use and rational conservation of water resources may be achieved only through an economically oriented approach.

A clear differentiation between total annual cost and revenue should frequently lead to changed rate patterns, and to an increased role for economic incentives. The expertise of economists with overall experience in natural resources management may greatly facilitate the assessment of the actual and potential role of economic incentives in water resources development and management.

## CHAPTER III

# Prediction Methodology for Selection of Suitable Water and Wastewater Processes

The three sections included in this chapter are shortened and revised versions of the original publications which they represent. In them is presented an ordered method of selecting the most appropriate technology for water and wastewater treatment for a particular site and at a particular time, according to the material and manpower resource capabilities available. The primary concern is drinking water and wastewater for organized communities, including those for which management systems for on-site processes would be appropriate.

In the first section explanation is made of the selection methodology which involves the systems approach and aggregate modelling. The systems approach permits the analyst to look at various interrelationships and decision options at one time while aggregate modelling uses average values for attributes of the real-life situation under study. The attributes for LDC modelling must be representative and

must be based on available data on the LDC site either obtained directly or through the aid of a surrogate.

The output of the model displays compatible water supply and sewerage treatment alternatives for a specified community in the base year and at the end of each of four increments of five years. For the alternatives provided, information is given on capital and maintenance costs; manpower requirements, the population to be served, and the plant scale which would be required.

In the second section of this chapter, data forms are included which were designed to use in collecting the basic information needed for the use of the predictive model, while the third section provides a manual computation application of the model together with an example problem which has been worked out step by step. This manual method will suffice in most instances, although a computerized version has been developed.



## III.1.

PREDICTION METHODOLOGY FOR SUITABLE  
WATER AND WASTEWATER PROCESSES

George W. Reid and Richard Discenza

The University of Oklahoma developed a predictive model to help planners select suitable water and wastewater treatment processes appropriate to the material and manpower resource capabilities of particular countries at particular times. This technique will eliminate the problem of overlooking good processes for water and wastewater treatment. Presently the model is limited to evaluating the plausible treatment methods for a single community. However, it can be easily modified to provide cost information on a regional basis. Through the use of this computerized model, a large amount of data/information can be processed quickly, and the resultant output will display the consequences of all the various actions including all relevant costs. Such a display will, in most cases, enhance the design engineer's professional judgement. For those planners who do not have access to a computer capable of executing the model, a manual approach was developed.

The initial form of the model was validated in-house and in the field. The in-house validation included:

1. comparison of model outputs with data from existing treatment facilities in developing countries;

---

Norman: The University of Oklahoma Bureau of Water and Environmental Resources Research, October 1975. (80 pp.)

2. identification of user application problems (users such as consultants, planners, and bankers);
3. inclusion of new interpretive/adaptive technology and state-of-the-art information to broaden the available treatment processes and levels of applicability.

The field validation work consisted of model runs by selected users to ascertain that the appropriate data could be obtained to run the model. The primary objective of this phase of the validation process was to ensure that input data requirements could be met in various developing country situations where substantial national and/or local environmental, economic, or social data are not generally available.

This model was originally presented in a United States Agency for International Development publication and a World Health Organization publication (2,3), and a sample computer printout was included. In addition, a listing of the computer program was presented in a supplementary USAID publication (4). Experience has shown that documentation beyond the logic diagram is not useful due to the variety of computer equipment that is available to prospective users. Therefore, this publication includes the logic diagram together with the step-by-step procedure presented in manual form. An understanding of these items will enable any programmer to proceed to tailor a program suited to particular equipment needs. Actually, the support tables and calculations are quite simple, and the manual procedure should suffice for most purposes.

#### METHODOLOGY

Figure III.1.1 is an overall view of the proposed planning model data flow for the selection of a combination of processes. This metho-

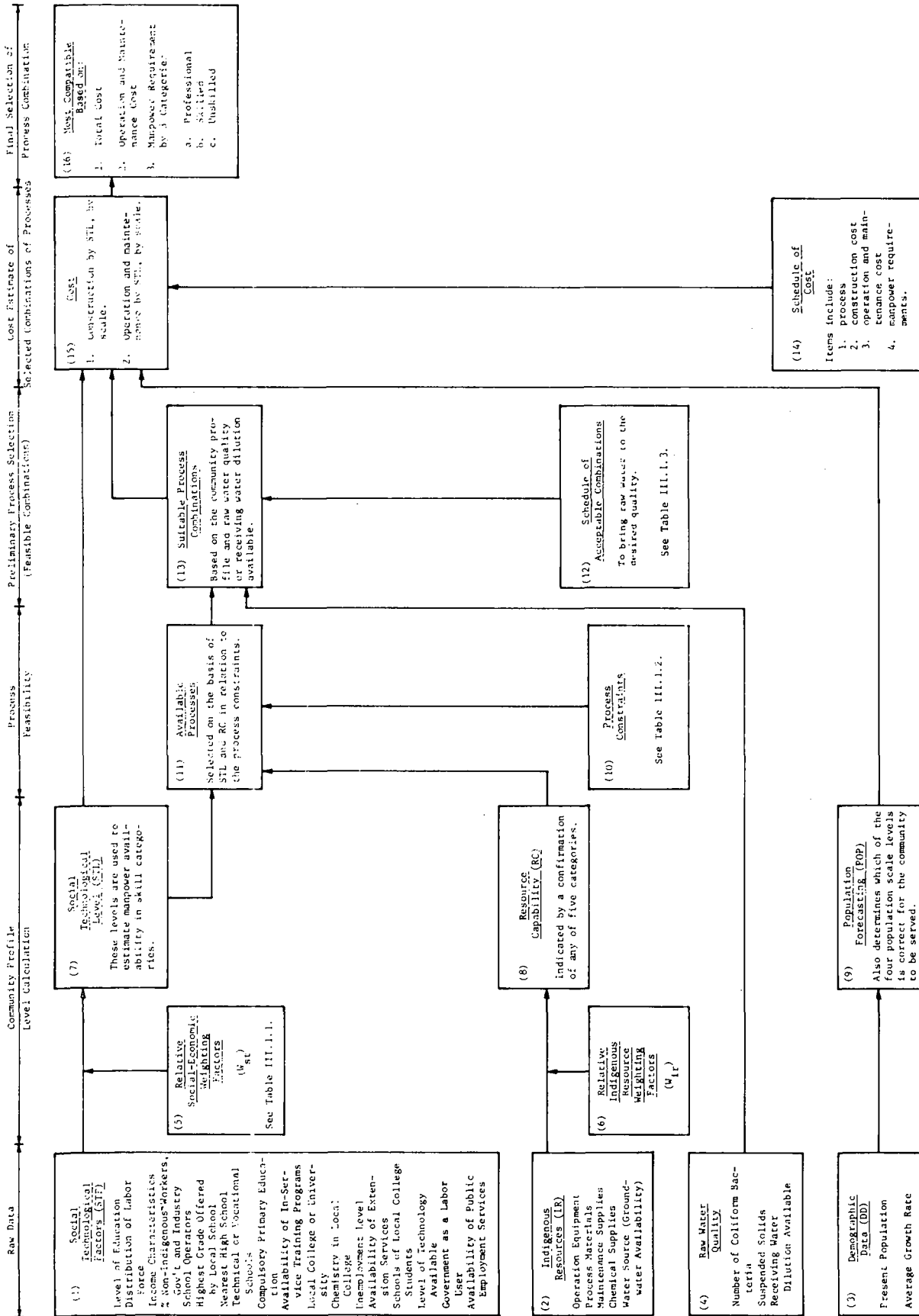

Fig. III.1.1. Complete information flow for the model to select a combination of water and wastewater treatment processes.

dology uses eighteen inputs that describe socio-economic conditions, thirty-one inputs in five main categories that describe the indigenous resources, two inputs that describe the demographic profile, and three inputs that describe the raw water quality. This constitutes the raw data. The method used to assure the appropriate process selection takes two categories of raw data (socio-economic and indigenous resources) and reduces them through a weighting process to four socio-technological levels and five resource capability categories which are used with a matrix of process constraints (in terms of manpower and material requirements) in order to screen for acceptable alternative processes for future consideration. The model identifies basic individual treatment processes. In practice, however, basic treatment processes are frequently utilized in varying combinations, depending on the conditions of the raw water to be treated or on the condition of the received waste streams. The individual processes determined acceptable by the model are thus used to set up combinations of processes.

The limitation on combinations, in the case of water, relates to initial raw water quality, and the screened combinations are designed to provide acceptable groups or sequences of treatments which will bring a raw water to a potable level. For wastewater, the limitation on the combinations relates to effluent dilution available, which is expressed either as a ratio of receiving water volume to waste volume, or alternatively as a ratio of CFS/1000PE (i.e., cubic feet per second of receiving water flow/waste load equivalent to that produced by 1000 people in one day). The constraints are subject to alterations; that is, various coun-

tries may elect various levels of quality. The levels used for this study were based on current international levels. As an LDC develops, more attributes will be monitored, and the allowable values of each attribute will decrease. See Figure III.1.2.

Next, the processes involved in the suitable combinations are located in terms of size of population group to be served or scale, and in terms of socio-technological levels, and a matrix of capital costs, operation and maintenance costs, and manpower requirements is applied. This matrix is developed by empirical analysis of data from more developed regions, regression analysis of regional or national data from developing countries, or real entries of local data. The final step in the model will provide the least cost process combination, in terms of total cost or in terms of maintenance costs, as desired. A stepwise, block-by-block characterization of the model process follows.

Block one--social-technological factors (STF). These inputs are defined as the sum of socio-cultural and socio-economic factors relevant to the model that are essential parts of any community or group of people. The variables were selected on the basis of the availability of related data at the local level and their ability to reflect the level of development at the community level. The characteristics of the eighteen variables used are briefly described below:

1. Five broad levels of education are specified: none, primary, high school, technical institute, and college. The economically more developed communities generally provide opportunities for higher levels of educational attainment.

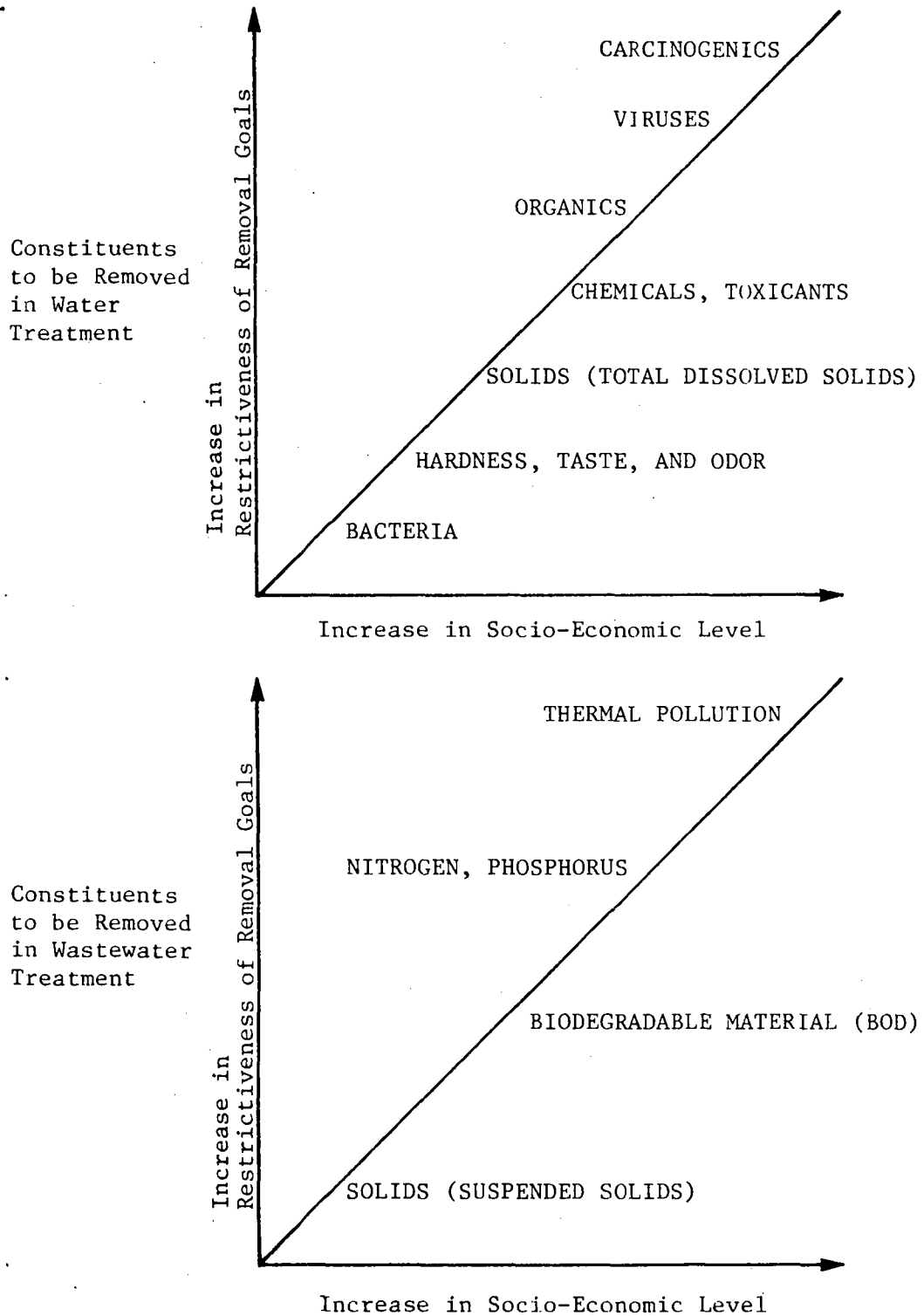

Fig. III.1.2. Conceptual representation of socio-economic development bringing additional treatment parameters and more restrictive levels of control.

2. Distribution of the labor force is expressed in terms of the percentage of professional, skilled, and unskilled workers who are in some way connected with the market economy. In a subsistence economy, only a very small portion of the total population is engaged in market activities. At the advanced level of development, a large percentage of the total population is active in the market, and these workers have expertise levels equivalent to the professional and skilled categories.
3. Income characteristics generally reflect the level of development. A larger per-capita income generally denotes higher levels of development.
4. The percentage of non-indigenous workers in government and in industry is also used as an indicator of development. Low levels of development generally require that the majority of skilled and professional jobs be held by non-indigenous workers.
- 5-9. These variables relate to the investment that a community has in the education of its youth. When schools are operated by voluntary agencies or missionary organizations, the level of development of the community tends to be at a low level. Increases in the standard of living tend to bring compulsory education to at least the primary level. The general accessibility of schools to a community is an indicator of the level of development, and generally, the higher the grade offered, the higher the level of development.
10. In-service training programs are generally not available in

less developed areas. These programs often become more available as the need for higher skills and more expertise in technical areas is required in the community. These in-service programs may be offered through agricultural extension and community development programs.

- 11-12. The availability of a college chemistry department gives some indication of the technical expertise available in the community. It also provides a potential place for the testing of water quality characteristics. The availability of a college or university education indicates a high level of development.
13. The community fiscal level relates to the ability of a community to meet the needs of improved water and sewage treatment by providing for some, if not all, of the funds required for these improvements. The response to this question is not used in computing the STL. If response (2) is indicated then a lowest maintenance cost alternative will be sought by the model. (See "Data Requirements," III.2, below.)
14. Rampant unemployment is characteristic of communities at a low level of development, and the bulk of those unemployed will be unskilled workers. Generally, the unemployment problem decreases as the level of development increases.
15. Agricultural extension services tend to improve as the level of development increases. The main hurdle at lower levels of development is that the appropriate organizational and institutional structures lack the means to implement and administer extension services.



16. If most or all of the college students receive their higher (third level) education in neighboring communities or abroad, this indicates that the community is at a lower level of development.
17. The level of technology available is a generalized data variable that calls on the experience of the planner. It simply asks what level of development is available as signified by four general categories of technology: hand tools, mechanical tools (e.g., gasoline-powered equipment), chemical products (e.g., use of fertilizers and/or chlorine), and electronic technology.
18. The government's role in the labor market also gives an indication of the level of development. At low levels of development, the local government tends to be the major employer. As development increases, employment in private or non-governmental-related activities tends to increase.
19. Public employment services are generally only available at high levels of development.

Block two--indigenous resources (IR). The second group of raw data inputs is concerned with the indigenous resources (IR) available within the community. Data about the local resources and the present technology available for a community is based on the variables shown below. The list is made up of supplies and materials needed for the operation of a wide variety of water and wastewater treatment systems. The availability of these items is matched, within the model, against

the requirements of the various processes. Those processes which require materials or resources not locally available are eliminated from the plausible treatment alternatives suggested by the model. The data input variables related to these local resources and materials include:

1. operation equipment
  - a. water meters
  - b. soldering equipment
  - c. acetylene torches
  - d. recording devices (e.g., thermostats)
  - e. laboratory equipment (e.g., test tubes)
  - f. portable power plants (e.g., portable gasoline-powered electric generators)
  - g. motors (e.g., one to three horsepower electric motors)
  - h. water pumps
2. process materials
  - a. pipe (clay, steel, cement, plastic, copper, etc.)
  - b. pipe fittings
  - c. paint
  - d. valves
  - e. tanks
  - f. vacuum gauges
  - g. heat exchangers
3. maintenance supplies
  - a. silica sand
  - b. graded gravel

- c. clean water
- d. gasoline
- 4. chemical supplies
  - a.  $\text{Al}_2(\text{SO}_4)_3$  (aluminum sulphate)
  - b.  $\text{FeCl}_3$  (ferric chloride)
  - c. char (activated charcoal)
  - d.  $\text{CaO}$  (lime)
  - e.  $\text{Na}_2\text{CO}_3$  (sodium carbonate)
  - f.  $\text{Cl}_2$  (chlorine)
  - g.  $\text{O}_3$  (ozone)
  - h. laboratory chemicals (e.g., litmus paper)
- 5. water source
  - a. river or stream
  - b. lake or impoundment
  - c. wells (is groundwater available?)
  - d. sea or brackish source.

Block three--demographic data (DD). These two types of inputs to the model were designed to include that demographic information which was most readily available. They include figures on the present population and the average growth rate. Two different population parameters can be specified in the input data, one for water and a second for wastewater.

Block four--raw water quality. The fourth and final group of inputs consists of the results of tests performed on the raw water:

1. The presence of the coliform group of bacteria in terms of most probable number per 100 milliliters (MPN/100 ml).
2. The measurements of turbidity, hardness, iron and manganese, and total dissolved solids (TDS).
3. The receiving water dilutions available as specified, if possible, by the biochemical oxygen demand (BOD--5 day, 20°C) content of the wastewater.

Hopefully, these data would be currently available for the site; if not, then national, regional, or similar data could substituted.

Block five--relative social-economic weighting factors ( $W_{st}$ ).

The data inputs identified in Block One are weighted (see Table III.1.). For example, educational attainment is a good indicator of development and has been given greater weight than the distance to the nearest high school, since the distance may not be important if the community has a good transportation system. The weighting process is flexible and can be modified to satisfy the requirements of local conditions.

Block six--relative indigenous resource weighting factors ( $W_{ir}$ ).

Block Six depicts the grouping process designed to determine if a group of related indigenous resources is available (see Block Two). The basic assumption underlying this grouping is that the items listed in the data sheet are only representative. If the majority of these items were designated as available, then the group (e.g., chemicals) would be considered generally available in the community under consideration. (Majority here means seventy percent, and this judgment value can be altered as needed.)

TABLE III.1.1  
 WEIGHTING FACTORS FOR SOCIAL-TECHNOLOGICAL  
 LEVEL DETERMINATION FOR COMMUNITIES  
 IN LESS DEVELOPED COUNTRIES

Description of Variable	Data Form Part III, Questions No. 1-19	Possible Choices	Weighting Factor
Level of Education	1	1	0
		2	5
		3	10
		4	15
Distribution of Labor Force	2	1	0
		2	5
		3	10
		4	15
Income Characteristics	3	1	0
		2	4
		3	8
		4	12
		5	15
Percent Non-Indigenous Workers in Government and Industry	4	1	4
		2	3
		3	2
		4	1
		5	0
School Operators	5	1	0
		2	5
Highest Grade Offered by Local School	6	0	0
		1 - 6	2
		7 - 10	4
		11 - 12	7
		12+	10
Distance to Nearest High School	7	1	3
		2	2
		3	1
		4	0
Availability of Technical and Vocational Training	8	1	5
		2	0

TABLE III.1.1--Continued

Description of Variable	Data Form Part III, Questions, No. 1-19	Possible Choices	Weighting Factor
Compulsory Primary Education	9	1	10
		2	0
Availability of In-service Training Programs	10	1	5
		2	0
Local College or University	11	1	10
		2	0
Chemistry in Local College	12	1	3
		2	0
Unemployment Level	14 <sup>a</sup>	1	0
		2	5
Availability of Extension Services	15	1	3
		2	0
Schools of Local College Students	16	1	0
		2	3
Level of Technology Available	17	1	0
		2	5
		3	10
		4	15
Government as a Labor User	18	1	0
		2	5
Availability of Public Employment Services	19	1	5
		2	0

<sup>a</sup>Question no. 13 is not used in computing the STL.

Block seven--social-technological level (STL). The values of the weighting factors from Block One are totaled, and a socio-technological level is assigned according to the following weight schedule:

<u>Socio-Technological Level (STL)</u>	<u>Range for Total of Weighting Factors.</u>
1	1-23
2	24-51
3	51-93
4	93-133.

Block Seven determines the manpower availability in three skill categories, based on the socio-technological level established for the community. The occupations required on water and sewage treatment programs in the post-construction stage fall into the following categories:

- A. professional
- B. skilled and craftsmen
- C. unskilled and semiskilled.

The main emphasis of the scheme is on operating personnel, as opposed to construction personnel, since investigation to this point has indicated that failure of a project due to lack of personnel almost always occurs during operation and maintenance rather than during construction. The decision rules developed for the model, provide the following manpower constraints for each of the four social-technological levels:

1. In Level I communities only unskilled or semiskilled manpower is available (Category C only).
2. In Level II communities and in Level III communities with populations under 50,000 only unskilled and some skilled labor is available (Categories C and B only).
3. In Level III communities with populations over 50,000 and in

Level IV communities, all categories of manpower are available (Categories A, B, and C).

The model will ensure that the treatment method selected can be maintained with workers from the local manpower supply. This is as opposed to instruction or special training of personnel which of course is an alternative. The purpose of this is to avoid the manpower problems which arise from the installation of processes without regard to the availability of local manpower to repair and maintain the treatment operation.

Block eight--resource capability (RC). Any number or all five of the resource groups can be available to a community.

Block nine--population forecasting (POP). The first portion of the population submodel makes forecasts for the total population of the community under study for each five-year planning interval. The routine is in a loop so that it is used repeatedly. The model that determines the population is very simple; the inputs used are the present population and the annual population growth rate. Although this simple model does not take into account other factors that have an effect on the population of a community, it should give a close approximation of the population if the change is at a fairly constant rate. Population changes are highly contingent on the rates of change in the industrial and commercial institutions of a community. If the average growth rate is not expected to vary appreciably during the time period being forecasted the method should give a good approximation of the so-called "norm" of the community. This "norm" will be what the area would look like if "nobody tinkered with the works."



Blocks ten and eleven--process constraints; available processes.

The next step carried out by the model is the selection or screening of feasible processes, based on the STL and the RC of the community, as well as individual process constraints. (See Table III.1.2.) Processes that are too sophisticated or those requiring resources not available within the community are eliminated from further consideration. There may be cases where all the processes will be eliminated, and there will be no feasible combinations reported by the model.

Block twelve--schedule of acceptable combinations to bring the raw water to the desired quality. Table III.1.3 and Figure III.1.3 show the various combinations of basic processes that are frequently used depending on the conditions of the raw water to be treated or on the degree of dilution available to waste flows. On-site sewerless processes are competitive for all four population classification levels, as shown in Table IX.1.33.

Block thirteen--suitable combinations. This block represents a critical decision point in the model. At this point, the array of process combinations presented in Block Twelve are matched or screened against the individual processes that have been selected as feasible according to the socio-technical level and the indigenous resource capability of the community under study. The results of this decision analysis give a list of one or more combinations of processes that can be considered plausible for the community. The screened combinations provide a sequence of treatments for raw water that bring it to a potable level. For wastewater, the screened combinations are based on the effluent dilution available, which is expressed as a ratio.

TABLE III.1.2

PROCESS CONSTRAINTS--  
WATER AND SEWAGE TREATMENT PROCESSES WITH  
ESSENTIAL MANPOWER AND RESOURCES REQUIRED FOR OPERATION

Treatment Methods	Process Requirements	Process Number	Manpower			Resources Required				
			Unskilled	Skilled	Professional	Operation Equipment	Process Materials	Maintenance Supplies	Chemical Supplies	Water Source (Groundwater Availability)
Water Processes	No Treatment	PW1	x				x			x
	Pre-Treatment	PW2	x					x		
	Slow Sand Filtration	PW3	x					x		
	Rapid Sand Filter--Conventional	PW4		x	x	x	x	x	x	
	Rapid Sand Filter--Advanced	PW5		x	x	x	x	x	x	
	Softening	PW6		x	x	x	x	x	x	
	Disinfection	PW7		x		x	x	x	x	
	Taste, Odor--Fe, Mn	PW8		x		x	x	x	x	
	Desalting--Salt	PW9		x	x	x	x	x	x	
	Desalting--Brackish	PW10		x	x	x	x	x	x	
	Containment Filter	PW11 <sup>a</sup>	x					x		
Waste Processes	Primary--Conventional	PS1	x							
	Primary--Stabilization Pond	PS2	x							
	Sludge--Conventional	PS3	x	x			x	x	x	
	Sludge--Advanced	PS4	x	x		x	x	x	x	
	Sludge--Combined (Imhoff)	PS5	x			x		x		

TABLE III.1.2--Continued

Treatment Methods	Process Requirements	Process Number	Manpower			Resources Required				
			Unskilled	Skilled	Professional	Operation Equipment	Process Materials	Maintenance Supplies	Chemical Supplies	Water Source (Groundwater Availability)
Waste Processes	Secondary--Standard Filter	PS6	x	x		x		x		
	Secondary--High Rate Filter	PS7	x	x	x	x	x	x	x	
	Secondary--Activated Sludge	PS8	x	x	x	x	x	x		
	Secondary--Extended Aeration	PS9	x	x		x		x		
	Disinfection	PS10		x		x	x			
	Aqua Culture	PS11 <sup>a</sup>	x							
	Dilution	PS12 <sup>a</sup>	x							
	Individual	PS13 <sup>a</sup>	x							x
	Individual (Advanced)	PS14 <sup>a</sup>		x		x		x		x

<sup>a</sup>PS11 and PS11, 12, 13, and 14 are listed for completeness here and elsewhere in this publication. These processes could easily be incorporated in the model, although they were not so included for this study.

TABLE III.1.3

ACCEPTABLE COMBINATIONS OF TREATMENT PROCESSES,  
ACCORDING TO RAW WATER QUALITY OR DEGREE OF  
DILUTION AVAILABLE TO WASTE FLOWS

Code for Process Combinations	Process Combinations	Criteria Levels					Receiving Water Volume (7-day Low Flow Level)/ Waste Volume
		Raw Water Concentration			Solids		
		Coliform Bacteria (MPN/100 ml)	Turbidity (JTU)	Other (mg/l)	300 hardness 1 - 3 Fe and Mn > 3000 TDSA > 2000 TDSA		
W1 W2 W3 W4 W5 W6 W7 W8 W9 W10 W11 W12 W13	PW1 PW1 + PW7 PW3 PW2 + PW3 PW11 PW4 + PW7 PW2 + PW4 + PW7 PW5 + PW7 PW2 + PW5 + PW7 (any one of W1 to W8) + PW6 (any one of W1 to W8) + PW8 PW7 + PW9 PW7 + PW10	1 - 2 100 100 300 300 2,000 3,000 2,000 3,000	10 10 100 800 800 100 1,000 100 1,000				
S1 S2 S3 S4 S5 S6 S7 S8 S9 S10 S11 S12 S13	PS1 + PS5 PS1 + PS3 PS2 S1 + PS6 PS1 + PS9 S2 + PS6 S2 + PS7 S2 + PS8 (any one of S1 to S7) + PS10 PS3 (without water carriage) PS11 PS12 PS2 + PS12					20 (or 3 - 4 CFS/1000 PEP) 20 ( " 10 (or 1.5 - 2 " 6 (or 0.9 - 1.2 " 3 (or 0.45 - 0.6 " 6 (or 0.9 - 1.2 " 5 (or 0.75 - 1 " 4 (or 0.6 - 0.8 " 2 (or 0.3 - 0.4 " not applicable 10 (or 1.5 - 2 " 40 (or 6 - 8 " 8 (or 1.2 - 1.6 "	

TDS means total dissolved solids.

The unit is defined as cubic feet per second of receiving water flow rate/1000 population equivalent. A population equivalent is a waste equivalent to one person per day, normally taken as 0.17 lbs. BOD/day.

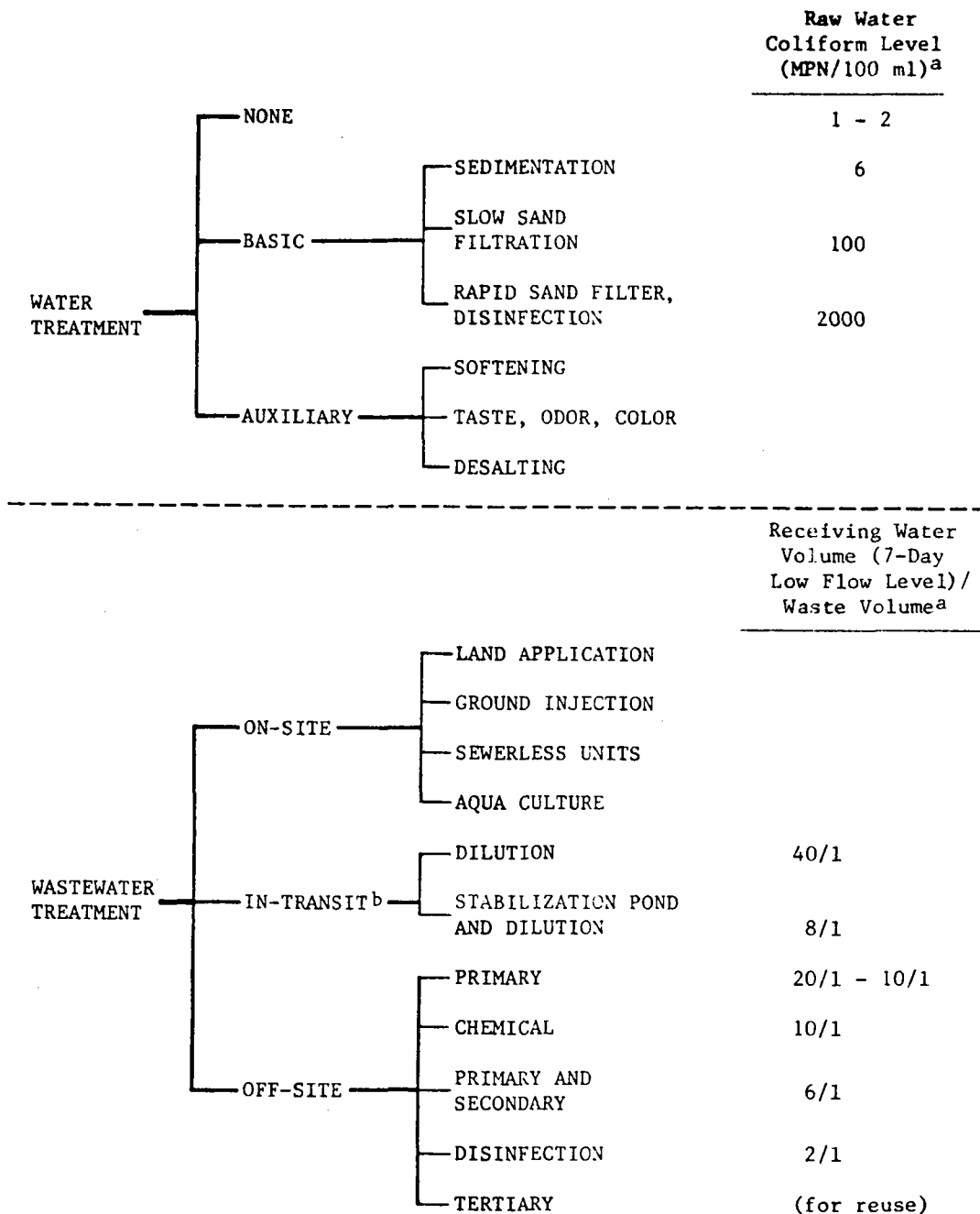

<sup>a</sup>Traditional standards of coliform concentrations and available dilution ratios.

<sup>b</sup>Can be applied in-stream or in-sewer.

Fig. III.1.3. Water and sewage treatment classification/decision tree.

Block fourteen--schedule of cost. Since U.S. data are readily available, empirical methods used in calculating costs of treatment facilities in developing countries are based on U.S. costs. This was accomplished for each particular process, by breaking down operation and maintenance costs and construction costs into basic components, i.e., labor and material. Coefficients for a cost transfer equation are produced from socio-economic data collected for developing areas. Manpower requirements are obtained from U.S. data according to social-technological level and population scale level. Regression analysis and local data are also used to create the cost matrix. (See Chapter IV below).

Block fifteen--cost. Construction and operation and maintenance costs as well as manpower requirements are estimated for the selected combinations of processes based on the social-technological level and the size of community.

Block sixteen--most compatible process combinations. The output of the model provides compatible water supply and sewerage treatment alternatives for a specified community in the base year and at the end of each of four increments of five years. There are thus five pages of output for each community. The details provided include:

1. total cost over an ensuing twenty-year period as well as the capital or construction cost and the yearly maintenance cost;
2. manpower needed for the effective maintenance and operation of the plant or plants, by three categories, unskilled, skilled, and professional;
3. the output of both treated water and/or the amount of sewage influent that the lowest cost combinations of processes will

handle; and

4. the population to be served under the proposed lowest cost system.

One further subcharacterization of the combinations of processes as specified by the model can be made. The basic classifications of  $PW_i$  and  $PS_i$  may still require significant variations within the categories or combinations selected by the model. In short, once the final combination of processes has been selected, a final sort is possible manually on the subcategory of  $PW_i$ 's and  $PS_i$ 's. For example, with slow sand filtration (PW3), the following variations are possible: conventional, manually cleaned; upflow; crossflow (dynamic); and dual media. These subprocesses, along with their individual constraints with regard to STL, are shown in Table III.1.4., and are assumed compatible within their categories and community level constraints.

Finally, there has been a basic assumption that all the processes ( $PW_i$  and  $PS_i$ ) require some sort of public or private infrastructure to oversee the construction and operation of the individual treatment installations. However, there is not necessarily a physical system serving multiple dwelling units associated with every treatment operation. For example, individual  $PS_{13}$ 's can be built, supplied, and maintained by an organization, but they are physically limited to a single family unit. A further assumption is that the individual systems (family units) are reasonably competitive with the other processes or combinations which are subject to the constraints specified in Table III.1.4.

TABLE III.1.4

WATER AND WASTEWATER TREATMENT PROCESS SUBCHARACTERIZATION<sup>a</sup>

Processes	Socio-Technological Constraints
WATER	
PW1 no-treatment	
a. <u>groundwater</u>	
b. <u>catchment control</u>	Usually limited by size to less than Level IV.
PW2 pre-treatment	
a. <u>turbidity/sand--plain sedimentation</u>	Level I
b. <u>algal control--thermocline control</u> <sup>b</sup>	Level IV
c. <u>copper sulfate (CuSO<sub>4</sub>)</u> <sup>b</sup>	Level III
d. <u>microscreen</u> <sup>b</sup>	Level IV
PW3 slow sand filtration	
a. <u>conventional, manually cleaned</u>	
b. <u>upflow</u> <sup>b</sup>	Usually limited by size to less than Level IV.
c. <u>crossflow (dynamic)</u> <sup>b</sup>	
d. <u>dual media</u> <sup>b</sup>	
PW4 rapid sand filter--conventional <sup>c</sup>	
a. <u>conventional</u>	Level III
b. <u>surface agitation (air, water, mechanical)</u>	Level III
c. <u>dual media (sand and artificial)</u>	Level III
d. <u>upflow</u>	Level IV
PW5 rapid sand filter--advanced <sup>c</sup>	
a. <u>multi-media (sand, garnet, coal)</u>	Level IV
b. <u>plate or tube settling as part of system</u>	Level III
c. <u>polyelectrolytes (cationic and anionic)</u>	Level IV
d. <u>biflow</u> <sup>b</sup>	Level IV
e. <u>dynamic</u> <sup>b</sup>	Level IV
f. <u>valveless</u> <sup>b</sup>	Level IV
PW6 softening	
a. <u>lime soda</u>	Level III
b. <u>zeolite</u>	Level IV
PW7 disinfection	
a. <u>chlorine</u>	Level III
b. <u>iodine</u>	Level IV
c. <u>ozone</u>	Level IV
d. <u>ultraviolet</u>	Level IV
e. <u>lime, CuSO<sub>4</sub></u>	Level I
f. <u>energy</u> <sup>b</sup> (pasteurization)	Level II



TABLE III.1.4--Continued

Processes	Socio-Technological Constraints
PW8 taste, odor--Fe, Mn a. aeration b. zeolite c. chlorine d. adsorbent--charcoal	Level II Level IV Level III Level III
PW9 desalting--salt a. multiple effect (multiple distillation) b. freezing out c. pressure	Level IV
PW10 desalting--brackish a. electrodialysis (ED) b. reverse osmosis (RO) c. chemical	Level IV
PW11 containment filters a. <u>Dunbar</u> b. <u>coconut fiber/charred rice husks<sup>b</sup></u> c. <u>asbestos/charred pine needle<sup>b</sup></u>	Level II
WASTEWATER	
PS1 <u>primary--conventional</u> (separate from sludge treatment)	Level I
PS2 primary stabilization pond a. <u>single cell</u> b. multiple cell	Level I Level II
PS3 sludge-conventional a. <u>conventional</u> b. heated c. thickened d. staged, including mixing	Level III Level III Level IV Level IV
PS4 sludge--advanced a. Zimpro-Pyrolysis b. incineration c. fertilizer	Level IV
PS5 <u>sludge combined--Imhoff</u>	Level I
PS6 <u>secondary--standard filter</u>	Level II

TABLE III.1.4--Continued

Processes	Socio-Technological Constraints
PS7 secondary--high rate filter a. Bio-filter b. Accelo-filter c. Aero-filter d. contact stabilization filter	Level III
PS8 secondary--activated sludge a. minimum solids b. conventional	Level IV Level III
PS9 secondary--extended aeration (oxidation pond) a. <u>oxidation pond</u> b. <u>Dutch ditch</u> (oxidation ditch) c. <u>INKA</u> aeration unit used with oxidation ditch d. <u>aerated lagoon</u>	Level III
PS10 disinfection--chlorine	Level II
PS11 aqua culture a. <u>fish culture--milkfish, tilapia, bass</u> b. <u>vascular plants--hyacinth, kang kung</u> c. <u>ecological</u> d. <u>irrigation</u>	Level I
PS12 dilution a. <u>coarse screens</u> b. fine screens c. chemical precipitation, Guggenheim	Level III
PS13 individual and on-site units a. septic tank b. <u>sanitary pit privy</u>	Level I
PS14 individual (advanced) units a. chemical b. thermal c. <u>Clivus Multrum</u>	Level III

<sup>a</sup>Underlining indicates that a process is of particular importance in Less Developed Countries (LDC's).

<sup>b</sup>Requires more field evaluation; not enough is known at present concerning these processes.

<sup>c</sup>Includes Fe, CaO, and/or Al for coagulation; mixing; and settling.

## SCOPE AND LIMITATIONS OF THE MODEL

Since the perspective of the model is global, a large array of treatment processes are considered potential candidates for the treatment of water and wastewater. The array of processes is open to expansion as new ideas are tested through the global network working on adaptive and innovative technological transfer. However, in certain areas some processes lend themselves to greater probabilities for success than others. To account for local variations, the model can be adapted by the addition and elimination of processes as needed.

The model initially was limited to organized communities or nucleated villages that range in population from 500 to 100,000 inhabitants. At the lower level the limit was intended to include individual family systems, if they are collectively managed. At the upper limit, high population concentration areas were excluded because they can afford professional expertise and have generally been able to develop adequate systems without the need for a planning model (1).

The model's data requirements are reasonable. The model is so structured that information for up to thirty percent of the social-technological items may be lacking, and still reasonable community identification can be achieved. In fact, one alternative would be to arrive at the community level by simply consulting the scenarios in the section on "Description of the STL Categories" below, thus bypassing the related data requirements entirely.

Another limitation of the model is that it deals only with water treatment. Procurement and distribution methods and transportation of wastewater away from households are not presently considered, although they could affect treatment costs to some degree. However, this effect

should not be too evident because water quality and system scale are both included in the model.

#### DESCRIPTION OF THE SOCIAL-TECHNOLOGICAL LEVELS (STL)

The approach in this study was to set up four levels of development so that any community would be classified rather easily into one of these levels. The level for a particular community could be determined through use of the data collected on particular socio-cultural and socio-economic factors (See Figure III.1.1, Block 1). The general characteristics of each social-technological level are described below.

Level I communities. Level I communities are those whose economic and social progress is dependent upon continued employment of outside high-level manpower in a wide variety of core positions in the main public and private institutions. At this stage the indigenous human resources are insufficient, and almost without exception external aid is required. Normally, the Level I community is essentially an agricultural society, with the majority of the population of the area being rural or nomadic and engaged in subsistence activities contributing marginally to a market economy.

There is a critical shortage of all categories of high-level manpower: professional and subprofessional, administrative and clerical, teachers, supervisors, and senior craftsmen. In many of these communities, the total number of native persons in the population who have a secondary education or the equivalent is certainly less than one percent, and in some cases, it may be closer to one-tenth of one percent.

In many Level I communities, the population is no longer stable, but is beginning to increase as progress is made in the control of diseases with the expansion of health services. In some areas,

overcrowding on the land, the initial thrust of education into these areas, and the building of roads has encouraged the movement of people to large towns and cities.

The education in Level I communities reaches only a small fraction of the population; its quality is low; and it is incapable of meeting even the minimum needs for local high-level manpower. Many of the schools are operated by "voluntary agencies" or missionary organizations, and the variations in curricula are wide. In most of these communities, the bulk of the primary school teachers are "unqualified" which generally means that they have had little more than six or seven years of primary schooling themselves. The characteristic pattern of most Level I communities is that many pupils start in the first grade, then drop out, and then come back again as repeaters and drop out again.

Level II communities. These communities for the most part are dependent upon the more advanced communities or central cities for critically needed scientific and engineering manpower. But they are able to produce the greater part of their own non-technical high-level manpower, such as teachers, managers, and supervisors with some assistance from advanced countries or other areas within the country. They are unable to develop enough strategic high-level manpower (particularly engineers, scientists, and highly qualified teachers). In many areas, a large portion, approximately half of the population, is engaged in subsistence activities outside the market economy. Most of the agricultural population produces at least some commodities which are sold for cash. In some areas there is a nucleus of modern industry, and in some communities the industrial sector is sizable. Some communities have textile factories and light metal manufacturing plants while others have large

mining or petroleum companies, most of which are partly owned and operated by foreign concerns. Banking and commercial establishments are much more developed than they are in Level I communities, as are the systems of transportation and communication. Thus, the modern sector of the community is larger and a great deal more complex than that in the Level I community, and government employment no longer dominates the labor market.

In nearly all Level II communities, there is widespread consciousness of the need for rapid economic and social development, yet in most cases there is no clear-cut strategy for achieving it. But in comparison with Level I communities, there is more widespread participation of the people in the political life of the community and, consequently, greater pressure for expansion of education and general improvement in the standards of living.

Level III communities. The secondary school enrollment ratio is three times higher than in Level II communities, and the primary enrollment is fifty percent higher. There is available practically all of the high-level manpower needed except for those occupations requiring scientific and technical personnel. Although shortages of scientists and engineers persist, they are not great enough to prevent the community from successfully importing and adapting modern technology without substantial external help.

The quantity and quality of high-level manpower in the Level III communities is far less than those in Level IV communities. The Level III community is a follower rather than an originator of scientific, engineering, and organizational innovations. A community in this level has a broad base of primary education with generally well-developed secondary

schools and maybe an institution of higher education. It has not been able to develop the research manpower and research institutes which are characteristics of Level IV communities. In the area of manpower, though capable of supplying initial minimum needs, institutions are often improperly oriented to meet the challenges posed by rapid modernization. In some cases, too many people are being trained in fields for which there is insufficient prospective demand. Industrialization is well advanced in Level III communities. Most of them are no longer predominantly agriculturally oriented. Transport, power, and communication are, on the whole, well-developed. There are, however, bottlenecks in such areas as electric production, railroad service, and irrigation, partly because of a shortage of the skilled and technical manpower to build and operate them.

Like many of the Level I or II communities, some of the Level III communities have surpluses of unskilled human resources. Generally, the salaries paid to high-talent manpower in science, engineering, and managerial positions in most of the Level III communities are sufficient to attract young people to train for these fields. Government administrative posts also carry high prestige and high salaries. There are public employment services, although these tend to service blue-collar workers rather than professionals. Some attempts have also been made to establish registers of scientific and technical personnel, but generally the employment opportunities for these people are sufficient without the assistance of formal placement procedures.

Level IV communities. The typical community in the fourth level of human resource development has an advanced industrial economy. It is capable of making major scientific, technological, and organizational

discoveries and innovations. This is because it has a relatively large stock of high-level manpower, particularly scientists, engineers, and managerial and administrative personnel. The community has made a heavy commitment to education, especially to higher education, and to human resource development in general. Since rapid changes in technology affect skills and occupations at all levels in the advanced industrial community, education and training tend to be geared to flexibility rather than to specialization.

Measures of educational development show narrow differentials, but they are still substantial. For example, Level IV communities have more than three times the number of students enrolled in first-level (primary) education than do Level I communities, and about one-fifth more than Level III communities. The percentages of those enrolled in scientific and technical facilities are higher, and of those enrolled in humanities, fine arts, and law, lower in Level IV communities than in the other communities. Finally, Level IV communities spend more of their income on public education than do Level III communities.

COST AND MANPOWER PARAMETERS (FOR SELECTED  
WATER AND WASTEWATER TREATMENT PROCESSES  
BY SOCIAL-TECHNOLOGICAL LEVEL AND SCALE)

To obtain cost figures three methods may be used: an empirical analysis of U.S. data, regional or national multiple regression data (cost-demand model included in Chapter IV), and in-country or local data. The first method was used to construct the cost-manpower matrix. The results are given in Tables III.1.5-24 which are in the appendix on Chapter III. These data cover processes PW1 through PW10, and PS1 through PS10. PW11 and PS11, 12, 13, and 14 require additional information.



## III.2.

PREDICTION METHODOLOGY FOR SUITABLE  
WATER AND WASTEWATER PROCESSES:  
DATA REQUIREMENTS

Data forms were designed to use in collecting the basic information needed for the predictive model, using a format chosen for the purpose of easy reduction by a computer. It is important that the data forms be completed by an individual or team that is quite familiar with the community involved, and every possible effort should be made to complete all of the questions included in the data forms. When reliable data are not available, estimates should be used which reflect variations attributable to local circumstances and conditions. In short, careful attention should be given to completing and supplying the information requested on the data forms, since successful use of the model depends on this information. The data forms to be used with the model are included in the pages which follow.

I. General Information

## 1. Location of Community

City Name \_\_\_\_\_

State or Province \_\_\_\_\_

Country \_\_\_\_\_

## 2. Planning Group or Agency \_\_\_\_\_

- II. Demographic - The model requires some basic population data for the purposes of capacity planning. Two inputs are required. If local or site data is not available please use a national estimate and also indicate whether it is national or local source.

Answer either A or B.

- A. 1. Present Population - The figure or estimate of the present population should reflect the number of inhabitants that the proposed water or wastewater treatment facility is going to serve.

Actual population \_\_\_\_\_ or estimate the following:

\_\_\_\_\_ (1) Between 500 and 2,500 people

\_\_\_\_\_ (2) 2,500 - 15,000

\_\_\_\_\_ (3) 15,000 - 50,000

\_\_\_\_\_ (4) 50,000 - 100,000

\_\_\_\_\_ (5) Source \_\_\_\_\_

2. Annual population growth rate \_\_\_\_\_ or estimate in the following:

\_\_\_\_\_ (1) Less than 1%

\_\_\_\_\_ (2) 1% - 1.5%

\_\_\_\_\_ (3) 1.5% - 2.0%

\_\_\_\_\_ (4) 2.0% - 2.5%

\_\_\_\_\_ (5) 2.5% - 3.0%

\_\_\_\_\_ (6) 3.0% - 3.5%

\_\_\_\_\_ (7) 3.5% - 4.0%

\_\_\_\_\_ (8) Greater than 4%

\_\_\_\_\_ (9) Source \_\_\_\_\_

B. Population estimate at last census \_\_\_\_\_

Date of Census \_\_\_\_\_ Source of Census \_\_\_\_\_

Annual Growth rate at time of last census or present annual growth rate \_\_\_\_\_

III. Socio-Technological Data - The purpose of this section is to gather enough information about the community so that it can be classified into one of the four levels of development. The approach has been to request information that is generally available and can be obtained on a local level. Please include any other information you feel is relevant.

CHECK THE MOST APPROPRIATE CATEGORY FOR THE FOLLOWING QUESTIONS

1. Average level of education obtained by inhabitants living in the community.

Level	None	Primary	High School	Technical Institute	College
_____ (1)	95%	4%	1%	0%	0%
_____ (2)	70%	19%	7%	3%	1%
_____ (3)	55%	22%	14%	6%	3%
_____ (4)	9%	34%	42%	8%	7%
_____ (5)	Other				

2. Average distribution of labor force in the community.

Level	Unskilled	Semi-Skilled	Professional
_____ (1)	97%	2%	1%
_____ (2)	80%	16%	4%
_____ (3)	61%	27%	12%
_____ (4)	45%	30%	25%

3. Annual average income per family in your country's currency.

\_\_\_\_\_ amount

\_\_\_\_\_ unit

If available, also check the approximate U.S. dollars equivalency of this amount shown in the following.

- \_\_\_\_\_ (1) Less than \$100
- \_\_\_\_\_ (2) \$100 - \$500
- \_\_\_\_\_ (3) \$500 - \$1,000
- \_\_\_\_\_ (4) \$1,000 - \$3,000
- \_\_\_\_\_ (5) Greater than \$3,000

4. Among the highly skilled and technical workers (for example, engineer, chemist, etc.) what percentage of these is non-local or non-native people?

- \_\_\_\_\_ (1) Less than 10%
- \_\_\_\_\_ (2) 10% - 25%
- \_\_\_\_\_ (3) 25% - 50%
- \_\_\_\_\_ (4) 50% - 75%
- \_\_\_\_\_ (5) 75% - 100%

5. Are there any primary and secondary schools operated by voluntary or missionary organizations rather than the government itself?

- \_\_\_\_\_ (1) Yes \_\_\_\_\_ (2) No

6. What is the highest grade offered by local schools on a regular basis? (Circle one)

1 2 3 4 5 6 7 8 9 10 11 12 12+

7. If the number selected in #6 above is less than 12, how far away is the nearest high school offering the 12th grade?

- \_\_\_\_\_ (1) Less than 10 miles (or less than 16 kilometers)
- \_\_\_\_\_ (2) 10 - 30 miles (or 16 - 48 kilometers)
- \_\_\_\_\_ (3) 30 - 50 miles (or 48 - 80 kilometers)
- \_\_\_\_\_ (4) Greater than 50 miles. (Greater than 80 kilometers.)
- \_\_\_\_\_ (5) Other (specify) \_\_\_\_\_

8. Are there any technical or vocational schools in the community?  
\_\_\_\_\_ (1) Yes \_\_\_\_\_ (2) No
9. Has the community achieved compulsory primary education of at least six years?  
\_\_\_\_\_ (1) Yes \_\_\_\_\_ (2) No
10. Are there any formal in-service training programs by either the government or local industry for their employees?  
\_\_\_\_\_ (1) Yes \_\_\_\_\_ (2) No
11. Is there a college or university in the local community?  
\_\_\_\_\_ (1) Yes \_\_\_\_\_ (2) No
12. Does the university have a chemistry department or laboratory?  
\_\_\_\_\_ (1) Yes \_\_\_\_\_ (2) No
13. How do you rate the ability of the community to finance a water and sewage treatment project?  
\_\_\_\_\_ (1) Unable to repay; the project is a gift because the beneficiaries are poor.  
\_\_\_\_\_ (2) Limited ability to repay; however, the benefits exceed the costs.  
\_\_\_\_\_ (3) Repayment prospects are good; the beneficiaries have relatively high incomes.
14. Is unemployment widespread?  
\_\_\_\_\_ (1) Yes \_\_\_\_\_ (2) No
15. Are advisory services widely available to farmers for community development or for other programs designed to upgrade the skills and enlist the participation of the inhabitants?  
\_\_\_\_\_ (1) Yes \_\_\_\_\_ (2) No
16. Do most college or university students of the community receive their education in neighboring communities, neighboring countries, or other foreign countries?  
\_\_\_\_\_ (1) Yes \_\_\_\_\_ (2) No
17. The level of technology available can generally be classified as  
\_\_\_\_\_ (1) Hand tools only

\_\_\_\_\_ (2) Mechanical tools (i.e., gasoline powered equipment)

\_\_\_\_\_ (3) Chemical products (fertilizers, chlorine)

\_\_\_\_\_ (4) Electronic technology

18. Does the government dominate the labor market?

\_\_\_\_\_ (1) Yes

\_\_\_\_\_ (2) No

19. Are public employment services readily available?

\_\_\_\_\_ (1) Yes

\_\_\_\_\_ (2) No

Indigenous Resources Data.

Questions 20-23 relate to the availability of materials and equipment. Check those items that are not generally available in the community.

20. Operation equipment. Which of the following are not generally available in the local community?

\_\_\_\_\_ (1) Water meters

\_\_\_\_\_ (2) Soldering equipment

\_\_\_\_\_ (3) Acetylene torches

\_\_\_\_\_ (4) Recording devices, such as thermostats

\_\_\_\_\_ (5) Laboratory equipment such as test tubes

\_\_\_\_\_ (6) Portable power plants such as gasoline powered electric generators

\_\_\_\_\_ (7) Motors such as 1-3 horsepower electric motors

\_\_\_\_\_ (8) Water pumps

21. Process materials. Which of the following are not generally available in the local community?

\_\_\_\_\_ (1) Pipe (clay, steel, cement, plastic, copper, etc.)

\_\_\_\_\_ (2) Pipe fittings

\_\_\_\_\_ (3) Paint

\_\_\_\_\_ (4) Valves

\_\_\_\_\_ (5) Tanks

\_\_\_\_\_ (6) Vacuum gauges

\_\_\_\_\_ (7) Heat exchangers

22. Operation and Maintenance supplies: Which of the following are not generally available in the local community?

\_\_\_\_\_ (1) Silica sand

\_\_\_\_\_ (2) Graded gravel

\_\_\_\_\_ (3) Clean water

\_\_\_\_\_ (4) Gasoline

23. Chemical supplies: Which of the following are not generally available in the local community?

\_\_\_\_\_ (1)  $Al_2(SO_4)_3$  (aluminum sulfate)

\_\_\_\_\_ (2)  $FeCl_3$  (ferric chloride)

\_\_\_\_\_ (3) Activated charcoal

\_\_\_\_\_ (4)  $CaO$  (lime)

\_\_\_\_\_ (5)  $NaCO_3$  (Soda ash)

\_\_\_\_\_ (6)  $Cl_2$  (Chlorine)

\_\_\_\_\_ (7)  $O_3$  (Ozone)

\_\_\_\_\_ (8) Laboratory chemicals

24. Major Water Source (check appropriate category)

\_\_\_\_\_ (1) River or stream

\_\_\_\_\_ (2) Lake or impoundment

\_\_\_\_\_ (3) Wells

\_\_\_\_\_ (4) Sea or brackish water

25. Approximate per capita water demand (daily)

(1) Current demands \_\_\_\_\_ in \_\_\_\_\_ (units)

(2) 10 year projection: \_\_\_\_\_

26. Is groundwater available?

\_\_\_\_\_ (1) Yes

\_\_\_\_\_ (2) No

27. Are wells already drilled? Current Capacity? \_\_\_\_\_ mgd

\_\_\_\_\_ (1) Yes \_\_\_\_\_ (2) No

28. Is a central wastewater collection system in existence?

\_\_\_\_\_ (1) Yes \_\_\_\_\_ (2) No

29. Is the following wastewater data available? Please fill in the percentage of people in the community that are:

(1) Currently connected to the system \_\_\_\_\_ %

(2) To be connected within 5 years of the start of the project \_\_\_\_\_ %

(3) To be connected within 10 years \_\_\_\_\_ %

IV. A. Raw Water Quality (drinking water). The purpose of this section is to provide as input to the model the results of tests that have been carried out on the input or raw water. Only starred tests are required for the predictive model.

(1) \*Number of coliform bacteria \_\_\_\_\_ (MPN/100 ml)

(2) \*Turbidity \_\_\_\_\_ (Jackson turbidity units, JTU)

(3) \*Hardness \_\_\_\_\_ (mg/l)

(4) \*Total dissolved solids \_\_\_\_\_ (mg/l)

(5) \*Fe and Mn \_\_\_\_\_ (mg/l)

(6) BOD \_\_\_\_\_ (mg/l)

(7) pH \_\_\_\_\_ (0 - 14)

(8) Dissolved oxygen \_\_\_\_\_ (mg/l)

(9) Temperature \_\_\_\_\_ (°C)

(10) Chlorine \_\_\_\_\_ (mg/l)



B. Wastewater Quality (prior to treatment).

(1) \*Dilution \_\_\_\_\_ (CFS receiving  
water flow/1000  
PE)

or \*Dilution \_\_\_\_\_ (Receiving water  
volume/waste vol-  
ume)

(2) \*BOD \_\_\_\_\_ (mg/l) (May be  
needed to ascer-  
tain figure for PE  
in dilution ratio.)



## III.3.

PREDICTION METHODOLOGY FOR SUITABLE  
WATER AND WASTEWATER PROCESSES:  
MANUAL COMPUTATION METHOD

George W. Reid and Richard Discenza

The selection of the most appropriate water and wastewater treatment method for developing countries by using the predictive model is not limited to situations where an electronic computer is available. A manual computation method has also been devised. The twelve steps to manually determine the most plausible treatment method are as follows:

1. Assign weights to the responses to the data sheet questions necessary for determining the STL level for the community under consideration. Weighting factors are shown in Table III.1.1.
2. Total the assigned weights.
3. Compare the total of assigned weights to the figures given in Table III.3.1 to determine the socio-technical level of the community and the per-capita water consumption.
4. Determine the operation equipment availability.
5. Determine the process materials availability.
6. Determine the operation and maintenance supplies availability.
7. Determine the chemical supplies availability and groundwater availability.

TABLE III.3.1  
SOCIO-TECHNOLOGICAL LEVEL AND  
WATER CONSUMPTION

Socio-Technological Level (STL)	Range for Total of Weighting Factors	Average Consumption of Water (Gal/Cap/Day)
I	1 - 23	25
II	24 - 51	50
III	51 - 93	75
IV	93+	100

TABLE III.3.2  
POPULATION RANGES AND  
SCALE VALUES

Estimated Population	Population Scale
500 - 2,499	1
2,500 - 14,999	2
15,000 - 49,999	3
50,000 - 100,000	4

8. Compare the basic processes and their requirements (Table III.1.2) against the available physical resource groups (these are determined by Steps 4-7) and manpower availability as determined by the size of population served and the STL.
9. Compare the various possible combinations of the treatment processes found to be feasible (Table III.1.3) to the water and wastewater quality of the community obtained from the data sheet.
10. Compute the population scale as given in the data sheet (II. A or B) according to the guidelines given in Table III.3.2.
11. Determine the total cost of construction and operation over twenty years for the feasible combinations (determined by Step 9) using the appropriate scale (from Step 10) and the appropriate STL level (from Step 3). Also, determine the manpower required.
12. Select the lowest total cost or the lowest maintenance cost combination of processes determined by Step 11.

#### A MANUAL COMPUTATION EXAMPLE

1. Data Form, Part III, Questions Numbered 1-19	Weighting Factor
1 . . . . .	<u>10</u>
2 . . . . .	<u>5</u>
3 . . . . .	<u>8</u>
4 . . . . .	<u>2</u>
5 . . . . .	<u>5</u>
6 . . . . .	<u>10</u>
7 . . . . .	<u>-</u>
8 . . . . .	<u>5</u>

Data Form, Part III, Questions Numbered 1-19	Weighting Factor
9 . . . . .	<u>0</u>
10 . . . . .	<u>5</u>
11 . . . . .	<u>0</u>
12 . . . . .	<u>0</u>
14 . . . . .	<u>0</u>
15 . . . . .	<u>0</u>
16 . . . . .	<u>0</u>
17 . . . . .	<u>5</u>
18 . . . . .	<u>5</u>
19 . . . . .	<u>5</u>

Number thirteen is omitted; it is used for a purpose other than STL computation.

2. Total the weighting factors from Step 1.

Total = 65.

3. Compare the total of the weighting factors to Table III.3.1.

STL for this community = 3.

Estimated consumption = 75 gcd.

These figures on consumption are used for the final output, to establish a figure for the plant capacity at the present population or at projected population levels.

4. Examine question No. III-20 on the data sheet. If three or fewer of the eight items are checked, then this group of operation equipment is considered available.

Operation Equipment

Available Yes

Not Available \_\_\_\_\_

5. Examine question No. III-21 on the data sheet. If three or fewer of the seven items are checked, then this group of process

materials are considered available.

Process Materials Available Yes  
Not Available \_\_\_\_\_

6. Examine question No. III-22 on the data sheet. If two or fewer of the maintenance items are checked, then this group of operation and maintenance supplies are considered available.

Operation and Maintenance Supplies Available Yes  
Not Available \_\_\_\_\_

7. Examine question No. III-23 on the data sheet. If three or fewer of the maintenance items are checked, then this group of operation and maintenance supplies are considered available.

Chemical Supplies Available \_\_\_\_\_  
Not Available X

Examine question Nos. III-24 and 26 on the data sheet.

Groundwater Available Yes  
Not Available \_\_\_\_\_

Summary of Physical Resource Availability:

<u>Physical Resource</u>	<u>Availability (Yes or No)</u>
Operation Equipment	<u>Yes</u>
Process Materials	<u>Yes</u>
Operation and Maintenance Supplies	<u>Yes</u>
Chemical Supplies	<u>No</u>
Groundwater	<u>Yes</u>

8. This step involves a comparison of several factors to determine if any or all of the basic processes must be eliminated because the community does not have the resources available. The primary tool for this comparison is Table III.1.2. Two general categories of requirements are considered, manpower and resources. In the category of

manpower the following guidelines should be used.

- a. In Level I communities basically only unskilled manpower is available.
- b. Level II communities have unskilled, and some skilled labor available.
- c. Level III communities with populations under 50,000 have unskilled and some skilled labor available. In Level III communities with a population of more than 50,000 and in Level IV communities, all three categories of manpower are available, unskilled, skilled, and professional.

The data sheet for the hypothetical community of this example shows that the population to be served is above 50,000. Therefore, none of the processes are eliminated because of manpower constraints.

For the resources required, it is necessary to carefully compare each of the processes and its requirements against the summary of resources available listed above. If a process requires a resource that is not locally available then the process should be eliminated from the number of feasible processes. (In this example processes requiring chemical supplies are eliminated.)

List the feasible processes:

<u>Water</u>	<u>Wastewater</u>
<u>PW1</u>	<u>PS1</u>
<u>PW2</u>	<u>PS2</u>
<u>PW3</u>	<u>PS5</u>
_____	<u>PS6</u>
_____	<u>PS8</u>
_____	<u>PS9</u>
_____	<u>PS10</u>



9. At this point the process combinations obtained from Table III.1.3 can only be made up of the above basic processes, and they are examined to see if they can be used to process the water, given that the water or wastewater quality is as specified on Part IV of the model data sheet.

In short, the feasible processes are compared to Table III.1.3. The combinations selected as feasible are those that are capable of treating the raw water concentration as specified on the data sheet and within the constraints given in Table III.1.3 and contain only those feasible basic processes as listed in Step 8 above.

List the feasible combinations:

- Water
1. W1 = PW1 (not feasible because raw water quality too low)
  2. W3 = PW3
  3. W4 = PW2 + PW3
  4. \_\_\_\_\_
  5. \_\_\_\_\_

- Wastewater
1. S1 = PS1 + PS5
  2. S3 = PS2
  3. S4 = PS1 + PS5 + PS6
  4. S5 = PS1 + PS9
  5. S9 = PS1 + PS5 + PS10
  6. S9 = PS2 + PS10
  7. S9 = PS1 + PS5 + PS6 + PS10
  8. S9 = PS1 + PS9 + PS10
  9. \_\_\_\_\_
- } (not feasible because dilution factor too small)

10. The population factor for the community under study is determined by taking the population given in Part II of the data sheet and comparing it to the estimated population groups in Table III.3.2.

Actual population = 60181.

Population scale factor = 4.

11. At this point the cost and manpower determinations for the feasible combinations can be made. The objective of this step is to determine the manpower requirements, construction, and operation and maintenance costs for a twenty-year period for all of the feasible combinations that have been selected. To determine these costs, costs associated with each of the basic processes are calculated and then combined together to arrive at the estimated costs of the feasible combinations of processes. The source data for the various treatment costs is contained in Tables III.1.5-24 which are in the appendix for Chapter III. There is one table for each of the processes in Step 9 above. From previous steps the following information is available: population scale = 4; STL = 3; estimated consumption = 75 gal/cap/day; and actual population = 60181. See Tables III.3.3 and 4 for the results of the calculations.

12. The final step in the process selection method involves the selection of the lowest total cost of the lowest maintenance cost combination from those listed in Table III.3.4.

In this example the lowest total cost water treatment combination is W3 which includes the process PW3 (slow sand filter). The lowest total cost wastewater treatment combination is the S9 which includes PS2 (primary--stabilization ponds) and PS10 (disinfection). In this

TABLE III.3.3

DETERMINATION OF COST AND MANPOWER  
REQUIREMENTS OF SINGLE PROCESSES  
(MANUAL EXAMPLE)<sup>a</sup>

Process Number	Construction Cost (\$U.S.)		Yearly Maintenance Cost (\$U.S.)		Total Cost, 20 Years (\$U.S.)		Required Manpower (Number of Persons)		
	Per Capita	Community	Per Capita	Community	Per Capita	Community	Unskilled	Skilled	Professional
WATER									
PW2	2.03	122,167	0.31	18,656	8.23	495,289	5	4	1
PW3	5.21	313,543	0.44	23,479	14.01	843,135	8		
WASTE-WATER									
PS1	13.17	792,583	0.67	40,321	26.57	1,599,009	4	2	
PS2	3.59	216,049	0.45	27,081	12.59	757,678	6		
PS5	31.10	1,871,629	2.06	123,972	72.30	4,351,086	4	1	
PS6	23.85	1,435,316	0.70	42,126	37.85	2,277,850	6	2	1
PS9	21.25	1,278,800	0.28	16,850	26.85	1,615,800	6	2	1
PS10	19.07	1,147,651	1.49	89,669	48.87	2,941,045	6	1	1

<sup>a</sup>(Community cost) = (per capita cost) (population of community).  
(Total cost) = (construction cost) + (operation and maintenance costs per year) (20 years).

TABLE III.3.4  
 DETERMINATION OF COST AND MANPOWER  
 REQUIREMENTS OF FEASIBLE COMBINATIONS  
 (MANUAL EXAMPLE)

Combinations	Processes	Construction Cost (\$U.S.)	Yearly Maintenance Cost (\$U.S.)	Total Cost, 20 Years (\$U.S.)	Required Manpower (Number of Persons)		
					Unskilled	Skilled	Professional
W3	(PW3) slow sand filter	313,543	23,479	843,135	8	0	0
	(PW3) slow sand filter	313,540	23,479	843,140	8	0	0
W4	(PW2) pre-treatment	122,167	18,656	495,289	5	4	1
	(PW3) slow sand filter	313,543 435,710	23,479 42,135	843,135 1,338,400	8 13	0 4	0 1
S9	(PS1) primary--conventional	792,583	40,321	1,599,009	4	2	0
	(PS5) sludge--combined (Imhoff)	1,871,629	123,972	4,351,086	4	1	0
	(PS10) disinfection	1,147,651 3,811,900	89,669 253,960	2,941,045 8,891,100	6 14	1 4	1 1
S9	(PS2) primary--stabilization pond	216,049	27,081	757,678	6	0	0
	(PS10) disinfection	1,147,651 1,363,700	89,669 116,750	2,941,045 3,698,700	6 12	1 1	1 1
	(PS1) primary--conventional	792,583	40,321	1,599,009	4	2	0
	(PS5) sludge--combined (Imhoff)	1,871,629	123,972	4,351,086	4	1	0

TABLE III.3.4--Continued

Combinations	Processes	Construction Cost (\$U.S.)	Yearly Maintenance Cost (\$U.S.)	Total Cost - 20 Years (\$U.S.)	Required Manpower (Number of Persons)		
					Unskilled	Skilled	Professional
S9	(PS6) secondary--standard filter	1,435,316	42,126	2,277,850	6	2	1
	(PS10) disinfection	1,147,651	89,669	2,941,045	6	1	1
		5,247,200	296,090	11,169,000	20	6	2
S9	(PS1) primary--conventional	792,583	40,321	1,599,009	4	2	0
	(PS9) secondary--extended aeration	1,278,800	16,850	1,615,800	6	2	1
	(PS10) disinfection	1,147,651	89,669	2,941,045	6	1	1
		3,219,000	146,840	6,155,800	16	5	2

Plant Scale = (75 gal/cap/day) • (60,181 people) = 4,513,000 gal/day.

example the lowest total cost combination also happens to be the lowest maintenance cost combination. This may not always be the case, however.

The computerized version has an additional feature that the manual method does not have. That is, the steps one through twelve are simulated at five year intervals for a period of twenty years. Inherent in these simulations are population increases and thus also a modest growth in the technological level of the community.







# Methodology for Prediction of Water and Wastewater Volumes and Treatment Costs

To obtain LDC cost or volume figures for selected water and wastewater treatment processes, three methods may be used. In order of increasing accuracy, they are the following: an empirical analysis of U.S. data, regional or national multiple regression data, and in-country or local data. In this chapter a cost-demand model is presented in which modelling techniques have been used to develop equations for Africa, Asia, and Latin America to predict water demand quantities and wastewater amounts, as well as construction and operation and maintenance costs for slow sand filters, rapid sand filters, stabilization lagoons, aerated lagoons, activated sludge systems, and trickling filters. The basic technique used in this study was step-wise multiple regression using available cost data from Africa, Asia, and Latin America gathered through the use of questionnaires and a review of the literature.

The material contained in this chapter is a shortened and revised version of the original publication. Numerous tables have been included which present the results for mean water demand, waste disposal, and costs of water and wastewater treatment systems for selected socio-economic and technological conditions of LDC's. Two sample problems illustrate the use of this predictive mathematical model.

## IV.

A MATHEMATICAL MODEL FOR PREDICTING WATER DEMAND,  
WASTEWATER DISPOSAL AND COST OF WATER AND  
WASTEWATER TREATMENT SYSTEMS IN  
DEVELOPING COUNTRIES

Michael I. Muiga and George W. Reid

This study uses mathematical modelling techniques to develop predictive equations, utilizing socio-economic, environmental, and technological indicators. Predictive equations are developed for three regions (Africa, Asia and Latin America) for water demand, waste water amounts, as well as construction and operation and maintenance costs for slow sand filters, rapid sand filters, stabilization lagoons, aerated lagoons, activated sludge systems, and trickling filters.

Data analysis indicated that water demand is a function of population, income, and a technological indicator (percentage of households connected to water supply), while waste water disposal was found to be a function of water demand and two technological indicators (percentage of homes connected to public sewerage systems and percentage of household systems). The predictive equations for water treatment costs were found to be a function of a technological indicator (percentage cost of imported water supply materials), population, and the design capacity. The variables which gave the best correlation for waste water treatment costs were population,

---

Norman: The University of Oklahoma Bureau of Water and Environmental Resources Research, January 1976. (147 pp.)

design capacity, and the percentage of imported wastewater disposal materials.

## INTRODUCTION

General. It is highly desirable that proper water supplies and sewage disposal should be of the highest priority in order to obtain the maximum environmental, economic, and social improvement for the people in developing countries. An improvement in the public health and thus in the general well-being and increased productivity of the people is probably the most significant effect of improved water supplies and sewage disposal.

To prove statistically the beneficial effect of proper water supplies and sewage disposal on the health and social conditions of the people of developing countries would require medical examinations and laboratory tests for a particular community for many years. Fortunately, with the World Health Organization such a case history has been documented and is included below.

A simple water supply system was installed in the Zaina area in the Central Province of Kenya, with the help of UNICEF and WHO, in 1961. This system is fed by gravity from a high level surface source of good physical quality and provides chlorinated piped water to 588 farms and four villages which had a total population of 3850 in 1961. By 1965, the system had been extended to supply water to 5800 persons. Prior to 1961, the source of water for domestic use and the considerable farm animal population was the Zaina River which flows in a gorge about 100 metres below the inhabited areas. Carrying water up the steep incline consumed a major portion of the time of the women.

When the new system was installed in 1961, a complete survey of the health and social aspects of the area was made under the supervision of the Provincial Medical Officer. The survey collected detailed information on the incidence of illnesses and infections, housing conditions and general living standards. A similar study was made of a control area located eight kilometers from Zaina and comparable to it in practically all characteristics

except that it lacked an adequate community water supply. In 1965, after four years of operation of the Zaina water system, a resurvey was made of both areas.

It was found that the Zaina community was in better health than four years earlier in terms of both total number of illnesses and duration of each illness. Using the same basis of comparison, the people of the control area were found to be in poorer health. A dramatic difference was found in the stool examination of children for ascariasis, the most common helminth infection in the area. The 1965 survey showed a decline of the disease in Zaina and an increase in the control area giving the latter a prevalence of six times that found in Zaina. The studies also showed that Zaina had made a greater economic advance than the control area. The easy availability of piped water and the release of women's energies for better housekeeping, care of children and vegetable gardening, has been the principal factor in the improvement of both health and well-being in Zaina. (48)

Since the socio-economic, labor, cultural, and resource conditions in developing countries are different from those in highly industrialized countries, it was felt, from the experience available, that the criteria used in developed countries for design of water supply would not be of use in developing countries. (See Table VIII.1.9 for an example of the drastic difference which can be observed when wastewater treatment costs in a developing country are compared to those in a highly industrialized country.) Therefore, this study was aimed at developing methods to estimate demand and costs for construction and maintenance of water and wastewater system in developing countries. However, very little information was available on these factors of demand and cost in developing countries.

Problem. Conditions characteristic of many developing countries include:

1. limited financial resources (particularly foreign currency);
2. limited manufacturing capacity;
3. limited skilled labor but ample unskilled labor;

4. scarce engineering personnel for construction and maintenance of water and wastewater systems.

In addition, most of the mathematical models which have been developed do not account for future technological and cultural changes as well as other factors, and they may not produce optimum cost alternatives for the following reasons.

1. Relative prices of inputs may have changed requiring a different mix of inputs in order to produce a particular level of clean effluent at least cost.
2. Technological breakthroughs that can substantially reduce cost may have been introduced.
3. Existing plants are likely to be an inefficient combination of technologies resulting from a series of additions.
4. Existing plants are not likely to be cost minimizers when they are not operated for profit.
5. Construction and operation costs change with time as a result of change in human values and environmental factors, both physical and economical.

Very few models were found which considered the influence of environmental parameters to total costs. An intensive search of the literature failed to find a single citation which considered all the significant factors and variables needed to develop a mathematical model(s) for predicting water supply and waste water disposal amounts and costs in developing countries.

Objective. The purpose of this study was:

1. to provide to administrators, engineers, and public officials who are in developing countries, concerned with particular future water and wastewater systems the ability to assess the general level of water supply and wastewater disposal amounts and costs prior to a detailed engineering determination;
2. to provide financial guidance in making preliminary decisions concerning future water and wastewater systems in developing countries;
3. to assist in establishing cost, process and resources interrelationships.

Four sub-models were developed as follows:

1. Water Demand Model for Developing Countries;
2. Wastewater Disposal Amounts Model for Developing Countries;
3. Cost of Water Treatment in Developing Countries;
4. Cost of Wastewater Treatment in Developing Countries.

Eventually these will be grouped together as shown in Figure IV.1.

The basic technique used in this study was stepwise multiple regression. Use was made of available cost data from Africa, Asia, and Latin America on slow sand filters, rapid sand filters, stabilization ponds, aerated lagoons, activated sludge systems, and trickling filters.

The equations for estimating water demand, wastewater discharge, and water and wastewater costs by processes, are in the following form:

$$Y = B_0 + B_1X_1 + B_2X_2 + B_3X_3 \dots + B_iX_i \quad \text{for } i = 1, 2, 3 \dots 22$$

where Y = dependent variable to be estimated, e.g., water demand;

$X_i$  = independent variables used in making estimates (Figure IV.1);

$B_i$  = regression coefficients.

Need for the Study and Justification. The United Nations has estimated that the developing countries have an annual population increase of more than two percent. This increase in population will involve a rising demand for water, not only for domestic and industrial use but also for agricultural use to grow more food. Consequent to the inevitable rise in water demand will come greater amounts of wastewater to be disposed of in a manner which will not present a health hazard. If waste water is not treated before discharge into water bodies or if water supplies are not treated before use,

Fig. IV.1. Relationship between water-wastewater demand models and water-wastewater cost models for developing countries.

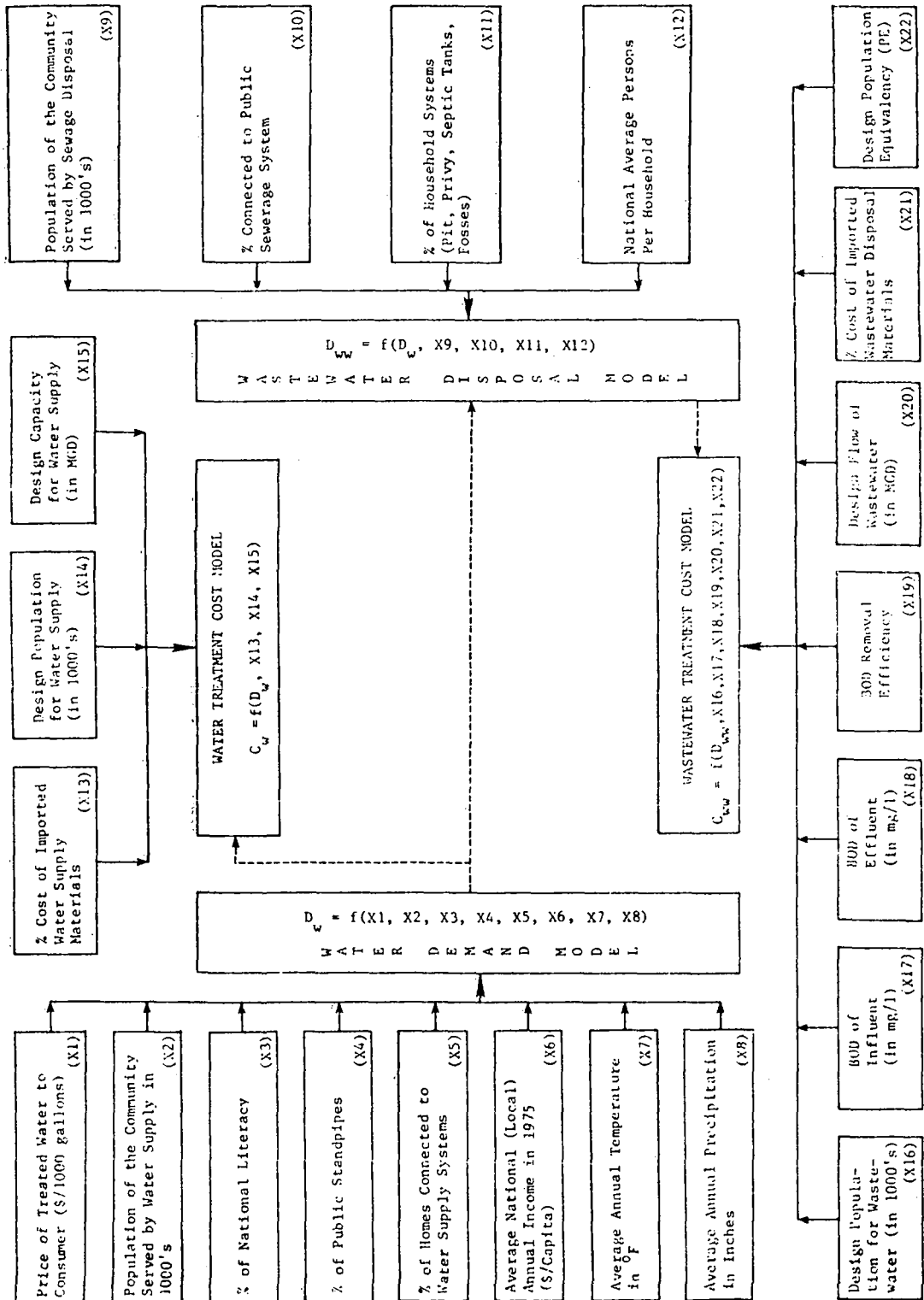



the public health in developing countries may deteriorate. Furthermore, the cost of treating water associated with domestic use is likely to go higher. There is, therefore, a definite need for development of a technique that can be used for estimating water demand, per capita wastewater disposal amounts, and the costs of treating water and wastewater in developing countries.

#### LITERATURE REVIEW

Water Demand Models. A number of studies have been directed toward describing the demand for water. These involved the manipulation of water use information and related economic data to provide some projection of future demand.

Reid (30) has used economic, population, and life style sub-models in the form of the following predictive equation:

$$WD_t = (Pop_t) uu \left[ \frac{ppt_t}{ppt_s} \right]^x \left[ \frac{Inc_t}{Inc_s} \right]^y \left[ \frac{Pop_t}{Pop_s} \right]^z \quad (4-1)$$

where:  $WD_t$  = water demand at time t,

$uu$  = unit use,

$Pop_t$  = population at time t,

$ppt_t$  = Precipitation at time t,

$Inc_t$  = income at time t.

In another study, Wolman (44) describes methods for making estimates of water demand for the United States as an economic model rather than as a set of formal projections. He does this because several important factors are necessarily excluded either because the basic data are still lacking or because some inter-relationships are not well enough understood to be handled with any confidence.

In 1975, Reid and Muiga (32) presented an approach to develop an aggregate mathematical model for water demands in developing countries using socio-economic growth patterns. The authors used socio-economic inputs to identify four socio-technological levels. Levels representative of socio-economic development are in turn used to identify municipal, agricultural and industrial water requirements.

The most advanced statistical methods used have been correlation analysis and the development of estimating equations from the regression line. For example, Sasaki and Sasaki (33) developed a model for Tokyo, Japan, using this method. They used four factors to give the following predictive equation:

$$I = 0.5674 X_1 + 0.1606 X_2 + 0.1149 X_3 + 0.1571 X_4 \quad (4-2)$$

where: I = water demand in gallons per capita per day,

$X_1$  = population,

$X_2$  = personal income,

$X_3$  = industrial production,

$X_4$  = sales of goods.

Further, they expressed maximum consumption of water per day in Tokyo as the linear function below.

$$Y = 361.521 + 32.057 I \quad (4-3)$$

where: Y = maximum water consumption per day for Tokyo.

The formula coefficient correlation shows a value of 0.986 and the standard deviation a value of 0.012. This method expresses statistically better results than if each factor were used separately. Sasaki and Sasaki concluded that water consumption per capita appears to show a larger value in large cities.

An interesting and detailed field examination of domestic water use in East Africa (Kenya, Tanzania and Uganda) was carried out by White, Bradley, and White (43). Although no predictive equations were given, the study attempted to relate per capita use to income, educational level, family size, source of available water, cost, culture and natural environment. Daily per capita use was found to range from a minimum of 1.4 litres in a farming household to a maximum of 660 litres in an upper income suburb of Moshi, Tanzania. The mean per capita use for piped supplies showed a low of 30 litres per capita daily and a high of 254 litres, while for unpiped supplies the mean per capita use showed a high of 21 litres and a low of 4 litres. In general, this study found that per capita use, where water is not piped into the household, is in large measure a function of the income level, the urban versus the rural situation, and the number of children within the household. Where water is piped into the household a major consumption in water occurs; the amount above that minimum is a function in considerable measure of cost, income level, family size and education. Finally, the study found that even where domestic water demand in the urban areas is relatively price inelastic, price is of measurable significance.

The influence of the type of housing on water demand in developing countries can be found in the Accra-Tema Study (36). The average daily domestic supply to Accra increased by about 11 percent from 1961 to 1963. In this period the population increase was about 9 percent whereas the increase in per capita use of water was about 2.5 percent. In Tema during the same period the average daily domestic supply increased by about 122 percent. The population

increased by about 35 percent, whereas the increase in per capita consumption was about 60 percent. This difference between the two cities was due mainly to the construction in Tema of high and medium grade housing with modern sanitary facilities. In Tema almost all the houses were connected to the distribution system and had an average daily domestic per capita consumption of 150 litres in 1963. In Accra half of the population lived in substandard housing and was served by street standpipes and the daily per capita consumption was only 48 litres.

In 1969, Lee (23) selected thirteen sites in Calcutta and New Delhi in an attempt to measure and define the relationship between economic development and the provision or need for public water supply systems through the examination of domestic water consumption. He concluded without giving any predictive equations, that the demand for domestic water supply is a function of accessibility to water, housing conditions, levels of income and water using habits.

Hanke (15) pointed out that although there is little empirical evidence concerning the nature of price elasticity for water, he had observed that there was a thirty-six percent decline in domestic use of water in Boulder, Colorado, after meter installation. He pointed out that within a metered system relatively small price changes may not lead to substantial changes in water demand. Howe and Linaweaver (17), while studying residential water demands using logarithmic demand models, incorporated several independent variables for both average domestic demand and sprinkling demand in the United States, suggesting that sprinkling demand might be relatively elastic and that domestic demand might be relatively inelastic. Price

elasticity of demand is defined as the relative change in quantity demanded as response to a relative change in price if one assumes that the quantity demanded  $q$  is a function of price  $p$ . Price elasticity of demand is theoretically given by Howe and Linaweaver as follows:

$$E_d = \frac{dq \cdot p}{dp \cdot q} = \frac{d(\log q)}{d(\log p)} \quad (4-4)$$

where:  $E_d$  = demand function.

Equation (4-4) can be described by the regression line:

$$\text{Log } E_d = a + b \log p \quad (4-5)$$

where:  $b$  = elasticity coefficient.

Fourt (13) performed multiple linear regressions to find relationships between water usage and price, number of days in summer, rainfall, average number of persons per meter and the total population served.

In another study, Wong (47) worked with a set of twenty variables which he reduced to seven principal components. The most significant of these factors were community size, per capita demand, price, standard of living and industrial depletion.

In 1937, Capen (4) developed the following equation for a well-metered water demand:

$$G = 54P^{0.125} \quad (4-6)$$

where:  $G$  = gallons per capita per day,

$P$  = population in thousands.

Although Capen's equation (4-6) is a good representation of the data from the fifty-two cities he surveyed, to suggest that population is the only variable relevant to domestic water demand is invalid.

In 1969, Meyer and Mangan (27) developed a model which is known as MAIN I for calculating water requirements by correlation with economic, social and climatic variables. Forecasts were completed for 141 Standard Metropolitan Statistical Areas (SMSA) and the final equation is given as follows:

$$E_{75i} = (W_{60i} \times 1.19 \times \frac{Y_{75i} - Y_{60i}}{Y_{60i}} + W_{60i}) \cdot P_{75i} \quad (4-7)$$

where: E = total water use  
W = per capita use  
Y = per capita income  
P = estimated population  
i = SMSA number  
60, 75 = 1960, 1975.

Wastewater Models. The general relationship between per capita wastewater disposal and socio-economic indicators has not been developed either in developing countries or in developed countries. One study in India (25) recommended thirty gallons per capita per day for designing wastewater treatment plants. However, this may not be valid for high income communities in India or in other developing countries. In addition, as the life style and economic conditions of developing countries change, water demand will likely change as well as the amount of wastewater to be disposed of daily. In the United States and other industrial nations, it has been simply a matter of taking a percentage of per capita water demand for the purposes of wastewater systems designing.

Water Treatment Cost Models. A water treatment plant, like many capital facilities, is usually constructed with a capacity that will satisfy the requirements over many years to come, instead of just immediate requirements. One main reason for this lies in economies of scale, available only with a large plant, and which can be achieved in terms of investment or operating cost. To reflect possible scale effects, the investment cost of an industrial facility is often represented by a power function of capacity, of the following form, first proposed by Chenery (5):

$$C = \alpha K^{\beta} \quad (4-8)$$

where: C = investment cost in thousand dollars

K = design capacity in MGD

$\alpha$  and  $\beta$  = coefficients.

In equation (4-8) if we let K equal 1 MGD, C equals  $\alpha$ . That means parameter  $\alpha$  is equal to the investment cost of a plant with a capacity of 1 MGD. On the other hand,  $\beta$  determines the manner in which investment cost changes with capacity. Since  $\beta$  is a constant exponent of K, the investment cost increases with capacity at an increasing or decreasing rate depending on whether  $\beta$  is bigger or smaller than 1.

Koenig (21) reported the collection of data on some thirty surface-water treatment plants in unspecified locations. Using data on twenty-one of these plants he obtained the following investment cost function based on the 1964 price level:

$$C = 307Q_s^{0.68} \quad (4-9)$$

where: C = investment cost in thousand dollars,

$Q_s$  = design capacity in MGD.

Ackerman (1) reported an investment cost function for surface-water treatment plants, using data on forty-two plants reported on

by Keonig in 1968. Using the 1964 price level and the Handy-Whitman Utilities Index for adjusting location differences, he reported the following function:

$$C = 267.0Q_s^{0.65} \quad (4-10)$$

In the same study, Ackermann produced an investment cost function for groundwater treatment plants based on data related to fifty-eight Illinois plants. He adjusted the original data to 1964 price levels and included the indirect costs of engineering, legal, administrative, and other overhead items including interest during construction, and obtained the following function:

$$C = 115Q_s^{0.63} \quad (4-11)$$

In 1961 comprehensive per capita construction cost data were compiled (33) for six nations (Brazil, Ceylon, Costa Rica, India, Jamaica, and Nigeria), representing all three major geographical regions where developing countries are located. A summary of these construction costs are presented in Table IV.1.

Black and Veatch (2) undertook a study to develop a manual to estimate the cost of conventional water supplies in the United States. The costs were developed as a function of design flow only. The costs included all structures, basin, filters, wastewater facilities, plant equipment, tanks, piping, fencing, and other materials necessary for a complete treatment plant. Table IV.2 gives some results of these findings.

Wastewater Treatment Cost Models. A number of studies (3, 7, 24, 34, 35) have been directed toward describing the cost of municipal waste treatment. The cost is usually expressed as a function of



TABLE IV.1  
 PER CAPITA CONSTRUCTION COST OF WATER TREATMENT  
 IN DEVELOPING COUNTRIES

	Country	Per Capita Construction Cost in United States Dollars	
		Reported	Adopted
Africa	Ghana	12.74	13
	Nigeria	8.65	10
Asia	Ceylon	42.00	42
	India	9.05	12
Latin America	Brazil	16.40	25
	Costa Rica	23.60	30
	Jamaica	30 - 50	40

SOURCE: J. M. Henderson, Report on Global Urban Water Supply Program Costs in Developing Nations 1961-1975 (Washington, D.C.: International Cooperation Administration, 1961.)

TABLE IV.2  
 COST OF WATER SUPPLIES  
 IN THE UNITED STATES

Design Capacity in MGD	Construction Cost (U.S.\$)			Operation and Maintenance (\$/1,000 gallons)
	Well Supplies	Treatment Plants and Storage	Intake & Pumping Stations	
0.1	20,000	60,000	40,000	0.120
0.2	21,000	90,000	40,000	0.102
0.5	26,000	140,000	40,000	0.078
1.0	34,000	220,000	40,000	0.062
2.0	50,000	380,000	55,000	0.048
5.0	125,000	700,000	130,000	0.034
10.0	250,000	1,150,000	240,000	0.028
20.0	500,000	2,000,000	465,000	0.024
30.0	750,000	2,700,000	630,000	0.024
40.0	1,000,000	3,400,000	800,000	0.022
50.0	1,250,000	4,000,000	980,000	0.021
60.0	1,500,000	4,600,000	1,150,000	0.020
70.0	1,750,000	5,100,000	1,300,000	0.019
80.0	2,000,000	5,600,000	1,480,000	0.018
90.0	2,250,000	6,100,000	1,660,000	0.017
100.0	2,500,000	6,550,000	1,820,000	0.017

SOURCE: Black and Veatch, Consulting Engineering Firm, Kansas City, Missouri, Manual for Calculation of Conventional Water Treatment Costs, Office of Saline Water Research and Development Report 917 (U.S. Department of Interior, March 1972).

the design flow through the plant or the design population, and the expected level of waste removal efficiency.

Velz (42) made a study of the costs of waste water treatment plants. He obtained his data from the literature and from questionnaires. To estimate the total cost of a plant, Velz assumed that the bid price on the construction cost was about eighty to eighty-five percent of the total cost, excluding the costs of land, engineering, and legal fees.

Wollman (46) used a multiple regression model to estimate the operation and maintenance costs of a waste water plant. The model was as follows:

$$Y = b_0 + b_1X_1 + b_2X_2 + b_3X_3 \quad (4-12)$$

where: Y = the annual operation and maintenance cost per daily population equivalent (P.E.)

X<sub>1</sub> = treatment level in percent of BOD removal

X<sub>2</sub> = percent of total waste that is industrial

X<sub>3</sub> = population served by the sewage system

b<sub>0</sub>, b<sub>1</sub>, b<sub>2</sub>, b<sub>3</sub> = regression coefficients.

Park (28) approached the problem of estimating the construction cost of a plant by considering both the hydraulic and biological loadings of the plant. He assumed that the primary treatment plant costs can be represented by the capacity of the plant in terms of its hydraulic loading, since the hydraulic loading is an important parameter for a primary treatment plant design. However, the secondary treatment plant costs can best be represented by the capacity of the plant in terms of its organic loading. The author assumed 0.2 lb of 5 day BOD per person per day and 100 gallons per capita per day of waste flow.

Thoman and Jenkins (37) recognized regional differences in construction costs. To take into account these differences, the authors partitioned the U.S. into twenty regions on a county line basis. Each of the regions corresponded to one of the twenty cities used in obtaining the Engineering News Record-Cost Index (ENR-CI). They referred the costs to the year 1913 as the base year. Three models were developed for estimating the construction costs of primary treatment plants, secondary treatment plants, and stabilization ponds. The main variable in the models was the design population. The authors developed the following model:

$$Y = aX^b \quad (4-13)$$

where: Y = cost of a plant per MGD of flow

X = size of the plant in terms of MGD of flow

a, b = constants.

In 1970 Shah and Reid made a study (34) to develop models for estimating the construction costs of waste treatment plants. Four variables were studied to predict the costs of a plant. They were the following:

1. population equivalent (PE);
2. flow in million gallons per day;
3. BOD of the influent, mg/l; and
4. efficiency of BOD removal.

The cost was evaluated in terms of

1. 1957-59 dollars per design PE; and
2. 1957-59 dollars per MGD of design flow.

Five types of waste treatment plants were modeled:

1. primary treatment plants;
2. waste stabilization ponds;
3. standard rate trickling filters;
4. high rate trickling filters; and
5. activated sludge plants.

To adjust the cost data of treatment plants obtained from various parts of the country to a common base, the WPC-STP (Water Pollution Control-Standard Treatment Process) Index was used because it is based on information peculiar to wastewater treatment plant construction.

The general form of the model which was tested was:

$$Y = B_0 + B_1X_1 + B_2X_2 + B_3X_3 + B_4X_4 + e \quad (4-14)$$

where: Y = construction cost of a plant in 1957-59 dollars per design MGD or per design PE

X<sub>1</sub> = design PE

X<sub>2</sub> = design flow in MGD

X<sub>3</sub> = design BOD influent in mg/l

X<sub>4</sub> = BOD removal efficiency.

B<sub>0</sub>, B<sub>1</sub>, B<sub>2</sub>, B<sub>3</sub>, B<sub>4</sub> = coefficients of regression

e = residual.

It was felt that in some situations, the linear model might not be able to represent the cost of a waste treatment plant. Therefore, along with the linear form, the following non-linear forms of the model were tested as follows:

$$Y = B_0 + \sum_{i=1}^4 B_i X_i \quad (4-15)$$

$$\ln Y = B_0 + \sum_{i=1}^4 B_i \ln X_i \quad (4-16)$$

$$\frac{1}{\ln Y} = B_0 + \sum_{i=1}^4 B_i \ln X_i \quad (4-17)$$

$$\frac{1}{y} = B_0 + \sum_{i=1}^4 B_i X_i \quad (4-18)$$

The variables,  $X_3$  and  $X_4$ , the influent BOD and the BOD removal efficiency, were found to be "not significant" statistically, in the estimation of the construction costs of the waste treatment plants studied.

The following models were developed.

1. Primary treatment plants:

$$\ln Y'' = 12.42 + 0.3852 X_2 \quad (4-19)$$

where:  $Y''$  = construction cost per design MGD, in 1957-59 dollars.

2. Waste stabilization ponds:

$$\frac{1}{\ln Y'''} = 0.1291 - 0.0044 \ln X_1 + 0.0073 \ln X_2 \quad (4-20)$$

$$\frac{1}{Y'} = 0.0511 + 0.0001 X_1 - 0.0640 X_2 \quad (4-21)$$

where:  $Y'$  = construction cost per design PE in 1957-1959 dollars.

3. Standard rate trickling filter:

$$\ln Y'' = 7.90 + 0.4007 \ln X_1 - 0.9568 \ln X_2. \quad (4-22)$$

4. High rate trickling filter:

$$\ln Y'' = 9.39 + 0.3357 \ln X_1 - 0.6443 \ln X_2 \quad (4-23)$$

$$\ln Y' = 9.39 - 0.6443 \ln X_1 + 0.3557 \ln X_2. \quad (4-24)$$

## 5. Activated sludge treatment plants:

$$\ln Y'' = 8.53 + 0.4610 \ln X_1 - 0.7375 \ln X_2 \quad (4-25)$$

$$\ln Y' = 8.53 - 0.5389 \ln X_1 + 0.2634 \ln X_2. \quad (4-26)$$

Studies have been made by Butts and Evans on municipal sewage treatment construction costs for 291 projects built in Illinois between 1957 and 1968 (3). Least squares regression analysis was used to relate design population equivalent to construction costs. Also regression equations for estimating plant operating costs, lagoon land costs, and other land costs were developed in the general geometric form:

$$C = KP^n \quad (4-27)$$

where: C = either construction, operating or land costs

K = regression constant

P = sewage treatment capacity or average annual load treated

n = slope of the least squares regression line.

A new equation was also developed to account for future expansion of the plant. It took the following form:

$$C = KP^n S^m \quad (4-28)$$

where: C = cost of new addition to old

K = a regression constant

P = capacity of new addition

S = capacity of existing plant

n, m = slope constants.

## DEVELOPMENT OF THE MATHEMATICAL MODEL

The major aim of this study was to develop prediction equations to estimate water demand, per capita waste water disposal amounts, and cost of water and wastewater treatment in developing countries. The development of a multiple correlation from the analysis of a series of regression equations is discussed in this chapter. The objective of the multiple correlation is to provide a function that can be used to estimate dependent variables that can yield more accurate results than using the sample mean.

Sample data were analyzed both to determine an arithmetic mean value for the dependent variable and to determine to what degree this value varies from the mean by calculating the standard deviation. The independent variables were individually analyzed by calculating linear correlation coefficients to determine which variables correlated best. The result of these analyses determined the order in which they were added to the regression equation. Regression equations were then developed starting with a linear equation which utilized only the most significant independent variable; then additional independent variables were added to this equation until all the variables had been utilized. The resultant regression equations were analyzed after each addition, to determine how much more accurate the added new variables made them. Variables not significantly improving the correlation were deleted. Finally, the F-test (defined by equation 3-15) of the significance was made to determine whether the degree of improvement in the accuracy of estimated values could reasonably be arrived at by chance or was statistically significant.



Correlation Coefficients. A good indication of the linear relationship between independent variables, and the linear relationship between individual independent variables and the dependent variable, is the value of the linear correlation coefficient (r) between the pair of variables.

The correlation coefficient between two random variables, x and y, with a joint distribution is defined as:

$$r = \frac{\Sigma (xy - \overline{xy})}{\left[ \Sigma (x - \overline{x})^2 \Sigma (y - \overline{y})^2 \right]^{1/2}} \quad (4-29)$$

where: r = linear correlation coefficient of y vs. x

y = independent or dependent variable

x = independent or dependent variable

$\overline{y}$  = arithmetic mean y value

$\overline{x}$  = arithmetic mean x value

xy = product of x and y

$\overline{xy}$  = arithmetic mean value of xy.

The range of values of the correlation coefficients is from -1 to +1. A non-zero simple correlation coefficient implies that there is a linear relationship between the observed values of the two variables. A correlation coefficient of zero can exist between variables that are independent of one another or between variables that are dependent of one another in a non-linear way.

Correlation coefficients were used as one of the screening mechanisms to select those variables which appeared to explain the magnitudes of the dependent variables of water demand, wastewater disposal, cost of water treatment and cost of wastewater treatment.

Correlation coefficients were also used to determine which independent variables had a high association between their respective values; this would mean that the use of either variable in the regression equation would yield a similar regression equation in terms of parameters. On the other hand, correlation coefficients at each stage provide some knowledge in determining which variables may only appear to explain the changes in dependent variables, because of a high correlation with a variable that actually explains the relationship but which appears not to be an important factor in influencing dependent variables.

Dealing with more than two variables at a time allows the partial correlation coefficients to be used to measure the linearity between observation of two variables with all other coefficients held constant. A partial correlation coefficient is useful because it removes the influence of the other variables, where two variables may appear to be correlated because of a common relationship with another variable and not a relationship between each other.

The partial correlation coefficient of  $x_1$  and  $x_2$  with  $x_3$  held constant is defined as follows:

$$r_{(2,1)3} = r_{(1,2)3} = \frac{r_{1,2} - r_{1,3} r_{2,3}}{\left[ (1-r_{1,3}^2) (1-r_{2,3}^2) \right]^{1/2}} \quad (4-30)$$

Multiple Regression. The problem of best-fitting a hyperplane to a set of joint observations on a dependent variable which is a linear function of several independent variables can be accomplished by the least squares principle. For any linear model, least squares

minimizes the residual sum of squares and provides an unbiased, linear estimate with minimum variance of the parameters.

The use of matrices is convenient since the computations increase tremendously as the number of variables and observations increase. The use of a digital computer is essential if investigation of many possible predictive equations is desirable.

The  $k$  equations can be set out in matrix form where  $Y$  is a  $k$  by 1 vector of observations of a dependent variable,  $X$  is a  $k$  by  $(i + 1)$  matrix of independent variables which explains the dependent variable's value,  $B$  is an  $(i + 1)$  by 1 vector of unknown parameters to be estimated and  $E$  is a  $k$  by 1 vector of residuals. The intercept term,  $B_0$ , dictates that each of the elements of the first column of the matrix  $X$  ( $X_{10}, X_{20}, \dots, X_{k0}$ ) be equal to one. Matrices representing a sample of  $k$  sets of observations on  $y$  and ( $i$  values of  $x$ ) are:

$$Y = \begin{pmatrix} y_1 \\ y_2 \\ y_3 \\ \cdot \\ \cdot \\ y_k \end{pmatrix} \quad X = \begin{pmatrix} x_{01} & x_{11} & \cdot & \cdot & \cdot & x_{i2} \\ x_{02} & x_{12} & \cdot & \cdot & \cdot & x_{i2} \\ \cdot & \cdot & & & & \cdot \\ \cdot & \cdot & & & & \cdot \\ x_{0k} & x_{1k} & & & & x_{ik} \\ x_{0k} & x_{1k} & \cdot & \cdot & \cdot & x_{ik} \end{pmatrix} \quad B = \begin{pmatrix} b_0 \\ b_1 \\ b_2 \\ \cdot \\ \cdot \\ b_i \end{pmatrix} \quad E = \begin{pmatrix} e_1 \\ e_2 \\ e_3 \\ \cdot \\ \cdot \\ e_k \end{pmatrix}$$

Matrix formulation of the observation is:

$$Y = BX + E \quad (4-31)$$

The residuals are described by the following matrix equation,

$$E = Y - XB: \quad (4-32)$$

$$\begin{pmatrix} e_1 \\ e_2 \\ \cdot \\ \cdot \\ e_k \end{pmatrix} = \begin{pmatrix} y_1 \\ y_2 \\ \cdot \\ \cdot \\ y_k \end{pmatrix} - \begin{pmatrix} x_{11} & x_{21} & \cdot & \cdot & x_{i1} \\ \cdot & \cdot & & & \cdot \\ \cdot & \cdot & & & \cdot \\ x_{1k} & x_{2k} & \cdot & \cdot & x_{ik} \end{pmatrix} \begin{pmatrix} b_1 \\ b_2 \\ \cdot \\ \cdot \\ b_i \end{pmatrix} .$$

The sum of squared residuals, can be written as:

$$\phi = \sum_{i=1}^k e_i^2 = \sum (y_i - b_1 X_{1i} - b_2 X_{2i} - \dots - b_k X_{ki})^2$$

$$\phi = y'y - 2b'x'y + b'x'xb. \quad (4-33)$$

Differentiating  $\phi$  with respect to each component of B and setting the resulting equations equal to zero provides a set of normal equations:

$$\begin{aligned} \frac{\delta\phi}{\delta b_1} &= 2(-\sum x_{1i}y_i + b_1\sum X_{1i}^2 + b_2\sum x_{1i} x_{2i} + \dots \\ &\quad + b_k\sum x_{1i} x_{ki}) = 0 \end{aligned}$$

$$\begin{aligned} \frac{\delta\phi}{\delta b_2} &= 2(-\sum x_{2i}y_i + b_1\sum x_{2i}x_{1i} + b_2\sum x_{2i}^2 + \dots \\ &\quad + b_k\sum x_{2i}x_{ki}) = 0 \end{aligned}$$

·  
·  
·

$$\begin{aligned} \frac{\delta\phi}{\delta b_k} &= 2(-\sum x_{ki}y_i + b_1\sum x_{ki}x_{1i} + b_2\sum x_{ki} x_{2i} + \dots \\ &\quad + b_k \sum x_{ki}^2) = 0 \end{aligned}$$

The set of normal equations is written in matrix form as:

$$\frac{\delta\phi}{\delta b} = -2X'Y + 2 X'XB = 0 \quad (4-34)$$

which is equivalent to:

$$X'Xb = X'Y \quad (4-35)$$

Stepwise Multiple Regression. Stepwise regression is a variation of multiple regression which provides a means of choosing independent variables which will provide the best prediction possible with fewest independent variables. This computation method was used in this study to provide the information necessary to select the independent variables to be brought into the equation.

Typical stepwise regression uses a simple correlation matrix for the selection of the first independent variable, choosing the independent variable with the largest absolute value correlation coefficient with the dependent variable. The selection of subsequent variables in the typical stepwise regression is made by selecting from the independent variables the variable having the highest partial correlation coefficient with the response. The decision of acceptance or rejection of each newly added variable is based on the results of an overall and partial F-test. Then stepwise regression examines the contribution the previously added variables would have made if the newly added variable had been entered first. A variable once accepted into the regression equation may later be rejected by this method.

The only modification made to the typical stepwise regression procedure was that the variable's order of entry was determined in part by the results of screening procedures and studies by others and not by use of a correlation matrix alone.

Examination of Residuals. The residual refers to the difference between the observed and regression equation value of the dependent variable. The basic assumptions made about the residuals when using least-squares regression analysis indicate that they are independent, have a constant variance and zero mean, follow a normal distribution if an F-test is used. The examination of residuals therefore should be directed to verifying the assumptions.

If the number of observations is several, one method of identifying independence of the residuals from one another is examination of the pattern of the signs (plus or minus) of the residuals to determine if the observed arrangement is statistically unusual, shown by Draper and Smith (10). This can include a graphical representation of those values and examining the sign of the residuals. The observed number of runs is considered as the number of sign changes plus one. The probability of the observed number of runs may be obtained from tables (10). If the probability of occurrence is less than five percent, the arrangement is assumed to be non-random.

If the number of observations is greater than twenty positives and twenty negative values, another test for independence of residuals may be made. A normal approximation to the actual distribution of the number of runs was used as suggested by Draper and Smith (10)

where:

$$\mu = \frac{2 n_1 n_2}{n_1 + n_2} + 1 \quad (4-36)$$

$$\sigma^2 = \frac{2 n_1 n_2 (2 n_1 n_2 - n_1 - n_2)}{(n_1 + n_2)^2 (n_1 + n_2 - 1)}, \text{ and} \quad (4-37)$$

$$Z = \frac{(u - \mu + \frac{1}{2})}{\sigma} \quad (4-38)$$

with  $n_1$  representing either the number of positive or negative residuals and  $n_2$  being the number of residuals with a sign opposite of those chosen for  $n_1$ .  $\mu$  and  $\sigma^2$  are the mean and variance of the discrete distribution of  $u$ , the number of runs. The probability of  $Z$  can be determined and if this probability value is low, then an unusually low number of runs will have occurred, and it will be assumed that the residuals are non-random and dependent.

The residual mean square value of the model,

$$\frac{1}{n-2} \sum_{i=1}^n (Y_i - \hat{Y}_i)^2,$$

has the expected value of the error variance,  $\sigma^2$ , only if the model is correct. If it is incorrect the residuals contain errors of two components, the variance error, which is random, and bias error, which is systematic. If repeat measurements of the dependent variables are made with all independent variables retaining their same value for two or more observations, the dependent values can be used to determine an estimate of the variance error because in this case only random variation can influence the results. The procedure used to determine the variance error estimate of  $\sigma^2$ ,  $S_e^2$  is outlined by Draper and Smith (10). Suppose

$Y_{11}, Y_{12}, \dots, Y_{1n_1}$  are  $n_1$  repeat observations at  $X_1$ .

$Y_{k1}, Y_{k2}, \dots, Y_{kn_k}$  are  $n_k$  repeat observations at  $X_k$ .

The contribution to the pure error sum of squares from the  $X_1$  readings is then:

$$\sum_{u=1}^{n_1} (Y_{1u} - \bar{Y}_1)^2 = \sum_{u=1}^{n_1} Y_{1u}^2 - n_1 \bar{Y}_1^2 \quad (4-39)$$

where  $\bar{Y}_1$  is the mean value of the  $Y_{11}, Y_{12}, \dots, Y_{1n_1}$  observations.

Similar quantities are evaluated for the other sets of Y's. The total variance error sum of squares is:

$$\sum_{i=1}^k \sum_{m=1}^{n_i} (Y_{iu} - \bar{Y}_i)^2 \quad (4-40)$$

and the total degrees of freedom equals

$$\sum_{i=1}^k (n_i - k).$$

Then the mean square for the variance error is

$$S_e^2 = \frac{\sum_{i=1}^k \sum_{u=1}^{n_i} (Y_{iu} - \bar{Y}_i)^2}{\sum_{i=1}^k n_i - k} \quad (4-41)$$

and is an estimate of  $\sigma^2$ .

Selection of Best Equation. The square of the multiple correlation coefficient or the coefficient of multiple determination ( $R^2$ ), the ratio of the sum of squares, is one possible criterion for selection of the best equation. However, the importance of an  $R^2$  close to unity, its maximum value, may be misleading. This is particularly the case when only a small number of observations are used, because the increase in the number of variables may have more of an influence on the accompanying increase in  $R^2$  than the related explanation



contributed by the variables. The addition of another variable to a regression equation will never decrease  $R^2$ . Draper and Smith (10) point out that if a set of observations on a dependent variable has only four different values a four-parameter model will provide a perfect fit. One method which takes into consideration a number of observations and the number of parameters is the corrected coefficient of determination ( $\bar{R}^2$ ) defined by Goldberger (14).

$$\bar{R}^2 = R^2 - \left(\frac{K}{N - K - 1}\right)(1 - R^2) \quad (4-42)$$

where:  $R^2$  = coefficient of determination  
 $K$  = number of variables  
 $N$  = number of observations  
 $N - K - 1$  = degrees of freedom.

The corrected coefficient of determination does not always increase with the addition of a new variable to the regression equation. One of the techniques used to evaluate alternative equations was the corrected coefficient of determination.

The standard error of estimate, defined as the square root of the residual mean square, has incorporated into it consideration of the degrees of freedom of the residual and, therefore, is also a usable index for evaluating alternative regression equations.

The simple F - test, a ratio of the regression mean square to the residual mean square, is a measure of the equation's usefulness as a predictor. A significant F-value means only that the regression coefficients explain more of the variation in the data than would be expected by chance, under similar conditions, a specified percentage of the time. It should be further noted that use of the F-test

requires that the residuals be normally distributed. Normal distribution of water supply and wastewater disposal data cannot be arbitrarily assumed to exist. However, normal distribution is not required for regression analysis.

The sequential F-test was used to determine if the addition of a new variable into the regression equation explained more of the variation than would be expected by chance. A 5 percent level of significance was used. The sequential or partial F-test as it is sometimes called is the ratio of the regression sum of squares explained by the addition of the new variable divided by the residual mean square (26). This calculated value is termed  $F_c$  and is compared with published values of the F-test to determine the probability that the explained deviation is significant when compared with the unexplained deviation.

$$F_c = (D_e/f_e)/(D_u/f_u) \quad (4-43)$$

where:  $F_c$  = calculated F value

$D_e$  = explained deviation

$D_u$  = unexplained deviation

$f_e$  = degrees of freedom of  $D_e$  = NV

$f_u$  = degrees of freedom of  $D_u$  = N - NV - 1

NV = number of independent variables

N = number of samples.

A plot of the residuals versus their associated fitted value of the dependent variable also yields information on any variation in variance as the magnitude of the fitted value increases.

Preparation of the residuals into unit normal deviate form and comparison of the resulting residuals distribution allows another examination of the residuals. Using this technique approximately 95 percent of the unit normal deviations would be expected to be within -1.96 to +1.96. If the residuals are assumed to have a normal distribution, their unit normal deviate form should satisfy the above criterion.

#### METHODS OF DATA COLLECTION AND PROCESSING

To gather the proper data the developing countries were divided into three major regions, Africa, Asia, and Latin America, and a questionnaire was prepared, a copy of which is in the appendix for Chapter IV. Figures for population equivalent (PE) and percent biochemical oxygen demand (BOD) removal were obtained through the use of formulas. The following formula was used to calculate PE:

$$PE = \frac{8.33 QL}{b} \quad (4-44)$$

where: Q = average flow in wastewater treatment plant (MGD)

L = average 5-day BOD of the waste (mg/l)

b = 0.17 lbs BOD per capita per day (commonly assumed value).

BOD removal efficiency was calculated using the following formula:

$$X_{19} = \frac{(BOD_i - BOD_e)100}{BOD_i} \quad (4-45)$$

where:  $X_{19}$  = percentage removal

$BOD_i = X_{17}$  = 5-day BOD influent

$BOD_e = X_{18}$  = 5-day BOD effluent.

Questionnaires were sent to Africa in March 1974, the Far East, Middle East and Latin America in May 1974. Due to problems in the handling of overseas mail and the problems which may arise in data collection, it was decided to send one questionnaire to local government offices (capital city or provincial city) and one to those national government agencies dealing with water supply and wastewater disposal. The questionnaires were sent to ministries of health, city governments, and water development boards, as well as the following agencies:

- (1) Regional Office for the Mediterranean, World Health Organization, Alexandria, Egypt;
- (2) Regional Office for Africa, World Health Organization, Brazzaville, Congo;
- (3) Regional Office for the Pacific, World Health Organization, Manila, Philippines;
- (4) Regional Office for the Far East, World Health Organization, New Delhi, India;
- (5) Pan-American Center for Engineering and Environmental Sciences, Lima, Peru;
- (6) American University of Beirut, Beirut, Lebanon;
- (7) University of Nairobi, Nairobi, Kenya;
- (8) Asian Institute of Technology, Bangkok, Thailand;
- (9) Middle East Technical University, Ankara, Turkey.

Included with the questionnaire was a letter and over-all summary of the research project on Low Cost Methods of Water and Wastewater Treatment in Less Developed Countries directed by Professor George W. Reid.

In sampling there always exists the risk, in making an estimate from data, that a particular sample is not truly representative of the universal population under study. The risk can be minimized by the application of probability sampling methods and appropriate estimation techniques, and also by taking a larger sample than originally called for (51).

Stratified random sampling, as used in this study requires that the sampler have prior knowledge about the population with respect to various categories or strata.

The sampling process involved a number of assumptions about variables in the universe, as follows:

1. The dependent variable is a random series with a probability distribution.
2. The independent variables are random series with probability distributions.
3. The dependent and independent variables are random series, each with a normal distribution; hence, there is a joint multivariable normal distribution.
4. Further assumptions are required for the random variables for testing and estimation.

Multicollinearity is defined as the intercorrelation among independent variables. When independent variables are intercorrelated, it is difficult to disentangle them in order to get precise and separate estimates of their relative effects upon the dependent variable, and estimates move further away from their association parameters. Two of the very few things which can be done to minimize multicollinearity are:

1. specify variables in the model which are known to be related;
2. check for variables in the model which have the same meaning and eliminate them.

To estimate the sample size of this study the Neyman allocation method (51) was used. The sample size  $n$  is defined by the following:

$$n_s = \frac{N_s S_s \cdot n}{\sum N_s S_s} \quad (4-46)$$

where:  $n_s$  = Sample size required for the Sth stratum,  
 $S_s$  = Sample estimate of the standard deviation, Sth stratum,  
 $n$  = Number of observations required,  
 $N_s$  = The size of the Sth stratum.

An estimated variance within each stratum was necessary to compute the sample size required for each stratum ( $n_s$ ). In this study a random size between 25 and 35 was used to estimate the variance for each stratum. Finally,  $n$  is computed by the following (51):

$$n = \frac{(\sum N_s S_s)^2}{\sum N_s S_s^2 + N^2 V^2} \quad (4-47)$$

where:  $N$  = total population size

$V$  = desired variance.

$V^2$  is defined by the following:

$$V^2 = \frac{d^2}{t^2} \quad (4-48)$$

where:  $d$  = half width of the required confidence interval

$t$  = level of reliability.

Table IV.3 shows the number of questionnaires sent to and received from the three principal geographic regions. Also shown is the number in the samples for which data was used which was found in the literature survey. Using this sample data the partial regression coefficients

TABLE IV.3  
 DISTRIBUTION OF THE COUNTRIES SURVEYED  
 AND SAMPLE DISTRIBUTION

Region	AFRICA			ASIA		LATIN AMERICA	
	East and Central	West	North	Far East	Middle East	Central and West Indies	South
Zaire	x						
Kenya	x						
Zambia	x						
Malawi	x						
Nigeria		x					
Ghana		x					
Uganda	x						
Sudan	x						
Ivory Coast		x					
Central Africa	x						
Libya			x				
Egypt			x				
Morocco			x				
Tunisia			x				
Algeria			x				
Cameroon	x						
Ethiopia	x						
Somali	x						
Malagasy	x						
Liberia		x					
Sierra Leone		x					
Gabon	x						
Mozambique	x						
Rwanda	x						
Mali		x					
Singapore				x			
South Korea				x			

TABLE IV.3--Continued

Region	AFRICA			ASIA		LATIN AMERICA	
	East and Central	West	North	Far East	Middle East	Central and West Indies	South
Burma				x			
Taiwan				x			
Pakistan				x			
Philippines				x			
Afghanistan				x			
Viet Nam				x			
Laos				x			
Cyprus					x		
Iran					x		
Saudi Arabia					x		
Syria					x		
India				x			
Indonesia				x			
Thailand				x			
Lebanon					x		
Jordan					x		
Turkey					x		
Barbados						x	
Panama						x	
Jamaica						x	
Venezuela							x
Guyana							x
Paraguay							x
Uruguay							x
Argentina							x
Mexico						x	
Costa Rica						x	
Trinidad- Tobago						x	
Puerto Rico						x	



TABLE IV.3--Continued

Region	AFRICA			ASIA		LATIN AMERICA	
	East and Central	West	North	Far East	Middle East	Central and West Indies	South
El Salvador						x	
Haiti						x	
Guatemala						x	
Brazil							x
Colombia							x
Peru							x
Chile							x
Bolivia							x
Number of Questionnaires Sent	50			59		40	
Number of Questionnaires Received	43			40		25	
Percent of the Questionnaires Received	86			67		62	
Sample Number Needed	90			75		65	
Sample Number Received	60			40		32	
Sample Number From Literature	43			38		25	

for the following forms of linear equations were computed for each submodel. The form which gave the best fit was used as the predictive equation.

The following forms of equations were tested to establish the best predictive equation:

$$Y = B_0 + \sum_{i=1}^k b_i X_i \quad (4-49)$$

$$\ln Y = b_0 + \sum_{i=1}^k b_i \ln X_i \quad (4-50)$$

$$\frac{1}{\ln Y} = b_0 + \sum_{i=1}^k b_i \ln X_i \quad (4-51)$$

$$\ln Y = b_0 + \sum_{i=1}^k b_i X_i \quad (4-52)$$

$$\frac{1}{Y} = b_0 + \sum_{i=1}^k b_i X_i \quad (4-53)$$

where: Y = dependent variable, Dw, Dww, Cw, or Cww in this study

$X_i$  = independent variable,  $X_1, X_2, \dots, X_{22}$

$b_0, b_i$  = partial regression coefficients.

#### RESULT OF DATA ANALYSIS

Many of the questionnaires received did not include BOD information. Some questionnaires reported that waste water disposal was not yet developed; thus, related data could not be supplied.

Water Demand Model. In developed countries where data are abundant and where water demand information is readily available, the

problem associated with evaluating design capacity is usually not too serious. Since a large proportion of water supply design is of the nature of expansion rather than new supply, it is usually possible to analyze meter records to obtain indications of per capita water demand.

Such is not the case, however, in developing countries. These systems are generally new; hence, historical demand records do not exist. In this situation use is often made of per capita demand in developed countries. These figures are often inappropriate for specific design situations in a developing country, since socio-economic conditions of a community in a developed country are often significantly different from those of a community in a developing country. Furthermore, water systems in developed countries meet additional large commercial and town irrigation demands.

The primary concern of this part of the model was to develop water demand predictive equations utilizing socio-economic, environmental and technological variables from developing countries. Data from developing countries were analyzed using eight independent variables as shown in Figure IV.1. The sequential F-test indicated the non-significance of variable  $X_1$ . Furthermore, there was no improvement of the regression equations with temperature ( $X_7$ ) and precipitation ( $X_8$ ). There was a good correlation between water usage and variables  $X_2$ ,  $X_5$ , and  $X_6$ . In the United States, the Reid study (31) showed precipitation, income, population and lifestyle, as indicators of water usage.

Equations for predicting water demand for three regions (Africa, Asia, and Latin America) are presented below. Each satisfies the

sequential F-test criteria and the corrected coefficient of determination.

$$D_{w.af} = 22.0341 + 0.0973 X_2 \quad R^2 = 0.953 \quad (4-54)$$

$$D_{w.af} = 12.7200 + 0.0683 X_2 + 0.0142 X_6 \quad R^2 = 0.968 \quad (4-55)$$

$$D_{w.as} = 7.1476 + 0.0827 X_2 \quad R^2 = 0.902 \quad (4-56)$$

$$D_{w.as} = 6.6317 + 0.04597 X_2 + 0.2204 X_5 + 0.0263 X_6 \quad R^2 = 0.968 \quad (4-57)$$

$$D_{w.la} = 15.3981 + 0.0663 X_2 \quad R^2 = 0.810 \quad (4-58)$$

$$D_{w.la} = 13.7401 + 0.0645 X_2 + 0.0682 X_5 + 0.0330 X_6 \quad R^2 = 0.897 \quad (4-59)$$

where:  $D_{w.af}$  = water demand in Africa in gallons per capita per day (gpcd)

$D_{w.as}$  = water demand in Asia (gpcd)

$D_{w.la}$  = water demand in Latin America (gpcd)

$X_2$  = population of the community served by water supply in thousands, where  $X_2 \leq 1000$

$X_5$  = percentage of homes connected to water supply systems

$X_6$  = average national per capita annual income in U.S. dollars.

Wastewater Disposal Model. To obtain optimum design of wastewater treatment plants, the amount of sewage provided must be estimated. developed countries use seventy-five percent of water demand as the criterion for designing wastewater plants, but this may be not applicable to developing countries. The primary purpose of this part of the model was to develop equations for predicting the amount of sewage produced per capita per day.

Sample sizes of 49, 55, and 46 were used in this model. Variables  $X_9$  and  $X_{12}$  were non-significant. Good correlation between per capita

wastewater disposal and variables  $D_w$ ,  $X_{10}$  and  $X_{11}$  were obtained.

The equations for predicting per capita wastewater discharge daily are presented below. Each satisfies the sequential F-test criteria and the corrected coefficient of determination.

$$D_{ww.af} = 0.2840 + 0.6670 D_w \quad R^2 = 0.890 \quad (4-60)$$

$$D_{ww.af} = 0.6442 + 0.4614 D_w + 0.0079 X_{10} - 0.0341 X_{11} \quad R^2 = 0.960 \quad (4-61)$$

$$D_{ww.as} = 0.7266 + 0.7399 D_w \quad R^2 = 0.908 \quad (4-62)$$

$$D_{ww.as} = 0.993 + 0.4614 D_w + 0.0047 X_{10} \quad R^2 = 0.952 \quad (4-63)$$

$$D_{ww.la} = 0.1652 + 0.7508 D_w \quad R^2 = 0.990 \quad (4-64)$$

$$D_{ww.la} = 0.1835 + 0.6164 D_w - 0.0368 X_{11} \quad R^2 = 0.999 \quad (4-65)$$

where:  $D_{ww.af}$  = wastewater disposal in Africa (gpcd)

$D_{ww.as}$  = wastewater disposal in Asia (gpcd)

$D_{ww.la}$  = wastewater disposal in Latin America (gpcd)

$D_w$  = water demand (gpcd)

$X_{10}$  = percentage connected to public sewerage systems

$X_{11}$  = percentage of household systems.

Water Treatment Cost Model. Cost data on water construction, operation, and maintenance were analyzed after all the costs had been projected to U.S. dollars using International Financial Statistics (20) and then projected to 1975 U.S. dollars assuming 6½ percent annual inflation. An examination of the correlation matrix indicated a high correlation between  $D_w$  and  $X_{15}$  and therefore only one of those two variables was used in any one of the regression

equations. For slow and rapid sand filter processes, equations predicting construction cost for both per capita ( $C'_w$ ) and per MGD ( $C''_w$ ) design were evaluated. Also, operation and maintenance cost per capita per year ( $C'''_w$ ) and per MGD per year ( $C''''_w$ ) were evaluated.

A sequential F-test justified the acceptance of each variable into the regression equations. In all regions good correlations were obtained using water demand ( $D_w$ ), technological indicator ( $X_{13}$ ), population ( $X_{14}$ ), and design capacity ( $X_{15}$ ). The logarithmic transformation of variables gave the best fit. Each equation satisfied the corrected coefficient of determination.

The best fit equations for predicting construction, operation and maintenance costs for slow sand filters are as follows:

$$\begin{aligned} \ell_n C'_{w.af} &= 2.6436 + 0.0988 \ell_n D_w \\ &\quad - 0.20651 \ell_n X_{14} \qquad R^2 = 0.810 \quad (4-66) \end{aligned}$$

$$\begin{aligned} \ell_n C''_{w.af} &= 3.4537 + 0.0089 \ell_n D_w \\ &\quad - 0.1321 \ell_n X_{14} \qquad R^2 = 0.806 \quad (4-67) \end{aligned}$$

$$\begin{aligned} \ell_n C'''_{w.af} &= 0.4346 + 0.0160 \ell_n D_w \\ &\quad - 0.3628 \ell_n X_{14} \qquad R^2 = 0.756 \quad (4-68) \end{aligned}$$

$$\ell_n C''''_{w.af} = 1.6217 - 0.6203 \ell_n X_{15} \qquad R^2 = 0.865 \quad (4-69)$$

$$\begin{aligned} \ell_n C'_{w.as} &= 2.7436 + 0.0088 \ell_n D_w \\ &\quad - 0.1065 \ell_n X_{14} \qquad R^2 = 0.887 \quad (4-70) \end{aligned}$$

$$\begin{aligned} \ell_n C''_{w.as} &= 3.6044 + 0.0100 \ell_n X_{13} \\ &\quad - 0.1065 \ell_n X_{15} \qquad R^2 = 0.876 \quad (4-71) \end{aligned}$$

$$\ell_n C'''_{w.as} = 0.5017 - 0.0751 \ell_n X_{14} \qquad R^2 = 0.770 \quad (4-72)$$

$$\begin{aligned} \ell_n C''''_{w.as} &= 2.1243 - 0.1018 \ell_n X_{14} \\ &\quad - 0.4891 \ell_n X_{15} \qquad R^2 = 0.902 \quad (4-73) \end{aligned}$$

$$\begin{aligned} \ell_n C'_{w.la} &= 2.5461 + 0.0096 \ell_n X_{13} \\ &\quad - 0.3628 \ell_n X_{14} \qquad R^2 = 0.640 \quad (4-74) \end{aligned}$$

$$\ell_n C''_{w.la} = 3.7997 - 0.0799 \ell_n X_{14} \qquad R^2 = 0.592 \quad (4-75)$$

$$\ell_n C'''_{w.la} = 0.3559 - 0.1511 \ell_n X_{14} \qquad R^2 = 0.804 \quad (4-76)$$

$$\begin{aligned} \ell_n C''''_{w.la} &= 1.6751 + 0.0016 \ell_n X_{13} \\ &\quad - 0.6315 \ell_n X_{15} \qquad R^2 = 0.579 \quad (4-77) \end{aligned}$$

where:  $C'_{w.af}$  = per capita construction cost, Africa (\$U.S.)

$C''_{w.af}$  = per MGD construction cost, Africa (\$1000 U.S.)

$C'''_{w.af}$  = per capita per year operation and maintenance cost, Africa (\$U.S.)

$C''''_{w.af}$  = per MGD per year operation and maintenance cost, Africa (\$1000 U.S.)

$C'_{w.as}$  = per capita construction cost, Asia (\$U.S.)

$C''_{w.as}$  = per MGD construction cost, Asia (\$1000 U.S.)

$C'''_{w.as}$  = per capita per year operation and maintenance cost, Asia (\$U.S.)

$C''''_{w.as}$  = per MGD per year operation and maintenance cost, Asia (\$1000 U.S.)

$C'_{w.la}$  = per capita construction cost, Latin America (\$U.S.)

$C''_{w.la}$  = per MGD construction cost, Latin America (\$1000 U.S.)

$C'''_{w.la}$  = per capita per year operation and maintenance cost, Latin America (\$U.S.)

$C''''_{w.la}$  = per MGD per year operation and maintenance cost Latin America (\$1000 U.S.)

$D_w$  = water demand (gpcd)

$X_{13}$  = percentage cost of imported water supply materials

$X_{14}$  = design population for water supply (1000's)

$X_{15}$  = design capacity for water supply in million gallons per day (MGD).

Equations for predicting construction and maintenance and operation costs of rapid sand filters are as follows:

$$\begin{aligned} \ell_n C'_{w.af} &= 3.1325 + 0.0024 \ell_n D_w \\ &\quad - 0.885 \ell_n X_{14} \end{aligned} \quad R^2 = 0.902 \quad (4-78)$$

$$\begin{aligned} \ell_n C''_{w.af} &= 5.8975 + 0.0097 \ell_n X_{13} \\ &\quad - 0.0127 \ell_n X_{14} \end{aligned} \quad R^2 = 0.859 \quad (4-79)$$

$$\begin{aligned} \ell_n C'''_{w.af} &= 1.9229 + 0.0396 \ell_n D_w \\ &\quad - 0.2596 \ell_n X_{14} \end{aligned} \quad R^2 = 0.953 \quad (4-80)$$

$$\begin{aligned} \ell_n C''''_{w.af} &= 4.7581 + 0.023 \ell_n X_{13} \\ &\quad - 0.0370 \ell_n X_{15} \end{aligned} \quad R^2 = 0.865 \quad (4-81)$$

$$\begin{aligned} \ell_n C'_{w.as} &= 3.3160 + 0.0017 \ell_n X_{13} \\ &\quad - 0.0901 \ell_n X_{15} \end{aligned} \quad R^2 = 0.870 \quad (4-82)$$

$$\begin{aligned} \ell_n C''_{w.as} &= 6.3884 + 0.0065 \ell_n X_{13} \\ &\quad - 0.0380 \ell_n X_{15} \end{aligned} \quad R^2 = 0.877 \quad (4-83)$$

$$\begin{aligned} \ell_n C'''_{w.as} &= 2.7466 + 0.0088 \ell_n D_w \\ &\quad - 0.2065 \ell_n X_{14} \end{aligned} \quad R^2 = 0.940 \quad (4-84)$$

$$\begin{aligned} \ell_n C''''_{w.as} &= 5.0991 + 0.0248 \ell_n X_{13} \\ &\quad - 0.0553 \ell_n X_{15} \end{aligned} \quad R^2 = 0.902 \quad (4-85)$$



$$\begin{aligned} \ell_n C'_{w.1a} &= 3.4597 + 0.0021 \ell_n X_{13} \\ &\quad - 0.0901 \ell_n X_{15} \end{aligned} \quad R^2 = 0.876 \quad (4-86)$$

$$\begin{aligned} \ell_n C''_{w.1a} &= 6.1323 + 0.0027 \ell_n X_{14} \\ &\quad - 0.0236 \ell_n X_{15} \end{aligned} \quad R^2 = 0.960 \quad (4-87)$$

$$\begin{aligned} \ell_n C'''_{w.1a} &= 2.0127 + 0.0238 \ell_n X_{13} \\ &\quad - 0.3007 \ell_n X_{15} \end{aligned} \quad R^2 = 0.897 \quad (4-88)$$

$$\begin{aligned} \ell_n C''''_{w.1a} &= 4.7829 + 0.0448 \ell_n X_{13} \\ &\quad - 0.0530 \ell_n X_{15} \end{aligned} \quad R^2 = 0.968 \quad (4-89)$$

Wastewater Treatment Cost Model. The last set of predictive equations were developed for construction, and operation and maintenance costs of wastewater treatment for the three regions using seven independent variables as shown previously in Figure IV.1. Variables  $X_{17}$ ,  $X_{18}$ ,  $X_{19}$ , and  $X_{22}$  were non-significant since most of the wastewater plants did not provide influent and effluent BOD values. The variables  $X_{16}$  and  $X_{20}$  gave the best correlation for all wastewater treatment processes (stabilization lagoon, aerated lagoon, activated sludge and trickling filter). The technological indicator ( $X_{21}$ ) appeared in the regression equations of the three more advanced wastewater treatment processes (aerated lagoon, activated sludge, and trickling filter), especially in the operation and the maintenance equations. The conclusion is that in the developing countries machines such as aerators, motors, and chemicals have to be imported for these processes. Therefore, in developing countries where land is cheap the stabilization lagoon or other land-type processes are the appropriate technology.

Each equation developed satisfied the sequential F-test and corrected coefficient of determination except for equations 4-110 and 4-117. The best fit equations for predicting construction, operation and maintenance costs of stabilization lagoons are:

$$\ell_n C'_{ww.af} = 1.3955 - 0.1845 \ell_n X_{16} \quad R^2 = 0.980 \quad (4-90)$$

$$\ell_n C''_{ww.af} = 4.0770 - 0.0440 \ell_n X_{16} \quad R^2 = 0.826 \quad (4-91)$$

$$\ell_n C'''_{ww.af} = -0.2532 - 0.2837 \ell_n X_{16} \quad R^2 = 0.917 \quad (4-92)$$

$$\begin{aligned} \ell_n C''''_{ww.af} &= 2.0967 - 0.2683 \ell_n X_{16} \\ &\quad - 0.0345 \ell_n X_{20} \end{aligned} \quad R^2 = 0.864 \quad (4-93)$$

$$\ell_n C'_{ww.as} = 1.5304 - 0.2152 \ell_n X_{16} \quad R^2 = 0.806 \quad (4-94)$$

$$\ell_n C''_{ww.as} = 4.9849 - 0.2594 \ell_n X_{16} \quad R^2 = 0.980 \quad (4-95)$$

$$\ell_n C'''_{ww.as} = -0.3274 - 0.1846 \ell_n X_{16} \quad R^2 = 0.788 \quad (4-96)$$

$$\ell_n C''''_{ww.as} = 2.2242 - 0.0035 \ell_n X_{16} \quad R^2 = 0.784 \quad (4-97)$$

$$\ell_n C'_{ww.la} = 1.7880 - 0.0979 \ell_n X_{16} \quad R^2 = 0.810 \quad (4-98)$$

$$\begin{aligned} \ell_n C''_{ww.la} &= 4.6571 - 0.0079 \ell_n X_{16} \\ &\quad - 0.0043 \ell_n X_{20} \end{aligned} \quad R^2 = 0.960 \quad (4-99)$$

$$\ell_n C'''_{ww.la} = 0.2597 - 0.0879 \ell_n X_{16} \quad R^2 = 0.806 \quad (4-100)$$

$$\begin{aligned} \ell_n C''''_{ww.la} &= 2.5720 - 0.2160 \ell_n X_{16} \\ &\quad - 0.0024 \ell_n X_{20} \end{aligned} \quad R^2 = 0.848 \quad (4-101)$$

Equations for predicting construction, operation and maintenance costs of aerated lagoons are as follows:

$$\ell_n C'_{ww.af} = 1.4768 - 0.1132 \ell_n X_{16} \quad R^2 = 0.990 \quad (4-102)$$

$$\begin{aligned} \ell_n C''_{ww.af} &= 4.8764 - 0.0025 \ell_n X_{16} \\ &\quad - 0.1214 \ell_n X_{20} \end{aligned} \quad R^2 = 0.861 \quad (4-103)$$

$$\ell_n C'''_{ww.af} = 0.1136 - 0.1435 \ell_n X_{16} \quad R^2 = 0.865 \quad (4-104)$$

$$\ell_n C''''_{ww.af} = 3.7754 - 0.2854 \ell_n X_{20} \quad R^2 = 0.853 \quad (4-105)$$

$$\ell_n C'_{ww.as} = 1.6395 - 0.1565 \ell_n X_{16} \quad R^2 = 0.898 \quad (4-106)$$

$$\begin{aligned} \ell_n C''_{ww.as} &= 5.0595 - 0.0475 \ell_n X_{16} \\ &\quad - 0.2105 \ell_n X_{20} \end{aligned} \quad R^2 = 0.988 \quad (4-107)$$

$$\ell_n C'''_{ww.as} = 0.3561 - 0.0955 \ell_n X_{16} \quad R^2 = 0.958 \quad (4-108)$$

$$\begin{aligned} \ell_n C''''_{ww.as} &= 3.9509 - 0.2170 \ell_n X_{20} \\ &\quad + 0.0032 \ell_n X_{21} \end{aligned} \quad R^2 = 0.853 \quad (4-109)$$

$$\ell_n C'_{ww.la} = 1.7581 - 0.1461 \ell_n X_{16} \quad (4-110)$$

$$\ell_n C''_{ww.la} = 5.4210 - 0.1645 \ell_n X_{20} \quad R^2 = 0.956 \quad (4-111)$$

$$\ell_n C'''_{ww.la} = 0.21149 - 0.1600 \ell_n X_{16} \quad R^2 = 0.921 \quad (4-112)$$

$$\ell_n C''''_{ww.la} = 4.023 - 0.3659 \ell_n X_{20} \quad R^2 = 0.948 \quad (4-113)$$

Equations for predicting construction, operation and maintenance cost of activated sludge treatment are as follows:

$$\ell_n C'_{ww.af} = 3.0051 - 0.3090 \ell_n X_{16} \quad R^2 = 0.984 \quad (4-114)$$

$$\begin{aligned} \ell_n C''_{ww.af} &= 6.5907 - 0.3020 \ell_n X_{20} \\ &+ 0.0021 \ell_n X_{21} \quad R^2 = 0.917 \quad (4-115) \end{aligned}$$

$$\begin{aligned} \ell_n C'''_{ww.af} &= 1.5225 - 0.3307 \ell_n X_{16} \\ &+ 0.0032 \ell_n X_{21} \quad R^2 = 0.960 \quad (4-116) \end{aligned}$$

$$\ell_n C''''_{ww.af} = 5.1250 - 0.3355 \ell_n X_{20} \quad (4-117)$$

$$\begin{aligned} \ell_n C'_{ww.as} &= 2.8597 - 0.2890 \ell_n X_{16} \\ &+ 0.0201 \ell_n X_{21} \quad R^2 = 0.937 \quad (4-118) \end{aligned}$$

$$\begin{aligned} \ell_n C''_{ww.as} &= 5.7594 - 0.2645 \ell_n X_{16} \\ &+ 0.2644 \ell_n X_{21} \quad R^2 = 0.902 \quad (4-119) \end{aligned}$$

$$\begin{aligned} \ell_n C'''_{ww.as} &= 1.7534 - 0.4269 \ell_n X_{16} \\ &+ 0.0021 \ell_n X_{21} \quad R^2 = 0.948 \quad (4-120) \end{aligned}$$

$$\begin{aligned} \ell_n C''''_{ww.as} &= 4.9224 - 0.2754 \ell_n X_{16} \\ &+ 0.0021 \ell_n X_{21} \quad R^2 = 0.948 \quad (4-121) \end{aligned}$$

$$\ell_n C'_{ww.la} = 2.8967 - 0.2709 \ell_n X_{16} \quad R^2 = 0.940 \quad (4-122)$$

$$\begin{aligned} \ell_n C''_{ww.la} &= 7.2754 - 0.0035 \ell_n X_{16} \\ &- 0.3575 \ell_n X_{20} \quad R^2 = 0.968 \quad (4-123) \end{aligned}$$

$$\ell_n C'''_{ww.la} = 1.7526 - 0.4002 \ell_n X_{16} \quad R^2 = 0.887 \quad (4-124)$$

$$\begin{aligned} \ell_n C''''_{ww.la} &= 5.6075 - 0.0073 \ell_n X_{16} \\ &- 0.3902 \ell_n X_{20} \quad R^2 = 0.865 \quad (4-125) \end{aligned}$$

Equations for predicting construction, operation and maintenance cost of trickling filter treatment are as follows:

$$\ell_n C'_{ww.af} = 3.1058 - 0.2546 \ell_n X_{16} \quad R^2 = 0.938 \quad (4-126)$$

$$\ell_n C''_{ww.af} = 7.2400 - 0.5503 \ell_n X_{20} \quad R^2 = 0.966 \quad (4-127)$$

$$\ell_n C'''_{ww.af} = 1.5591 - 0.3105 \ell_n X_{16} \quad R^2 = 0.910 \quad (4-128)$$

$$\begin{aligned} \ell_n C''''_{ww.af} &= 5.1240 - 0.3355 \ell_n X_{20} \\ &+ 0.0024 \ell_n X_{21} \end{aligned} \quad R^2 = 0.958 \quad (4-129)$$

$$\begin{aligned} \ell_n C'_{ww.as} &= 3.0021 - 0.3410 \ell_n X_{16} \\ &+ 0.0124 \ell_n X_{21} \end{aligned} \quad R^2 = 0.966 \quad (4-130)$$

$$\ell_n C''_{ww.as} = 7.0453 - 0.5709 \ell_n X_{20} \quad R^2 = 0.940 \quad (4-131)$$

$$\ell_n C'''_{ww.as} = 1.8641 - 0.3507 \ell_n X_{16} \quad R^2 = 0.913 \quad (4-132)$$

$$\begin{aligned} \ell_n C''''_{ww.as} &= 5.2594 - 0.2659 \ell_n X_{16} \\ &+ 0.0211 \ell_n X_{21} \end{aligned} \quad R^2 = 0.896 \quad (4-133)$$

$$\ell_n C'_{ww.1a} = 3.3345 - 0.2491 \ell_n X_{16} \quad R^2 = 0.929 \quad (4-134)$$

$$\ell_n C''_{ww.1a} = 6.9852 - 0.3294 \ell_n X_{20} \quad R^2 = 0.958 \quad (4-135)$$

$$\ell_n C'''_{ww.1a} = 1.7543 - 0.2009 \ell_n X_{16} \quad R^2 = 0.937 \quad (4-136)$$

$$\ell_n C''''_{ww.1a} = 5.975 - 0.2956 \ell_n X_{20} \quad R^2 = 0.900 \quad (4-137)$$

- $C'_{ww.af}$  = per capita construction cost, Africa (\$U.S.)  
 $C''_{ww.af}$  = per MGD construction cost, Africa (\$1000 U.S.)  
 $C'''_{ww.af}$  = per capita per year operation and maintenance cost, Africa (\$U.S.)  
 $C''''_{ww.af}$  = per MGD per year operation and maintenance cost, (\$1000 U.S.)  
 $C'_{ww.as}$  = per capita construction cost, Asia (\$U.S.)  
 $C''_{ww.as}$  = per MGD construction cost, Asia (\$1000 U.S.)  
 $C'''_{ww.as}$  = per capita per year operation and maintenance cost, Asia (U.S.)  
 $C''''_{ww.as}$  = per MGD per year operation and maintenance cost, Asia (\$1000 U.S.)  
 $C'_{ww.la}$  = per capita construction cost, Latin America (\$U.S.)  
 $C''_{ww.la}$  = per MGD construction cost, Latin America (\$1000 U.S.)  
 $C'''_{ww.la}$  = per capita per year operation and maintenance cost, Latin America (\$U.S.)  
 $C''''_{ww.la}$  = per MGD per year operation and maintenance cost, Latin America (\$1000 U.S.)  
 $X_{16}$  = design population for wastewater (1000's)  
 $X_{20}$  = design flow of wastewater plant (MGD)  
 $X_{21}$  = percent of cost of imported wastewater disposal materials.

Comments Regarding Models. The non-logarithmic linear form resulted in better predictive equations for the water demand and wastewater disposal models, producing higher  $R^2$  values and satisfying the sequential F-test criteria. The log-log linear form gave better predictive equations in water and wastewater treatment cost models. In almost all cases, the rapid sand filter construction, operation and maintenance costs were correlated with variable  $X_{13}$ , percentage of cost of imported water supply materials, while activated sludge and trickling filter were correlated with variable  $X_{21}$ , percentage of

cost of imported wastewater disposal materials. This shows that an abundance of materials have to be imported for constructing, as well as operating and maintaining these high technology processes.

In Tables IV.4,5,6,7 correlation matrices, degrees of freedom, deviations, residual mean squares (RESMS) are given for estimating standard errors of estimated expected values with a ninety-five percent confidence interval. Table IV.8 shows typical construction, operation and maintenance costs of slow sand and rapid sand filters for selected socio-economic and technological conditions using the predictive equations. Table IV.9 gives comparison costs of wastewater treatment processes for the Cpheri-Nagpur study done in India (25) and the predictive equations developed here. Tables IV.10-17 in the appendix for Chapter IV give results obtained with the equations.

#### ADDITIONAL RESEARCH

Additional research is needed to evaluate and strengthen the models developed in this study.

- (1) It is possible that these models could be refined by inclusion of additional socio-cultural data. This would require fieldwork in one or two countries as case studies.
- (2) Case studies of water demand are needed from two areas. These would include more detailed data than could be obtained by mail survey.
  - (a) One country should be selected among the arid areas of the Middle East, for example, Saudi Arabia.
  - (b) Another country should be selected in a tropical region, for example, Zaire.
- (3) More mathematical models should be developed which are based on conditions of developing countries and

TABLE IV.4  
EQUATIONS FOR ESTIMATING STANDARD ERRORS FOR WATER DEMAND MODEL

WATER DEMAND MODEL	CORRELATION MATRIX $C_{ij}$						DEVIATIONS						Resms	N
	$C_{22}$	$C_{55}$	$C_{66}$	$C_{25}$	$C_{26}$	$C_{56}$	$X_2$	$X_5$	$X_6$	Resms	N			
	$D_{w.af}$	$D_{w.a}$	$D_{w.la}$				$X_2^-$	$X_5^-$	$X_6^-$					
	0.0002	-0.0005	0.0001	0.0016	0.0000	-0.0012	$X_2^-$ (1050)	$X_5^-$ (-19)	$X_6^-$ (-500)	0.2231	89			
	0.0000	0.0015	0.0000	-0.0001	0.0000	0.0002	$X_2^-$ (875)	$X_5^-$ (-38)	$X_6^-$ (-350)	0.2001	70			
	0.0000	0.0022	0.0000	-0.0001	0.0001	-0.0001	$X_2^-$ (+25)	$X_5^-$ (-49)	$X_6^-$ (-55)	0.1167	65			

Standard error of estimated expected values:

$$S_{D_{w.af}} = t_{.95, df} \left[ \text{Resms} \left( \frac{1}{N} + C_{22} X_2^2 + C_{55} X_5^2 + C_{66} X_6^2 + 2C_{25} X_2 X_5 + 2C_{26} X_2 X_6 + 2C_{56} X_5 X_6 \right) \right]^{\frac{1}{2}} \quad df = 89 - 2 - 1 = 86$$

$$S_{D_{w.a}} = t_{.95, df} \left[ \text{Resms} \left( \frac{1}{N} + C_{22} X_2^2 + C_{55} X_5^2 + C_{66} X_6^2 + 2C_{25} X_2 X_5 + 2C_{26} X_2 X_6 + 2C_{56} X_5 X_6 \right) \right]^{\frac{1}{2}} \quad df=66$$

$$S_{D_{w.la}} = t_{.95, df} \left[ \text{Resms} \left( \frac{1}{N} + C_{22} X_2^2 + C_{55} X_5^2 + C_{66} X_6^2 + 2C_{25} X_2 X_5 + 2C_{26} X_2 X_6 + 2C_{56} X_5 X_6 \right) \right]^{\frac{1}{2}} \quad df=61$$

Resms = residual mean squares. df = degrees of freedom = N - V - 1.  
N = number of observations. V = number of variables.



TABLE IV.5  
EQUATIONS FOR ESTIMATING STANDARD ERRORS FOR WASTEWATER DISPOSAL

WASTE WATER DISPOSAL MODEL	CORRELATION MATRIX					DEVIATIONS					Resms	N
	C <sub>ij</sub>					d <sub>w</sub>	X <sub>10</sub>	X <sub>11</sub>	Resms	N		
	C <sub>ww</sub>	C <sub>10 10</sub>	C <sub>11 11</sub>	C <sub>w 10</sub>	C <sub>w 11</sub>							
D <sub>ww.af</sub>	0.0024	0.0016	0.0000	-0.000	0.0000	0.0001	D <sub>w</sub> <sup>-</sup> (-6.5)	X <sub>10</sub> <sup>-</sup> (-4.5)	X <sub>11</sub> <sup>-</sup> (-7.5)	0.2368	49	
D <sub>ww.as</sub>	0.0032	0.0000	0.0003	0.00502	0.0011	0.0000	D <sub>w</sub> <sup>-</sup> (-4.5)	X <sub>10</sub> <sup>-</sup> (-11.2)	X <sub>11</sub> <sup>-</sup> (-13.9)	0.1274	55	
D <sub>ww.la</sub>	0.0100	0.0022	0.0002	0.0009	0.0002	0.0000	D <sub>w</sub> <sup>-</sup> (-4.8)	X <sub>10</sub> <sup>-</sup> (-2.3)	X <sub>11</sub> <sup>-</sup> (-3.9)	0.4509	46	

Standard errors of estimated expected values

$$S_{D_{ww.af}} = \frac{-t}{.95, df} \left[ \text{Resms} \left( \frac{1}{N} + C_{ww} d_w^2 + C_{10} X_{10}^2 + C_{11} X_{11}^2 + 2C_w X_{10} + 2C_w X_{11} + 2C_{10} X_{10} X_{11} \right) \right]^{\frac{1}{2}} \quad df=45$$

$$S_{D_{ww.as}} = \frac{-t}{.95, df} \left[ \text{Resms} \left( \frac{1}{N} + C_{ww} d_w^2 + C_{10} X_{10}^2 + C_{11} X_{11}^2 + 2C_w X_{10} + 2C_w X_{11} + 2C_{10} X_{10} X_{11} \right) \right]^{\frac{1}{2}} \quad df=51$$

$$S_{D_{ww.la}} = \frac{-t}{.95, df} \left[ \text{Resms} \left( \frac{1}{N} + C_{ww} d_w^2 + C_{10} X_{10}^2 + C_{11} X_{11}^2 + 2C_w X_{10} + 2C_w X_{11} + 2C_{10} X_{10} X_{11} \right) \right]^{\frac{1}{2}} \quad df=42$$

TABLE IV.6

EQUATIONS FOR ESTIMATING STANDARD ERRORS FOR WATER TREATMENT COST MODEL

		Correlation Matrix									
		$C_{ww}$	$C_{13\ 13}$	$C_{14\ 14}$	$C_{15\ 15}$	$C_{w\ 13}$	$C_{w\ 14}$	$C_{w\ 15}$	$C_{13\ 14}$	$C_{13\ 15}$	$C_{14\ 15}$
SLOW SAND FILTER	$C'_{ww,af}$	0.0005	0.0000	0.0040	0.0000	0.0001	0.0021	0.0003	0.0000	0.0006	0.0000
	$C'_{ww,af}$	0.0003	0.0000	0.0031	0.0041	0.0010	0.0001	0.0000	0.0001	0.0000	0.0021
	$C'_{ww,af}$	0.0010	0.0011	0.0110	0.0000	0.0011	0.0010	0.0061	0.0018	0.0011	0.0044
	$C'_{ww,af}$	0.0006	0.0000	0.0127	0.0002	0.0021	0.0006	0.0021	0.0000	0.0000	0.0009
	$C'_{ww,as}$	0.0000	0.0110	0.0101	0.0004	0.0000	0.0008	0.0013	0.0161	0.0016	0.0000
	$C'_{ww,as}$	0.0001	0.0021	0.0000	0.0011	0.0001	0.0061	0.0005	0.0111	0.0000	0.0003
	$C'_{ww,as}$	0.0002	0.0003	0.0006	0.0031	0.0101	0.0000	0.0030	0.0016	0.0009	0.0004
	$C'_{ww,as}$	0.0009	0.0004	0.0104	0.0006	0.0000	0.0001	0.0008	0.0000	0.0006	0.0000
	$C'_{ww,la}$	0.0013	0.0201	0.0000	0.0004	0.0003	0.0000	0.0000	0.0016	0.0021	0.0211
	$C'_{ww,la}$	0.0030	0.0000	0.0600	0.0000	0.0001	0.0061	0.0037	0.0000	0.0111	0.0031
	$C'_{ww,la}$	0.0050	0.0000	0.0011	0.0041	0.0041	0.0004	0.0081	0.0061	0.0000	0.0046
	$C'_{ww,la}$	0.0031	0.0111	0.0009	0.0000	0.0011	0.0031	0.0000	0.0031	0.0000	0.0039
RAPID SAND FILTER	$C'_{ww,af}$	0.0000	0.0034	0.0000	0.0034	0.0041	0.0004	0.0000	0.0041	0.0011	0.0006
	$C'_{ww,af}$	0.0021	0.0017	0.0008	0.0000	0.0001	0.0036	0.0101	0.0064	0.0061	0.0031
	$C'_{ww,af}$	0.0000	0.0016	0.0000	0.0010	0.0011	0.0008	0.0003	0.0000	0.0094	0.0041
	$C'_{ww,af}$	0.0090	0.0000	0.0131	0.0000	0.0021	0.0031	0.0001	0.0011	0.0010	0.0000
	$C'_{ww,as}$	0.0000	0.0000	0.0006	0.0020	0.0011	0.0000	0.0009	0.0004	0.0001	0.0061
	$C'_{ww,as}$	0.0210	0.0000	0.0000	0.0009	0.0101	0.0008	0.0001	0.0061	0.0000	0.0031
	$C'_{ww,as}$	0.0121	0.0031	0.0401	0.0304	0.0000	0.0021	0.0021	0.0041	0.0116	0.0000
	$C'_{ww,as}$	0.0000	0.0131	0.0016	0.0000	0.0071	0.0000	0.0040	0.0009	0.0109	0.0017
	$C'_{ww,la}$	0.0000	0.0090	0.0000	0.0008	0.0061	0.0000	0.0081	0.0000	0.0008	0.0049
	$C'_{ww,la}$	0.0001	0.0061	0.0071	0.0000	0.0031	0.0101	0.0061	0.0211	0.0045	0.0000
	$C'_{ww,la}$	0.0010	0.0000	0.0008	0.0001	0.0041	0.0031	0.0031	0.0017	0.0008	0.0094
	$C'_{ww,la}$	0.0030	0.0008	0.0000	0.0204	0.0000	0.0017	0.0112	0.0016	0.0106	0.0105

Sample equation for estimating standard error of estimated expected value for Slow Sand Filter

$$S_{in} C'_{w,af} = t_{.95, df} \left[ \frac{1}{N} + C_{ww} d_w^2 + C_{14} X_{14}^2 + C_{w\ 14} X_{14} \right] \quad \dagger \quad df=62$$

TABLE IV.6--Continued

	Deviations				Resms	N
	$d_w$	$x_{13}$	$x_{14}$	$x_{15}$		
SLOW SAND FILTER	C'ww.af	lnDw <sup>-</sup> (-30)	lnX <sub>13</sub> <sup>-</sup> (-10)	lnX <sub>14</sub> <sup>-</sup> (-200)	lnX <sub>15</sub> <sup>-</sup> (-11)0.1750	65
	C'ww.af	lnD <sub>w</sub> <sup>-</sup> (-30)	lnX <sub>13</sub> <sup>-</sup> (-10)	lnX <sub>14</sub> <sup>-</sup> (-200)	lnX <sub>15</sub> <sup>-</sup> (-11)0.2650	65
	C'ww.af	lnD <sub>w</sub> <sup>-</sup> (-30)	lnX <sub>13</sub> <sup>-</sup> (-10)	lnX <sub>14</sub> <sup>-</sup> (-200)	lnX <sub>15</sub> <sup>-</sup> (-11)0.1270	65
	C'ww.af	lnD <sub>w</sub> <sup>-</sup> (-30)	lnX <sub>13</sub> <sup>-</sup> (-10)	lnX <sub>14</sub> <sup>-</sup> (-200)	lnX <sub>15</sub> <sup>-</sup> (-11)0.1350	65
	C'ww.as	lnD <sub>w</sub> <sup>-</sup> (+4.5)	lnX <sub>13</sub> <sup>-</sup> (-6)	lnX <sub>14</sub> <sup>-</sup> (-29)	lnX <sub>15</sub> <sup>-</sup> (-9)0.3450	49
	C'ww.as	lnD <sub>w</sub> <sup>-</sup> (+4.5)	lnX <sub>13</sub> <sup>-</sup> (-6)	lnX <sub>14</sub> <sup>-</sup> (-29)	lnX <sub>15</sub> <sup>-</sup> (-9)0.3050	49
	C'ww.as	lnD <sub>w</sub> <sup>-</sup> (+4.5)	lnX <sub>13</sub> <sup>-</sup> (-6)	lnX <sub>14</sub> <sup>-</sup> (-29)	lnX <sub>15</sub> <sup>-</sup> (-9)0.2603	49
	C'ww.as	lnD <sub>w</sub> <sup>-</sup> (+4.5)	lnX <sub>13</sub> <sup>-</sup> (-6)	lnX <sub>14</sub> <sup>-</sup> (-29)	lnX <sub>15</sub> <sup>-</sup> (-9)0.1017	49
	C'ww.ia	lnD <sub>w</sub> <sup>-</sup> (-6.7)	lnX <sub>13</sub> <sup>-</sup> (-18)	lnX <sub>14</sub> <sup>-</sup> (-45)	lnX <sub>15</sub> <sup>-</sup> (-14)0.1920	39
	C'ww.ia	lnD <sub>w</sub> <sup>-</sup> (-6.7)	lnX <sub>13</sub> <sup>-</sup> (-18)	lnX <sub>14</sub> <sup>-</sup> (-45)	lnX <sub>15</sub> <sup>-</sup> (-14)0.2001	39
	C'ww.ia	lnD <sub>w</sub> <sup>-</sup> (-6.7)	lnX <sub>13</sub> <sup>-</sup> (-18)	lnX <sub>14</sub> <sup>-</sup> (-45)	lnX <sub>15</sub> <sup>-</sup> (-14)0.1021	39
	C'ww.ia	lnD <sub>w</sub> <sup>-</sup> (-6.7)	lnX <sub>13</sub> <sup>-</sup> (-18)	lnX <sub>14</sub> <sup>-</sup> (-45)	lnX <sub>15</sub> <sup>-</sup> (-14)0.1450	39
RAPID SAND FILTER	C'ww.af	lnDw <sup>-</sup> (-5)	lnX <sub>13</sub> <sup>-</sup> (-25)	lnX <sub>14</sub> <sup>-</sup> (-15)	lnX <sub>15</sub> <sup>-</sup> (-8)0.1060	48
	C'ww.af	lnD <sub>w</sub> <sup>-</sup> (-5)	lnX <sub>13</sub> <sup>-</sup> (-25)	lnX <sub>14</sub> <sup>-</sup> (-15)	lnX <sub>15</sub> <sup>-</sup> (-8)0.1260	48
	C'ww.af	lnD <sub>w</sub> <sup>-</sup> (-5)	lnX <sub>13</sub> <sup>-</sup> (-25)	lnX <sub>14</sub> <sup>-</sup> (-15)	lnX <sub>15</sub> <sup>-</sup> (-8)0.1102	48
	C'ww.af	lnD <sub>w</sub> <sup>-</sup> (-5)	lnX <sub>13</sub> <sup>-</sup> (-25)	lnX <sub>14</sub> <sup>-</sup> (-15)	lnX <sub>15</sub> <sup>-</sup> (-8)0.1507	48
	C'ww.as	lnD <sub>w</sub> <sup>-</sup> (-12)	lnX <sub>13</sub> <sup>-</sup> (-3)	lnX <sub>14</sub> <sup>-</sup> (-23)	lnX <sub>15</sub> <sup>-</sup> (-4.4)0.1801	58
	C'ww.as	lnD <sub>w</sub> <sup>-</sup> (-12)	lnX <sub>13</sub> <sup>-</sup> (-3)	lnX <sub>14</sub> <sup>-</sup> (-23)	lnX <sub>15</sub> <sup>-</sup> (-4.4)0.2007	58
	C'ww.as	lnD <sub>w</sub> <sup>-</sup> (-12)	lnX <sub>13</sub> <sup>-</sup> (-3)	lnX <sub>14</sub> <sup>-</sup> (-23)	lnX <sub>15</sub> <sup>-</sup> (-4.4)0.19007	58
	C'ww.as	lnD <sub>w</sub> <sup>-</sup> (-12)	lnX <sub>13</sub> <sup>-</sup> (-3)	lnX <sub>14</sub> <sup>-</sup> (-23)	lnX <sub>15</sub> <sup>-</sup> (-4.4)0.1609	58
	C'ww.ia	lnD <sub>w</sub> <sup>-</sup> (-4)	lnX <sub>13</sub> <sup>-</sup> (-15)	lnX <sub>14</sub> <sup>-</sup> (-6.5)	lnX <sub>15</sub> <sup>-</sup> (-3.9)0.1340	45
	C'ww.ia	lnD <sub>w</sub> <sup>-</sup> (-4)	lnX <sub>13</sub> <sup>-</sup> (-15)	lnX <sub>14</sub> <sup>-</sup> (-6.5)	lnX <sub>15</sub> <sup>-</sup> (-3.9)0.1445	45
	C'ww.ia	lnD <sub>w</sub> <sup>-</sup> (-4)	lnX <sub>13</sub> <sup>-</sup> (-15)	lnX <sub>14</sub> <sup>-</sup> (-6.5)	lnX <sub>15</sub> <sup>-</sup> (-3.9)0.1501	45
	C'ww.ia	lnD <sub>w</sub> <sup>-</sup> (-4)	lnX <sub>13</sub> <sup>-</sup> (-15)	lnX <sub>14</sub> <sup>-</sup> (-6.5)	lnX <sub>15</sub> <sup>-</sup> (-3.9)0.1906	45



TABLE IV.7--Continued

	C <sub>16 16</sub>	C <sub>20 20</sub>	C <sub>21 21</sub>	C <sub>16 20</sub>	C <sub>16 21</sub>	C <sub>20 21</sub>	X <sub>16</sub>	X <sub>20</sub>	X <sub>21</sub>	Resms	N
ACTIVATED SLUDGE	C <sup>ww.af</sup>	0.0101	0.0021	0.0000	0.0209	0.0071	lnX <sub>16</sub> <sup>-(-9)</sup>	lnX <sub>20</sub> <sup>-(-5)</sup>	lnX <sub>21</sub> <sup>-(-2)</sup>	0.1241	26
	C <sup>ww.af</sup>	0.0034	0.0103	0.0002	0.0004	0.0031	lnX <sub>16</sub> <sup>-(-9)</sup>	lnX <sub>20</sub> <sup>-(-5)</sup>	lnX <sub>21</sub> <sup>-(-2)</sup>	0.2017	26
	C <sup>ww.af</sup>	0.0000	0.0045	0.0061	0.0000	0.0041	lnX <sub>16</sub> <sup>-(-9)</sup>	lnX <sub>20</sub> <sup>-(-5)</sup>	lnX <sub>21</sub> <sup>-(-2)</sup>	0.1009	26
	C <sup>ww.af</sup>	0.0301	0.0009	0.0007	0.0000	0.0008	lnX <sub>16</sub> <sup>-(-9)</sup>	lnX <sub>20</sub> <sup>-(-5)</sup>	lnX <sub>21</sub> <sup>-(-2)</sup>	0.3000	26
	C <sup>ww.as</sup>	0.0000	0.0000	0.0003	0.0110	0.0003	lnX <sub>16</sub> <sup>-(-31)</sup>	lnX <sub>20</sub> <sup>-(-3)</sup>	lnX <sub>21</sub> <sup>-(-7)</sup>	0.4011	32
	C <sup>ww.as</sup>	0.0203	0.00701	0.0008	0.0309	0.0041	lnX <sub>16</sub> <sup>-(-31)</sup>	lnX <sub>20</sub> <sup>-(-3)</sup>	lnX <sub>21</sub> <sup>-(-7)</sup>	0.1107	32
	C <sup>ww.as</sup>	0.0011	0.0301	0.0009	0.0220	0.0010	lnX <sub>16</sub> <sup>-(-31)</sup>	lnX <sub>20</sub> <sup>-(-3)</sup>	lnX <sub>21</sub> <sup>-(-7)</sup>	0.2111	32
	C <sup>ww.as</sup>	0.0035	0.0404	0.0001	0.0030	0.0004	lnX <sub>16</sub> <sup>-(-31)</sup>	lnX <sub>20</sub> <sup>-(-3)</sup>	lnX <sub>21</sub> <sup>-(-7)</sup>	0.3044	32
	C <sup>ww.la</sup>	0.0008	0.00504	0.0204	0.0016	0.0034	lnX <sub>16</sub> <sup>-(-75)</sup>	lnX <sub>20</sub> <sup>-(-9)</sup>	lnX <sub>21</sub> <sup>-(-9)</sup>	0.3066	34
	C <sup>ww.la</sup>	0.0000	0.00305	0.0207	0.0019	0.0044	lnX <sub>16</sub> <sup>-(-75)</sup>	lnX <sub>20</sub> <sup>-(-9)</sup>	lnX <sub>21</sub> <sup>-(-9)</sup>	0.1070	34
	C <sup>ww.la</sup>	0.0061	0.00701	0.0093	0.0017	0.0000	lnX <sub>16</sub> <sup>-(-75)</sup>	lnX <sub>20</sub> <sup>-(-9)</sup>	lnX <sub>21</sub> <sup>-(-9)</sup>	0.17011	34
	C <sup>ww.la</sup>	0.0209	0.0000	0.0000	0.0015	0.0007	lnX <sub>16</sub> <sup>-(-75)</sup>	lnX <sub>20</sub> <sup>-(-9)</sup>	lnX <sub>21</sub> <sup>-(-9)</sup>	0.1003	34
TRICKLING FILTER	C <sup>ww.af</sup>	0.0301	0.0065	0.0300	0.0014	0.0008	lnX <sub>16</sub> <sup>-(-48)</sup>	lnX <sub>20</sub> <sup>+(-3)</sup>	lnX <sub>21</sub> <sup>-(-1)</sup>	0.1604	29
	C <sup>ww.af</sup>	0.0000	0.0020	0.0401	0.0014	0.0000	lnX <sub>16</sub> <sup>-(-48)</sup>	lnX <sub>20</sub> <sup>+(-3)</sup>	lnX <sub>21</sub> <sup>-(-1)</sup>	0.1909	29
	C <sup>ww.af</sup>	0.0010	0.0900	0.0000	0.0000	0.0000	lnX <sub>16</sub> <sup>-(-48)</sup>	lnX <sub>20</sub> <sup>+(-3)</sup>	lnX <sub>21</sub> <sup>-(-1)</sup>	0.1070	29
	C <sup>ww.af</sup>	0.0029	0.0000	0.0004	0.0031	0.0031	lnX <sub>16</sub> <sup>-(-48)</sup>	lnX <sub>20</sub> <sup>+(-3)</sup>	lnX <sub>21</sub> <sup>-(-1)</sup>	0.4081	29
	C <sup>ww.as</sup>	0.0000	0.0020	0.0003	0.0041	0.0041	lnX <sub>16</sub> <sup>-(-11)</sup>	lnX <sub>20</sub> <sup>-(-14)</sup>	lnX <sub>21</sub> <sup>-(-8)</sup>	0.1701	35
	C <sup>ww.as</sup>	0.0071	0.0040	0.0061	0.0090	0.0031	lnX <sub>16</sub> <sup>-(-11)</sup>	lnX <sub>20</sub> <sup>-(-14)</sup>	lnX <sub>21</sub> <sup>-(-8)</sup>	0.1633	35
	C <sup>ww.as</sup>	0.0002	0.0004	0.0031	0.0030	0.0071	lnX <sub>16</sub> <sup>-(-11)</sup>	lnX <sub>20</sub> <sup>-(-14)</sup>	lnX <sub>21</sub> <sup>-(-8)</sup>	0.1401	35
	C <sup>ww.as</sup>	0.0034	0.0007	0.0045	0.0004	0.0001	lnX <sub>16</sub> <sup>-(-11)</sup>	lnX <sub>20</sub> <sup>-(-14)</sup>	lnX <sub>21</sub> <sup>-(-8)</sup>	0.5016	35
	C <sup>ww.la</sup>	0.0000	0.0011	0.0009	0.0005	0.0109	lnX <sub>16</sub> <sup>-(-65)</sup>	lnX <sub>20</sub> <sup>-(-7)</sup>	lnX <sub>21</sub> <sup>-(-5)</sup>	0.4907	38
	C <sup>ww.la</sup>	0.0061	0.0031	0.0000	0.0009	0.0009	lnX <sub>16</sub> <sup>-(-65)</sup>	lnX <sub>20</sub> <sup>-(-7)</sup>	lnX <sub>21</sub> <sup>-(-5)</sup>	0.3771	38
	C <sup>ww.la</sup>	0.0000	0.0008	0.0000	0.0004	0.0000	lnX <sub>16</sub> <sup>-(-65)</sup>	lnX <sub>20</sub> <sup>-(-7)</sup>	lnX <sub>21</sub> <sup>-(-5)</sup>	0.3094	38
	C <sup>ww.la</sup>	0.0000	0.0000	0.0107	0.0016	0.107	lnX <sub>16</sub> <sup>-(-65)</sup>	lnX <sub>20</sub> <sup>-(-7)</sup>	lnX <sub>21</sub> <sup>-(-5)</sup>	0.5901	38

Sample equation for estimating standard error of estimated expected value for stabilization lagoon

$$S_{\ln C_{11}^{ww.af}} = t_{.95, df} \left[ \text{Resms} \left( \frac{1}{N} + C_{16} X_{16}^2 + C_{20} X_{20}^2 + C_{21} X_{21}^2 \right) \right]^{1/2} \quad df=41$$

TABLE IV.8  
ESTIMATED COST OF WATER TREATMENT IN DEVELOPING COUNTRIES  
USING THE PREDICTIVE EQUATIONS

Type of Treatment Process	Water Demand in Gallons per Capita per Day	% Cost of Imported Water Supply Materials	Design Population	Design Capacity in MGD	Estimate of Mean Construction Cost in \$ per Capita			Estimate of Mean Operation and Maintenance Cost in \$/Capita/year		
					AFRICA	ASIA	LATIN AMERICA	AFRICA	ASIA	LATIN AMERICA
SLOW SAND FILTER	5	5	5,000	5	11.82	13.28	9.34	1.39	1.46	1.12
	25	25	30,000	5	9.57	11.13	6.59	1.23	1.28	0.85
	45	5	55,000	5	8.95	10.48	5.85	1.18	1.22	0.78
	65	45	105,000	25	8.12	9.82	5.15	1.13	1.16	0.71
	85	5	155,000	25	7.69	9.44	4.77	1.10	1.13	0.66
	105	25	180,000	25	7.62	9.31	4.64	1.08	1.10	0.65
RAPID SAND FILTER	5	5	5,000	5	19.96	23.89	27.58	4.80	11.34	4.79
	25	25	30,000	5	17.10	20.38	23.54	3.21	7.94	2.91
	45	5	55,000	5	16.23	19.25	22.32	2.81	7.04	2.45
	65	45	105,000	25	15.34	18.23	21.07	2.41	6.18	2.03
	85	5	155,000	25	14.83	17.54	20.35	2.20	5.72	1.82
	105	25	180,000	25	14.64	17.34	20.09	2.13	5.55	1.75

TABLE IV.9

## ESTIMATED COST OF WASTEWATER TREATMENT IN ASIA AND INDIA USING OU-AID AND CPHERI NAGPUR STUDIES

Type of Treatment Process	Design Population	Design Flow in MGD	% Cost of Imported Wastewater Disposal Material	Estimate of Mean Construction Cost in \$ per Capita		Estimate of Mean Operation and Maintenance Cost in \$/Capita/year	
				ASIA OU-AID Study	INDIA Nagpur Study (a)	ASIA OU-AID Study	INDIA Nagpur Study (a)
STABILIZATION LAGOON	5,000	0.15	--	3.27	2.09	0.54	0.32
	10,000	0.30	--	2.81	1.84	0.47	0.25
	50,000	1.50	--	1.99	1.29	0.35	0.17
	100,000	3.00	--	1.71	1.25	0.31	0.14
	200,000	6.00	--	1.48	1.17	0.27	0.12
AERATED LAGOON	5,000	0.15	--	4.00	2.54	1.22	0.69
	10,000	0.30	--	3.59	2.18	1.15	0.60
	50,000	1.50	--	2.79	2.00	0.98	0.48
	100,000	3.00	--	2.50	1.81	0.92	0.44
	200,000	6.00	--	2.25	1.60	0.86	0.40
ACTIVATED SLUDGE	5,000	0.15	25	10.99	--	2.92	--
	10,000	0.30	25	9.00	--	2.17	--
	50,000	1.50	25	5.65	--	1.05	--
	100,000	3.00	25	4.62	--	0.81	--
	200,000	6.00	25	3.79	--	0.61	--
TRICKLING FILTER	5,000	0.15	25	12.09	8.65	3.66	1.39
	10,000	0.30	25	9.55	8.54	2.88	1.55
	50,000	1.50	25	5.51	3.85	2.58	0.36
	100,000	3.00	25	4.33	3.51	2.29	0.70
	200,000	6.00	25	3.43	2.22	1.00	0.51

<sup>a</sup>Low Cost Waste Treatment. Nagpur, India: Central Public Health Engineering Research Institute, 1972.

which reflect the total water resources planning in the developing countries.

- (4) There is a need to develop water quality standards for developing countries.
- (5) Cost-effectiveness studies of water supply and wastewater disposal should be carried out, comparing in particular the benefits acquired from treated water and sewerage facilities to other public work sectors.
- (6) Efforts should be made to apply these models in actual planning situations.

#### SAMPLE PROBLEMS

Sample Problem 1. The City of Istanbul, Turkey, is proposing to build either stabilization lagoons for three suburbs or one activated sludge plant. Land is cheap, and due to geographical location the cost of transporting the wastewater by gravity flow is minimal.

Per capita income in the city is estimated to be 250 U.S. dollars per year. Twenty percent of the cost of wastewater disposal materials would have to be imported to construct and operate the activated sludge plant. The design population is given in Figure IV.2. A recommendation is sought for the Istanbul Planning Commissioners in terms of the mean lower cost process (three stabilization lagoons or one activated sludge plant).

#### Solution

Using equation (4-94),

Construction Cost of Stabilization Lagoon 1 --



$$\begin{aligned}
 \ell_n C'_{ww.as} &= 1.5303 - 0.2152 \ell_n X_{16} \\
 &= 1.5303 - 0.2152 \ell_n 100 \\
 &= 1.5303 - 0.9910 = 0.5393
 \end{aligned}$$

Antilog of 0.5393 = 1.71 (\$U.S./capita).

Operation and Maintenance Cost of Stabilization Lagoon 1,  
using equation (4-96) —

$$\begin{aligned}
 \ell_n C'''_{ww.as} &= -0.3274 - 0.1846 \ell_n 100 \\
 &= -0.3274 - 0.8501 \\
 &= -1.1775
 \end{aligned}$$

Antilog -1.1775 = 0.30 (\$U.S./capita/year).

Fig. IV.2. Sample Problem 1.

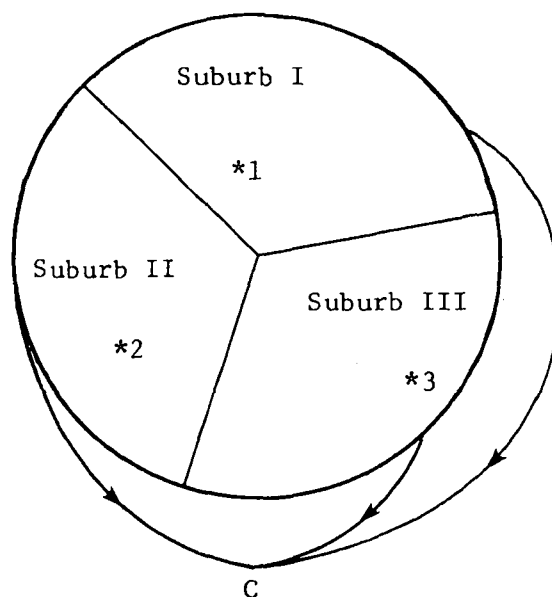

Suburb I, Population = 100,000.  
Suburb II, Population = 25,000.  
Suburb III, Population = 75,000.

\* Location of Stabilization Lagoons.

C Location of Activated Sludge Plant.

→ Transportation of Wastewater to Point C.

Construction Cost of Stabilization Lagoon 2 --

$$\begin{aligned} \ell_n C'_{ww.as} &= 1.5303 - 0.2152 \ell_n 25 \\ &= 2.31 (\$U.S./capita). \end{aligned}$$

Construction Cost of Stabilization Lagoon 3 --

$$\begin{aligned} \ell_n C'_{ww.as} &= 1.5303 - 0.2152 \ell_n 75 \\ &= 1.82 (\$U.S./capita). \end{aligned}$$

Operation and Maintenance Cost of Stabilization Lagoon 2 --

$$\begin{aligned} \ell_n C''_{ww.as} &= -0.3274 - 0.1846 \ell_n 25 \\ &= -0.3274 - 0.5942 \\ &= -0.9216 \end{aligned}$$

$$\text{Antilog } -0.9216 = 0.40 (\$U.S./capita/year).$$

Operation and Maintenance Cost of Stabilization Lagoon 3 --

$$\begin{aligned} \ell_n C''_{ww.as} &= -0.3274 - 0.1846 \ell_n 75 \\ &= -1.12 \end{aligned}$$

$$\text{Antilog } -1.12 = 0.32 (\$U.S./capita/year).$$

Using equation (4-118),

Construction Cost of Activated Sludge Plant --

$$\ell_n C'_{ww.as} = 2.8597 - 0.2890 \ell_n X_{16} + 0.0201 \ell_n X_{21}$$

(where:  $X_{16}$  is the total population of 3 suburbs and  $X_{21}$  is 20%)

$$\begin{aligned} \ell_n C'_{ww.as} &= 2.8597 - 0.2890 \ell_n (100 + 25 + 75) + 0.0201 \ell_n 20 \\ &= 2.8597 - 1.5312 + 0.0602 \\ &= 1.3887 \end{aligned}$$

$$\text{Antilog } 1.3887 = 4.01 (\$U.S./capita).$$

Using equation (4-120),

Operation and Maintenance Cost for the Activated Sludge Plant --

$$\begin{aligned}
 \ell_n C''_{\text{ww.as}} &= 1.7534 - 0.4269 \ell_n X_{16} + 0.0021 \ell_n X_{21} \\
 &= 1.7534 - 2.2618 + 0.0062 \\
 &= -0.5022
 \end{aligned}$$

Antilog  $-0.5022 = 0.60$  (\$U.S./capita/year).

Total Construction Cost for Three Stabilization Lagoons --

$$\begin{aligned}
 &= 1.71 (100,000) + 2.31 (25,000) + 1.82 (75,000) \\
 &= 171,000 + 57,750 + 136,500 = 365,250 (\$U.S.)
 \end{aligned}$$

Total O & M Cost per Year for Three Stabilization Lagoons --

$$\begin{aligned}
 &= 0.30 (100,000) + 0.40 (25,000) + 0.32 (75,000) \\
 &= 30,000 + 10,000 + 24,000 \\
 &= 64,000 (\$U.S./year).
 \end{aligned}$$

Total Construction Cost for Activated Sludge Plant --

$$\begin{aligned}
 &= 4.01 (200,000) \\
 &= 802,000 (\$U.S.)
 \end{aligned}$$

Total O & M Cost per Year for Activated Sludge Plant --

$$\begin{aligned}
 &= 0.60 (200,000) \\
 &= 120,000 (\$U.S./year).
 \end{aligned}$$

Three stabilization lagoons would be the recommendation to give to the Commissioners.

Sample Problem 2. The Governments of Kenya, Mexico, and Taiwan want to establish small towns in the interior. The projected population for each town (Kijiji Kipya, Nuevo Pueblo, and Hsin Tsein) is to be 5,000. Both water and wastewater treatment plants must be built simultaneously. Figures are needed for the mean costs of slow sand filters and aerated lagoons.

The following historical data exists for each region:

- (1) Average annual income for Kenya is 500 dollars;
- (2) average annual income for Mexico is 550 dollars;

- (3) average annual income for Taiwan is 1100 dollars.
- (4) Percentage homes connected to water supply for Mexico is approximately 40;
- (5) percentage homes connected to water supply for Taiwan is approximately 65.
- (6) Assume the design population is the same as the population of the towns.
- (7) Since there are no sewerage systems,  $X_{10}$  and  $X_{11}$  are assumed to be zero.
- (8) It is further assumed that 20% of the cost of materials for building and operation will be spent on imported items.

### Solution

Using equations (4-55) and (4-57) for water demand, the construction and operation and maintenance costs of the slow sand filter are found for each country.

$$\begin{aligned}
 \ell_n C'_{w.af} &= 2.6436 + 0.0988 \ell_n D_w - 0.20651 \ell_n X_{14} & (4-66) \\
 &= 2.6436 + 0.0988 \ell_n (12.72 + 0.0683 X_2 + 0.0142 X_6) \\
 &\quad - 0.20651 \ell_n X_{14} \\
 &= 2.6436 + 0.0988 \ell_n (12.72 + 0.0683 (5) + 0.0142 (500) ) \\
 &\quad - 0.20651 \ell_n (5) \\
 &= 2.6080
 \end{aligned}$$

Antilog 2.6080 = 13.57 (\$U.S./capita), (construction, Africa).

$$\begin{aligned}
 \ell_n C'''_{w.af} &= 0.4346 + 0.0160 \ell_n D_w - 0.3628 \ell_n X_{14} & (4-68) \\
 &= 0.4346 + 0.0160 \ell_n (1272 + 0.0683 X_2 + 0.0142 X_6) \\
 &\quad - 0.3628 \ell_n X_{14} \\
 &= 0.4346 + 0.0160 \ell_n (12.72 + 0.0683 (5) + 0.0142 (500) ) \\
 &\quad - 0.3628 \ell_n (5) \\
 &= 0.4346 + 0.0480 - 0.5838 \\
 &= -0.1012
 \end{aligned}$$

Antilog  $-0.1012 = 0.90$  (\$U.S./capita/year), (O & M, Africa).

$$\begin{aligned} \ell_n C'_{w.as} &= 2.7436 + 0.0088 \ell_n (6.6817 + 0.04597 (5) + 0.2204 (65) \\ &\quad + 0.0263 (1100) ) - 0.1065 \ell_n (5) \quad (4-70) \\ &= 2.7436 + 0.0344 - 0.1711 \\ &= 2.6069 \end{aligned}$$

Antilog  $2.6069 = 13.55$  (\$U.S./capita), (construction, Asia).

$$\begin{aligned} \ell_n C'''_{w.as} &= 0.5017 - 0.0751 \ell_n (5) \quad (4-72) \\ &= 0.3809 \end{aligned}$$

Antilog  $0.3809 = 1.46$  (\$U.S./capita/year), (O & M, Asia).

$$\begin{aligned} \ell_n C'_{w.la} &= 2.5461 + 0.0096 \ell_n (20) - 0.3628 \ell_n (5) \quad (4-74) \\ &= 2.5461 + 0.02876 - 0.5839 \\ &= 1.991 \end{aligned}$$

Antilog  $1.991 = 7.32$  (\$U.S./capita), (Construction, Latin America).

$$\begin{aligned} \ell_n C'''_{w.la} &= 0.3559 - 0.1511 \ell_n (5) \quad (4-76) \\ &= 0.1127 \end{aligned}$$

Antilog  $0.1127 = 1.12$  (\$U.S./capita/year), (O & M, Latin America).

Construction, operation and maintenance costs of aerated lagoons are found for each country.

$$\begin{aligned} \ell_n C'_{ww.af} &= 1.4768 - 0.1132 \ell_n X_{16} \quad (4-102) \\ &= 1.4758 - 0.1132 \ell_n (5) \\ &= 1.29462 \end{aligned}$$

Antilog  $1.29462 = 3.65$  (\$U.S./capita), (construction, Africa).









# Methodology for Establishing Priorities among Water Supply Programs: A Case Study

This chapter presents a methodology for setting priorities for water supply programs and represents a condensed form of material which has not been published previously. In this study analysis was made of the Indonesian Rural Water Supply Program. There were found to be three major constraints in executing that Program, namely, money, time, and manpower. The problem was to develop criteria for selecting which among the proposed projects should be executed first. Existing priority models were deemed unsuitable for application in Indonesia at the present time because of the particular program strategies and conditions prevailing, and also because of the lack of well-trained engineering personnel, especially at the levels where the selection of the project localities is made.

In this chapter a delineation is made of the relevant Indonesian administrative hierarchy, population characteristics, and the water

and sanitation situation. In the study, the following ten prioritizing parameters were established: waterborne diseases, difficulty in obtaining water, technological alternatives, population, village contribution, village potential, public places, excreta disposal, road conditions, and power supply. These are discussed in detail in this chapter.

Through the use of forms and questionnaires extensive data was obtained on particular localities in Indonesia. This data was subsequently processed, and some of the results are presented here to demonstrate utilization of the prioritizing model.

V.

A PRIORITY SETTING FOR THE RURAL  
WATER SUPPLY PROGRAM IN INDONESIA

Soetiman

## INTRODUCTION

General. This study deals with a present need of the Indonesian Rural Water Supply Program, that is, a method of setting the priority for selecting which villages should receive a water supply system first. The scope of the Indonesian Rural Water Supply Program is very broad; it covers more than 100 million Indonesian people who live in about 56,000 villages. Resources, especially money and manpower, are very limited, and there is a time limit as well. Most of the villages want to receive their water supply system first, and it was felt that a priority model was strongly needed to ensure that the government money is spent more wisely and that the people feel that the program is being implemented fairly. This study consists of four parts: an introduction, literature review, examination of methodology, and a test of the model.

Indonesian Governmental Hierarchy. The basic hierarchy is illustrated in Figure V.1. The central (federal) government consists of a president, a vice-president and about twenty-one ministers; there is no prime minister. The province (state), also called the first-level of government, is headed by a governor. There are twenty-six provinces in all of Indonesia. The kabupaten is also called the second-level of government and is headed by a bupati. There are 234

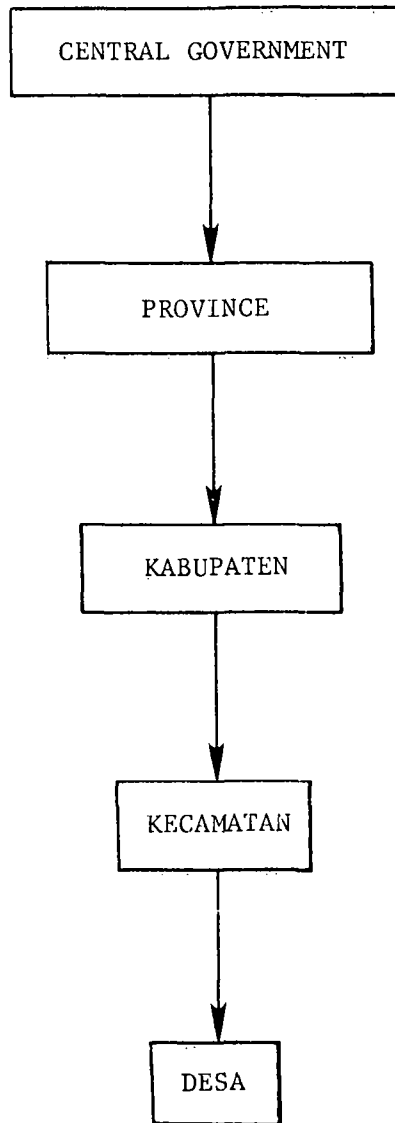

Fig. V.1. A sketch of the Indonesian Governmental Hierarchy.

kabupatens in all of Indonesia. Besides the kabupatens, there are fifty-four municipal areas each of which is headed by a city mayor. The kecamatan is headed by a camat, and there are 3,138 kecamatans in all of Indonesia. The desa (village unit) is also called the lowest-level of government headed by a lurah. Some desas consist of only one village, but some desas consist of two or more villages. There are 48,575 desas consisting of about 56,000 villages in all of Indonesia.

The names of the twenty-six provinces and the number of municipal areas, kabupatens, kecamatans and desas, together with urban and rural populations quoted from the census in 1971 are shown in Table V.1. This table indicates that the Indonesian population in 1971 was 119.2 million.

Population. At the present time, the figure for the population of Indonesia which is accepted by the Ministry of Health is approximately 151 million consisting of 122 million who live in rural areas and 29 million who live in urban areas (1). These figures indicate that more than 80 percent of the Indonesian population live in rural areas, which is a common characteristic of less developed countries in general. The present annual growth rate is 2.3 percent, and it is expected that by an intensive family planning program which is currently being implemented in the country, the annual growth rate will be reduced to 1.2 percent by 2001 (7). With respect to age groups, 44.1 percent of the population is under fifteen years of age, and only 2.5 percent is over sixty-five years (7).

TABLE V.1.  
 THE PROVINCES AND THE NUMBER OF MUNICIPAL AREAS, KABUPATEN, KECAMATANS AND DESAS  
 TOGETHER WITH URBAN AND RURAL POPULATION

Province	Municipal Areas	Kabu- patens	Keca- matans	Desas	Population x 1,000		
					Urban	Rural	Total
1. D.I. Aceh	2	8	129	601	198	1,811	2,009
2. North Sumatra	6	11	167	5,303	1,174	5,448	6,622
3. West Sumatra	6	8	80	559	480	2,313	2,793
4. Riau	1	5	67	721	218	1,423	1,641
5. Jambi	1	5	37	918	293	713	1,006
6. Bengkulu	1	3	23	71	61	458	519
7. South Sumatra	1	9	85	1,692	1,001	2,442	3,443
8. Lampung	1	3	58	1,124	274	2,503	2,777
9. D.K.I. Jakarta	5	-	27	220	4,576	-	4,576
10. West Java	4	20	387	3,927	2,686	18,946	21,632
11. Central Java	6	29	492	8,485	2,356	19,521	21,877
12. Yogyakarta	1	4	74	556	-	-	2,490
13. East Java	8	29	554	8,865	3,702	21,824	25,526
14. Bali	-	8	50	560	208	1,921	2,120

TABLE V.1.1.--Continued

Province	Municipal Areas	Kabupaten	Kecamatan	Desas	Population x 1,000		
					Urban	Rural	Total
15. West Nusa Tenggara	-	6	56	553	179	2,023	2,202
16. East Nusa Tenggara	-	12	98	1,714	129	2,165	2,294
17. West Kalimantan	1	6	106	3,584	258	1,761	2,019
18. Central Kalimantan	1	9	82	1,183	110	589	699
19. South Kalimantan	2	9	94	674	453	1,246	1,699
20. East Kalimantan	2	4	69	915	301	432	733
21. North Sulawesi	2	4	81	1,142	335	1,383	1,718
22. Central Sulawesi	-	4	61	1,149	73	840	913
23. South Sulawesi	2	21	169	1,163	941	4,248	5,189
24. South-East Sulawesi	-	4	43	394	52	662	714
25. Maluku	1	4	51	1,605	144	944	1,088
26. Irian Jaya	-	9	35	892	151	772	923
Total	54	234	3,138	48,575	20,353	96,379	119,222

SOURCE: UNICEF/WHO, Report on Rural Water Supply in Indonesia, EH/SEARO/75.1 (April 1975).

Water Situation. Indonesia is a tropical country characterized by heavy rainfall. The average rainfall for the whole country is approximately 2,000 mm (about 80 inches) per year. Unfortunately, the distribution of rainfall throughout the country is uneven; some areas get a very high rainfall, for instance, Batu Raden, Central Java, receives about 7,000 mm (about 280 inches) per year, while Palu, Central Sulawesi, receives only about 700 mm (about 28 inches) per year. The distribution of rainfall throughout the year is also uneven. During the wet months, between December and March, some areas get heavy flooding routinely which destroys property and takes lives. During the dry months, on the other hand, between July and September, some areas have no water, not even a drop to drink.

Water supply facilities are still scarce in most parts of Indonesia, particularly in rural areas. Before the Indonesian Government ran the First Five-Year Development Plan, April 1, 1969, to March 31, 1974, fewer than twenty percent of the urban population had been served by piped water systems from the Municipal Drinking Water Services, and only about one percent of the rural population had had reasonable access to safe water. By the end of the First Five-Year Development Plan, approximately twenty-five percent of the urban population was served by piped water systems, and about 1.6 percent of the rural population had reasonable access to safe water. Today, about forty-five percent of the urban population is served by piped water systems, and about 5.4 percent of the rural population.

The majority of Indonesian people depend on unsafe water from wells, rivers, irrigation canals, ponds, lakes, unprotected springs and rainwater collections which are subject to pollution. On certain



islands and coastal areas where potable water is not available, water has to be brought by boats or trucks from nearby producers of safe water. Villages in the mountainous areas use bamboo pipes to carry water from natural springs, where the major portion of the water leaks on the way and only a very small portion reaches the villages due to the very long distances traveled.

The situation is drastic during the dry season, the period from July to September, when wells, rivers, irrigation canals and ponds run dry and the villagers have to travel a few kilometers or even more than seven kilometers to get a bucket of water from the big rivers or springs. Women and children are responsible for getting the water, while men go to work to earn a living. They often spend all day in this task; therefore, many children do not go to school and lose their opportunity for the education which is provided by the government. Also, women lose valuable time that could be devoted to economic activities and educating their children.

Excreta Disposal. At present, not more than five percent of the Indonesian rural population have or use facilities for safe disposal of excreta (10). Most of the rural population dispose of their human waste through rivers, irrigation canals, ponds, farms or backyards. which creates the major source of pollution in rural areas. This condition is, of course, very dangerous to public health and aesthetically unpleasant.

In the First Five-Year Development Plan, the Provincial and Kabupaten Health Offices initiated the introduction of the simplest method for safe excreta disposal by means of latrines that consist of just a plain hole covered by a concrete slab with a water seal.

Now latrines, as excreta disposal facilities, are one of the most important items in the INPRES (Presidential Instruction) Program in Health Improvement and the Rural Water Supply and Sanitation Programs.

Public Health. Public health conditions in Indonesia, especially in rural areas, are very bad due to a lack of safe water and excreta disposal facilities as discussed previously. This causes many water-borne diseases (diseases which are transmitted through water), particularly cholera, which takes many lives. Cholera is said to be endemic to Indonesia, that is, it is a disease which occurs every year and spreads from one place to another, especially during the dry season when water is extremely difficult to find or during the wet season after heavy flooding. The World Health Organization Regional Office for South East Asia (13) reported that there were numerous cholera cases in Indonesia: 6,525 in 1970, 23,555 in 1971, and 43,423 in 1972 with the deaths of 1,379, 3,335 and 6,863 people, respectively; this indicates a marked increase within a two-year period. Children under six years of age are prone to cholera and other waterborne diseases such as gastro-enteric diseases and typhoid.

Other diseases which are also considered waterborne and are often contracted are trachoma and skin diseases. Malaria is a water-related disease (a disease where a necessary part of the life cycle of the infecting agent takes place in aquatic animals). Finally, other diseases which are related to poor sanitation are hookworm infestation (ancylostomiasis), and infestation of roundworms (trichuriasis and ascariasis).

Indonesian Rural Water Supply Program. The Indonesian Rural Water Supply Program began in the first year of the First Five-Year Development Plan, April 1, 1969, but only as a "Pilot Project." At

the end of the First Five-Year Development Plan, March 31, 1974, the Rural Water Supply Program had served only 721,250 people or about 0.6 percent of the total rural population. On April 1, 1974, the beginning of the Second Five-Year Development Plan, this Indonesian Rural Water Supply Program was integrated with the INPRES Program in Rural Development, and was subsequently called the INPRES Program in Rural Water Supply.

Since the Indonesian Rural Water Supply Program has been financed by INPRES funds, remarkable progress has been achieved; within three years, 1974 to 1977, it was serving about 5.7 million people or about 4.7 percent of the total Indonesian rural population. The target of the INPRES Program in Rural Water Supply is to supply safe water to ten percent of the Indonesian rural population by the end of the Second Five-Year Development Plan (March 31, 1979) with a water consumption rate of sixty liters per capita per day using public taps (hydrants) as a distribution system. Comparison can be made between the designed water consumption rate of the Indonesian Rural Water Supply Program and the World Health Organization data for average daily consumption in rural areas, presented in Table V.2.

In implementing the Rural Water Supply Program, the Indonesian Government is receiving assistance from the World Health Organization (WHO) in terms of experts in planning and supervision; from United Nations Children's Fund (UNICEF) in terms of materials and equipment such as pipes, fittings, water pumps, pre-fabricated steel water tanks, and survey and drilling tools; and from United Nations Development Program (UNDP) and United States Agency for International Devel-

TABLE V.2  
 AVERAGE DAILY WATER CONSUMPTION IN RURAL AREAS

Region	Liters per Capita per Day	
	Minimum	Maximum
Africa	15	35
Southeast Asia	30	70
Western Pacific	30	95
Eastern Mediterranean	40	85
Europe (Algeria, Morocco, Turkey)	20	65
Latin America and the Caribbean	70	190
World Average	35	90

SOURCE: World Bank, "Village Water Supply," March 1976, p. 33.

opment (USAID) in terms of manpower development such as the upgrading of health controllers, sanitarians and assistant sanitarians. The progress of the Indonesian Rural Water Supply Program by funds, by population served, and by systems are presented in Tables V.3, V.4, and V.5, respectively.

The administrative steps in initiating and developing Indonesian Rural Water Supply Project proposals is illustrated in Figure V.2 and described by the following steps:

1. The community complains.
2. The Health Center Officer discusses this complaint with the Camat.
3. The sanitarian from the Health Center explores the complaint.
4. The Health Center Officer reports to the Hygiene and Sanitation (HS) Section at the Kabupaten Level.
5. HS personnel and the Kecamatan sanitarian go to the area of the complaint.
6. The HS Section Officer reports the information collected from the area to the Bupati.
7. The Bupati sends an agreement of need to the HS Section.
8. The HS Section Officer proposes the need for a safe water system to the Sub-Directorate of HS Provincial Level.
9. The HS Section Officer approaches the Bupati for his support in construction and maintenance costs.
10. The Bupati instructs the Camat and Lurah to approach the community for a contribution to construction and maintenance costs.
11. The staff of the HS Sub-Directorate visits the area to review the preliminary proposal.
12. The staff of the HS Sub-Directorate discusses the revised preliminary proposal with the Governor to get a financial contribution from the provincial level.
13. The proposal is sent to the HS Directorate for approval.

TABLE V.3  
PROGRESS REPORT BY FUNDS,  
RURAL WATER SUPPLY PROGRAM

Time Period	Amount (Million \$U.S.)
1969 - 1974	1.70
1974 - 1975	6.35
1975 - 1976	10.79
1976 - 1977	14.88
Total	29.62

SOURCE: Communication with Indonesian Ministry of Health, Directorate General of Communicable Diseases, Directorate of Hygiene and Sanitation, Jakarta, Indonesia.

TABLE V.4  
 PROGRESS REPORT BY POPULATION SERVED,  
 RURAL WATER SUPPLY PROGRAM

Time Period	Population Served	Percentage of Total Rural Population
1969 - 1970	78,700	0.077
1970 - 1971	28,500	0.027
1971 - 1972	82,850	0.077
1972 - 1973	242,950	0.219
1973 - 1974	287,800	0.253
1974 - 1975	1,452,982	1.247
1975 - 1976	2,130,400	1.785
1976 - 1977	2,107,500	1.724
Total	6,411,582	5.409

SOURCE: Communication with Indonesian Ministry of Health, Directorate General of Communicable Diseases, Directorate of Hygiene and Sanitation, Jakarta, Indonesia.

TABLE V.5  
 PROGRESS REPORT BY SYSTEMS  
 RURAL WATER SUPPLY PROGRAM

Time Period	Piped Systems	Rain Water Collections	Spring Protections	Artesian Wells	Hand Pumps
1969 - 1970	3	0	1	0	0
1970 - 1971	5	0	1	0	0
1971 - 1972	14	0	0	1	0
1972 - 1973	35	0	7	0	0
1973 - 1974	51	0	15	16	3
1974 - 1975	96	163	81	33	10,127
1975 - 1976	146	445	180	50	14,199
1976 - 1977	150	500	150	25	14,175
Total	500	1,108	435	125	38,504

SOURCE: Communication with Indonesian Ministry of Health, Directorate General of Communicable Diseases, Directorate of Hygiene and Sanitation, Jakarta, Indonesia.



Fig. V.2. Administrative procedure for Indonesian Rural Water Supply Project proposals.

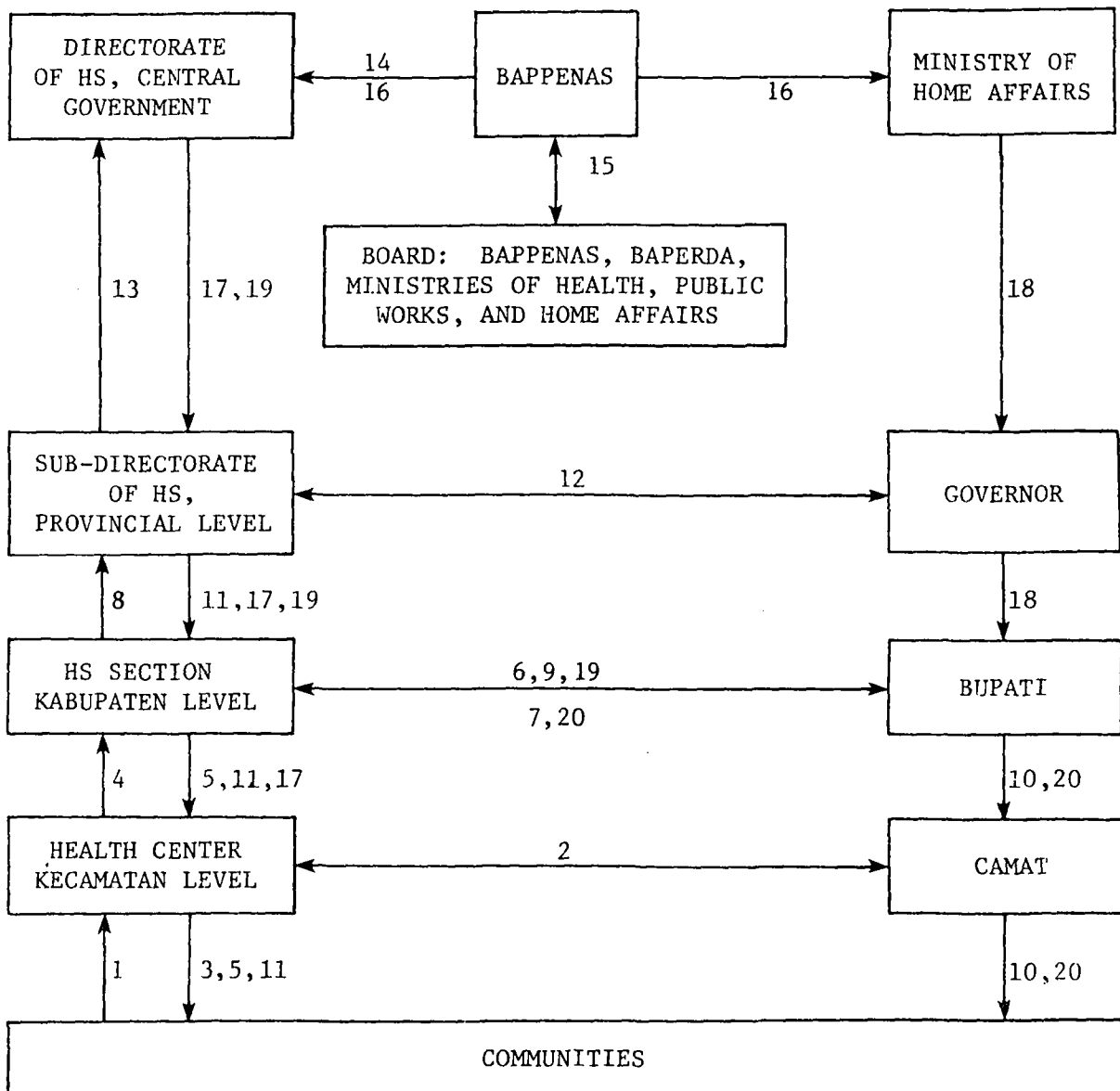

SOURCE: Communication with Indonesian Ministry of Health, Directorate General of Communicable Diseases, Directorate of Hygiene and Sanitation, Jakarta, Indonesia.

14. The HS Directorate formulates a program and refers it to the National Development Planning Board (BAPPENAS).
15. BAPPENAS discusses the program with a board consisting of representatives of BAPPENAS, the Provincial Development Planning Board (BAPERDA), and the Ministries of Health, Public Works, and Home Affairs. This board determines a ceiling budget to be provided for rural water supply projects.
16. BAPPENAS sends the final decision of the ceiling budget to the HS Directorate through the Ministry of Health, and to the Ministry of Home Affairs.
17. Based on the ceiling budget, the HS Directorate makes the final decision about the projects which are found to be urgent and notifies the HS Section at Kabupaten Level through the HS Sub-Directorate.
18. At the same time, the Ministry of Home Affairs notifies the Bupati through the Governor about the final decision on the ceiling budget.
19. The HS Directorate sends standard designs of selected systems to the Bupati through the HS Section.
20. The Bupati, as project manager, forms a tender committee consisting of technical and administrative officials from the Kabupaten Public Works, the HS Section, The HS Sub-Directorate and, for systems using artesian wells, the Directorate of Geology, and the Ministry of Mining. Based on the evaluation of the tender committee, the Bupati assigns a selected contractor and notifies the Camat and Lurah for their support in implementing the projects.

There are two ministries that are responsible for the implementation of the Indonesian Rural Water Supply Program: the Ministry of Health through the Directorate of Hygiene and Sanitation, which is responsible for technical problems such as surveys, designs and supervision of the construction as well as the operation and maintenance; and the Ministry of Home Affairs through the Bupati, who is responsible for administrative and financial problems such as the selection of project localities and collection of funds from INPRES, province, and local resources.

Constraints. There are three major constraints in executing the Indonesian Rural Water Supply Program, namely, money, time and manpower. It was estimated in 1973 by the Project System Analysis Group of WHO experts from taking samples in West Java Province, that based on the water consumption rate of sixty liters per capita per day with a public tap distribution system, average construction cost would be U.S.\$8 per capita, ranging from U.S.\$3 to U.S.\$30 depending on the type of system to be installed. This figure is more realistic than the U.S.\$4 assumed in the Second United Nations Development Decade (12). Assuming that this figure does not change, the Indonesian Rural Water Supply Program, which is to serve a projected population of about 131 million people by 1980, will need at least U.S.\$1 billion. This is a substantial amount of money for the Indonesian Government at present, because many other projects are being implemented simultaneously under the Second Five-Year Development Plan.

The Indonesian Rural Water Supply Program consists of short-term and long-term targets. The short-term target is to supply ten percent of the Indonesian rural population, or about 13 million people, with safe water systems by the end of the Second Five-Year Development Plan, March 31, 1979 (6). The long-term target is to supply all of the Indonesian rural population with safe water systems.

Concerning the short-term target, the Indonesian Government would have to serve about 5.5 million people within two fiscal years, 1977-1978 and 1978-1979; this requires a total of about U.S.\$44 million or U.S.\$22 million each fiscal year, a difficult undertaking. With regard to the long-term target, an investment of about U.S.\$1 billion is needed. In the fiscal year 1976-1977, the Indonesian

Government spent U.S.\$14.88 million. Assuming that the Indonesian Government will spend at least the same amount for each successive year, it would take about seventy years to supply the projected rural population of 131 million with safe water systems; but during this period of time, the population would at least double. Therefore, it is difficult to predict how much time would be needed to implement the Indonesian Rural Water Supply Program.

However, since the Indonesian Government is now running a national development program across the country with emphasis on rural areas, progress in the economic growth of rural areas, as well as in the nation, will enable the investment of a greater amount of money in rural water supply projects. As village incomes increase and a better level of education is attained, the villagers will perceive the need for a safe water system, and they will contribute a greater portion of the cost of installation of a safe water system or even finance such an installation themselves. Nevertheless, the Indonesian Rural Water Supply Program will take some decades to complete.

The scope of the Indonesian Rural Water Supply Program is broad. It requires a lot of money and a large number of competent personnel, appropriately organized for planning, design, execution, supervision, operation, maintenance and the development of the rural water supply systems.

In 1975 (10), at the Central Directorate of Hygiene and Sanitation, there were fifteen health controllers and thirteen sanitarians. There is a sanitary engineer in each of the two Departments of Communicable Diseases in the Central and East Java Provinces.

In all, thirty-two health controllers and fifty-four sanitarians are engaged in rural water supply schemes in the twenty-six Provincial Offices. For the 234 Kabupatens there are thirty-three health controllers and 198 sanitarians in the Health Offices who are engaged in rural water supply and sanitation programs. A staff of seventeen health controllers, 169 sanitarians and 368 assistant sanitarians is engaged in rural water supply and sanitation programs in some of the 3,138 Kecamatans.

These personnel figures are far below the needs of the water supply program and most of the personnel do not have sufficient background in engineering. A UNICEF/WHO Group (10) reported that the absence of trained engineering staff at the national, provincial and kabupaten levels is a serious drawback to the water supply program. However, it must be kept in mind that at present, it is very difficult to find an engineer who is willing to work on rural water supply projects because the production of engineers by universities in Indonesia, particularly sanitary engineers, is very low, while the demand is high, especially from private firms which offer better conditions and higher salaries.

On the other hand, there is not much interest in construction of rural water supply projects by large and experienced contracting firms because the expected profit is not attractive to them and because some sub-projects are located in very remote areas, especially projects using spring protections with piped system, and they are quite difficult to reach. Therefore, only the small and unexperienced contracting firms are willing to work on rural water supply projects; consequently, the use of small contracting firms will require more

qualified and experienced supervising teams, something which is very difficult to find at this time.

Probably the best way to deal with this complex situation is to install the simplest systems first, such as dug wells or tube wells with handpumps, rainwater collection systems, and simple spring protections without piped systems which do not require sophisticated engineering designs, careful supervision or skilled operators; otherwise, the program will never be implemented. This should be accompanied by an extensive training of engineering staff, supervising teams, operation and maintenance personnel, as is presently being conducted and planned by the Ministry of Health with the cooperation and assistance of some engineering institutions and international agencies such as WHO, UNICEF, UNDP and USAID.

#### LITERATURE REVIEW

Village Need, Village Potential and System Costs. A World Bank Paper (12) discussed general criteria for selecting the individual sub-projects to be executed first, based on village need, village potential, and system costs, since it is impossible to make rigorous cost/benefit analysis of the effects of village water supply programs. Village need is broken down into three components: village interest; adequacy of existing supply in terms of quantity, convenience, reliability during drought, and quality; and prevalence of waterborne diseases. Village Potential includes the growth potential of the community and village institutions. A lack of adequate water supplies may prevent the development of the village's economic potential, for example, markets, food or fish processing centers,

and local health or education centers. The villages may also be unable to obtain sufficient water for productive non-domestic use, for example, agriculture, livestock, vegetable cultivation, preparation of produce for market, or cottage industries such as cloth dyeing. With respect to village institutions, it was stated that villages with strong, competent institutions and good educational levels would be more able to participate in drawing up a program, to collect water charges, and to find operating and maintenance staffs from among the villagers than villages where such conditions do not exist.

The objective of system costs is to ensure the least-cost means of providing the required service. Factors affecting this objective are: population distribution, the nature of the water source and its accessibility. With respect to population distribution, it was mentioned that other things being equal, the larger, more densely populated villages will need lower investment costs per capita. One system for a group of villages that are close together may be lower in capital cost and more economical to operate and administer than those for scattered villages. With respect to accessibility, it was stated that a system for villages without good roads will be difficult and expensive to construct and maintain.

Economics and Policy. Saunders and Warford (8) described criteria based on economics and governmental policy which are normally used to determine investment priorities in rural water supplies in less developed countries. This question was examined under the following headings: Costs, Economies of Scale, and Service Quality; Growth Point Strategies; Income Redistribution and "Worst First"

Strategies; Financial Viability and Community Enthusiasm; and Maximum Number Served per Fixed Resources. In practice, of course, political considerations or response to the most vociferous demands for service are often major determinants of who will receive water first.

Saunders and Warford assume that generally there are economies of large-scale production in the provision of water supplies. If this assumption is valid and if the objective of the rural water supply program is to serve the most people at the least cost, this criterion would lead to construction of the water supply systems in the largest villages first. Eligible villages could simply be ranked by population size and then be provided with water supplies in turn as resources become available. Regarding service quality, it was stated that two of the more important factors are transmission costs and source works. For example, distribution through public hydrants is more economical than through house connections, and use of dug wells with handpumps is more economical than river treatment facilities.

In considering growth point strategies, it was stated by Saunders and Warford that economic growth and development does not take place at the same rate in all localities; at any point in time, some areas are growing rapidly, some areas are stagnant, and some others are declining. One suggestion for helping the rural population is to stem the out-flow of people in rural areas so that they can more effectively compete with the better established urban areas. Once a potential growth point has been selected, government investment in educational facilities, roads, market places, and sanitary facilities including water supplies is necessary. The objective of the investment is to create centers which will hold populations and



attract and hold economic activities. While a safe water supply may be necessary for development, it is not sufficient in itself to induce development. Therefore, if economic development is an objective, then the limited water supply investment must be directed into selected high potential areas or region with a relatively concentrated population, and it should be accompanied by complementary investment in other public services.

For income redistribution and "worst first" strategies it was stated by Saunders and Warford that the goal of redistributing income from higher to lower groups could also be a consideration when selecting which villages should have a high priority for receiving a water supply system. Any investment emphasis on rural areas will on an overall basis result in a high to low income redistribution since rural populations are generally poorer than urban populations and since the major portion of national revenue comes from the higher income urban areas. In Thailand villages are ranked according to their need for water and those villages with most need are given the highest priority. At present, the Indonesian Rural Water Supply Program (5) is close to this strategy since the highest priority is given to "critical areas" where water is extremely difficult to find and a high cholera incidence is present, although village contributions are expected.

In discussing financial viability and community enthusiasm, it was stated by Saunders and Warford that a financial viability condition is probably not consistent with a worst-first strategy. On the other hand, it could be consistent with a growth point or growth area strategy, and if the national government partially subsidizes

the program there would still be a redistribution of income in the country. It is also frequently noted in rural water supply literature that the probability of project failure is much greater in cases where the recipient village is not outwardly enthusiastic about the project. No matter how badly a village needs a better water supply system, if the population does not perceive the need for or value of the system, the usage rate will be low, system maintenance and local administration will be inadequate, and vandalism could be a problem.

Finally, it was stated that another strategy for selecting villages would be to choose villages which can be served most economically. This would essentially be an attempt to serve the maximum number of either villages or people with a given amount of financial resources. The Pan American Health Organization (PAHO) formula which will be discussed later in this chapter, has a selection bias which fits well under this strategy. Generally, while there is nothing wrong with a strategy of minimizing costs and maximizing the number of localities served; many countries, given their objectives, would probably be better off constraining such a strategy to include some considerations of financial viability, growth points and/or enthusiasm.

Criteria Adopted by Countries for Assigning Priorities. Pineo and Subrahmanyam (2) presented seven criteria adopted by countries for assigning priorities in providing new community water supplies. Those are shown in Table V.6. Population was the most often mentioned factor, followed by scarcity, development, health, social reasons, community demand, and cost, in that order.

TABLE V.6  
 FREQUENCY OF MENTION OF  
 CRITERIA ADOPTED BY COUNTRIES FOR ASSIGNING PRIORITY  
 IN PROVIDING NEW COMMUNITY WATER SUPPLY

	Scarcity	Population Size, Density	Health	Development	Social Reasons	Cost	Community Demand
Africa South of the Sahara	9	10	4	9	6	3	2
Latin America and the Caribbean	2	11	3	6	6	4	8
West Asia and Northeast Africa	1	0	0	0	0	0	0
Algeria and Morocco	8	4	6	3	4	1	4
Southeast Asia	2	1	5	2	0	1	3
East Asia and Western Pacific	1	4	3	3	2	0	1
Total	23	30	21	23	18	9	18

SOURCE: Pineo, C. S. and Subrahmanyam, D. V. Community Water Supply and Excreta Disposal Situation in Developing Countries, A Commentary. Offset publication no. 15. Geneva: World Health Organization, 1975.

Priority Models. Linear programming (3), the pragmatic approach (3), the PAHO formula (8), and the Reid and Discenza Model (4) will be discussed as approaches to priority modeling.

The linear programming approach was developed by the PSA Group of WHO experts (3) in 1973 for assigning priority for the rural water supply program in the West Java Province, Indonesia. In mathematical terms, this formula is expressed as follows:

Maximize  $U_d \cdot P_c \cdot W_{ms}$ ,

subject to:

$$1. E(B) = p(fi) \cdot FI + p(di) \cdot DI$$

$$2. E(T) = 1/n \sum_{i=1..} p(ta)_i \cdot CC_i$$

$$3. E(M) = p(m_c) \cdot L_c + p(m_{om}) \cdot L_{om}$$

$$4. W_d \neq W_i$$

$$5. E(P) = \prod_{i=1,2,3} p(p)_i \cdot OC$$

where:  $U_d$  = the fraction of the population covered with drinking water of minimum standard, who utilize the water,

$P_c$  = population coverage,

$W_{ms}$  = water of minimum standard quality for health care (liters/capita/day),

$E(B)$  = expected budget,

$p(fi)$  = the probability of foreign investment,

$FI$  = the level of foreign investment,

$p(di)$  = the probability of domestic investment,

$DI$  = the level of domestic investment,

$E(T)$  = expected technology cost,

$p(ta)_i$  = the probability of the i-th technological alternative based on the hydrological and hydrogeological conditions in the area under consideration,

- $CC_i$  = the construction or capital costs for the  $i$ -th alternative,  
 $n$  = number of technological alternatives,  
 $E(M)$  = expected manpower availability cost,  
 $p(m_c)$  = the probability of manpower or availability of manpower for construction,  
 $p(m_{om})$  = the probability of manpower for operation and maintenance,  
 $L_c$  = labor cost for construction,  
 $L_{om}$  = labor cost for operation and maintenance,  
 $W_d$  = water for drinking purposes,  
 $W_i$  = water for irrigation purposes,  
 $E(P)$  = expected population, health, and socio-economic development problems cost,  
 $p(p)_i$  = probability of population ( $i=1$ ), health ( $i=2$ ) and socio-economic development ( $i=3$ ) problems as a result of a lack of safe water supply,  
 $OC$  = the opportunity cost of these problems.

The pragmatic approach was also developed by the PSA Group (3) as an alternative model for the linear programming approach which was described above. The basic characteristic of this method is a systematic integration of hydrological, hydrogeological, technological, demographic, health and socio-economic information for the definition of a water supply problem and subsequent setting of objectives for a water supply action program. The quantification of most of the above variables follows an iterative process consisting of the following 12 steps:

1. Determine from a review of the water situation, hydrological and hydrogeological information, and the technology analysis, the technological alternatives for construction of a new system and/or rehabilitation of the existing water supply system per area.

2. Determine from a review of the manpower constraints, the probability of community contribution for maintenance of the water supply systems per area.
3. Rank order (as a result of steps 1 and 2) the areas on the basis of highest alternatives for construction and/or rehabilitation and highest probability for maintenance of the water supply systems.
4. Select relevant demographic dimensions, for instance, projected population and population density, for water supply systems and indicate these demographic factors per area.
5. Rank order (as a result of step 4) the areas on the basis of the highest demographic dimensions.
6. Select relevant health dimensions (for instance, incidence, prevalence, and case fatality ratio) for selected health problems which relate to water supplies. Indicate per area the level of these health dimensions for the selected health problems.
7. Rank order (as a result of step 6) the areas on the basis of highest probability of health problems.
8. Determine from a review of on-going and planned socio-economic development in the country, province or district, the growth potential of selected socio-economic sectors.
9. Rank order (on the basis of step 8) the areas on the basis of lowest development potential.
10. On the basis of the rankings provided by steps 3, 5, 7 and 9, the areas can next be rank ordered such that the result shows in descending order:
  - the areas with lower technological alternatives for construction and probability of maintenance of water supply systems,
  - the areas with lower probability of population problems related to water supplies,
  - the areas with lower probability of health problems related to water supplies,
  - the areas with lower probability of socio-economic development potential.
11. From a review of the manpower and financial resources, an attempt should be made to indicate the level of existing available resources per area. In addition, a number of alternative financing levels should be generated where each alternative shows the level of foreign and domestic investment for the water supply project.

12. This step allows for objective setting within the range of the remaining possibilities. This range has been narrowed by step 1, the technological alternatives, and step 10 which integrated demographic, health and socio-economic information for determination of priority areas. Given the highest ranked priority area in step 10, an objective (in terms of population coverage with water of minimum standard) can be set by selecting among the technological alternatives for this area (step 3) on the basis of maximum utilization of existing manpower and local financial resources and minimum requirement for foreign investment (step 11). Next, objectives can be set for the second, third, and the rest of the priority areas. After setting objectives for all areas on the basis of one combination of levels of foreign and domestic investment, the process could be repeated for other alternative combinations of investment levels.

The PAHO formula is called a priority index formula developed (8) in Mexico and which is expressed in mathematical terms as follows:

$$I = 100 \frac{P}{C - A} r k$$

- where: I = an index of project selection priority in which a higher value of (I) indicates a higher priority for early water supply system installation,
- $\frac{P}{C - A}$  = the inverse of the cost per capita of the system, excluding the distribution network costs (or cost of public faucets); (C) is the total cost less household connections, if any, and (A) is the counterpart contribution supplied by the community,
- r = an index of the physical availability of water derived as a ratio between the existing water flow at the point of capture and the requirement foreseen in the 20th year of operation of the system,
- k = an index of the concentration of houses in the community to be served, measured as that proportion of the total number located within fifty meters of the proposed main conduit.

The Reid and Discenza model was intended to select the compatible water and wastewater treatment processes (4); however, this model is flexible and can be also used with a slight modification in raw data inputs and data processing, for assigning priority for rural

water supply and urban water supply as well. This model is discussed in Chapter III.

#### METHODOLOGY

The priority models presented are not suitable for the Indonesian Rural Water Supply Program at the present time because of different strategies, rural conditions and characteristics, and the lack of well-trained engineering personnel, especially at the Kabupaten levels where the selection of the project localities is made. The linear programming model is very sophisticated because every constraint requires a separate analysis. It also requires that the personnel involved have a background in economics, mathematical statistics, demography and engineering. Such personnel, however, are not available at the Kabupaten level at this time. The pragmatic approach requires the same background for its personnel as does the linear programming approach, and there is no basic formula for ranking every variable; it requires practical experience and to some extent personal judgment. The priority index formula is much simpler and more realistic than the previous two; every variable is easy to quantify. It fits the strategies of Economies of Scale and Financial Viability introduced by Saunders and Warford. However, this model does not fit the Indonesian Rural Water Supply Program strategies which are closer to Income Redistribution and "Worst First" Strategies. This model implies that the communities with the larger population, the higher village contributions, the higher house density and abundance of water sources receive the safe water system first; it reflects the "Best First" Strategies because, in general, a larger



population indicates better economic development, better educational levels and better sanitation conditions in the community. In other words, this type of community does not need very much help. The Reid and Discenza model is not suitable for the rural water supply program in Indonesia at this time because some of the inputs of socio-technological factors and indigenous resources are not yet available in the rural areas in Indonesia. However, this model inspired the author to develop a suitable model for a priority setting of the Indonesian Rural Water Supply Program. Although the model developed in this study is different from the Reid and Discenza model, the process of utilization is similar.

Model Development. The objective of this study is to develop a priority model suitable for the Indonesian Rural Water Supply Program at this time, taking into consideration the strategy of the Indonesian Rural Water Supply Program, the Indonesian rural conditions and characteristics, the qualifications of the personnel at the Kabupaten Offices who are to use the proposed developed model, and the practical experience of the author.

Based on the above criteria, the model developed in this study will be very simple and unique as illustrated in Figure V.3. It is a matrix system and in mathematical terms is expressed as follows:

$$PI_j = \sum_{i=1}^{10} W_i \cdot S_{ij}$$

where: PI = Priority Index

W = weight of each parameter

S = score of each parameter in each village

i = a subscript denoting the i-th parameter

j = a subscript denoting the j-th village.

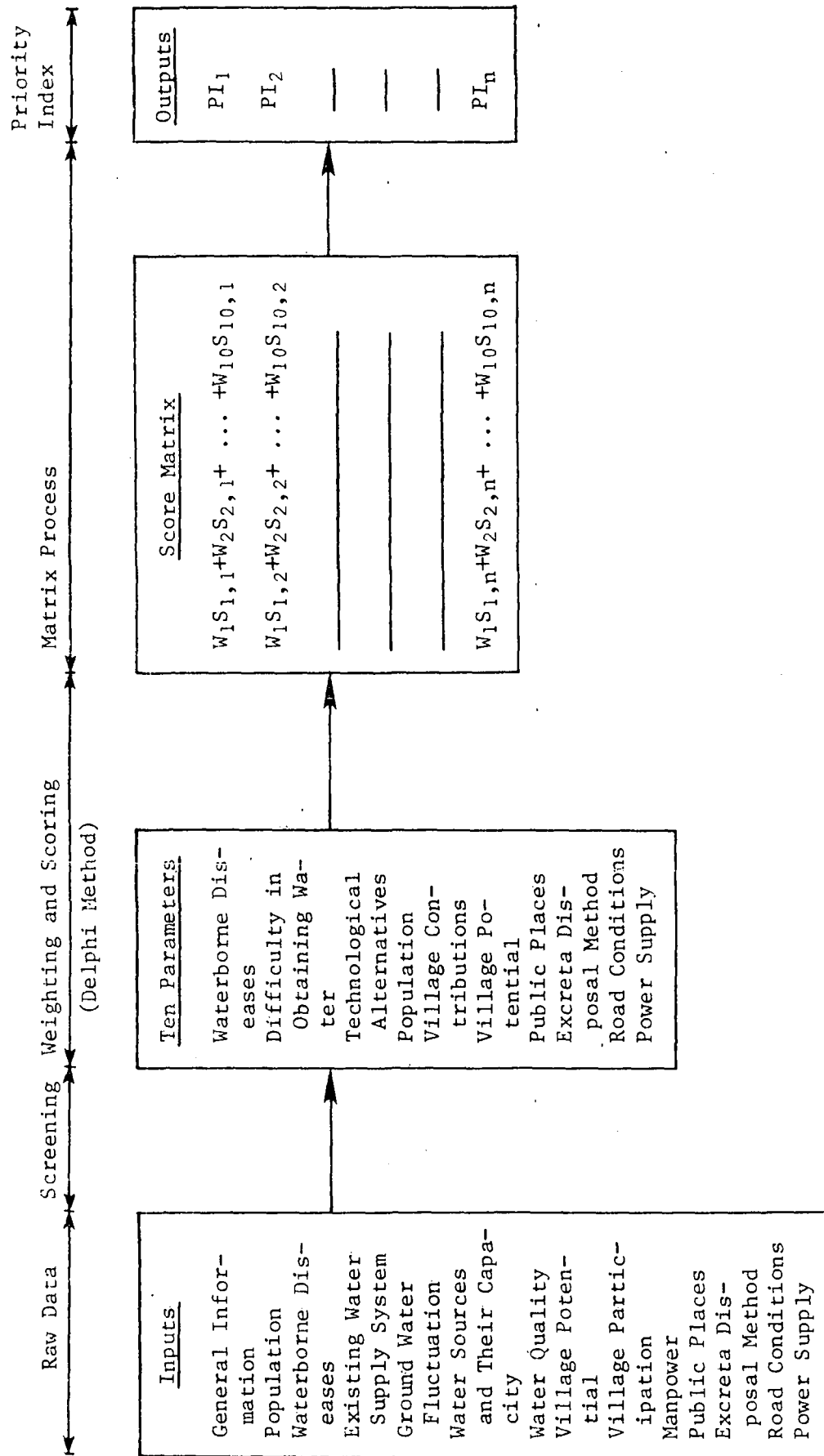

Fig. V.3. A Flow Diagram of Priority Setting Model for the Indonesian Rural Water Supply Program.

The villages represent matrix rows and the parameters represent matrix columns. The entries consist of the product of weight times score of each parameter, that is  $W_i \cdot S_{ij}$ .

The parameters consist of the following ten elements: water-borne diseases, difficulty in obtaining water, technological alternatives, population, village contribution, village potential, public places, excreta disposal, road conditions, and power supply. Selection of the ten parameters was based on the strategy of the Indonesian Rural Water Supply Program, their relevance to the program, suitability to the Indonesian rural conditions and characteristics, and feasibility in applying them to the data available. Six of these ten parameters are the same as the criteria adopted by countries for assigning priority in providing new community water supplies presented in Table IV.6. Following is a discussion of the relevance of each parameter to the above mentioned criteria.

(Waterborne Diseases.) It was expressed in the INPRES Program (5) that the provision of safe water systems per province was based on the following considerations:

- a. the incidence of cholera and other waterborne diseases such as typhoid, trachoma, and gastroenteric and skin diseases,
- b. the areas which have difficulty in obtaining water,
- c. the availability of Directorate of Hygiene and Sanitation personnel,
- d. the availability of data from presurveys.

Because water plays an important role in transmitting diseases, this parameter should be given the highest weight.

(Difficulty in Obtaining Water.) This parameter was also mentioned in the INPRES Program as expressed above. During the dry

season, in some areas water is extremely difficult to obtain; the villagers have to travel a few kilometers, and in some places more than seven kilometers, to get a bucket of water. Also, they must often climb or descend to get to the water source.

(Technological Alternatives.) The type of water technology to be installed will be based on the availability of water sources and the capability of the community to operate and maintain the system. The concern of this parameter is to choose the simplest and most economical systems, such as dug or tube wells with handpumps, spring protection without piped systems, free-flowing artesian wells, and if there is no other water source in the area, rainwater collections.

(Population.) This parameter is associated with the economy of the project as described by Saunders and Warford who assumed that there are economies of large production scale in the provision of water supplies. More important in this respect is whether the population is nucleated or dispersed. In this model as in Table V.6, population receives a high weight.

(Village Contributions.) This parameter reflects village interest and involvement in the water supply program. The best evidence of such interest is village willingness to contribute to construction costs and to pay an adequate fee for water use in order to operate and maintain the system that is to be installed. Village contributions include money, labor and local materials. This parameter also reflects the sense of community responsibility for the system.

(Public Places.) Public places include health centers, schools, markets, Desa institution buildings, and religious centers such as mosques, churches, and temples. These public places play an important role in spreading or controlling waterborne diseases, and health centers and schools in particular play an important role in teaching people about personal hygiene, grooming and how to appreciate safe water systems.

The PSA Group (3) reported that men tend to get cholera first and then transmit it to their families. The reason is that men often travel to other villages to visit public places to do business, while most women stay at home preparing meals and taking care of their children. Therefore, in planning a rural water supply, public places must be taken into consideration; for instance, public taps (hydrants) should be located near public places, or preferably on the grounds of public places.

In the event that there is not sufficient water to supply the community, public places are served first in Indonesia, since these places accommodate many people; this reflects the characteristics of the Indonesian people who are cooperative and willing to work together.

(Excreta Disposal Method.) To improve the public health conditions in rural areas, along with the water supply program, the Indonesian Government is also running a program to provide one latrine for every house. If many houses in the community have latrines or other sanitary excreta disposal facilities, it will reduce the number of latrines to be built in the community, and the budget for latrines

could be applied later to the water supply project. This will increase the number of project localities.

(Road Conditions.) If there is an accessible road to the community, it will be helpful in the transportation of equipment and materials during construction and later maintenance as well, particularly for systems using artesian wells and surface water treatments, where construction requires drilling rigs, concrete mixers, water pumps, pipes, and prefabricated steel water tanks. An accessible road, therefore, will reduce the construction cost and save time.

(Power Supply.) Some systems such as non-free flowing artesian wells, surface water treatments and spring protections with low elevation require motorized pumps; therefore, the availability of electric power will be very helpful because it will reduce the costs of operation and maintenance. An electric pump is easier to operate and maintain than a diesel pump.

Weighting Process. The Delphi method is used in this study as the weighting process. It has been developed extensively by Olaf Helmer (1966) and others at the RAND Corporation (11). In this method, experts form a panel and then deal with a specific question. Rather than meeting physically to debate the question however, these experts, the panel members, are kept apart so that their judgment will not be influenced by social pressure or by other aspects of small group behavior.

This method is applied in this study to determine the weight of each of the ten parameters, based on their relevance and importance in relation to the water supply program. A panel of twenty-eight distinguished experts was formed; the experts were selected from

various countries who are very much involved in rural water supply programs. A questionnaire listing the ten parameters was sent and each expert was requested his or her opinion on how to distribute 100 points among the ten parameters. Twenty-three completed questionnaires were received and summarized. A copy of the questionnaire distributed is included as Figure V.4. The average weight for each parameter is summarized in Table V.7. The highest weight is 16.1 for Village Contributions. Three other parameters, Water-borne Diseases, Difficulty in Obtaining Water and Technological Alternatives, received high weights, 14.9, 14.4 and 13.9, respectively. Population received only 11.5, just slightly above the mean value of 10, and occupied the fifth rank. Village Potential received 9.0, below the mean value, and occupied the sixth rank, and Public Places received 6.9 and occupied the seventh rank. The three parameters which received the lowest weights were Excreta Disposals, Power Supply and Road Conditions receiving 5.4, 4.4 and 3.5, respectively. Upon review of the results, no panel member disagreed with the average weight distribution. Thus, it was concluded that the average weight for each parameter was a reasonable figure to work with.

Data Collection. The data was obtained from the Directorate of Hygiene and Sanitation, Directorate General of Communicable Diseases, Ministry of Health, Jakarta, Indonesia, through the Phase I Survey which covered about 21,000 villages. Copies of Questionnaires A, B, and C and of Questionnaire Part I are included in the appendix for Chapter V. This data was collected using Questionnaire A, instead of Questionnaire Part I which was used to develop the ten parameters as criteria for assigning priority. Due to this change in the questionnaires, information on some of the parameters was not made available. However,

Fig. V.4. QUESTIONNAIRE FOR DETERMINING PARAMETER WEIGHTS

No.	Parameter	Weight
1.	Waterborne Diseases	_____
2.	Difficulty in Obtaining Water	_____
3.	Technological Alternatives	_____
4.	Population	_____
5.	Village Contributions	_____
6.	Village Potential	_____
7.	Public Places	_____
8.	Excreta Disposals	_____
9.	Road Conditions	_____
10.	Power Supply	_____
Total		100.00

Date \_\_\_\_\_

Name \_\_\_\_\_

Title \_\_\_\_\_

\_\_\_\_\_

\_\_\_\_\_



TABLE V.7  
AVERAGE WEIGHT DISTRIBUTION OF THE TEN PARAMETERS

No.	Parameter	Average weight
1.	Waterborne Diseases	14.9
2.	Difficulty in Obtaining Water	14.4
3.	Technological Alternatives	13.9
4.	Population	11.5
5.	Village Contributions	16.1
6.	Village Potential	9.0
7.	Public Places	6.9
8.	Excreta Disposals	5.4
9.	Road Conditions	3.5
10.	Power Supply	4.4
	Total	100.0

discussions with health officials in Jakarta and Bandung concluded that these ten parameters should be kept.

Data collection was conducted by sanitarians and assistant sanitarians from the Kabupaten and Kecamatan Levels using Questionnaire A, one per village. The completed A Questionnaires were gathered at the Kecamatan Office, where the data was then transferred to B Questionnaires; this is called Tabulation at the Kecamatan Level. The completed B Questionnaires were then sent to the Kabupaten Office and were transferred to C Questionnaires. This is called Tabulation at the Kabupaten Level. Finally, C Questionnaires were sent to the Directorate of Hygiene and Sanitation (Central Government). There only the C Questionnaires from the twenty-two surveyed provinces were available at the Directorate of Hygiene and Sanitation because the original data, A Questionnaires, were kept at the Kecamatan Office, and B Questionnaires were kept at the Kabupaten Office. Tabulation at Kabupaten Level, C Questionnaires, do not contain detailed data for every village, but rather data and information for the whole Kabupaten area; they cannot be used to establish a priority based on individual villages. To establish a priority, completed B Questionnaires should be used. (There were four Kabupatens who misunderstood the above procedure for handling data and sent Questionnaires A, B and C to the Directorate of Hygiene and Sanitation.)

Finally, to get the most representative data possible based on the data available at the Directorate of Hygiene and Sanitation, twenty-two C Questionnaires representing Twenty-two Kabupatens from twenty-two Provinces were selected, and thirty-five B Questionnaires

were also selected and obtained from the following Kabupatens: four from North Maluku; fourteen from Tasikmalaya; eight from Cirebon; and nine from Majalengka. For additional information, 134 A Questionnaires from Cirebon and Tasikmalaya Kabupatens were also selected and obtained. The total data selected and brought back to Norman, Oklahoma, consisted of 1,468 pages, and from this raw data the final selection was made to meet the requirement of testing the model.

Scoring Process. The scoring process consisted of the categorization of the data and score assignment of each data category. As indicated earlier, data for some parameters was not made available through use of Questionnaires A, B, and C. In this case, categorization was based on Questionnaire Part I which was used to develop the ten parameters. Efforts were made in categorization to quantify as many of the parameters as possible in order to facilitate application to the model. The categorization of each parameter follows.

(Waterborne Diseases.) There are five diseases that are considered waterborne diseases in the survey data, namely, cholera, gastroenteric disease, typhoid, trachoma and skin disease. According to Questionnaire A, these five diseases are categorized as follows:

- a. Five diseases present.
- b. Four diseases present.
- c. Three diseases present.
- d. Two diseases present.
- e. One disease present.
- f. Cholera present.
- g. No disease present.

(Difficulty in Obtaining Water.) This parameter is expressed in the distance the villagers have to travel to a water source and the distance they climb or descend to get to the water source.

This parameter is categorized as follows:

- a. less than 200 meters away without climbing or descending,
- b. between 200 and 1,000 meters away without climbing or descending,
- c. more than 1,000 meters away without climbing or descending,
- d. less than 200 meters away with climbing or descending less than 150 meters,
- e. between 200 and 1,000 meters away with climbing or descending less than 150 meters,
- f. between 200 and 1,000 meters away with climbing or descending 150 meters or more,
- g. more than 1,000 meters away with climbing or descending less than 150 meters,
- h. more than 1,000 meters away with climbing or descending 150 meters or more.

(Technological Alternatives.) This parameter is categorized as follows:

- a. rainwater collections,
- b. dug wells or tube wells with handpumps,
- c. spring protections without piped systems,
- d. spring protections with piped systems by gravity,
- e. spring protections with pump and piped systems,
- f. free-flowing artesian wells without piped systems,
- g. free-flowing artesian wells with piped systems,
- h. non-free flowing artesian wells with pump and piped systems,
- i. surface water (includes rivers, irrigation canals, lakes and ponds) with piped systems by gravity and chlorination,

- j. surface water with piped systems, pump and chlorination,
- k. surface water with complete treatment and piped systems.

(Population.) The data shows that the population varies widely, from 100 to more than 36,000 people per village. However, generally, the number of people in the villages within the same Kecamatan do not vary very much; this will ensure a fair result in population scoring because score assignment is made Kecamatan by Kecamatan. Based on the wide range in population size, this parameter is categorized into six groups and each group is further broken down into five sub-groups in accordance with the average number of people per village within the Kecamatan, as presented in Table V.8.

(Village Contributions.) This parameter can be quantified if the village contributions are expressed in terms of the percentage of the total construction cost and the amount for operation and maintenance which the villages are willing to pay, whether this be in the form of money, labor or local materials. However, the data available gave only the villages willingness to contribute to the construction and/or maintenance costs without further specification. Based on this data, this parameter is categorized as follows:

- a. willing to contribute to the construction and maintenance costs,
- b. willing to contribute to the construction cost only,
- c. willing to contribute to the maintenance cost only,
- d. not willing to contribute at all.

(Village Potential.) This parameter includes the elements of economic growth potential and manpower. It is better to express

TABLE V.8  
 POPULATION, CATEGORIES, AND SUB-GROUPS  
 (Population in Thousands)

Average Population per Village with- in the Kecamatan	Population and Sub-Groups for Each Village				
	1	2	3	4	5
a. up to 0.50	up to 0.15	0.15- 0.25	0.25- 0.50	0.50- 1.00	1.00 and up
b. 0.50- 1.00	up to 0.50	0.50- 0.75	0.75- 1.25	1.25- 2.00	2.00 and up
c. 1.00- 2.50	up to 1.00	1.00- 1.50	1.50- 2.50	2.50- 4.00	4.00 and up
d. 2.00- 5.00	up to 2.00	2.00- 3.00	3.00- 4.50	4.50- 7.00	7.00 and up
e. 5.00-10.00	up to 5.00	5.00- 7.00	7.00-10.00	10.00-15.00	15.00 and up
f. 10.00 and up	up to 10.00	10.00-15.00	15.00-20.00	20.00-25.00	25.00 and up

the economic growth potential in terms of income per family, but this is difficult to assess because incomes are not stable and do not come from merely one source for most villagers, since the majority of the villagers are farmers. During farming season the villagers work on their farms, but off-season they find other jobs in such areas as construction, public transportation, trade, handcrafts, and fishing. Therefore, it is better to express village economic growth potential in terms of land use, mineral resources, industrial development, and number of infrastructures and utilities as was done by the PSA Group (3) in 1973 for the West Java Province Rural Water Supply Program.

The following factors were used:

- a. agricultural land used as rice field,
- b. agricultural land used as dry farming,
- c. agricultural land used as fish ponds,
- d. planned industrial development,
- e. high growth industry,
- f. medium growth industry,
- g. mineral resources such as oil, coal, tin, bauxite, manganese, gold, copper, nickel, sulphur, and lime,
- h. Central Government and/or Provincial roads,
- i. Kecamatan road infrastructures,
- j. electricity distribution and/or potential for distribution such as proximity to tension lines,
- k. an urban center in the Kecamatan or in its neighborhood.

Manpower is categorized as follows:

- a. engineers,
- b. bachelor engineers,
- c. health controllers,

- d. technicians,
- e. sanitarians,
- f. assistant sanitarians.

(Public Places.) This parameter is quantifiable, so categorization is not necessary because scoring merely follows the number of public places such as the number of health centers, schools, markets, mosques, churches and temples that exist in each village.

(Excreta Disposal.) This parameter is expressed in terms of the percentage of houses in each village using sanitary excreta disposal methods such as septic tanks, latrines, and fish ponds. Since this parameter is quantifiable, categorization is not necessary.

(Road Conditions.) This parameter is expressed in terms of accessibility to carriers and capacities. The categorization is as follows:

- a. accessible to trucks,
- b. accessible to light trucks,
- c. accessible to carts pulled by horses, cows, and water buffaloes,
- d. accessible to two-wheeled vehicles.

(Power Supply.) This parameter is categorized on the capacity of the power output available expressed in terms of kilowatts, as follows:

- a. up to 1.5 kilowatts,
- b. 1.5 to 3 kilowatts,
- c. 3 to 5 kilowatts,
- d. more than 5 kilowatts.

The following paragraphs discuss the process of score assignment for each parameter. Scoring (establishment of  $S_{ij}$  values) is somewhat



arbitrary. The score values will range from 0 to 15 using only round numbers.

(Waterborne Diseases.) The score for each category is merely the sum of the scores of the diseases represented in each category for a particular case. For the five diseases considered as waterborne, the scoring values are based on how dangerous each disease is and the role of water in transmitting those diseases. For the scoring values used for each disease, see Table V.9.

(Difficulty in Obtaining Water.) The scores range from 1 for the smallest distance without climbing or descending to 10 for the farthest distance with the greatest amount of climbing or descending, as presented in Table V.10.

(Technological Alternatives.) The scores range from 1 for the most complicated to 10 for the simplest systems as shown in Table V.11.

(Population.) The scores range from 1 for the smallest number of people to 10 for the largest number of people in each village as shown in Table V.12.

(Village Contributions.) The scores range from 0 for villages which are not willing to contribute to the construction or maintenance costs to 10 for villages which are willing to contribute to the construction and maintenance costs. See Table V.13.

(Village Potential.) Categorization was not necessary because score values were simply assigned for each of the relevant factors which can exist in a village. The total score is the sum of the score values for all the factors present in the community. The values are presented in Table V.14.

TABLE V.9  
SCORE ASSIGNMENT FOR  
WATERBORNE DISEASES

Disease	Score
Cholera	5
Gastroenteric disease	4
Typhoid	3
Trachoma	2
Skin disease	1
No disease	0

TABLE V.10  
SCORE ASSIGNMENT FOR DIFFICULTY IN  
OBTAINING WATER

Category	Score	Category	Score
a	1	e	6
b	2	f	8
c	4	g	8
d	4	h	10

TABLE V.11  
SCORE ASSIGNMENT FOR TECHNOLOGICAL  
ALTERNATIVES

Category	Score	Category	Score
a	10	f	6
b	10	g	4
c	8	h	3
d	7	i	3
e	5	j	1
		k	0

TABLE V.12  
SCORE ASSIGNMENT FOR POPULATION

Category	Population Sub-Group				
	1	2	3	4	5
a	1	2	3	4	5
b	2	3	4	5	6
c	3	4	5	6	7
d	4	5	6	7	8
e	5	6	7	8	9
f	6	7	8	9	10

TABLE V.13  
SCORE ASSIGNMENT FOR VILLAGE  
CONTRIBUTIONS

Category	Score
a	10
b	5
c	5
d	0

TABLE V.14  
SCORE ASSIGNMENT FOR VILLAGE POTENTIAL

Factor	Score	Factor	Score
a	2	g	4
b	1	h	1
c	2	i	1
d	3	j	1
e	7	k	2
f	4		

(Public Places.) The score value given each public place is based on the quantity and frequency of water use and its role in transmitting or controlling the waterborne diseases; these values range from 1 to 5 as shown in Table V.15. The total score is derived from knowing the total number of public places in a community.

(Excreta Disposals.) The score is based on the percentage of houses using sanitary excreta disposal methods and ranges from 1 for ten percent to 10 for 100 percent, as is shown in Table V.16.

(Road Conditions.) The scores range from 1 for accessibility to two-wheeled vehicles to 5 for accessibility to trucks as shown in Table V.17. In some areas in Kalimantan and Sumatra, transportation consists of boats, speed boats and canoes. In this case, a boat is equivalent to a truck, a speed boat to a light truck and a canoe to a cart.

(Power Supply.) The scores are based on power supply capacity and range from 1 for the lowest capacity to 4 for the highest capacity as is shown in Table V.18.

#### TEST OF THE MODEL

Introduction. The data obtained from the Indonesian Government was processed to demonstrate the utilization of the model. This will provide guidelines for the planners who are involved in the Indonesian Rural Water Supply Program at the kabupaten level by giving them an example of practical use.

The priority setting chosen was the kabupaten level because the project manager of the rural water supply projects is the Bupati. INPRES funds and funds from local communities come to the Bupati

TABLE V.15  
SCORE ASSIGNMENT FOR  
PUBLIC PLACES

Public Places	Score
School	5
Health center	4
Market	3
Mosque	3
Church	2
Temple	1

TABLE V.16  
SCORE ASSIGNMENT FOR EXCRETA DISPOSAL

Houses Using Sanitary Excreta Disposal Facilities (Percent)	Score	Houses Using Sanitary Excreta Disposal Facilities (Percent)	Score
Up to 10	1	51 to 60	6
11 to 20	2	61 to 70	7
21 to 30	3	71 to 80	8
31 to 40	4	81 to 90	9
41 to 50	5	91 to 100	10

TABLE V.17  
SCORE ASSIGNMENT FOR  
ROAD CONDITIONS

Category	Score
a	5
b	3
c	2
d	1

TABLE V.18  
SCORE ASSIGNMENT FOR  
POWER SUPPLY

Category	Score
a	1
b	2
c	3
d	4

account. Additional data and information, if desirable, is easily obtained at the kabupaten office. The Bupati knows much more about the rural conditions and characteristics in his area than do the officials from the Directorate of Hygiene and Sanitation.

To perform the test, selection was made of six B Questionnaires representing six Kecamatan from four Kabupatens. Additional information, when necessary, might be obtained from the available A and C Questionnaires. The six Kecamatan included Ibu and Jailolo Kecamatan from the North Maluku Kabupaten, Maluku Province; Kadipaten Kecamatan from the Majalengka Kabupaten, West Java Province; South Cirebon Kecamatan from the Cirebon Kabupaten, West Java Province; Manonjaya and Tasikmalaya Kecamatan from the Tasikmalaya Kabupaten, West Java Province.

Score Processing. The example of only one of the six Kecamatan is presented here. The data from the Ibu Kecamatan will be categorized and scored for each parameter. The IBU Kecamatan, located in the North Maluku Kabupaten, Maluku Province, is an area which has the lowest average population per village in Indonesia, that is, 336 people per village. The actual number of people per village ranges from 111 to 1,158 people. The total population of the Kecamatan is 10,070 which is dispersed among thirty villages within the Kecamatan area. One more interesting point is that no waterborne disease is present in this Kecamatan.

(Waterborne Diseases.) Data concerning waterborne diseases can be seen in Table B.8 of Questionnaire B. Since there is no waterborne disease indicated, all villages in this Kecamatan belong to category (g) with a score of 0.



(Difficulty in Obtaining Water.) Table B.3.2, Questionnaire B, indicates that the villagers in this Kecamatan take water from wells, springs, rivers or irrigation canals. Table B.6 indicates that the villagers have to travel from less than 200 to more than 1,000 meters to get to the water sources, while Table B.7 indicates that the villagers from some villages do not have to climb or descend and that others have to climb or descend from less than 150 to more than 150 meters. Thus the Ibu Kecamatan contains within it villages which fall into most of the categories of this parameter, as is shown in Table V.19.

(Technological Alternatives.) For this parameter the planner must consider Tables B.4, B.5, B.6, B.7, B.8 and B.9, Questionnaire B, to decide the best possible alternatives for each village. For villages numbered 17 and 19, the best possible alternatives are dug or tube wells with handpumps (category b), because groundwater is available all year round in those two villages and it is of a good quality with a water depth less than fifteen meters and can be drawn out by deep-handpumps. Spring protections without piped systems (category c) should be used for villages numbered 1, 5, 13, 15, 16, 27, 28, 29 and 30 because there are located within 200 meters of these communities springs which never dry. Spring protections with piped gravity systems (category d) should be used for villages numbered 2, 3 and 26 because there are springs which never dry located within a distance from the communities of between 200 to 1,000 meters or more than 1,000 meters and at an elevation higher than that of the communities. Surface water with piped systems and chlorination (category i) should be used for villages numbered 4, 6 - 12, 14, 18, and 20 - 25 because only surface water from rivers or irrigation

TABLE V.19

CATEGORY AND SCORE FOR DIFFICULTY IN OBTAINING WATER  
IN THE IBU KECAMATAN

No.	Village	Category	Score
1.	Podal	a	1
2.	Tengwango	e	6
3.	Togowo	e	6
4.	Duno	e	6
5.	Tokowoko	a	1
6.	Goin	a	1
7.	Sangaji Nyeku	a	1
8.	Sangaji Adu	a	1
9.	Toguis	f	8
10.	Togoreba Sungai	a	1
11.	Borona	a	1
12.	Todake	b	2
13.	Sirimahu	e	6
14.	Pasalulu	a	1
15.	Togoreba	f	8
16.	Tobaol	a	1
17.	Tongutette	a	1
18.	Gam Lamo	a	1
19.	Gam Ici	a	1
20.	Tongute Sungu	d	4
21.	Akesibu	h	10
22.	Tongute Goin	a	1
23.	Maritango	a	1
24.	Kei Ici	h	10
25.	Naga	e	6
26.	Tosoa Togower	f	8
27.	Tababal	a	1
28.	Baru	a	1
29.	Aduu	d	4
30.	Ngawet Nanas Jere	d	4

canals is available during the dry season in those sixteen villages and because the water quality is good that is, it is clear and not salty. The scores for this parameter are presented in Table V.20.

(Population.) The number of people per village within the Ibu Kecamatan is obtained from Table B.2, Questionnaire B. The average number of people per village is 336; therefore, this Kecamatan belongs to category (a) with the scores ranging from 1 to 5, as presented in Table V.21.

(Village Contributions.) The data for this parameter is obtained from Table B.10, Questionnaire B. All villages in the Ibu Kecamatan are willing to contribute to the construction costs and the villages numbered 1 to 16 are also willing to contribute to the maintenance costs. Thus, the sixteen villages numbered 1 to 16 belong to category (a) with a score of 10, and the fourteen villages numbered 17 to 30 belong to category (b) with a score of 5.

(Village Potential.) There is no data available for this important parameter due to the questionnaire change.

(Public Places.) There is no data for this parameter.

(Excreta Disposal.) The data for this parameter would ordinarily be obtained from Table B.16, Questionnaire B, and Table A.13, Questionnaire A. However, these two tables were left blank by the surveyor.

(Road Conditions.) There is no data for this parameter due to the questionnaire change.

(Power Supply.) There is no data for this last parameter due to the questionnaire change also.

Priority Computation. The priority indices were then determined for the villages. The products of  $W_i S_{ij}$  was determined and the value

TABLE V.20  
 CATEGORY AND SCORE FOR TECHNOLOGICAL ALTERNATIVES  
 IN THE IBU KECAMATAN

No.	Village	Category	Score
1.	Podal	c	8
2.	Tengwango	d	7
3.	Togowo	d	7
4.	Duno	i	3
5.	Tckowoko	c	8
6.	Goin	i	3
7.	Sangaji Nyeku	i	3
8.	Sangaji Adu	i	3
9.	Toguis	i	3
10.	Togoreba Sungai	i	3
11.	Borona	i	3
12.	Todake	i	3
13.	Sirimahu	c	8
14.	Pasalulu	i	3
15.	Togoreba	c	8
16.	Tobaol	c	8
17.	Tongutette	b	10
18.	Gam Lamo	i	3
19.	Gam Ici	b	10
20.	Tongute Sungai	i	3
21.	Akesibu	i	3
22.	Tongute Goin	i	3
23.	Maritango	i	3
24.	Kie Ici	i	3
25.	Naga	i	3
26.	Tosoa Togower	d	7
27.	Tababal	c	8
28.	Baru	c	8
29.	Aduu	c	8
30.	Ngawet Nanas Jere	c	8

TABLE V.21  
 CATEGORY AND SCORE FOR POPULATION  
 IN THE IBU KECAMATAN

No.	Village	Population	Category	Score
1.	Podal	413	a.3	3
2.	Tengwango	184	a.2	2
3.	Togowo	244	a.2	2
4.	Duno	424	a.3	3
5.	Tokowoko	139	a.1	1
6.	Goin	244	a.2	2
7.	Sangaji Nyeku	157	a.2	2
8.	Sangaji Adu	111	a.1	1
9.	Toguis	117	a.1	1
10.	Togoreba Sungai	243	a.2	2
11.	Borona	170	a.2	2
12.	Todake	167	a.2	2
13.	Sirimahu	190	a.2	2
14.	Paslulu	523	a.3	3
15.	Togoreba	339	a.3	3
16.	Tobaol	287	a.3	3
17.	Tongutette	749	a.4	4
18.	Gam Lamo	304	a.3	3
19.	Gam Ici	647	a.4	4
20.	Tongute Sungai	503	a.4	4
21.	Akesibu	261	a.3	3
22.	Tongute Goin	463	a.3	3
23.	Maritango	267	a.3	3
24.	Kie Ici	456	a.3	3
25.	Naga	171	a.2	2
26.	Tosoa Togower	241	a.2	2
27.	Tobabal	198	a.2	2
28.	Baru	1,158	a.5	5
29.	Aduu	202	a.2	2
30.	Ngawet Nanas Jere	497	a.3	3
	Total	10,070		

of PI is the summation of  $W_i S_{ij}$ . The values of  $W_i S_{ij}$  and PI for the Ibu Kecamatan are summarized in Table V.22.

Discussion of Results. The higher the PI value the higher the priority of the village to receive the safe water system first. Two of the five parameters used, Waterborne Diseases and Village Contributions, did not have much affect on the priority index (PI) values because most of the villages within the same Kecamatan had the same scores for these two parameters. Since no specifics were given for the waterborne diseases as to the number of cases or the year in which the diseases had occurred, this parameter may have introduced bias into the results, while the willingness of the villages to contribute to the costs was difficult to actually determine from the verbal responses obtained through the survey. The remaining three parameters were affected less by subjectivity in the responses to the questionnaires. Village Potential, Public Places, Excreta Disposal, Road Conditions and Power Supply are also parameters which would not have been as much affected by subjectivity in the responses, had this data been available. The PI figures for the Ibu Kecamatan ranged from 172 to 422. In future surveys data collection should be conducted by well-trained sanitarians and assistant sanitarians in order to ensure reliability of the data.

TABLE V.22

## PI VALUES FOR VILLAGES IN THE IBU KECAMATAN

No.	Village	$W_i \cdot S_{ij}$					PI
		Waterborne Diseases	Difficulty in Obtaining Water	Technological Alternatives	Population	Village Contributions	
1.	Podal	0	14	111	35	161	321
2.	Tengwango	0	86	97	23	161	367
3.	Togowo	0	86	97	23	161	367
4.	Duno	0	86	42	35	161	324
5.	Tokowoko	0	14	111	12	161	298
6.	Goin	0	14	42	23	161	240
7.	Sangaji Nyeku	0	14	42	23	161	240
8.	Sangaji Adu	0	14	42	12	161	229
9.	Toguis	0	115	42	12	161	330
10.	Togoreba Sungai	0	14	42	23	161	240
11.	Borona	0	14	42	23	161	240
12.	Todake	0	29	42	23	161	255
13.	Sirimahu	0	86	111	23	161	381
14.	Pasalulu	0	14	42	35	161	252
15.	Togoreba	0	115	111	35	161	422
16.	Tobaol	0	14	111	35	161	321
17.	Tongutette	0	14	139	46	81	280
18.	Gam Lamo	0	14	42	35	81	172
19.	Gam Ici	0	14	139	46	81	280
20.	Tongute Sungai	0	58	42	46	81	227
21.	Akesibu	0	14	42	35	81	172
22.	Tongute Goin	0	14	42	35	81	172
23.	Maritango	0	14	42	23	81	160
24.	Kie Ici	0	144	42	35	81	302
25.	Naga	0	86	42	23	81	232
26.	Tosoa Togower	0	115	97	23	81	316
27.	Tababal	0	14	111	23	81	229
28.	Baru	0	14	111	58	81	264
29.	Aduu	0	58	111	23	81	273
30.	Ngawet Nanas Jere	0	58	111	35	81	285





## CHAPTER VI

# Implication of Past Developments in Water and Wastewater Technology

The material in this chapter constitutes a historical study of DC water and wastewater technologies and their impact upon the societies that made use of them. First, discussion is presented of material arranged in the following technology categories: water supply, pumps and their power source, pipe for supply and drainage, water treatment and standards, storage in cisterns, distribution and use, sewage removal and treatment, and the administration and financing of water supply systems. This chapter is a shortened version of the original publication, and a great deal of selectivity was exercised in this portion.

Next, developmental summaries are given for Britain and the United States where in each case the various technological categories are integrated to form the picture of a society as a whole. This permits greater insight into the impact of particular technological factors, particularly in the area of public health.

Finally, technological levels and life-style levels are discerned as a chronological concept. The results of this study can assist in the blending of historically used methods with new ones, where this is found to be compatible to LDC sites. A retrospective analysis of technologies and management can be a further aid to planners in assisting LDC sites to avoid the problems which occurred in DC's during the process of development in the area of water supply and sanitation.

## VI.

HISTORIC IMPLICATION FOR DEVELOPING COUNTRIES  
OF DEVELOPED COUNTRIES' WATER  
AND WASTEWATER TECHNOLOGY

Kay Coffey and George W. Reid

This information was compiled for the purpose of providing an examination of the history of the technology of water handling and usage in areas now developed which could be of benefit in accelerating progress in improvements in this field in developing areas. Additional information from less developed regions was included in certain instances where it was of interest. The general purpose was to find historical evidence of alternatives for less developed regions.

The material which follows comprises a summary description of historically used techniques as well as of the chronological development of water usage and handling, first in Great Britain, particularly London, and also in the United States, these being the two areas for which the most complete information was made available to this effort. Finally, life-style levels and technology levels in developed areas were described as chronological concepts.

There are comparisons which can be made between present or projected life-style levels in less developed areas, and the various stages of past life-style levels of those countries which are now considered as being the most highly developed as well as leaders in technological innovations. When linked to technological levels, these comparisons

should provide historical evidence of viable alternatives for developing areas and assist in planning for appropriate and reasonable technologies of water-wastewater treatment and handling for those regions.

#### WATER SUPPLY

Wells were perhaps the principal source for urban areas at least up to 500 A.D. Rock excavating was often accomplished by drilling and wedging, or by firing and cooling. In ancient Palestine a phenomenon called a cave-well was often found. This type of well sometimes developed when the water table fell, and digging laterally along a fissure was done in order to follow the water. A feature of the nineteenth century was the development of the artesian well, which took its name from Artois in France, where it is supposed to have originated in 1126. Early in the nineteenth century, borings were lined with iron tubes, and since then wells have been taken to increasing depths, reaching thousands of feet in this century, where necessary.

Irrigation works played an important role in domestic supplies for early urban areas in Mesopotamia, Egypt, India, and China, as well as in the Middle East.

Often when cities have initially taken their water supply from local surface or ground supplies, and have later found these supplies to be inadequate, it has subsequently become necessary to transport from more distant supplies. Kanats originated probably as early as the fourth millennium B.C. These are subterranean aqueducts used to transport groundwater from an underground aquifer to the point of use at ground surface. Structures of this type are still extant in Iran and Syria where they have been used primarily for irrigation and urban or village supplies since antiquity. In constructing kanats, a shaft was sunk,

perhaps 300 feet, to the water-bearing stratum. A few feet from the bottom of the shaft, a tunnel was placed to connect horizontally with other wells, and to carry the water collected from the wells to its destination, which could be as much as fifty miles away. The wells were placed at intervals of from thirty to eighty yards. The tunnel was about four feet high and two feet wide, either unlined or lined with large oval hoops of baked pottery two inches thick and one foot wide. In later times pipe was used for this purpose. Openings were provided at intervals along the route of the conduit to permit cleaning out of accumulations of settled mud or sand.

Similar channels have been used in Iraq, Yemen, and in North Africa where they were called "foggaras." Cyprus, too, had a kanat-like water system. There soil was removed from the excavations by means of a basket and rope operated by a primitive windlass formed of a cradle of horizontal wooden bars. If valleys lay in the path of the conduit, they were spanned by masonry aqueducts.

There are significant problems associated with the use of a kanat. It is expensive both to construct and maintain. If the tunnels are unlined, there is a heavy loss of water in the system, and the tunnels must be cleaned periodically. Frequently a source dries up or changes take place in the tunnels, necessitating a new kanat.

The Romans made great strides in systems of aqueducts and organized water supply. Certain early instruments were used in the construction of Roman aqueducts to maintain uniform gradients and alignment of tunnel construction. In most cases, a steeper grade than necessary was used to allow for error. A mortar was used which was made of lime, clay, and sand. Elevated channels were troughs of brick or stone lined with

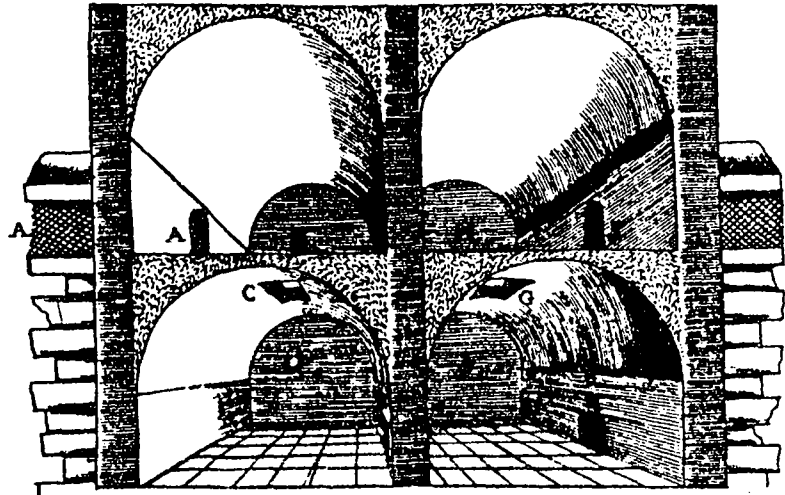

Fig. VI.1. Piscana on Roman aqueduct Virgo. Water enters from aqueduct at A, proceeds following the sequence of letters and returns to the aqueduct at I. Sedimental material passes through K to a cloaca.

SOURCE: Rapha Fabretti, De Aquis et Aquaeductibus Veteris Romae. Dissertationes Tres (Rome: I. B. Bufsotti, 1680), presented by M. N. Baker, The Quest for Pure Water: The History of Water Purification from the Earliest Records to the Twentieth Century (New York: American Water Works Association, 1949), p. 291.

cement and covered with a coping, usually arched. Most often water ran directly through the trough, though sometimes it flowed through pipes of lead or terra-cotta which were laid along the trough. Piscanae or settling tanks were located along the route of the aqueduct to remove sediment.

In ancient aqueduct construction, stone masonry was the principal material. In the Middle Ages, lead, wood or earthenware pipes were used. In modern times larger capacities required open channel stone or brick masonry conduits, and high pressure required reinforced concrete or steel.

In Europe during the Middle Ages the first supplies for towns were usually wells and rivers which represented localized supplies. When population increases brought the need for long-distance supplies, monasteries were leaders in the effort to provide for this need.

In modern times Great Britain and the United States have played leading roles in the development of public water supplies, with most of the development in that area occurring beginning in the nineteenth century.

#### PUMPS AND THEIR POWER SOURCE

The history of the raising of water began with irrigation. Early methods of pumping were often powered by cranks, treadmills, and water or wind power. In Egypt, as early as the eighteenth dynasty (fourteenth-sixteenth centuries B.C.) and perhaps earlier, the counterpoise principle was used in the shaduf, still in use today. A link-chain pump type was used in China from some three thousand years ago. The saqieh, noria, or Persian wheel was thought to have been introduced into Egypt before Roman domination. Its original form is a vertical wheel on the

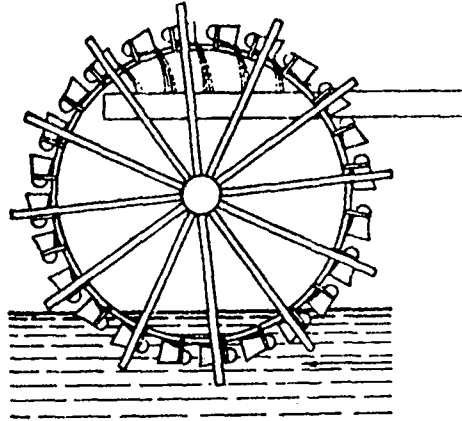

Fig. VI.2. Paddle wheel for raising water,  
a type of noria.

SOURCE: Maurice Daumas, ed., A History of Technology and Invention: Progress Through the Ages, vol. 1: The Origins of Technological Civilization, trans. Eileen B. Hennessy (New York: Crown Publishers, 1969, p. 106.



Fig. VI.3. Form of  
Archimedes' screw.

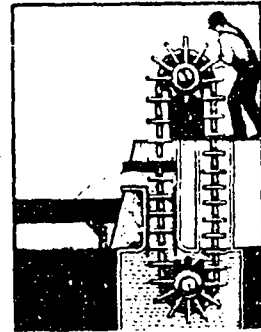

Fig. VI.4. Chain pump.

SOURCE: Compton's Pictured Encyclopedia and Fact-Index, 1952 ed., s.v. "Water."



rim of which water pots are attached to cords. Another smaller vertical wheel with cogs is fixed on the same axis and engaged with the cogs of a large horizontal wheel turned by an animal walking in a circle, or by water power. The endless chain or chain of pots, another form of noria, was supplied power by a crank or treadmill while pots attached were used to raise water.

Another method of water raising was and is the "taboot" or screw. It is essentially the screw of Archimedes (287-212 B.C.). A windlass, described by ancient Greek mechanics, consists of supports and a cylinder rotated by a crank. A rope of light chain winds around the cylinder and raises a water vessel on the other end of the rope.

The invention of the force pump is attributed to a Greek, Ctesibius, in the third century B.C. It is thought the pump was operated by hand only. A description follows of a Roman pump of this type dating from the first century A.D.

It was made of bronze; it had at the bottom a pair of cylinders set a short distance apart and a "Y"-shaped pipe connected with both, joining them to a vessel between them. In this vessel were flap valves fitting over the upper vents of the tubes to prevent water forced up to the vessel from returning. Over the vessel was an inverted funnel fastened to it by means of a wedge thrust through a staple to prevent it lifting under pressure of water. Valves were inserted in the cylinders beneath the lower vents of the pipes and over the openings which were in the bottoms of the cylinders. Pistons, which were oiled, worked in the cylinders and, as the valves stopped up the openings, forced the water by repeated pressure and expansion through the vents of the pipes into the central vessel, from which it passed up a pipe at the top of the funnel, so supplying water to a fountain head from the reservoir at a lower level.<sup>18</sup>(p. 73)

Figure VI.5 illustrates a Roman pump used for domestic water supply and of a type similar to the one described. It dates from the first century A.D. This one was found at Silchester, a Romano-British town in England. It is a double forcing pump which was operated by hand and

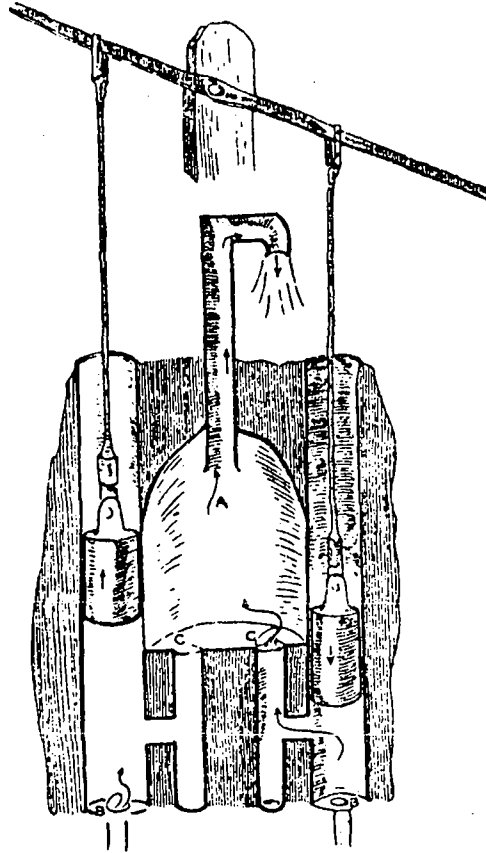

Fig. VI.5. Roman force pump, Silchester, England.

SOURCE: F. W. Robins, The Story of Water Supply (London: Oxford University Press, 1946), p. 78, copyright of Reading Museum.

would only work when submerged. The two barrels were lined with lead tubes, and the body of the pump was cut out of a block of wood. Certain examples found have had pistons of about one inch in diameter and a stroke of from about three to five inches.

In Asia and China, toward the tenth century, windmills came into use for irrigation or drainage. Arabs probably introduced windmills to the West where they were initially used only for the grinding of grain.

After the Roman era, there is a lack of evidence of the use of pumps till the fifteenth century in Europe. The first systems there were of wood and were operated by hand. From about 1500 to 1850 the waterwheel was widely used as a source of power. In the 1700's steam was introduced as a source of power, and metal came to be used throughout pump construction. The principle of the hydraulic ram was discovered in Britain by Whitehunt in 1772, and by 1865 it had become popular for small water supplies. Cheap electrical power has been available in modern times.

#### PIPE, FOR SUPPLY AND DRAINAGE

According to the Copper Development Association, copper piping covered with gypsum and dating from about 2750 B.C. was discovered at Abusir, Egypt. It was made by hand-hammering a thin sheet of copper and then folding it up.

In Crete terra-cotta pipes with cement joints were found in the Palace of Minos at Knossos (about 2000 B.C.). These pipes thus antedate similar earthenware pipes used during Roman and medieval time. Two types were found in Crete. For one type the sections were tapered, the smaller end of one section fitting into the large end of an adjacent section. The smaller end was provided with a stop flange a few inches from the end. The second type was like the first with one

addition. Here the sections were equipped with side loops so that the separate sections could be fastened together.

In the Roman Empire four materials were usually used for pipes: earthenware, lead, wood, and stone. Concrete was also used, and bronze was used infrequently in pipes, for cases where pressures were high. Wood was high in tensile strength, but deteriorated rapidly. Stone, concrete, and terra-cotta were durable, but low in tensile strength. Lead was durable but not resilient; thus it was difficult to make the joints water-tight. Earthenware pipes were cylindrical and had joints of the spigot and socket type. Joints were sealed with a mixture of quicklime and oil.

As the Middle Ages began in Europe, stone channels seem to have been more usual in long-distance supplies, while piping was more characteristic of the fourteenth and fifteenth centuries.

The mains of the New River Company of London (1613-1904) were first of wood. A description of them follows:

Usually they are of elm. They were made from the solid trunk, bored, and laid with the bark left on for external protection. The joints were of the spigot and socket type, the spigot being the smaller tapered end of the log or trunk, which was coated with white lead and driven into the larger end, the latter being reinforced by an iron band driven in. These end bands were of one inch or one and a quarter inch by one and a quarter inch iron, with the inner edges "feathered" to facilitate driving. Y's and T's were at first provided by utilizing the natural forks of the trees. Services were usually of lead. Connexions in case of fire were obtained by the rough and ready method of chopping a hole in the pipe which was afterwards stopped by a plug. As the positions of these plugs were (or should have been) marked to prevent unnecessary additional damage, they became "fireplugs" and gave rise to the term.<sup>19</sup>(p. 160)

Wooden pipes had to be replaced about every fourteen years. Often several lengths were laid together to increase the capacity. Oak and cedar trunks have been used in addition to elm. At Paisley, Scotland, the

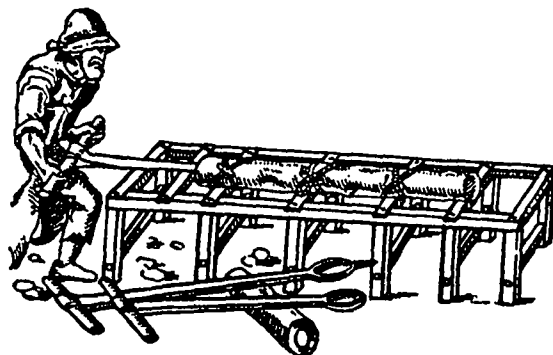

Fig. VI.6. Boring a wooden pipe by hand,  
Europe, early sixteenth century.

SOURCE: Maurice Daumas, ed., A History of Technology and Invention: Progress Through the Ages, vol. 2: The First Stages of Mechanization, trans. Eileen B. Hennessy (New York: Crown Publishers, 1969), p. 255, presenting Georgius Agricola, De Re Metallica (1556), trans. Herbert C. Hoover and Lou Henry Hoover (London: n.p., 1912; reprint ed., New York: n.p., 1950).

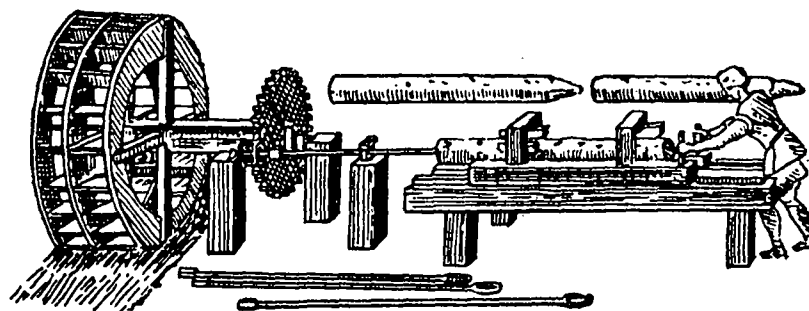

Fig. VI.7. Machine for boring wooden pipes,  
Europe, eighteenth century.

SOURCE: Daumas, vol. 2, p. 517.

first known filter for treatment of a city-wide supply, put into use about 1804, used 200 feet of three inch bore wooden pipe of Scots fir. Present day use of wood stave pipes has been reported in some parts of the United States and Canada.

Blast furnaces were first used in Europe in the fourteenth century. This enabled iron to be melted and then cast into molds. However, since charcoal was the only fuel, this was difficult and expensive. In the 1700's in England, coke was used and the process became cheap enough so that pipes could be manufactured and cast in molds with a steel bar as a core. Thus a new pipe material, cast iron, made its appearance.

In 1825 steel tubes were turned out by the butt welding process. Difficulty was experienced in protecting this material from corrosion.

In 1862 an inventor of Birmingham, England, Alexander Parkes, discovered how to make a composition of cellulose nitrate which was soft when hot, but hard and transparent at room temperature. He called it Parkesine. In the United States, John Welsey Hyatt improved Parkes' material and received a patent in 1870 on what he called celluloid. In 1931 PVC (polyvinyl chloride) pipe was developed by German scientists; in 1941 thermoplastic pipe was developed in the United States, and in 1948 PE (polyethylene pipes).

Pitch-fiber pipe was introduced for drainage in 1906 when drains were installed in Orangeburg, New York. These pipes are made of pulped newspapers impregnated with bitumen.

Asbestos-cement pipe was developed in Europe prior to World War I. This type of pipe resists soil corrosion.

#### WATER TREATMENT AND STANDARDS

In general, there has been a considerable lag between the development of techniques for treating water and their actual use. In the development

of treatment, sedimentation, filtration through porous vessels, and coagulation probably were among the earliest forms of treatment. These methods plus filtration, wick siphons, and distillation were basically the total of methods used till the 1890's. Among the more recent developments have been pH control, softening, and the addition of iodides and fluorides.

Great advances in the art of water treatment were made in the eighteenth century, particularly in the last half. However, for each new process of treatment, there were some who were opposed to its introduction.

About 1800 the objective of filtration was removal of turbidity, and filtration was viewed as a straining process. From about 1850 removal of organic matter became more important, and filtration was viewed increasingly as a chemical and biological process. By the 1800's filtration was viewed as a means to remove bacteria and combat cholera, typhoid, and other diseases. Chlorination has been largely responsible for the reliance on single-pass rapid filtration in the United States, whereas in France where chlorination was not widely adopted, multiple filtration prevailed.

As the debates continued over filtration, and as its use spread, more was being discovered concerning the spread of certain diseases by water which was contaminated. In 1874 the Royal Rivers Pollution Commission in London made a report in which much space was devoted to the "Propagation of Cholera by Water."<sup>2</sup>(p. 122) The conclusions were based on data and facts gathered from the cholera epidemics of 1832, 1849, 1854, and 1866. Data were also presented showing that where slow sand filtration had been installed, there was relatively light

incidence of cholera. Typhoid also had been traced to contaminated water. In 1876 in the United States John T. Fanning wrote that water could be a vehicle for the spread of diarrhea, dysentery and typhoid. In 1880 the typhoid bacillus was isolated.

In spite of some opposition here and there to rapid filtration, coagulation, and chlorination, all proved to be invaluable in combatting death and disease which had previously visited large urban areas in frequently recurring waves. One example took place in Hamburg and Altona Germany where a cholera epidemic occurred in 1892. The Hamburg epidemic was the result of contaminated water from the Elbe River. In Altona, water from the same stream was used, and even though all of the sewage from Hamburg was discharged a few miles above Altona, the epidemic in Altona was much less serious. A second example occurred in Louisville, Kentucky, where for the years 1906-1910 the typhoid death rate was 52.7 per 100,000. Rapid filters went into operation in the summer of 1909, but it was not until 1912 that all elements of the system were operating together, that is, filtration, sedimentation, and coagulation, and the typhoid death rate fell to 19.7 for 1911-15. In 1914-15 prechlorination was begun, and the typhoid death rate fell to 9.7 for 1916-20. In 1924 postchlorination was added, and the typhoid death rate fell again to 4.9 for 1921-25 and on down to 0.9 for 1936-40. Along with other typhoid prevention measures, the improvement in water treatment contributed to the decline of typhoid in Louisville, Kentucky.<sup>2</sup>(p. 241)

Early standards of water quality were based on clarity, taste, odor and the health of users. Later tests measured the amount of oxygen, chlorine, nitrites, certain types of bacteria, and radioactive elements.



Early Treatment of Water by Filtration. In 1749 Joseph Amy in France was granted the first water filter patent issued by any country. These filters were to be constructed of lead, pewter, or earthenware, with filtering materials of sponge and sand which would be washed in place. The sand was to be packed between two perforated plates. In 1791 in England, James Peacock set forth the reasons for placing coarse material at the bottom of a filter with regularly decreasing sizes above it, so that interstitial spaces would increase in geometric ratio.

The first filtration plant for city-wide supply was installed at Paisley, Scotland, in about 1804. The plant utilized a prefilter, sedimentation and double filtration, with lateral flow throughout. Water passed through a roughing filter to a pumpwell. A steam engine lifted the water to the settling basin. The settling basin, main filters, and clear-water basin were arranged concentrically.

Filter-Cisterns. From the founding of Venice in the fifth century till the eighteenth century, the city depended on water stored in cisterns. Many of these came to be surrounded by a sand filter. The cisterns were usually ten to twelve feet deep while the surrounding filter might be twice that deep. To construct a filter cistern, a cone-shaped excavation was first made. Then a timber form was placed against the wall of the pit and on this was placed well-puddled clay. A flat stone formed the bottom of the cistern and the walls were made of bricks laid with open joints. The space between the cistern and the edge of the excavation with the puddle lining, was filled with sand. At each corner of the filter was a place where water could be fed to the filter, either collected rainwater from roofs and interior courtyards or water transported from elsewhere.

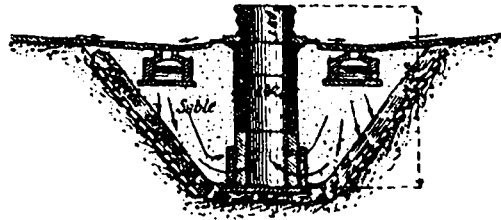

Fig. VI.8. Cross section of Venetian filter-cistern.

SOURCE: Edouard Imbeaux, *L'Alimentation en Eaux* (n.p., 1902), presented by M. N. Baker, *The Quest for Pure Water: The History of Water Purification from the Earliest Records to the Twentieth Century* (New York: American Water Works Association, 1949), p. 15.

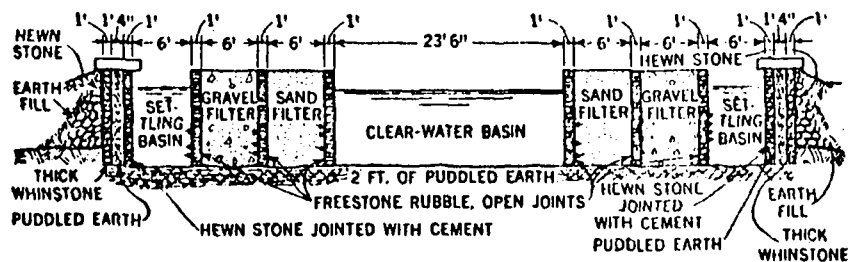

Fig. VI.9. First known filter to supply an entire city with water, Paisley, Scotland, 1804.

SOURCE: John Sinclair, *The Code of Health and Longevity* (Edinburgh: A. Constable & Co., 1807), presented by Baker, p. 78.

Filtration Basins and Galleries. A procedure has been noted among various peoples, whereby water is obtained from hollows scooped out in the sand along a river or waterhole, even when dry. The water thus obtained, most of it coming from groundwater, has been filtered by passage through the sands. This method may be regarded as a prototype of the infiltration basin. This basin sometimes consists only of a shallow open basin with an unpaved bottom. Filter galleries are usually open-jointed conduits of brick, stone, concrete, or pipe, laid in trenches which have been filled in again.

The successful operation of a natural filter, depends upon proper studies to determine suitable locations. It is important to ascertain the probable division of yield between the adjacent body of water and the underflow, and particularly the liability of clogging of the material between the body of water and the gallery or basin. Deposit of sediment will be made on the river bottom, and the extent of scouring should be considered. Studies should be made of the stratum of permeable material, depth and slope of the water table, and characteristics of the surface water and groundwater in the area. If conditions appear favorable, it might be worthwhile to consider a natural filter.

Slow Sand Filter. Robert Thom of Scotland and James Simpson of England were outstanding pioneers in the development of filtration. Thom's first municipal filter was installed at Greenock in 1827, and Simpson's at London in 1829. Through experimentation, both men discovered that the failure of filters due to clogging occurred at or just below the surface, and each developed a method of cleaning. Simpson's method consisted in scraping off the top layer, washing and restoring it, and totally replacing it at suitable intervals. Thom's method of

cleaning was the reverse-flow wash which had been called for in the patent for Peacock's filter in 1791. Both men utilized the method of arranging successively finer filter media from the bottom to the top of the filter, as had also been called for in the British patent granted to Peacock.

Simpson's filter had open-jointed branch drains of brick. Settling reservoirs were operated with their low-water line level with the high-water line of the filter. Output was usually about three million gallons per day (U.S.) per acre. Simpson reported that, "the silt, . . . renders the interstices between the particles of sand still more minute, and the bed generally produces better water when it is pretty well covered with silt than at any other time. . . . and in cleaning the silt off, it has never been found necessary to scrape any more of the sand off with the silt than the first half-inch depth and sometimes only half that depth was removed."<sup>2</sup>(pp. 107-108) Materials used in the bed were river sand, shells and pebbles, and gravel, with the surface arranged in ridges. The small shells were used to improve the separation of the sand from the gravel and thus maintain the free percolation in the lower layers which would speed up the rate of filtration.

Thom's filter was enclosed by rectangular masonry walls. The filter media was supported on a false bottom of flat tiles with perforations more than 0.1 inch in diameter. Bricks supported the false bottom and formed the underdrains. Media used were gravel, sand, and charcoal. The charcoal, ground to about 1/16 inch diameter, was mixed with the upper layer of sand. Cleaning was by reverse-flow wash aided by stirring with a rake. Output at a filter constructed by Thom at Paisley was given as an average rate of nearly six million

gallons per day per acre or double the rate of slow sand filters of that and later dates.

The Simpson type of slow sand filter became the model for slow sand filters throughout the world. Thom's design was used to limited extent, but the elements of reverse-flow wash with the false bottom were principal features of the rapid filter developed in the United States during the 1880's.

In January of 1829 Simpson reported that although the bed of the filter was covered with five inches of ice, it was still working properly. This is the earliest known report of the effect of ice on filtration. In certain cases of slow sand filtration, climates have been reported such that ice cover for long periods has both prevented cleaning of the bed, and hindered the passage of air and light so as to cut down on the efficiency of the filters. Slow sand filters may be found which have been covered to remedy such situations. In 1876 Colonel John T. Fanning, dean of U.S. hydraulic engineers in the last third of the nineteenth century, wrote a treatise on water works in which he emphasized the need for roofing filters to protect their operation against the effects of both low and high temperatures.

At the Lawrence Experiment Station in Massachusetts, established in 1887, much research was devoted to experiments on the nitrification of organic matter by intermittent sand filtration. Time was to prove that intermittent filtration was not a suitable practice for water treatment. It had been taken over from sewage treatment where a large amount of organic matter often had to be oxidized.

Rapid Filtration. The Frenchman Henry Darcy patented a filter in 1856 which encompassed all the elements of the future American rapid filter, save one, coagulation. Most aspects of Darcy's system had been developed previously, but the particular combination he devised was new. It was proposed to use increased pressure or negative pressure and only about one foot of sand and one-third to two-thirds foot of gravel. Reverse-flow wash was to be used at intervals, as well as scraping. In addition, there were proposed the new methods of keeping the filter clean by means of sweeping the surface with a mechanically driven revolving broom, and discharging to waste suspended matter within twenty inches of the surface of the sand, without stopping filtration. (Raw water was introduced horizontally to the filtration tank one meter above the filter bed.) In the 1880's and early 1890's the rapid filter was developed in the United States and put on a sound engineering basis. Principal methods of cleaning used were jets of water directed on or just below the surface, reverse-flow wash, and agitators which loosened the media from top to bottom. No coagulant was used in various of the antecedents of the American rapid filter, or in instances of the later rapid filters. However, in general, pre-coagulation and sedimentation came to be regarded as an important element of most rapid filtration units.

Drifting-Sand Rapid Filters. The basic principle of this type of rapid filter is the ejection of sand from the bottom of the filter and its replacement at the top of the filter to aid in the washing process.

Multiple Filtration. In 1685 Luc Antonio Porzio, an Italian physician, proposed multiple filtration through sand, preceded by straining and sedimentation. After 1685 multiple filtration was proposed

from time to time and was used in Scotland, England, and other places. At the close of the nineteenth century the city of Paris adopted multiple filtration consisting of two or more roughing filters of gravel, a prefilter, and a final filter of the slow sand type. This system subsequently became widely used in France, more than in other parts of the world.

The Paris filters of 1899 were installed by Armand Puech, who had taken out a British patent on multiple filters in 1898. From filter to filter in the series, the filtering material decreased successively in size as did the unit rate of filtration. In these early days of the Puech filters, there was generally no presedimentation, coagulation, or disinfection. Later in the development of this system, the roughing filters and prefilters were converted into what were actually rapid filters. After installation of the Paris filters, Puech was joined by H. Chabal and by 1935 the Puech-Chabal system of filtration was more widely used in France than any other means of water purification.

Non-Submerged Filter. This type of filter was developed in France beginning in the early 1890's. Water was to be showered upon the filter at such a rate that it would not stand on or in the sand, and really involved the same operation as that found in the sewage trickling filter which was being perfected in the 1890's in England.

Sedimentation and Coagulation. In 1904 Allen Hazen wrote an important paper on sedimentation. Parts of the introduction and summary follow:

It has been found in St. Louis that continuous operation, that is to say, a continuous flow of water into, through and out of the basin, gives quite as good results as the intermittent operation. . . . The use of baffles has also been learned, and it has been shown clearly that a well-baffled basin will do as much work as a much larger basin without baffles. . . .

The fundamental propositions [of sedimentation] may be very concisely expressed. They are: first, that the results obtained are dependent upon the area of bottom surface exposed to receive sedimentation, and that they are entirely independent of the depth of the basin; and second, that the best results are obtained when the basins are arranged so that the incoming water containing the maximum quantity of sediment is kept from mixing with water which is partially clarified. In other words . . . practically accomplished by dividing the basing into consecutive apartments by baffling or otherwise.<sup>2</sup>(p. 298)

Coagulation as an aid to sedimentation has been practiced since ancient times. The list of materials used for this purpose is extensive, but the most common are aluminum sulfate or alum and lime. An alum dosing apparatus was patented in 1890 by Professor Henry Carmichael of Massachusetts. It was a pump with curved tubes attached to a hollow hub. The pump was driven by a propellor in the raw water main. Greater velocity and therefore volume of the raw water increased the speed of the pump. Sometimes around-the-end baffled mixing chambers have been used for mixing the chemicals introduced for coagulation.

Originally plain sedimentation had for its objective the removal of turbidity. Later, especially when used with rapid filtration, coagulation and sedimentation have had as objectives, in addition to the removal of turbidity, the removal of color and bacteria.

Disinfection. The earliest British patents involving some type of chlorination date from about 1840. Chlorination with bleaching powder was used in 1896 to stop a typhoid epidemic at Pola on the Adriatic Sea (one-time chief naval station of Austria-Hungary). Sodium sulfite was used to neutralize the excess chlorine. At a Louisville, Kentucky, testing station in 1896 William M. Jewell applied chlorine gas to the effluent from a Jewell rapid filter. It was operated about ten days, and chlorine was applied at the rate of 0.25 ppm. This was probably



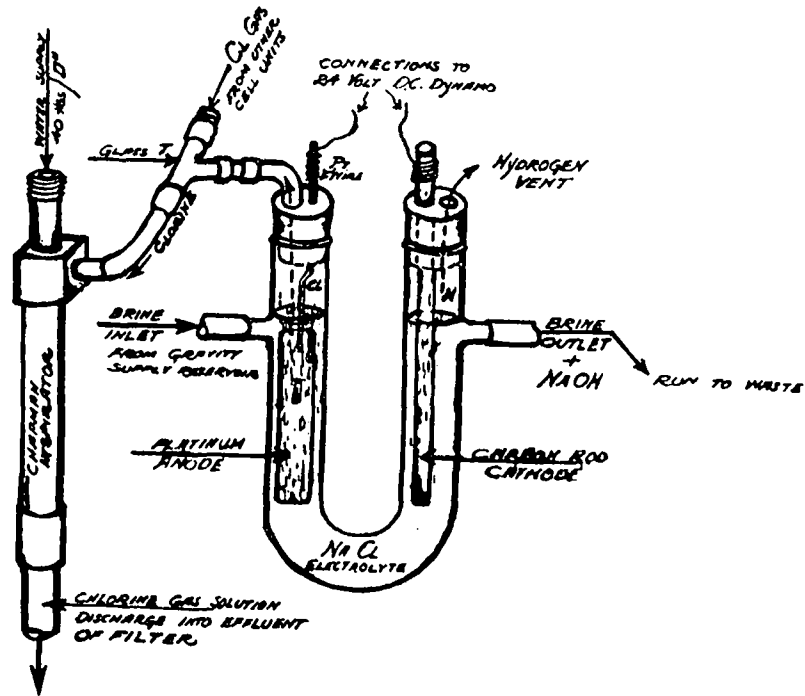

Fig. VI.10. Jewell chlorine gas generator,  
Louisville, 1896.

SOURCE: Reproduction of sketch made by William M. Jewell, presented by M. N. Baker, The Quest for Pure Water: The History of Water Purification from the Earliest Records to the Twentieth Century (New York: American Water Works Association, 1949), p. 333.

the first use of chlorine gas on the effluent from a working-scale water filter, to reduce the bacterial count. The first permanent water chlorination plant was installed at Middelkerke, Belgium, in 1902. Before passing through gravity filters, chloride of lime and perchloride of iron (0.2 and 8 ppm) were introduced through drip cocks. In 1909 liquid chlorine was first produced commercially in the United States. In 1912 Dr. George Ornstein developed the process in which chlorine gas is first dissolved in a stream of water before introduction into water to be treated. Chlorination has also been used in combatting algae growths, and improvements in methods of use have aided in combatting associated odor and taste problems.

Ozonation for water treatment began about the same time as chlorination did. It has been used more extensively in France than in perhaps any other country. As a process ozonation has been more expensive and complicated than chlorination to install and operate; however, one advantage of ozonation is that it does not aggravate taste and odor problems as chlorination sometimes does. In the development of ozonation in the United States a small pilot plant was operated at Whiting, Indiana, in 1938-39, and a 3.5 mgd ozonation plant was installed there in 1940. The pre-ozonating plant included: an electrostatic air filter, air dryer, air compressors, ozonators (for production of the ozone), meters, and two ozonizers (for introduction of the ozone-filled air through porous tubes into the supply to be treated).

The earliest reported statements of the bactericidal action of ultraviolet rays was made in 1877 by two English scientists, Downs and Blunt. In general, this mode of treatment has proved too expensive for

municipal installations and has found limited adoption for some ships, industrial concerns, and swimming pools.

In general, use of heat for large supplies has proved too costly a method of treatment, though after discovery of the principles and properties of heat transference, apparatuses were applied in a few special cases beginning about 1888 by Charles Herscher. After studies in 1904 by George Thomas Moore and Karl F. Kellerman in the United States, copper sulfate was accepted as an effective germicide and algae-cide. It has also been determined that small quantities of silver in water would destroy some macro- and micro-organisms.

Algae Control. In 1676 the Dutch naturalist Antony van Leeuwenhoek observed living creatures in rainwater which he called animalcula. In 1693 Dr. Edward King observed that a small amount of sulfuric acid introduced into water containing "some hundreds of these animalcula . . . very nimbly frisking about causes them to spread themselves, and tumble down seemingly dead."<sup>2</sup>(p. 391) In 1757 Dr. John Rutty of England reported five drops of hydrochloric acid would destroy the animalcules.

James Peacock who in 1791 was granted the first British patent on a process and apparatus for water filtration designed a process in which the raw water vessel discharged into a bag or strainer which collected "innumerable green filaments" which "coalesce and form a tough mucus" causing "disagreeable effects."<sup>2</sup>(p. 73) Peacock stated that this phenomenon did not occur unless the water was exposed to the sun.

In 1821 Toulouse, France, constructed a filtration basin in which problems were experienced with "aquatic plants." These "plants, these animals, died and putrefied in a water lukewarm, making it very bad."<sup>2</sup>(pp. 275-277) It was not possible to cover the basin because of

its size; thus it was converted into a filtration gallery after which there were no further problems. Toulouse was the first large-scale example of difficulty in a public water supply from tastes and odors and of the solution by excluding light and air.

Another filter basin put into use in Nottingham, England in 1831, likewise experienced growths of algae. The problem was handled there by pumping out the water and sweeping the bottom with a broom at three-week intervals in the summer and six-week intervals in the winter.

To avoid the occurrence of "vegetation" Edwin Chadwick suggested that where water was gathered from areas underlaid with granite or like material, the overlying vegetable matter should be stripped. This anticipated stripping of the sites of large storage reservoirs practiced in the United States a few decades later.

In 1896 Charles P. Allen, Chief Engineer of the Denver Union Water Company experimented with different linings of reservoirs, concrete, asphalt, and earth. The various linings made little difference in algae growths.

George T. Moore and Karl F. Kellerman reported in 1904-05 on studies which had begun in 1901, that copper sulfate was an efficient algicide. Within a few years algae control was effected by application of copper sulfate from boats by spraying or by filling bags and immersing them in the water. In 1935 the Los Angeles Bureau of Water Supply introduced the broadcasting of copper sulfate crystals. By using crystals of various sizes, the chemical would reach the surface as well as lower layers.

In 1924 at Huntington, West Virginia, artificially created turbidity was introduced as a treatment for algae. The turbidity provided a nucleus for flocculation and sedimentation of the organisms.

Prechlorination of water before slow sand filtration was introduced by Ilion, New York, in 1929, to prevent algae growth on the filters. Chlorination rates of 20 to 30 pounds per million gallons were used.

Taste and Odor Control. The first attempts at taste and odor control date from prehistory and involved boiling the water. Hippocrates suggested boiling to prevent odors, in the fifth century B.C.

Aeration has been used for taste and odor removal or prevention for millennia, with the first-known apparatus for artificial aeration appearing in 1755 as described by Hales. Various types of cascade, jet, and other open-air aerators were developed. Pan aerators with or without coke fillings were used at Winchester, Kentucky in 1901 or 1902.

Use of charcoal for taste improvement is also lost in prehistory. In 1790 Johann Tobias Lowitz, a Dutch chemist, announced that powdered charcoal aided in preventing or removing bad tastes and odors. In 1807 Cavallo, an Italian, proposed adding powdered charcoal to water, agitating, and then filtering. Since the 1920's activated carbon has been used.

Algae and other organisms can produce tastes and odors. Methods for control of algae are discussed in a separate section.

Chlorination for disinfection sometimes produced an odor problem, particularly when chlorine was added to water supplies containing phenols as chlorophenols were produced which are highly odorous compounds. Joseph Race at Ottawa in 1917 applied ammonia with chlorine to reduce end tastes, and it was later determined that this combination also prevented end tastes or odors occurring as a result of the presence of phenolic compounds.

In 1926 Toronto began what was called superchlorination. It was found that if enough chlorine was added so that practically all of the residual chlorine was "free" (chlorine, hypochlorous acid, and hypochlorite ion) instead of "combined" (chloramines) end odors would be destroyed. In 1928 R.D. Scott reported the phenomenon which is the principle behind this type of chlorination, and which gave the method the name, "break-point" chlorination. It was found that as more chlorine was added, the residual chlorine at first increased, then decreased, and then once again began to increase. The idea with superchlorination was to add sufficient chlorine to pass beyond the breakpoint in the curve, to the side where the residual once again began to increase.

In 1930 and 1932 ozonation was applied to taste and odor control at Hobart and Long Beach, Indiana, and at Whiting, Indiana, in 1940.

Aeration. The value of aeration as a method of water treatment has been known, and aeration has been practiced since very ancient times. James Lind, a British naval surgeon and hygienist, proposed in the mid 1700's the removal of hydrosulphuric acid and volatile organics by passing water through a perforated plate so that it would fall through the air in finely divided streams. The earliest known cascade aerator working in series was installed in 1848 near Glasgow, Scotland. The water treatment system consisted of five units, the settling reservoir, three filters, and the clear-water reservoir, all arranged in stair-step fashion. Between each unit there was a cascade down to the next unit. The first known aerator on an American water supply was installed at Elmira, New York in 1860-61. It was of the fountain jet type.

Professor Albert R. Leeds in 1884 was granted U.S. patents on saturating water with oxygen or ozone by introducing air under pressure into water under pressure and in motion. The object in using pressure was to force the oxygen into solution in order to restore oxygen stored in reservoirs or when covered by ice, as in a stream. The method shown in the patent was the introduction of the air into the lower end of a pump line delivering water into a reservoir through a submerged opening. John W. Hyatt was granted a U.S. patent in 1885 on a device for sucking air into and mixing it with water in its downward passage through a group of tubes. Other methods of aeration have included the use of weirs, pans with or without coke, and multiple spray nozzles discharging not far above the surface of a reservoir.

As developed in the twentieth century, aeration continued to have as its objective the removal of odors plus the additional objective of aiding in iron and manganese removal. A previous objective, the removal of organic matter, was given up in the case of drinking water treatment.

Distillation. Ancient writers recorded that the vapors which rose from bodies of water were purer than the original bodies of water themselves. Rainwater, regarded as condensed vapors, was thus a preferred supply. Aristotle (384-322 B.C.) wrote that when sea water was evaporated, the vapors obtained were purer than their source. Jabir Ibn Hayyan, an Arabian alchemist of the eighth century A.D. wrote the first treatise on distillation. He described various apparatus, and defined distillation as "an elevation of aqueous 'Vapours' in their 'Vessel'," some by means of fire and some without use of fire. In the late sixteenth century the British patent office first began to issue patents for distillation, mainly for salt water aboard ships.

In 1767 Dr. William Heberden of England wrote that to improve the taste of distilled water, it could be allowed to stand, or boiled in an open container, or air could be forced into it, in order to replenish the oxygen which had been lost in the process of distillation. During the last half of the nineteenth century the use of distillation continued to be limited mainly to ships and naval bases.

Softening. Calcium, Ca, and magnesium, Mg, cause by far the greatest portion of the hardness occurring in natural waters. These cations can be associated with carbonate,  $\text{CO}_3^{=}$ , and bicarbonate,  $\text{HCO}_3^{-}$ , anions or with other anions. On a small scale, if not by name, softening has been practiced through the centuries ever since soap came into use. In 1756 Francis Home, a Scotch physician, published a book on his studies on water softening. They appear to have been the first scientific experiments on water softening, and he seems to have been the first to suggest that water softening be applied to municipal supplies. The softening agents he proposed were alkaline salts, and his measure of the hardness of a water sample was its soap curdling point.

One of the pioneers in the field of water softening was John Rutty of England. In 1757 he wrote that one method of softening was to introduce an alkaline compound such as "the ashes of green ash or beech burnt to a whiteness."<sup>2</sup>(p. 418)

In 1830 in Britain Abraham Booth wrote a treatise on softening and related topics in which he stated that "simple boiling will soften waters whose hardness consists of the carbonates of lime [Ca] and magnesia [Mg] . . . for as the carbonic acid is expelled . . . the earth subsides, . . . [but this] will not remove sulphate of lime [Ca], and, as this is almost constantly present in water, boiling is but a



partial mode of purification. . . ."2 (p. 419) (In the past, carbonate hardness has been called temporary hardness, while non-carbonate hardness was formerly called permanent hardness because it cannot be removed by boiling.)

In 1841, Thomas Clark, Professor of Chemistry in Aberdeen University, Scotland, announced what was called the Clark lime process and was granted a British patent. He claimed that his excess lime method would also work to purify the water. His patent covered the use of lime,  $\text{CaO}$  or  $\text{Ca(OH)}_2$ , to precipitate  $\text{CaCO}_3$ , followed by sedimentation or by sedimentation and filtration.

The first plant for softening of a municipal supply was completed at Plumstead, England, at the end of 1854. The ratio of slaked lime to untreated water was one to eight or one to nine. The lime sludge was sold to bristle manufacturers.

John Henderson Porter, a London civil engineer, took out a British patent in 1876 which proposed to use the precipitate resulting from the Clark process as the medium of filtration by retaining it on filter cloths.

After completion of the Clark process, the treated water still contains some magnesium hardness, and non-carbonate calcium hardness. A. Ashby was granted a British patent in 1878 which claimed removal of these types of hardness from water which had already been subjected to Clark's Process. The method in the patent proposed to add sodium carbonate to precipitate the remaining hardness. In 1891 William Lawrence took out a British patent which included the antecedent of upward-flow reaction and sedimentation, a notable development when applied to water softening practice.

In 1897 at the water works of Swadlincote and Ashby softened water was recarbonated by means of coke to remedy the problems associated with excess causticity. Later, practically all softening plants were equipped with recarbonation devices.

In 1903 Robert Gans was granted a German patent for what was to be called the zeolite process of water softening. This development included the use of "a form of artificial zeolites" created by fusing "clays and soda ash [ $\text{Na}_2\text{CO}_3$ ], and hydrating them."<sup>2</sup>(p. 436) Use of these zeolites removes the cations causing hardness and replaces them with sodium cations.

Iron and Manganese Removal. In 1868 B. Salbach in Germany stated that groundwater could be freed from iron and manganese by aeration followed by filtration through gravel and sand. Through aeration the iron and manganese compounds were oxidized to form insoluble compounds which could then be removed by filtration.

Charlottenburg, Germany, was the first city to build an iron-removal plant, in 1874. In 1942 a plant in Etobicoke in Canada was using zeolite for both softening and iron removal. Ion exchange has been used for manganese removal as well as for iron.

Desalinization. Various forms of distillation have been used, as well as electrodialysis, freezing, reverse osmosis and ion exchange.

#### STORAGE IN CISTERNS

Water stored in cisterns benefits from the sedimentation process. In Palestine and Syria there were numerous cisterns which received activity from early times in the conservation of water supplies. Most of the cisterns in Jerusalem were of four types:

(a) small cisterns each consisting of a long shaft cut through the rock, with a bottle-shaped excavation to collect the water at the bottom--a type, up to twenty feet or so in depth, attached to houses or groups of houses in Palestine even in Canaanite times, (b) large excavations beneath the surface, roofed with the natural rock, some measuring up to forty feet from floor to ceiling, (c) cisterns of Herodian or later date where the rock has been cut down perpendicularly and an arch, or roof of masonry, built over the excavation, and (d) cisterns of more modern construction dug out of the rubbish and lined with masonry, which are supplied by rain collected on the roofs and terraces of the houses.<sup>19</sup>(p. 49)

The best known of "Phoenician" waterworks were those of the city of Carthage, where two groups of cisterns were constructed to catch and hold rain water. The construction was of rubble lined with cement. The first group was 139 meters long and 37 meters wide, barrel vaulted and divided into eighteen compartments, in parallel rows opening on to a common "corridor." The compartments are each nearly 100 feet long by 20 feet wide, and 27½ feet high. The other group was larger.

From the fifth century to the eighteenth century Venice depended on water stored in hundreds of cisterns. Large storage reservoirs such as those found at Carthage were not possible due to the situation of the city on islands.

At Byzantium in the sixth century, Justinian had two great underground cisterns built. One, the "Hall of a Thousand and One Columns" was built in 528 A.D. The structure is in two stories, and the domed roof is supported by sixteen rows of fourteen columns each. The other, Yeri Batan Serai, was still being used to hold the water supply of Constantinople in the middle of the twentieth century. Like the other, it is filled with decorated columns and has the appearance of a cathedral filled with water, rather than a cistern.

## DISTRIBUTION AND USE

In many urban areas, distribution of water has been carried out by means of porters or carts prior to the introduction of piping. Before Roman times, where public water supply systems were to be found, water was generally distributed to only a few public fountains. Even in the Roman Empire, distribution to private homes was quite limited. In Europe during the Middle Ages water was usually obtained from public fountains or carriers, and not until the 1600's did piped private supplies begin to be introduced. Some cities have utilized dual supply systems, one system providing potable water, and the other system providing water for street washing, fire-fighting, and similar purposes.

Where piped supplies of drinking water were intermittent, there were associated problems. In 1849 the first Medical Officer of Health of the City of London reported:

I consider the system of intermittent water supply to be radically bad; not only because it is a system of stint in what ought to be lavishly bestowed, but also because of the necessity which it creates that large and extensive receptacles should be provided, and because of the liability to contamination incurred by water which has to be retained often during a considerable period. In inspecting the courts and alleys of the City, one constantly sees butts for the reception of water, either public, or in the open yards of the house, or sometimes in their cellars; and these butts, dirty, mouldering and coverless, receiving soot and all other impurities from the air; absorbing stench from the adjacent cesspool; inviting filth from insects, vermin, sparrows, cats and children; their contents often augmented through a rain pipe by the washings of thereof, and every hour becoming fustier and more offensive. Nothing can be less like water should be than the fluid obtained under such circumstances.<sup>15</sup>(p. 52)

People in villages and cities of ancient times probably did not use over three to five gallons per day per person. However, Clemens Herschel estimated that the average quantity of water delivered to Rome by the aqueducts was in A.D. 97, about thirty-eight million gallons

per day or thirty-eight gallons per capita day.<sup>13</sup>(pp. 240-241) Bath and shower facilities are dependent on constant pressure water supplies and sewerage facilities. Public baths and latrines have been useful in areas such as ancient Rome where many people lived in tenement-like dwellings and charges for the facilities were kept within the reach of all. In the late 1800's water demands began to increase where there was increased use of bathtubs, water closets, and public bathhouses. In the 1900's further increases in demand occurred where use was made of washing machines, dishwashers, garbage disposals, air conditioners, and lawn sprinklers.

Where metering has been used, it has encouraged conservation of water. In 1835 a metering device was being used which consisted of a hollow drum or wheel divided into sections. As the wheel rotated each compartment would fill with water and then be subsequently emptied. The number of revolutions was recorded through a system of gears. This is much like the modern water meters, except that the wheel rotated in a vertical rather than horizontal plane.

One type of use of domestic water supplies which involves significant quantities of water, is represented by latrines or closets, which have been provided in certain communities since ancient times. Around 2500 B.C. in the Indus Valley (now Pakistan) at Mohenjo-daro, one of the largest towns of that time, every house had a latrine. In Egypt around 1350 B.C. there were latrines which employed earthenware jars as receptacles. Many larger Greek towns of the first century B.C. had public and private lavatories with water flushing facilities. This was usually a channel with a continuous flow of water. In Rome in the fourth century A.D. water flushing of latrines became prevalent and much use was made of wastewater from the public baths. In 315 A.D. Rome is reported to have had 144 public

latrines, or about one for every 5,000 persons. A continuous flow of water in channels was used.

In London during the middle ages, public latrines were built which were flushed by water courses. Toward the end of the thirteenth century private latrines became common, constructed along water courses. When the number increased, the disposal was diverted from open water courses to privy vaults and cesspools. By 1500 in England, most townhouses had only a privy in the yard consisting of an open pit under a wooden seat in a little shack. A type of water closet was first described in 1596, in a poem published by an Englishman, Sir John Harrington, though this device had nowhere come into general use until the eighteenth century, and in the early years of that use, certain of the municipalities involved did not permit the use of municipal supplies of water for the operation of water closets. By 1700 the wealthier class in Britain made use of a "close-stool" which was kept in the bedroom. This was a box fitted with a padded seat and enclosing a pot which was emptied by the servants.

The first types of water closets included the long hopper, and the pan closet. The latter originated in London in 1852. The plunger closet received a U.S. patent in 1857. This was the first patent in the United States for a water closet. In 1775 a watchmaker, Alexander Cumming, took out a British patent for a valve closet, consisting of a cast-iron bowl with a valve at the base which could be opened by a plunger to release the contents through an inverted siphon. The water for flushing came from a cistern overhead, while the effluent was discharged into a cesspool under the basement or in the yard of the house. In 1778 Joseph Bramah took out another patent for a valve closet

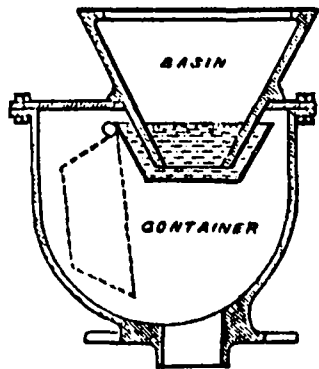

Fig. VI.11. Pan closet.

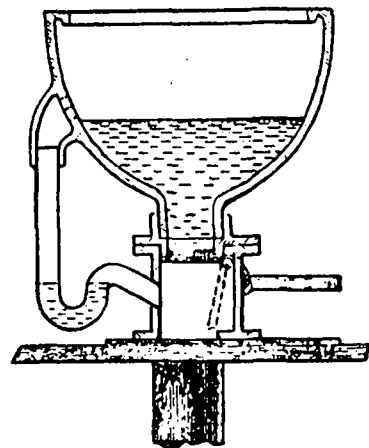

Fig. VI.12. Valve closet.

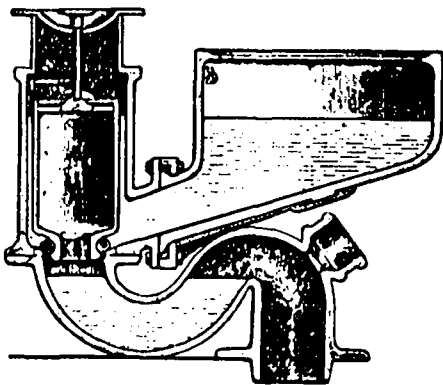

Fig. VI.13. Plunger closet.

SOURCE: Thomas S. Ainge, The Sanitary Sewerage of Buildings (Chicago: Domestic Engineering, 1907), pp. 102, 104, 105.

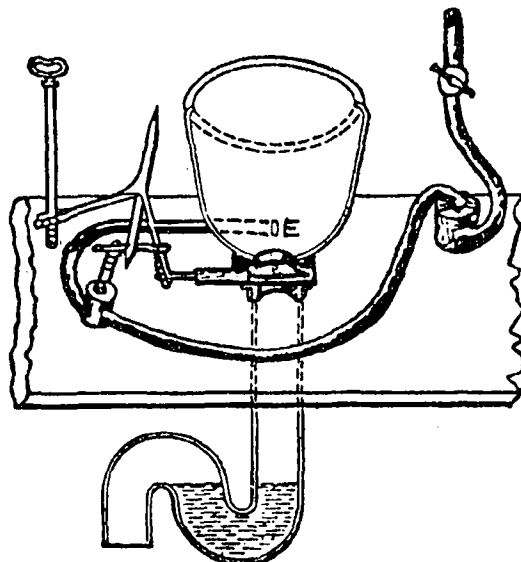

Fig. VI.14. Cumming's valve closet, 1775.

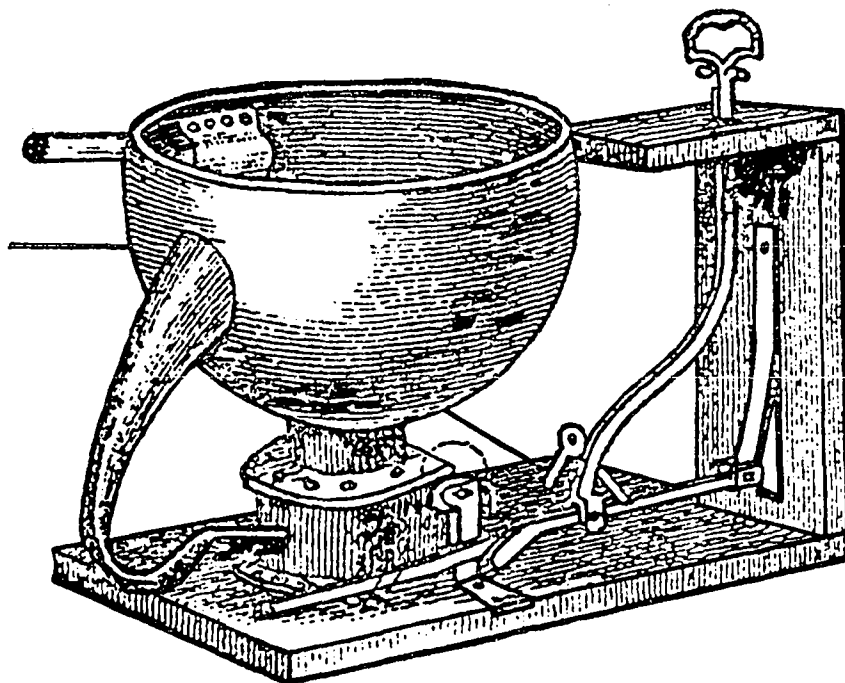

Fig. VI.15. Bramah's valve closet, 1778.

SOURCE: F. L. Small, The Influent and the Effluent: The History of Urban Water Supply and Sanitation (Manitoba, Canada: Underwood McLellan and Associates, Modern Press, 1974), pp. 198, 199.



with a different design. By 1815 this was the accepted type. As late as 1937 the valve closet was recommended by some for situations in which no flushing cistern was required. Other earlier types of water closets included the short hopper and the washout closet. In 1782 in London, a trap was devised using a water-seal. In 1852 Josiah G. Jennings made the first wash-down closet. The siphon closet was developed and perfected in the United States.

#### SEWAGE REMOVAL AND TREATMENT

Throughout history the urban environment has been in general quite unsanitary, and progress in correcting the situation has been very slow. Problems increased with growing populations. In Europe by the seventeenth century improvements were needed, and by the second half of the eighteenth century some urbanized areas became decidedly unhealthy places. In the United States by the middle of the nineteenth century the major cities were overcrowded and unsanitary, and there were frequent epidemics of yellow fever, cholera, and typhoid in the middle years of that century. In some of the developing countries, the mortality rates from enteric diseases are in the same range as that which was true in North America in the last period of the nineteenth century.

The proper removal and treatment of sewage or excreta has provided a principal part of the remedy for this situation in those parts of the world where it has been adopted. Information on the following items is included below: methods of removal or treatment utilizing no water or small amounts of water, removal by water carriage, and treatment of sewage from systems using water carriage. In general, it may be said that sewage systems using water work

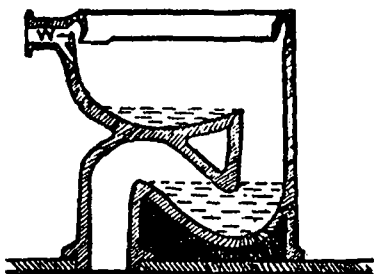

Fig. VI.16. Wash out closet.

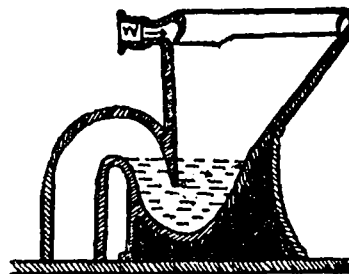

Fig. VI.17. Wash down closet.

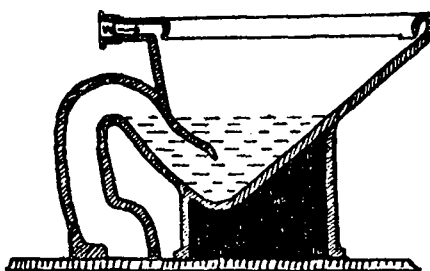

Fig. VI.18. Siphon closet.

SOURCE: Jean Broadhurst, Home and Community Hygiene: A Text-book of Personal and Public Health, 4th ed. rev. and enl., Lippincott's Home Manuals, ed. Benjamin R. Andrews (Philadelphia: J. B. Lippincott Co., 1929, pp. 240, 241.

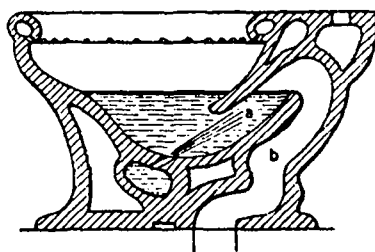

Fig. VI.19. Siphon jet closet.

SOURCE: Charles Merrick Gay and Charles De van Fawcett, Mechanical and Electrical Equipment for Buildings (New York: John Wiley & Sons, 1935), p. 84.

well in urban areas with high density populations where there is an abundant and constant supply of cheap water, and where there is sufficient wealth available to pay the costs of installation and upkeep. Virtually all the conventional types of sewage treatment, chemical and biological, used in developed areas today were introduced within the last one hundred years.

Solid Waste Collection by Private Contractors. In the 1800's and earlier throughout the Middle Ages in England and the rest of Europe, solid waste was heaped up in piles in the streets, paved or unpaved, and around the homes of city dwellers. Some was sold for agricultural purposes. In the wealthier parts of towns private contractors collected the refuse periodically. In the early fourteenth century London was the first European city to set up an organized scavenging system.

Composting. Composting is an ancient method, but at least one modern-day application may be mentioned. In 1957 on the island of Jersey in the English Channel a composting plant was built consisting of a tower of six floors. In this type of plant aeration occurs as the refuse and sludge fall slowly down through the floors, and aerobes assist in decomposing the mixture. The finished product is used as fertilizer.

Cesspools. At the close of the Middle Ages in Britain much of the human wastes were being directed to privy vaults or cesspools, and thence percolated into the porous layer contaminating well water. By 1775 in Britain the effluent from water closets was being discharged into cesspools under the basements or in the yards of the houses.

Septic Tanks. Septic tanks were first introduced in France about 1869, and in the United States in 1884. In England in 1896 Donald

Cameron, city surveyor of Exeter, announced that sewage could be held in an airtight tank for a day or so and that this reduced the organic content. He called this a septic tank.

The process in the septic tank utilized the action of anaerobic bacteria. Disposal of effluent from this unit is now usually accomplished by cesspool or soil percolation through open-jointed clay pipes.

Drains and Sewers. There are really two types of processes involved, one the transportation of stormwater, and second the transportation of sanitary flow. In Mesopotamia in the fourth millennium B.C. open ditch and rough stone-lined channels drained stormwater. At Chandu-daro, Sind (third millennium B.C.) as well as at Mohenjodaro and Harappa there were found excellent sanitary systems to which an adequate water supply would have been essential. The cities of Babylon and Jerusalem had sewers cut in rock or built of masonry dating back to the eleventh century B.C. Cylindrical sewer pipes were in use in the seventh century B.C. at Babylon and Ninevah. The Greek city of Olynthus, planned in the Macedonian Period (380-130 B.C.), was provided with a central paved alley five feet wide in each city block to provide drainage. A channel in the floor was for dry weather flow. Covered brick masonry drains were in each street. Each house was connected to the drains with a small sump chamber of brick masonry to collect sedimental material. Lime-mud mortar was used. Sewers were common in the time of Rome. The famous sewer of ancient Rome called the Cloaca Maxima was built about 588 B.C. Only wealthy people had private sewer connections. No drainage systems rivaled those of Rome until the nineteenth century.

In most urban areas of Europe during the Middle Ages the drainage systems were often clogged because of refuse and lack of water to provide flushing. By 1800 in cities of Europe and the United States, it was becoming common to discharge domestic wastes to storm sewers. This was the "combined" sewer system.

By 1841 in London there was no over-all planning in the construction of sewers, and most were square brick tunnels with flat bottoms and no fall. One medical officer wrote: "The sewer in Friar Street has a most curious quality, that of flowing either way equally well."<sup>18</sup>(p. 11) Such sewers were really elongated cesspools. Little water was used; thus the sewers were made quite large so that cleaners could enter them. Subsequent to the period described here John Roe designed the egg-shaped sewer.

In the middle of the nineteenth century came the concept of a separate sewerage system to carry only water-borne human wastes. This was a major advance in urban sanitation. In Hamburg, Germany, was introduced the first complete sewer system which was flushed thoroughly with water every week. The first large modern sewers were at Hamburg (1844-48) and London (1854-65). In London the pumps used were steam-driven double-acting beam engines, driving ram or plunger pumps. The last of these sewage pumps was not replaced until 1952.

In the United States, street drainage was usually by means of a ditch along the center of the street. New York had only two public sewers before 1720. In 1860 there were only ten sewer cities in the United States.

Garchey System--Modified Water Carriage System. A French

Engineer, Louis Antoine Garchey designed a system in which a three-gallon cast iron container was fitted beneath a sink,

with an eight-inch outlet covered by a removable disc. Refuse dropped down the hole in the sink and mixed with waste water. The container was similar to a valve closet and by pulling a plug the contents could be flushed into a six-inch vertical pipe resembling a soil-pipe.

An eight-inch earthenware drain led to collecting chambers. Finally the refuse was partially dried by rotating it in extractors like large spin-driers. The water passed to the sewer and the solid refuse was incinerated.<sup>18</sup>(p. 61)

The system was first installed in a housing development near Paris. The first British Garchey system was installed in 1935.

Effluent Standards. In 1912 in Britain the Royal Commission on Sewage Disposal proposed standards for sewage effluents in its Ninth Report. When effluents were to be discharged into rivers where dilution would be less than eight to one, the Commission recommended that in the effluent, "(1) suspended solids should not exceed thirty parts per million, and (2) not more than twenty parts per million of dissolved oxygen should be absorbed in five days at 65° F."<sup>18</sup>(p. 30) The later restriction refers to the test for "biochemical oxygen demand" or BOD test.

Sewage Farms and Land Application of Sewage. In ancient Greece, cities which had drainage systems often spread the effluent over wide areas of ground for irrigation. Following recommendations of the Health of Towns Act in 1888, some towns in Britain operated sewage farms, growing grass, mangolds, cabbage, and willow. The produce from these farms was generally unpopular in the vegetable markets. Among the disadvantages associated with land application is the fact that it may be necessary to store the sewage during

cold weather months for spraying on fields later during warmer weather. The large areas of land required with this method represent another potential disadvantage. The use of a drainage system can help to prevent the types of problems related to salt build-up and waterlogging of the soil.

Chlorination and Ozonation of Sewage. Experimental application of chloride of lime was made to London sewage in 1854 and 1884. On January 27, 1887, a British patent was issued on an electrolytic method of purifying sewage. The electrolytic processes which were developed each operated on the principle of producing a chlorinating or oxidizing agent which could then be applied to the sewage.

On May 10, 1887, the first United States patent on chlorination of sewage was granted to J.J. Powers. His apparatus was to generate gaseous chlorine from manganese dioxide, sodium chloride and sulfuric acid.

Contact Beds. This type of treatment appeared in the 1880's. Crushed rock or slag is placed in watertight tanks. The beds are operated by the fill and draw method and require removal of accumulated solids. Limitations include the frequency of clogging, the longest period required, and the relatively low loading that can be used.

Sewage Trickling Filter. In 1871 in Wales the first intermittent sand filtration process was placed in operation. William Joseph Dibdin, a London Chemist, in 1882 gave evidence to the Royal Commission on Metropolitan Sewage Disposal that bacteria were important in sewage treatment. He was one of the first to suspect and promote this idea.

In 1887 the State Board of Health of Massachusetts at the Lawrence Experiment Station experimented with Dibdin's idea. Two years later

the board reported that "the mechanical separation of any part of the sewage by straining through sand is but an incident . . . [while] the essential conditions are very slow motion of very thin films of liquid over the surface of particles having spaces between them sufficient to allow air to be continually in contact."<sup>18</sup>(p. 28) However, even the coarsest sand became clogged and useless in a short time.

Dibdin continued experimentation using different media. In 1896 he wrote of his own experiments explaining that a very coarse medium was needed into which air could pass freely over the slimy deposits of aerobic bacteria which fed on the organic matter in the sewage.

Before the date of Dibdin's publication, about 1893, at Salford, England, one of the earliest of the trickling filters was installed. Trickling filters are self-cleaning units from which settleable solids pass out with the effluent to settling tanks. The first trickling filter treatment plants in the United States were introduced in 1894.

Activated Sludge Process. In 1912 Dr. Gilbert Fowler and his assistants in the Manchester Rivers Department discovered what is now known as the "activated sludge" process. They aerated sewage in bottles for a period of time, withdrawing at the end a clear liquid and leaving a brown deposit. When raw sewage was replaced in the bottles with the deposit, the liquid became clear in a shorter time than before. This process involved the production of an activated mass of organisms which were capable of aerobically stabilizing a waste. Two processes came to be used to provide air for the bacteria, the diffused air process, which forced air into the bottom of the tank,



and surface aeration which introduced air by moving paddles at the surface.

Refinements of the 1940's included tapered aeration and step aeration which made better use of oxygen throughout the aeration period. Other refinements developed are high-rate aeration, bioabsorption, and extended aeration. Extended aeration lowers the rate of sludge production.

Sewage Lagoons or Stabilization Ponds. This form of treatment has been widely adopted in recent years. These lagoons can be anaerobic or aerobic. Artificial aeration can be utilized, and this type of unit is closely related to the oxidation ditch. For more complete coverage of this topic see p. 439 below.

#### ADMINISTRATION AND FINANCING OF WATER SUPPLY SYSTEMS

The Greek philosopher Plato (427-347 B.C.) suggested that a city water supply be administered by a group of water commissioners representing individual districts. He also recommended regulations governing water use as well as penalties.

Frontinus, as water commissioner of the City of Rome around 97-104 A.D., headed an organization run by the government, and one which was quite well developed. Of great importance in the growth and maintenance of these systems and of those found throughout the Empire, were the funds provided by the Roman governments and Emperors.

During the Middle Ages in Europe, the decline in urban populations decreased tax revenues, and monasteries came to be leaders in providing water supply, and sanitation facilities. Late in the Middle

Ages cities again began to grow and local municipalities took over leadership from the monasteries.

In Europe after the Middle Ages and up to the eighteenth century, with rare exceptions the costs of water supply were borne by the Church or by burgesses of the municipality. In the eighteenth century private enterprise began to enter the field of urban water supply.

In modern times Great Britain and the United States have played a leading role in the development of public water supplies. However, the pace of development of urban water supply facilities did not pick up in Europe and the United States until the nineteenth century. By 1800 London, Paris, and Rome were nearly the extent of water supply facilities in Europe at that time. By 1810 there were several private companies serving London. In that year they decided to divide the areas served between them and to increase the rates, which aroused complaints of monopolistic practices. Later, complaints and difficulties arising from the poor quality of water supplied led to successive hearings and attempts at certain reforms. Among these were the Waterworks Clauses Act of 1847, and that of 1863, which introduced the principle of compulsory supply. In 1867 the water used in London was supplied by nine companies. It was not until 1902 that the Metropolitan Water Act authorized the Metropolitan Water Board and directed that London's water finally come under public control, a matter which was accomplished in 1904.

In 1800 Boston, Philadelphia, and New York were nearly the extent of public water supply facilities in the United States at that time. In the United States at the end of 1830 there were only forty-four cities with public water supplies. Most of them were small gravity

water works, and none included filtration. As public water supplies in the United States developed, public ownership became the norm.

HISTORICAL DEVELOPMENT IN GREAT BRITAIN  
(EMPHASIS ON LONDON) AND THE UNITED STATES

Great Britain. Britain, and particularly London, were selected for a developmental summary because they present the oldest of the modern systems for which the information available for this research was most complete.

The early civilizations which developed in Egypt, Crete, Persia, northern India or Pakistan, and China, each at some point attempted to provide for water supplies and drainage systems. In Europe after the decline of the Roman civilization, the principles of town sanitation were widely ignored. Beginning in the twelfth century, as towns began to increase in Europe, liquid wastes from the towns were being drained into ditches and moats, while solid wastes were piled in the streets and sometimes sold for agricultural purposes.

At the beginning of the sixteenth century a house in a British town would have had no water pipes and no drainage. In the yard would have been located a privy consisting of a large pot under a wooden seat in a little shack. By 1578 London was one of the largest towns in Europe, with a population of about 100,000. Sources of water at that time included the river, public conduits supplied by springs, and water sold by porters. In 1580 Peter Morice, a Dutch engineer, built two wooden force pumps under London Bridge which were driven by a water wheel. The river water was pumped through a wooden pipe which could be tapped by lead pipes to run water to the yards of some private homes. In 1596 Sir John Harrington, a poet, published a book containing a poem in which was described something which we would

now call a valve water closet. It was presented by him and treated at that time as something of a joke.

By 1700 in an English townhouse of the upper classes, the owner and his family no longer made use of a privy in the yard, but rather a "close-stool" which was kept in the bedroom. This was a box with a padded seat and a pot inside, the contents of which were emptied by the servants. In 1775 a watchmaker, Alexander Cumming, invented a type of valve closet, consisting of a cast-iron bowl with a valve at the base which could be opened by a plunger to release the contents. The water for flushing came from a cistern overhead, while the effluent was discharged into a cesspool under the basement or in the yard of the house. In 1778 Joseph Bramah took out another patent for a valve closet with a different design.

By the last quarter of the eighteenth century there was culminating a change in life-style in Britain, a movement from the country to the city, and from the farm to industry. Before that time, most people in Britain had worked in agriculture. Water power had limited the size of industries; pack horses had been used to distribute goods; and since the introduction in Europe of blast furnaces in the fourteenth century, small amounts of iron had been smelted with the use of charcoal. In 1711 in Shropshire, coke had begun to be used by Abraham Darby and his son to smelt iron (from about 1750 cast-iron pipes had begun to replace wooden pipes for water mains); in 1712, Thomas Newcomen had pumped water from a coal mine with the use of a steam engine; in 1759 a canal had been built; and in 1781 James Watt had improved the steam engine to supply rotative power. Thus, by the last quarter of the eighteenth century industry and towns began to grow rapidly. London's population increased from 1.5 million to 2.5 million between 1831 and 1851.

Due to the growth of towns and the beginning popularity of water-closets in the early 1800's, more sewage and other wastes were being dumped into rivers from which water supplies were subsequently drawn. Solid waste was still left piled in streets and yards and was collected in wealthier parts of town by private contractors. Before 1815 in London laws prohibited the discharge of any waste other than kitchen waste into drains. Not until 1848 in Britain did it become compulsory to discharge town sewage into drains. Where privy vaults or cesspools were built or manufactured improperly, they often created a hazard to health.

Early water mains supplied water only intermittently. In 1800 better homes received piped water which was stored in lead-lined cisterns before subsequent use. However, in some poorer areas, one well pump and one privy would serve many houses. The poorer classes had great difficulty to wait at the public standpipes at the appointed hours to obtain the water and then to store it, so that they most often did not have sufficient supply. Sometimes a great number of people had to provide themselves water from taps which flowed for less than an hour each day and not at all on some days. In the year 1800 a bath was not often used in Britain. When it was used by the upper classes, it consisted of a portable bath set up in the bedroom which was filled and emptied by the servants.

In 1804 John Gibb, owner of a cotton mill in Paisley, Scotland, began selling water from a sand filter he had built to clean water used for bleaching. The water was delivered in carts for a half-penny per gallon. The first town with a piped supply of filtered

water was Glasgow, in 1807. The early filters were never completely successful because a satisfactory method of cleaning was not then known by the operators. In 1827 a Scottish engineer and mill owner, Robert Thom, built a slow sand filter cleaned by reverse flow wash, and in 1829 James Simpson devised a slow sand filter which was cleaned by scraping the surface of the sand with spades. These developments in filtration were too late to be of use during the first epidemic of cholera to sweep Britain, but in the three epidemics which followed, doctors noted that those areas served by filtered water suffered fewer cases of cholera.

Before 1817 there had been occasional outbreaks of cholera in India, but in that year it began spreading across the world. In October 1831 cholera reached Britain and produced the first epidemic there killing thousands of people. In 1831; no one knew how to prevent cholera. Now it is known that an essential element in the prevention of epidemics of that disease is a good water supply. Three later cholera epidemics were to occur in Britain, in 1848-1849, 1853-1854, and 1866. Bacterial diseases were another cause of thousands of deaths every year. In general, living in town was much less healthy than living in the country. In 1831 more than twenty persons out of 1000 died in Britain each year and this figure rose as high as thirty or forty per 1000 in some towns.<sup>18</sup>(p. 3)

Edwin Chadwick, prominent among forerunners in urban hygiene, reported in 1842: "The great preventives, drainage, street and house cleaning by means of supplies of water and improved sewerage, and especially the introduction of cheaper and more efficient modes of removing all noxious refuse from towns, are operations for which aid

must be sought from the science of the civil engineer, not from the physician."<sup>18</sup>(p. 7) Since at that time an "engineer" was a military man, the word civil was added to the name to make a distinction for this new profession. Reporting for the Poor Law Commission in 1842, Chadwick recommended measures which may be summarized in part as follows:

- (1) Every town should have a system of pipe sewers with pipe sizes restricted and grades of sufficient slope to give self cleansing velocities. . . . Thus every town and city would have a system of sewers that would afford an efficient means of conveyance, rather than a depository for sanitary sewage.
- (2) Every house should be directly connected to the system of sanitary sewers, and every house should be served by a constant pressure public water supply system.
- (3) Sanitary sewer systems and public water supply systems should be publicly owned. Such systems should be designed by competent civil engineers and should be operated under the direction of appointed water and sewer commissioners supported by adequate administrative and technical staff.<sup>20</sup>(pp. 193-194)

Subsequently, John Roe, engineer to the Holborn and Finsbury Commission of Sewers, designed the egg-shaped sewer to replace the square ones in use, and Henry Doulton produced glazed earthenware pipes for house drainage.

In 1835 after the first cholera epidemic in 1831, a committee appointed by Parliament reported on conditions arising from the fact that the Thames was used both for the disposal of sewage from the City of London as well as for the municipal water supply.

The Thames, to this day, receives the excrementitious matter from nearly a million and a half of human beings; the washings of their foul linen; the filth and refuse of many hundred manufactories; the offal and decomposing vegetable substances from the markets; the foul and gory liquid from slaughterhouses, and the purulent abominations from hospitals and dissecting rooms, too disgusting to detail.

Thus that most noble river, which has been given to us by Providence for our health, recreation and beneficial use, is converted into the Common Sewer of London, and the sickening

mixture it contains daily pumped up with water as a common beverage for the inhabitants of the most civilized capital in Europe.<sup>18</sup>(pp. 21-22)

In 1848 the second epidemic of cholera began in Britain, involving almost every urban region. In London alone there were 15,000 deaths and as many more who fell ill but recovered. It was during this epidemic that Dr. John Snow, a thirty-six year old physician, discovered that cholera was communicated by the mixture of water contaminated by cholera victims with supplies of water used for drinking or cooking. His findings were published in 1849 but were not accepted by the majority of medical men who still believed in the miasmatic theory of communication of diseases. According to this theory, disease was a fever which was brought by special disease-producing airs or vapors.

Parliament enacted in 1848 "that water supplies must be pure, safe, and constant. . . ." <sup>18</sup>(p. 37) However, there continued to be intermittent supplies for many years. In 1848 most municipal water supplies were privately owned and did not operate or improve their services adequately. Thus, efforts were begun by municipal governments in Britain to buy up the companies. However, the eight London water companies had not all come under public control until 1902. A Metropolitan Water Act of 1852 required that all domestic water from the Thames be filtered, but the London water companies were often in violation. The third epidemic of cholera occurred in 1853-54.

In 1858 Louis Pasteur, a French chemist, published his finding of living microscopic beings which required air, calling them aerobes. In 1860 he described microscopic beings which lived in the absence of air, calling them anaerobes. Thus the germ-theory of the origin of disease was advanced.



By the second half of the nineteenth century, some towns in Britain were operating sewage farms for sewage disposal. Generally, a bacterial process was not considered in the experiments with treatment of sewage. Instead, experiments were conducted on filtration of sewage as a purely mechanical process, and on the use of chemicals to precipitate the suspended matter in sewage. Manganate of soda was used on London's sewage in 1885, and chloride of lime in 1887.

The Public Health Act of 1872 required cities of over 25,000 to appoint a medical health officer and inspectors. As a result many wells were condemned because of contamination by sewage, and this significantly reduced urban death rates in England. Beginning in 1875, the number of cases of typhoid fever began to decline, so that after 1900 few cases were reported.

In 1882, William Joseph Dibdin, a London chemist, was among the first to indicate that bacteria were important in sewage treatment; later with some assistance from results of the Lawrence Experiment Station in Massachusetts, he discovered the principles of operation of what later came to be known as the trickling filter. One of the earliest of the trickling filters was installed in 1893 at Salford, England.

By 1890 most British towns had constant supplies of water. Cases of typhoid were still common. A vaccine for this disease was first produced in 1897.

In 1893 pressures and temperatures necessary to manufacture copper pipe by extrusion were reached and copper pipes were used in high-quality plumbing.

In 1896, Donald Cameron, city surveyor of Exeter, discovered the principles of operation of what he called the septic tank.

In 1897, at Maidstone in Kent bleaching powder was put in the water mains to stop an outbreak of typhoid. The first permanent chlorination of a municipal supply began in Lincoln in 1905 using a solution of sodium hypochlorite. The use of chlorine for disinfection of public water supplies was a big step in the hygiene of water. However, chlorination was slow to find adoption in Britain. In London, chlorination was not begun until 1916 and then only to avoid the necessity of undergoing sedimentation before filtration. Bleaching powder was used first and then liquid chlorine in 1917. Ozonation was introduced in Britain at about the same time as chlorination, but never received widespread acceptance there.

Although water carriage of sewage was widely accepted by the end of the nineteenth century, less than ten percent of the residences in the principal cities of England had that facility at that time.

In 1912, Dr. Gilbert Fowler and assistants in the Manchester Rivers Department, discovered what is now known as the "activated sludge" process for treatment of sewage. In that same year the Royal Commission on Sewage Disposal proposed standards for sewage effluents. Where discharge was to be made into rivers where dilution was less than eight times the volume of effluent, no more than thirty ppm suspended solids would be allowed in the effluent, and not more than twenty ppm 5-day BOD would be allowed.

In the 1920's compression joints for piping were developed and in 1934 the capillary joint. Copper piping came into wide use at about the same time. In 1862 Alexander Parkes of Birmingham had discovered

how to make a plastic-like material out of cellulose nitrate. Later the plastic industry developed and plastic waste pipes were introduced in 1944 and water pipes in 1953. Problems were encountered with brittleness in the first attempts.

United States. A brief history of the development of methods of water supply and wastewater disposal in the United States follows as well as an indication of the impact this has had on public health.

Developments in the United States, as in Britain, have represented a leading force in modern systems of domestic water handling.

In colonial America before steam powered water pumping systems were developed, municipal water supplies were ordinarily taken from public wells equipped with hand pumps. As late as 1799, New York obtained its water supply from a well by means of a horse-powered pump. The earliest public water supplies in the United States were to be found in Boston in 1652; Schaefferstown, Pennsylvania, in 1732; and Bethlehem, Pennsylvania, in 1761. By 1800 there were seventeen utilities, in 1850 more than one hundred, and in 1885 more than one thousand. In 1895 there were about 3000, in 1924 more than 9000 and in the 1960's more than 18,000 systems. In 1890 about one-third of the systems were privately owned, but by 1960 more than three-quarters of the people were served by publicly owned systems.<sup>22</sup> (p. 220)

Some of the early public supplies were originally installed primarily for the purposes of street washing rather than for domestic supply. Treatment of the earliest supplies in the United States was directed primarily toward the removal of turbidity, and the ability to perform tests for purity predated their use. The greatest advances in the improvement of quality have been made in the last century. In

the 1870's the first filtration systems in the United States were installed when slow sand filters were built at Poughkeepsie and Hudson, New York. In the late 1880's the earliest rapid sand filtration units were in operation. Chlorination for bacterial disinfection was introduced in 1908. In 1945 three communities were supplied with fluoridated water, and in 1959 the number had grown to over one thousand communities.

One hundred years ago wastewater was often simply poured into street gutters, and cesspools and privy vaults were in common use. By 1957 more than 7500 sewage treatment plants were in operation. An additional 3000 communities had sewerage, but were discharging without treatment.

The diseases which may be water-related range from typhoid fever, amebic dysentery, infectious hepatitis, and schistosomiasis, to others which are too numerous to mention, and all of these diseases were prevalent in the United States in the not too distant past. In some developing countries, mortality rates from enteric disease are in the same range as that which was true in North America in the last period of the nineteenth century. In the United States water purification is one of the measures which has brought water-related diseases under control. In 1900 in the United States, deaths from typhoid fever were 35.8 per 100,000 population. By 1936 the figure had been lowered to 2.5, and it was later diminished to practically zero.<sup>22</sup>(p. 225)

#### LIFE-STYLE LEVELS AND TECHNOLOGY LEVELS AS A CHRONOLOGICAL CONCEPT

In viewing as a whole the material presented above it has been possible to ascertain chronological developments in technological levels as well as in life-style levels. With the aid of the organization

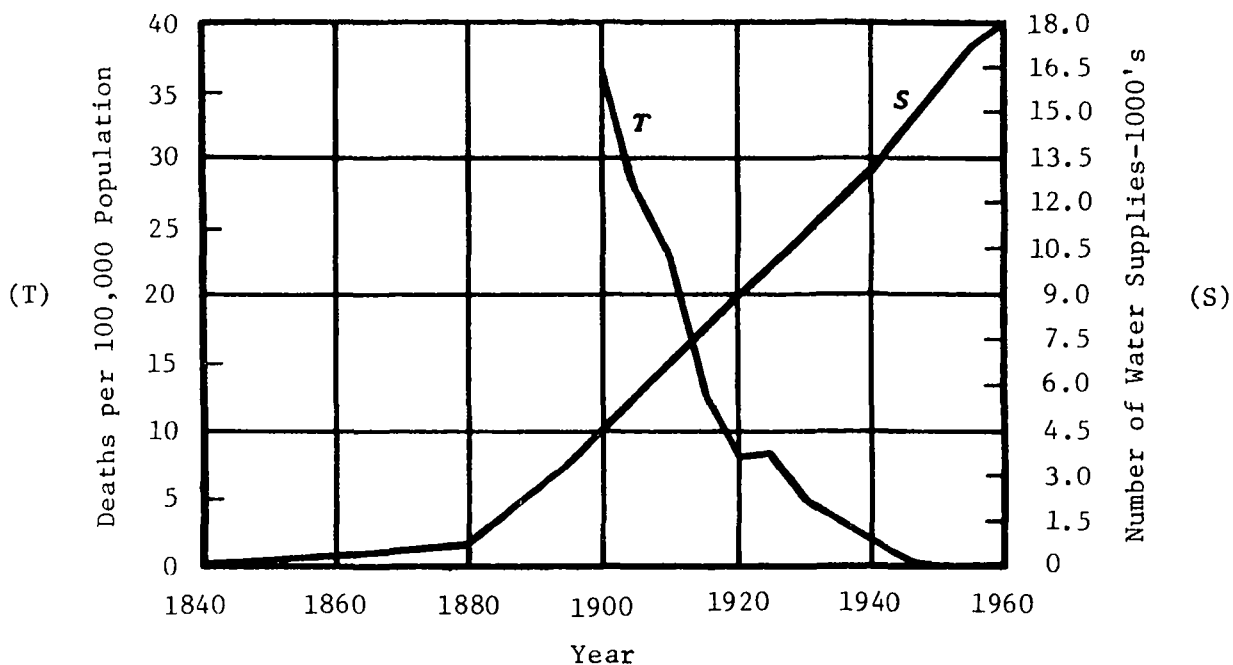

Fig. VI.20. Simultaneous decline in typhoid fever death rate and rise in number of community water supplies in the United States.

SOURCE: Abel Wolman and Herbert M. Bosch, "U. S. Water Supply Lessons Applicable to Developing Countries," Water, Health and Society, ed. Gilbert F. White (Bloomington: Indiana University Press, 1969), p. 225.

of the historical information into Tables VI.1 and VI.2, it was possible to ascertain different levels of technology developing chronologically in the various geographic areas. Six levels were detected, and the main aspects of the classification have been included in Table VI.3. It should be noted with respect to this classification process, that inventions which are listed in the inventory were not put into use immediately. There was usually a certain lag-time between the discovery of a technology and its application. Also, these technology levels are not closed units, each separate from the others. Rather, as new ways of handling water or sewage came into practice, the old ways very often continued to exist along with the new, and the appearance of a new level of technology was often a gradual process, with first one element appearing, to be followed later by others of the same level.

In addition to technology levels, life-style levels could be discerned as a chronological concept. Four levels were defined and the principal aspects of this classification have been included in Table VI.4. Technological progress is linked to demographic expansion, and important as well to the transitions from one life-style stage to another are the processes of urbanization and industrialization. The same process of blurring between levels occurs with the life-style levels as was the case with the technological levels, and interrelationships are evident between the two classifications, life-style and technological.

Subsequent to the previous steps in arriving at life-style and technology levels, an attempt was made to tie historic technology levels to the life-style levels. A time scale, Table VI.5, was developed for three historical regions covered by the inventory. The three regions

TABLE VI. 1  
 CHRONOLOGICAL SUMMARY OF HISTORICAL DATA--MIDDLE EAST  
 (ANCIENT AND MEDIEVAL), INDIAN SUBCONTINENT (ANCIENT), EUROPE (ANCIENT)

Date	Middle East (Ancient and Medieval)	Indian Subcontinent (Ancient)	Europe (Ancient)
4th millennium B.C.	Egypt Mesopotamia Evidence of wells. Open ditches and rough stone-lined channels drained stormwater; privies.		(Crete) Palace of Minos at Knossos Greeks Rome
3rd millennium B.C.		(Chandu-daro and/or Mohenjo-daro) wells of brickwork; public baths; bathroom and latrine in each private dwelling; excellent sanitary systems; pottery drainpipes.	
2750 B.C.	Copper piping.		
2500 B.C.	Drainage systems.		
2500-1200 B.C.			Terra-cotta pipes with cement joints; earliest form of bathtub discovered (earthenware); water-flushed latrines.
2400 B.C.	(Babylonia) possibly earliest use of shaduf.		

TABLE VI.1.1--Continued

Date	Middle East (Ancient and Medieval)	Indian Subcontinent (Ancient)	Europe (Ancient)
early times	<p data-bbox="420 1466 440 1520">Egypt</p> <p data-bbox="420 1203 440 1321">Mesopotamia</p> <p data-bbox="495 1141 769 1359">Typical middle-class dwelling stored rain-water in a cistern; irrigation works used as domestic supply; private bathing facilities for the wealthy; sewage and solid waste deposited in streets and open spaces.</p>		<p data-bbox="420 727 456 886">(Crete) Palace of Minos at Knossos</p> <p data-bbox="420 555 440 623">Greeks</p> <p data-bbox="420 333 440 381">Rome</p>
about 2000 B.C.		<p data-bbox="801 919 965 1127">(Sanskrit) Early evidence of water treatment: boiling, sunlight, heated iron, filtration through sand and coarse gravel, coagulation.</p>	
16th century B.C. or earlier	<p data-bbox="989 1479 1009 1556">Shaduf.</p>		
1450 B.C.	<p data-bbox="1056 1396 1114 1556">Early evidence of water treatment.</p>		
1350 B.C.	<p data-bbox="1141 1363 1282 1556">Latrines with earthenware jars as receptacles, (Tell-el Amarna) crude stone shower baths.</p>		
13th century B.C.	<p data-bbox="1307 1417 1328 1556">Wick siphons.</p>		



TABLE VI.1--Continued

Date	Middle East (Ancient and Medieval)	Indian Subcontinent (Ancient)	Europe (Ancient)
11th century B.C.	Egypt	Mesopotamia	(Crete) Palace of Minos at Knossos
ancient times (?)	(Babylon) sewers cut in rock or built of masonry.		Land application of of urban drainage.
about 750 B.C.			Founding of Rome; water supply from Tiber and private wells.
600 - 550 B.C.	Construction of reservoirs by Nebuchadnezzar.		
6th century B.C.			(Athens) aqueduct constructed, al- though the city never acquired a well-developed sys- tem of water supply, drainage system, or sewer networks.
588 B.C.			Construction of <u>Cloaca Maxima</u> .
5th century B.C.			(Olynthus) aque- duct of terra-cotta pipes; houses with bathrooms, cisterns, lavatories, and a waste pipe running through the outside wall to the street; central alley in each block for drain- age; covered brick masonry drains. Hippocrates advo- cated boiling for disinfection and prevention of odors.

TABLE VI.1.1--Continued

Date	Middle East. (Ancient and Medieval)		Indian Subcontinent (Ancient)	Europe (Ancient)	
	Egypt	Mesopotamia		(Crete) Palace of Minos at Knossos	Greeks
about 400 B.C.				Plato recommended city water supply administered by a group of water commissioners.	
400-100 B.C.		Drainage served each house.			
about 350 B.C.				Aristotle mentioned filtration through porous vessels and distillation to purify water.	
312 B.C.					Construction of the first of the main aqueducts.
3rd century B.C.					Ctesibius invented force pump, operated by hand.
about 250 B.C.					
about 200 B.C.				Screw of Archimedes. (Pergamum, Asia Minor) aqueduct with inverted siphon constructed of stones with holes.	
1st century B.C.				Crude stone shower baths; public and private lavatories with water flushing facilities.	
47 B.C.	(Alexandria) prominent families provided with cisterns.				

TABLE VI. 1--Continued

Date	Middle East (Ancient and Medieval)		Indian Subcontinent (Ancient)	Europe (Ancient)	
	Egypt	Mesopotamia		(Crete) Palace of Minos at Knossos	Greeks
15 B.C.					
50 A.D.	(Alexandria) prototype of in- filtration galle- ries.				
97-104 A.D.					Use of coagulation.
4th century A.D.					Sextus Julius Frontinus, Water Commissioner of the City of Rome, wrote first contemporary engineering record of works to improve public water supply; in- cluded description of pis- cinae or settling tanks along aqueducts. Water Commission was government-operated, fun- ded by Roman government and emperors. Most of the supply from the aqueducts fed con- tinuously-flowing public foun- tains. Herschel estimated the supply by 100 A.D. at 50 gallons/capita/day. Popu- lation of Rome about 1 mil- lion. Six large public bath- ing establishments.  Eleven great thermae and 926 public baths; water- flushing public latrines. These cheap and accessible public facilities were necessary because a large population inhabited tene- ment-like dwellings.  Goths broke conduits at Rome; the population dwindled.
537 A.D.					

TABLE VI.1--Continued

Date	Middle East (Ancient and Medieval)		Indian Subcontinent (Ancient)	Europe (Ancient)	
	Egypt	Mesopotamia		(Crete) Palace of Minos at Knossos	Greeks  Rome
640 A.D.					
Middle Ages	(Alexandria) each dwelling with a bathroom.				
end of 9th century	(Cairo) number of water carriers estimated to be 100,000.				
10th century A.D.	(Cairo) arched viaduct similar to Roman aqueducts.				Tiber again used as supply.

TABLE VI.2  
 CHRONOLOGICAL SUMMARY OF HISTORICAL DATA--EUROPE  
 (MIEVEAL AND MODERN) AND THE UNITED STATES

Date	Europe (Medieval and Modern)					United States
	Europe in General	France	Paris, France	Britain	London, England  Holland and Germany	
Middle Ages	<p>Urban population declined along with tax revenues, and monasteries became leaders in supplying water supply and sanitation facilities. Wells and localized supplies, or stone channels for long-distance supplies. Delivery at public conduits or by porters. Bathing infrequent and lacking in privacy except in monasteries; monasteries provided latrines with water flushing and underground sewers, while cities usually had drainage ditches in the middle of the street.</p>	<p>Largest city in Europe after the decline of Rome. Seine and local wells used as water supply.</p>	<p>Supply from springs, wells, streams, and rivers within the city.</p>			
Middle Ages to 1800's				<p>Solid waste and sewage heaped in piles in the streets; collection in wealthier parts of town.</p>		
11th century				<p>Aqueducts transported water from distant supplies.</p>		

TABLE VI.2--Continued

Date	Europe (Medieval and Modern)					United States
	Europe in General	France	Paris, France	Britain	London, England	
late middle ages	Cities began to grow, and municipalitics began to take the lead from monasteries in the provision of water supply and sanitation facilities.			Lead pipe aqueducts of the gravity-flow type; use of privy vaults and cesspools.		
1100's	Liquid wastes drained to ditches and moats; solid wastes piled in the streets and sometimes sold for agricultural purposes.		First aqueducts to city.			
1105		First recorded windmill in Europe.				
1126		Development of artesian well (possibly a Chinese idea).				
about 1300	(Northern Europe) Public baths appeared.					
early 1300's					Private latrines situated along watercourses. First European city with an organized scavenging system for sewage and solid waste; public latrines with water flushing.	
1300's	Introduction of blast furnaces to smelt iron with charcoal.					

TABLE VI. 2--Continued

Date	Europe (Medieval and Modern)				United States
	Europe in General	France	Paris, France	Britain, London, England, Holland and Germany	
15th century	Primitive pumps of piston or plunger type supplying water to many cities.				
about 1500			Houses without water pipes or drainage.	Company of Water Tankard Bearers of pumping (force pumps driven by wheel; wooden construction).	
16th century	Single acting and double acting suction and force pumps, also centrifugal pump and ball and flap valves; use of wood rather than metal.				
1500-1700	Cost of water supply borne by church or burgesses of municipality.				
about 1550			Supply an average of one quart/capita/day; household filters in use.		
1553		Public fountains at Nantes (pop. 2600).			
1578				One of the largest cities in Europe (pop. 100,000). Sources included rivers, springs supplying public fountains and porters.	

TABLE VI.2--Continued

Date	Europe (Medieval and Modern)					United States
	Europe in General	France	Paris, France	Britain	London, England Holland and Germany	
1580					Peter Morice de- signed first me- chanical public water supply, water-wheel- driven pumps under London Bridge to serve some private homes with piped water (wooden con- struction).	
1596				Watercloset de- scribed by Sir John Harrington.		
before 1600				Private water services rare.		
1600	Large urban areas needing improvements in sanitation.					
early 1600's					Sheet-lead pipes; wooden mains of New River Company.	
1600's				Cast-lead pipes; private ser- vices increased, but only for the wealthy.		
colonial times						Smaller commu- nities meant there were relatively few problems with sanitation. Water supplies were usually pub- lic wells equipped with hand pumps.



TABLE VI.2--Continued

Date	Europe (Medieval and Modern)				United States
	Europe in General	France	Britain	Holland and Germany	
1602-1850's					
1630					
1652					
1676					
1682					
about 1700					
1700's					
1720					

Waterwheel-reciprocal pump system.

Somerset invented water-pumping engine utilizing steam.

(Boston) earliest public water supply in the United States.

(Holland) Leeuwenhoek observed living creatures in rainwater.

(Versailles) cast-iron mains, waterwheel and pump system.

Supplied 2 1/4 quarts/capita/day.

Upper classes used "close-stool."

Coke used in blast furnaces, to manufacture cast-iron pipes, use of cast metal introduced to pump manufacture; waterclosets in general use.

Private enterprise entered field of water supply.

Newcomen steam engine.

(New York) only two public sewers; drainage ditches in center of street.

TABLE VI.2--Continued

Date	Europe (Medieval and Modern)					United States
	Europe in General	France	Paris, France	Britain	London, England	
1745					Holland and Germany	
1749		Joseph Amy granted first water filter patent in any country.				
1750				Beginning of "In- dustrial Revolution."	Iron pipe mains measuring 1800 yards.	
1750-1800						Industrializa- tion and growth of cities.
1754						First steam- driven pumps in U.S., at Beth- lehem, Pennsyl- vania.
about 1755				Description of aer- ation by dropping water into air.		
1756				(Scotland) first scientific experi- ments on water softening.		
1757				Proposal to soften water with alkali compounds; hydrochloric acid observed to des- troy living crea- tures in water.		
1764						First commercially filtered water in Paris.

TABLE VI.2--Continued

Date	Europe (Medieval and Modern)					United States
	Europe in General	France	Paris, France	Britain	London, England Holland and Germany	
1767						
1775				Description of softening by boiling; alum used in home treatment by coagulation.		
1776				Effluent from water-closets discharged to cesspools; patent for valve closet.		
1776				First steam-powered pump in Paris.		
1778				Bramah valve closet (accepted design 1815-1937).		
1780				Shift to urbanization and industrialization from agriculture.		
1782					Water-seal trap for closet.	
1790				Johanna Hempel, first patent for household filters in England.	(Holland) Johann Tobias Lovitz, paper on powdered charcoal to prevent tastes and odors.	
1791				First British patent on a process and apparatus for filtration.		
1797						(Cincinnati) water porters.
1799						(New York) supplied by well and horse-powered pump.

TABLE VI. 2--Continued

Date	Europe (Medieval and Modern)				United States
	Europe in General	France	Britain	Holland and Germany	
about 1800	"Combined" sewer systems; only London, Paris, and Rome, in Europe, had water supply facilities.		Infrequent bathing in portable baths.	Intermittent supply; some homes with piped supply but poorer areas served with a central pump and one central privy for many families; bathing infrequent in portable baths.	Only public water supplies in U.S. located at Boston, Philadelphia, and New York. "Combined" sewer system.
early 1800's				Popularity of water closets; waste still piped in streets and collected in wealthier areas by private contractors.	(Philadelphia) public stand-pipes replaced with underground tanks and handpumps.
1800's	Filter basins and galleries.		(York) unfiltered river water subjected to home treatment by sedimentation.		Filter-basins and galleries.
1804			(Palsley, Scotland) first water filter for city-wide supply (delivery by cart).		
1806		Second city with city-wide filtered water supply.			
1810			(Glasgow, Scotland) first filter gallery on record; water was piped.	Private companies supplied London's water.	
1815				Sanitary sewage permitted in drains.	

TABLE VI.2--Continued

Date	Europe (Medieval and Modern)				United States
	Europe in General	France	Paris, France	Britain London, England Holland and Germany	
1817					(Philadelphia) cast-iron pipes introduced.
1818			(Ireland) first known softening of water for pub- lic use (potash of soda).		
1819			Patent for filter with negative head.		
1820's	(Toulouse) first large-scale example of diffi- culty in a pub- lic water supply from tastes and odors and of the solution of ex- cluding light and air.			Water supply being taken from sewer outfall.	
1827	Patent on pressure filter.		(Scotland) Robert Thom's first muni- cipal filter in- stalled, having principal fea- tures of rapid filter.		
1829			Simpson's first slow sand filter.	James Simpson's first municipal filter installed (model for slow sand filter).	(Lynchburg, Va.) first U.S. set- tling reservoir.
1831-1851				London grew from 1.5 to 2.5 million.	
1832					
1833		Storm sewers begun.	Cholera epidemic.		

TABLE VI.2--Continued

Date	Europe (Medieval and Modern)					United States
	Europe in General	France	Paris, France	Britain	London, England Holland and Germany	
1835		Fonvielle patent for reverse-flow wash.				(Philadelphia) first proposal recorded, to chlorinate water supply.
1838				(Paisley, Scotland) Filtered water was piped.		
1840						Boilers supplied hot water to the bath.
1840's				Earliest British patents on chlori- nation. Henry Doulton, glazed earthenware pipe.	London's first public bath- houses.	
1841				(Scotland) Clark lime process of softening.	No over-all planning in con- struction of sew- ers; little water used.	
1842				<u>Chadwick's General Report.</u>	Edwin Chadwick's report on water supply and sew- erage; John Roe subsequently de- signed egg- shaped sewer to replace square ones.	
1844-48						(Germany) Construc- tion of first modern complete sewer sys- tem; flushed with water every week.

TABLE VI. 2--Continued

Date	Europe (Medieval and Modern)					United States
	Europe in General	France	Paris, France	Britain	London, England	
1848				Britain	Holland and Germany	
mid-1800's			(Scotland) Earliest-known cascade aerator working in series; British Parliament required water supplies to be pure, safe, and constant (not in fact accomplished until later).	Compulsory to discharge sanitary sewage to drains; Snow discovered that cholera is communicated by contaminated water.		Cities crowded and unsanitary; epidemics of yellow fever, cholera, and typhoid. (New York) supplied 78 gallons/capita/day.
1850-1900				Use of distillation for ships and naval bases.		
1850's				Third cholera outbreak.		
1852					Wash-down closet; pan closet.	Waste water poured in street gutters; cess-pools and privy vaults common.
1853						
1854					Chloride of lime applied to sewage.	

TABLE VI.2--Continued

Date	Europe (Medieval and Modern)					United States
	Europe in General	France	Paris, France	Britain	London, England Holland and Germany	
1854-65					Construction of modern sewer system.	
1856		Darcy patent, forerunner of rapid filtration (coagulation not included).				
1857					(Germany) slow sand filters introduced.	Patent for plunger closet (first U.S. patent for water closet).
1858		Pasteur published findings on "aerobes."				
1860		Pasteur described "anaerobes."				Ten sewer cities in U.S.; disposal of sewage by dilution. (Elmira, N.Y.) first known aeration on a U.S. water supply.
1860-61						
1862				Invention of plastic-like Parkesine.		
1863					(Germany) proposal to remove iron and manganese by aeration and filtration.	
1866		Masonry dam at St. Etienne.		Last cholera outbreak in Britain.		
1869		Septic tanks.				



TABLE VI. 2--Continued

Date	Europe (Medieval and Modern)				United States
	Europe in General	France	Paris, France	Britain, London, England, Holland and Germany	
1870					(N.Y.) hot water supplied from central plant in home. John Wesley Hyatt, patent for celluloid.
1870's					(Poughkeepsie and Hudson, N.Y.) first U.S. filtration system installed, slow sand filters.
1870's and 1880's					(Albany, N.Y.) no filtration of river-supply and resulting deaths from typhoid.
1870's and after					Increasing number of sewage treatment plants using chemical precipitation and biological processes.
1871				(Wales) first intermittent sand filtration of sewage.	
1874				"Propagation of Cholera by Water"; British patent for ozonation.	
1875-1900				(Germany) First municipal iron removal plant.	
1876				Cases of typhoid fever decreased.	(Rochester, N.Y.) earliest U.S. multiple-jet fountain aerators. John Fanning, statements on water as vehicle for diarrhea, dysentery, typhoid.

TABLE VI.2--Continued

Date	Europe (Medieval and Modern)				United States
	Europe in General	France	Paris, France	Britain, London, England, Holland and Germany	
1877			Earliest statements on bactericidal action of ultraviolet rays.		
1878			Patent on softening with sodium carbonate.		
1879				(Holland) earliest use of alum to clarify an urban water supply.	
before 1880			Adoption of separate sewerage systems.		
1880			Sanitary sewage allowed in storm sewers.		
1880's			First high masonry dam in Britain, at Liverpool.		Earliest rapid sand filter units; first cities to install separate sewer systems.
1882			Evidence of importance of bacteria in sewage treatment. precipitation.		
1884					Process patent for ozonation; septic tanks; Hyatt patent on simultaneous coagulation-filtration.
1885					(New Jersey) Hyatt drifting-sand rapid filter first installed; no city in U.S. treating

TABLE VI.2--Continued

Date	Europe (Medieval and Modern)				United States
	Europe in General	France	Paris, France	Britain, London, England, Holland and Germany	
1887				Patent on electrolytic method of purifying sewage.	sewage effectively, coagulation became integral part of rapid filtration process.  Lawrence Experiment Station established in Massachusetts (studies included intermittent sand filtration). (Worcester, Mass.) patent on chlorination of sewage.
1888				Health of Towns Act, operation of sewage farms.	First patent on chlorination of water.
1889					First plant in U.S. for chemical precipitation of sewage.
1890					(New York) Ninety gal/cap/day supplied.
1890's	Shift to artificially filtered water supplies.			Sewage trickling filter perfected; most British towns with constant supplies.	
1892					(Germany) Manually operated gas water heater.  (Germany) Hamburg-Altona cholera outbreak emphasized protection of filtration.

TABLE VI.2--Continued

Date	Europe (Medieval and Modern)					United States
	Europe in General	France	Paris, France	Britain	London, England, Holland and Germany	
1894						First trickling filter plants in the U.S.
1896				Septic tanks.		(Louisville, Ky.) chlorine gas applied to effluent from working-scale filter to reduce bacterial count.
1897				First recarbonation of softened water, and chlorination of public supply.		
1899						(Albany, N.Y.) slow sand filtration decreased incidence of typhoid.
about 1900	Public baths in most major cities.		Shift from spring water to filtered river water and piped supply.	Less than 10% of residences in principal cities had water carriage of sewage.		In U.S., 950 sewer cities; deaths from typhoid were 35.8/100,000. (New York) supplied 950 gal/cap/day.
after 1900		Multiple filtration came into wide use.				
1901-02						(Kentucky) pan aeration with or without coke filling.
1902	First permanent water chlorination plant.					
1903						(Germany) patent for zeolite process of water softening.

TABLE VI.2--Continued

Date	Europe (Medieval and Modern)				United States
	Europe in General	France	Paris, France	Britain, England, and Germany	
1904				London's water supply came under public control.	George Thomas Moore and Karl F. Kellerman, studies on copper sulfate as algicide and germicide.
1905					First permanent chlorination of U.S. municipal water supply.
1906					Pitch-fiber pipe introduced.
1906-10					(Louisville, Ky.) Annual typhoid death rate 52.7/100,000.
1907					Liquid chlorine first commercially produced in the U.S.
1910					Automatic water heater.
1912			Discovery of "activated sludge" sewage treatment; standards for sewage effluent.		(Louisville, Ky.) filtration, sedimentation, and coagulation decreased annual typhoid death-rate to 19.7/100,000. Process whereby chlorine gas is dissolved in stream of water prior to introduction to water to be treated.

TABLE VI. 2--Continued

Date	Europe (Medieval and Modern)				United States
	Europe in General	France	Britain	Holland and Germany	
1916					(Louisville, Ky.) prechlorination decreased annual typhoid death-rate to 9.7/100,000.
1916-20			Chlorination begun		
1924					(Virginia) artificially-created turbidity used as treatment for algae.
1929					(Illion, N.Y.) prechlorination used to prevent algae growth on slow sand filters.
1931				(Germany) Development of polyvinylchloride pipe.	(Brownsville, Tex.) porous tubes or plates for air diffusion at a water works.
1935					In U.S., 6800 sewer cities.
after 1936					Deaths from typhoid practically zero.
1936-40					(Louisville, Ky.) post-chlorination decreased annual typhoid death-rate to 0.9/100,000.
1941					Development of thermoplastic pipe.
1945					Fluoridation.
1948					Development of polyethylene pipes.

TABLE VI.3

## CLASSIFICATION OF WATER AND SANITATION TECHNOLOGY LEVELS

Level	Water	Sewage
I	Dug wells, springs, or rivers (all local supplies); transport by water carriers. Disease as result of improper handling.	Scavenging system for sewage and solid waste, sometimes for use as fertilizer.
II	Aqueducts, canals (more distant supplies); village hydrants, fountains. Disease as result of improper handling.	Privy vaults, public latrines with water flushing; drainage systems; sewage farms.
III	Pumps, piped water, lead plumbing, fire control. Typhoid, dysentery, sewage problems.	Privy vaults, "close stools," some water closets; cesspools.
IV	Inside plumbing, slow sand filters, growth of industrial need and need for growing supply. Cholera, typhoid.	Water closets; combined sewers; dilution as disposal method; sewage farms
V	Rapid filtration, chlorination, ozonation, water-softening, aeration, continued growth of industrial need. Incidence of typhoid fever and other water-borne diseases decreased.	Separate sewerage systems; trickling filters, activated sludge treatment.
VI	Fluoridation, recarbonation, advanced treatment systems, concepts of water conservation, recycling and multiple use. Death from typhoid practically zero.	Reuse, sewage farms.

TABLE VI.4  
CLASSIFICATION OF LIFE-STYLE LEVELS<sup>a</sup>

Level	Characteristics
I	Agricultural civilization, peasant and herdsman the most important members of the community
II	Balance between agriculture and hand-craft industry with a close connection to agriculture. (Implements are economically cheap and technically crude, most made of wood; power source is irregular and often water.)
III	Industrialization. (Implements are cheap and uniform, much use being made of iron; power source is coal and the steam engine.)
IV	Industrialization and automation. (Much use is made of alloyed metals; power source is often electricity.)

<sup>a</sup>For a more complete description of the four levels of classification developed in the study on Appropriate Methods of Treating Water and Wastewater in Developing Countries, see the "Description of the Social-Technological Levels (STL)," p. 68 above.



TABLE VI.5  
TIME SCALE, DEVELOPED REGIONS--HISTORICAL

Rome		Europe, Medieval and Modern		United States	
Life-Style Level	Technology Level	Life-Style Level	Technology Level	Life-Style Level	Technology Level
	Time Span		Time Span		Time Span
I	I	I	I	I	I
	750 B.C.-588 B.C.		500 A.D.-1000 A.D. (Population declined.)		1600-1700 (Communities small.)
II	II	II	II	II	II
	588 B.C.-100 B.C.		1000-1600 (Cities grew.)		1700-1750
	III		III		III
	100 B.C.-537 A.D. (Population about one million.)		1600-1800 (Industrial Revolution begins, 1750.)		1750-1800 (Industrialization and growth of cities.)
I	I	IV	IV	IV	IV
	537 A.D.-1000 A.D. (Population dwindled.)		1800-1870		1800-1870
		III	V	III	V
			1870-1950		1870-1930
		IV	VI	IV	VI
			1950-		1930-

chosen were Rome, Europe (medieval and modern) and the United States. These regions were selected because information concerning them was more complete, and because these areas had been forerunners in the economic and technological development of interest here. From Table VI.5 it may be seen that the progression to higher stages of life-style level or technological level corresponds to periods of population increases. This phenomenon may be seen from two points of view, first, that smaller urban areas could solve their problems of water supply and sanitation with simpler means, but also that larger populations might provide a larger base for tax or other revenues with which to pay for improvements. The greater urbanization, in addition, was accompanied by industrial advances which contributed to progress in technological development. In connection with this last observation, it can be seen that life-style level I corresponds to technology level I, life-style level II to technology levels II and III, life-style level III to technology levels IV and V, and life-style level IV to technology level VI. This proved to be the case in all three of the regions included in the Time Scale display. The United States began its process of development at a much later date than was the case in Europe, so that the early life-style and technology levels are telescoped into a shorter time span.

In conclusion, it was felt that past developments in the technology of water handling and usage in developed areas could be of benefit in accelerating progress in this field in developing areas and that this study could provide background information for planning in these areas. There are implications to be made and comparisons which are possible between present or projected life-style levels,

technological levels, or other aspects of the situation in less developed areas, and the various historical stages of those countries which are considered as having been leaders in the field of water supply and sanitation. In ascertaining the manner in which present conditions of a particular developing area emulate the historic conditions presented here, it is in certain instances possible to discern appropriate and reasonable alternative technologies or methods for water-wastewater treatment and handling for developing areas. In other instances, it is possible to discern the problems which were associated with this historic development of domestic water use and handling so that they might be overcome or better dealt with as efforts in this field are furthered in particular developing areas.

Retrospective analysis of technologies and management, together with an examination of the impacts on the societies involved, can be a valuable aid to planners. For example, in planning for water supply and waste disposal in urban areas of less developed countries, it would be beneficial to review the history of the use in developed countries of such things as wells, sand filtration, or disinfection. What is generally required in planning for water and waste management, particularly in developing areas, is an appropriate blending of the old and proven with the new and innovative, in processes as well as in equipment. For example, plastic pipe represents a rather recent development which has found wide application in various types of systems, some of which date from a much earlier period. One outstanding and singularly important fact can be noted in a retrospective analysis of water and wastewater

technology and management in developed countries, and that is that tremendous health benefits have resulted wherever use was made of appropriate and adequate means for purification of drinking water and for disposal or treatment of wastes.

## CHAPTER VII

# Water Supply and Treatment

In LDC's it is not always possible to provide the population with drinking water that satisfies DC standards. The first concern may be to make adequate amounts of water easily available. With regard to water quality, resources and capabilities must be weighed in order to derive standards suitable to a particular situation, with pathogenic purity being an important consideration. The determination of standards for potable water and water treatment relates to economic feasibility and to in-country ability to provide operational skills necessary for water analysis. When more sophisticated treatment processes are used, the need increases for better analytical support. In general, in an LDC situation, costly and complicated equipment should be avoided.

As an LDC develops or changes with respect to its industries or type of life-style, additional measurements (attributes) of the quality

of drinking water will be required, and the acceptable level for each attribute will also be subject to change. At least, in DC's the pattern of change has been toward more restrictive standards, moving for example, from limits on simple turbidity and coliform bacteria to the identification of organic chemicals, toxic metals, or viruses. It is of interest to note that although in the United States great reliance has been placed upon chlorine for the removal of pathogens, the presence of chlorine has been implicated in the production of detrimental health effects, and dechlorination has been advocated.

In the first section of this chapter, emphasis is placed on "Water Supplies in Rural Areas of Developing Countries"; however, application can be made to nearly all but the largest settlements. Examination is made of some of the possible causes for failures in the area of potable water supply in LDC's. Information is provided on water consumption, sources, treatment, and transport and distribution. To furnish this article complementary material was included from two original publications which were greatly reduced and rewritten for adaptation to the limits of this text.

The second section of this chapter provides a study of a sand filter in Thailand. Details are given related to its design and operation. The original publication was condensed and rewritten for inclusion in this text.

The third section in this chapter is an article which was prepared especially for publication in this volume. It presents certain advantages, disadvantages, and design criteria for small wells, and slow and rapid sand filtration with particular application to developing areas. When feasible, recovery of groundwater is suggested as the

most desirable source for domestic supplies, since any pathogenic organisms will generally have had sufficient time to die away, and the result will be a hygienically safe water. Slow sand filters present a choice method of treatment in LDC's since they are uncomplicated in management and maintenance, utilize unskilled labor, and have a tremendous purifying capacity. Although slow sand filters have great advantages for developing countries, the advantages of rapid sand filters are that they show greater adaptability to more turbid waters and have smaller land requirements.

## VII.1.

WATER SUPPLIES IN RURAL AREAS OF  
DEVELOPING COUNTRIES (PART ONE)

L. Huisman

## INTRODUCTION

In rural areas of developing countries the efforts involved in obtaining water for domestic purposes are often tremendous, while in most cases the water is unreliable and properly speaking should be boiled before drinking, at the same time exercising the utmost care to prevent post-contamination. This is seldom feasible, with the result that the water supply itself endangers the health of the people concerned.

Many governments, often with outside aid, have taken it upon themselves to improve this situation, to provide a better source at a shorter distance from the consumers. In the past these efforts were not always successful, and it is wise to recognize the underlying causes for failure. As most important, the following may be mentioned:

- a. Particularly in non-market economies the people are extremely poor, and for a water supply as a self-paying proposition, only the cheapest methods are available. Even these may prove too expensive, meaning that in rainy periods the population goes back to their former, unreliable sources, negating any health benefit the public supply has brought. Neither is providing

---

Treatment Methods for Water Supplies in Rural Areas of Developing Countries. Prepared in Delft, The Netherlands, at the University of Technology, for Norman: University of Oklahoma Bureau of Water and Environmental Resources Research, 1975. (52 pp.).



the people with water free of charge a solution. It makes them indifferent and causes high consumption, resulting in a wastewater disposal problem.

- b. Bacteriological pollution of surface water is not recognized. This can result in a rejection of groundwater which would be bacteriologically safer, if it has a bitter taste due to small amounts of iron and does not satisfy more obvious criteria for consumer acceptance. Any public water supply scheme should therefore be preceded and accompanied by a campaign to inform the population. Trained personnel speaking the local language are indispensable for this but are seldom available in the numbers required.
- c. Only in (large) cities is it possible to engage the artisans and technicians necessary for operation and maintenance, and even here organisational and managerial skills are in short supply. In rural areas recruitment must be done locally, and an intensive training programme is now required. After the contractor has left, the operator is on his own. He can only do a good job when the installation is simple and its technology is as much as possible adapted to local skills. For the water supply itself, lack of adequate operation and maintenance is the most frequent cause for failures. For example, when a dug well is equipped with a pump but repairs cannot be effected by personnel in the immediate neighbourhood, the well cover will eventually be removed and the water abstracted with rope and buckets.

- d. It should be realized that safe drinking water is not enough to prevent the spread of water related diseases. Nature has many other possibilities in store, and people should learn how to avoid them. This is only possible by providing primary education to all children of school-going age. Because of the lack of adequately trained teachers, however, this is a dream that will not be fulfilled in the present century.

Taking all the above-mentioned factors together, it is clearly impossible to provide the rural population of developing countries with drinking water that satisfies western world standards. Here the first concern of the water engineer should be the quantity of the water, making adequate amounts easily available. As regards water quality, he should do the best he can, at the same time avoiding complicated and costly equipment and never aiming at perfection. As prevention is better than cure, he should first of all give his attention to groundwater recovery, when necessary, spread over various sites or increased in yield by artificial recharge. Private supplies, one for each family, greatly reduce the propagation of waterborne diseases and should be given high priority, while for a dispersed population they often form the only possibility. Flowing rivers are able to carry local pollution over distances of tens of kilometers up to a few hundred kilometers, and treatment of such a water is always necessary. Appropriate technology should now be applied, commensurate with the skills and materials locally available as well as with the prevailing social attitudes. Involvement of the local population, finally, is a pre-requisite for success, and great care should therefore be given to obtaining and maintaining good communication with the local political and religious leaders.

To provide a region with a public water supply, a masterplan is necessary, followed by detailed feasibility studies on technical, financial, organizational, and managerial aspects. Before the water engineer can start his work, many investigations should have been carried out, some of which are extremely time consuming and require the help of high-level (perhaps foreign) experts. In many cases the project cannot suffer the delay, neither bear the cost, of such data collection, and the water engineer has to start from scratch, using his ingenuity to solve the problems as they arise. His capabilities are now the deciding factor for success or failure, and all pains should be taken to select the best man available.

As indicated by the title of this paper, the contents will be limited to rural supplies, unpiped for a dispersed population having only small nucleated settlements and piped for (larger) villages. Public water supplies to cities are left out of consideration. Their financial scope must be made large enough to engage properly trained personnel, allowing the application of western technology, adapted in one way or another to local circumstances and avoiding the sophistication that is nowadays required, to save through the use of unskilled labour.

#### WATER CONSUMPTION

Water is indispensable for life. To perform its physiological functions properly, the adult human body needs two to five liters per day, depending on climate and work-load. Water is also required for other duties, for cleaning cooking or eating utensils, personal hygiene, laundry, or housecleaning. Strange as it may seem, the latter amounts do not vary much with the household size, allowing the calculation of the

total consumption per family as

$$Q = q_o + n \cdot q_c$$

with  $n$  as the number of family members. This relationship was first discovered for the city of the Hague in the Netherlands, giving

$$Q = 120 + n(50) \text{ liters/day}$$

and meaning for a family of four an average per capita consumption of eighty liters per day. From data provided by White, Bradley, and White (3, p. 123) about water consumption in Tanzania the following formulas may be derived:

$$\text{unpiped households} \quad Q = 25 + n(5),$$

$$\text{households with piped connections} \quad Q = 200 + n(80).$$

This means for a family of five an average per capita consumption of ten and 120 liters per day, respectively. Already from these figures it will be clear that consumption increases tremendously when water becomes more easily available. In the case where consumption has previously been low, the provision of more water decidedly improves health, either by reduction of disease through greater use of water for washing or by growing of food supplies. When consumption has already been high, however, a further increase in water supply must be considered as a luxury item which will be used for car washing, watering of the lawn or similar non-essential purposes. Moreover, it should be realized that a major part of the domestic water supply is converted into sewage. As long as the per capita consumption is small, less than about twenty to forty liters per day depending on soil conditions, disposal is easy, using cesspools and soak-away pits. With higher consumptions a system of sanitary sewers is required, and these are rather expensive to construct.

Taking the above mentioned factors into account, it is proposed to base water consumption in rural areas of developing countries on the

following formulas. The average per capita consumption for a family of five is  $q$ .

Unpiped supplies --

minimum	$Q = 10 + n(5)$	$q = 7$ liters/day
---------	-----------------	--------------------

adequate	$Q = 30 + n(7)$	$q = 13$ liters/day.
----------	-----------------	----------------------

Piped supplies with standpipes --

	$Q = 50 + n(10)$	$q = 20$ liters/day.
--	------------------	----------------------

Households with piped connection --

small village	$Q = 100 + n(20)$	$q = 40$ liters/day
---------------	-------------------	---------------------

large village	$Q = 125 + n(25)$	$q = 50$ liters/day.
---------------	-------------------	----------------------

In tropical climates the variation in daily domestic consumption is less than in temperate ones, while the variation in hourly consumption is somewhat larger. For piped municipal supplies with standpipes and for piped household connections, about the same capacity is required for the distribution system and only a slightly larger clear water storage is required in tropical compared to temperate climates. With unpiped households on the other hand, the pattern of daily consumption may be schematized as follows:

30% during one hour at the beginning of the day,

30% during one and one-half hour at the end of the day,

40% more or less evenly divided over the remaining daylight hours.

This means a ratio between maximum and average hourly consumption equal to a factor of no less than 7.2, while the clear water storage necessary to flatten out the demand variations rises to one-half of the daily consumption. This certainly increases the cost of water supply. Money could be saved with an alternating supply which would provide each sector of the community with water during two hours per day only. The serious disadvantage must be mentioned, however, that during the remaining twenty-two

hours, the distribution system is without pressure, thus allowing polluted groundwater to enter the system through the always present leaks. In this sense, the water supply becomes a menace to public health.

#### WATER SOURCES

Hydrological cycle. Water is indispensable for men, plants, and animals, and in this respect it is very fortunate that enormous amounts are available on the earth. However, only 0.62% of these amounts are fresh water, and only 2% of the latter quantity is surface water in rivers and lakes where it is easily demonstrable and seizable. Luckily, the water on the earth is not at rest, but in a continuous circulatory movement, whether as water vapour in the atmosphere, as surface water in streams, lakes, seas and oceans or as groundwater in the interstices of the sub-soil. There is a never-ending transformation from one state to another, known as the hydrologic cycle (Figure VII.1.1.). Water from the atmosphere falls to the ground as rain, hail, sleet and snow. Some water is exposed to evaporation while some is consumed by vegetation (transpiration losses). That which remains either flows over or directly beneath the ground surface to open water courses, or else moves further downward through the aerated upper strata of the earth until it reaches the groundwater table and recharges the groundwater supply. This groundwater is not stagnant, but flows through the soil in the direction of the downward slope of the groundwater table. Sooner or later it appears again at the surface, in the form of springs or as groundwater overflow into rivers and lakes. The smaller streams combine to form larger rivers which carry the water to the sea. Here, evaporation returns it to the atmosphere, and the cycle begins once more. It takes nearly three centuries on the

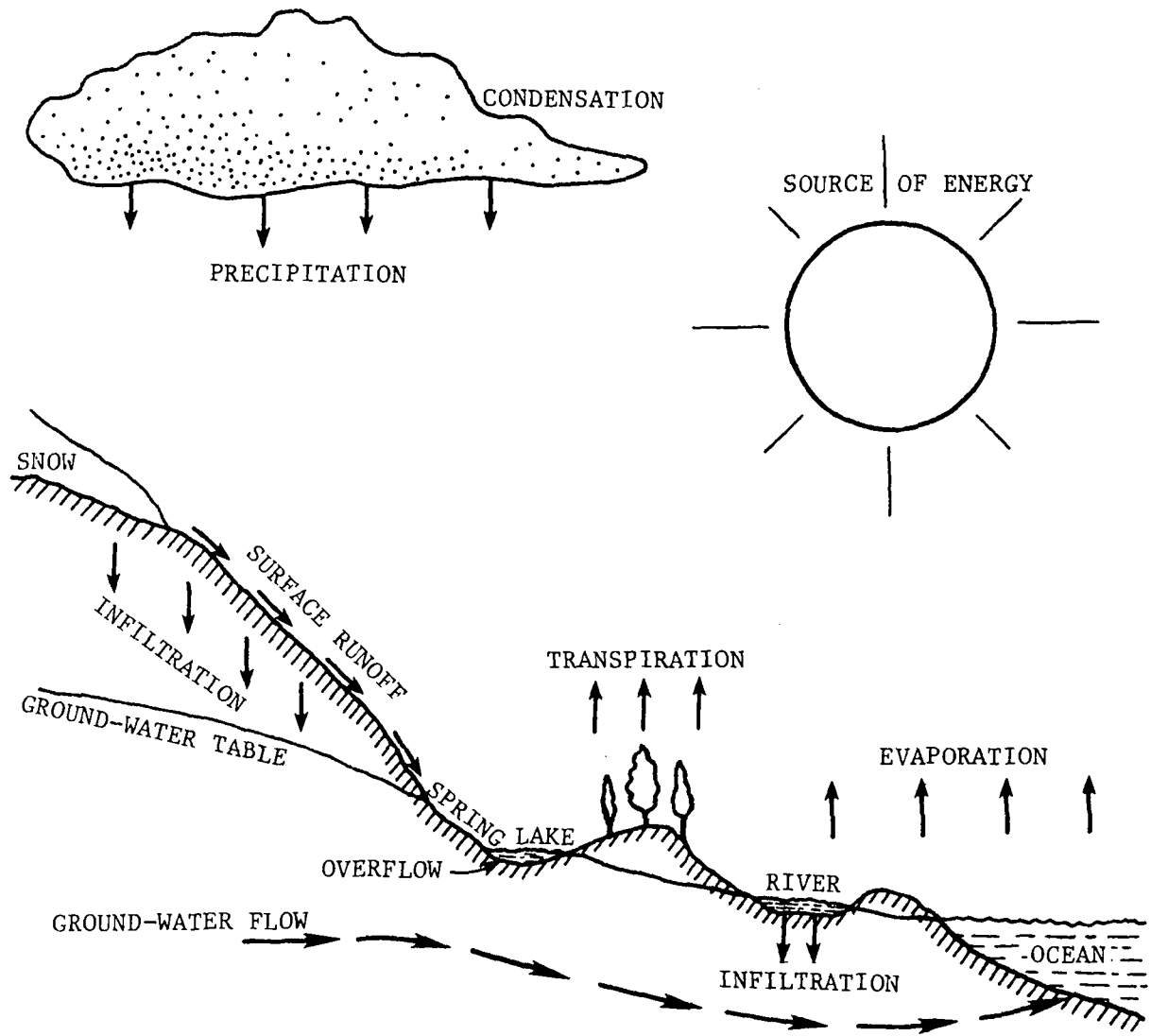

Fig. VII.1.1. Hydrologic cycle.

average for the fresh water stock on the land surfaces of the world to be replaced by new water coming from the sea.

Water for domestic use may be abstracted from the hydrologic cycle at various points: as roof drainage before it reaches the ground, as ground catchment before it runs off or percolates downward, as groundwater, as springwater at the point of re-emergence to ground surface, and as surface water from rivers and lakes. To these natural possibilities may be added man-made ones such as abstracting water vapour from the atmosphere by condensation and creating or increasing groundwater supplies by induced or artificial recharge. Not all these possibilities are available everywhere or at all times, and each of them has special advantages and disadvantages. They will be described in more detail in the subsequent sections.

Rainwater. Assuming an annual rainfall of 0.5 m and a roof catchment (Fig. VII.1.2) with an efficiency of 80 to 90%, an amount of 0.425 m<sup>3</sup>/m<sup>2</sup> per year becomes available. For a family of five with minimum requirements (see "Water Consumption" above) the consumption equals thirty-five liters per day or 12.8 m<sup>3</sup>/year for which a catchment area of thirty m<sup>2</sup> is sufficient. In case the rainless period has a duration of one-half year, theoretically a storage of 6.4 m<sup>3</sup> is required. Taking into account evaporation losses this amount must be raised to 7.5 m<sup>3</sup>, which may be accommodated in a cistern two meters in diameter with a depth of 2.5 meters, for example. Often storage tanks are covered or filled with rocks or sand to reduce evaporation. When water requirements are larger, ground catchments may be used. For the same rainfall of 0.5 m/year, an efficiency of 60-80% and minimum requirements of 65 liters/day, the required area for catchment rises to 68 m<sup>2</sup> and the necessary storage area to 14 m<sup>3</sup>.



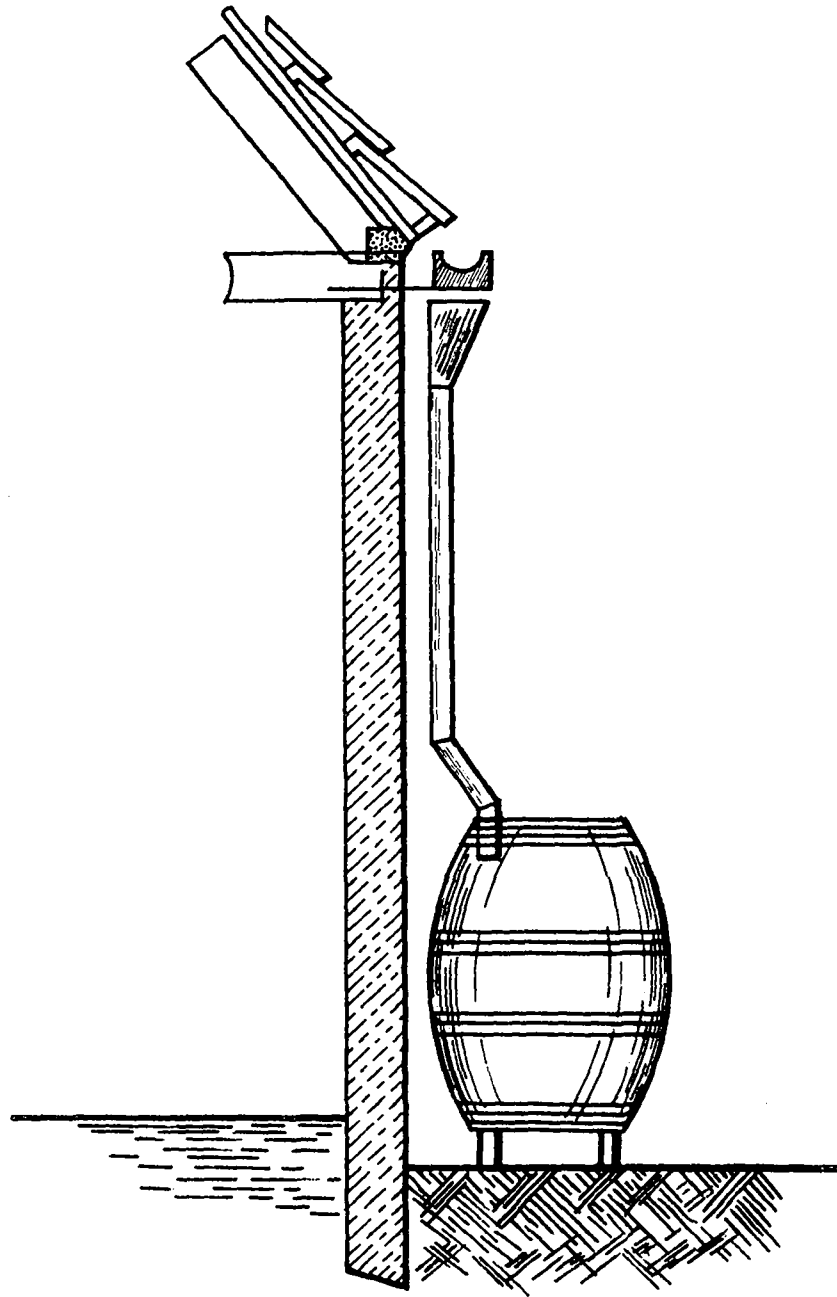

Fig.VII.1.2. Roof catchment.

In general, the size of the catchment area will provide no problems, but the volume of the cistern is too large an effort for a single family. For a small village or a limited sector of a larger one, filter cisterns may be applied (Fig. VII.1.3). Rainwater harvested with the help of ground catchments will always be polluted by bird droppings, by wind-blown dust, and when left unprotected, also by the excrements of animals. This is the reason that cisterns equipped with sand filters are beneficial, able to produce a clear water which in many cases will also be fairly reliable hygienically.

Springwater. Groundwater is the best source for domestic supplies. Since it was born as downward percolating rain or river water, tens to hundreds of years have elapsed during which all pathogenic organisms have died away, resulting in a hygienically safe water. Groundwater does have the disadvantage that it is invisible and therefore unknown and that for its recovery more or less elaborate works are necessary. These drawbacks, however, do not hold true for groundwater that returns to the ground surface in the form of springs where it is directly recognizable and seizable.

Looking only at the etiology of springs, four different types may be distinguished, shown together in Fig. VII.1.4. The depression springs on the left of this figure are rather variable in yield, while in dry periods and with a lower groundwater table, they may cease to flow altogether.

To maintain the hygienic purity of springwater, it must be recovered in such a way that any possibility of pollution is avoided. This is done by enclosing the spring with a concrete or masonry structure to protect the water from such things as pollution or mud. An interesting possibility is the use of drains or perforated pipes driven more or less horizontally

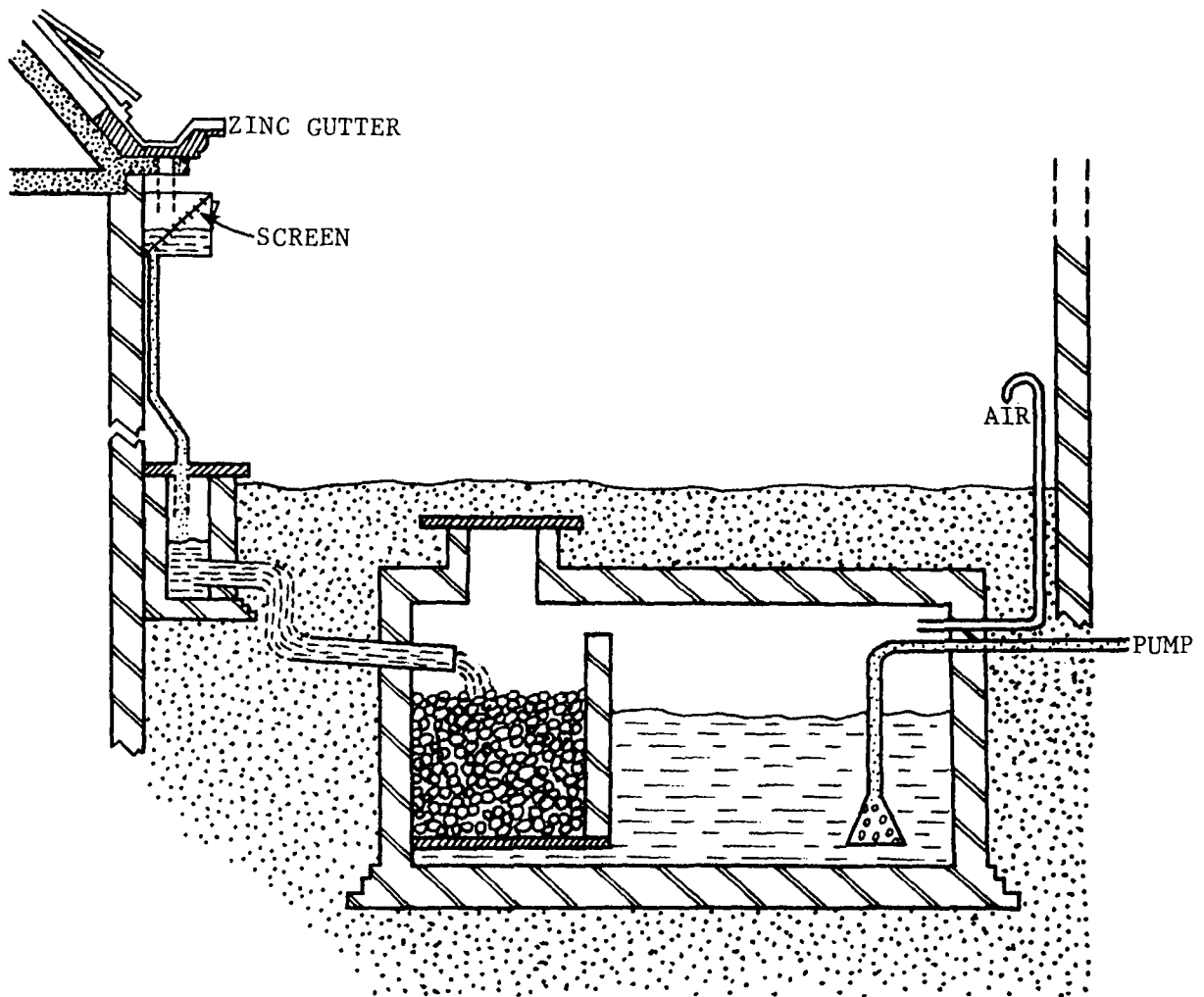
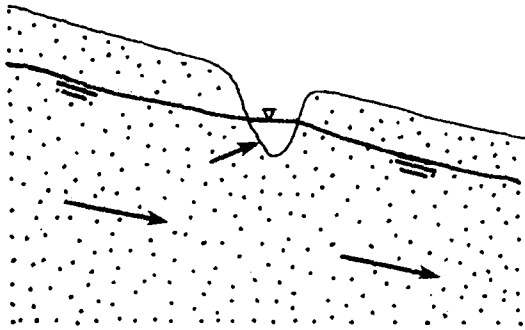
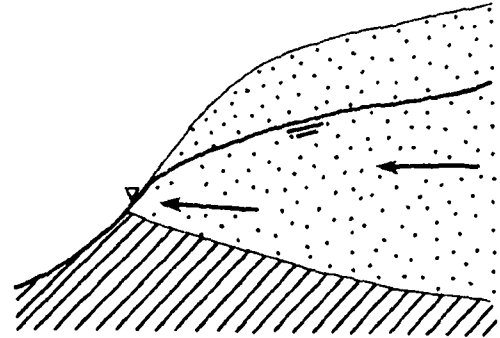

Fig.VII.1.3. Cistern.



GRAVITY DEPRESSION SPRING



GRAVITY CONTACT SPRING

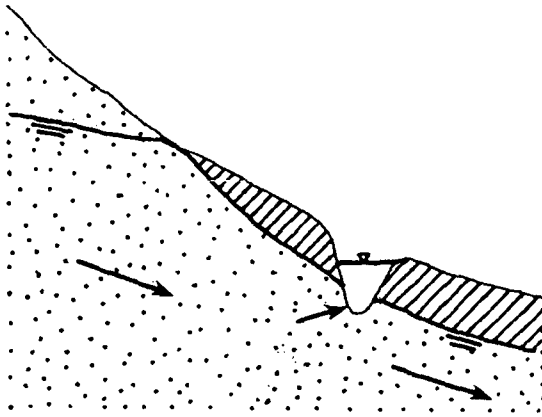

ARTESIAN DEPRESSION SPRING

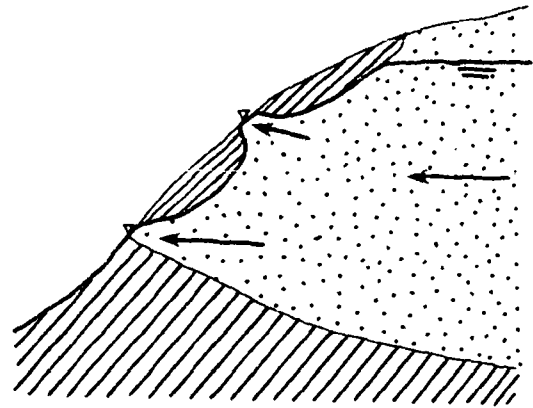

ARTESIAN CONTACT SPRING

Fig.VII.1.4. Springs.

into the hill side, whereby protection against pollution from ground surface is easier to obtain.

Groundwater. As mentioned before, groundwater has the enormous advantage of being safe in bacteriological respect. To this it must be added that under suitable conditions it can be recovered at many places, including the immediate neighbourhood of population clusters, shortening the distance it must be carried to the various households. Thus, individual supplies, one for each family, may also be considered, in which case they will be kept in better condition while the consequences of pollution are appreciably less.

Dug wells for groundwater abstraction are so simple in construction that they can be made by local artisans from local materials without specialized equipment or skills. As a consequence of their method of construction, dug wells have a diameter large enough for a man to work in, at least one meter, by means of which they are able to store great quantities of water, thus allowing periodic abstractions at a larger rate than that of the groundwater actually flowing into the well. There are many materials suitable for linings, masonry, brick work, steel and timber all being used in various parts of the world according to circumstances; but for widespread use, there are great advantages in utilizing plain or reinforced concrete. Timber lining rots and requires frequent renewal, particularly above the water line. It can be rendered more resistant to decay by means of a waterproof coating or another suitable preservative.

To prevent pollution of the groundwater abstracted by a dug well, the curb must be water tight over its upper part, if possible to a depth of a few meters below the lowest groundwater level during operation. To

protect the water inside the well against pollution by wind blown material or by objects falling into the well opening, a tight cover made of durable material is a strict requirement. This precludes water abstraction by rope and bucket, and a (hand) pump must be installed. Due to wear and tear, this pump is bound to fail after some time of use. Consequently, in the neighbourhood a reserve pump must be available as well as the skills to install it. When the upper soil layers are stiff, clay for instance, the annular space produced around the well during sinking will not be self-sealing and must be filled with grout to prevent incursion of surface drainage around the well perimeter. Around the well an artificial mound is desirable, provided with pavement to let rain and spilled water flow away from the well as quickly as possible.

When water has to be tapped at greater depths, tube wells must be used. For depths of a few tens of meters, driven or jetted wells offer an attractive solution, but they do have the disadvantage that all materials must be imported. For larger depths drilling methods have to be applied. In western-type countries, reverse hydraulic rotary drilling is used almost exclusively, but for developing countries percussion methods are better suited. They are certainly slower and more labour intensive, but on the other hand they are safer, more reliable, and require less skilled personnel. Tube wells require little in the field of sanitary protection. Due to the great depth at which the screen is set, the groundwater is reliable in bacteriological respect while the small diameter of the casing makes pollution prevention of the water abstracted quite easy.

Surface water. For rural supplies in developing countries, surface water sources show many disadvantages. Rivers are not always perennial.

By contact with human and animal life the water is polluted and always needs treatment before domestic use. It is only locally available, and when it is situated at a distance from the community, at least a pumping station, pipelines, and standposts are required. Individual supplies thus are not feasible utilizing surface water sources.

The least objectionable solution is the abstraction of water from natural or artificial lakes. Here the water is at least clear, and when it is abstracted at some distance from the shoreline the pollution is rather small, so that adequate treatment may be effected by slow sand filtration alone. In the case of river water, turbulent mixing results in about the same quality of water over the full cross-sectional area, and abstraction near the shore will show little disadvantage. In particular with turbid waters, an extensive treatment will be required, comprising at least plain sedimentation and slow sand filtration and under more severe conditions chemical coagulation, flocculation, settling, rapid filtration and disinfection. In such instances the help of foreign firms is often required for construction, while for operation imported chemicals, technical expertise and managerial skills must be available. To prepare for the failure of the river water in quantitative or qualitative respect during dry periods, storage reservoirs must be constructed. These reservoirs offer the added advantage of quality improvement by self-purification, and in such instances simpler treatment methods may be used than otherwise would be required.

A protected river intake is shown in Fig. VIII.1.5, a vertically bent pipe within a stone caisson close to the shore. The caisson protects the intake against such things as flowing water, floating wood, or shipping. The stone caisson should extend above the highest water level. With such

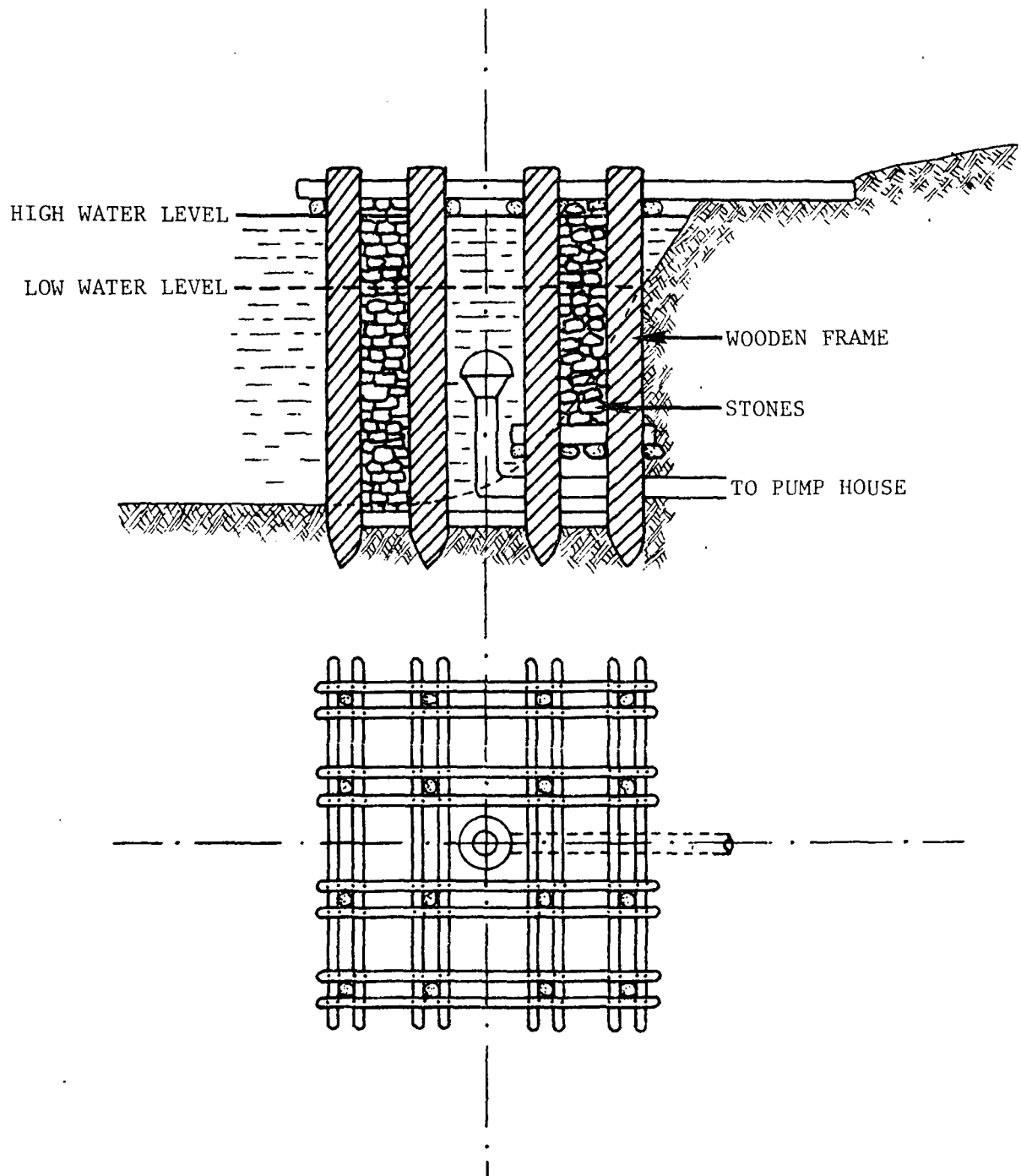

Fig.VII.1.5. Protected river intake (schematic, not to scale).



a design it is easy to reach the intake grid for control and cleaning. A pond or lake intake is shown in Fig. VII.1.6. This floating system has the advantage that it avoids intake of floating dirt and mud from the pond or lake bottom. The flexible joint of rubber or plastic can present difficulties and has to be renewed from time to time (2).

Artificial recharge. Artificial recharge may be defined as the planned activity of man whereby surface water from streams or lakes is made to infiltrate the ground to increase the recovery of groundwater. The methods of artificially increasing groundwater supplies may be classified into two broad groups:

- a. indirect methods, in which increased recharge is obtained by locating the means for groundwater abstraction as close as practicable to areas of rejected recharge or natural discharge;
- b. direct methods, in which water from surface sources is conveyed to points from which it percolates into a body of groundwater.

The indirect methods are better known as induced recharge and are commonly accomplished by inducing movement of water from a stream or lake into the ground as a result of groundwater recovery at a short distance from the shoreline. Schematically this is shown in Fig. VII.1.7. Provided that the distance from the well, line of wells or gallery to the river is larger than about fifty meters and that the river water takes at least one month to reach the collectors, the water recovered will be bacteriologically safe.

The direct methods of artificial recharge are more complicated and require at least transportation of the water, but here the source of surface water and the aquifer to be replenished are separate items so that for each the best possibility can be chosen. Depending on local

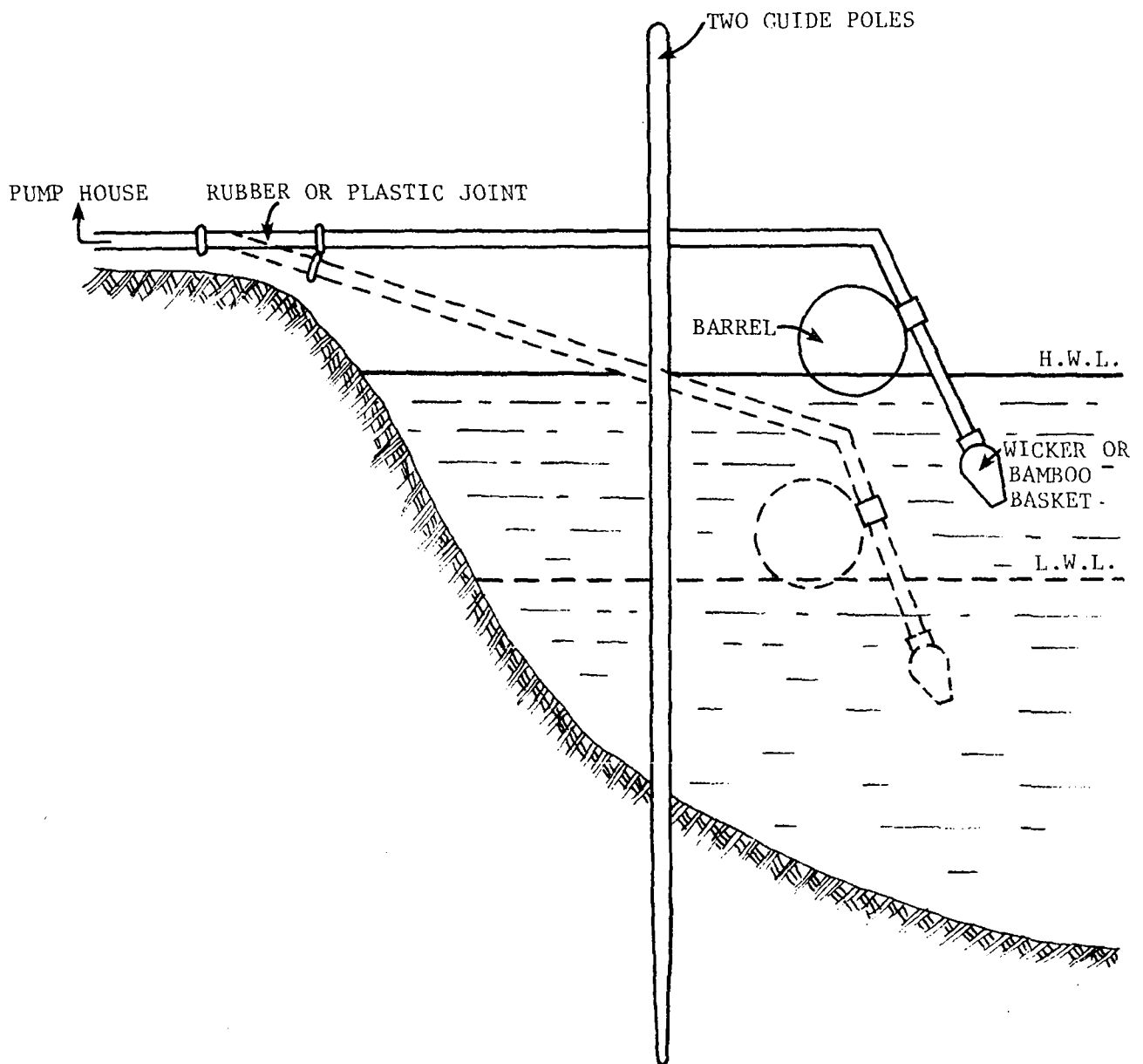

Fig. VII.1.6. Protected pond or lake water intake (schematic, not to scale).

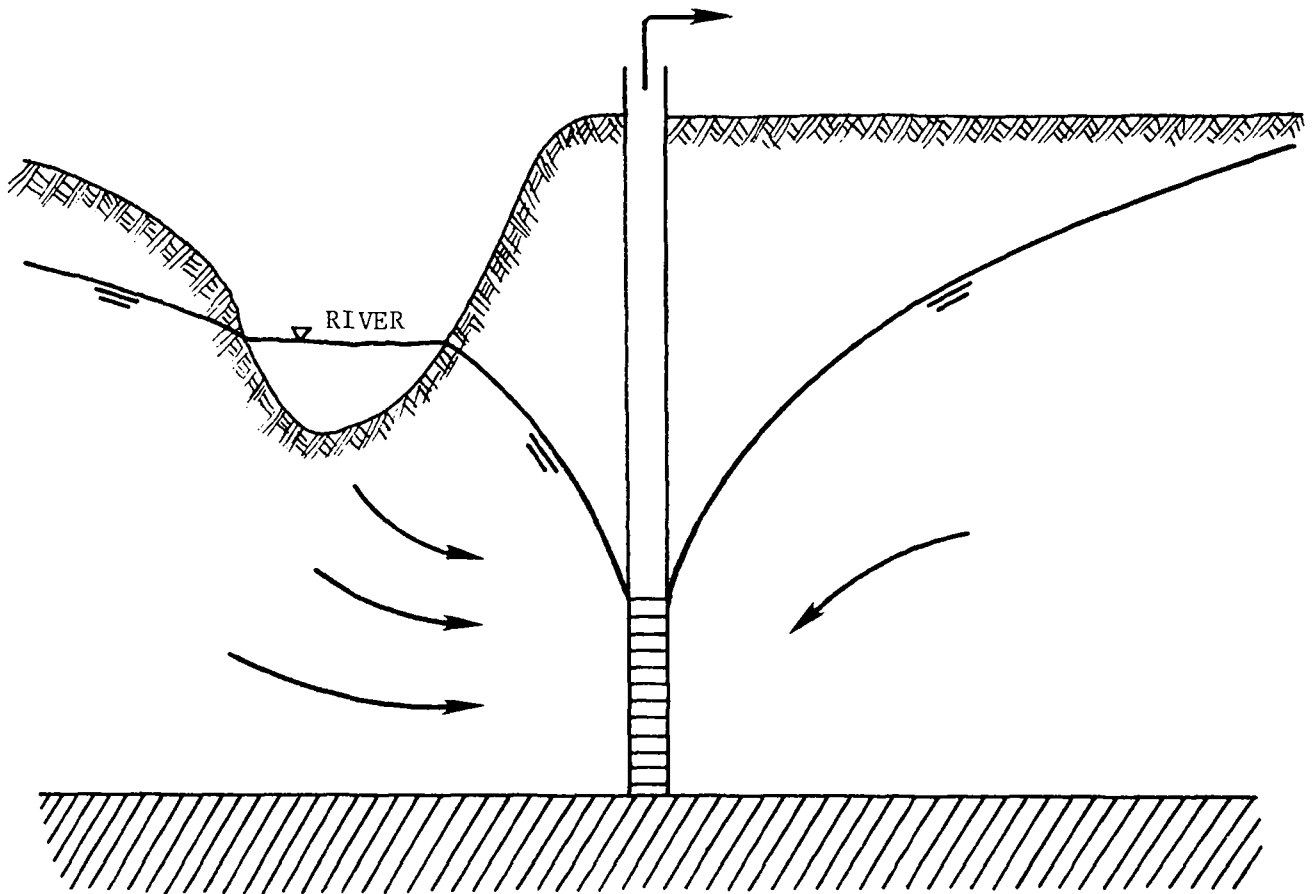

Fig. VII.1.7. Induced recharge.

geo-hydrologic conditions, the actual recharge may be accomplished with spreading basins, with pits and shafts or by means of injection wells. Spreading basins are the simplest to construct and operate. The quality of the recharge water may be improved by a simple pretreatment consisting of the use of roughing filters both preceded and followed by aeration. The quality of the groundwater abstracted in this case can compete with the best treatment systems available. It is, moreover, a natural treatment, less likely to fail with inexpert operation.

#### WATER TREATMENT

General. The quality of domestic water has to satisfy two requirements; it must be safe and it should be attractive to use. Both goals may be realized by a judicious selection of the source or by purification after recovery. For good health the amounts of water available must also be adequate. In some cases the amounts available may be limited by the size of the source while the distance to the source is commonly the limiting factor. In the latter case, a piped supply reduces the limitations on quantities available, but this involves large amounts of local labour and foreign currency. When transport by gravity is not possible and pumps must be used, the cost of construction rises further, and operation and maintenance requires skilled labour, seldom locally available.

Taking the above mentioned factors into account, a list of declining preferences for sources of supply could be set up as shown below:

- a. groundwater, requiring no treatment, recovered at various places at short distances from the consumers;
- b. springwater, requiring no treatment, recovered at some distance and carried to the consumption area by a gravity system;
- c. groundwater, requiring simple treatment, recovered locally;

- d. individual rainwater supplies;
- e. springwater, requiring simple treatment and a gravity supply;
- f. lake water, requiring simple treatment, recovered at some distance and carried to the distribution area by a pump-driven piped supply;
- g. water from rivers, requiring extensive treatment and pumping to the supply area.

Springwater and natural or artificially recharged groundwater supplies are hygienically safe, but when they are anaerobic, they may contain concentrations of iron and manganese which are too high. Removal may be accomplished by aeration, sedimentation and mechanical filtration. Slow sand filters may be applied for the treatment of surface water with little turbidity or for groundwater or rainwater polluted during or after the process of collection. For river water with a high concentration of suspended matter and perhaps a large load of organic and bacteriological pollutants, a number of unit operations must be set one behind the other, such as plain sedimentation, chemical coagulation with flocculation and settling, and rapid filtration with disinfection or slow sand filtration.

When considering treatment systems, it should be realized that one treatment may be able to perform various functions. For example, slow sand filtration contributes to clarification, deferrisation and removal of pathogenic organisms. On the other hand, one purpose can be served by different treatments, as in the case of the removal of suspended matter which may be accomplished by sedimentation as well as by filtration.

Aeration. Aeration is the process whereby water is brought into intimate contact with air for the purpose of raising the oxygen content, lowering the carbon dioxide content and removing obnoxious gases such

as methane and hydrogen sulfide. Aeration may be necessary for groundwater, but when it is required for surface water this indicates such heavy organic pollution that a better source should be sought.

Methods of aeration may be classified into three broad groups, waterfall aerators, bubble aerators and mechanical aerators. With waterfall aerators the water falls through the air in fine droplets or thin sheets. These devices are the simplest to construct, give excellent results and should therefore be preferred when working under more primitive conditions. Waterfall aerators may be constructed as spray aerators with upward or downward water outflow, as multiple tray aerators or as cascade aerators, the latter having the advantage that the loss of carbon dioxide can be kept small. Spray aeration requires an elaborate pipe distribution system to deliver the water to the various nozzles, making its construction rather expensive. Multiple tray aerators offer the cheapest and simplest construction, requiring little space and performing an excellent job both with regard to oxygen absorption and removal of undesired gases. Cascade aerators require more space (loading 20 to 100 m<sup>3</sup>/hour per meter width) and are more expensive to construct but must be used when the water recovered is in carbon dioxide-bicarbonate equilibrium, meaning that a loss of carbon dioxide would result in a precipitation of calcium carbonate.

During aeration the water must be protected from pollution by contact with people, animals or wind-blown material. This may be accomplished by locating the aerator in a fenced-in pasture and removing all shrubs and trees to a distance of about thirty meters.

When groundwater is anaerobic and needs aeration, it may also contain minerals such as iron and manganese in amounts too high for domestic

use. During aeration these substances are converted to insoluble ferric or manganic oxide hydrates, which may subsequently be removed by sedimentation or filtration.

Plain Sedimentation. In a flowing river, a classification of undissolved particles takes place. Those with a mass density less than that of water accumulate at the surface. Particles much heavier than water, such as sand, are transported rolling and tumbling over the river bottom, while particles with a mass density only slightly larger than that of the surrounding fluid are kept in suspension by turbulence and bottom scour. River water intakes can be constructed in such a way that the abstraction of floating matter or bottom transport is avoided. It is impossible, however, to prevent the carrying along of suspended particles, meaning that the water taken in may be turbid and thus unacceptable as drinking water.

Removal of turbidity may be accomplished in different ways, plain sedimentation being the simplest. The water to be treated flows through a tank of large cross-sectional area, creating a state of virtual quiescence. This allows the particles slightly heavier than the fluid to move downward and accumulate at the bottom of the tank, and the water leaves the tank in a clarified condition. For particles which do not tend to coalesce during settling, the overflow rate, that is the ratio between the amount of water to be treated and the surface area of the tank, is the deciding design factor. The depth of the tank is of little importance and may be kept quite small, one meter for instance. For flocculating mud particles, the purifying effect also depends on the detention time and requires a greater depth, two meters or more when possible. To avoid short-circuiting, the ratio of the length to the width of the tank

should be quite large, from three to six. For the same reason, the inflow and outflow of water should be divided evenly over the whole width. This can be accomplished quite easily with straight weirs.

Basins for plain sedimentation can be constructed as simple, dug basins with an overflow rate of one to ten meters per day. Assuming common values of two m/day overflow rate, a village of 1000 inhabitants and a per capita per day consumption of thirty liters, the pond required would have the following dimensions: 1.5 meters in depth with side slopes of 1 to 1.5, a bottom width of two meters and a bottom length of 10.5 meters with 7.5 meters between the inlet and outlet weirs (Fig. VII.1.8). For cleaning by draining, drying and excavation of the accumulated material, two such tanks should be constructed, so that one may be used while the other is cleaned.

It should be realized that plain sedimentation alone is seldom sufficient to produce a water of the desired clarity and that this treatment is superfluous for water abstracted from lakes or from storage reservoirs.

Chemical coagulation, flocculation and settling. The efficiency of plain sedimentation is greatly enhanced and also extended to colloidal matter (including colour), when the suspended particles in the raw water can be made to coalesce, thus forming larger flocs with a higher rate of subsidence. In case these particles carry a (like) electric charge, this process requires the addition of chemicals. Commonly three-valent iron or aluminium salts are used for this purpose, which after dissolution in the water form micro-flocs almost instantaneously. By stirring (flocculation) these flocs combine with the suspended matter naturally present in the water, producing the desired aggregates of high



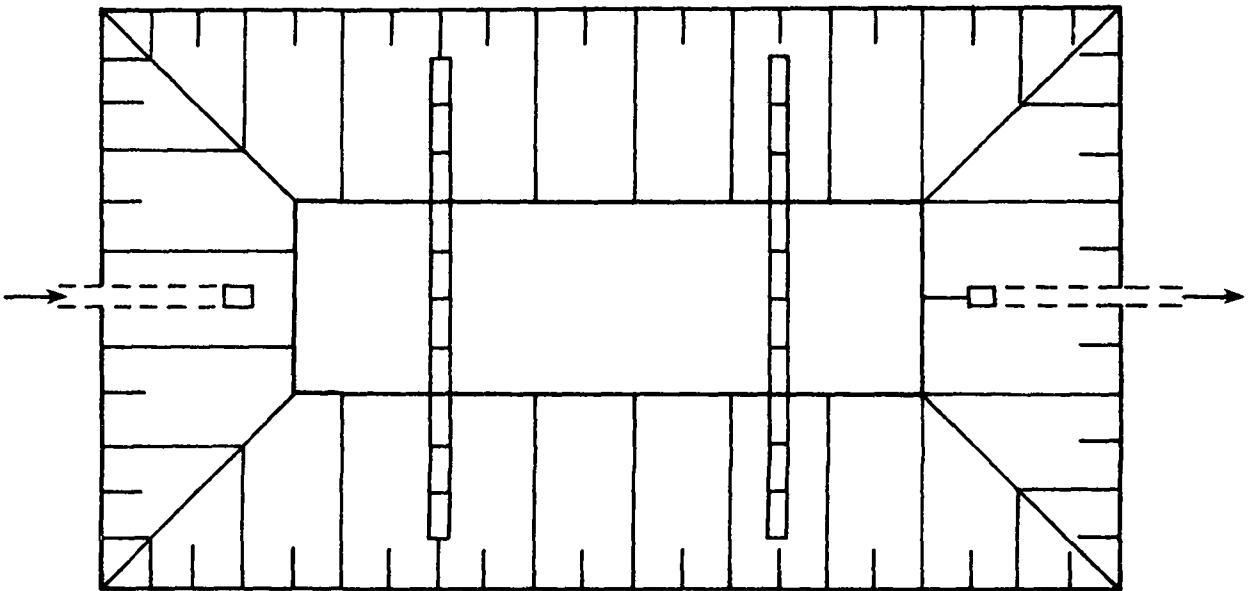

Fig. VII.1.8. Plain sedimentation with dug basin.

settling velocity (25-75 m/day). By means of subsequent sedimentation these flocs can easily be removed.

In the description given above, a number of different operations can be distinguished:

- a. acquisition and storage of chemicals;
- b. dosing of chemicals in an amount dependent on the quantity and quality of the water to be treated;
- c. mixing of the chemicals with the water;
- d. flocculation;
- e. settling.

In rural areas of developing countries it is difficult to obtain chemicals from far away places, while the lack of managerial skills can endanger the continuity of the supply. In some areas, however, locally available materials can be used either as found or after simple modification. Even in those countries where no bauxite is available, it is possible to produce alum sulfate locally using simple clay or (kaolin) as raw material. Some natural organic products like starch, gelatin and alginates can be used as coagulant aids. In Western Europe, for example, an extract of potato flour is used for this purpose.

The amount of chemicals needed per unit volume of water varies with water quality, that is, with the time of the year, and the proper amount is fairly complicated to assess correctly, in particular when the acidity of the water needs adjustment. This problem can be made somewhat easier to solve when coagulating chemicals are used which are able to work within a wide pH range and which are rather indifferent to the size of the dose. For the addition of the chemicals many simple devices have been developed which with proper care are able to work to satisfaction. Mixing of the

chemicals with the water is done most efficiently by mechanical means (flash mixers), but adequate results can also be obtained through hydraulic mixing. Hydraulic mixing is most efficient with a hydraulic jump, but in many cases the turbulence downstream from an overflow weir is also able to do the job. Modern flocculators are of the mechanical type, but hydraulic ones using the turbulence created by the flow of water around baffles can do an adequate job and are simple to construct. Settling offers little difficulty. It can be accomplished in the same way as described for plain sedimentation, with the depth somewhat greater to accommodate the larger amounts of sludge. The effluent from the settling tank always contains some suspended flocs, and subsequent treatment is therefore necessary to obtain the desired clarity. Chemical coagulation is a complicated and expensive treatment and should be avoided as long as possible, preferably by choosing a better source of raw water.

Slow sand filtration. During filtration through a porous substance, the water quality is improved by removal of suspended and colloidal matter, by reduction in the number of bacteria and other organisms and by changes in chemical constituents. In principle the porous substance may be any stable material, but in the field of domestic water supplies beds of sand are used in ninety-nine percent of the cases. Sand is cheap, inert, durable, widely available and gives excellent results. As long as sand can be applied, other materials do not need to be considered.

During the process of filtration impurities accumulate on and between the grains of the filterbed, reducing the effective pore space, and the resistance to the flow of water increases. After some time this resistance becomes so high that cleaning the filter is necessary to maintain its capacity. With slow filters the bed is composed of ungraded fine sand

of an effective size between 0.1 and 0.3 mm. This sand is so fine that the suspended and colloidal matter from the raw water is retained in the very top of the filterbed. The clogged material here may be removed and the filter restored to its original capacity by scraping off this top layer of dirty sand, to a depth varying from one to a few centimeters. To increase the length of a filter-run, that is, the interval between two consecutive scrapings, to workable values of from one to a few months, the filtration rate must be quite small with values commonly falling between two and five meters per day. Two units should be provided, so that one may be used while the other is being cleaned.

Essentially, a slow filter consists of a water tight box provided with an underdrainage system to support the filtering material. Many solutions have been found for the construction of the underdrainage systems. Bricks, stones and even bamboo have been suggested for this purpose. However, bamboo requires frequent renewal because of its putrifying tendency. The walls of the filter can be sloping walls dug into the earth and supported or protected by chicken wire reinforcement and sand cement or sand-bitumen mix. The filterbed commonly has a thickness of 0.8 to 1.3 m, while on top the water to be treated is present to a depth of 1 to 1.5 m. Inlets and outlets should be provided with controllers to keep the raw water level and the filtration rate constant. Modern slow sand filters tend to be of complicated design, often covered to prevent algae growth and provided with mechanical cleaning equipment to save on labour. Older constructions however, are also able to do a good job, while all over the world designs have evolved to use locally available materials and skills to the utmost extent.

Slow sand filters have a tremendous purifying capacity, not to be surpassed by any other single unit operation. They are able to supply a water of excellent clarity, free from obnoxious dissolved impurities and bacteriologically safe. However, the raw water must not be too polluted, and must have only a low suspended matter content. This means the treatment of water from lakes and reservoirs and the final treatment after settling of river water. Slow sand filters can also be used to advantage for the removal of iron and manganese from groundwater after aeration.

Rapid filtration. When large amounts of water or very turbid water must be treated, slow sand filters are at a disadvantage because of their small silt storage capacity in the top part of the filterbed only. More rapid filtration and filtration of more turbid waters is made possible by deep bed filtration, using coarser and in particular more uniform sand grains (approximately 0.8-1.2 mm). Impurities from the raw water now penetrate to such great depths in the filterbed that cleaning by scraping is impossible. Back-washing must be used by reversing the flow of water. This expands the filterbed and scours the grains, carrying the dislodged impurities to waste. Such a way of cleaning a filter is easy and quick, and the length of filter-run may be reduced to one or a few days. Common filter rates for rapid filters vary from 100 to 250 m/day, that is, fifty times the rates used with a slow filter. The filterbed area can thus be reduced.

In developing countries rapid sand filters are used either as pre-treatment to lighten the load on subsequent slow sand filters or as treatment after chemical coagulation, flocculation and settling, to be followed by disinfection only. It should be realized that rapid filtration plants

are quite complicated. Not only the design and construction, but also the operation and maintenance are a matter for experts. This makes them unsuited for rural supplies in developing countries. They can be used where a large number of small supplies can be integrated into a small number of big ones. This increases the cost of transportation, but reduces the number of treatment plants which will require expert supervision.

Activated carbon filtration. With the preceding treatments, removal of taste and odour producing substances is only possible to a limited extent. Removal of taste and odour producing substances can be improved by absorption on activated carbon for which many sources are often available in developing countries. Activated carbon filtration can be effected prior to slow sand filtration in separate units, using high filtration rates and correspondingly smaller filterbed areas, or it can be achieved by topping the bed of a slow sand filter with a layer of activated carbon 0.1 or 0.2 meters thick. When the grain size of this material is two to three times coarser than that of the underlying sand, the length of filter-run will be greatly extended, to six months for example, compensating for the additional labour necessary to remove the carbon layer prior to cleaning the slow sand filterbed by scraping.

Disinfection. Disinfection serves to kill pathogenic organisms by chemical action. On an individual basis the hygienic quality of drinking water can be assured by boiling. This is completely effective, provided that post-contamination during cooling is avoided. Oxidants are most often used for disinfection. For proper results the organic content of the water must be small, and this is best achieved through applying disinfection as the last step in the purification process. The majority of

the most widely used disinfectants cannot be applied in rural areas of developing countries. Gaseous chlorine is too cumbersome and too expensive to transport over great distances, while chlorine dioxide and ozone must be made locally, and usually the necessary skills are unavailable. This leaves as possibilities the chlorine compounds  $\text{NaOCl}$  and  $\text{CaOCl}_2$ , as well as the halogens bromine and iodine. During storage the chlorine compounds are partly degraded into  $\text{NaCl}$  and  $\text{CaCl}_2$ , respectively, decreasing their disinfective powers. Bromine and iodine may be lost by evaporation, but what remains will have the same strength as before.

Dosing of disinfectants is in principle the same as for chemical coagulation. The dosing of disinfectants must be constrained to certain limits. Below certain levels, the disinfectant is ineffective, and above this level the water becomes so unacceptable to the consumer that he returns to the polluted source. Disinfection methods for village supplies normally fall into one of two categories, pot or drip feeders.

#### WATER TRANSPORT AND DISTRIBUTION

Manually operated pumps usually must be obtained from outside the local community. Once they have been installed they need only simple maintenance, and their length of useful life is long. Internal combustion engines must be imported and their proper operation and maintenance is fairly complicated and in many cases cannot be entrusted to the local population. They also require fuel, creating additional financial and managerial problems. When possible, locally available energy sources should therefore be sought. In some instances good results have been obtained with wind or hydraulic power.

For rural supplies in developing countries small diameter pipes will suffice, and they are best made of plastic or asbestic cement, depending

on local circumstances. For a gravity supply operated twenty-four hours per day, the distribution capacity need not be larger than the average consumption per second, provided that an elevated storage tank is installed. With a distribution supply operated twelve hours per day, the capacity of the pipeline must be doubled while the clear water storage may be reduced.

To prevent a sewerage problem from arising it is essential to keep water consumption down, and this can best be achieved by limiting the number of house connections and serving the majority of people with stand-pipes. This also allows a simple lay-out of the distribution system with a minimum number of auxiliaries, thus limiting the cost of construction and facilitating maintenance and operation.



## VII.1. (Continued)

WATER SUPPLIES IN RURAL AREAS  
OF DEVELOPING COUNTRIES (PART TWO)

Willem van Gorkum and Kees Kempenaar

## PLANNING AND DESIGN

Finance is usually a difficult item in the planning and designing of drinking water projects in developing countries. Many water projects are started with international bilateral or multilateral aid. A disadvantage of this finance system is the dependence of the developing countries on the fund-giving country. For example, it is usually the practice that developing countries have to buy the materials and equipment which they need for the project from the country giving the support. Another disadvantage can be that some developing countries spend those funds on expensive and overly-sophisticated supply plants. A good finance system for village drinking water projects has been applied in South America. The first village sets up a drinking water project from outside funding, and after the start of water delivery the village pays back the funds. Then a second village uses the funds returned by the first village to start its own drinking water project. As this process is repeated, the funds needed to start only one programme can be used for a whole region.

When initiating planning and designing one needs data on the population, the region and the raw water sources. A knowledge of historical consumption patterns including peak demands, and average total and personal demand is important. Population inflow and outflow have a great

Rural Water Supply in Developing Countries. Prepared in Delft, The Netherlands, at the University of Technology, for Norman: University of Oklahoma Bureau of Water and Environmental Resources Research, 1975. (210 pp.)

influence on the total consumption, just as do agriculture (irrigation) and industrial development. A new or improved water supply usually will mean higher consumption patterns. According to White, Bradley and White, there are at least seven factors affecting the amounts of water withdrawn by individual households: the size of the family, income level, education, cultural heritage, character of water supply, cost of obtaining water as measured by energy or cash expenditure, and climate and terrain (110). Moreover, some demand occurs as a result of leakages and waste in the system. Livestock and gardening can also be important factors in water demand in rural areas.

Because of limited financial resources rural water systems in most cases serve their consumers predominantly through public standposts and only selectively through house connections. Generally we can say that when there is a supply in the house or courtyard, the demand may be five or more times greater than when water has to be withdrawn from a public standpost. If water has to be carried a considerable distance, more than one mile for instance, consumption may fall to as low as five liters per capita per day, which approaches the minimum necessary to sustain life. Limiting a piped rural supply may inhibit desirable expansions, but designing on urban or semi-urban scales will be an unrealistic over-investment. Moreover, piped supplies into rural homes may precipitate problems of wastewater disposal sooner than they can be solved.

A review of some standards of water use extracted from national publications or from available project reports shows figures of about forty to sixty liters per capita per day where public standposts are used, and a greater range of from about fifty to 200 l/cap/day for house connections. Figures for traditional sources, including wells and springs,

range from five to thirty l/cap/day (47). The World Health Organization's Statistical Report gives data on average daily consumption in rural areas. (See Table VII.1.1.) Evaluation studies show that the price of water has a great influence on the consumption pattern.

The problem of energy supply is an important item for water supply projects, especially in developing countries. For example, oil energy is very expensive and can present supply problems. A low cost local energy source solves these difficulties. In the future, wind, water power (the hydraulic ram) and sun energy may provide suitable energy sources.

#### DATA COLLECTION

The capacity of raw water sources. A good design of any water supply starts with the identification of the alternative raw water sources. Reliability, the ability to deliver sufficient quantities 365 days a year, is the most important factor in the choice of raw water sources to prevent consumers from being driven to other, unsafe sources in periods of water shortage, thereby counteracting the advantages of their safe supply during the remainder of the year.

An organized data collecting programme is of the greatest importance in the national and regional programming for water supply in the developing countries. For precipitation as a source we need to know the quantities and the spatial and temporal distribution of rain and snow. When we use surface water from streams, lakes or reservoirs, we want to have data on evaporation, and on the quantities and distribution of surface runoff. For groundwater use we need data on the quantities and distribution of soil moisture and on the location and properties of the different ground layers. The collection of such data could

TABLE VII.1.1  
 AVERAGE DAILY CONSUMPTION IN RURAL AREAS  
 (Liters per Capita per Day)

	Minimum	Maximum
Africa	15	35
Southeast Asia	30	70
Western Pacific	30	75
Eastern Mediterranean	40	85
Europe (Algeria, Morocco, Turkey)	20	65
Latin America and the Caribbean	70	190
World Average	35	90

SOURCE: World Health Organization statistical report.

be undertaken most economically through the use of integrated measurement and observation systems. Photogrammetry and remote sensing techniques are methods which deliver some data in a quick and easy way. Equipment can be used for test drilling, water analysis, and measuring differences in ground elevation, distances, and streamflows. Other equipment may be used for topographic surveys, and pumps may be used for testing the yield of available water sources. Data on the sites and seasonal delivery of existing wells, on the seasonal pattern of riverflow, or on the existence of natural springs, ponds and lakes in the neighbourhood of a community may be obtained from local residents if care is taken in the interpretation of this information.

The quality of water. Investigation of the raw water sources should be made in order to determine what treatment it may be necessary to apply. The designer must retain human health as the most important issue. For hygienic reliability you start with the investigation of the biological character of the water. The indicating method of the coliform group of bacteria is well-known and widely used. The possible temperature problem in tropical circumstances has been described by J. Kreysler (53). The chemical character in many cases does not have such direct influence on health as does the biological character. The physical character is directly noticed by the consumers and is thus usually of greater importance to him than the biological or chemical characteristics of the water, although the physical characteristics may not have much influence on the health of the users.

## SOURCES

Where alternative raw water sources exist, the choice of the preferred source is likely to depend upon reliability, safety and economy, in that order. Water, which requires no treatment to meet bacteriological, physical and chemical requirements and which can be delivered to the consumer by a gravity system should be given first consideration. Water which requires no treatment but which must be pumped to the consumer would be the second choice. Water which requires simple treatment but which can be delivered to the consumer through a gravity system should be given third priority consideration. Water which requires both simple treatment and which must be delivered to the consumers by pumping would be the next choice (106).

Groundwater. Often one of the first steps in the improvement of the water supply is the improvement of existing wells, by well protection (surface drainage around the well and covering of the wells) and addition of pumps. Wells for the extraction of groundwater may be classified as shallow or deep wells. We can almost always rely on the bacteriological safety of the water from deep wells. The water from comparatively shallow wells can be expected to be safe also, as long as short circuiting is prevented. The principles of well construction, such as digging, boring, jetting, and driving with all their variants are well described in various handbooks (39,106).

The casings of tube wells are now often made of polyvinyl chloride (PVC) which decreases the problem of corrosion. In some countries, however, there are difficulties in cutting the very fine slots in the PVC for the screens or strainers. The use of PVC is too expensive for some communities. Research on the use of locally available materials is

going on, an example of which is the bamboo tube well first engineered by a village farmer in Bangladesh (7).

With the increase of tube wells, the hand dug well has become less popular. However, the interest in dug wells is reviving. Modern materials, tools and equipment, often locally produced, may transform crude holes in the ground, host for parasitic and bacterial diseases, into more safe, soundly engineered, hygienic and reliable sources of water. Dug wells are inexpensive and easily constructed and maintained by fairly unskilled labour. Moreover, dug wells will always be the best solution for shallow, low yielding aquifers because the storage within the body of the well itself allows the water collected during the night to be available for use during the hours of peak draw-off the next day. They are the best solution also for inaccessible regions where transportation of drilling equipment is difficult. Dug wells do have distinct limitations, however. They cannot be used to reach groundwater at a depth larger than twenty to thirty meters. Their capacity is usually low. Well digging technology is understood and used in most countries, but the art of lining wells has regressed, and there is an important need for improved linings. The liner protects against caving and collapse and prevents polluted surface water from entering the well. The main problem is in lining the walls below the level of the water table. Another need is for safer, more rapid, and more efficient digging.

The horizontal well system, an improved spring-development process, has many possibilities for providing and conserving reliable water in geologically appropriate areas. A horizontal well is a "cased" spring. A horizontal boring rig is used to drill a hole and install a steel-pipe casing into a mountain or hillside to tap a trapped water supply.

Drilling time has averaged about thirty-two hours per producing well. Horizontal wells are drilled at promising sites where springs, seeps, or traces of water are found. Occurrence of phreatophytes, dried up springs and favorable geology are all indicators used to select the drilling site. No pumps are needed. Horizontal wells protect against contamination by such things as animals, dust, or erosion and maintenance costs are insignificant in comparison to those of other systems for harnessing springs. If the flow is very low, a storage tank can be added to accumulate water during the night or off-season. With adequate storage, spring sites that flow only during a few weeks in the year may be useful. Successful yields have varied from one to 230 liters per minute; most were in the ten to forty liter per minute range. Horizontal drilling equipment is currently manufactured which is simple, portable, and dependable. The drilling process involves a rotary, wet boring horizontal drill stem rig, a carbide-tipped or diamond-core drill bit, a small recirculating water pump, a cement slurry pressure tank, a drill water supply, and a few standard plumbing tools and supplies. Horizontal well drilling is quite a different technology from vertical drilling, and skill, patience, and field experience are required to master it (69).

Rainwater, catchment, storage, and evaporation control. On a small scale, such as for individual households and small villages, rainwater harvesting is particularly suited. In arid areas it would always be a good policy to supply public buildings such as schools and other community centres with roof catchments and storage capacity so that the community would have some water in storage for emergency use. The size of the catchment area, just as the content of the storage tank, depends on the



intensity and the distribution of the natural rainfall and water consumption. Theoretically, twenty-five mm (one inch) of rainfall over  $9.3 \text{ m}^2$  (100 square feet) of horizontal surface will yield 236 litres (sixty-two U.S. gallons) of water. Allowing for losses due to evaporation, it may be safely estimated that 190 litres (50 U.S. gallons) will reach the storage tank.

For individual households roof-catchment will be the first solution to consider, although poor roofing may call for some improvement before being used for this method. This can be done by the inhabitants themselves, but attention has to be given to the fact that the quality of this kind of water supply is affected by the nature and the degree of maintenance of the catchment surfaces and the collection troughs. Rough surfaces are likely to retain wind-blown dust which is later collected by the rainwater. Galvanized iron roofing provides excellent, smooth surfaces for the collection of rainwater.

Methods of ground catchment include alteration. This means simply clearing the slopes of a hill of rocks and vegetation, sometimes compacting the soil surface and making ditches or rock walls along hill-side contours. When erosion is not excessive, this can be a very economical solution. Another method is soil treatment. This can be the use of chemicals which fill the pores or make the soil hydrophobic, but it can also be ground stabilization with lime. This is an old technique, now scientifically approached, whereby lime is added to the soil and the soil is compacted. A third method is soil covering (56). The soil is covered with waterproof membranes or asphalt layers. Sometimes the membranes have to be covered with gravel to protect them against damage by radiation, wind or cattle. There are many different synthetic sheet

materials which are very well suited for catchment purposes, but most of these materials are oil derivatives, and their cost could increase with the price of oil.

The rainwater storage tank consists in its simplest form of an oil drum and in its most complex form of a reinforced concrete cistern. Sometimes small reservoirs are used. To strain out suspended matter, sand filters may be built at the entrance of storage tanks; however, one can never rely on the safety of such water, so that disinfection will always be necessary.

Great losses may be experienced from evaporation during storage, particularly with the use of small reservoirs. To reduce these losses, the adaptation of monolayers of aliphatic alcohols and other liquid chemicals is a possibility. It seems to be very difficult to keep the alcohol barrier intact because of wind and water action. Furthermore, the films do not reduce the amount of solar energy which the water absorbs, and they decrease the amount of heat normally lost, because inhibiting evaporation also inhibits the cooling effect of evaporation. Thus, the higher water temperature increases evaporation at any part of the water surface which the barrier does not cover. A better solution seems to be wax that softens due to the heat of sunlight and flows over the water surface to form a flexible, continuous film. The film can crack during cold weather, but the heat of the sun will reform it again. Blocks of floating and, if possible, light coloured reflecting materials have also been used with reasonable success. In the Sudan sand filled reservoirs have been used. The disadvantage of this system is that the required tank volume increases considerably. Another method is simply to cover the tank, but it may be cheaper to build additional catchments

to make up for the quantity of water lost by evaporation rather than to provide a cover. However, there could be several additional reasons for covering, such as prevention of pollution, algae-growth or mosquito breeding. For small reservoirs it may be economical to build deeper reservoirs with a smaller surface area.

Surface water. With surface water sources the following points can be of importance. Water from natural ponds and lakes would be more uniform in quality than water from flowing streams. Self-purification is usually less complete in smaller lakes than in large ones. Deep lakes may throw up microscopic organisms during seasonal overturns. Impounding reservoirs may pose algae problems near the surface, while water near the bottom may be high in turbidity, carbon dioxide, manganese and occasionally hydrogen sulfide. In arid lands, due to evaporation, the salinity of water in lakes and reservoirs can rise considerably. Irrigation water sometimes contains pesticides or fungicides used for agricultural purposes, and these additions may not be removed by regular treatment processes.

Salt and brackish water. Several years ago P. Hoffman, Managing Director of the United Nations Special Fund, reported that "at least sixty of the underdeveloped countries and territories associated with the U.N., face forms of water shortage which in time can be met only from non-traditional sources, that is, from brackish and salt water sources." (93) There are nearly 1,000 desalination plants in operation in various parts of the world with capacities ranging from 100 m<sup>3</sup>/day to 30,000 m<sup>3</sup>/day. Despite the many research activities in the last fifteen years directed towards improvements in technology, the cost of water from the various desalting processes remains high. The

theoretical energy required to remove salts from a solution is a fundamental factor given by the laws of thermodynamics so that for reducing costs, measures are required that will reduce energy losses and improve efficiencies through economies of scale, multipurpose application (particularly when linked to power generation), extended plant life, and lower maintenance requirements. Even for solar stills using solar energy the costs are high at present due to the need for large amounts of capital and a large land area for production of even small amounts of fresh water. Costs of desalination are from five to ten times those of conventional alternatives, and generally desalination should only be considered as an alternative to fresh water transported by pipelines when pipelines longer than 200 kilometers are required.

Desalination processes include the use of evaporation (distillation), membranes (reverse osmosis, electrodialysis), freezing or chemical means. In rural areas of developing countries reverse osmosis and the solar still are the most appropriate technologies (8). Membrane processes have certain advantages over distillation. Large metallic components such as heat exchange pipes are not required. High capital investment equipment such as tube rolling and milling machines are not needed. Capital and operating costs for the small membrane plants are about half those of distillation plants. Membrane process equipment can be manufactured with local materials and manpower. Membrane plants are simple to construct and operate, and there are no corrosion or scale problems. Of the membrane processes, reverse osmosis is preferred because of lower energy consumption, complete removal of bacteria and viruses, little sensitivity of the process to salinity changes in brackish water, low maintenance requirements (except for the high pressure

pumps), and no requirement for highly skilled operators for plant operation.

#### TREATMENT

Disinfection. Lack of money and knowledge of techniques in rural areas of developing countries in many cases causes disinfection to be the only feasible drinking water treatment. This means chlorination in most cases. The pot or cartridge method of dosing utilizes a pot of some type which is filled with bleaching powder or another disinfectional substance and is hung in the water to be treated. The only operation necessary is renewal of the disinfectional substance from time to time (16, 88, 125). Greater storage capacity may be used in developing countries to avoid transportation problems. However, as chemicals for disinfection become overaged, the activity of the substance decreases (17). For in-country manufacturers, small factories dispersed throughout the country would be a better solution than one big factory serving the needs of the entire country. When distances are short, the supply of chemicals will be frequent and storage will be less important.

Sedimentation, flocculation and coagulation. There may be some future for tube settlers made of locally produced plastic pipes (123).

A new trend in the coagulation process is the magnesium carbonate process (86). It is complicated but has the advantages of recycling of coagulant, elimination or reduction of sludge disposal, additional disinfection due to high pH, removal of iron and manganese, production of a water with adequate hardness and alkalinity to allow corrosion control by stabilization of the water, and potential savings in treatment costs.

Filtration. In situations of individual supply or small village supply, simple filter systems give good results (62,120). The advantage with these systems is that local materials may be used and the operation is uncomplicated. The so-called drum filter is a good example. Another example is a horizontal slow sand filter, which can be a very simple solution for water of low turbidity, at least when there is sand available in the region (57).

Slow sand filtration is uncomplicated in management and maintenance, utilizes unskilled labour and produces clear, hygienically reliable water (35,46). The biological purification of slow sand filtration is better under circumstances of higher temperature, an advantage in tropical areas.

In some cases where the raw water supply is limited, intermittent supply is provided. For filtration plants this practice creates problems because the bacteriological action can function in an optimal way only with continuous filter operation. With no food the bacteria become less in number and bacteriological purification is lessened. Intermittent slow sand filtration can be used to retard the growth of algae, but generally continuous operation is preferred.

A development in the use of slow sand filters has been operation with alum-coagulated water (1). Declining the rate of filtration is another development which may be an advantage in filter control (25). Local filter media may be used in areas with sand selecting problems or scarcity (37). The problem of the grading of sand can be solved by upflow during back-washing when a natural selection takes place (79). The multi-media filter is another way to lengthen a filter run, the grading taking place due to the difference in weight of the different media (84).

Demineralization. Demineralization including desalting may be accomplished in rural sunny areas through a kind of distillation by a solar still which uses solar energy. Through a transparent cover water is warmed by sun heat. This causes evaporation and condensation against the cover, and the condensate is collected. For individual and for community use many experiments have been conducted in the field of solar stills (8,54).

Defluoridation is a great problem in some areas. The Nalgonda technique of defluoridation comprises addition in sequence of sodium aluminate or lime, bleaching powder and filter alum followed by flocculation, sedimentation and filtration (70).

#### WATERLIFTING AND PUMPS

In the face of possible energy shortages there can be revived possibilities such as windmills and animals, and in the future solar energy may be used. One other development is the hydraulic ram. Its operation requires the presence of different ground levels and sufficient amounts of water (108). An important single pump engine is the Humphrey pump, which has the advantage that different kinds of energy can be used so that the pump can be adapted to several circumstances. A simple handpump is sometimes a good solution also.

#### DISTRIBUTION

Storage. There are two different types of storage, namely, raw water storage and clean water storage. Raw water storage with plain sedimentation can provide a simple, effective and self-contained treatment under favourable conditions. Large impounding reservoirs, natural lakes and ponds serve such purposes in many cases. They produce multiple

benefits: equilization of a fluctuating flow, sedimentation of silt and suspended matter, oxidation of unstable organic impurities, reduction of colour, turbidity, and pathogenic organisms and evening out of quality fluctuations. Sometimes sedimentation basins are provided as the only treatment before disinfection. In those cases at least from one to several days of settling have to be provided before the water is drawn out for use. Long storage, however, particularly with alkaline water, can give algae problems. Where the storage cannot be limited to an optimum of two to three weeks, measures must be taken to control algae, for example, copper sulphate dosing.

The clear water or service storage performs several functions in the distribution system. As storage to provide for fluctuating demand, it permits pumps and filter plants to operate at constant rates and ensures economy in their size and capacity. In the case of an elevated reservoir, more uniform pumping heads are possible which facilitates the selection of pumping sets operating at a high efficiency. It ensures the necessary pressure in the whole or in part of the distribution system. In emergency cases adequate storage within the system will assure uninterrupted supply regardless of power failure, plant breakdown, normal maintenance periods and fire-fighting. It allows pumping to take place during parts of the day only.

Storage tanks, both ground level and elevated, lend themselves readily to type designing and to the adoption of locally available skills and materials. The avoidance of complicated pipe work, the use of thin block or masonry skin walls filled in with mass concrete instead of the traditional reinforced concrete design, the restriction of the number of types and sizes to a minimum (even if this involves over-capacity in



some instances) are possible ways of economizing on imported materials and on design and construction staff. Steel tanks have an advantage in their speed of construction, but they need regular painting and do not last as long as concrete.

If the topography is suitable, reservoirs are constructed on elevated ground; in other cases they are supported on towers. In traditional Islamic countries there is no other tower allowed besides the minaret, and pumping has to be chosen.

Usually, elevated reservoirs are not designed to "float on the system." Instead, all water is pumped the full height to the top of the reservoir and then flows to the village by gravity. This is a wasteful use of power. However, the custom of pumping all water into the reservoir is so ingrained that it is difficult to obtain acceptance by engineers of the concept of direct pumping into the distribution system with only the excess over demand going to the reservoir.

Pipes. In urban supplies more than half and usually two-thirds to three-fourths of the total investment in the community water supply goes into the distribution system. In rural areas the supply is in many cases operating without any piped distribution system or with a simple system supplying water to several public standpipes only. A distribution system generally consists of pipes, accessories such as valves and meters, and servical connections. The pressure and the amounts of water which have to be delivered are the important parameters for the design size and material of pipes. Generally, the choice for pipe material will be steel, cast iron, spuncast iron, prestressed concrete, asbestos cement, or plastic for medium and large diameters, and asbestos cement, galvanized iron and steel or plastic for smaller diameters; copper and lead piping

have but limited use and for specific purposes only in home plumbing (104).

The use of bamboo has drawn much attention, and in Indonesia this material is used for gravity systems in rural areas. Bamboo systems are easy to construct by unskilled labour, and bamboo is cheap in those countries where it is available. There are, however, many problems which have to be solved before bamboo systems can compete with the traditional systems. One of the problems is that bamboo is not suited for pressure systems since the maximum allowable pressure is about two atmospheres. The duration of bamboo is relatively low, from about three to five years, although a great deal of research is being conducted to find suitable conservation methods. Another disadvantage is the bad taste and odour which is present in the system during the first weeks of use.

Plastic pipe deserves special attention because of the properties which make it suitable for adoption in developing countries. The main advantages of plastic pipe are its relatively low cost and its suitability for local manufacturing due to the availability of raw materials on international markets and the low cost of equipment required for the manufacture. As for the mechanical properties of plastic pipe we can mention the following attributes as advantages: excellent resistance to corrosive water and corrosive soils, bacteriological inertness, low thermal conductivity, extreme lightness, flexibility, smooth internal surface, very low water absorption, availability in greater lengths, good workability. The main drawbacks are the following: temperature sensitivity (decrease in the mechanical strength with an increase of the temperature), relatively high thermal expansion, sensitivity to light

(ultraviolet light) and weather (weatherability), sensitivity to notches, particularly PVC pipes, decrease in impact strength of PVC with decrease in temperature, diffusion of odorants and other very volatile gasses through the wall of polyethylene (PE) pipes, sensitivity to organic solvents such as ketones, ethers and chlorinated hydrocarbons, detrimental effects to the water of the plastics or of additives used in manufacture.

Pipe appurtenances such as specials, joints, clamps, and valves and fittings form a sizeable portion of the network system. Their quantity should be minimized by careful design.

A very important factor in water systems design, especially in long-range development programmes, is the standardization of materials and equipment. Easy availability and the ability to interchange pipe materials throughout a region or country is an asset in efficient maintenance.

Service connections. The change from standpipe to houseconnection seems to be progress because of the increased convenience which results in savings of time and effort due to the elimination of the necessity to carry and store water. There are situations, however, where there is no economic or social replacement for standpipes. Nevertheless, the public standpipe has some great disadvantages. One is that the collection of water charges is difficult because of the large number of people supplied from the same point with different levels of service. Another disadvantage is that the maintenance of a public standpipe is difficult because of careless use by many people, none of whom considers it his property.

One often sees in the literature reference to the great amount of waste in the water supplies of many developing countries, either with standpipes or with house connections. When supplies have pressure on the distribution system only a part of the day, it is often the case that in the beginning of the period of water delivery there is a large queue at the standpipe and in the houses the storage tanks are being filled. An hour later there is no one at the still flowing standpipe, and even the reservoirs in the houses are running over with no one to attend them. A solution for this type of waste could be the adoption of special devices like the fordilla faucet, a spring loaded mechanism which closes automatically after a few seconds and can discharge a fixed amount of water each time it has been pressed. The disadvantages of this system are the difficulties in repairing them and their need for substantial pressure to function adequately. Another solution could be the adoption of constant flow valves which can reduce the use from twenty-five to thirty percent. A solution for certain situations would be metering, where everyone would pay for the water he actually consumes. Meters are comparatively short-lived and require testing and servicing, including a trained staff for reading, billing and collecting. All of these elements contribute to the cost of such a method. A simple and economic solution to water conservation is the use of smaller diameters for the pipes.

#### CONCLUSIONS

In large cities in developing countries the plants for treatment of water supplies are usually fairly complicated as in more developed countries, but these plants supply a small part of the population in the developing countries with drinking water. Outside the large cities

there are a relatively small number of treatment processes used in developing countries. Where the people are concerned about a community water supply they consider treatment as a second stage in development, the first stage being to find a reliable water source. In some development programmes for drinking water supplies this policy results because of economic reasons.

In developing countries there is a shortage of evaluations of existing plants. There are many assessment reports on countries or regions, but these are mainly limited to general remarks on such items as percentages of people supplied with reliable water, percentages of standpipes or house connections, number of drilled tube wells, departments responsible for developing programmes, or financial restrictions. There are seldom reports which give such information as a technical evaluation of existing plants or current programmes, the technical performance of plants or parts of it, causes and duration of breakdowns, connection between the latest and former breakdowns, or possibilities of repair. This kind of data seems necessary in dealing with supply of drinking water in developing countries. Currently for most designing of community water supplies in developing countries, reliance is placed on the judgement of a few individuals such as staff members and consultants of the World Health Organization and the World Bank, on the enthusiasm of the army of volunteer workers, or on the conscience of those undertaking commercial projects. For many projects the planning and construction take place under the supervision of the World Health Organization. After the project is finished, further responsibility is turned over to local authorities. It seldom happens that the initial project managers obtain operating information on their former projects.

Proper evaluations are needed, though there is a problem in obtaining financing for such efforts, since evaluation projects seem to have only scientific value and not to contribute directly to the supply of more water.

## VII.2.

STUDY OF AN EXISTING WATER TREATMENT PLANT  
OF SIMPLE DESIGN AND OPERATING SYSTEM FOR  
SUPPLYING DRINKING WATER TO RURAL COMMUNITIES  
IN THE LOWER MEKONG BASIN COUNTRIES:  
STUDY OF A SLOW SAND FILTER

Thailand Ministry of Public Health, Department  
of Health, Rural Water Supply Division

## INTRODUCTION

Sand filtration remains the main concern in water treatment in Thailand. In rural areas where modern techniques and qualified operators are insufficient, simply constructed and operated systems like the slow sand filter are recommended.

The purpose of this research was to study problems associated with the design and operation of an already installed slow sand filter. The data and information gathered included loading, operational difficulties, operation cost and income, process efficiency, and the population and society of the village served. This study began in June 1975. All the data and information collection was finished in April 1976. The report was completed in July 1976.

The sand filter under study is located in the Sanitary District of Nong Ko, Amphoe Kranuan, Changwad Khonkaen. The slow sand filter at Kranuan was constructed in 1971 under the responsibility of the Rural Water Supply Division, Department of Health. The plant is located in the northeastern part of Thailand about 500 kms from Bangkok. The

construction cost including the treatment system and main distribution pipe was about 1,100,000 baht (1 \$ = 20 baht) with the government contribution equal to 500,000 baht and the local contribution equal to 680,000 baht.

This plant is designed to serve 9,563 people with the capacity of 100 m<sup>3</sup> per hour. The plant is composed of two slow sand filter units, each with a capacity of 50 m<sup>3</sup>/hr, and there is also a space reserved for future expansion.

The water source of the slow sand filter plant at Kranuan is a reservoir eight kilometers from the plant. Raw water is pumped by a diesel engine pump from the reservoir. It can first pass into an earth sedimentation pond (existing pond) of about 22,000 m<sup>3</sup> capacity. However, at this time the pond was not being used, since the raw water quality was good with turbidity absent. Raw water was being pumped to the filter unit directly. The water flows by gravity through the filter, passes the filter rate control chamber and flows into a clear well. In the clear well, a chlorine solution is fed by gravity to mix with the filtered water before being pumped to an elevated tank. After that, water is distributed to the consumer through main pipes of 8", 6", 4" and 2". The plant operates continuously except once a year when the storage tank is washed.

For operation of the water supply a fourteen member sanitary district committee is in charge. The chairman is the Sheriff. There are two operators, one with a fourth grade education and one with a seventh grade education. They were trained by the Division of Community Water Supply. The starting salary was 500 baht, and the present salary is 720 baht. The responsibility of the operators includes engine operation,



water fare collection, pipe connection, and maintenance of the system. For major technical problems the Community Water Supply Center is consulted. Water fees are determined by meters (3 baht/m<sup>3</sup>) and there are no public taps. (See Figures VII.2.1-4 for views of the filter plant.)

#### WATER CONSUMPTION AND EXPENDITURES

Design criteria (consumption). For the construction of water systems, the Rural Water Supply Division has the following design criteria:

plant life	- 10 years
maximum day demand	- 1.5 x average day demand
peak hour demand	- (4.0 x average day demand)/(24)
maximum pumping day	- 15 hours
population growth	- 3%
total storage	- 70% average day supply
elevated storage	- 20% average day supply
per capita consumption	
Sanitary District	- 80 lpcd
common village	- 50 lpcd
pipe material	- asbestos cement, PVC, galvanized steel
distribution system life	- 15 years
minimum pressure	- 10 psi at the curb, distribution.

#### Kranuan plant (consumption).

population design	- 2,000 houses, 9,817 people
present population served	- 271 houses, 1,725 people
present maximum day demand	- 144 m <sup>3</sup>
present average day demand	- 135 m <sup>3</sup>

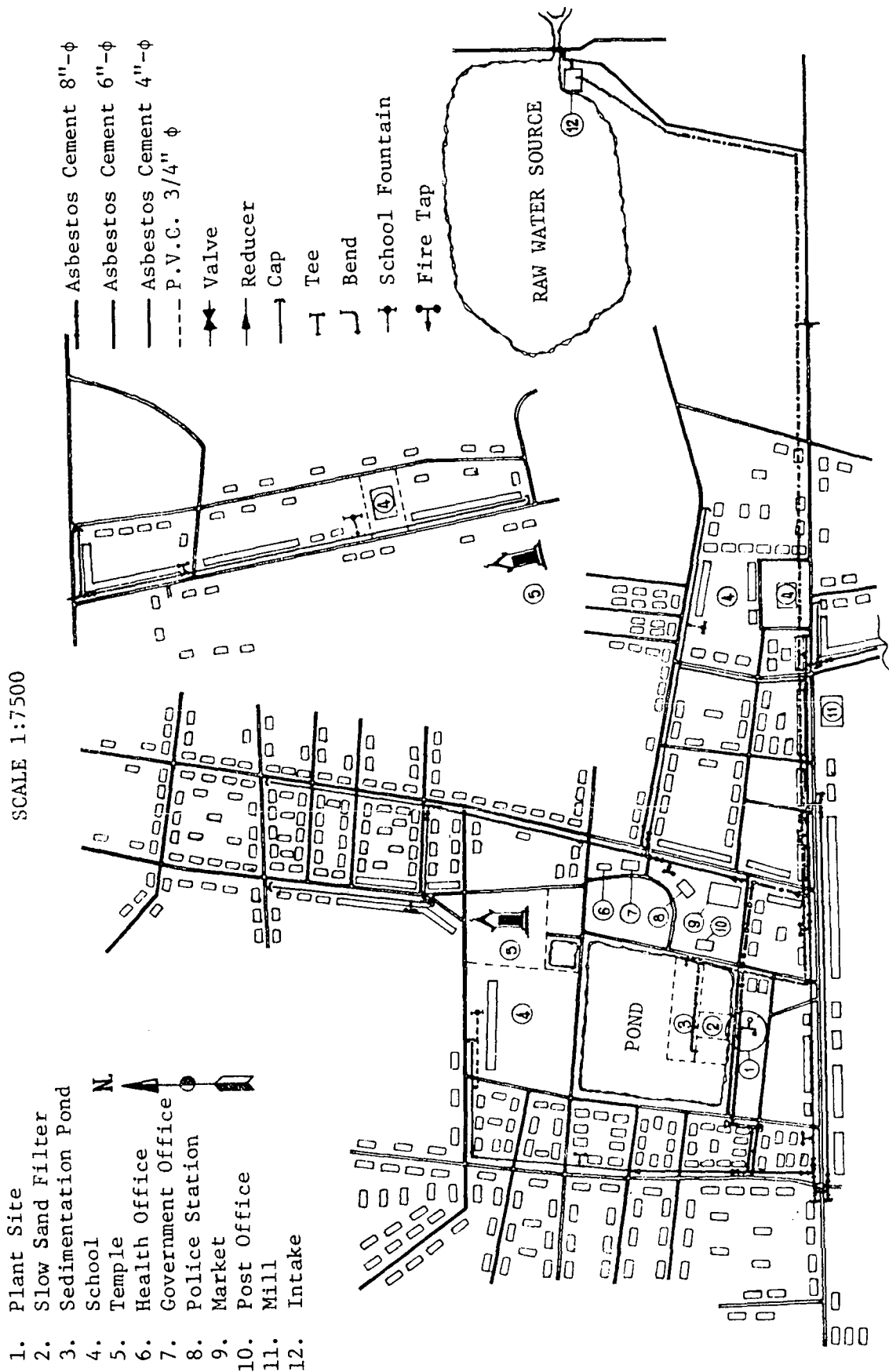

Fig. VII.2.1. Map, distribution system of A. Kra-Nuan.

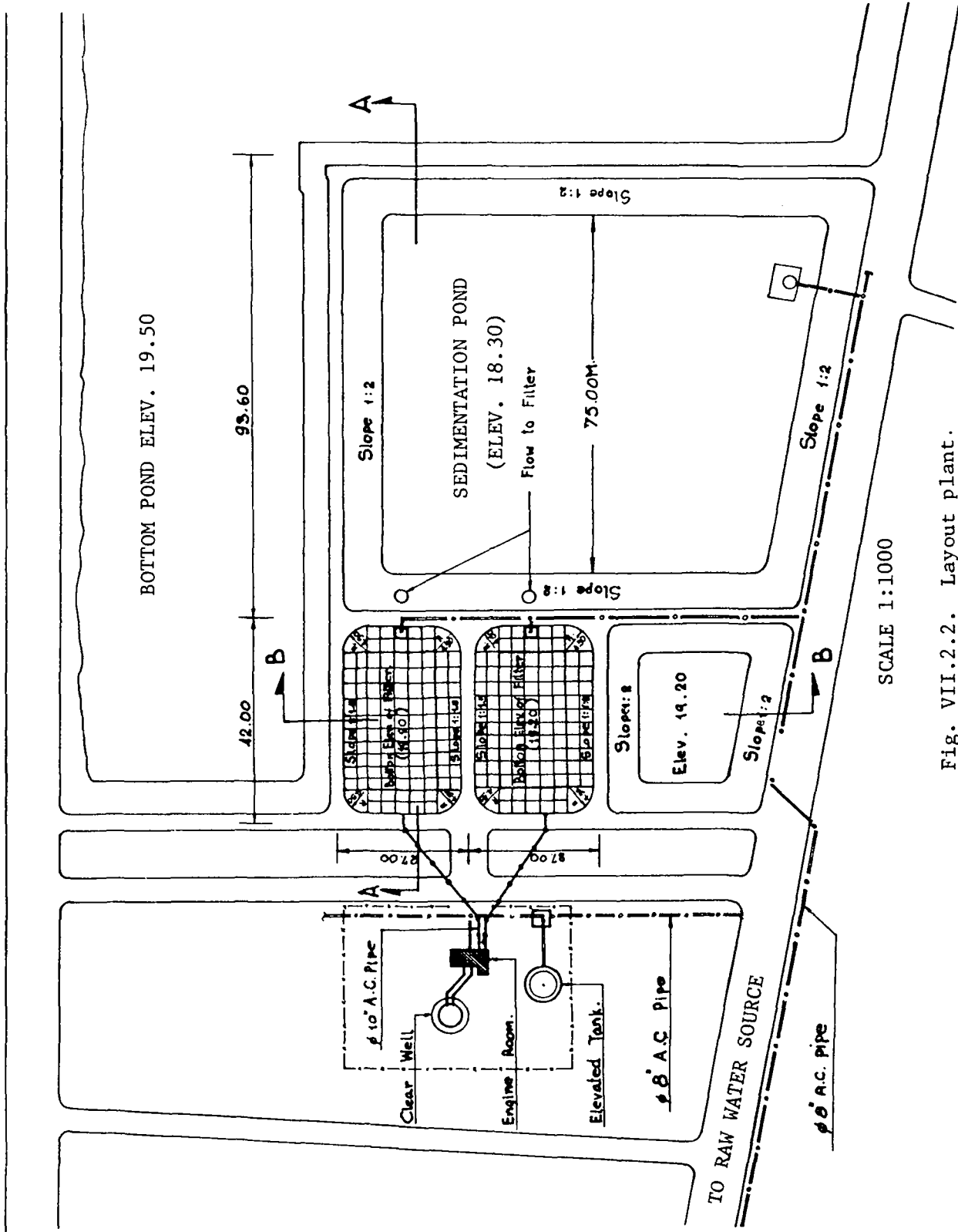

Fig. VII.2.2. Layout plant.

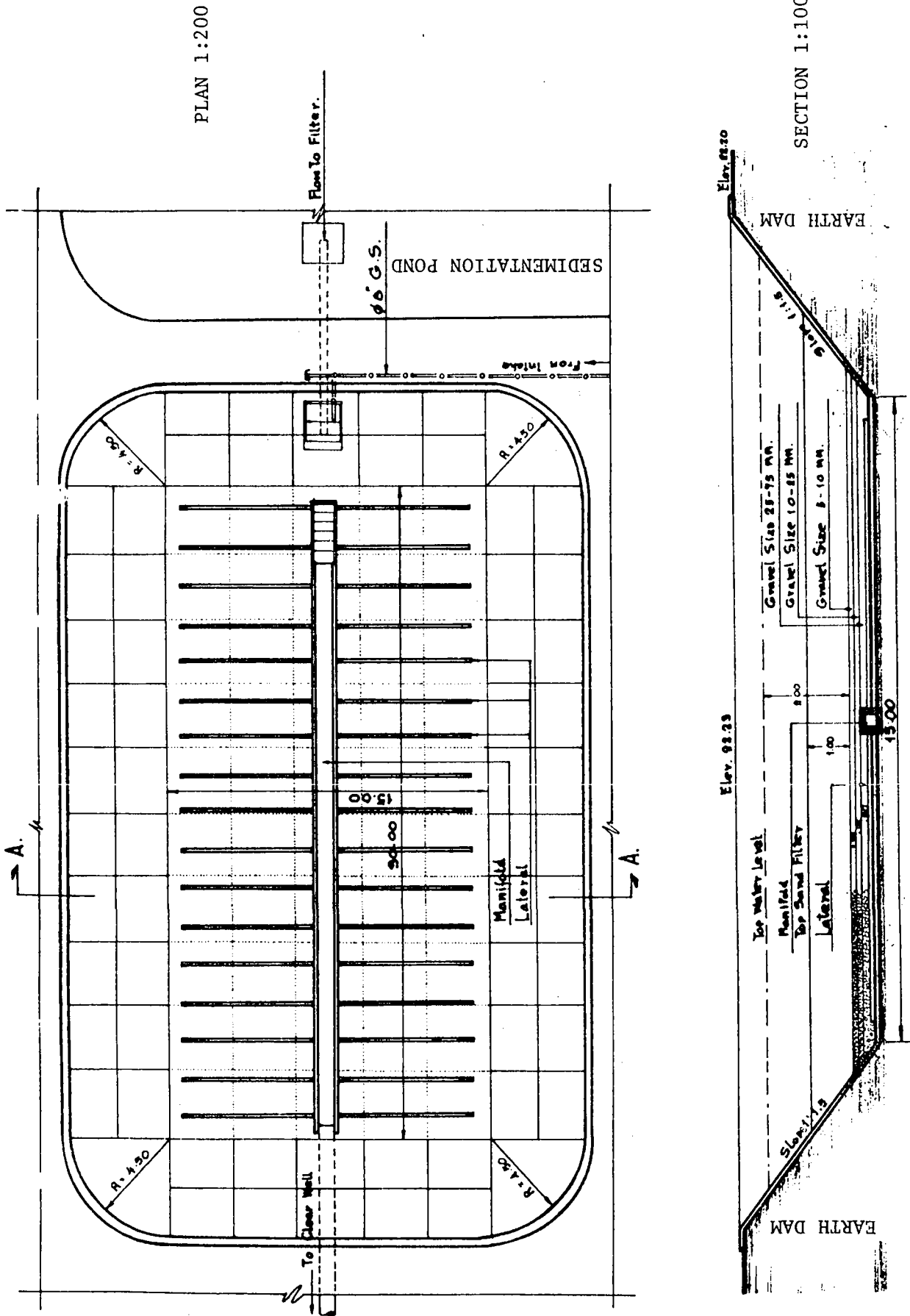

Fig. VII.2.3. Plan and section.



present peak hour demand	- 10.25 m <sup>3</sup>
present average pumping day	- 3.43 hours
present maximum pumping day	- 5.50 hours

The maximum day demand for the Kranuan plant is only 1.07 of the average day demand. Also, the peak hour demand is only equal to  $(1.82 \times \text{average day demand}) / (24)$ .

Referring to Figure VII.2.5 figures for per capita consumption can be obtained. The average per capita consumption of 78.5 lpcd is very close to the criteria of 80 lpcd set for a sanitary district. An interesting point is that the mode (the value occurring more often than any other among a set of observations) shows thirty percent of the houses have a per capita consumption of 39.2 lpcd which is less than the criteria of 50 lpcd set for a common village area. The standard deviation from the average is  $\pm 28.3$  lpcd, thus including values lying between 50 and 107 lpcd. The daily consumption per capita analysis does not include the consumption by a sawmill which draws about 23 m<sup>3</sup>/day, nor does it include consumption by the three schools which use about 5 m<sup>3</sup>/day each.

Figure VII.2.6 shows two peak hour periods of 9.5 m<sup>3</sup>/hr at 08.00 in the morning and 10.25 m<sup>3</sup>/hr at 18.00 in the evening, with the twenty-four hour average of 5.8 m<sup>3</sup>/hr and a daytime average (06.00 - 20.00) of 7.4 m<sup>3</sup>/hr. The data were collected from January 15 to February 15, 1976.

Expenditures. The monthly expenses can be divided into four categories (see Table VII.2.1).

fuel for the raw water pump	27%
electricity for the filtered water pump	14%

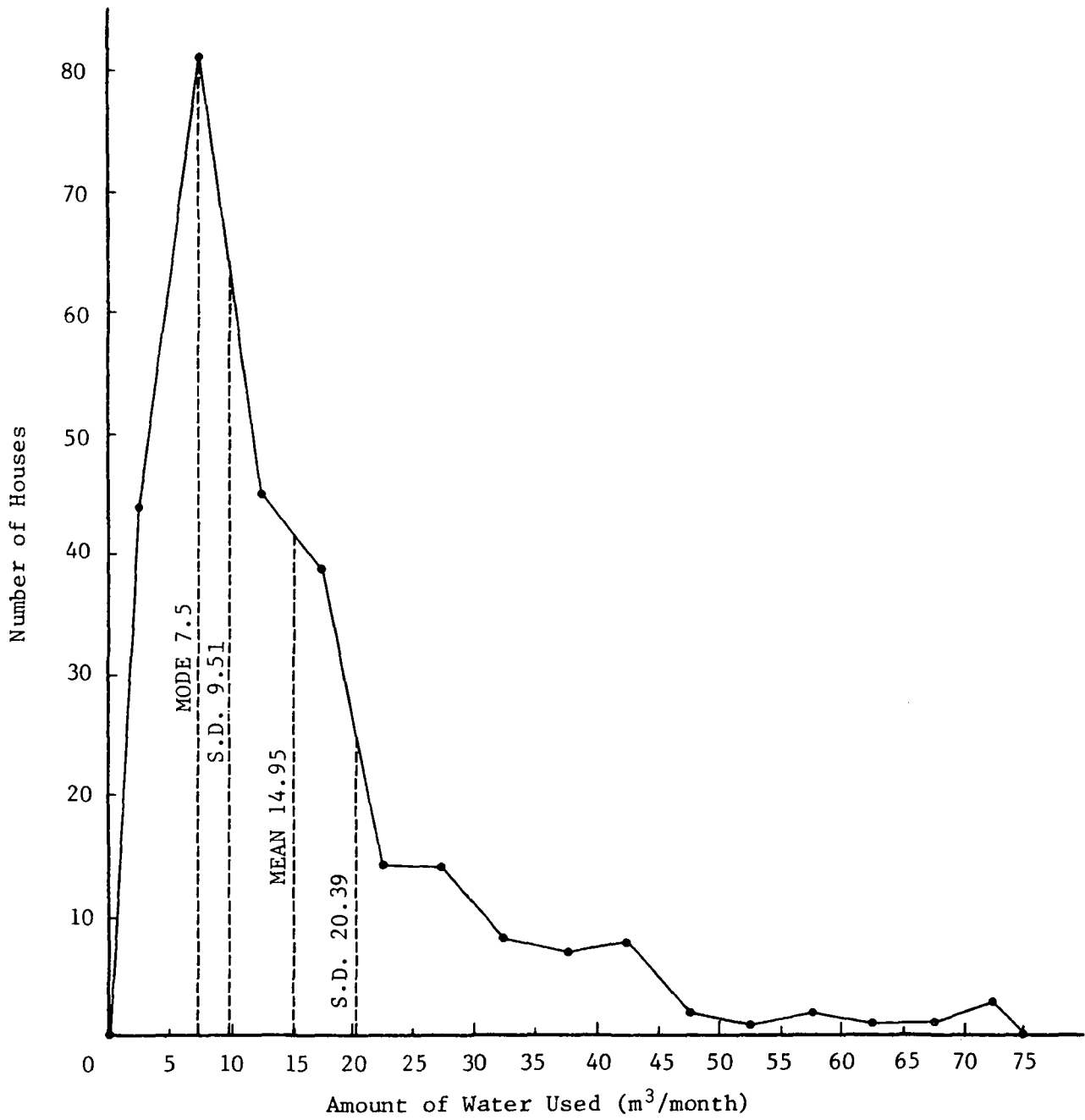

Fig. VII.2.5. Monthly consumption (m<sup>3</sup>/month/house).

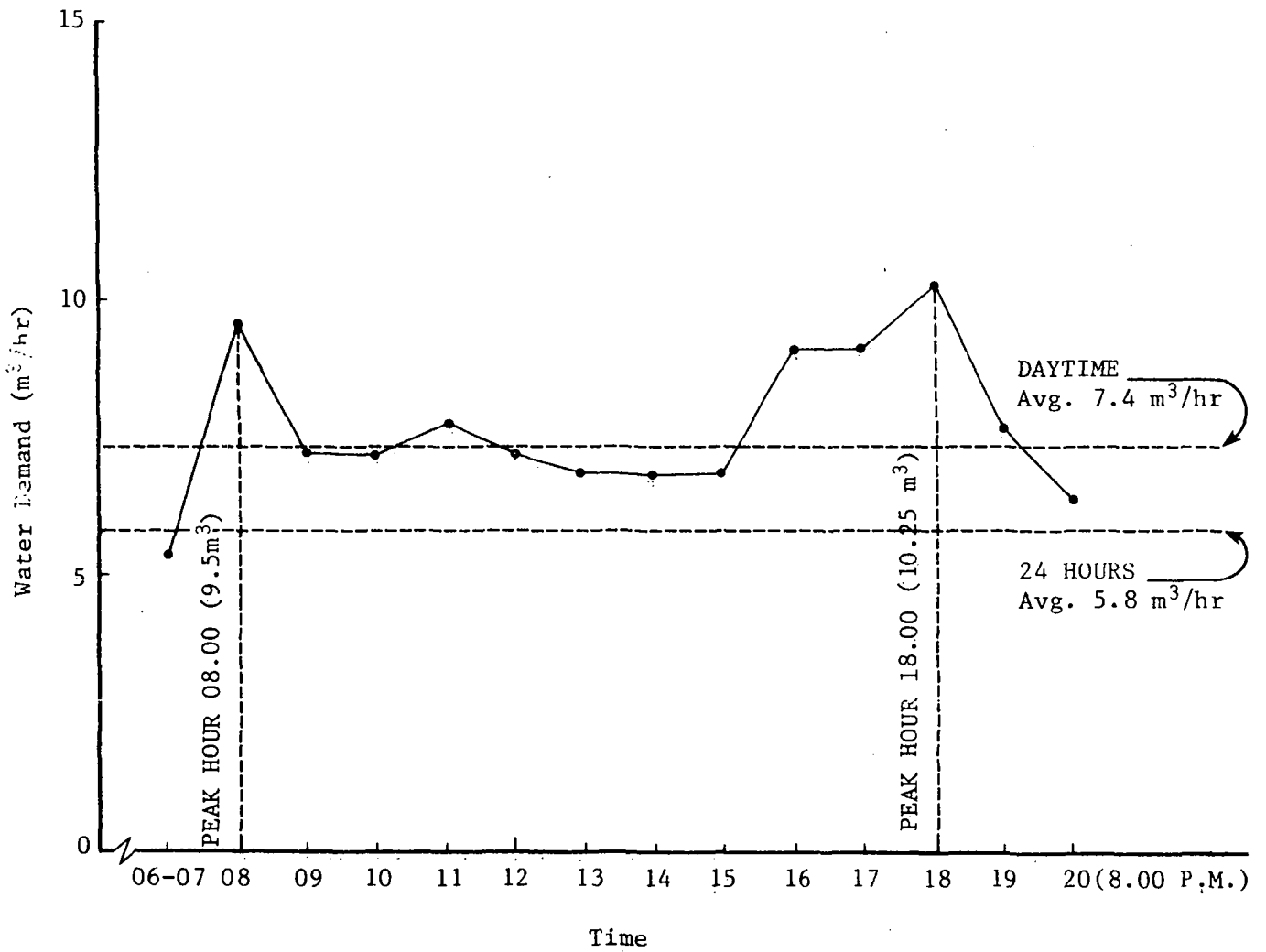

Fig. VII.2.6. Water usage pattern..



TABLE VII.2.1  
INCOME AND EXPENDITURE PER MONTH

Month	Income (₪)	Expenditure (₪)								Total
		Salary	Fuel	Oil	Electricity	Chlorine	Surface Cleaning	Maintenance		
Sept. 75	9,775	1,700	1,020	75	552	510	-	-	-	3,857
Oct. 75	9,878	1,700	1,020	75	580	680	-	-	-	4,055
Nov. 75	11,263	1,700	1,020	75	569	875	423	1,050	-	5,712
Dec. 75	11,985	1,700	1,020	91	582	1,800	-	-	-	5,193
Jan. 76	11,338	1,700	1,020	298	567	-	-	-	-	3,585
Feb. 76	11,320	1,700	1,020	105	580	-	-	-	-	3,405
Mar. 76	16,637	1,700	1,510	75	769	680	300	-	-	5,034
Apr. 76	15,598	1,700	1,020	75	682	680	-	700	-	4,857
May 76	15,021	1,700	1,550	156	628	680	-	-	-	4,714
June 76	12,468	1,700	1,020	75	589	-	-	-	-	3,684

salary for two operators	42%
maintenance (chemical and other)	17%.

Expenditures average 4,217 bahts/month for the production of 4,050 m<sup>3</sup>/month of water. Thus, approximately 1 baht is expended in the production of each cubic meter of water. Average revenue per month is 10,563 bahts. (See Figure VII.2.7 and Table VII.2.2.)

#### CHARACTERISTICS OF THE FILTER

Filter design. At the time of this study, the filter was being used only one unit at a time because the water demand was not up to the capacity designed for the plant. While one unit was cleaned the other unit was used. The bottom dimensions of each filter unit are 15 m x 30 m making a total of 900 m<sup>2</sup> for the two filter areas combined. The depth of the filter beds are:

free board	0.60 m
supernatant water	1.00 m
sand bed (initially)	1.00 m
gravel size 5-10 mm	0.10 m
gravel size 10-25 mm	0.10 m
gravel size 25-75 mm	0.20 m
total depth	3.00 m.

The underdrain system consists of concrete blocks forming the manifold (0.30 x 0.36 m in size). These blocks are placed 1.5 cm apart, one from the other. The laterals are made from 100 mm asbestos cement pipe in sections 30 cm long. The sections are placed 1.5 cm apart, one from the other. The filtered water flows to the clear well in 250 mm AC pipe. The rate of filtration is controlled by a gate valve and a V-shaped weir before

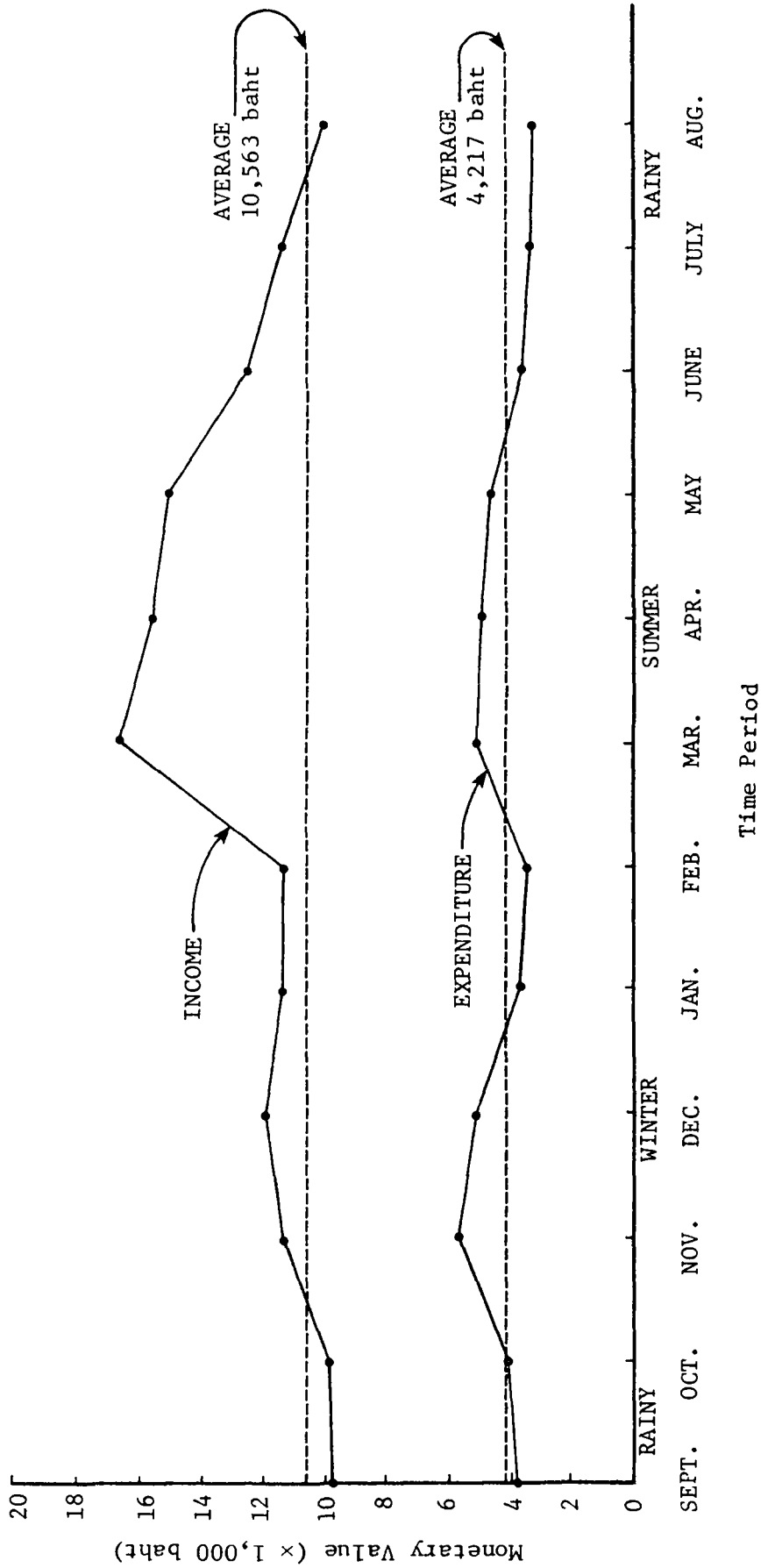

Fig. VII.2.7. Income and expenditure per month.

TABLE VII.2.2  
DEMAND AND PAYMENT

Demand Per Month (M <sup>3</sup> )	Consumer		Total Amount		Payment/Month (₱)	
	Houses	%	M <sup>3</sup>	%	Per House	Total
0 - 5	44	16	110	3	7.5	330
5 - 10	81	30	608	15	22.5	1,824
10 - 15	45	16	562	14	37.5	1,686
15 - 20	39	14	683	17	52.5	2,049
20 - 25	14	5	375	9	67.5	1,125
25 - 30	14	5	385	10	82.5	1,155
30 - 35	8	3	260	7	97.5	780
35 - 40	7	2	262	7	112.5	786
40 - 45	8	3	340	8	127.5	1,020
45 - 50	2	1	95	2	142.5	285
50 - 55	1	1	53	1	157.5	159
55 - 60	2	1	115	3	172.5	345
60 - 65	1	1	62	1	187.5	186
65 - 70	1	1	68	1	202.5	204
70 - 75	3	1	72	2	217.5	216
Total	271	100	4,050	100	-	12,150

the clear well. The weir serves as a flow measurement device and also as a U-tube to prevent the sand surface from drying.

Sieve analysis. It has been suggested by L. Huisman and W. E. Wood that a degree of uniformity of less than 3 and an effective diameter in the range of 0.15 to 0.35 mm are desirable for the sand media of slow sand filters. In this experiment, sieve analyses were made five times of samples from various positions in the filter. For the results, see Tables VII.2.3 and VII.2.4, and Figure VII.2.8. A uniformity of 2.75 and an effective diameter of 0.24 mm were the average results obtained. The two values are satisfactory within the ranges suggested above.

Rate of filtration. The rate of 100 m<sup>3</sup>/hr is the design capacity of this plant. Since there are two units, each should run at the rate of 50 m<sup>3</sup>/hr or at about 0.11 m<sup>3</sup>/hr/m<sup>2</sup> related to the filter bottom area. The rate of filtration is adjusted by means of the valve between the filter and the clear well.

In this analysis, after cleaning the surface of the sand of the unit to be analysed the control valve was opened fully. That made the filtration rate slightly higher than the design rate, or about 60 m<sup>3</sup>/hr (0.133 m<sup>3</sup>/hr/m<sup>2</sup>) with the water level at 0.90 meters above the sand surface. The raw water pump was shut down at this level. The raw water was allowed to pass through the filter bed, and the rates of filtration were checked again at 0.80 and 0.70 m of water level above the sand surface. The filter stopped running at the level of 0.50 m automatically due to the action of the weir. This process was repeated periodically and data were collected each time, over a total of 120 hours of filter run.

The rate of filtration corresponding to the length of the filter run were plotted. The curves did not show clearly any signs of clogging

TABLE VII.2.3

REPORT OF SIEVE ANALYSIS  
(EXPERIMENT 1)

Opening (mm)	U.S. No.	Weight (gm)		Weight of Soil		% Retained	% Finer
		Sieve	Sieve and Soil	(gms)	(%)		
4.689	4	590.15	593.45	3.8	1.15	1.15	98.85
2.00	10	527.05	555.75	28.7	10.0	11.15	88.85
1.168	16	497.7	520.45	22.75	7.93	19.08	80.92
1.00	18	506	518.9	12.9	4.50	23.58	76.42
0.589	30	468.15	520.55	52.4	18.26	41.84	58.16
0.420	40	394.6	442.6	48.0	16.75	58.59	41.41
0.350	45	445.2	482.05	36.85	12.84	71.43	28.57
0.295	50	440.05	462.9	22.85	7.96	79.39	20.61
0.250	60	369.55	395.9	26.35	9.18	88.57	11.43
	PAN	367.0	399.8	32.8	11.43	100.00	0

D10 = .23 mm.

$$\frac{D60}{D10} = \frac{.63}{.23} = 2.74.$$

TABLE VII.2.4  
REPORT OF SIEVE ANALYSIS  
(AVERAGE FOR FIVE EXPERIMENTS)

U.S. No.	% Finer
4	99.19
10	90.63
16	77.76
18	73.3
30	53.49
40	40.61
45	33.32
50	25.03
60	13.23

$$D_{10} = .24 \text{ mm.}$$

$$\frac{D_{60}}{D_{10}} = \frac{.66}{.24} = 2.75.$$

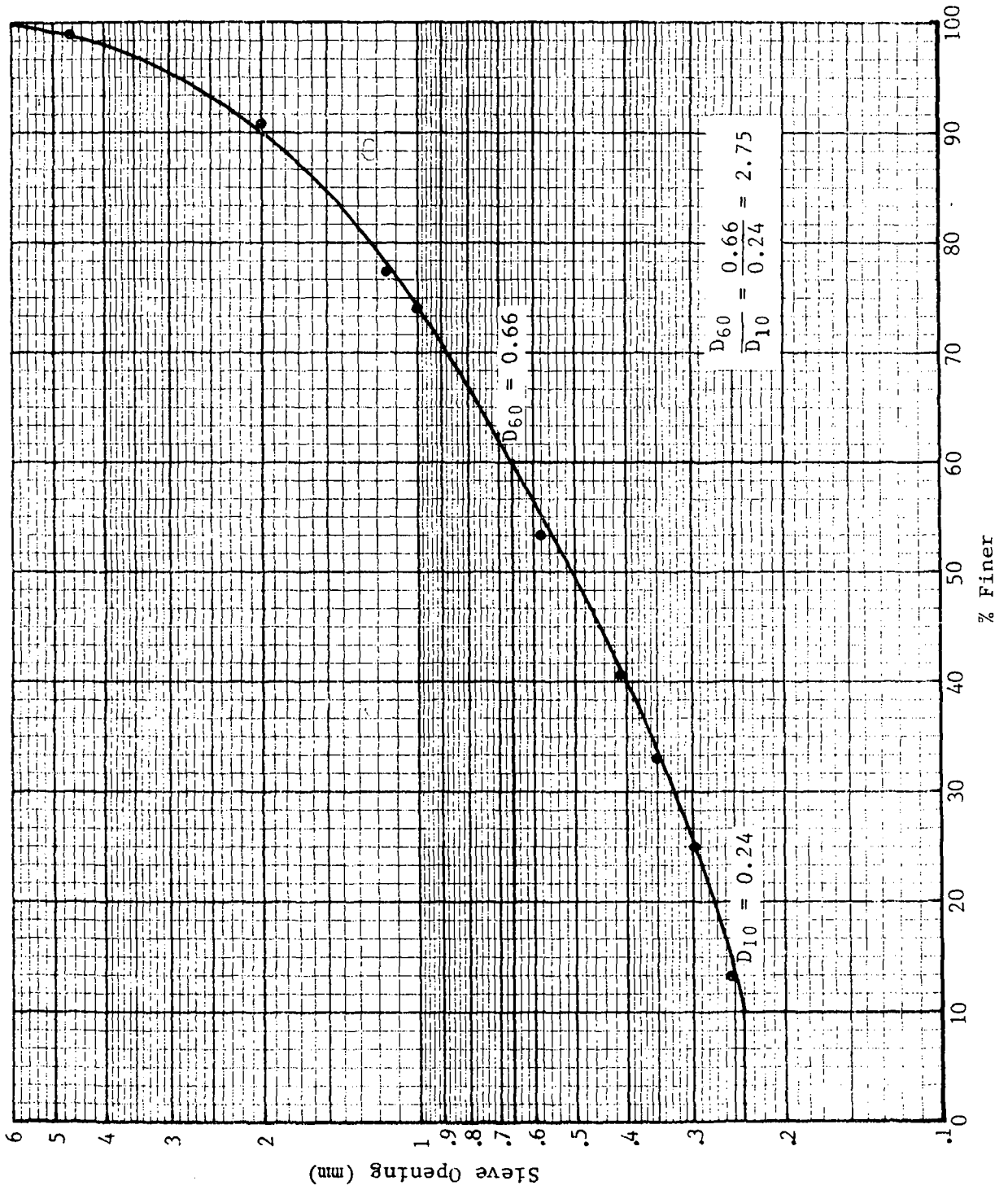

Fig. VII.2.8.  
Sieve analysis.



and there were, in general, fluctuations along the lines. After forty hours of filter run the rate of filtration increased till it again reached the starting rate. This could have been due to any crack on the surface of the sand. However, this phenomenon should not have happened since the sand was never allowed to dry, being always covered with water, and since the technician checked the filter each day.

The rate curves were plotted relative to three different water elevations above the sand surface, at 0.90, 0.80 and 0.70 m. At the 0.90 m water level, the rate of filtration dropped by about  $7 \text{ m}^3/\text{hr}$  over the total run, an 11.6% decrease. But at the 0.80 and 0.70 m water levels the rates of filtration fluctuated up and down during the 120-hour run, and the deviations were not large.

It can be seen from the curves in Figure VII.2.9 that a difference in the elevation of the water level will make the rate of filtration vary a great deal. A difference of 0.10 m changed the filtration rate by about  $15 \text{ m}^3/\text{hr}$  or  $0.033 \text{ m}^3/\text{hr}/\text{m}^2$ . To operate the filter at the design rate, the water elevation should be kept at about 0.80 - 0.85 m above the sand surface. That should maintain a rate of about  $0.10 \text{ m}^3/\text{hr}/\text{m}^2$ .

#### QUALITY CONTROL AND EFFICIENCY OF THE FILTER

Slow sand filtration systems are used for water sources that are believed to be of good quality throughout the year. The chemical and bacteriological characteristics of the water produced at the filtration plant at Kranuan will give an idea of the capability and the efficiency of the filter. For this purpose, water was sampled from the inlet and the outlet of the filter. The samples were subjected to physical, chemical and bacteriological determinations. The bacteriological samples

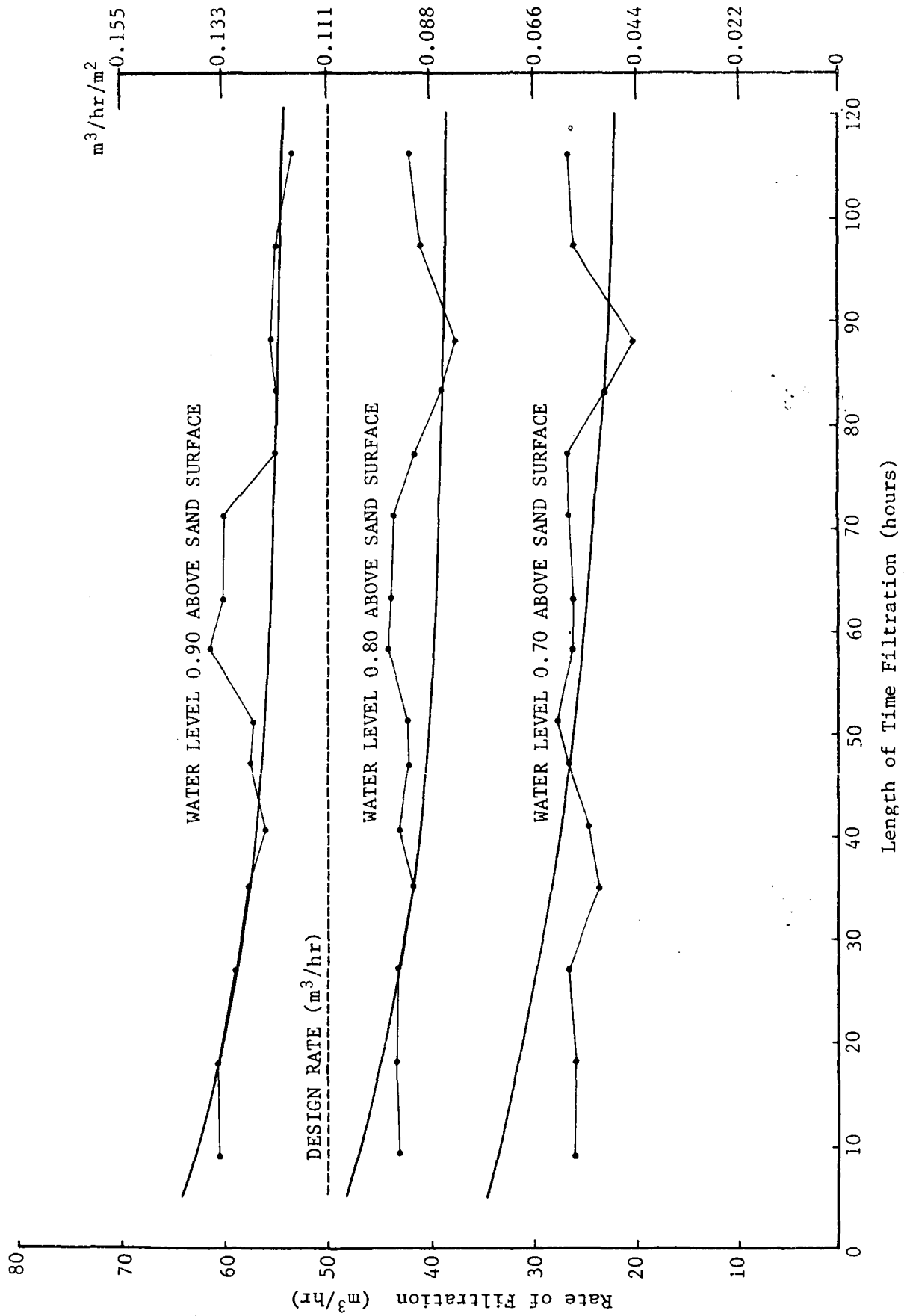

Fig. VII. 2.9. Rate of filtration at various filtered times (m³/hr vs. hours).

were taken using an aseptic technique and a sterile glass bottle. These experiments were run for one month, January - February 1976. The results of the analyses are tabulated in Table VII.2.5.

Temperature. The measurement of temperature was done at the water treatment plant. The temperature of the water usually varies according to the seasons and the weather conditions. The time of this analysis was between January and February. These two months are in the late winter of Thailand and air temperatures range from  $22.8^{\circ}\text{C}$  to  $25.8^{\circ}\text{C}$ . The average value of the raw water temperature was  $24.5^{\circ}\text{C}$  and for the filtrate the temperature was  $24.0^{\circ}\text{C}$ .

Colour. The determination of colour was reported in terms of apparent colour which is due to suspended matter. The average result was five units for both raw and filtered waters.

Turbidity. The analysis of turbidity was performed by using a Turbidimeter Hach Model 2100A. The turbidity values of the raw water were between 5.6 and 7.2, which gives an average of 6.5; and the turbidity of the treated water ranged from 2.6 to 5.6, which provided an average of 4.2.

Value of pH. The pH value is measured by using a pH meter Orion Model 407A. Values ranged from 7.85 to 8.9 for the raw water and from 7.98 to 8.15 for the filtered water. The average pH value of the former was 8.13 and of the latter it was 8.05.

Alkalinity. The alkalinity of water is due to the presence of bicarbonate, carbonate and hydroxide. The phenolphthalein alkalinity in the processed water was undetectable. The total or methyl orange alkalinity values for the raw and filtered water were 123.4 and 127.2 ppm ( $\text{CaCO}_3$ ), respectively.

TABLE VII.2.5  
RESULTS OF ANALYSIS OF WATER

Date of Collection	Temperature		pH		Colour Units		Turbidity (FTU)		Total Solids (mg/l)		Hardness (mg/l-CaCO <sub>3</sub> )		Alkalinity (mg/l-CaCO <sub>3</sub> )		D.O. (mg/l)	Residual-Cl <sub>2</sub> (mg/l)		Coliform (MPN/100 ml)			
	R	P	R	P	R	P	R	P	R	P	R	P	R	P		R	P	R	P		
12 Jan 76	24.4	23.2	8.65	8.15	5	5	5.6	2.6	79	103	52	72	4	nil	124	170	8	2.3	nil	38	240
13 Jan 76	22.8	20.8	8.6	7.99	5	5	5.6	2.6	73	88	56	72	8	nil	136	170	8.4	2.3	nil	-	-
17 Jan 76	-	-	8.82	8.05	5	5	5.6	2.6	89	91	56	56	10	nil	124	128	-	-	-	-	-
20 Jan 76	23.5	24.1	8.74	8.04	5	5	5.6	2.6	58	71	56	52	12	nil	128	136	7.6	5.6	nil	240	38
22 Jan 76	25.0	24.5	8.7	7.96	5	5	5.6	2.6	45	70	56	52	14	nil	120	120	8.2	7.2	nil	240	38
26 Jan 76	25.8	25.3	8.68	8.03	5	5	5.6	2.6	60	72	56	52	10	nil	122	126	8.5	6.1	nil	38	38
28 Jan 76	25.4	25.6	8.65	8.01	5	5	5.6	2.6	58	52	52	52	6	nil	122	130	7.4	5.4	nil	240	38
30 Jan 76	24.6	24.2	8.4	8.08	5	5	5.6	2.6	37	55	56	48	10	nil	144	142	7.3	5.3	nil	-	-
2 Feb 76	-	-	8.65	8.09	5	5	7.2	5.6	18	38	52	52	11	nil	142	146	7.4	5.1	-	12	5

R = raw water. P = potable water.

TABLE VII. 2.5. --Continued

Date of Collection	Temperature		pH		Colour Units		Turbidity (FTU)		Total Solids (mg/l)		Hardness (mg/l-CaCO <sub>3</sub> )		Alkalinity (mg/l-CaCO <sub>3</sub> )				D.O. (mg/l)		Residual-Cl <sub>2</sub> (mg/l)		Coliform (MPN/100 ml)		
	R	P	R	P	R	P	R	P	R	P	R	P	Phenolphthalein	R	P	Methyl Orange	R	P	R	P	R	P	
4 Feb 76	-	-	8.58	8.11	5	5	7.2	5.6	12	21	56	52	nil	142	144	144	8	5.7	-	-	-	38	2
6 Feb 76	-	-	8.65	8.1	5	5	7.2	5.6	93	89	56	52	nil	146	142	142	8.7	6.9	-	-	-	-	-
9 Feb 76	-	-	8.45	8.01	5	5	7.2	5.6	101	115	56	52	1	18	14	14	8	5	-	-	-	-	-
11 Feb 76	-	-	8.85	8.12	5	5	7.2	5.6	82	86	52	52	nil	140	136	136	8.2	7.2	-	-	-	-	-
13 Feb 76	-	-	8.9	8.15	5	5	7.2	5.6	83	90	64	52	nil	138	126	126	8	6.7	-	-	-	-	-
16 Feb 76	-	-	7.85	7.98	5	5	7.2	5.6	88	82	18	28	nil	136	120	120	7	6.4	-	-	240	240	
18 Feb 76	-	-	8.65	8.08	5	5	7.2	5.6	96	95	56	52	2	54	52	52	9.3	7.2	-	-	15	8.8	
20 Feb 76	-	-	8.21	7.93	5	5	7.2	5.6	105	106	60	60	3	162	160	160	9	5.1	-	-	-	-	
Average	24.5	24	8.6	8.05	5	5	6.5	4.2	69.2	77.9	53.5	53.4	8.7	123.4	127.2	127.2	8.1	5.6	nil	0.12	122.3	72	

R = raw water. P = potable water.

Hardness. Hardness prevents lather formation and produces scale. The determination of hardness was made by the titration method. It showed that the hardness value both of the raw water and of the filtrate was about 53.5 ppm.

Total solids. The solids were determined as total dissolved solids. This was done by evaporating a volume of sample to dryness and drying it in an oven at 100 - 105°C. The remaining weight of the sample consists of the weight of the solids. The amounts of solids in the raw and filtered waters were 69.2 and 77.9 mg/l, respectively.

Dissolved oxygen. The Winkler method was applied to determine the dissolved oxygen. The oxygen dissolved in the raw water kept in the reservoir was 8.1 mg/l. After filtration the dissolved oxygen content had dropped to 5.6 mg/l.

Coliform bacteria. An estimation of the coliform number was determined by the Most Probable Number (MPN) method. Coliform bacteria have the property that they will ferment lactose with the production of gas. The appearance of gas after incubation for twenty-four hours at 37°C, is taken as a positive test for the presence of coliform bacteria. The number of positive tubes are statistically interpreted to arrive at the Most Probable Number per 100 ml. The average value for the raw water was 122 and after filtration the figure dropped to 72.

Residual chlorine. Chlorine is used for disinfection of the filtered water. A residual chlorine is left in the water and this can be detected. The residual chlorine ensures that the water will remain safe for consumption. The average value found was 0.12 ppm. The amount of high test hypochlorite (60%) used is about fifteen kilogrammes per month or per 4,050 m<sup>3</sup>.

Discussion. The filter system at Kranuan can produce clear, odourless and colourless water with a 41% reduction of coliform organisms. Slow sand filtration, theoretically, can achieve 99% reduction of bacteria. The analysis showed that the efficiency of filtration was not yet satisfactory with respect to coliform removal. The degree of hardness shown by the analysis would cause the water to be classified as soft. This has economic advantages in terms of soap consumption. As the dissolved oxygen content of the effluent was above 3 mg/l, it is believed that anaerobic conditions rarely develop in the filter bed.

The physical and chemical analyses show that the physical and chemical parameters do not exceed the limits of the WHO standards for drinking water, 1971. If disinfection is strictly controlled, the water is safe for drinking.





## VII.3.

SMALL WELLS, SLOW SAND FILTRATION, AND  
RAPID SAND FILTRATION FOR  
WATER SUPPLIES IN DEVELOPING AREAS

Kung-cheh George Li

## SMALL WELLS

Introduction. The small wells discussed here will be limited to those wells which are relatively low in output, shallow in depth, and used primarily for rural community water supplies in developing countries. Therefore, the small wells included are large dug wells or small tube wells.

Use of groundwater, to which water wells serve as a means of access, provides many advantages. In general, groundwater is a more reliable and better quality source than surface water. It also costs less to develop. Small wells have become the major type of installation for small water systems in rural areas of developing countries.

Location of wells. A simple way to determine the appropriate location for a well is to study all the geological data available, including geologic maps, cross-sections and aerial photographs, and to study all available information on existing wells, especially the well logs. Important sources of water are consolidated rocks and granular, unconsolidated sediments including marine deposits, river valleys,

alluvial fans, coastal plains, glacial outwash and sometimes dune sand (7). So far as public water supplies are concerned, sands and gravels are the most important aquifers, with sandstones next in importance. In a region where the groundwater table is high and the underground strata are pervious, shallow wells may be located at any convenient place. The surface evidence of groundwater occurrence is demonstrated in Figure VII.3.1.

Types of small wells. As mentioned before, this examination of small wells is limited to the consideration of wells which are relatively low in output and shallow in depth. They are generally, but not necessarily, less than from fifteen to thirty meters in depth. Therefore, they can be shallow wells of large diameter as dug wells. They can also be shallow wells of small diameter as bored, driven, or jetted wells. The relationship between small wells, the groundwater table and ground surface is shown in Figure VII.3.2.

Dug wells. Dug wells are holes or pits dug by hand or machine tools which extend into the ground to tap the water table. They are usually greater than one meter in diameter. When such a well is used to supply water to a small community, it may be five or six meters in diameter. In this case, they are large in diameter and extend into shallow strata of sand or gravel. A well of this type surely has the advantage of furnishing considerable storage and will therefore allow a heavy draft for a short period. Dug wells are usually constructed to a depth of from three to twelve meters. Yields considerably less than 600 cubic meters/day are typical (5).

Dug wells are generally lined with concrete, brick, stone, tile, wood cribbing or steel rings to prevent the wall from caving in. Brick

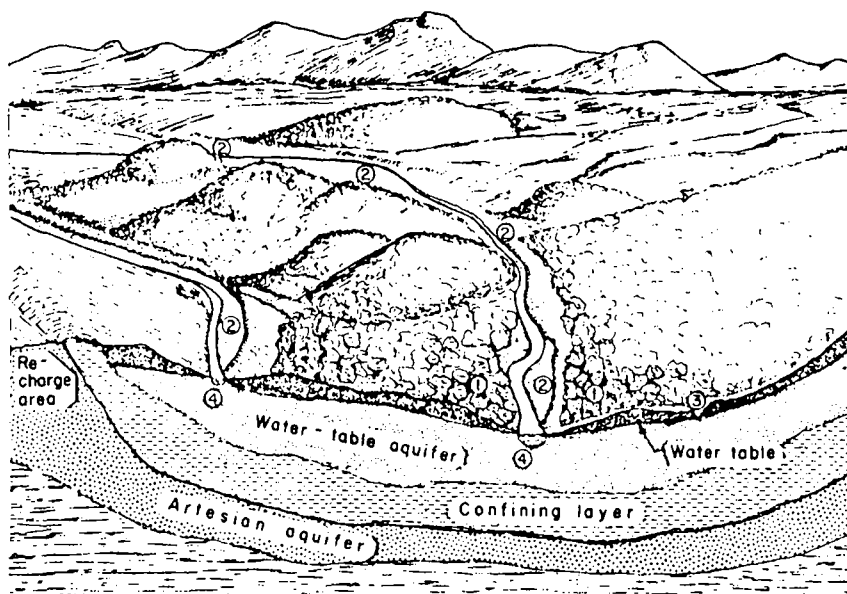

Fig. VII.3.1. Surface evidence of groundwater occurrence.

- Key:
1. Dense vegetation indicating possible shallow water table and proximity to surface stream.
  2. River plains, possible sites for wells in water-table aquifer.
  3. Flowing spring where groundwater outcrops. Springs may also be found at the foot of hills and river banks.
  4. River beds cut into water-bearing sand formation indicate possibility of river banks as good well sites.

SOURCE: Water Supply for Rural Areas and Small Communities, WHO Monograph Series, no. 42, 1959, Fig. 4.

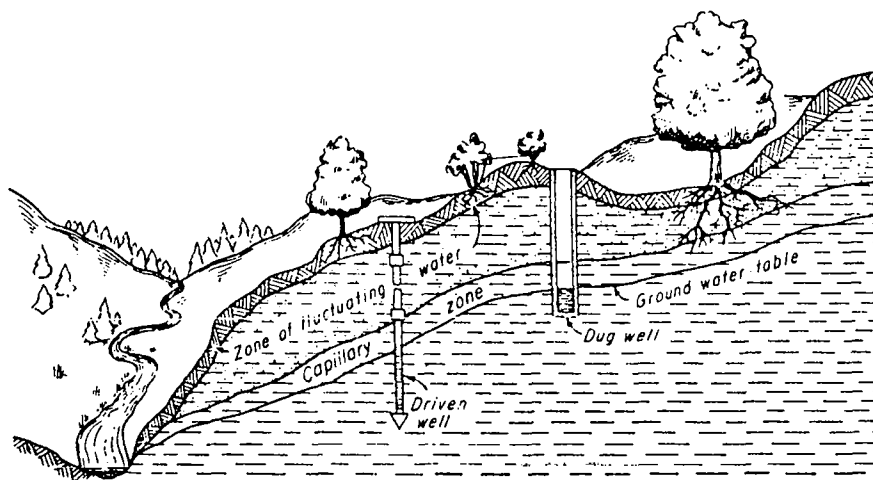

Fig. VII.3.2. Relation between small wells, the groundwater table and ground surface.

SOURCE: H. E. Babbitt, J. J. Doland, and J. L. Cleasby, Water Supply Engineering, 6th ed. (New York: McGraw-Hill, 1967).

with cement mortar is sometimes used to a depth of three meters below the ground surface with dry joints used below that level. A typical dug well is shown in Figure VII.3.3.

Large dug wells, up to a diameter of thirty meters, may be constructed by sinking a monolithic concrete lining as a caisson as well as by other methods.

Bored wells. Bored wells are constructed by drilling in unconsolidated material with hand-operated or power-driven earth augers. Such bored wells may be constructed up to about one meter in diameter and have been enlarged up to 1.2 meters in diameter by reaming. A concrete, tile or metal casing is inserted in the hole and cemented in place before the strainer is installed (7).

Driven wells. Driven wells which are up to ten centimeters in diameter and twenty meters deep can be installed only in soft formations relatively free of cobbles or boulders. A driven well is constructed by driving a well point on the lower end of a pipe which acts as both well casing and suction pipe. The driving is done by means of a maul (heavy hammer) or by dropping a weight. Driven wells are usually pumped by suction lift. In such cases, the static water level should be within about 4.5 meters of the surface (12). Because of limitations on size and depth, driven wells are not ordinarily adapted for large supply projects. However, batteries of driven wells may be connected to a suction header to supply enough water for small water supply systems.

Jetted wells. Jetted wells are constructed by a high-velocity stream of water which is directed downward into the earth. By attaching the well pipe to a self-jetting well point, consisting of a screened section ending in a nozzle, the well pipe is jetted into place (7).

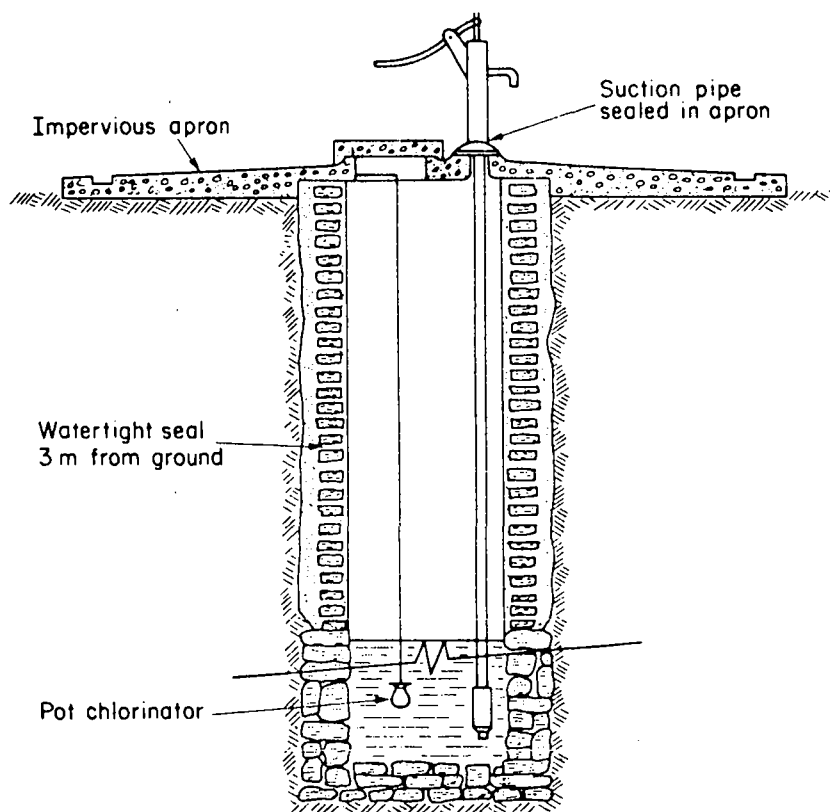

Fig. VII.3.3. Dug well with hand-pump and sanitary protection.

SOURCE: R. Feachem, M. McGarry, and D. Mara, eds., Water, Wastes, and Health in Hot Climates, (New York: John Wiley & Sons, 1977.)

Jetted wells can be constructed quickly when conditions are favorable, and they can provide an emergency supply of water.

Sanitary protection of small wells. The required measures for protection of dug wells from contamination should include the following:

1. The sides of the well should be lined with impervious material to a depth of about three meters to prevent the entry of water flowing near the ground surface.
2. An impervious apron should be constructed around the well mouth to prevent the surface water from entering at the top, to divert spilled water away from the well-mouth to a soak-away and to provide a comparatively dry floor for well-users. The ground surface must slope away from the well or the site must be otherwise drained.
3. An area within a radius of about fifteen meters from the well should be kept free from pollution. In this area there should be no dumping of refuse, and any pit latrines, soakaways or cesspits should be relocated (8).

A dug well with a hand-pump and sanitary protection is shown in Figure VII.3.3. It will be noted that in this figure a pot chlorinator is included as an additional safeguard. Protective measures (two) and (three) should also be applied in shallow tube or screened wells.

Modification of dug wells. If dug wells are difficult to maintain in a sanitary condition, they usually can be made much safer by driving well points into the water-bearing formation and thus converting them into tubular wells. A converted dug well is shown in Figure VII.3.4.

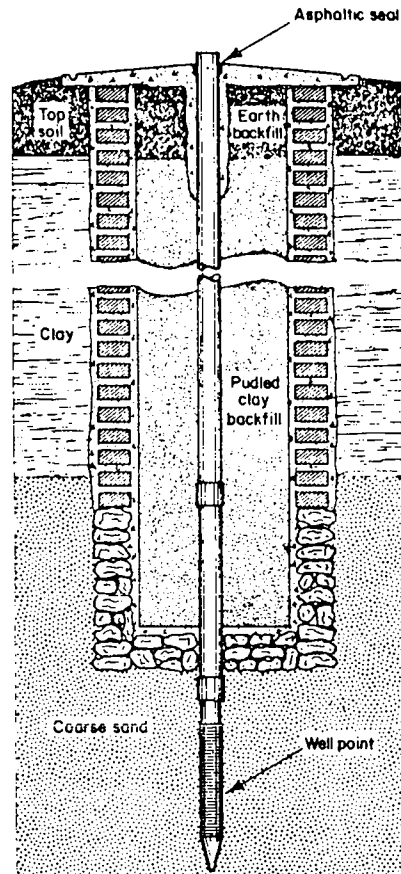

Fig. VII.3.4. A dug well with driven well point installation.

SOURCE: U. P. Gibson, and R. D. Singer, Small Wells Manual (Washington, D.C.: USAID, 1969).



One additional advantage of this modification is a much higher rate of yield. This is because the driven well point can penetrate much deeper into the water-bearing formation.

#### SLOW SAND FILTRATION

Introduction. Recently there has been a tendency to assume that slow sand filtration is an old-fashioned method of water treatment because of the development of rapid sand filtration. This criticism is definitely incorrect. Under suitable circumstances, slow sand filtration may be not only the cheapest and simplest but also the most efficient method of water treatment. So, it is unwise to neglect consideration of slow sand filters when planning new water works, especially in the developing countries.

Advantages of slow sand filters. Huisman and Wood claim that "no other single process can effect such an improvement in the physical, chemical, and bacteriological quality of normal surface waters." (11) Slow sand filters have a high degree of efficiency in the removal of turbidities, tastes and odors. The slower filtration rate also gives the bed a greater efficiency in the removal of bacteria than is attained by the rapid filter, considering the filter alone and not the auxiliary treatment. Furthermore, no chemicals are needed, and the absence of the use of a coagulant is typical of the slow sand filter. Pickford claims some additional advantages for the developing countries:

1. The cost of construction is low, especially where manual labor is used.
2. Simplicity of design and operation means that filters can be built and used with limited technical supervision. No

- special pipework, equipment or instrumentation is needed.
3. The labor required for maintenance can be unskilled, as the major job is cleaning the beds which can be done by hand.
  4. Import of material and equipment can be negligible, and no chemicals are required.
  5. Power is not required if a fall is available on site, as there are no moving parts or requirements for compressed air or high-pressure water.
  6. Variations in raw water quality and temperature can be accommodated provided turbidity does not become excessive; and overloading for short periods does no harm.
  7. Water is saved (an important matter in many areas) because large quantities of washwater are not required.
  8. Sludge, which is often a major problem with water treatment by more sophisticated methods, is less troublesome. There is less of it, and it is easily dewatered (8).

Application. Slow sand filters are most practical in the treatment of water with turbidity below fifty mg/l (expressed as  $\text{SiO}_2$ ) as this permits a longer filter run although raw water turbidities of 100-200 mg/l can be tolerated for two or three days. The best purification by slow sand filtration occurs when the average turbidity is ten mg/l or less. When higher turbidities are expected, slow sand filtration should be preceded by some type of pretreatment, such as plain sedimentation, storage with micro-straining for algae removal, rapid "roughing" filtration, and sedimentation preceded by chemical coagulation (if necessary) and followed by rapid "roughing" filtration (11).

Mechanism of slow sand filtration. A number of different operations combine to produce the overall removal of impurities accomplished by slow sand filtration. The most important of these operations which contribute to the transport, attachment and purification mechanisms in the filters are straining, sedimentation, inertial and centrifugal forces, the Van der Waals force, electrostatic attraction, adhesion and the action of schmutzdecke. Actually, the successful performance of a slow sand filter is dependent mainly on the schmutzdecke. In a mature bed, a thin layer called the schmutzdecke forms on the surface of the bed. The schmutzdecke (from the German schmutz, dirt or impurity, and decke, cover or layer) consists of algae, plankton, bacteria and other forms of life. Within this layer micro-organisms break down organic matter, and a great deal of inorganic suspended matter is retained by straining.

Design of a slow sand filter. The characteristic features of the slow sand filter are the slow rate of filtration and the method of cleaning the beds by scraping off the surface layer of sand.

The filtration rate of downward flow of water under treatment normally lies between 0.1 and 0.4 m<sup>3</sup>/hr/m<sup>2</sup>. It should be slow enough to ensure a minimum length of filter run of at least two weeks under the most unfavorable conditions. Under average running conditions, the interval between cleanings will commonly be from twenty days to two months (7). A typical slow sand filtration plant is shown in Figure VII.3.5.

As shown in Figure VII.3.5, the essential parts of a slow sand filter are the water layer, the sand bed, supporting gravel, underdrainage system and filter control system.

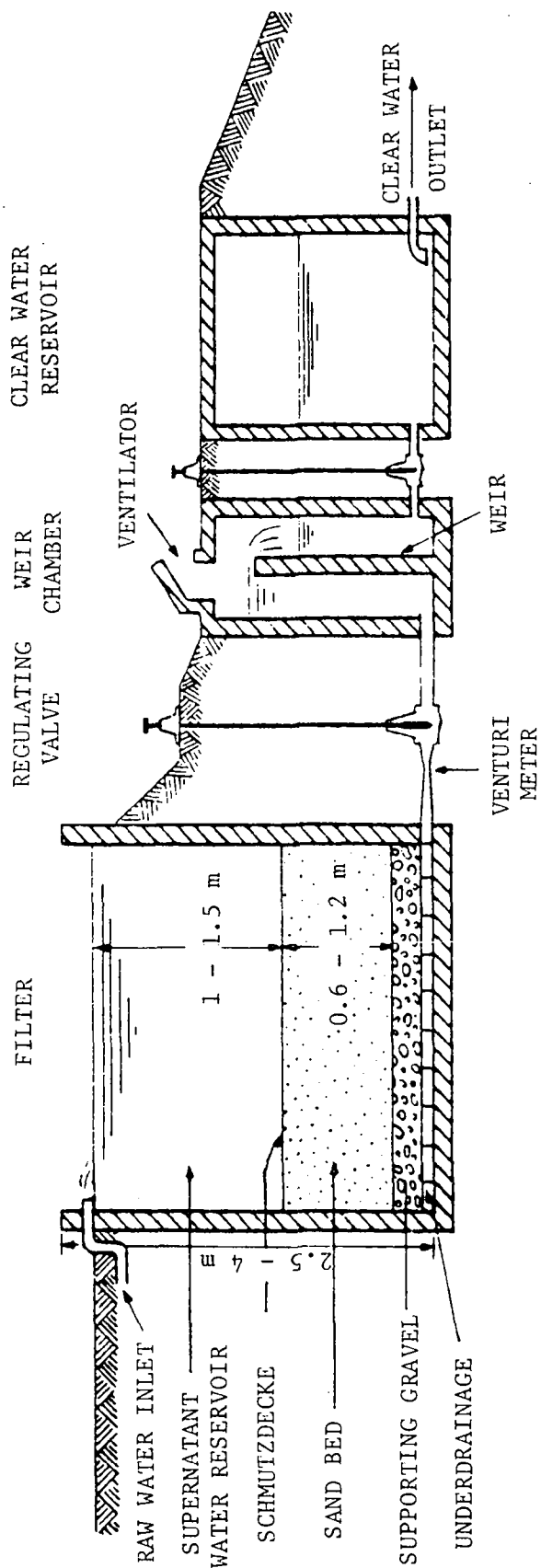

Fig. VII.3.5. Diagram of a slow sand filter.

SOURCE: L. Huisman, and W. E. Wood, Slow Sand Filtration (Geneva: World Health Organization, 1974).

The principal function of the water layer is to maintain a constant head of water above the sand bed for providing the pressure that carries the water through the filter. In practice, a depth of water of between 1.0-1.5 meters is provided.

The sand bed thickness initially varies from 1.2 to 1.4 meters. The thickness is usually reduced to no less than fifty to eighty centimeters. Common specifications for the type of sand used are the effective size at 0.15-0.35 mm, and the uniformity coefficient of between 1.5 and 3. A coefficient of less than 2 is preferable. The effective size is the sieve size in millimeters that permits ten percent of the sand by weight to pass ( $d_{10}$ ). The uniformity coefficient is the ratio between the sieve size that will pass sixty percent to the sieve size that will pass ten percent (effective size) ( $d_{60}/d_{10}$ ).

The supporting gravel is placed as graded layers with the finest size on top. The rules applied to the design of the supporting gravel bed are:

1. For the gravel in each layer, ten percent and ninety percent passing diameters should differ by a factor of not more than  $\sqrt{2}$ . If this is difficult to attain, then the requirement may be relaxed to a factor of two, but in this case each layer should have its  $d_{10}$  value restricted to not larger than three times that of the layer above.
2. The gravel of the bottom layer should have an effective diameter of at least twice the size of the opening into the underdrainage system. Each successive layer should be graded so that its smaller ( $d_{10}$ ) particle diameters are not more

than four times smaller than those of the layer immediately below.

3. The uppermost layer of the gravel must be chosen with a  $d_{10}$  value more than four times greater than the  $d_{15}$  value of the coarsest filtration sand and less than four times greater than the  $d_{85}$  value of the finest filtration sand. The sand is taken from natural deposits which vary in grain size from one spot to another.
4. The thickness of each layer of gravel should be at least three times the diameter of the largest stones in its grading. In engineering practice, the minimum thickness of the layers is usually increased to from five to seven centimeters for the finer gravel and to from eight to twelve centimeters for the coarser gravel (11).

An underdrainage system below the gravel layers is required for three purposes: support for the filter media, collection of the filter water, and uniform distribution of the filtration rate. The simplest form of underdrainage system consists of lateral drains spaced less than four meters apart, and a main drain. Filter bottoms are sometimes gently sloped downward from the midpoints between the laterals. The laterals usually consist of porous or perforated unglazed drainage tiles, glazed pipes laid with open joints, or perforated pipes of asbestos cement or polyvinylchloride, covered with layers of gravel. The main drain may be constructed of pipes of made of concrete, and it is frequently placed beneath the floor of the filter box to save the bed depth.

Today there is increasing use of standard bricks to support the medium and to provide drainage space. One of the simplest of such

open-jointed brick arrangements is shown in Figure VII.3.6. If the dimensions of the bricks are 5 x 11 x 22 cm, then each channel drains a strip twenty-three cm wide.

Generally, filter control is accomplished by means of a system of hand-operated valves to regulate the filtration rate and the depth of water over the filter. A simple filter control system is shown in Figure VII.3.5. Automatic controllers of the type used with rapid filters may be employed but are not necessary with the low filtration rates of the slow filter.

The minimum workable size of a filter unit might be 100-150 m<sup>2</sup> and the maximum size might be 2000-5000 m<sup>2</sup>. The number of filters (N) may be obtained by dividing the total filtration area required by the area of each filter and adding the chosen number of reserve filters. At least one reserve filter should be provided, but two or more reserve filters are necessary for large treatment plants. The number of filters (N) can also be approximated by using the following formula:

$$N = \frac{1}{4} \sqrt{Q} ,$$

where N = number of filters (N ≥ 2)

Q = hourly quantity of water to be treated (m<sup>3</sup>/hr) (11).

The shape of filters is usually rectangular. The filters are always equal in size and laid out side by side in rows. Assuming that (n) filters of equal size are laid out side by side in a single row, the ratio of the width (W) to the length (L) of each filter unit can be estimated by use of the following formula:

$$W/L = (n + 1)/(2n).$$

For example, W/L = 1/1.3 for n = 2; W/L = 1/1.5 for n = 3; etc.

This equation gives the optimum W/L ratio which will minimize construction

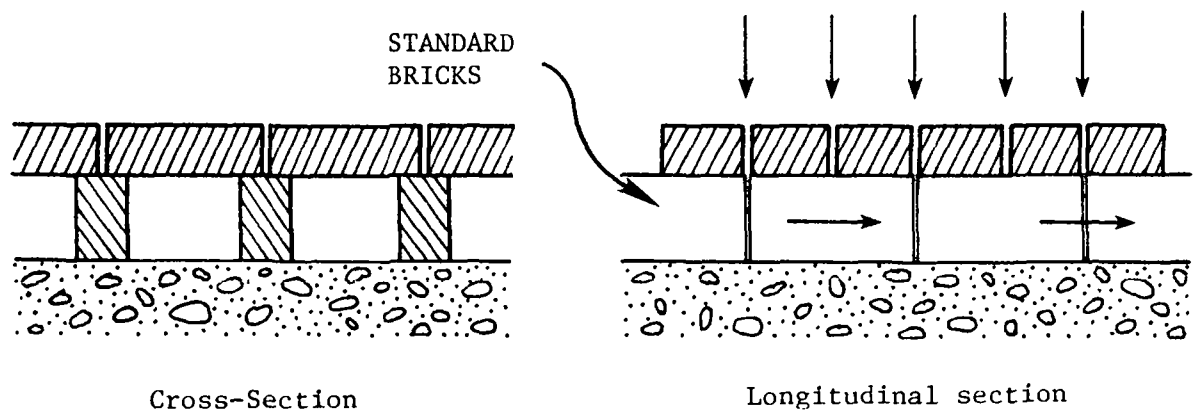
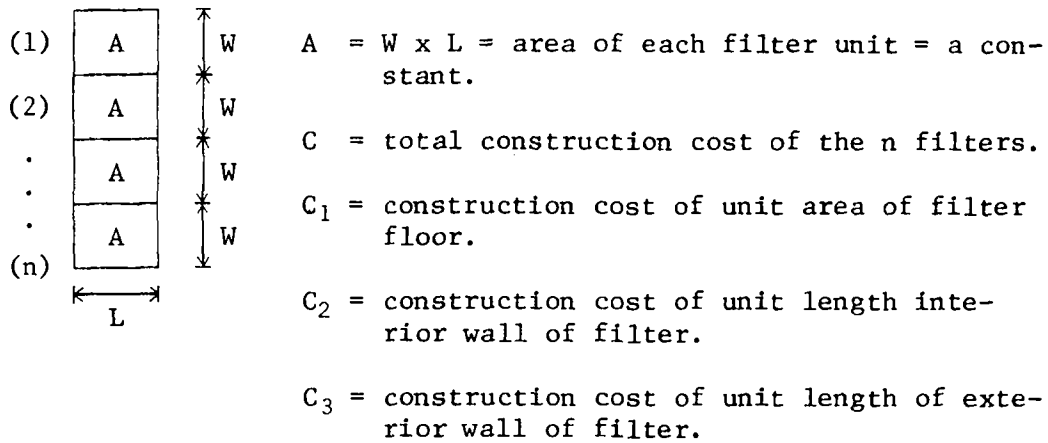

Fig. VII.3.6. Open-jointed brick filter bottom.

SOURCE: L. Huisman, and W. E. Wood, Slow Sand Filtration. Geneva: World Health Organization, 1974.



costs, and the derivation follows.



$$\text{Then, } C = C_1 nA + C_2(n-1)L + 2C_3(nW + L) = C_1 nA + C_2(n-1)L + 2C_3\left(n\frac{A}{L} + L\right).$$

$$\text{Assume } C_2 = C_3.$$

$$\text{Then, } C = C_1 nA + C_2 \left[ (n+1)L + 2n\frac{A}{L} \right].$$

Find the first and second derivatives of  $C$  with respect to  $L$ , and set each of them equal to zero.

$$\frac{dC}{dL} = C_2 \left[ (n+1) - 2n\frac{A}{L^2} \right] = C_2 \left[ (n+1) - 2n\frac{W}{L} \right] = 0.$$

$$\text{If } C_2 \neq 0, \frac{W}{L} = \frac{(n+1)}{(2n)}.$$

$$\frac{d^2C}{dL^2} = 4C_2 n \frac{A}{L^3} > 0.$$

By inference, then, when  $C$  is at a minimum,  $W/L = (n+1)/(2n)$ .

As with the rapid sand filter, a clear well is needed at the plant, and this is generally made large enough to equalize filter output and demand over a day. Furthermore, as a safeguard, the application of chlorine to the effluent of a slow sand filter (i.e., chlorination) is also practiced. In general, the dosage is about 0.5 mg/l and rarely more than 1.0 mg/l.

Operation of slow sand filter. The initial resistance (loss of head) of the clean filter bed is about six centimeters (7). During filtration, impurities deposit in and on the surface layer of the sand bed, and the loss of head begins to increase. When the loss of head has reached its permissible limit, the filter is thrown out of service and cleaned. The loss of head before cleaning is seldom allowed to exceed the depth of water over the surface of the sand (i.e., 1-1.5 m) (3). As mentioned before, the period between cleaning is twenty to sixty days. The method of cleaning can be either scraping off the surface layer of sand and washing and storing cleaned sand for periodic resanding of the bed, or washing the surface sand in place with a washer traveling over the sand bed. Because labor is readily available in developing countries, the former method is favored. Men with flat, wide shovels do the scraping and remove from one to two centimeters of top material. The work of cleaning by hand should be completed in one to two days. After washing, the sand is stored and replaced on the bed when, by successive cleanings, the thickness of the sand bed has been reduced to about fifty to eighty centimeters. About 0.2 to 0.6 percent of the water filtered is required for washing purposes (7). When resanding, a process of "throwing over" is carried out (11). During this process, an additional depth of old sand is temporarily removed to one side; then the cleaned sand is added, and the old sand replaced on top of the cleaned sand. The purpose of the process is to retain much of the active material and enable the resanded filter to become operational with a minimum of re-ripening.

After being cleaned, the beds are refilled with filtered water from below until the sand is completely covered. This prevents

entrapment of air in the sand. Furthermore, the filtered water may be wasted for several days until analysis shows that it meets the quality standard.

#### RAPID SAND FILTRATION

Introduction. Although slow sand filters have great advantages for developing countries, rapid sand filters are also widely used for treatment of community water supplies due to their greater adaptability to more turbid waters, and smaller land requirements. Recently there have been some modifications in rapid sand filtration, but these have required a degree of operation technique and an investment in initial and operation costs which are beyond the level of low cost methods of water treatment in most of the developing countries. The following discussion is therefore limited to the design of conventional rapid sand filtration plants.

A rapid sand filtration plant. The term rapid sand filtration implies a water treatment process which includes coagulation (i.e., rapid mixing and flocculation), sedimentation, filtration and disinfection. A flow diagram of a rapid sand filtration plant is shown in Figure VII.3.7.

As is shown in Figure VII.3.7, coagulation and sedimentation are necessary in preparation of the water for filtration. Careful preparation of the water by means of good coagulation and sedimentation with an optimum use of coagulants is essential for economy and for satisfactory filter operation. As water flows through the various units, color, turbidity, tastes and odors, and bacteria are removed from the surface water supplies. Additional operations may include bar racks and coarse

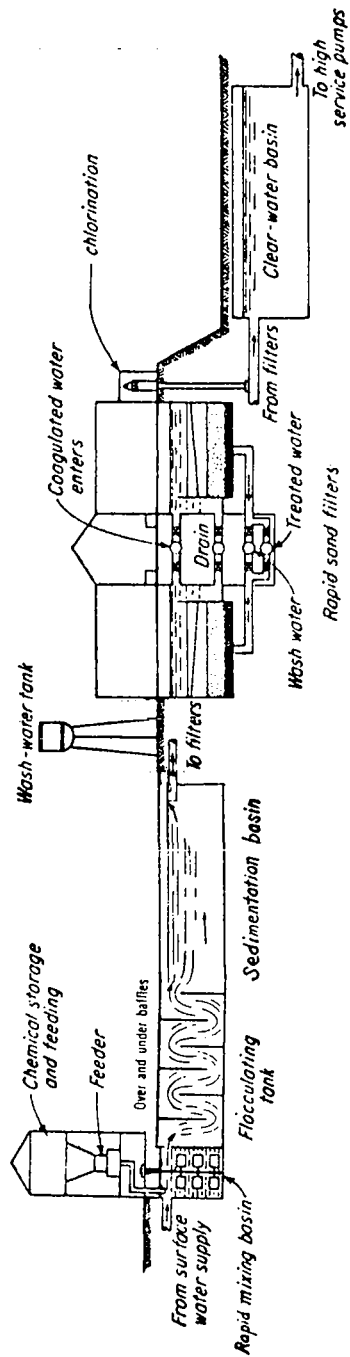

Fig. VII.3.7. A rapid sand filtration plant.

SOURCE: Modified from G. M. Fair, J. C. Geyer, and D. A. Okun, Elements of Water and Wastewater Disposal (New York: John Wiley & Sons, 1971.)

screens if floating debris and fish are a problem; aeration if shown to be economical and beneficial for treatment of tastes and odors; plain sedimentation if the water is highly turbid (1); and softening if the water is high in the degree of hardness.

Coagulation. Coagulation proceeds in two stages, rapid or flash mixing followed by flocculation or slow mixing. In the rapid mixing process, a coagulant is rapidly and uniformly dispersed through the mass of water. In the following flocculation process, a readily settleable floc is built up, and this may be defined as "floc growth."

Coagulants and feeding methods. By far the most important coagulant is aluminum sulfate, usually called alum or filter alum. Most commercial grades have the formula  $[Al_2(SO_4)_3 \cdot 14 H_2O]$ . Aluminum sulfate is available in lump, ground or liquid form (1). Other coagulants in use are iron salts, such as ferrous sulfate (also known as copperas and the most often used of the iron salts), ferric sulfate and ferric chloride. These iron salts can operate over a wider pH range than alum and are generally more effective in removing color from water, but they are usually more costly (6).

Optimum floc formation requires that for alum the pH be within the range of 5.0-7.0. Sufficient alkalinity must be present for reaction with the coagulant. If insufficient alkalinity is present in the water, lime is generally added. While they are not equally effective in all waters, some polyelectrolytes, when used in conjunction with the common metal coagulants, yield large dense floc which settles rapidly. This may improve sedimentation and reduce flocculation time. A polyelectrolyte is a linear or branched chain of small subunits containing ionizable groups. Polyacrylate is an example of an anionic

polyelectrolyte:

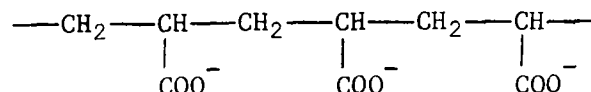

The method of feeding chemicals is either in solution or as solids. In a small plant, chemicals dissolved in water and fed as a solution can be more accurate and less costly than dry feed. One of the simple solution feeding devices is arranged as in Figure VII.3.8. For determining the optimum dosage of coagulant and needed stirring the jar test is most commonly used. This test is performed in the laboratory with the aid of a stirring device with a variable speed motor, and trials are made on small quantities of the water to be treated.

Rapid mixing devices. Rapid mixing may be accomplished by injection of the chemicals into a point of high-velocity flow, such as ahead of the suction of a low-lift pump or hydraulic pump. Injection of chemicals ahead of a low-lift pump has the advantages of the short period required for mixing, the low cost, and the fact that there is no additional head loss. When a hydraulic pump mixer is employed, the flow velocity should be as rapid as three m/sec, and the available head loss should be at least 0.3 meter. A baffled mixing basin has the advantage that there is very little short circuiting and it is a suitable device for small plants. In practice, in a baffled basin used for rapid mixing the velocity needs to be above 1.5 m/sec and the head loss must lie between 0.3 and 1.0 m. The rapid-mix chambers fitted with vertical-shaft rotary mixing devices are also widely used today. The practice followed in the design of rapid mixing units has been to provide ten to thirty seconds of detention time.

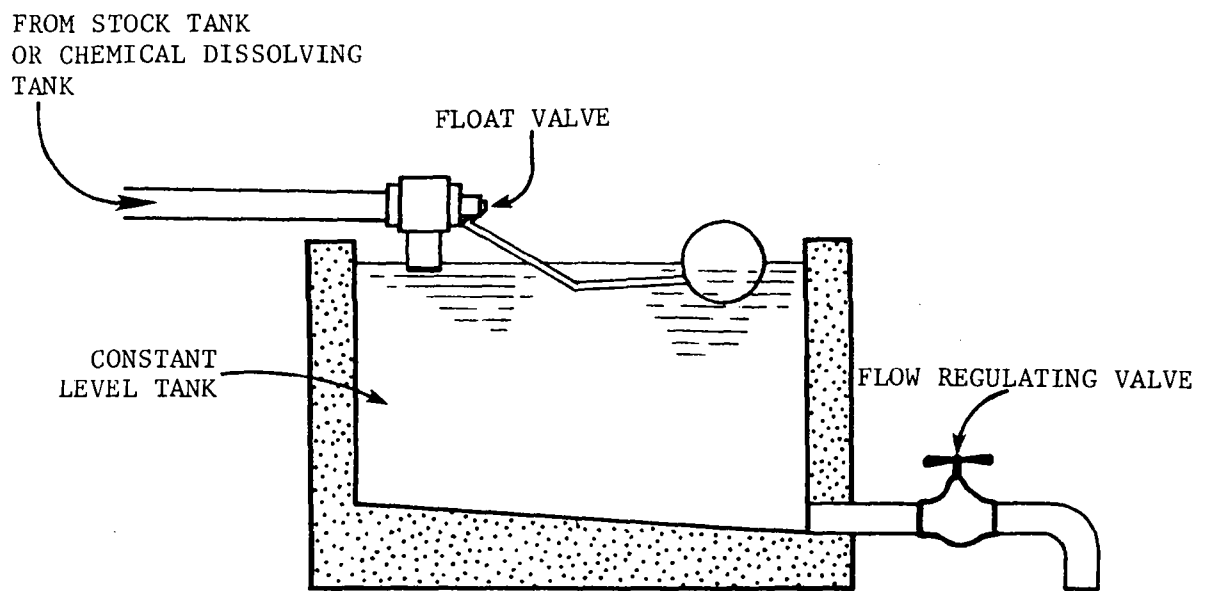

Fig. VII.3.8. A simple solution feeder.

Flocculation basins. This stage involves slow and gentle stirring with sufficient time allowed to build up floc. The completeness of the process is described by a dimensionless term  $Gt$ , where  $G$  ( $\text{sec}^{-1}$ ) is the mean velocity gradient in the basin and  $t$  (seconds) is the detention time (3). The magnitude of  $G$  is a function of the useful power input ( $P$ ) relative to the volume of the fluid ( $C$ ) and a proportionality factor ( $\mu$ ) which has the same dimensions as the absolute viscosity and is equal to it in laminar flow.

$$G = \sqrt{P/(C\mu)}$$

In flocculation practice,  $Gt$  may range within the limits  $10^4$  to  $10^5$ . Detention times range from twenty to sixty minutes, and velocity gradients range from five to 100 (1/sec) with optimum values between thirty and sixty (1/sec) (1,6). Too high a velocity gradient will shear floc particles, and too low a velocity gradient will fail to provide sufficient agitation to enable floc formation. When the floc particles have grown in size, they become weaker and more subject to being torn apart. So, tapered flocculation is frequently used.

Baffled flocculation basins of horizontal (around-the-end) or vertical (over-and-under) types, formerly widely used, are still most suitable for small plants in rural areas of developing countries. They have the advantages of very little short-circuiting and no necessity for mechanical equipment. The depth of the basins is around three to five meters. Spacing between the baffles is around sixty centimeters to facilitate cleaning operations. The flow velocity is designed in a range of fifteen to fifty cm/sec, and the total head loss will be around thirty to ninety centimeters. The around-the-end types of basin is commonly applied to plants with capacities below 76,000



cubic meters/day, and the over-and-under type with the advantage of more continuous turbulence is applied where sufficient water head is available and land is limited.

Mechanical flocculators are gaining in popularity at present. They usually employ rotating paddle wheels. The paddle area is commonly between ten and twenty-five percent of the tank section area.

Sedimentation basins. Design for sedimentation following flocculation depends on the settling characteristics of the floc formed in the coagulation process. A general range of detention times is two to four hours. The overflow rates (surface loading) used in floc settling vary from twenty to forty  $\text{m}^3/\text{day}/\text{m}^2$  ( $\text{m}/\text{day}$ ), and the horizontal velocity is commonly below thirty centimeters/minute to minimize the disturbances caused by such things as density currents and eddy currents in the basins. An eddy current is caused by the inertia of the incoming fluid. A density current occurs due to the difference in density of water layers with varying temperatures, and this can cause cold or heavy water to underrun a basin and warm or light water to flow across its surface. The length of rectangular basins is practically less than thirty meters, but basins can be constructed with a maximum length of up to about 100 meters. The depth of the basin is about two to five meters, three meters being a preferred value (7). The ratio of length to width is commonly between 3:1 to 5:1. Inlets must distribute the flow as uniformly as possible, and this can be achieved by using a dispersion wall perforated by holes or slots. Control of outflow is generally secured by a weir attached to one or both sides of a single or multiple outlet trough. Weir loading should be held below  $400 \text{ m}^3/\text{day}/\text{m}$  (7).

The cleaning of tanks can be carried out either mechanically (i.e., a sludge-removal device) or manually. In developing countries and elsewhere where labor is readily available, the latter method will be favored. In manually cleaned basins, the time lapse between cleanings varies from a few weeks to a year or more, and the sludge accumulated is sluiced by fire hose after the tank has been cut out of service and dewatered.

If a circular settling tank is used, the diameter may be as large as seventy meters, but they are generally held to thirty meters or less in diameter to reduce wind effects.

Rapid sand filters. The rapid sand gravity filter is commonly used to remove nonsettleable floc and impurities remaining after coagulation and sedimentation of raw water. The filtering mechanism of a rapid sand filter is very complex, consisting of the actions of straining, sedimentation and flocculation.

Rapid sand filters are usually laid out side by side in rows along one side or along both sides of a pipe gallery which contains inlet and outlet piping, wash-water inlet lines and backwash drains. A typical rapid sand filter with accessory equipment is shown in Figure VII.3.9.

A rapid sand filter of the open gravity type consists of an open watertight basin containing a layer of sand sixty to eighty centimeters thick, supported on layers of gravel. The gravel is underlaid by an underdrainage system which leads to the outlet where a rate controller is located. The rate of filtration commonly varies from 100 to 150  $\text{m}^3/\text{day}/\text{m}^2$ .

The size of sand used in a rapid filter is described by the effective size, which is the sieve size in millimeters that permits ten

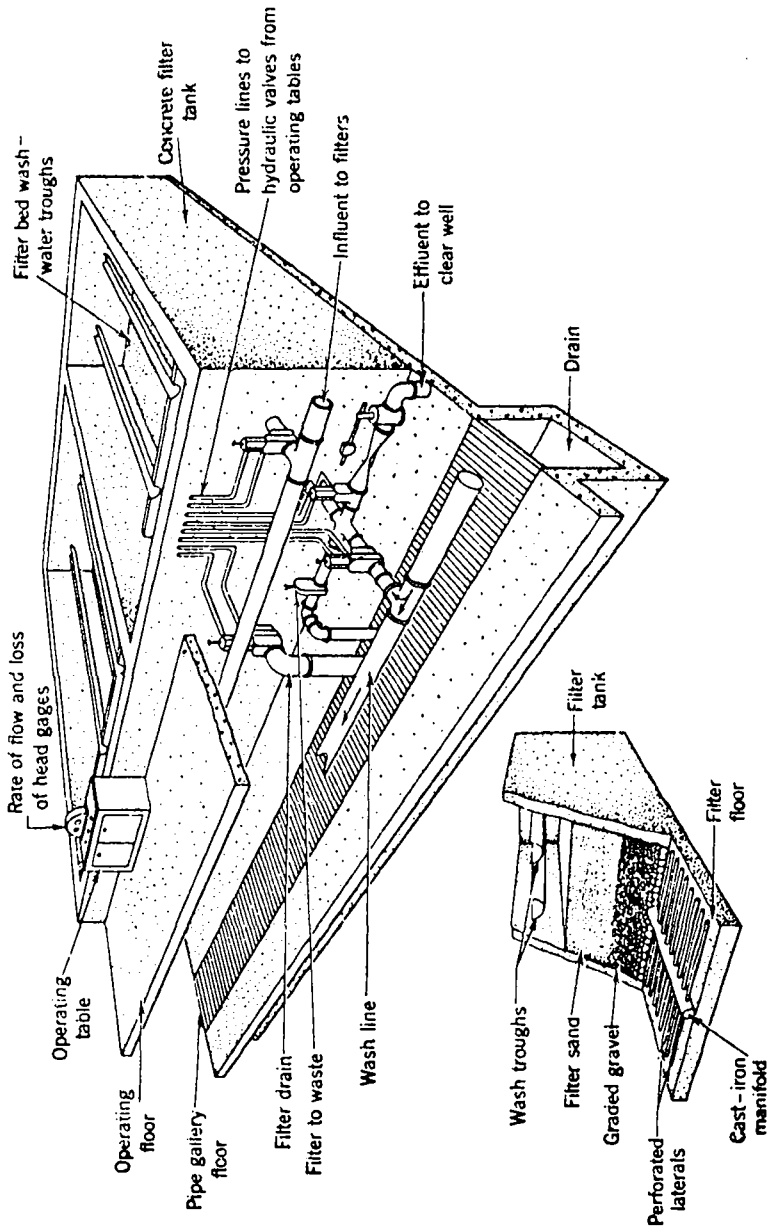

Fig. VII.3.9. Rapid filters and accessory equipment

SOURCE: C. P. Hoover, Water Supply and Treatment (National Lime Association).

percent of the sand by weight to pass. Uniformity in size is described by the uniformity coefficient, which is the ratio between the sieve size that will pass sixty percent to the effective size. Common ranges in effective size and uniformity coefficient are 0.40-0.55 mm and 1.35-1.75, respectively (6). During filtration, the depth of water above the sand surface is from 1.0 to 1.5 m. The total head available for filtration is equal to the difference between the water surface above the sand bed and the water level in the clear well, commonly three to four meters. Under average operating conditions the filter run is commonly twenty-four hours (ranging from twelve to seventy-two hours) which corresponds to a measured head loss through the filter bed of about 2.5-3 m. As the filter run is ended, the filter is cleaned by backwashing at a rate of about  $0.6 \text{ m}^3/\text{min}/\text{m}^2$  for a period of five to ten minutes. The expansion ratio is about twenty to fifty percent (1). The clear water for backwashing is from either a wash-water tank or pumps. It flows into the filter under-drainage system, where it is distributed upward through the sand filter. Dirty wash water is collected by troughs and flows into a channel connected to the drain. Usually, rotary surface washers are also installed in the filters to improve filter cleaning and prevent mud-ball formation and filter cracking. After backwashing, the initial filtered water is normally wasted for three to five minutes.

Usually the minimum number of filter units is two. The surface area of a filter unit is normally below  $150 \text{ m}^2$  to secure uniform distribution of wash water. The ratio of length to width of a filter box lies between 1.25 and 1.35.

The graded layers of gravel furnish proper support for the sand, and act as a dispersing medium to reduce jet action for the backwash. The size and depth of the lowest layer of gravel depends on the type of underdrainage system used, and the size and depth of the top layer of gravel depends on the size of the bottom layer of fine media above. The filter gravel bed commonly consists of four or five layers of gravel sizes ranging from three to sixty millimeters with the finest size located on top. The total depth of gravel may vary from fifteen to sixty centimeters, and is usually about forty-five centimeters.

The most important function of the filter underdrain is to provide uniform distribution of backwash water. A widely used type is the perforated-pipe system (see Figure VII.3.9), which consists of a manifold and laterals. Other systems are the pipe and strainer type, the vitrified-tile block with orifices, porous plates and precast-concrete underdrains (6). Manufacturers of filter equipment have devised various types of underdrain systems.

To operate the plant without too frequent a variation of its output rate and also to provide storage for filtered water, a clear well can be located beneath the filter units or in a separate structure.

As a variation on the conventional rapid sand filter, either a crushed anthracite coal or a dual-media (a sand layer topped with a bed of anthracite coal media), may be substituted for sand, but they are more costly than sand media.

Chlorination. Chlorination has been a standard treatment at rapid sand filter plants for destroying disease bacteria. The chlorine is generally added in the filter effluent pipe or in the clear well so that an adequate contact time will be assured.

Management of water treatment plant residues. In the past, settled coagulation wastes and backwash water have been disposed of without treatment, but these solids discharged may promote buildup of deposits of "sludge banks" in the backwaters of slowly moving portions of streams. From an aesthetic standpoint, the discharge of these wastes is objectionable because it will markedly increase the turbidity and apparent color of the receiving waters (2). Furthermore, the discharge also contains polluting concentrations of chemicals used in processing. Proper procedures for disposal of such wastes from water treatment plants are recommended for consideration in developing countries according to the local pollution control requirements and financial resources. Possible procedures include: direct discharge to a receiving stream with an adequate flow rate or drainage system, lagoons or sludge drying beds, hauling away for surface land application, discharge into a municipal sewerage system, recirculation and reuse of filter washwaters, dewatering of sludge, and reclamation of alum or other useful constituents (2,6).







## CHAPTER VIII

# Wastewater Disposal and Treatment

In this chapter are presented several wastewater treatment or disposal methods for application to sewered wastewaters. These particular methods were selected for inclusion because of their low cost and their suitability for developing countries. Stabilization ponds are among the processes associated with developing countries, and the first section of this chapter deals with this subject at length before giving brief descriptions of the use of fish ponds and oxidation ditches. This material represents a shortened version of the original publication. Stabilization pond systems are a treatment of choice in developing countries due to their generally low cost and because many developing countries are located in tropical areas which provide optimum climatic conditions for pond operation. Data are given on the performance and costs of ponds, and some comparisons are made with aerated lagoons and activated sludge systems.

In the second section in this chapter, information is given on the aerated lagoon, including process design considerations and power requirements for mixing. The cost of an aerated lagoon is generally more than that of a stabilization pond and less than that of an oxidation ditch. Among the advantages of aerated lagoons in comparison with stabilization ponds, are first, their ability to handle higher loadings with a shorter detention time in a reduced area. In addition, algae are not necessary to provide oxygen to an aerated lagoon; therefore, this type of unit can be used without regard to the amount of available sunlight.

In the third section of this chapter, an article on land application of wastewater presents a practice which was formerly used primarily for wastewater disposal but which more recently has often been used for wastewater treatment or reuse. Like the article on aerated lagoons this article was prepared especially for publication in this volume. Design criteria are given, and cost and health aspects are discussed. With this method wastewater is spread over the land. After having been subjected to filtering and stabilization of the organic matter by topsoils and soil biota, the treated water may be collected by a drainage system for reuse or allowed to recharge natural aquifers. The requirements of this process are low in terms of energy and chemicals, and the water yielded from a properly maintained system will be of similar quality to the water provided by advanced tertiary treatment processes. A principal problem associated with land application is the possibility of pollution of groundwater or soils with harmful substances.

## VIII.1.

## SEWAGE TREATMENT IN DEVELOPING COUNTRIES

L. W. Canter and J. F. Malina

## INTRODUCTION

The need for wastewater treatment in developing countries can be seen in the numerous instances where raw sewage is diverted into streams or oceans, thus contaminating waters that could be used for human consumption, industrial needs, land irrigation, fish production, or recreation. However, only a small percentage of the population in most developing countries is served by wastewater treatment facilities, due to the high costs of certain wastewater treatment processes, the lack of qualified personnel to operate and maintain sophisticated treatment processes, and the low priority generally assigned to wastewater treatment relative to other national needs.

This study was meant to provide a state-of-the-art of sewage treatment in developing countries. Mention was made of processes utilized in developing countries from the context of available treatment system technology. No attempt was made to cover every process in detail. The paper was oriented to treatment applied for seweraged wastewaters. This paper was developed following a review of published references on wastewater treatment in developing countries. In addition, selected non-U.S. and some U.S. references for developed countries were identified relative to wastewater treatment. The

---

Norman: The University of Oklahoma Bureau of Water and Environmental Resources Research, December 1976. (174 pp.)

following processes were found to be associated with developed countries: primary (conventional), sludge (conventional), sludge (advanced), secondary (standard filter), secondary (high rate filter), secondary (activated sludge), secondary (extended aeration), disinfection, agricultural utilization, ground discharge, and tertiary treatment. Those processes which were found to be associated with developing countries included primary (stabilization ponds), sludge (conventional), ocean disposal, and septic tanks. On the basis that ponds are the most used process in developing countries, the major portion of this report is a presentation of the use and costs of ponds and increases in treatment costs associated with the use of more sophisticated wastewater treatment processes. There are two basic reasons for the popularity of waste stabilization pond systems in developing countries. One is the low cost, particularly for smaller communities. Another is the fact that the optimum climatic conditions for ponds are to be found in tropical areas where many developing countries are located.

Wastewater Treatment Goals. It is useful to consider the wastewater treatment goals that have been identified for treatment practices in the United States. Table VIII.1.1 shows the wastewater treatment goals in the United States from an historical perspective (Barth, 1971).

Wastewater treatment goals for developing countries should be primarily oriented to protecting public health through the control of pathogens, and secondarily oriented to the removal of oxygen-demanding materials and suspended solids. Future wastewater treatment goals for developing countries, however, are expected to become more

TABLE VIII.1.1  
 UNITED STATES WASTEWATER TREATMENT GOALS

Time Period	Goals
1900 - 1920	Remove: suspended solids oxygen demanding materials. Transform $\text{NH}_4^+$ to $\text{NO}_3^-$ .
1920 - 1964	Remove: suspended solids BOD <sub>5</sub> . Protect receiving water from toxicants. Control coliforms.
1964 - 1972	Remove: suspended solids oxygen-demanding materials nitrogen (or transform $\text{NH}_4^+$ to $\text{NO}_3^-$ ) phosphorus. Protect receiving water from toxicants. Control coliforms. Positive control of sludges and brines.
Current Trend	Elimination of discharge of all pollutants.

1920, approximate time of introduction of activated sludge process.  
 1964, initiation of advanced wastewater treatment research program of the U.S. Public Health Service.

similar to those for developed countries, and table VIII.1.2 indicates certain treatment processes which would then be appropriate.

#### STABILIZATION PONDS

History of Pond Usage in Developing Areas. Man-made stabilization lagoons for sewage treatment, fish production, and land irrigation have been used in Asia for centuries. In Europe, fish ponds were built by the Greeks in Agrigantum, Sicily, before modern times (Gloyna, 1971), and ponds have been used in India for a considerable period of time. The use of ponds in Marandellas, Southern Rhodesia, was reported in 1960 (Hodgson, 1964). By 1967, ponds were in use in several countries (Gloyna, 1971), including Argentina, Bolivia, Brazil, Colombia, Costa Rica, Cuba, Ecuador, Ghana, Guatemala, India, Israel, Kenya, Mauritius, Mexico, Nicaragua, Nigeria, Pakistan, Peru, Saudi Arabia, South Africa, Southern Rhodesia, Thailand, Uganda, the United Arab Republic, Venezuela, and Zambia. This list of countries was extended by Talboys (1971) to include Chile, El Salvador, Panama, Barbados, Honduras, the Dominican Republic, and Uruguay. This literature review found references to the use of ponds in the additional countries of Malaysia, South Vietnam, and Tanzania.

Biology of Waste Stabilization Ponds. Figure VIII.1.1 shows common interactions in a waste stabilization pond (Zajic, 1971). Waste stabilization pond operation depends upon the symbiotic relationship between bacterial degradation of organic matter and algal photosynthetic production of oxygen. Aerobic, facultative, and anaerobic bacteria are found in ponds. Predominant bacteria under aerobic or facultative conditions include Pseudomonas, Acromobacter, Flavobacterium, and

TABLE VIII.1.2

TREATMENT PROCESSES APPROPRIATE TO  
PROJECTED WASTEWATER TREATMENT GOALS IN DEVELOPING COUNTRIES

Process	Coliform Control	Solids Removal	Oxygen Demand Removal	Sludge Control	Phosphorus Removal	Nitrogen Control	Toxicant Control
Primary (conventional)		x					
Primary (stabilization pond)	x	x	x				
Sludge (conventional)				x			
Sludge (advanced)				x			
Sludge (combined Imhoff)		x	x	x			
Secondary (standard filter)		x	x	x			
Secondary (high rate filter)		x	x	x			
Secondary (activated sludge)		x	x	x			
Secondary (extended aeration)		x	x	x			
Disinfection	x						
Agricultural utilization	x						
Ground discharge	x						
Ocean disposal				x			
Septic tanks	x	x	x	x			
Tertiary (reverse osmosis, ion exchange, combustion)					x	x	x

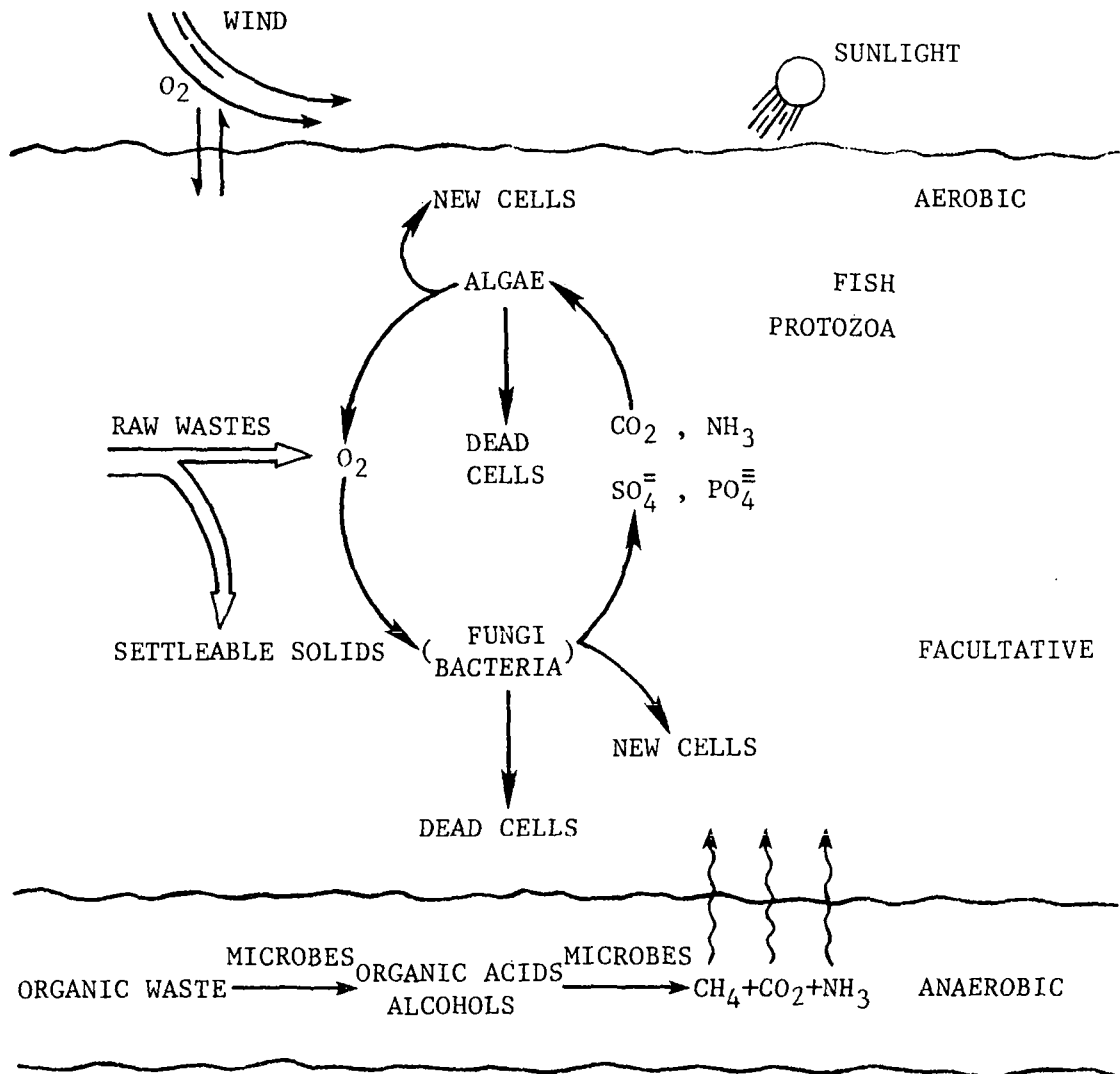

Fig. VIII.1.1. Schematic diagram of waste stabilization lagoon operation.



Alcaligenes (McKinney, 1962; Zajic, 1971; Gann, Collier, and Lawrence, 1968; Oswald, 1968, "Advances"). Under anaerobic conditions the genus Clostridium predominates, but sulfate-reducing and methane-forming bacteria can also be present. Four genera of the methane-forming bacteria have been recognized: Methanobacterium, Methanobacillus, Methanococcus, and Methanosarcina (Mitchell, 1974). Algae in waste stabilization lagoons have been grouped as green algae, diatoms, and blue-green algae by Gloyna (1971). On the other hand, Palmer (1962) and Eckley, Canter, and Reid (1974) have grouped them as blue-green algae, green algae, diatoms, and pigmented flagellates. A representative list of algal genera reported in stabilization ponds in developing countries is contained in Table VIII.1.3. In this table, the genera most commonly found are Chlorella, Oscillatoria, Chlamydomonas, and Euglena.

Protozoa, rotifers, and fungi occur in ponds and are important in obtaining effluents with minimum turbidity (Calaway, 1968; Ruttner, 1973; Gloyna, 1971; Cubillos, 1970; Canter, 1969; Purushothaman, 1970; and Amin and Ganapati, 1972). Rotifers are of special interest because they feed on small organic particles as well as on bacteria and algae (Pennak, 1953; Ruttner, 1973; McKinney, 1962). The role of fungi in waste treatment resides in their capacity to assimilate a wide range of complex organic materials, and their ability to produce bactericidal substances (Carpenter, 1969; Vennes, 1970; and Zajic, 1971).

At least two orders of crustaceans have been found in waste stabilization ponds: Clodocera and Copepoda. The genera Daphnia belonging to the former, and Cyclops belonging to the latter, have been identified in many stabilization lagoons (Diaz, 1975). Like rotifers,

TABLE VIII.1.3

ALGAL GENERA OBSERVED IN  
STABILIZATION PONDS IN DEVELOPING COUNTRIES

Country	Algal Genera	Reference
Brazil	<u>Chlorella</u>	Talboys, 1971
Colombia (Cali)	<u>Chlorella</u> <u>Carteria</u> <u>Euglena</u> <u>Chlamydomonas</u> <u>Lepocinclis</u> <u>Nitzschia</u> <u>Achromobacter</u> <u>Pseudomonas</u> <u>Flavobacterium</u>	Canter, 1969      Jourdan, 1969
Colombia (Palmira)	<u>Chlorella</u> <u>Euglena</u>	Canter, 1969
India (Ahmedabad)	<u>Arthrospira</u> <u>Oscillatoria</u> <u>Chlorella</u>	Jayangoudar et al., 1970 Amin and Ganapati, 1972
India (Madras)	<u>Eudorina</u> <u>Oocystis</u> <u>Pandorina</u> <u>Merismopedia</u> <u>Oscillatoria</u> <u>Spirulina</u>	Purushothaman, 1970
Mexico (Durango)	<u>Chlorella</u> <u>Scenedesmus</u> <u>Euglena</u> <u>Oscillatoria</u> <u>Phacus</u>	Talboys, 1971
Panama (Canal Zone)	<u>Chlorella</u>  <u>Chlamydomonas</u>  <u>Euglena</u> <u>Anacystis</u> <u>Pseudomonas</u> <u>Alcaligenes</u>	Longley, Young, and Ashmore, 1970 Eckley, Canter, and Reid, 1974
Peru (Lima)	<u>Chlorella</u> <u>Euglena</u>	Talboys, 1971

TABLE VIII.1.3--Continued

Country	Algal Genera	Reference
Rhodesia (Mandarellas)	<u>Golenkinia</u> <u>Scenedesmus</u> <u>Closteriopsia</u> <u>Micractinium</u>	Hodgson, 1964
Thailand	<u>Chlorella</u>	McGarry, 1970
Zambia (Lusaka)	<u>Micractinium</u> <u>Ankistrodesmus</u> <u>Euglena</u> <u>Chlorella</u>	Marais, 1970

clodocerans and copepods feed on bacteria and algae, and are important to the clarification of pond effluents (Vennes, 1970; De Noyelles, 1967; Tschortner, 1968; and Hodgson, 1964).

Snails in waste stabilization ponds can act as vectors in the transmission of schistosomiasis. Pond detention time is important in this regard, since Hodgson (1964), while investigating a pond in Mandarellas, Southern Rhodesia, found that snail vectors were not capable of survival for more than ten weeks in a pond environment.

Aquatic insects such as mosquitoes can be a problem in ponds with no routine maintenance program (Kimmerle and Enns, 1968). Periodic removal of peripheral vegetation is generally required for achieving positive control (Longley, Young, and Ashmore, 1970; Eckley, Canter, and Reid, 1974; and Marais, 1966).

Fish in waste stabilization ponds can be used for insect control, algae control, and production of protein for animal and human consumption. Protein production and sewage treatment may have conflicting purposes, however, since sewage can be treated and passed through ponds at a rate greater than that at which maximum fish growth takes place (Mortimer and Hickling, 1954). The use of fish in waste stabilization ponds has been reported in Java, Thailand, Burma, Malaya, Sumatra, the Philippines, Formosa, Ceylon, the British West Indies, India, Rhodesia, China, Trinidad, Borneo, Pakistan, Puerto Rico, and Hawaii (Swingle, 1960; Mortimer and Hickling, 1954; Hodgson, 1964; McGarry, 1970; and Duffer, 1974).

Climatic Factors Affecting Pond Performance. Temperature, solar radiation, wind speed, evaporation, and rainfall are the principal climatic factors which affect pond performance. Temperature affects

photosynthetic oxygen production, rate of organic degradation, and chemical and biochemical reactions occurring in the pond. The optimum temperature for a pond system is from 25<sup>o</sup> to 32<sup>o</sup>C (Diaz, 1975).

Thermal stratification can occur in ponds as a result of liquid temperature differentials. If stratification persists, non-motile algae below the thermocline cannot enter the photic zone, and thus die due to lack of light (Marais, 1970). Thermal stratification can also cause short-circuiting, resulting in reduced effluent quality (Barsom, 1973).

Solar radiation affects the water temperature of ponds, and is also the energy source for photosynthesis. Probable values for visible solar energy are given in Table VIII.1.4 (Oswald and Gotaas, 1955). This table indicates that the predicted minimum and maximum values of visible solar energy for tropical areas are 120 and 270 Langleys, respectively. Measured values for ponds in tropical areas often exceed 270 Langleys (Gloyna, 1971; Marais, 1970; Eckley, Canter, and Reid, 1974; Canter, 1969; and Hodgson, 1964). According to Marais (1970), solar radiation in tropical areas does not seem to be a critical factor for algal growth and oxygen production.

Wind is a prominent factor affecting the performance of waste stabilization ponds. Wind aids reaeration in the top layer, and induces mixing in the whole body of water. Mixing is of special interest because it overcomes stratification, distributes oxygen from the top layers to the bottom layers, maintains non-mobile algae in suspension, enhances algae growth, and increases the organic capacity of ponds (Marais, 1970). Wind can also cause de-aeration under super-saturated conditions of dissolved oxygen (Canter, 1969), and during periods of

TABLE VIII.1.4

PROBABLE VALUES OF VISIBLE SOLAR ENERGY AS A FUNCTION OF  
 LATITUDE AND MONTH (IN LANGLEYS)<sup>a</sup>  
 (Langleys, cal/cm<sup>2</sup>/day)

Latitude		Jan.	Feb.	Mar.	Apr.	May	June	July	Aug.	Sep.	Oct.	Nov.	Dec.
0	max.	255	266	271	266	249	236	238	252	269	265	256	253
	min.	210	219	206	188	182	103	137	167	207	203	202	195
10	max.	223	244	264	271	270	262	265	266	266	248	228	225
	min.	179	184	193	183	192	129	158	176	196	181	176	162
20	max.	183	213	246	271	284	284	282	272	252	224	190	182
	min.	134	140	168	170	194	148	172	177	176	150	138	120
30	max.	136	176	218	261	290	296	289	271	231	192	148	126
	min.	76	96	134	151	184	163	178	166	147	113	90	70
40	max.	80	130	181	181	286	298	288	258	203	152	95	66
	min.	30	53	95	125	162	173	172	147	112	72	42	24
50	max.	28	70	141	210	271	297	280	236	166	100	40	26
	min.	10	19	58	97	144	176	155	125	73	40	15	7
60	max.	7	32	107	176	249	294	268	205	126	43	10	5
	min.	2	4	33	79	132	174	144	100	38	26	3	1

SOURCE: Oswald and Gotaas, 1955.

<sup>a</sup>One Langley equals one cal/cm<sup>2</sup>/day. Correction for cloudiness is:  $S_c = S_{\min} + r(S_{\max} - S_{\min})$ , where  $R$  = total hours sunshine/total possible hours sunshine. Correction for elevation up to 10,000 feet is  $S_c = S(1 + 0.01e)$ , where  $e$  = elevation in hundreds of feet.

excessive windspeed settleable solids might become suspended, thus reducing light penetration and consequently reducing photosynthetic activity. Excessive windspeed may also cause erosion along the edges of ponds (Callaway and Wagner, 1966). To avoid short-circuiting from inlet to outlet and retardation of the normal flow, the pond layout should be planned in a way to prevent having the prevailing wind direction along the line of flow (Callaway and Wagner, 1966). Prevailing wind direction is also an important consideration in the location of lagoons with respect to housing. A minimum of one-quarter mile from the housing area to the pond location is suggested (Callaway and Wagner, 1966).

Evaporation and rainfall are interrelated, and in various ways are affected by temperature, solar radiation, and wind speed. In tropical areas, evaporation might play an important role in determining the level of water maintained in the lagoon (Callaway and Wagner, 1966). Evaporation loss should be considered in lagoon design, or supplemental water should be provided to compensate for the evaporation loss (Barsom, 1973). Oswald (1968) reported that algae converting light into heat accelerate the rate of evaporation in ponds. Evaporation in algae cultures is at least ten percent greater than in plain water. Rainfall is important due to hydraulic design considerations for ponds. A heavy rain can increase reaeration, induce mixing, contribute water with large concentrations of dissolved oxygen, and in some cases, break down stratification in ponds.

Design Practice for Ponds. The majority of waste stabilization ponds are designed on the basis of organic loading, depth, and detention time (Zajic, 1971). Other factors influencing the design of

ponds are temperature, light, volumetric loading, bottom sediment accumulation, toxicity of waste, size and shape of pond facilities, hydraulic principles, and mode of operation (Gloyna, 1965). As Canter (1969) proposed, two approaches to designing waste stabilization ponds are: (1) use of design criteria based on usage and (2) use of empirical design equations based on experimentation.

Design criteria based on usage should be given preference depending on availability of satisfactory operating experiences and existence of similar climatic conditions prevailing in the area. While in the United States organic loadings for facultative ponds of fifty pounds BOD<sub>5</sub>/acre/day or less are most often used (Canter, Englande, and Mauldin, 1969), tropical areas can receive three to seven times this loading with successful results (Diaz, 1975). Table VIII.1.5 presented by Gloyna (1971) shows organic loadings for facultative ponds that have been used in various geographical locations with good results. Table VIII.1.6 summarizes some design loadings used on pond systems in Latin America, Asia, and Africa.

Empirical design relationships have been developed by several investigators. These will be presented for anaerobic ponds (Vincent), facultative ponds (Marais and Shaw, Herman and Gloyna, McGarry and Pescod, Siddiqi and Handa), and aerobic ponds (Oswald, and Zajic).

McGarry and Pescod (1970) presented an empirical formulation recommended by Vincent for anaerobic ponds in tropical areas. Complete mixing and a pH range between 6.8 and 7.2 must be assumed. This empirical formulation is presented in Equation 1, as follows:



TABLE VIII.1.5  
 BOD LOADINGS PER UNIT AREA PER DAY UNDER  
 VARIOUS CLIMATIC CONDITIONS

Surface Loading (Lb. BOD <sub>5</sub> /Acre/Day) <sup>a</sup>	Population Per Acre <sup>b</sup>	Detention Time (Days) <sup>c</sup>	Environmental Conditions
Less than 9	Less than 80	More than 200	Frigid zone with seasonal ice cover, uniformly low water temperature and variable cloud cover.
9 - 45	80 - 405	200 - 100	Cold seasonal climate with seasonal ice cover and temperate summer temperatures for short periods.
45 - 134	405 - 1,215	100 - 33	Temperate to semi-tropical zone with occasional ice cover and no prolonged cloud cover.
134 - 313	1,215 - 2,834	33 - 17	Tropical zone with uniformly distributed sunshine and temperature and no seasonal cloud cover.

SOURCE: Gloyna, 1971.

<sup>a</sup>Based on the assumption that the effluent volume is equal to the influent volume, i.e., that the sum of the evaporative and seepage losses is not greater than rainfall.

<sup>b</sup>Assuming a contribution of 0.11 lb. BOD<sub>5</sub> per person per day.

<sup>c</sup>Based on an influent volume of 260 gallons of waste per person per day.

TABLE VIII.1.1.6  
AREAL LOADINGS USED IN TROPICAL AREAS

Location	Loading (Lb. BOD <sub>5</sub> /Acre/Day)	Depth (Feet)	No. of Lagoons	Remarks	Source
<u>Latin America</u>					
Canas, Costa Rica	213	3-5	2	Facultative, parallel	1
Lima, Peru	254	2.3-40	1	Facultative	2
Lima, Peru	241	5.5a	21	Facultative, series	2
Mexicali, Mexico	1062	15 <sup>a</sup> -4.6 <sup>b</sup>	No data	Anaerobic-facultative, series	2
Brasilia, Brazil	536 <sup>a</sup> -80 <sup>b</sup>	6.5 <sup>a</sup> -3.3 <sup>b</sup>	2	Anaerobic-facultative, series	2
Canal Zone, Panama	150	6 <sup>a</sup> -4 <sup>b</sup>	3	Anaerobic-facultative, series	3
Palmdra, Colombia	150	3-5	3	Facultative, series and parallel	4
<u>Asia</u>					
Madras, India	180	2.75 <sup>a</sup> -5 <sup>b</sup>	5	Anaerobic-facultative, series	5
Ahmedabad, India	200-250	3-4	2	Facultative, series	6
Ahmedabad, India	325	4	1	Facultative	7
Nagpur, India	185 <sup>a</sup>	3.5 <sup>a</sup>	2	Facultative, series	7
Nagpur, India	417 <sup>a</sup> -394 <sup>b</sup>	5 <sup>a</sup> , <sup>b</sup>	2	Facultative, parallel	7
Bangkok, Thailand	5000	3	No data	Anaerobic	8
Bangkok, Thailand	200-400	8-15	24	High rate, parallel	9
Danang, Viet Nam	220	No data	2	Facultative, series	10

TABLE VIII.1.6 --Continued

Location	Loadings (Lb. BOD <sub>5</sub> /Acre/Day)	Depth (Feet)	No. of Lagoons	Remarks	Source
<u>Africa</u>					
Mandarellas, Southern Rhodesia	168 <sup>a</sup>	4 <sup>a</sup> -3 <sup>b</sup>	6	Facultative, series	11
Nairobi, Kenya	91.5a-57 <sup>b</sup>	5.7 <sup>a</sup> , <sup>b</sup>	2	Facultative, series	12

## SOURCES: Formulation of table, Diaz, 1975.

1. Saenz (1969)
2. Talboys (1971)
3. Eckley, Canter, and Reid (1974)
4. Canter (1969)
5. Purushothaman (1970)
6. Jayangoudar et al. (1970)
7. Dave and Jain (1966)
8. McGarry and Pescod (1970)
9. McGarry (1970)
10. Duttweiler and Burgh (1969)
11. Hodgson (1964)
12. WHO and Government of Kenya (1973)

<sup>a</sup>Primary ponds.

<sup>b</sup>Secondary Ponds.

$$P = \frac{P_o}{6\left(\frac{P}{P_o}\right)^{4.8} R + 1} \quad (\text{Equation 1})$$

where  $P$  = Pond and effluent, 20°C BOD<sub>5</sub> (mg/l)

$P_o$  = Influent, 20°C BOD<sub>5</sub> (mg/l)

$R$  = Retention time for completely mixed separate pond system (days).

Marais and Shaw developed an equation for facultative ponds in southern and central Africa (Gloyna, 1971). Complete mixing and reduction of BOD according to a first-order reaction were assumed. The equation is as follows:

$$L_p = \frac{600}{(0.18d + 8)} \quad (\text{Equation 2})$$

where:  $L_p$  = Effluent BOD<sub>5</sub> (mg/l)

$d$  = Depth (m.)

and if the initial BOD and detention time are known:

$$L_p = \frac{L_o}{0.17 R_T + 1} \quad (\text{Equation 3})$$

where:  $L_o$  = Influent BOD<sub>5</sub> (mg/l)

$R_T$  = Detention time at temperature  $T$ .

Herman and Gloyna also proposed an equation particularly useful for temperate and warmer areas (Gloyna, 1971). This relationship, shown by Equation 4, emphasizes the influence of temperature on detention time.

$$V = (3.5 \times 10^{-5}) N_q L_a \theta^{(35-T_m)} \quad (\text{Equation 4})$$

where:  $V$  = Pond volume ( $m^3$ )

$N$  = Number of people contributing waste

$q$  = Per capita waste contribution (liters/day)

$\theta$  = Temperature reaction coefficient = 0.085

$T_m$  = Average water temperature of coldest month

$L_a$  = Influent ultimate BOD (mg/l).

McGarry and Pescod (1970) developed an equation describing the relationship between possible areal BOD loading and ambient monthly mean temperature. The applicable temperature range is  $20 - 90^\circ F$ , and the equation is as follows:

$$L_o = 10 (1.054)^T \quad (\text{Equation 5})$$

where:  $L_o$  = Areal BOD loading (pounds/acre/day)

$T$  = Ambient mean monthly temperature,  $^\circ F$ .

McGarry and Pescod (1970) also developed a design relationship for primary facultative ponds in tropical areas. Equation 6 was formulated after a study of ponds operating under 143 different conditions:

$$L_r = 9.23 + 0.725 L_o \quad (\text{Equation 6})$$

where:  $L_r$  = Areal BOD removal (pounds/acre/day)

$L_o$  = Influent  $BOD_5$  (mg/l).

Siddiqi and Handa (1971) proposed a design equation after studying ponds in seven different cities in India. The relationship is as follows:

$$E = \frac{100}{1 + 0.188 L_f^{0.48}} \quad (\text{Equation 7})$$

where: E = BOD performance efficiency (%)

$L_f$  = Loading factor (ratio of BOD load to oxygen production by algae. The range of  $L_f$  must be between 0.44 and 8.0).

Oswald (1968, "Quality") proposed the following design equation for aerobic ponds:

$$\frac{d}{D} = \frac{0.66 FS}{L_a} \quad (\text{Equation 8})$$

where: F = Oxygenation factor or ratio of oxygen produced to the oxygen required (usually between 1.2 and 1.8)

S = Solar radiation (calories/cm<sup>2</sup>/day)

d = Depth (m)

D = Detention time (days)

$L_a$  = Influent first-stage BOD (mg/l).

Zajic (1971) presented a design equation developed by Oswald and Gotaas. This relationship has also been applied to the design of aerobic ponds:

$$A = \frac{hW}{FES} \quad (\text{Equation 9})$$

where: A = Surface area of pond (cm<sup>2</sup>)

h = Unit heat of combustion (cal/gm)

W = Net weight of oxygen produced (g/day)

E = Efficiency of solar energy conversion to usable photosynthetic energy, usually 2 to 4%

For F and S, see equation 8.

Aerated ponds or lagoons represent an intermediate treatment system between natural treatment (waste stabilization ponds) and mechanical treatment (activated sludge plants). Aerated lagoons are

basically ponds with provisions for oxygenation through the use of surface aeration devices. Brazilian design criteria for facultative ponds and aerated lagoons are summarized in Table VIII.1.7.

Pathogen Removals in Ponds. Pond removal efficiencies for coliform and pathogenic bacteria are usually high, and values of up to 99% are often observed. Many theories about the destruction of pathogens in ponds have been suggested. Parhad and Rao (1974) suggested that the rapid die-off of coliforms may be attributed to the high pH found in ponds. They found that E. coli could not grow in wastewater with a pH greater than 9.2. Gann, Collier, and Lawrence (1968), conducting a study with model ponds in Oklahoma, concluded that reduction of coliforms in ponds is closely related to BOD removals, thus indicating that coliforms are removed because of their inability to compete successfully for nutrients. McKinney (1962) also proposed competition for food as a principal reason for coliform removal in ponds. He suggested that predatory protozoan populations can also be responsible. Caldwell (1956), Davidson (1961), and Merz, Zehnpfennig, and Klima (1962) suggested that toxic substances produced by algae reduce the number of bacteria including coliform bacteria. Chlorellin, a substance liberated by Chlorella, was reported to have a marked antibacterial activity. Oswald and Gotaas (1955) stated that in a study they conducted in laboratory and pilot plants, no anticoliform activity could be credited to algae. They proposed that besides the normal die-off of coliforms, the bactericidal effect of solar radiation should be taken into consideration. Smallhorst, Walton, and Meyers (1953) suggested that detention time and settling are also important factors in the removal of bacteria from stabilization lagoons. Other environmental

TABLE VIII.1.7  
 DESIGN CRITERIA FOR PONDS AND AERATED LAGOONS  
 IN BRAZIL

	Facultative Pond	Aerated Lagoon
Efficiency (%)	90	90
Depth (meters)	2	3
Detention time (days)	--	6
BOD <sub>5</sub> (gm/capita-day)	54	54
Flow (l/cap-day)	170	170
Temperature (°C)	17°C -- 21°C	20°C
BOD <sub>u</sub> /BOD <sub>5</sub>	1.46	1.46
Maximum area per pond (hectares)	8	8
Constant K <sub>1</sub> (per day)	--	0.35
Kg O <sub>2</sub> added/Kg BOD removed	--	0.7
Kg O <sub>2</sub> added/h.p./hr	--	1.2
Hp/1000 m <sup>3</sup>	--	2.68

SOURCE: Correspondence with E. Jordao, Rio de Janeiro, Brazil.



factors responsible for a decrease in bacterial concentrations include: (a) dilution and mixing, (b) aggregation, (c) presence of toxic substances, and (d) temperature (Gloyna, 1971).

Several equations have been developed to describe bacterial removals in ponds. A modification of Chick's Law that describes the rate of bacterial disappearance is as follows (Gloyna, 1971):

$$\frac{(N'_o - N'_R)}{N'_o} = \frac{N'_t}{N'_o} = (1 + ck'_1R)^{-\frac{1}{c}} \quad \text{(Equation 10)}$$

where:  $N'_t$  = Bacterial population at detention time R (days)

$N'_o$  = Initial bacterial population

$N'_R = N'_o - N'_t$

$c$  = Non-uniformity coefficient

$k'_1$  = Rate constant,  $\log_e$  (bacterial disappearance/day)

$R$  = Detention time (days).

When removal occurs at a uniform rate,  $c = 0$ .

Marais (1966) proposed equations to relate the reduction of faecal bacteria in a single pond and in a series of ponds. These equations are, for a single pond:

$$\frac{N'_t}{N'_o} \% = \frac{100}{(2R + 1)} \quad \text{(Equation 11)}$$

and for a series of ponds:

$$\frac{(N'_t)}{N'_o} \% = \frac{100}{(2R_1 + 1)} \cdot \frac{100}{(2R_2 + 1)} \quad \text{(Equation 12)}$$

where:  $N'_t$  = Faecal bacteria in pond effluent (per ml)

$N'_o$  = Faecal bacteria in pond influent (per ml)

$R, R_1, R_2$  = Retention time for completely mixed separate pond system (days).

Canter (1969) presented an equation for predicting pathogen removals developed by Mauldin.

$$P.R. = \frac{(100) (K) R^{0.04}}{L^{0.306} D^{0.0033}} \quad (\text{Equation 13})$$

$$K = 0.0089 (L) + 2.55$$

where: P.R. = Percentage removal

K = Proportionality constant

L = Organic loading rate (lb. BOD<sub>5</sub>/acre/day)

D = Depth (feet)

R = Detention time (days)

Considering the removal of viruses, stabilization ponds seem to have higher percentage removals than conventional wastewater treatment plants if the pond is loaded to its design capacity (Stander et al., 1973). Shuval (1973), in studying the effectiveness of an Imhoff tank, biological filtration plant, and stabilization ponds for removal of enteroviruses, concluded that ponds, although not very efficient in virus removal (67% removal), were still more effective than the two other wastewater treatment units. Slanetz et al. (1970), suggested that virus removal depends on exposure to solar radiation, absorption due to static forces, or detention beyond the normal survival time of the virus. Virus removal seems to be independent of the biological processes occurring in ponds.

Pond System Performance. Table VIII.1.8 contains a summary of BOD and bacterial removals observed for ponds in developing countries. The data reveals that the majority of the pond systems have BOD removals of 80% or more. Values obtained for coliform removal are much higher than for BOD removal. The data also suggests that higher

TABLE VIII.1.8

BOD AND COLIFORM REMOVALS  
FOR PONDS IN DEVELOPING COUNTRIES

Location	Loading (lb. BOD <sub>5</sub> /Acre/Day)	BOD Removal (%)	Coliform Removal (%)	No. of Lagoons	Remarks	Source
<u>Latin America</u>						
Canas, Costa Rica	213	93	97	2	Facultative, parallel	1
Lima Peru	254	70	N.D.	1	Facultative	2
(Same lagoon)	490-540	68	N.D.	1	Odor problems	2
Durango, Mexico	N.D.	69-80	N.D.	2	Facultative, parallel	2
(Same lagoon)	N.D.	73-82	95.3-99 (+)	2	Facultative, series	2
Brasilia, Brazil	536 <sup>a</sup> -80 <sup>b</sup>	86 <sup>c</sup>	90 <sup>c</sup>	2	Anaerobic-facultative, series	2
Canal Zone, Panama	143	75	99 (+)	3	Anaerobic-facultative, series	3
Palmira, Columbia	128 <sup>a</sup>	93	99 (+)	3	Facultative, series parallel	4
<u>Asia</u>						
Madras, India	170	67-87	93-99	5	Anaerobic-facultative, series	5
Ahmedabad, India	246	80	N.D.	2	Facultative, series	6
Ahmedabad, India	325	73	N.D.	1	Facultative	7
Nagpur, India	185	88	N.D.	2	Facultative, series	7
Nagpur, India	417 <sup>a</sup> -394 <sup>b</sup>	74-79	N.D.	2	Facultative, parallel	7
Bhilai, India	N.D.	86	N.D.	1	Facultative	7
Bangkok, Thailand	200-400	83-95	N.D.	24	High rate, parallel	8
Bien Hoa, Viet Nam	600	62	N.D.	N.D.	Facultative - shallow	9

TABLE VIII.1.8--Continued

Location	Loading (lb. BOD /Acre/Day	BOD Removal (%)	Coliform Removal (%)	No. of Lagoons	Remarks	Source
Africa Mandarellas, Southern Rhodesia	282 <sup>a</sup>	74-88	N.D.	6	Facultative, series	10

SOURCES: Table formulation, Diaz, 1975.

1. Saenz (1969)
2. Talboys (1971)
3. Eckley, Canter, and Reid (1974)
4. Canter (1969)
5. Purushotaman (1970)
6. Jayangouadar et al. (1970)
7. Dave and Jain (1966)
8. McGarry (1970)
9. Duttweiler and Burgh (1969)
10. Hodgson (1964)

<sup>a</sup>Primary ponds.

<sup>b</sup>Secondary ponds.

<sup>c</sup>Entire system.

removals of coliform bacteria are obtained in ponds working in series.

Eckley, Canter, and Reid (1974) presented performance equations for a pond system that had been working in the Canal Zone, Panama, for five years. The data collected during that period of time was subjected to multiple regression analyses. The following performance equations were derived for a three-pond system (anaerobic-facultative-polishing):

$$\begin{aligned} \% \text{ BOD removal} = & 14.469 + 27.244 \frac{(P-E)}{P} + 73.942 \frac{(I-E)}{I} + 0.071 \text{ BOD}_L - \\ & 0.160 N_L - 0.149 P_L + 0.927 \text{ COD}_L \end{aligned}$$

$$\begin{aligned} \% \text{ E. coli removal} = & -85.264 + 122.170 \frac{(P-E)}{P} + 194.613 \frac{(I-E)}{I} + 0.969 N_L \\ & - 0.586 P_L - 0.069 \text{ COD}_L \end{aligned}$$

$$\% \text{ N removal} = 11.466 + 87.464 \frac{(I-E)}{I} + 0.272 P_L - 26.979 \frac{(P-E)}{P} + 0.036 \text{ COD}_L$$

$$\% \text{ P removal} = -293.396 + 4.921 P_L + 326.894 \frac{(I-E)}{I} - 2.962 N_L + 0.229 \text{ COD}_L$$

where:  $\text{BOD}_L$  = Biochemical Oxygen Demand Loading (lb./acre/day)

$\text{COD}_L$  = Chemical Oxygen Demand Loading (lb./acre/day)

$N_L$  = Organic Nitrogen and Ammonia Loading (lb./acre/day)

$P_L$  = Orthophosphates Loading (lb./acre/day)

$\frac{I-E}{I}$  = (Influent Flow - Effluent Flow)/Influent Flow

$\frac{P-E}{P}$  = (Precipitation - Evaporation)/Precipitation

N = Organic Nitrogen and Ammonia

P = Orthophosphates.

Sludge Accumulation in Ponds. During the first years of operation of a facultative pond, deposition of sludge occurs at a faster rate than it is removed by fermentation. With time (two to twenty years), an equilibrium is reached where the rate of deposition equals the rate of fermentation (Marais, 1970). After equilibrium is reached, sludge accumulation in ponds treating primary and secondary effluents of domestic wastes is practically negligible (Stander et al., 1973). However, in tropical areas where high BOD surface loadings are utilized and water consumption per capita is low, sludge accumulation may become significant if lagoons are not properly designed (Gloyna, 1971).

Eckley, Canter, and Reid (1974) reported four inches of sludge accumulation in a pond loaded with 200 lb. BOD/acre/day after two years of operation in the Canal Zone, Panama. In the same location, another study was made with a small experimental pond with loadings between 5,000 and 11,000 lb. BOD/acre/day. After six months of operation, sludge build-up was only twelve inches. The relatively small accumulation of sludge was probably the result of high temperatures in the area and the consequent high rates of fermentation and methane production. Cubillos (1970) reported 6.6 inches of sludge accumulation after two years of operation in a pond with loadings ranging from 70 to 407 lb. BOD/acre/day in Palmira, Colombia. Hodgson (1964) reported 4.4 inches of sludge accumulation in a pond at Mandarellas, Southern Rhodesia, after fourteen months of operation with loadings ranging between 127 and 182 lb. BOD/acre/day. According to Callaway and Wagner (1966), in properly designed lagoons the high rates of fermentation and methane production in tropical areas made de-sludging of lagoons unnecessary until after eight to sixteen years of operation.

Costs of Wastewater Treatment in Developing Countries (Ponds, Aerated Lagoons, and Activated Sludge Systems). The cost of construction and operation of waste stabilization ponds is lower than for any mechanical wastewater treatment plants, provided that land costs are not prohibitive (Gloyna, 1971). Stabilization ponds are especially economical for small communities in rural areas (Callaway and Wagner, 1966). Table VIII.1.9 summarizes a comparison of capital costs and operation and maintenance costs for stabilization ponds in the United States, India, and Brazil (Reid, 1974). India's costs can be considered applicable to other Asian as well as African developing countries, and Brazilian costs can be extrapolated to other Latin American countries.

A wastewater treatment system including an aerated lagoon with a six-day detention time followed by a second lagoon with a two-day detention time to remove excess suspended solids also was considered. The per capita costs of construction are shown in Table VIII.1.9. These costs range from \$6 per capita for a system serving 50,000 people up to \$7.40 per capita in a system serving 5,000 people. These costs are based on construction costs similar to those for waste stabilization ponds including the excavation, landscape, parshall flume, inlet and outlet structure, etc. as well as a cost of approximately \$400 per installed horsepower of aeration equipment. Fixed mounted surface aerators are included in the aerated lagoon design. The per capita capital costs of the aerated lagoon systems are approximately half those for stabilization ponds to serve populations of 5,000 to 10,000, and approximately 2/3 the cost per capita for ponds serving a population between 25,000 and 50,000 people; however,

TABLE VIII.1.9  
WASTE STABILIZATION POND COSTS  
FOR THE UNITED STATES, INDIA, AND BRAZIL

Population	United States of America <sup>1</sup>		India <sup>2</sup>		Brazil <sup>3</sup>
	Construction <sup>4</sup> (\$/Capita)	Operation & Maintenance (\$/Year/Capita)	Construction <sup>4</sup> (\$/Capita)	Operation & Maintenance (\$/Year/Capita)	Capital <sup>5</sup> (\$/Capita)
5,000	16.56	0.50	2.09	0.32	14.50 (7.40) <sup>6</sup>
10,000	10.89	0.39	1.84	0.25	12.50 (6.60)
25,000	-	-	-	-	10.50 (6.40)
50,000	4.11	0.20	1.29	0.17	9.00 (6.00)
100,000	2.70	0.14	1.25	0.14	-
200,000	1.78	0.11	1.17	0.12	-

SOURCES: <sup>1</sup>Smith and Eiler, Cost to Consumer for Collection and Treatment of Waste Water. (United States Environmental Protection Agency, July 1970);

<sup>2</sup>Low Cost Waste Treatment (Nagpur, India: Central Public Health Engineering Research Institute, 1972);

<sup>3</sup>Correspondence to J. Malina from E. Jordao, Rio de Janeiro.

<sup>4</sup>Land costs are excluded.

<sup>5</sup>Cost includes excavation, parshall flume, inlet and outlet structures, but does not include cost of land.

<sup>6</sup>Numbers in parentheses represent aerated lagoon capital costs.



the operating costs would be considerably higher. This increased cost results from the electrical requirements to operate the surface aerators. If a relatively low cost of electricity is available, for example, hydroelectric power, these operating costs could be minimal. In fact, in Brazil where most of the electrical energy is generated by hydroelectric power plants, aerated lagoons do offer a reasonable alternative to waste stabilization ponds. The mechanical surface aerators can also be replaced by static aeration devices which require compressed air. This type of aeration system would minimize maintenance. A direct-drive blower could be used to provide the compressed air, and the need for electricity would be minimized.

The cost of land as well as the availability of land would also affect the type of waste treatment facility that should be installed in developing countries. The data presented in Table VIII.1.10 indicate that the land requirements for waste stabilization ponds, aerated lagoons, and activated sludge systems are not markedly different for a plant with a capacity of one million gallons/day (MGD) which is equivalent to a plant serving 10,000 people. The land requirements range from ten to eighteen acres for a one MGD facility. However, as the capacity of the treatment facility approaches ten MGD (serving approximately 100,000 people), the land requirements for waste stabilization ponds are approximately four times the requirements for an aerated lagoon system, and nine times the land requirements for an activated sludge plant.

The land requirements for treating wastewater in stabilization ponds increase rapidly as the capacity of the plant increases, so that the requirements to treat 100 MGD of wastewater (serving

TABLE VIII.1.10  
LAND REQUIREMENTS OF WASTEWATER TREATMENT FACILITIES

Capacity (MGD)	Population	Acres (Ponds <sup>a</sup> )	Acres (Aerated Lagoons <sup>b</sup> )	Acres (Activated Sludge <sup>c</sup> )
1	10,000	18	15	10
10	100,000	180	50	20
25	250,000	450	90	35
50	500,000	900	125	45
100	1,000,000	1,800	250	70

<sup>a</sup>Based on  $V = (3.5 \times 10^{-5})NqL_a\theta^{(35 - T_m)}$  and depth = 2 meters.

<sup>b</sup>Based on 6-day detention time.

<sup>c</sup>EPA estimates.

approximately 1,000,000 people) is 1800 acres for waste stabilization ponds compared to only 70 acres for an activated sludge system. In some of the large urban-industrial metropolitan areas in developing countries, land may not be available at a sufficiently reasonable cost to rely on waste stabilization ponds as a means of providing adequate treatment of municipal wastewaters. Therefore, it may be necessary to install a waste treatment facility which includes screening, grit removal, primary sedimentation, an activated sludge system, and anaerobic digestion of the sludge. In such a system, the sludges can be handled by the anaerobic digestion, and the methane gas produced can be recovered and used to provide some of the energy required to operate the plant.

The capital and operating costs for wastewater treatment using activated sludge for biological treatment and anaerobic digestion and energy recovery is presented in Table VIII.1.11. By adding energy recovery by anaerobic digestion the cost is approximately doubled. However, as the size of the plant increases, the capital costs of the activated sludge system become more competitive with waste stabilization ponds, especially in areas where the cost of land is high. Therefore, the various alternatives should be evaluated in terms of land availability, costs of land, and ease of expansion of the system to meet future population requirements.

Energy requirements for wastewater treatment represent another decision factor for treatment process selection. Some energy can be obtained from digester gas in an activated sludge plant. For example, a schematic diagram of an anaerobic digestion system with power and heat recovery using dual fuel engines is shown in Figure VIII.1.2.

TABLE VIII.1.1.11  
 CAPITAL AND OPERATING COST FOR  
 WASTEWATER TREATMENT PLANT USING ACTIVATED SLUDGE FOR  
 BIOLOGICAL TREATMENT AND ANAEROBIC DIGESTION AND ENERGY RECOVERY  
 (1975 DOLLARS)

Capacity (MGD)	Population Served	Capital Cost		Operating Cost	
		Biological Waste- water Treatment (\$/Capita)	Sludge Digestion and Energy Recovery (\$/Capita)	Chemicals, Labor, etc. (\$/Cap/yr)	Sludge Handling and Electrical (\$/Cap/yr)
1	10,000	\$53.70	\$48.93	\$3.35	\$1.52
10	100,000	21.43	10.79	0.96	0.32
25	250,000	17.58	7.30	0.70	0.27
50	500,000	15.78	6.58	0.56	0.24
100	1,000,000	14.22	6.18	0.46	0.22

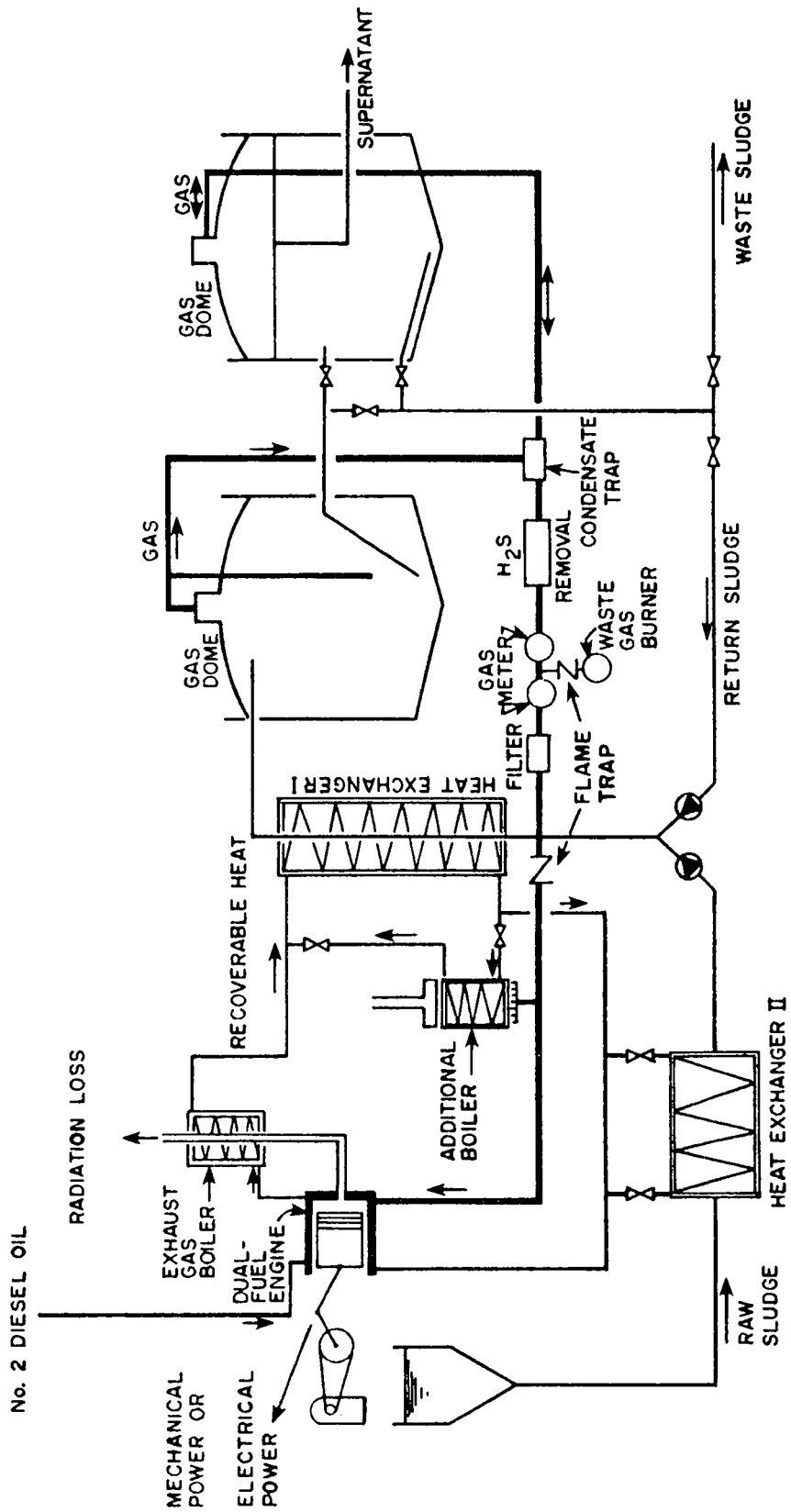

Fig. VIII.1.1.2. Schematic of power and heat generation with dual-fuel engines.

The gas produced during anaerobic digestion contains approximately 600-700 BTU per cubic foot. However, to use the gas in a dual fuel engine, the hydrogen sulfide must be removed. Hydrogen sulfide is generally removed using iron oxide mixed with wood shavings. The dual fuel engine uses the methane gas with some auxiliary diesel oil, and the mechanical energy generated can be used to drive the blowers required to aerate the activated sludge system. The cooling water from the engine is used in a heat exchanger to heat the sludge entering the digestion system. Any excess gas beyond that required to drive the blowers is converted to electrical energy by means of a dual fuel engine and an electrical generating set. This electrical energy is used throughout the treatment plant to operate pumps and meet other electrical needs.

The energy requirements to treat municipal wastewater at activated sludge plants with capacities ranging from one MGD up to 100 MGD are shown in Table VIII.1.12. Energy balances for municipal waste treatment plants with energy recovery and utilization are shown in Table VIII.1.13 for plant capacities of 1, 10, 25, 50, and 100 MGD. The total energy requirements are separated into energy required by the diffused air system and other energy requirements in the plant. The energy available from the digested gas also is tabulated along with the requirements for pilot oil which is essential to the operation of the dual fuel engine. The conversion factors for reducing all the energy requirements to BTU's per day are also included in the table. The energy balance indicates that the amount of gas produced at the plant treating one MGD of wastewater (serving 10,000 people) is not sufficient to meet all the energy requirements for the

TABLE VIII.1.12

ELECTRICAL ENERGY REQUIREMENTS FOR  
UNIT PROCESSES AND OPERATIONS IN AN  
ACTIVATED SLUDGE PLANT  
(KILOWATT-HOURS/DAY)

Treatment Unit	Plant Size (MGD)				
	1	10	25	50	100
Preliminary Treatment					
Bar Screens	2	2	3	6	11
Comminutors	16	61	92	142	204
Grit Removal	2	4	9	17	34
Influent Pumping (30 Feet Total Head)	153	1,451	3,233	6,467	12,933
Primary Sedimentation (800 gpd/ft <sup>2</sup> )	31	122	224	347	734
Activated Sludge Process					
Diffused Air	553	5,324	13,310	26,620	53,240
Recirculation Pumping (50%, 17.5 ft.)	45	423	943	1,886	3,772
Final Sedimentation (800 gpd/ft <sup>2</sup> )	31	122	224	347	734
Chlorination	1	1	67	134	267
Lights & Miscellaneous Power	57	210	450	950	2,400
Sludge Treatment					
Sludge Pumping	2	21	51	102	204
Gravity Thickeners	11	21	21	21	41
Anaerobic Digesters					
Mixing	84	212	334	448	673
Heating	23	68	119	180	324
Compressors (Gas Storage)	17	168	420	841	1,683
<b>Total</b>	<b>1,008</b>	<b>8,210</b>	<b>19,500</b>	<b>38,508</b>	<b>77,254</b>

TABLE VIII.1.13  
 ENERGY BALANCE FOR MUNICIPAL WASTEWATER  
 TREATMENT PLANT WITH ENERGY RECOVERY AND UTILIZATION

Plant Capacity (MGD)	Population Served	Diffused Air System Requirements <sup>a</sup> (BTU x 10 <sup>6</sup> /Day)	Other Requirements <sup>b</sup> (BTU x 10 <sup>6</sup> /Day)	Energy Available from Digester Gas (BTU x 10 <sup>6</sup> /Day)	Deficit or Surplus (BTU x 10 <sup>6</sup> /Day)	Pilot Oil Required (gal/day)
1	10,000	3.98	4.37	6.8	(-1.55)	7.1
10	100,000	39.78	26.55	68	(+1.67)	56.1
25	250,000	99.44	56.95	170	(+13.61)	132.1
50	500,000	198.88	109.37	340	(+31.75)	260.4
100	1,000,000	397.76	220.93	680	(+61.31)	523.0

<sup>a</sup>Direct drive blowers. One BHp-Hr (British horsepower-hour) = 6350 BTU.

<sup>b</sup>Other electrical generation. One Kw-hr (kilowatt-hour) = 9200 BTU.

<sup>c</sup>Number two diesel oil. One gallon = 140,000 BTU.



wastewater treatment plant. However, even at this plant size, sufficient digester gas is generated to drive the blowers required for aeration of the activated sludge system and to generate a considerable portion of the other electrical energy requirements. The amount of energy available in the digester gas produced at a treatment plant with a capacity of ten MGD or greater is sufficient to meet all the energy requirements of the municipal wastewater treatment plant. In fact, the amount of gas produced contains more energy than is required to drive the diffused air blowers and meet other electrical requirements. The amount of excess energy increases as the plant capacity increases. However, it should be pointed out that the energy available in the gas produced by anaerobic digestion of municipal wastewaters would provide only a small fraction of the energy used by most major metropolitan areas. However, this energy may be made available to the population in the immediate vicinity of the plant either in the form of heat for space heating or as electricity during hours of peak usage.

Therefore, although waste stabilization ponds provide a relatively low cost treatment alternative for pollution abatement in developing countries, the availability of land and the cost of land may increase the capital cost of waste stabilization ponds to such a level that other wastewater treatment systems are in fact more economical. In large urban areas, the activated sludge system will provide high efficiency treatment of the wastewater, and the sludges generated during treatment can be stabilized by anaerobic digestion and the gases produced can be recovered and utilized to meet the energy demands of the treatment plant.

## ALTERNATIVE DISPOSAL METHODS

The paragraphs which follow contain brief descriptions of two additional wastewater disposal methods which would be of interest in developing countries.

Fish Production. Interest in the United States in the use of fish as collecting devices in tertiary lagoons was primarily due to the federal effluent requirements of 30 mg/l suspended solids set by the Environmental Protection Agency (EPA). This requirement made obsolete many of the single pass lagoons used in small cities and towns, and aquaculture provided one possible solution to this problem. The primary impetus in developing countries for using fish in sewage lagoons is food production, and the rules of fish culture where production of the greatest amounts of fish is the goal, are not the same as the rules for removal of the greatest amount of contaminants. Unfortunately, one cannot optimize simultaneously both fish production and nutrient removal.

Prof. Hoser at the University of Munich observed the following difficulties in the use of fish in sewage ponds: (1) maintenance of a sufficiently high oxygen concentration by keeping the sewage fresh, and avoiding sludge deposits, and destroying surface growths (to maintain 3 ppm dissolved oxygen, sprays and narrow sluices have been used at various installations); (2) elimination of toxic substances and conditions, such as ammonia, sulfides, improper pH or water temperatures; and (3) the maintenance of a biological balance that would yield adequate quantities of fish food.

As practiced in central Europe, the dilutions of two to five volumes of clean water were employed for settled sewage and the ponds were from 1 to 2½ feet deep with a loading of 800 to 1,000 people per surface acre of pond (Imhoff had suggested 800 people/acre). Ducks kept the ponds clear of undesirable weeds, and one acre of pond was said to produce from 400 to 500 pounds of fish and from 200 to 250 pounds of duck meat. The ponds were drained and cleaned during the winter when ice conditions and retarded aquatic life interfered with fish raising, and this necessitated disposal by other means at this time. In some instances, special hibernating basins were provided for the animal and plant pond life, and the ponds were filled again in the spring.

Carpenter, Coleman, and Jarman at the Oklahoma State Health Department and Spear at the University of Oklahoma conducted research on fish production in sewage lagoons (5,7,15). Data associated with this research shows that Oklahoma City had cultured successfully such species as carp, goldfish, fathead minnow, golden shiner, black bullhead, channel catfish, mosquito fish, bluegill, green sunfish, largemouth bass, and Tilapia nilotrica. The Quail Creek sewage plant located in the Oklahoma City metropolitan area consisted of a six-cell series lagoon with a Hinde Air-Aqua spray in the first two cells. Each cell was six acres in area with a depth of five feet. Catfish were placed in the third and fourth cells, golden shiners in the fifth and sixth cells, and fathead minnow and Tilapia in the third cell. The mean value of weekly analyses from June to October showed a BOD<sub>5</sub> removal of 95%. There

was 94% removal of suspended solids with an effluent concentration of twelve mg/l. The nitrogen to phosphorous ratio was reduced from 2/1 in the influent to about 1/1 in the effluent. The fecal coliform bacteria was reduced from  $3 \times 10^6$  to twenty (Most Probable Number/100 ml), and in the first cell the ammonia concentration was reduced from twelve mg/l to one mg/l. Spear was not so successful using buffalo fish under wintertime conditions (15).

Studies on the use of Tilapia in sewage ponds in Oklahoma reported an increase of from 1,500 to 4,300 pounds/acre in 191 days. Similarly, catfish increased by 600 to 4,400 pounds/acre and shiners from 85 to 536 pounds/acre, in a four month period (7,15). These appear to be representative numbers when waste disposal is the primary objective. By contrast, in intensive fish production, Tilapia will increase by four to five times as much when fed grain in the amount of three percent of body weight/day as when fed on algae, and by twenty to forty times as much in the same time period, as when fed on sewage effluent. However, if fish production is the goal, one still has an effluent to be dispersed (13). Productivity also depends on what is grown. Selection must be made of the best species and combinations of fish and other waterlife such as bass/Tilapia, salmon/amphid, or Tilapia/bass/crayfish; of whether to breed or fatten using fish or fingerlings.

Vascular aquatic plants including water hyacinth are also candidates for mineral nutrient removal (1,3). Rush ponds are used some places in Holland instead of activated sludge units. The production of plants can be used as ruminant feed or for methane production, whereas fish production can be used for animal feed and fertilizer.

It was estimated in Oklahoma that the net income from fish was about 2 ½¢/1,000 gallons of sewage treated (7).

There are potential health problems associated with fish grown in wastewaters and it has been recommended in Europe that such fish be removed to fresh water two to three weeks prior to sale. Salmonella, polioviruses, Coxsackie viruses, shigella, cholera vibrios, and enteropathogenic viral hepatitis, have all been implicated in fish and shell fish (4,6).

Oxidation ditch. The device called the oxidation ditch or dutch ditch utilizes a brush type aerator for extended aeration. The water circulates in a ditch or tank in circular fashion. See Figure VIII.1.3. This system may find application in the case of large, extended aeration, activated sludge plants. The unit is well adapted to small communities particularly where a shallow depth is desired. However, the aerator unit which is manufactured in Europe or in the United States is expensive, costing from three to four times as much as the floating conventional pumping aerators, whereas Thailand has manufactured aerator-rotors costing approximately one-tenth as much as the European or American units. This is an excellent example of the transfer of an appropriate technology to a developing country. In order to avoid the expense associated with the brush aerator Pasveer in the Netherlands developed the modification called the carousel in which a deeper sump is incorporated at one place in the ditch and a conventional mechanical floating aerator is used instead of a brush aerator. Another type of aeration unit called the INKA has been reported in use with the oxidation ditch. With this unit, large volumes of air are released at low submergence heads, and the location of the unit has little effect on the oxygen transfer characteristics.

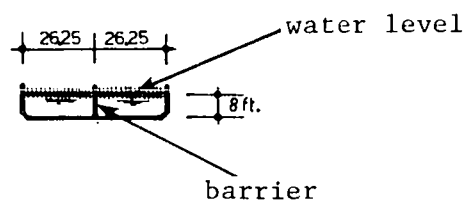
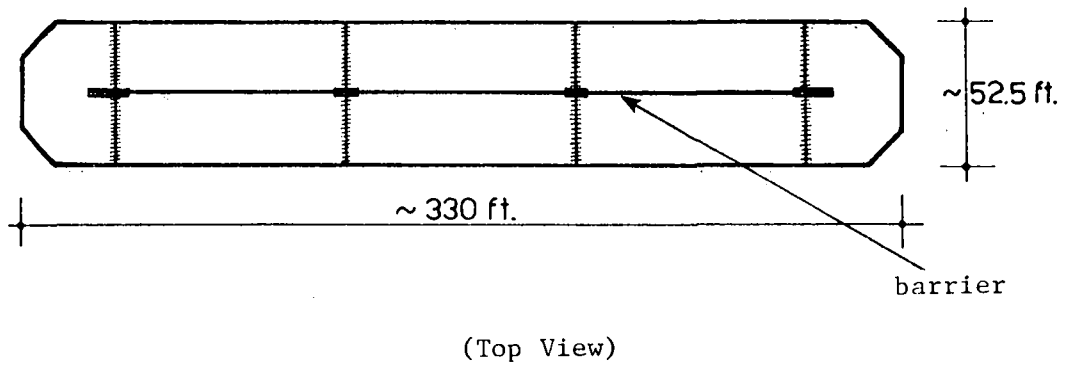

Fig. VIII.1.3. Basic oxidation ditch design.

## VIII.2.

## AERATED LAGOONS

Kung-cheh George Li

## INTRODUCTION

An aerated lagoon is a basin of significant depth (eight to twelve feet) in which wastewater is treated on a flow-through basis. Oxygen is usually supplied either by means of surface aerators or air diffuser units to maintain a minimum dissolved oxygen content of one mg/l in the basin. Because aerated lagoons are cheaper in terms of capital and maintenance costs in comparison to most conventional biological waste treatment methods, they can be classified as one of the lower cost waste treatment methods suitable for consideration in developing countries.

ADVANTAGES OF AERATED LAGOONS  
IN DEVELOPING COUNTRIES

1. When compared with stabilization ponds, aerated lagoons have the ability to handle higher loadings with a shorter detention time in a reduced area and with greater lagoon depth. The land area required for an aerated lagoon is commonly one-tenth to one-eighth of that required for a stabilization pond.

2. Unlike stabilization ponds, aerated lagoons do not depend on algae for their oxygen source; therefore, they can continue to function

without regard to the amount of available sunlight. In temperate climates it has been found that during winter the algae in waste stabilization ponds do not produce enough oxygen to satisfy the bacterial demand for it.

3. Generally, primary settling, sludge settling, sludge recirculation or sludge drying are not necessary for aerated lagoons.

4. The maintenance required for aerated lagoons is not complex. They do not need the type of biological operation control which is necessary for a conventional biological waste treatment process.

5. The surface aerators which are most commonly used as aeration equipment in aerated lagoons can be easily manufactured locally.

6. The aerated lagoon can be constructed easily using earthwork, and the surface aerators used can be readily obtained by ordering the correct size and number of aerator units to suit the design of the lagoon on a "do-it-yourself" basis. This factor makes it a treatment process which is quite suitable for most developing country situations.

7. With regard to annual cost, the aerated lagoon lies somewhere between the waste stabilization pond on one hand and the oxidation ditch and conventional treatment methods on the other. Because of this the aerated lagoon is believed to represent one of the best compromise treatment methods for developing countries (1,6).

#### BASIC CONSIDERATIONS

Two types of aerated lagoons can be considered: the aerobic lagoon and the aerobic--anaerobic lagoon (4).

In an aerobic lagoon, all the solids are in suspension so that the concentration of effluent suspended solids will be equal to the



concentration of solids in the basin. Generally, separate sludge settling and disposal facilities are required. The system will be similar to the activated sludge process, and the BOD removal efficiency can be as high as seventy to ninety percent.

In an aerobic - anaerobic lagoon, the turbulence level maintained insures uniform distribution of oxygen throughout the basin but is usually insufficient to maintain all the solids in suspension. As a result, a certain amount of solids deposit on the bottom and undergo anaerobic decomposition. Because the deposited solids undergo anaerobic decomposition, the net sludge accumulation is not too much. The sludge needs to be moved out only periodically. Generally a BOD removal efficiency of seventy to ninety percent can again be attained, but the effluent may contain relatively high concentrations of suspended solids which make the effluent have a slightly turbid appearance. The lagoon can be followed by a settling basin or a shallow pond if desired, and this will assist further in the removal of solids and BOD. A typical aerated lagoon is shown in Figure VIII.2.1.

#### PROCESS DESIGN CONSIDERATIONS

The main considerations in the design of aerated lagoons include (1) detention time, (2) lagoon temperature and its effects (3) oxygen demand and supply, (4) oxygen transfer and aerator performance, and (5) energy requirements for mixing.

1. Detention time. Assuming the aerated lagoon system to be completely mixed, at steady-state, and the biological reaction to be a first-order reaction, the common relationship in the lagoon is described by the following equation:

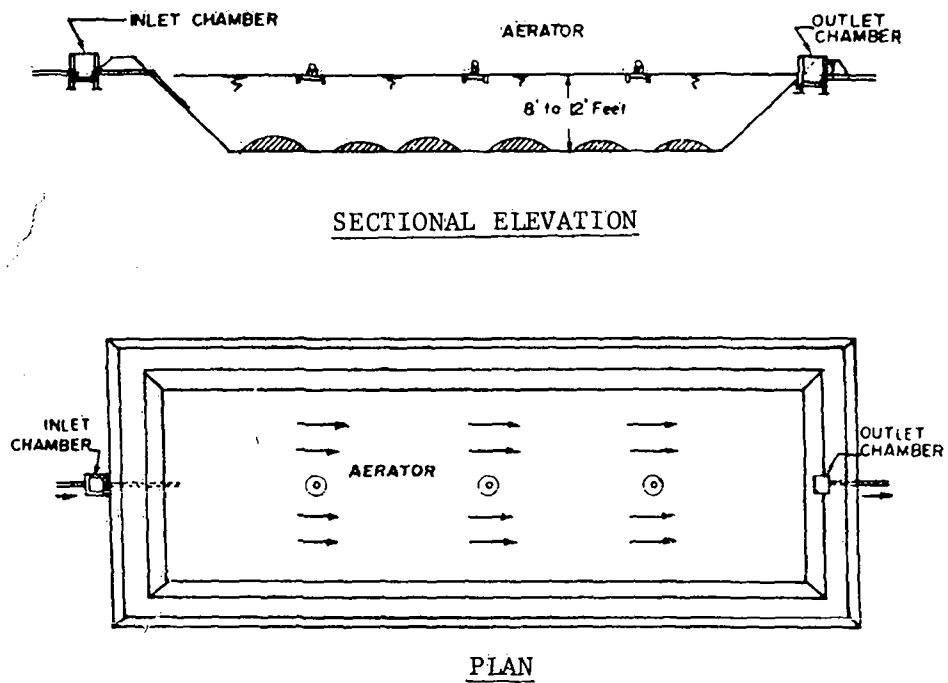

Fig. VIII.2.1. Aerated lagoon.

SOURCE: S. J. Arceivala, S. R. Alagarsamy, and J. S. S. Lakshminarayana, "Design and Construction of Aerated Lagoons in India," Proceedings of a Symposium on Low Cost Waste Treatment (Nagpur, India: CPHERI, 1969).

$$\frac{Le}{Lo} = \frac{1}{1 + Kt}, \quad (8-2-1)$$

where  $Le$  = effluent BOD concentration (mg/l),  
 $Lo$  = influent BOD concentration (mg/l),  
 $K$  = overall first-order BOD removal rate ( $\text{day}^{-1}$ ), and  
 $t$  = detention time (days) (2).

From equation (8-2-1) the detention time and thereby the volume of the lagoon can be determined. The value of  $K$  may be determined from pilot tests or estimated from available data. Reported values of  $K$  have ranged from 0.3 to over 1.0 (2). The detention time commonly ranges from three to five days or more depending upon the characteristics of the wastes (1).

2. Lagoon temperature and its effects. Temperatures in a lagoon may vary considerably between winter and summer conditions, and the temperature variations will exert a profound effect on the rate of BOD removal due to the low solids level maintained in the lagoon (7). The lagoon temperature can be estimated from the general air or ambient temperature, since the lagoon temperature generally follows the air temperature in most areas. The value of the removal rate  $K$  at a temperature other than  $20^{\circ}\text{C}$  can be determined by using the following equation:

$$K_T = K_{20^{\circ}\text{C}} \theta^{(T - 20^{\circ})}, \quad (8-2-2)$$

where  $K_T$  = removal rate at temperature  $T^{\circ}\text{C}$ ,  
 $K_{20^{\circ}\text{C}}$  = removal rate at temperature  $20^{\circ}\text{C}$ ,  
 $T$  = lagoon temperature ( $^{\circ}\text{C}$ ), and  
 $\theta$  = temperature coefficient.

The value of the temperature coefficient  $\theta$  is a function of the

biodegradability of the wastes and commonly lies in a range between 1.035 to 1.075, with 1.035 being the most common value (2).

3. Oxygen demand and supply. Oxygen requirements in an aerated lagoon occur as a result of both assimilative and endogenous respiration. However, since the concentration of microbial suspended solids is generally at a low level (80-200 mg/l VSS, volatile suspended solids), the oxygen requirement can be directly related to the BOD removal as follows:

$$\text{lbs of oxygen required/day} = a \cdot \text{lbs of BOD}_5 \text{ removed/day.}$$

(8-2-3)

The value of the constant (a) depends on the nature of the waste, the mixing level, and the temperature. It can be determined by laboratory or field testing of the wastewater to be treated, or it can be estimated from data on similar wastes elsewhere. Common values range from 1.0 to 1.4 (7).

Oxygen is supplied to the aerated lagoon partly by surface aeration resulting from surface turbulence and wave action and partly by aeration induced with diffuse or surface aerators. It is reasonable to assume that the surface aeration component has been used to compensate for the additional oxygen demand from the benthic oxidation of anaerobic decomposition products (6). Therefore, the total oxygen requirements of the lagoon are considered to be supplied solely by the induced aeration system, and the surface aeration will be neglected.

Diffuser aeration systems which are high in both initial and maintenance costs are not preferred for aerated lagoons. Most systems use surface aerators.

4. Oxygen transfer and aerator performance. The oxygen transferred by the surface aeration units can be computed with the following equation (1):

$$N = N_o \left[ \frac{C_{sw} - C_L}{C_s} (1.02)^{T - 20} \cdot \alpha \right], \quad (8-2-4)$$

- where  $N$  = lbs of oxygen/hp-hr transferred under field conditions,  
 $N_o$  = lbs of oxygen/hp-hr transferred in water at 20°C and zero dissolved oxygen (i.e., under standard conditions),  
 $C_{sw}$  = oxygen saturation concentration in lagoon at T°C (mg/l) (usually 0.90 to 0.98 times the saturation concentration in fresh water at T°C),  
 $C_L$  = dissolved oxygen concentration in the lagoon at T°C (mg/l) (for most practical cases, 2 mg/l or greater (7)),  
 $C_s$  = oxygen saturation concentration in fresh water at 20°C (mg/l) (generally using 9.17 mg/l),  
 $T$  = temperature of lagoon liquid (°C),  
 $\alpha$  = oxygen-transfer correction factor (usually 0.8 to 0.9).

#### POWER REQUIREMENT FOR MIXING

Although it is not necessary to keep all of the solids in suspension in an aerated lagoon, it is imperative to provide sufficient power to ensure a complete mixing of the liquid and to maintain a uniform distribution of oxygen through the basin. Normally, six to ten horsepower per million gallons will accomplish this goal (5). For an aerated lagoon it is extremely important that the mixing power requirement be checked, because in most instances the power needed for mixing will

determine the aerator design selected. If the solids are to be maintained in suspension, a power level of approximately 60 to 100 horsepower per million gallons is required.

#### CONSTRUCTION AND MAINTENANCE

1. Screening or comminuting devices should be provided to prevent the aerator propeller from being fouled by such things as rags and debris. A grit chamber is also recommended, but a primary clarifier is not required.

2. Aerated lagoons are generally built eight to twelve feet deep with earth side slopes appropriate for soil conditions. An embankment slope of 1 in 2 is commonly used. A rectangular shape with a maximum ratio of length to width of 3:1 is also preferred (6).

3. The aerators induce a very high degree of turbulence in the lagoon, so it is necessary to protect the embankment and lagoon bottom from erosion and scouring. This may be achieved by providing a lining of butyl rubber (or similar material), masonry (set with cement or laid as rip-rap) or mass concrete (3). Masonry and concrete are generally avoided due to the large volume involved.

4. Aerated lagoons should be located in relatively impervious soil to prevent percolation and pollution of groundwater.

5. Where fixed surface aerators are used, the water level in the lagoon must be kept constant to ensure the required degree of submergence of the aerators. Recently, floating surface aerators have been favored because fluctuations in water level do not impair their efficiency.

6. Although surface aerators are usually quite reliable in operation, periodic lubrication may be necessary.

## VIII.3.

LAND APPLICATION  
OF WASTEWATER

Sue Lin Lewis

## INTRODUCTION

Land application of wastewater is an old practice. Historically, it has been used predominantly as a convenient and economical approach to wastewater disposal, whereas the current trend is primarily towards wastewater treatment and/or reuse. Land application may be viewed as a recycling system in which the wastewater is spread over the land. The natural topsoils and soil biota provide filtering and stabilization of the organic matter. Nutrients are used by the plants, precipitated out, or adsorbed on the soils. The renovated water, after passing through the soil filter or so-called "living filter," may be collected by a drainage system or used to recharge the natural aquifers, at which point it becomes available for reuse. In regions with limited water resources land application can be operated to boost growth of grass, crops, or forests as well as for wastewater treatment.

There are three basic types of land application systems: irrigation, infiltration-percolation, and overland-flow. The major concerns in the management of land application of wastewater should be based on the following factors: land availability, site location, the climate,

soil and subsurface conditions, hydraulic acceptance, the wastewater characteristics, the capacity and utilization of the plant-soil complex to produce a specific water quality, the intended use or reuse of the wastewater, and the ultimate use of the land. With adequate controls and regulations, land application systems will play a significant role in future wastewater management plans. They offer more than waste treatment, permitting the efficient use of a widely available resource.

#### METHODS OF APPLYING WASTEWATER TO LAND

There are three basic types of land treatment systems as illustrated in Figure VIII.3.1.

- (a) low rate system (irrigation),
- (b) surface runoff system (overland flow),
- (c) high rate system (infiltration-percolation).

Selection of the type of system at a given site is essentially governed by the soil and subsurface conditions, the climate, the drainability of the soil, the availability of land, the geological and topographical conditions of the land, and the intended use or reuse of the wastewater. Comparison of the three types is made in Table VIII.3.1.

For each type of land treatment system, the wastewater may be applied with sprinklers or with surface irrigation techniques (graded or level, borders or furrows). Surface techniques require less energy and complete gravity flow is often possible. Also, surface techniques produce few or no airborne pathogens because of little or no spray in the operations. They require relatively flat land, or at least smooth topographies so that contour techniques can be used where the land is sloping. Sprinkler or spray-type systems are used where the topography



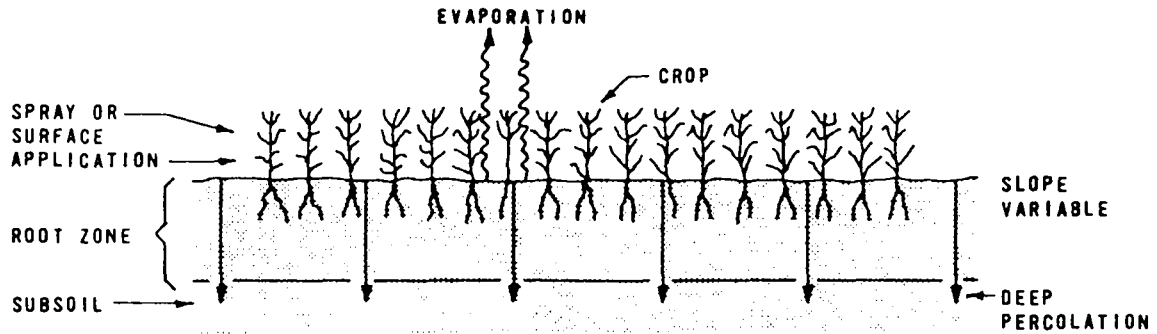

(a) IRRIGATION

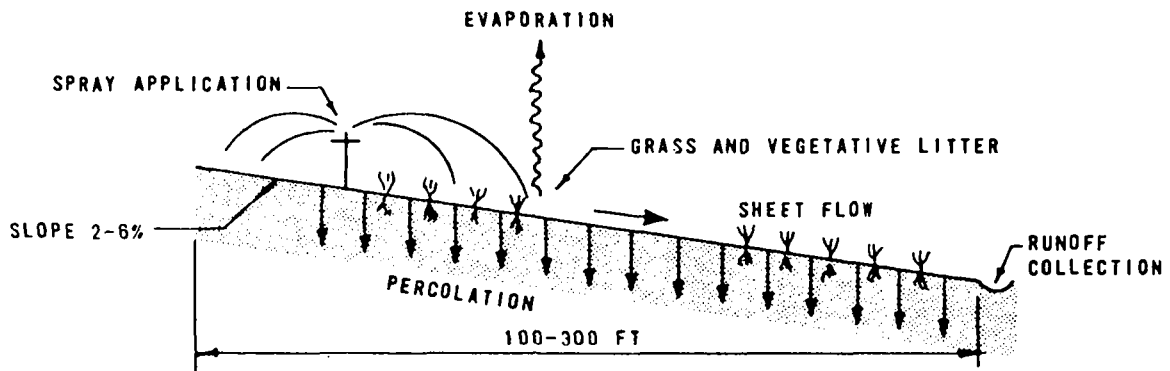

(b) OVERLAND FLOW

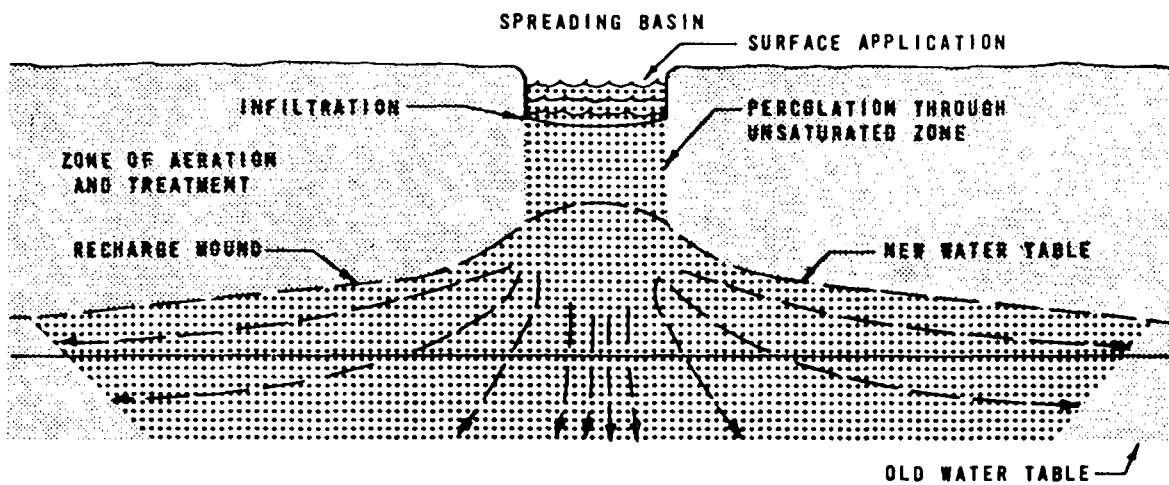

(c) INFILTRATION-PERCOLATION

Fig. VIII.3.1. Three types of land treatment systems.

SOURCE: Charles E. Pound, Ronald W. Crites, Douglas A. Griffes, *Costs of Wastewater Treatment by Land Application*, EPA-430/9-75-003. Washington, D.C.: USEPA, June 1975.

TABLE VIII.3.1

COMPARATIVE CHARACTERISTICS OF  
LAND-APPLICATION APPROACHES

Factor	Type of Approach		
	Irrigation	Overland Flow	Infiltration-Percolation
Liquid-loading rate	0.5 to 4 in/wk	2 to 5.5 in/wk	0.3 to 1.0 ft/wk
Annual application	2 to 8 ft/yr	8 to 24 ft/yr	18 to 500 ft/yr
Land required for 1-MGD flow	62 to 560 acres plus buffer zones	46 to 140 acres plus buffer zones	2 to 62 acres plus buffer zones
Application techniques	Spray or surface	Usually spray	Usually spray
Soils	Moderately permeable soils with good productivity when irrigated	Slowly permeable soils such as clay loams and clay	Rapidly permeable soils such as sands, loamy sands, and sandy loams
Probability of influencing groundwater quality	Moderate	Slight	Certain
Needed depth to groundwater	About 5 ft	Undetermined	About 15 ft
Wastewater losses	Predominantly evaporation or deep percolation	Predominantly surface discharge but some evaporation and percolation	Percolation to groundwater
Conveyance distance, miles <sup>a</sup>	1-10	5	5
Storage period, weeks <sup>a</sup>	1-20	5	1
Land price, \$/acre <sup>a</sup>	1000-4000	2,000	2,000
Crop revenue, \$/acre <sup>a</sup>	150-400	100	--

TABLE VIII.3.1--Continued

Factor	Type of Approach		
	Irrigation	Overland Flow	Infiltration-Percolation
Use as a treatment process with a recovery of treated water	Generally impractical	50 to 60% recovery	Up to 90% recovery
Use for treatment beyond secondary:			
1. For BOD and suspended solids removal	90-99%	90-99%	90-99%
2. For nitrogen removal	85-90%	70-90%	0-80%
3. For phosphorus removal	80-99%	50-60%	70-95%
Use to grow crops for sale	Excellent	Fair	Poor
Use as direct recycle to the land	Complete	Partial	Complete
Use to recharge groundwater	0-30%	0-10%	Up to 90%
Use in cold climates	Fair <sup>b</sup>	-- <sup>c</sup>	Excellent

SOURCE: Land Treatment of Municipal Wastewater Effluents (EPA, Jan. 1946). Alternate Waste Management Technology for Best Practicable Waste Treatment, EPA-430/9-75-013, October 1975.

<sup>a</sup>Wastewater Treatment and Reuse by Land Application. Vol. 1: Summary. Environmental Protection Technology Series (EPA-660/2-73-006 a). Washington, D.C.: USEPA, August 1973.

<sup>b</sup>Conflicting data--woods irrigation acceptable, cropland irrigation marginal.

<sup>c</sup>Insufficient data.

is too irregular for surface irrigation, or where the wastewater should be applied at rates that are less than the infiltration rate of the soil when flooded. Sprinkler systems have higher energy requirements because the water is applied under pressure. They also cause more spray and airborne pathogens which can travel hundreds of meters. For this reason, buffer zones about 50 to 200 feet wide are usually required around spray-type systems.

Low-rate systems. Most land treatment systems are of the low-rate or irrigation type, applying 0.5-4 inches of wastewater every week. About 70 to 140 acres of land are required per 10,000 people. The soil profile and type of cover crop are primary factors controlling nutrient removal and infiltration. Crops generally respond well to irrigation with the treated sewage and similar wastewater, which is essentially a nutrient solution to agriculture. However, caution in the selection of crops for a specific given case to enable long-season or year-around operation of the system is necessary. Most of the nitrogen entering the soil with the treated wastewater can be taken up by the plants. Phosphorus, metals and other elements are also taken up by plants as well as fixed or otherwise immobilized in the soil. In heavy industrialized areas, certain undesired materials can be prevented from entering the sewage system through a suitable industrial source control program. Heavy metals, boron concentrations, and sodium adsorption ratios (SAR) should be closely watched. Excessive boron levels can be reduced by source control, or crops can be selected that are relatively tolerant to high boron levels. (Also, high boron levels will have less effect on crops in clay soils than in sandy soils.)

High SAR can damage the structure of clay soils, but the problem can be corrected by lime applications. Sandy soils are less affected by high SAR than clay soils.

The soil of low-rate land treatment systems should be at least one meter deep and must be sufficiently permeable to accept the wastewater at the desired rate. Land with shallow coarse-textured soil underlaid by fractured or cavernous rock is not suitable because the danger of groundwater pollution in the rock is high. Ideally, the surface soil should be of a silt loam texture with adequate permeability and a minimum depth of three to five feet to groundwater.

Water distribution is by fixed or moving sprinkling systems, or surface spreading. Fixed nozzles are attached to risers from either surface or buried pipe networks. The most popular moving sprinkling system is a center-pivot spray boom. On flat land surface irrigation may be applied by the ridge-and-furrow method or the border-strip method of irrigation. There are several types of irrigation:

1. spray irrigation--water from nozzles wets the land like rain. Usually this method is employed for industrial wastes.
2. surface irrigation--on sloping land wastewater flows over the soil from ditches or pipes with side outlets.
3. flood irrigation--areas surrounded by earthen embankments are flooded to a depth of a foot or two with wastewater which seeps into the soil. The purified wastewater is collected beneath the surface.

The portion of the water not used by the plants seeps down through the root zone and eventually into the underlying groundwater. For humid regions, this deep percolation water can be expected to be of

relatively good quality due to low evapotranspiration rates and dilution with rainwater, and adds to the useful groundwater supply. In arid regions, however, the deep percolation water will often have too high a salt content (3,000 mg/liter or more) to permit profitable reuse of this water. Whether such a condition will prevail in any given case depends upon many factors, including:

- (a) the dissolved solids concentration of the applied irrigation water;
- (b) the amount of irrigation water applied relative to the evapotranspiration;
- (c) the leachability of salts previously accumulated in the soils of the area to be irrigated;
- (d) the amount of infiltrating precipitation for diluting the dissolved solids concentration;
- (e) the particular type of reuse of the percolated water which is contemplated.

Therefore, any deep percolation from irrigated fields in dry climates, should be removed by drains or wells and disposed of in drainage ways, salt lakes, evaporation basins, or other surface water if the quality is not acceptable for reuse.

In cold climates, storage of the winter flow may be required to avoid spraying on frozen ground and/or when crops are dormant and nutrient uptake is minimal. Low-rate systems should not receive more wastewater than their designed rate, mainly because of the danger of nitrate pollution of the underlying groundwater. Thus, soils and crops for low-rate systems must be carefully selected in order to avoid disappointment. If higher application rates are desired, the system should be

designed and managed to promote removal of nitrogen by denitrification rather than by crop uptake.

High-rate systems. High-rate systems are used where the function of the land treatment system is primary that of a tertiary treatment plant, producing reclaimed or renovated water for reuse. They are also used where land is not available for low-rate systems. Application rates in this process are of the order of 10 to 120 inches per week, depending on the soil, the climate, and the wastewater characteristics. The land requirements for high-rate systems are only a small fraction of those for low-rate systems (At an application rate of 6.6 feet per week, for example, about 3.5 acres are required per 10,000 people). However, high-rate systems require deep, rapidly permeable soils, such as sands and sandy loams, and a water table that does not rise to field surface during application of wastewater and drains rapidly to a depth of at least three feet during drying or resting periods.

The typical year-round operating cycle in high-rate systems is two weeks of flooding followed by ten days drying in summer and twenty days drying in winter. Drying or resting periods are necessary to bring oxygen into the soil and to restore infiltration rates. Drying cycles also interrupt the life cycles of some small flying insects (Chironomidae midges) that breed in ponded water, thereby preventing a nuisance in the surrounding community.

The majority of water renovation occurs by physical, chemical, and biological mechanisms in the soil matrix, with vegetation playing a relatively minor role. Crops are usually not grown in high-rate infiltration basins. While a grass cover helps to remove suspended

solids and organic matter, only small portions of nutrient salts are photosynthesized. Multivalent ions appear to be extracted rather easily, while monovalent species tend to be flushed down through the soil mantle. For arid regions, high-rate systems are the only type of land treatment that can yield renovated water with a salt content that is not much higher than that of the original wastewater. At high loading rates, the soil filtration process still yields complete removal of biochemical oxygen demand, suspended solids, and pathogenic bacteria, as with low-rate systems. However, there is a significant risk of carrying pathogenic viruses to underground water. The removal of nitrogen and phosphorus requires special attention because of the high-hydraulic loading rates. Much more nitrogen, phosphorus, metals and other materials enter the soil than is the case in a low-rate system and there are usually no crops with this method which would otherwise remove some of those elements.

Nitrogen removal is accomplished by stimulating denitrification in the soil. This is an anaerobic, microbiological process in which denitrifying bacteria use the oxygen of nitrates as a hydrogen acceptor in their metabolism, thereby producing nitrogen gas which returns to the atmosphere, and oxides. For secondary sewage effluent, most of the nitrogen usually is in the ammonium form. Ammonium ions in the percolate are absorbed through a cation-exchange process in the soil until saturation. Then further amounts of ammonia are carried into the groundwater. During the drying period, complexed ammonium ions are converted to nitrate under aerobic soil conditions. Anaerobiosis, from reflooding with water, results in a portion of the nitrate's



being converted to nitrogen gas. When sewage effluent application is resumed, low infiltration rates should be maintained for the first two or three days to prevent rapid leaching of the remaining nitrate. This will promote additional denitrification and can result in fifty to eighty percent removal of nitrogen.

Soils differ as to their ability to immobilize and store phosphorus. Soils with a high pH can effectively remove apatites from wastewater in a high-rate system. The same is true for soils with a low pH that contain relatively large amounts of iron and aluminum oxides. In clean sand with a low pH, phosphates are relatively mobile and may show up in the deep percolation water. If this is objectionable, phosphates should be precipitated prior to infiltration or after the water is withdrawn for some specific use. Drains or wells may have to be used to prevent high water table interference, to collect the renovated water for reuse, and to protect native groundwater supplies.

Overland-flow systems. Where soils are so fine and impermeable that infiltration rates are too slow even for low rate systems, overland-flow systems can be used. This method results in surface drainage that must be collected for reuse or discharged to a surface watercourse. Waste is applied by sprinklers to the upper end of terraces that are 200-300 feet in length and on grades of about two to six percent. The wastewater then flows in a shallow sheet over the vegetated surface (usually grass) and runs off the lower end of the plot. The plots are designed to be steep enough to produce a relatively shallow sheet of water, and flat enough to avoid erosion and resulting channeling and short circuiting. Water should be applied at rates of two to five inches

per week. Renovation is achieved by filtration and bacterial decomposition as the water moves slowly through the grass cover. Effluent BOD and suspended solids are less than twenty mg/l all year round. Phosphorus removal is about fifty to sixty percent, while the nitrogen removal efficiency of ninety percent during the summer drops substantially in the winter. Detention times are too short for complete removal of bacteria and viruses. This surface flow process is very dependent on weather, and only in mild climates can the runoff at the end of these plots meet present effluent standards for the entire year.

Two major restrictions to the overland runoff system are difficulty in maintaining consistent quality in the renovated water and site-preparation costs. Even in suitable regions it is difficult to predict the degree of renovation possible by a spray-runoff system without conducting pilot-plant studies.

Combination systems. In some cases, certain combinations of low-rate, high-rate, and overland-flow systems may give the best solution. In cold climates, for example, high-rate systems might be used during winter months to avoid expensive storage reservoirs, while low-rate systems might then be used in the summer to maximize irrigation and fertilizer benefits from the wastewater. Where suspended solids are high and effluent quality is poor in general, an overland-flow system might be used as a pretreatment for a high-rate system. Also, it might be possible in areas with high water tables to renovate water with low-rate or high-rate systems, collect renovated water with horizontal drains, and then use it for groundwater recharge of deep aquifers with injection wells.

## GENERAL CONSIDERATIONS AND DESIGN CRITERIA

Land disposal is a potential technique for wastewater treatment and/or reuse where an available site has suitable soil conditions and groundwater hydrology and the climate is favorable. The general design considerations are included in Table VIII.3.2, and site selection factors and criteria for effluent irrigation are given in Table VIII.3.3. Liquid loading rates for various soil types are given in Figure VIII.3.2. If wastewater is properly applied to land, the soil actually removes pollutants and renders the water cleaner. High quality water is thus generated from wastewater. However, poor design and mismanagement, particularly overloading of wastewater, can result in health risks, nuisance factors, underground water contamination, and the potential toxicity of metals buildup in the soils and changes in soil structure. The success or failure of the process is primarily determined by various loading rates such as the hydraulic, organic, salt, and nutrient load, plus soil conditions, site location, crop selection, and the overall system management. Appropriate loading rates vary according to the soil, climate, crop, and depth to the groundwater table. The design loading rates cannot exceed the vertical permeability or percolation rate of the soils, and should not create excessive build-up of groundwater mounds under the application fields.

Hydraulic loading. This refers to the quantity of water that is actually applied to the land. Tremendous differences exist in the capacity of soils to absorb water. Over-loading should not be allowed to occur for two reasons. First, the soil needs to drain and re-aerate between applications to prevent the suffocation of plants and the

TABLE VIII.3.2  
GENERAL DESIGN CONSIDERATIONS FOR LAND-TREATMENT SYSTEMS

Wastewater Characteristics	Climate	Geology	Soils	Plant Cover	Topography	Application
Flow	Precipitation	Groundwater	Type	Indigenous to region	Slope	Method
Constituent load	Evapotranspiration	Seasonal depth	Gradation	Nutrient-removal capability	Aspect of slope	Type of equipment
	Temperature	Quality	Infiltration/permeability			
	Growing season	Points of discharge	Type and quantity of clay	Toxicity levels	Crop and farm management	Types of drainage
	Occurrence and depth of frozen ground	Bedrock Type	Cation-exchange capacity	Moisture and shade tolerance		
	Storage requirements	Depth	Phosphorus adsorption potential	Marketability		
	Wind velocity and direction	Permeability			Heavy metal adsorption potential	
			pH			
			Organic matter			

SOURCE: R. D. Johnson, "Land Treatment of Wastewater," The Military Engineer 65, no. 428 (1973):375.

TABLE VIII.3.3  
 SITE SELECTION FACTORS  
 AND CRITERIA FOR EFFLUENT IRRIGATION

Factor	Criterion
Soil type	Loamy soils preferable but most soils from sands to clays are acceptable.
Soil drainability	Well drained soil is preferable; consult experienced agricultural advisors.
Soil depth	Uniformly five to six feet or more throughout sites is preferred.
Depth to groundwater	Minimum of five feet is preferred. Drainage to obtain this minimum may be required.
Groundwater control	May be necessary to ensure renovation if water table is less than ten feet from surface.
Groundwater movement	Velocity and direction must be determined.
Slopes	Up to fifteen percent are acceptable with or without terracing.
Underground formations	Should be mapped and analyzed with respect to interference with groundwater or percolating water movement.
Isolation	Moderate isolation from public preferable, degree dependent on wastewater characteristics, method of application, and crop.
Distance from source of wastewater	A matter of economics.

SOURCE: Wastewater Treatment and Reuse by Land Application, Vol. 1: Summary. Environmental Protection Technology Series (EPA-660/2-73-006a). Washington, D.C.: USEPA, Office of Research and Development, August 1973.

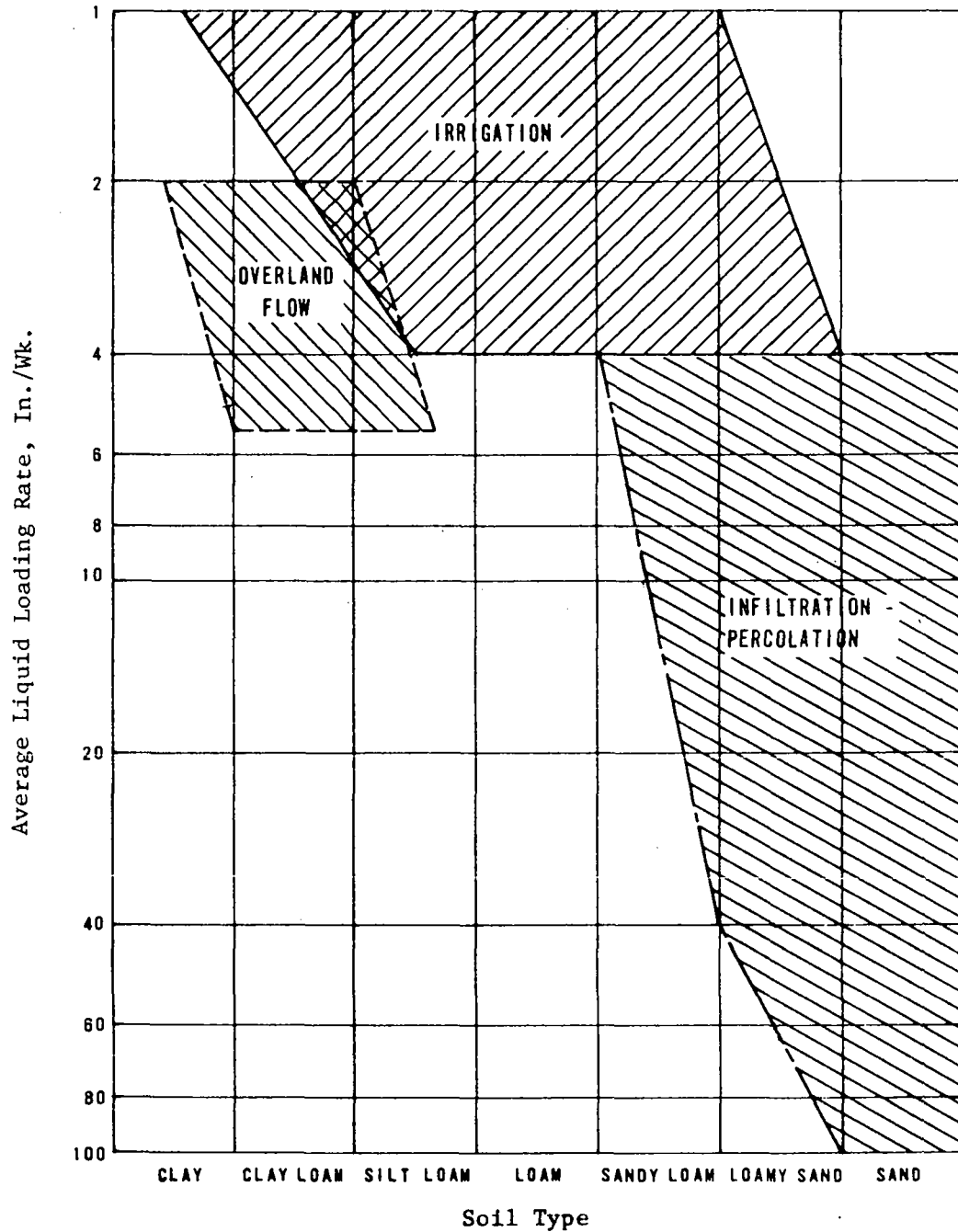

Fig. VIII.3.2. Soil type versus liquid loading rates for different land application approaches.

SOURCE: Wastewater Treatment and Reuse by Land Application, Vol. 1: Summary. Environmental Protection Technology Series (EPA-660/2-73-006a). Washington, D.C.: USEPA, Office of Research and Development, August 1973.

destruction of vegetation. Second, surface runoff will result in a serious pollution problem if overloading occurs.

Organic loading. This is an important factor because each soil has a limited capacity to decompose the organic carbon which is used as the indicator of organic loading. Soil conditions determine the actual rate of decomposition of organic matter. For example, a coarsely textured, well-aerated soil will absorb and decompose much more organic matter than will a fine textured or wet soil.

Salt loading. This is the concentration of various salts in the wastewater. An imbalance of salt in the applied wastewater may change the structure of the soil. Salt concentrations as low as 100 ppm, measured in terms of sodium ions, may render the soil incapable of transmitting water. Therefore, suitable soil amendments must be applied to insure that the soil maintains its hydraulic conductivity.

Nutrient loading. This is another important loading factor in land application. Various nutrient requirements exist for different plants and crops. The principal ones are nitrogen, phosphates, as well as other elements. The removal of nitrogen and phosphates depends on the type of soil, crop, sequence of wetting and drying periods, and wastewater loading rates. Excessive nitrite and phosphorus concentrations may build up in groundwater if nutrient loading is not properly controlled.

Soil condition. This is one of the important parameters that cannot be overlooked in land application. It determines the permeability, drainage capacity, evapotranspiration rate, cation-exchange capacity, heavy metal absorption potential, and water table slope and boundary

condition of the land. For example, rapidly permeable, well drained sandy soils can be applied with larger wastewater loading rates than slowly permeable, poorly drained clay.

Site selection. The criteria for site selection include soil types, soil drainage, soil depth, depth to groundwater, wastewater characteristics, groundwater movement, ground slope, degree of isolation of site, underground formations, and distance from the groundwater source. An ideal site is one that is well isolated, has deep loam or sandy loam soils, is well drained, has a deep groundwater table, and is located where the groundwater moving away from the site is not likely to change the quality of the regional aquifer.

Crop selection. Each crop has the capacity to absorb a specific amount of nutrients from the soil. In addition, the crop roots encourage denitrification in the root zone by supplying the necessary carbon for the denitrifying bacteria. The selection for a vegetative cover or crop depends on factors such as water tolerance, nutrient requirements and tolerances, season of growth, nutrient removal efficiency, type of soil, and market for the product. However, it has been found that most crops can tolerate the application of as much as fifty percent more than their actual need for nitrogen without suffering any damage and without the result of excessive water pollution (12).

Overall system management. Effective management and monitoring are fundamental requirements. System monitoring (such as pilot testing, wastewater analysis, and effluent sampling and testing) is required to ensure conformance to the predicted performance of a land application system and for the successful operation of such systems.



Good land application systems do not happen; they are carefully designed and then carefully managed. Sometimes, local experimentation is needed before the best design can be formulated. This is because the performance depends so much on the local conditions of soils, hydrogeology, and climate. One way to achieve this is to start on a small scale and expand the system on the basis of experiences obtained.

Generally, secondary treatment of wastewater is considered essential before disposal on land. The application of raw wastewater is not recommended. Also, land application is usually not practiced from December to April in climates where this will cause cold weather operating problems. The oxidation ponds for winter storage need to be properly designed to prevent nuisance and pollution vectors. The storage of wastewater can encourage the prolific growth of algae, and aquatic animals in the ponds. As a consequence, a significant portion of the nitrogen and phosphorus is taken up in the storage period. In addition to all the factors discussed above, the political, legal, environmental and economical impacts, as well as public involvement should be taken into consideration.

#### COST ASPECTS

The costs for land application include the capital costs, and the operation and maintenance costs. The capital costs, including those related to land, treatment, storage, transmission, and distribution, vary with geographical area, topography of the site, type of treatment, and land application system used. The operation and maintenance costs depend on the type of treatment, type and size of the

effluent distribution system and storage ponds, the nature of the vegetation cover or crop, and the geographical condition of the system.

A cost-effective comparison of the different methods of land application and other methods of wastewater treatment are presented in Tables VIII.3.4-6 and Figure VIII.3.3. In general, from Figure VIII.3.3 it may be seen that land application systems exhibit less economy of scale, especially at lower flow capacities, than advanced wastewater treatment (AWT) systems. Infiltration-percolation is the lowest cost land application system. While the overland and irrigation types are nearly equal to each other in total cost. All three land application systems are significantly more cost effective than AWT-3 or AWT-4, although the effluent qualities are approximately similar. Therefore, land application system are considered to be economically viable.

#### HEALTH ASPECTS

In the use of land application systems nitrates, refractory organics, and pathogenic organisms are of most concern from a public health standpoint. With well-designed and well-managed land application systems, nitrate nitrogen should be reduced to below the maximum limit of ten mg/liter for drinking water. Slightly higher nitrate levels may occur with high-rate systems. However, these levels can be reduced by dilution with native groundwater or by blending with other water.

BOD and suspended solids are effectively removed (90-99% percent) when wastewater moves through soil and aquifers while minute

TABLE VIII.3.4  
 COMPARISON OF CAPITAL AND OPERATING COSTS  
 COSTS FOR ONE-MGD SPRAY IRRIGATION, OVERLAND FLOW,  
 AND INFILTRATION-PERCOLATION SYSTEMS<sup>a</sup>

Cost Item	Spray Irrigation	Overland Flow	Infiltration- Percolation
Liquid loading rate, inc./wk	2.5	4.0	60.0
Land used, acres	103	64	--
Land required, acres <sup>b</sup>	124	77	5
Capital costs			
Land @ \$500/acre	\$ 62,000	\$ 38,500	\$ 2,500
Earthwork	10,300	64,000	10,000
Pumping station	50,000	50,000	--
Transmission	132,000	132,000	132,000
Distribution	144,000	64,000	5,000
Collection	--	6,000	30,000
Total capital costs	\$398,300	\$354,500	\$179,500
Capital cost per purchased acre	\$ 3,200	\$ 4,600	\$ 35,800
Amortized cost <sup>c</sup>	\$37,000	\$ 34,700	\$ 19,500
Capital cost, ¢/1,000 gal.	10.1	9.5	5.3
Operating costs			
Labor	\$ 10,000	\$ 10,000	\$ 7,500
Maintenance	19,400	12,000	3,500
Power	5,800	5,800	1,800
Total operating costs	\$ 35,200	\$ 27,800	\$ 12,800

TABLE VIII.3.4--Continued

Cost Item	Spray Irrigation	Overland Flow	Infiltration- Percolation
Operating cost, ¢/1,000 gal.	9.6	7.6	3.5
Total cost, ¢/1,000 gal.	19.7	17.1	8.8

SOURCE: Walter D. Atkins, Design Guidelines for Land Application of Municipal Wastewater (Oklahoma State Department of Health, August 1976).

<sup>a</sup>Estimated for 1973 dollars, Engineering News-Record construction cost (ENRCC) index 1860 and sewage treatment plant construction cost (STPCC) index 192.

<sup>b</sup>20 percent additional land purchased for buffer zones and additional capacity.

<sup>c</sup>15-year life for capital item, excluding land; interest rate 7 percent.

TABLE VIII.3.5

## AWT SYSTEMS

System	Constituents Removed	Processes Used
AWT-1	NH <sub>3</sub> -N	Biological nitrification
AWT-2	Total-N	Biological nitrification-denitrification
AWT-3	Phosphorus and SS	Tertiary, two-stage lime coagulation, and filtration
AWT-4	Total N, P, and SS	Tertiary, two-stage lime coagulation, filtration, and selective ion exchange

SOURCE: Wastewater Treatment and Reuse by Land Application, Vol. 1: Summary, Environmental Protection Technology Series (EPA-660/2-43-006a) (Washington, D.C.: USEPA, August 1973).

TABLE VIII.3.6

EFFLUENT QUALITY COMPARISON FOR  
LAND TREATMENT AND AWT SYSTEMS

System	Effluent Quality Parameter (mg/l)					
	BOD	SS	NH <sub>3</sub> -N	NO <sub>3</sub> -N	Total N	P
Aerated lagoon	35	40	10	20	30	8
Activated sludge	20	25	20	10	30	8
Irrigation	1	1	0.5	2.5	3	0.1
Overland flow	5	5	0.5	2.5	3	5
Infiltration-percolation	5	1	--	10	10	2
AWT-1	12	15	1	29	30	8
AWT-2	15	16	--	--	3	8
AWT-3	5	5	20	10	30	0.5
AWT-4	5	5	--	--	3	0.5

SOURCE: Wastewater Treatment and Reuse by Land Application, Vol. 1: Summary, Environmental Protection Technology Series (EPA-660/2-43-006a) (Washington, D.C.: USEPA, August 1973).

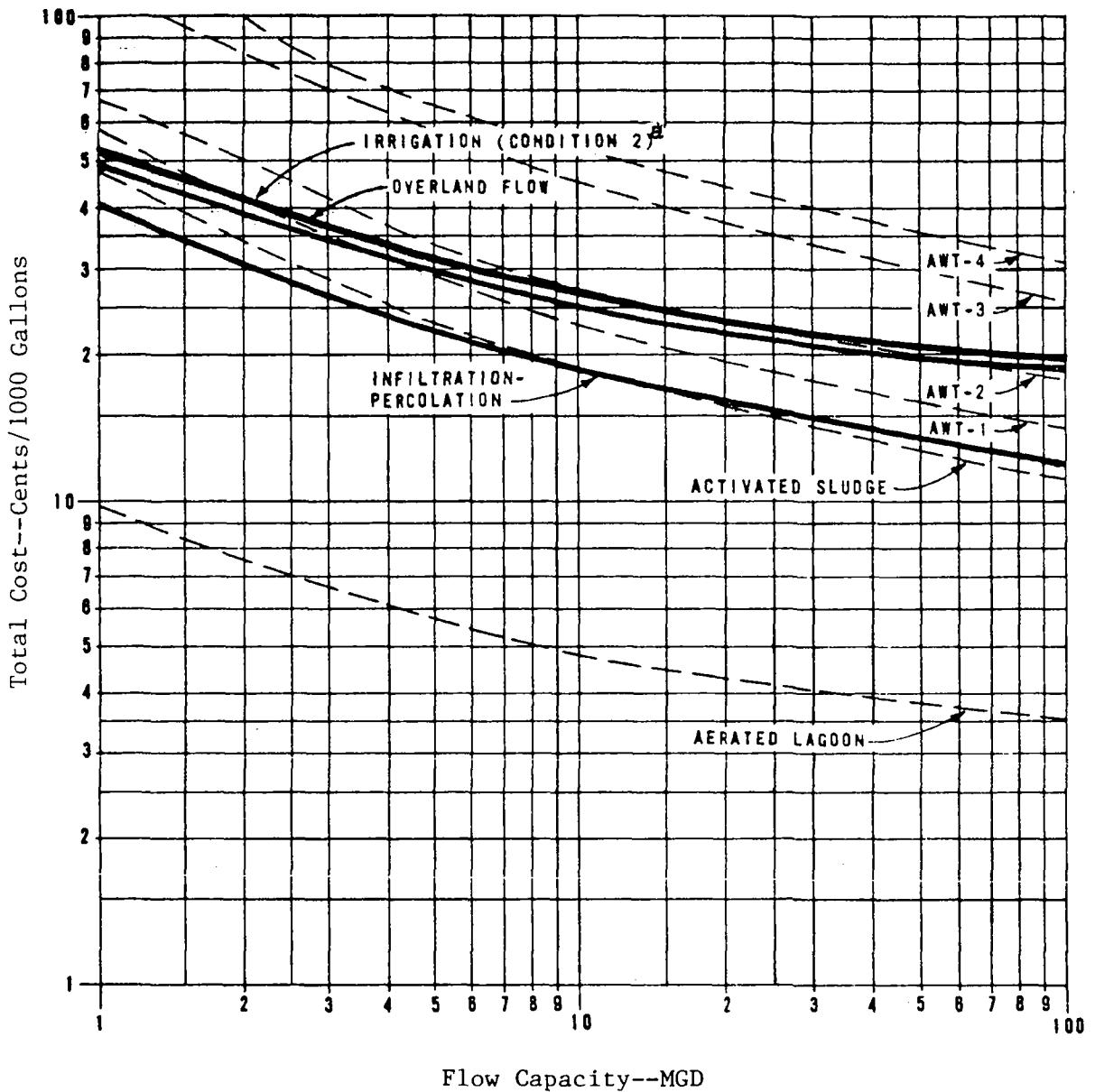

Fig. VIII.3.3. Cost of land applications systems, advanced wastewater treatment (AWT), and other treatment systems.

SOURCE: Wastewater Treatment and Reuse by Land Application, Vol. 1: Summary, Environmental Protection Technology Series (EPA-660/2-43-006a) (Washington, D.C.: USEPA, August 1973).

<sup>a</sup>Condition 2 represents a climate with moderately cold winters, moderately well-drained soil underlain by poorly drained subsoil. Application is by center pivot sprinkling.

concentrations of organic carbon may still remain. Little work has been done in this field, but it is likely that these carbon residuals do resist biodegradation and may be associated with humic-type acids. There has been speculation that these organic constituents may be toxic, teratogenic, or carcinogenic. However, the true health significance of these materials will not be established until the specific constituents are identified, their concentrations determined, and their potential health impact evaluated.

Fecal coliform tests are usually negative for renovated water after it has traveled from 3 to 330 feet. Bacterial pathogens can be considered effectively removed in this processing. Theoretically, viruses can travel greater distances than bacteria. However, viruses can be immobilized by clay and organic matter in the soil. Better virus detention can be expected in arid areas with the higher pH, higher ionic concentrations, and higher cation-exchange capacity of the soils. Chlorination of water pumped from wells affected by renovated water should effectively remove the remaining viruses. These remarks apply to both low-rate and high-rate infiltration systems. The effluent from an overloaded system may still contain considerable amounts of bacteria and viruses. If the quality of the renovated water from land application systems is considered inferior to that of native groundwater, the renovated water can be taken out of aquifers with horizontal drains or pumped wells and collected for the use of unrestricted irrigation, some industrial purposes, recreational lakes, or it can be discharged into a stream or other surface water. Compared to the discharging of treated wastewaters to surface streams and lakes that serve as the raw water supply

for many public water systems, it is preferable that the renovated wastewaters be allowed to pass from the natural aerobic soil filtration systems into groundwater and from there be used for domestic purposes.

#### SUMMARY AND CONCLUSIONS

Estimates of water use indicate that the need for water will continue to increase in the future. The renovated water from land application systems can help meet the demands and also benefit farmers with a water supply and nutrient supply for crops.

The advantages of land treatments include the following:

1. It is a method of water treatment as well as method of resource recovery.
2. The use of nitrogen, phosphorus and other elements for irrigation of crops can reduce the demands for artificial fertilizers and minimize the contribution of these nutrients to the eutrophication of streams and lakes.
3. The reclaimed water having undergone sufficient treatment for reuse, can economically supplement groundwater supplies, particularly in the case of high rate systems.
4. The requirements of the land treatment process are low in terms of energy and chemicals.
5. Land treated wastewaters are kept out of surface waters used for drinking purposes.
6. Well-designed and well-managed land treatment systems are fail-safe.
7. Money invested in land is never lost.



8. In general, land application systems can be considerably less expensive, and more cost-effective than tertiary treatment facilities yielding water of similar quality.
9. Land application can be operated with a minimum of environmental and health hazards.

The disadvantages of land treatment include: operational problems due to cold weather, problems related to the requirement and availability of land, a large dependence on local conditions, and the potential for pollution and induced toxicity of groundwater. The concentrations of harmful trace elements and toxic substances which are not likely to be removed in the renovation process must be controlled in irrigation water or reduced in advance of land disposal. Extensive soil-water and groundwater pollution is more difficult to correct than surface water pollution, and once present, such pollutants can persist for generations within the subsurface. One of the biggest potential problems with land application can be the pollution of surface waters by runoff from excessively loaded systems. However, excessive runoff can be controlled by careful design and management of the total system.

Land application has its supporters as well as its opponents. The proper approach is a rational assessment of the various alternatives so that the system that gives economically and environmentally the best solution can be selected.



## CHAPTER IX

# On-Site Disposal and Treatment

For disposal and collection systems in nucleated areas, the sanitary pit privy with its variants, and sewerage systems including sewage treatment are not the only answers. The intermediate approach of the sewerless toilet or on-site treatment is a viable alternative. In many LDC cities there exist few if any sewers, let alone sanitary sewerage systems. Consideration should be given to the problems and costs associated with sewer system construction for such large populations, as well as to the problems and costs associated with the treatment which would be required. The material in this chapter is concerned with the sewerless toilet or on-site treatment as a viable alternative, and is a shortened and revised version of the original publication which it represents.

There are three general classifications used for the sewerless units, hydraulic, biological, and chemical/thermal. To date in DC's the use of thermal toilets has been mostly limited to boats, offshore drilling sites, and recreation areas, so that their current production costs are not representative of high production levels. Studies of costs at high production levels and with in-country production indicate that a non-structural system of on-site units is quite competitive with other methods.

There is a need for the testing of numerous management schemes for the manufacture and distribution of systems of these on-site units: (1) in-country manufacture and placement as a social service; (2) private enterprise (LDC and DC combinations), starting an entirely new industry; (3) a combination of the in-country social service approach, with or without at least an initial governmental subsidy.

The use of such on-site alternatives for sewage could aid in breaking the water-related disease cycle. Separate handling would be required for grey water; however, a piped water distribution system with all its attendant problems and costs, would not be required.

## IX.

COST-EFFECTIVENESS OF THE SOCIO-CULTURAL  
AND HEALTH BENEFITS OF SEWERLESS  
ALTERNATIVES FOR DOMESTIC WASTE  
DISPOSAL IN DEVELOPING COUNTRIES

Gayle Townley

## INTRODUCTION

Background. The need to remove or dispose of human waste is an integral part of every culture. The manner in which it is done has had widespread health effects and has influenced man's progress throughout recorded history. It has only been in the last two hundred years that a waterborne piped collection network has been utilized to remove wastewater from households in populated areas. These waterborne sewage systems have served admirably in cities or urbanized areas with high density populations, enabling a large number of persons to be free of the associated diseases, especially enteric and helminthic diseases, that accompany unsanitary conditions.

Where and when abundant water is cheaply available and the level of wealth can support the high capital costs required, centralized collection and treatment systems have been very successful in influencing the improvement of health conditions. Usually such systems have become possible only with the advent of a centrally piped water supply system.

Available processes for sewage treatment and/or disposal encompass both the waterborne sewage systems and the newer waterless or

---

Washington, D.C.: U.S. Agency for International Development, Office of Health, Technical Assistance Bureau; and Norman: University of Oklahoma Bureau of Water and Environmental Resources Research, 1977. (184 pp.)

water-restricted sewage systems. The waterborne systems are referred to in this report as conventional treatment due to their widespread acceptance. The waterless or water-restricted systems are referred to as sewerless treatment though some devices are initially included which connect to sewage lines.

Cost has often been the sole determining factor in the selection of alternative sewage disposal/treatment systems. Availability, adaptability, and the latest technology in methods and equipment have also had some influence. None of these are particularly "bad" reasons for selecting a system, but by themselves they have not proven to be adequate in the light of failures, system breakdowns and partial treatment. Because centralized treatment facilities are generally one of a kind, and because collection systems vary as to topography and settlement patterns, responsibility for failures has been difficult to establish. In less developed countries (LDC's) engineering expertise for design and installation as well as equipment requirements for such facilities have been almost entirely transferred from the more industrialized nations. Thus, particularly in LDC's, there have been problems related to adaptation, application of system designs, higher than unexpected costs, unanticipated construction delays, an earlier than expected need for equipment replacement, and early system failures.

Need for study on wastewater. The need for treatment of wastewater is no less than the need for safe water supplies. Basic sanitation services are needed for the prevention and control of communicable diseases and for the promotion of physical, mental, and social well-being throughout the world. Some studies have indicated that there is a greater than

70% reduction in water-related communicable diseases with water treatment and an additional 25% or greater reduction with the introduction of sewage treatment.

Actually, the overall picture of sewage disposal gained through research involving ninety selected LDC's, is not as good as that of water supply. This is due somewhat to the earlier emphasis on safe drinking water prior to concern for a treated effluent. On the basis of currently available information from the World Health Organization, estimates in LDC's are that fifty percent of urban residents are served with public sewerage systems and forty-five percent more with individual household systems. In rural areas ninety-one percent of the population is estimated to have inadequate excreta disposal facilities. This means that in LDC's greater than one billion people are following primitive excreta disposal practices, burial and stream, which lead to unnecessary illness, disability, and death.

Among these one billion or more people there are those who cannot be reached by conventional treatment systems and who could potentially benefit from sewerless alternatives. Target areas should be those areas which have been shown to public health officials to have the highest risk for waterborne diseases.

Cost-effectiveness. Cost-effectiveness analysis as applied here, is defined as an analytical study designed to assist a decision-maker in identifying a preferred choice among possible alternatives and involves two steps of evaluation. The first step is cost evaluation which entails the delineation of all major system components and the development of capital and operating costs for each. The second step is the effectiveness evaluation in which one attempts to generate a single basic measure

or indicator of effectiveness using multiple considerations. The essence of cost-effectiveness analysis then compares the trade-off of cost with effectiveness to identify the most cost-effective alternative.

The traditional economic analysis of engineering systems was dependent on cost consideration alone. Decision-makers initially used the least cost solutions that met required constraints. In this case, systems were measured by minimizing the cost without referring to the benefits. Following this approach, evaluations emphasized net cost or net savings, with this representing the difference between total cost incurred and any resultant benefits which could be expressed in monetary units. However, it has been well demonstrated that combining costs and benefits into a single measure will not necessarily indicate the most economically efficient alternative. Thus, cost-benefits analysis which centered on the cost/benefits ratio as the indicator of economic efficiency was introduced.

Cost-benefits analysis, however, is not satisfactory in evaluating wastewater treatment and disposal systems for any public application because the overall utility of any alternative system depends upon multiple criteria or measures of effectiveness (reliability, operational simplicity, automation, public acceptability, and others) which cannot be expressed directly in monetary units without losing the true significance of cost and/or benefit.

Thus, selection of one wastewater system from among a group of alternatives, with respect to multiple criteria, asserts a complex problem in decision-making for local administrators and consulting engineers as well as for federal agencies and international loan institutions. Use of decision-weighting models has become a necessity. The ability to



measure formerly non-quantitative values for comparison with quantitative ones enhances the use of such modeling techniques for decision-making.

In this report, will be found a representation of the possible conventional treatment systems which have been or could be used in developing areas, as well as their advantages or disadvantages. During the evaluation, they served as the fundamental knowledge that must be referred to when evaluating those system criteria which can only be judged from the knowledge of current practices. A comprehensive survey of sewerless or water reduction disposal devices and hardware manufacturers is also included. This study is then directed toward identifying the most cost-effective systems for use in developing countries.

#### HISTORIC DEVELOPMENT OF WASTEWATER DEVICES AND TREATMENT

General. Early methods of waste removal or avoidance have included migration, cremation, burial, use of earth closets, bodies of water, and midden heaps. Ditches or trenches have sometimes been dug to receive large quantities, and great pits roofed over with beams and earth have been used to receive large quantities of water from washing and cooking as well as sewage. Excavations such as these have been found which have been lined with brick, arched over, and connected with the houses by brick or flagstone drains. The pits have not usually been cemented because this would have meant more frequent emptying, as well as provision for venting of the sewer gases. Where running water came into use in the 1800's and waterclosets after 1870, cesspools became completely inadequate. Up until that time, where sewers were used they had been considered receptacles of surface water runoff only, while disposal of collected sewage was accomplished primarily through use of sewage farming

or dumping into streams. The increased volume of water used by householders encouraged sewerage development, and disposal by dilution with sewers emptying into rivers, streams, and lakes. When cities began to dump their sewage into water courses from which drinking water was also drawn, incredibly high typhoid fever death rates often resulted. Filtration of water supplies rather than sewage treatment first evolved as the answer because sanitary engineers of that period argued that given the level of benefits the costs of sewage treatment were too high when compared to the costs of water filtration. Later, sewage treatment was introduced in some areas where water treatment alone proved inadequate for the maintenance of a sanitary water supply.

Septic systems. Septic tank systems began to replace cesspools and privy vaults after the 1890's as the public became aware of sanitation problems and accepted the necessity for new methods. (See Figure IX.1.) Septic systems were first patented in England by John Louis Mouras and Abbe Morgno in 1881. Their first application in the United States was in Boston in 1883.

Initially, septic tanks were constructed by rule-of-thumb estimates and later according to the construction guides published by various state and federal authorities. These early systems consisted of the septic tank itself with a soil leaching or absorption field which received the overflow of anaerobically decomposed wastewater. After introduction in the United State several modifications in the basic design and principles of operation took place. No major modifications have taken place in the last thirty-five years. Sludge removal from septic tanks is necessary every two to four years or when the system fails.

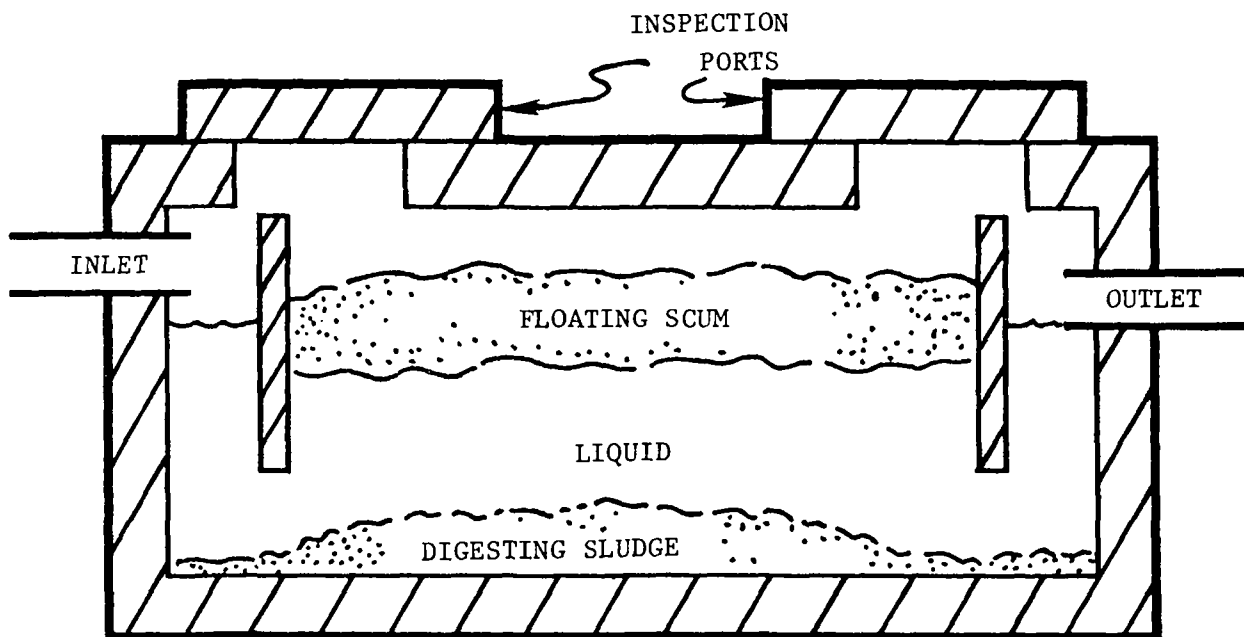

Fig. IX.1. Typical septic tank design.

Today, the number of septic tanks in the United States is unknown with estimates ranging from thirteen to twenty-five million individual disposal units. This estimate would also include aerobic systems which have had some acceptance with an estimated 20,000 to 30,000 in use in 1970.

Public health effects are critical when septic systems are built close to private wells. Outbreaks of typhoid fever, dysentery, gastrointestinal infection, infectious hepatitis and infant methemoglobinemia have been traced to malfunctioning septic tank systems, often improperly designed systems located too close to water wells. Lack of known alternatives, especially lower cost or more effective available treatment methods, has led to the continued installation of septic tank/soil absorption systems (ST/SAS).

Alternative technological advances. In developed countries man uses forty percent of the treated drinking water produced to flush away waste from water closets to treatment plants. This is the most expensive system ever devised by man, though the flush system accompanied by treatment is undoubtedly responsible for maintaining the health of the developed world.

Reportedly, seventy percent of the world's population does not even have piped water, so that they are automatically excluded from use of the flush toilet system. An estimated 5.8 million people in the United States do not have sewage or water systems, and the World Health Organization has estimated that only eight percent of the urban families in lesser developed countries have a sanitary sewage system.

Alternative technology for disposal/treatment of excrement has been developed in the past thirty years which are waterless or water conserving

devices. These new devices, comprising approximately thirty patents, may be classified into five groupings:

1. Incinerating toilets burn body waste to a sterile ash and thus consume energy, about \$2.00/month.
2. Composting toilets consist of a large fiberglass container eight feet long with a slanting bottom, located in the basement with the result being a dried compost after two years.
3. Biological toilets are based on biological principles of waste digestion where body wastes and toilet tissues are in effect turned into water by enzymes and bacteria by the weekly addition of a bio-package, and are disposed of in a small drain field outside the house.
4. Vacuum systems uses the vacuum principle to transport body wastes from the toilet bowl through sewer lines for disposal (expensive for an individual system).
5. Aerobic tanks use a small pump to mix air into a tank, similar to a septic tank, so that digestion is speeded up, and addition of dissolved oxygen also helps to prevent clogging of drain fields.

Primarily, the difficulties with utilization of these systems have been cost due to limited production, availability to site at construction time, and the additional requirement of a previously known need for a nonconventional system.

#### CONVENTIONAL TREATMENT SYSTEMS

Conventional cost data. Preliminary results of conversations with the World Bank show that total system costs are not available for

countries outside the United States. Facility costs are available in some cases, but the investment requirements for the entire system, that is, sewerage, house connections, household plumbing and equipment costs have not been established for the population to be served by the facility. The reasons for this are complex. Financing is done by various methods and sources with the United Nations providing some of the investment capital in addition to that of the country and financial lending institutions. Construction of water and wastewater projects is often linked with each one servicing a varying population. Financing and construction is done in steps or stages for urban areas with cost estimates sometimes based on a larger population than that which will be initially served. Each additional step or extension is then divided by the same or a portion of the same population already included in the previous estimate. Such estimates have been necessary to obtain approval for projects which would have been economically unacceptable otherwise.

These reasons for the lack of comprehensive data, of course, are not limited to economic development projects in other countries. Cost estimating projects of all forms of public works construction in the United States have utilized various projection techniques to improve the feasibility and to secure the acceptance of projects which would have otherwise been fiscally impossible for cities in the United States to undertake. Because of the widespread use of such techniques and the multiple forms of financing possible, public works projects in the United States have hidden costs which have not been explored to this date. Cost studies have primarily centered on the treatment and sewerage portions, thus not revealing the total encumbrance of the public for such projects. Several excellent documents which supercede previous efforts

at analysis of conventional treatment costs have been produced. The first one, A Guide to the Selection of Cost-Effective Wastewater Treatment Systems, provides by diagram the alternative wastewater treatment systems which are capable of achieving the same effluent quality (3). This guide's main use is to make rough "comparative" analysis during the facilities planning phase. Reference can then be made to the unit process cost curves which give cost/1000 gallons according to plant capacity, for operation and maintenance and capital costs. Prices are based on the February 1973 National Average Wastewater Treatment Plant Cost Index, the Wholesale Price Index for Industrial Commodities, and Labor Costs from the United States Environmental Protection Agency (EPA) and the Department of Labor Statistics Office. A summary of treatment plant construction cost estimates was developed for unit processes (Table IX.3) with the explanation of the treatment codes given in Tables IX.1 and IX.2. Since construction and operation and maintenance (O & M) costs are constantly changing, an appendix was provided in the Guide where cost equations have been developed with a flexibility that permits changing various economic parameters, such as cost indices and labor rates. Such flexibility in the analysis of conventional treatment alternatives has been unavailable in other costing sources.

The following paragraph contains common terms and some costs given in the Guide. Total cost for each unit process comprises the sum of the capital, operating and maintenance costs. Capital costs include construction amortized over twenty years at 5 5/8 percent, structures, equipment, pumps and integral piping, appurtenances described or implied by the unit process, land requirements at \$2000/acre, engineering,

TABLE IX.1

CODE-- INFLUENT AND CONVENTIONAL WASTEWATER  
TREATMENT UNIT PROCESSES

---

<p>AA. Preliminary Treatment Influent: Raw wastewater</p>	<p>D. Filtration Influent: Effluent from A-2,B-2,B-3,C-2 C-3,C-4,C-5,F-1 or F-2,G-1,G-2,G-3,G-4, H,J,K</p>
<p>AB. Raw Wastewater Pumping Influent: Effluent from AA</p>	
<p>A. Primary Sedimentation Influent: Effluent from AA or AB A-1 Conventional A-2 Two-Stage Lime Addition A-3 Single Stage Lime Addition A-4 Alum Addition A-5 FeCl<sub>3</sub> Addition</p>	<p>E. Activated Carbon Influent: Effluent from D</p>
<p>B. Trickling Filter B-1 Influent: Effluent from A-1 B-2 Influent: Effluent from A-3 B-3 Influent: Effluent from A-4 or A-5</p>	<p>F. Two-Stage Tertiary Lime Treatment F-1 Influent: Effluent from B-1 F-2 Influent: Effluent from C-1</p>
<p>C. Activated Sludge C-1 Conventional Influent: Effluent from A-1 C-2 Conventional Influent: Effluent from A-3 C-3 Conventional Influent: Effluent from A-4 or A-5 C-4 Alum Addition Influent: Effluent from A-1 C-5 FeCl<sub>3</sub> Addition Influent: Effluent from A-1 C-6 High Rate Influent: Effluent from A-1 C-7 High Rate and Alum Addition Influent: Effluent from A-1 C-8 High Rate and FeCl<sub>3</sub> Addition Influent: Effluent from A-1</p>	<p>G. Biological Nutrifcation G-1 Influent: Effluent from C-6 G-2 Influent: Effluent from B-1 G-3 Influent: Effluent from A-3,A-4 or A-5 G-4 Influent: Effluent from A-2,C-7 or C-8</p>
	<p>H. Biological Denitrification Influent: Effluent from G-1,G-2,G-3 or G-4</p>
	<p>I. Ion Exchanges Associated with A-2,B-2,B-3,C-2,C-3,C-4, C-5,F-1, or F-2</p>
	<p>J. Breakpoint Chlorination Influent: Effluent from A-2,B-1,B-2,B-3,C-1, C-2,C-3,C-4,C-5,F-1 or F-2</p>
	<p>K. Ammonia Stripping Influent: Effluent from F-1 or F-2</p>
	<p>R. Disinfection Influent: Effluent from any treatment pro- cess</p>

---

SOURCE: A Guide to the Selection of Cost-Effective Wastewater Treatment Systems,  
EPA 430/9-75-002, March 1975.



TABLE IX.2  
CODE--INFLUENT AND SLUDGE  
HANDLING UNIT PROCESSES

---

L. Anaerobic Digestion	
L-1 Sludge Influent:	Generated from A-1+B-1, C-1 or C-6
L-2 Sludge Influent:	Generated from A-1+C-4, or C-5, or C-7, or C-8, A-4+B-3 or C-3, A-5+B-3 or C-3
M. Heat Treatment	
M-1 Sludge Influent:	Generated from A-1+B-1, C-1 or C-6
M-2 Sludge Influent:	Generated from A-1+C-4 or C-5, or C-7, or C-8, A-4+B-3 or C-3, A-5+B-3 or C-3
N. Air Drying	
N-1 Sludge Influent:	Effluent Sludge from L-1
N-2 Sludge Influent:	Effluent Sludge from L-2
O. Dewatering	
O-1 Sludge Influent:	Generated from A-1+B-1, C-1 or C-6
O-2 Sludge Influent:	Generated from A-1+C-4 or C-5, or C-7, or C-8, A-4+B-3 or C-3, A-5+B-3 or C-3
O-3 Sludge Influent:	Generated from A-2
O-4 Sludge Influent:	Generated from A-3+B-3 or C-2
O-5 Sludge Influent:	Effluent Sludge from L-1
O-6 Sludge Influent:	Effluent Sludge from L-2
O-7 Sludge Influent:	Generated from F-1 or F-2
O-8 Sludge Influent:	Effluent Sludge from M-1
O-9 Sludge Influent:	Effluent Sludge from M-2
P. Incineration	
P-1 Influent Sludge:	Effluent Sludge from O-1
P-2 Influent Sludge:	Effluent Sludge from O-2
P-3 Influent Sludge:	Effluent Sludge from O-3
P-4 Influent Sludge:	Effluent Sludge from O-4
P-5 Influent Sludge:	Effluent Sludge from O-7+O-1
P-6 Influent Sludge:	Effluent Sludge from O-8
P-7 Influent Sludge:	Effluent Sludge from O-9
Q. Recalcination (includes chemical storage and feeding)	
Q-1 Sludge Influent:	Effluent Sludge from O-3
Q-2 Sludge Influent:	Effluent Sludge from O-4
Q-3 Sludge Influent:	Effluent Sludge from O-7

---

SOURCE: A Guide to the Selection of Cost-Effective Wastewater Treatment Systems, EPA 430/9-75-002, March 1975.

TABLE IX.3  
SUMMARY OF TREATMENT PLANT CONSTRUCTION COST ESTIMATES

Treatment Category	Alternative Number	Unit Processes by Alternative	Estimated Cost (\$ Million) at Design Flow Rate (MGD) <sup>a</sup>			
			1	5	20	100
Primary -- Conventional (PS1)	1	AA, AB, A-1, C-1, R, O-5, L-1	2.06	3.73	9.05	34.4
	2	AA, AB, A-1, C-1, R, P-6, O-8, M-1	2.67	5.13	11.7	38.7
	3	AA, AB, A-1, C-1, R, O-1, P-1	2.53	4.97	11.5	38.7
	4	AA, AB, A-1, C-1, R, O-1, P-5	2.36	4.58	10.7	36.7
	5	AA, AB, A-1, B-1, R, L-1, N-1	1.63	3.54	9.79	40.2
	6	AA, AB, A-1, B-1, R, L-1, O-5	1.84	3.50	8.81	34.1
	7	AA, AB, A-1, B-1, R, O-8, P-6	2.42	4.90	11.4	38.4
	8	AA, AB, A-1, B-1, R, O-1, P-1	2.30	4.74	11.3	38.4
	9	AA, AB, A-1, B-1, R, O-1, P-5	2.14	4.35	10.4	36.4
		Mean Cost (Alternatives above)	2.22	4.38	10.5	37.3
Primary -- Stabilization Pond (PS2)	1	AA, AB, A-3, R, C-2, O-4, P-4	2.70	5.32	12.3	35.8
	2	AA, AB, A-3, R, B-2, Q-2, O-4	2.36	4.63	10.7	36.0
	3	AA, AB, A-3, R, B-2, O-4, P-4	2.50	5.10	12.0	35.0
Sludge -- Conventional (PS3)	1	AA, AB, A-1, C-1, F-2, R, O-5, L-1	2.70	4.61	10.8	41.0
Sludge -- Advanced (PS4)	1	AA, AB, A-2, G-4, R, O-3, P-3	3.22	5.29	12.1	41.3
Sludge -- Combined Imhoff (PS5)	1	AA, AB, A-2, G-4, H, R, O-3, P-3	3.56	5.90	13.7	48.2
Secondary -- Standard Filter (PS6)	1	AA, AB, A-2, G-4, H, O, R, O-3, P-3	3.97	7.09	16.7	56.8

<sup>a</sup>Estimated using cost equations from Table B-1 of A Guide to the Selection of Cost-Effective Wastewater Treatment Systems, EPA 430/9-75-002, March 1975, an STP Index of 263, and a 20% surcharge for site work and buildings. STP Index is the national average wastewater treatment plant cost index.

contingencies, and interest during construction at twenty-seven percent. Operation and maintenance costs include the annual average equivalent of O & M costs at 100 percent utilization throughout the life of the plant, and all material costs, including chemicals, power, fuel, and other materials. Capital costs are trended at the National Average Wastewater Treatment Plant Cost Index of 177.5 for February 1973, and materials at the Wholesale Price Index for Industrial Commodities of 120.0 for February 1973. Labor cost including allowance for fringe benefits, was taken at five dollars per hour.

An Analysis of Construction Cost Experience for Wastewater Treatment Plants is based on the grant eligible cost data for more than 150 treatment plants constructed during a period of four years (42). Costs in the Analysis were adjusted to include 20% for site work and were updated from 1973. The comparison established that bid costs are 1 to 2.5 times higher than cost predicted. Thus less economy of scale is shown by the bid data than has been previously assumed because of the construction cost escalation (Table IX.4).

The market place is found to limit accurate quantification of costs for the types of unit processes or the required effluent quality. Previous cost data publications had failed to address this problem. Table IX.5 gives costs and energy requirements for collection systems of various sizes and population densities in 1976. Figure IX.2 contains cost curves which are a best fit of extremely variable data points and which might require adjustment for a specific project.

Small Community Costs. A summary of the results of an EPA survey of conventional systems of towns under 50,000 population in the summer of 1976 indicated the following:

TABLE IX.4

CONSTRUCTION COST ESCALATION FROM TREATMENT  
CATEGORY ONE TO SPECIFIED TREATMENT CATEGORY<sup>a</sup>

Treatment Category	Selected Alternative (From Table IX.3)	Design Flow Rate (MGD)				Average	Factor Used
		1	5	20	100		
Primary -- Conventional (PS1)	1	1.00	1.00	1.00	1.00	1.00	1.00
Primary -- Stabilization Pond (PS2)	1	1.31	1.43	1.36	1.04	1.28	1.20
Sludge -- Conventional (PS3)	1	1.31	1.24	1.20	1.19	1.23	1.23
Sludge -- Advanced (PS4)	1	1.56	1.42	1.34	1.20	1.38	1.38
Sludge -- Combined Imhoff (PS5)	1	1.73	1.58	1.52	1.40	1.56	1.56
Secondary -- Standard Filter (PS6)	1	1.92	1.90	1.85	1.65	1.83	1.83

SOURCE: USEPA, An Analysis of Construction Cost Experience for Wastewater Treatment Plants, February, 1976.

<sup>a</sup>Ratio of estimated construction for specified treatment category to that for Treatment Category 1, at each flow rate.

TABLE IX.5

COLLECTION SYSTEMS--POPULATION AND DENSITY VERSUS  
ENERGY REQUIREMENTS AND ANNUAL COSTS (1976)

Population of Agencies	Miles of Sewer	Population per Mile	Annual Sewer Line Cost (\$ Per Mile)	Number of Lift Stations	Installed Pump Horsepower	Kilowatt-hrs Consumed (Millions)
10,000	29	345	185	5	52	0.0239
36,685	128	287	297	5	220	0.120
43,000	153	281	910	22	1390	0.608
84,700	337	251	521	5	16	0.006
89,200	360	248	839	26	565	not available
309,000	1211	255	469	48	3112	4.0
383,000	1600	239	2444	57	1997	1.93
557,000	1450	385	674	13	not available	not available
728,400	1355	538	1370	5	855	0.491
Range of Values	29 to 1600	239 to 538	185 to 2444	5 to 57	16 to 3112	0.006 to 4.0

SOURCE: Brady, Goodman, Kerri, and Reed, "Performance Indicators for Wastewater Collection Systems," presented at the Fiftieth Annual Conference, Water Pollution Control Federation, Philadelphia, Pennsylvania, October 2-7, 1977.

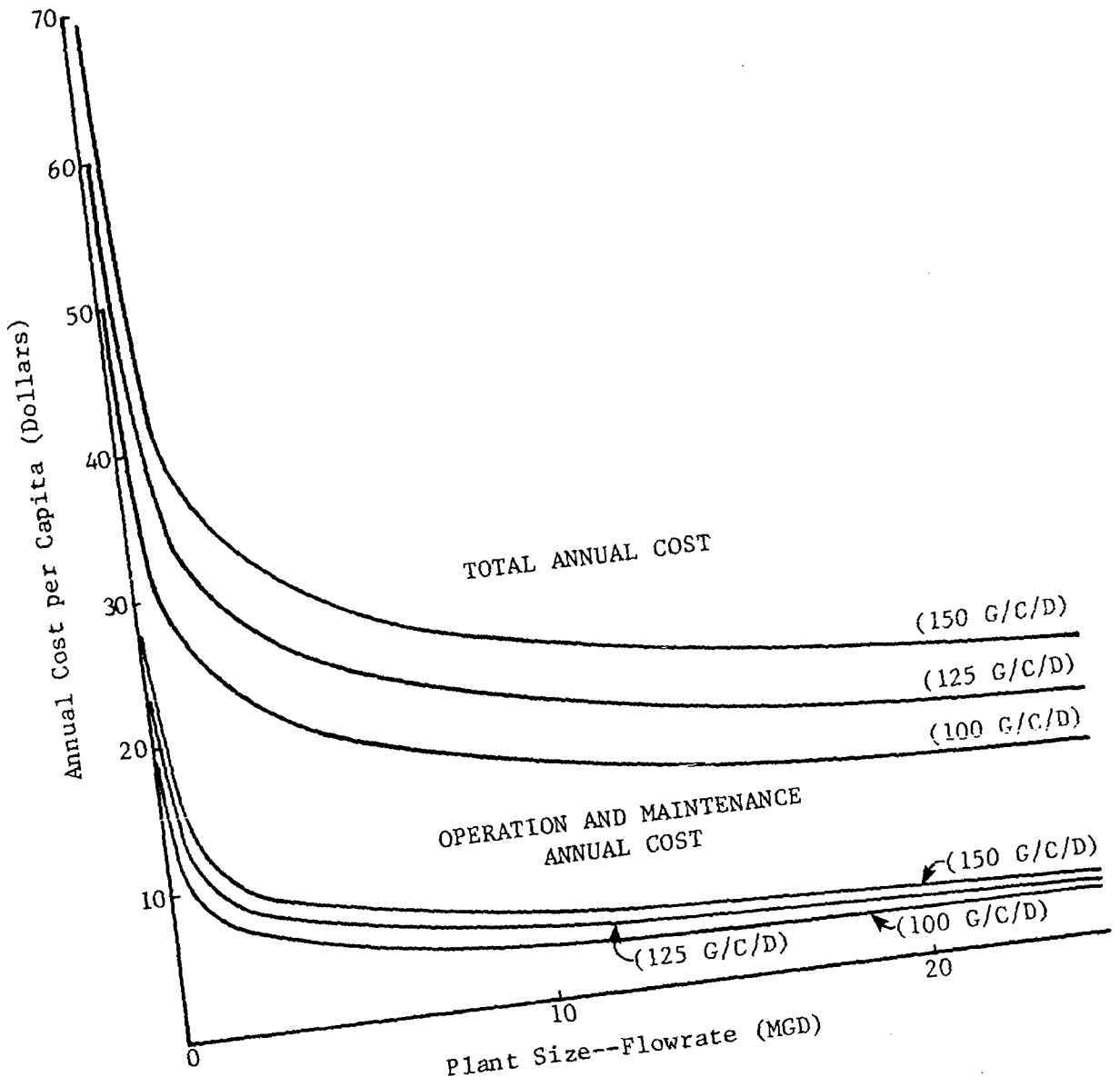

Fig. IX.2. Annual per capita costs according to waste-water treatment plant size.

Two hundred fifty-eight facility plans for forty-nine states were analyzed. The results indicate that operation and maintenance plus debt retirement of the local share for recommended new facilities will cost in excess of \$100 per household in 40% of the communities and \$200 per household in 10%. Costs exceeded \$300 per household per year in several cases. Communities under 10,000 population experienced much higher costs on the average than larger communities. (43)

This meant to the householder in a small town that the sewage portion alone of his monthly bill from the city could run in the neighborhood of from twelve to twenty dollars. Fault for the high cost was attributed to the failure to analyze the alternatives of non-sewered systems in the facility plans even in cases where they were potentially cost-effective (10).

In a review for the National Conference O & M costs for small municipal wastewater treatment facilities were presented which had been derived from 1300 inspections and adjusted to 1976 dollar levels (43). (See Table IX.6.) Similarly, the present worth O & M and capital costs were compared for activated sludge facilities (Table IX.7). It is apparent that mechanical activated sludge facilities have significantly higher O & M costs than the other types of facilities listed in Table IX.6.

Alternate disposal techniques. Various means are being explored as alternatives for disposal of sewage once it has been collected. Two alternatives presently under study by EPA are:

1. aquaculture -- the use of sewage as a fish food,
2. land application (spray irrigation, overland flow, and rapid infiltration) -- the deposit of sewage on land to increase fertility of crops. The crops involved have usually been lower in the food chain than those intended for human consumption.

Some difficulties are being experienced with both methods. In aquaculture metals appear to aggregate in the higher predatory fish

TABLE IX.6

OPERATION AND MAINTENANCE COSTS FOR SMALL  
MUNICIPAL WASTEWATER TREATMENT FACILITIES  
(1976 Dollar Levels)

Wastewater Treatment Process	Annual O&M Cost (\$ 1000's)	
	0.1 MGD	1.0 MGD
Primary	11.6	58.5
Trickling Filter	12.5	61.5
Extended Aeration	18.0	66.7
Activated Sludge	18.6	87.0
Stabilization Ponds	11.2	38.1

TABLE IX.7

PRESENT WORTH COMPARISON OF O&M COSTS WITH  
CAPITAL COSTS FOR ACTIVATED SLUDGE FACILITIES

Design Flow Rate (MGD)	Present Worth of Capital Cost (\$ Million)	Present Worth of O&M Cost (\$ Million)
.1	.323	.406
.5	1.226	1.193
1.0	2.140	1.899

SOURCE: USEPA, O & M Considerations for Small Municipal Wastewater Treatment Facilities (Washington, D.C., 1977).



thus eliminating them as a potential human food source and reducing the cost-effectiveness of this method. Conservationists are in opposition to the various land application techniques because of problems of land availability and because of the metals and minerals present in the wastewater due to the industrial contribution in central collection systems and to the inability to control access to sewerage systems. Environmental assessment procedures will also slow this land disposal effort reducing its effectiveness in the next few years.

Land application treatment costs have been developed in a series of three documents in which five of the best known case histories of land application of municipal wastewater are presented (24).

Low pressure sewer systems are an alternative which could also offer significant cost advantages for collection systems under certain circumstances. However, this would not be an overall solution to sewerage problems since treatment would still be needed.

The JPL system is a new cost-saving sewage treatment process derived from National Aeronautics and Space Administration (NASA) research. A pyrolytic reactor converts solid sewage material to activated carbon which in turn treats incoming wastewater. It is expected to exceed the EPA standards for ocean discharge and to reduce capital costs by twenty-five percent as compared with conventional processing systems.

The wet transfer system utilizes a grinder to mix household refuse with sewage. A recent study suggests that the wet transport of such a combination would be technologically feasible and convenient but more expensive than the conventional method of collecting and transporting refuse (11). A cost analysis of the two systems suggests that the wet transport system is uneconomical for present wide-scale application so long

as less skilled manpower is available and transportation costs are not excessive (see Tables IX.8 and 9).

#### STATE OF THE ART -- SEWERLESS TREATMENT SYSTEMS AND WATER REDUCTION DEVICES

Septic tank. At the present time on-site sewage treatment technology primarily utilizes septic tank (or anaerobic) treatment of household wastewater. Because of the availability of septic systems, their proven acceptance, and the financing of such systems by lending institutions, this type of treatment is widespread. Introduction of septic tanks by public health educators and sanitarians is common whenever public water supplies are extended especially in areas where central collection is impractical or infeasible.

Intermediate technology. Another level of technology in wastewater disposal has been developing (or accumulating) in the past few years which cannot be ignored in any state-of-the-art documentation. The technology itself is not new but the techniques are. Composting, aqua privies, and water basin discharge for flushing are some of the many disposal methods included in the intermediate category. These disposal methods utilize local materials in on-site construction (16). Local materials used in both Tanzania and Botswana included such things as elephant grass, ferrocement, and thin and narrow concrete bricks. One successful unit which has been reported, the Roec Latrine, has an inclined shaft extending into a trench with a vertical vent. Preliminary results have indicated that the vertical vent is the key to fly control. Another successful unit adapted to Moslem culture allows the use of water for cleansing. It is called the Utafiti and has an open

TABLE IX.8  
 COMPARATIVE ANNUAL COSTS PER HOUSEHOLD  
 FOR CONVENTIONAL AND WET TRANSPORT SYSTEMS,  
 BY SIZE OF POPULATION AND REFUSE GENERATION RATE

Item	Total System Cost Range	
	Conventional System <sup>a</sup>	Wet System
Population size <sup>b</sup>		
50,000	\$57-115	\$132-196
100,000	52-110	126-184
500,000	43-101	113-160
Refuse generation rates <sup>c</sup>		
1.02 kg	43-101	113-160
1.53 kg	45-103	126-172
2.04 kg	47-105	134-181

SOURCE: Curran Associates, "A Preliminary Assessment of Wet Systems for Residential Refuse Collection," EPA Contract No. 68-03-0183, March 1974, p. 152.

<sup>a</sup>Includes the usual costs for sewage collection and sludge handling and assumes incineration of refuse.

<sup>b</sup>A generation rate of 1.02 kilograms per capita per day is assumed.

<sup>c</sup>Kilograms per capita per day are for a population of 500,000.

TABLE IX.9

COMPARATIVE ANNUAL COSTS PER  
HOUSEHOLD FOR CONVENTIONAL AND  
WET TRANSPORT SYSTEMS, SPRINGFIELD  
SMSA (STANDARD METROPOLITAN STATISTICAL AREA)

Item	Cost	
	Conventional System	Wet Transport System
Refuse collection	\$17.50	\$2.50 <sup>a</sup>
Bulky refuse collection	1.00	2.00
Disposal <sup>b</sup>	3.50	1.00
Sewer maintenance	2.00	6.00-9.00 <sup>c</sup>
Grinding	--	80.00-105.00
Treatment	9.00	12.50
Sludge handling	5.50	8.50
Sludge disposal	0.75	2.00
Annual Total	39.25	114.50-142.50 <sup>d</sup>

SOURCE: Curran Associates, "An Assessment of Wet Systems for Residential Refuse Collection: Summary Report," EPA Contract No. 68-03-0183, March 1974, p. 80. Data are 1973 price estimates for Springfield, Massachusetts.

<sup>a</sup>Collection of nongrindables only.

<sup>b</sup>Assumes landfill of refuse.

<sup>c</sup>Assumes one flushing per year. If four flushings are required, the cost would rise to \$24 to \$36.

<sup>d</sup>Excluding the grinder system costs, total costs would be \$34.50 to \$37.50.

bottom which allows drainage of excess moisture, which would limit applications to dry areas.

One of the major advantages with this intermediate technology is cost. Typically, each unit has averaged \$30-50 without labor in Tanzania applications. Data collected in Taiwan, Korea, and Japan on a vacuum truck and vault system show it operating at one-tenth the cost of sewerage systems (21).

Alternatives to the typical subsurface disposal system. In the area of sewerless devices which receive wastes from individual units for treatment/disposal, "soils information and percolation tests indicate the probability of success or failure of a subsurface tile system. . . . Alternatives to be discussed include: utilization of two subsurface disposal fields [Figure IX.3], individual lagoons [Figure IX.4], above-ground mounds [Figure IX.5], recirculating sand filters [Figure IX.6], aerobic digester units, holding tanks, recirculating toilets, composters, and incinerating units." (39)

Comparison of advanced devices and systems. In Table IX.10 comparison may be made of the six types of devices to be considered. Because of the numerous devices available within each type a narrative comparison would have been lengthy and ineffective. Instead an evaluation of each of the six categories is presented with some of the more successful units being referenced.

Other commercially available devices which could be classified as collection or non-treatment devices, such as freeze toilets, chemical toilets, pit latrines, aqua privies, and water-borne network devices were eliminated from consideration in this report. Vacuum, oil base, and biological waste processing methods were included even though their waste product requires further treatment and/or disposal because the

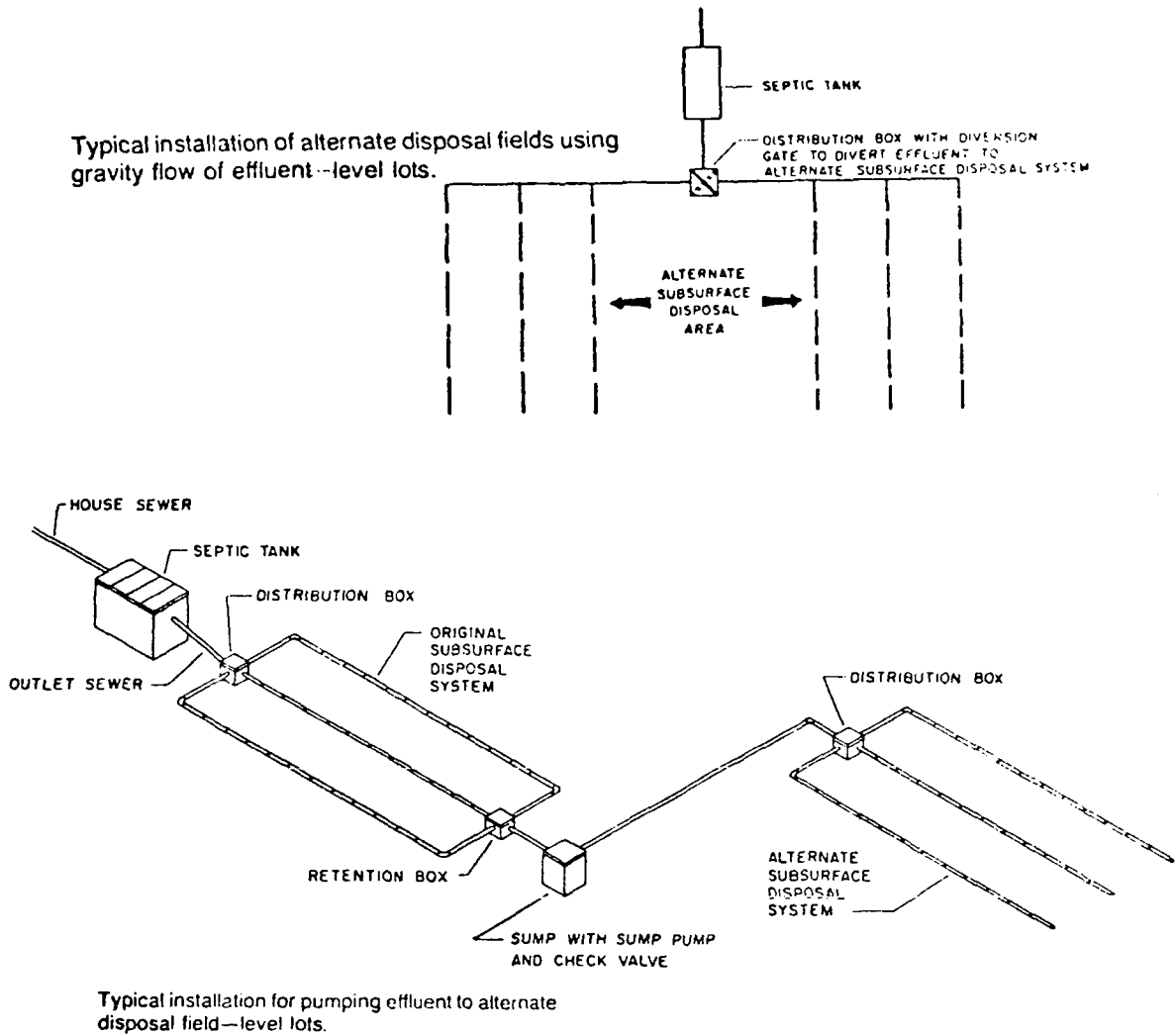

Fig. IX.3. Alternate subsurface disposal fields.

SOURCE: W. F. Taggart et al., Considerations for Designing and Improving Individual Sewage Disposal Systems, Oklahoma State Health Department, 1977.

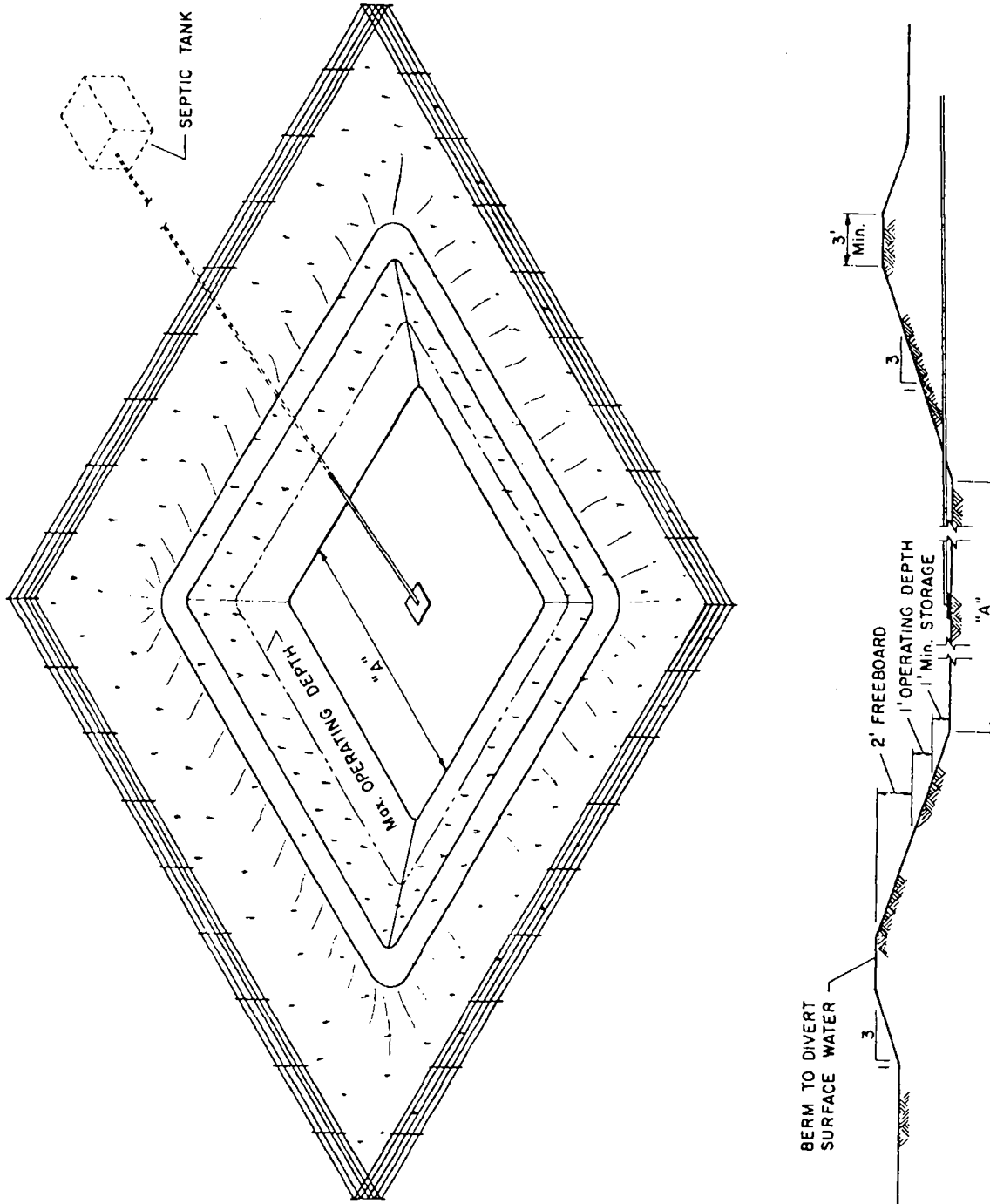

Fig. IX.4. Individual sewage lagoon.

SOURCE: W. F. Taggart et al., Considerations for Designing and Improving Individual Sewage Disposal Systems, Oklahoma State Health Department, 1977.

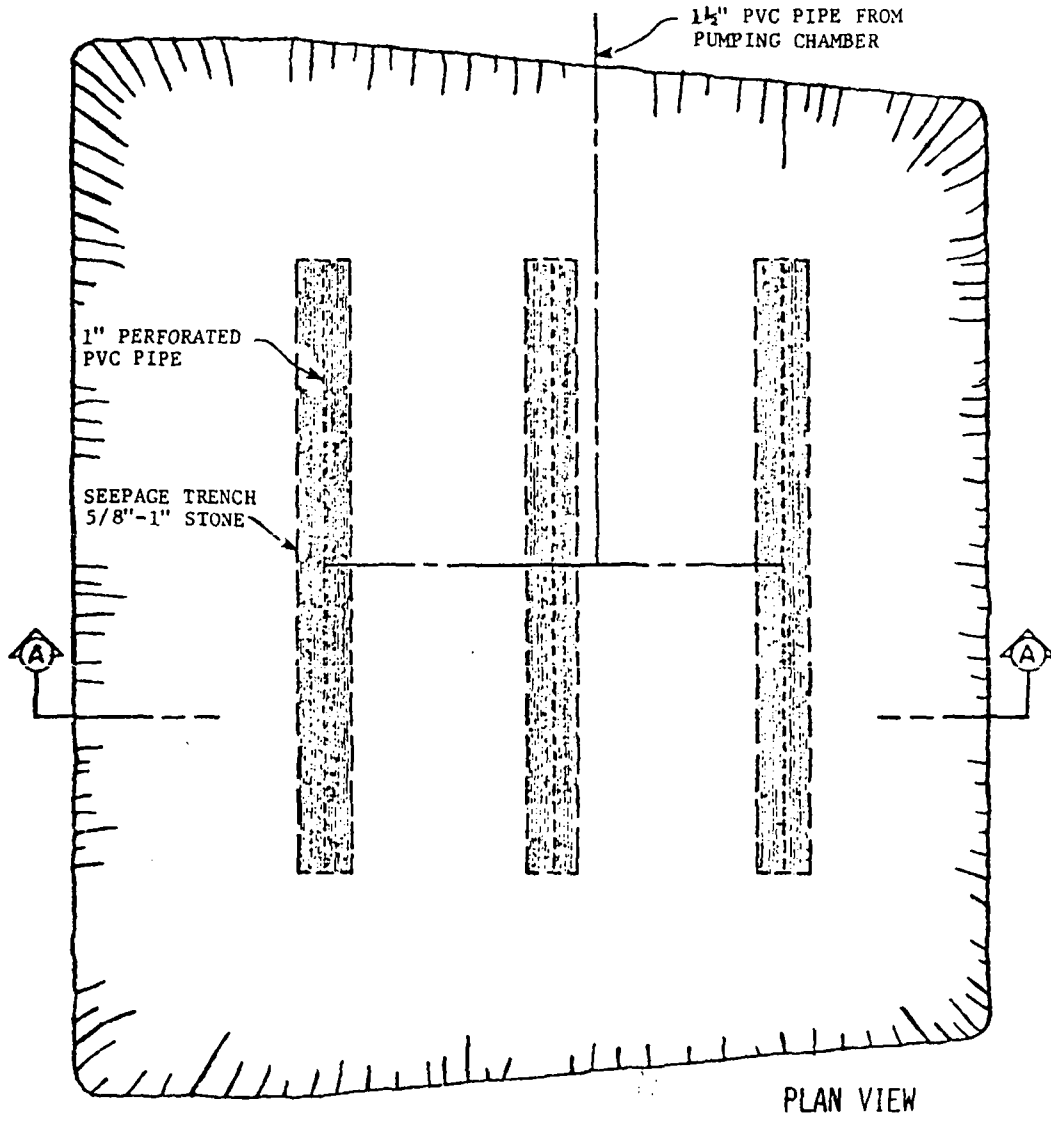
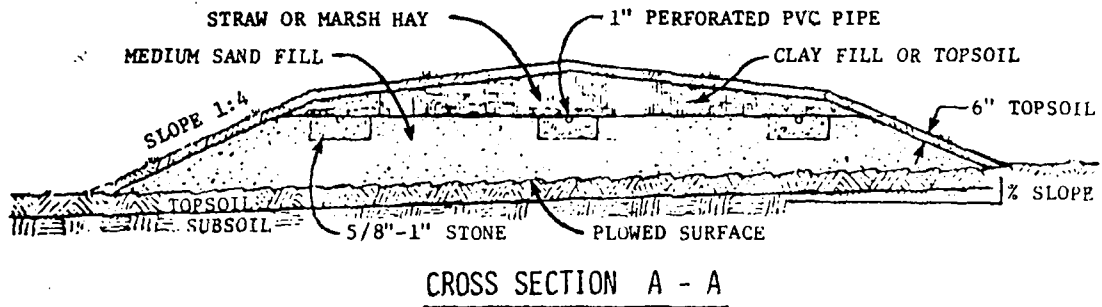
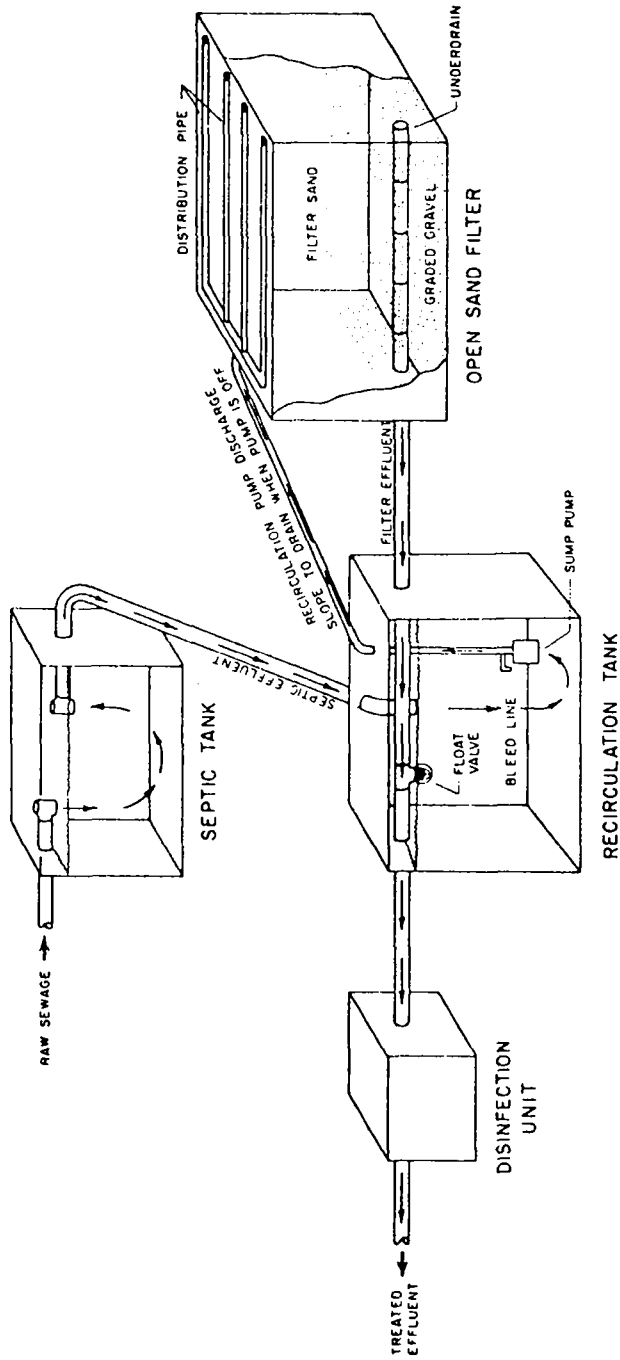

Fig. IX.5. Mound system for a three or four bedroom home.

SOURCE: W. F. Taggart et al., Considerations for Designing and Improving Individual Sewage Disposal Systems, Oklahoma State Health Department, 1977.





Schematic layout of typical recirculating sand filter sewage treatment system

Fig. IX.6. Schematic layout of typical recirculating sand filter sewage treatment system.

SOURCE: W. F. Taggart et al., Considerations for Designing and Improving Individual Sewage Disposal Systems, Oklahoma State Health Department, 1977.

TABLE IX.10  
COMPARISON OF DEVICES AND SYSTEMS

Method	Name	Country	Unit Cost			Operating Costs	Capacity (Persons)	Requirements		Effluent	Primary Application
			0-\$100	\$100-\$500	\$500-\$1000			Over \$1000	Water		
Incinerating	Destroilet	USA				3-5¢/u	4-16	*		A	2nd Home
	Ecett	Sweden		*	*	6¢/u	4-6	*		A	2nd Home
	Electro Standard	Sweden		*	*	5¢/u	4-6	*		A	2nd Home
	Elonette	Sweden		*	*	4¢/u	4-12	*		A	2nd Home
	Incinolet	USA		*	*	5¢/u	4-20	*		A	Industry
	Toarett	Sweden		*	*	8¢/u		*		A	2nd Home
	Xpurgator	USA						*		A	Develop-mental
	Clivus Multrum (Same Name)	Sweden (USA)			*		4-40			S	Home
	Mull-Toa (Biu-Let)	Norway (USA)		*	*		4-40			S	Home
	Saniterm	Sweden		*	*		3-4		*	S	2nd Home
Composting	Toa-Throne	USA		*	*	24¢/day	3-4		*	S	2nd Home
	Farallones Privy	USA		*	*		4-6		*	S	2nd Home
	Kern Compost Privy	Denmark		*	*		4-6		*	S	Rural
	Mulbank (Ecolet)	USA		*	*		4-6		*	S	2nd Home
	Humumat	Sweden (USA)		*	*	6¢/day	2-4		*	S	2nd Home
		Canada		*	*	6¢/day	2-4		*	S	2nd Home
									*	S	
									*	S	
									*	S	
									*	S	

TABLE IX.10--Continued

Method	Name	Country	Unit Cost				Operating Costs	Capacity (Persons)	Requirements			Effluent	Primary Application
			0-\$100	\$100-\$500	\$500-\$1000	Over \$1000			Water	Power	Chemicals		
Composting (continued)	Kombio	Norway			*			*			S		
	Mull-Toa Jumbo	Norway			*			*			S		
	KPS Miljoklosett	Norway		*				*			S		
	Tropic	Norway		*				*			S		
Biological	Cycle-let	USA					4¢/day	*			L	2nd Home	
	Bio-Flo	USA			*			*			L	Portable	
	Jet Flush	UK		*			100/u	*			L	Airlines	
	Monomatic	USA		*			100/u	*			L	Portable	
	Potpourri	Canada				*	50/u	*			L	Marine	
	Craft Toilet	USA		*			200/u	*			L	Marine	
Vacuum	Vacu-Flush	USA			*		4+	*			L	Marine	
	Electrolux Vacuum												
	Sewage System	Sweden				*	4+	*			L	Recreat.	
	Airvac	USA						*			L	Commun.	
	Envirovac	USA				*		*			L	Commun.	
Aerobic	Lectra/San	USA					3-5	*			L	Marine	
	Digestomatic	USA						*			L		
	Aerobic Home System	USA						*			L		
	Sewerless Toilet	USA				*		*			L		
Waste Tamer	USA						*			L			

TABLE IX. 10--Continued

Method	Name	Country	Unit Cost				Operating Costs	Capacity (Persons)	Requirements			Effluent	Primary Application
			0-\$100	\$100-\$500	\$500-\$1000	Over \$1000			Water	Power	Chemicals		
Aerobic (Continued)	Microx	USA					4-25	*	*	*	L	Home/Indus.	
	Cromaglass	USA	*				6	*	*	*	L	Home	
	Flo-Thru	USA			*	*	5-500	*	*	*	L	Home/Indus.	
	Bio Disc	Canada			*	*	8	*	*	*	L	Home	
	Aquarobic	Canada			*	*							
Oil Base	Magic Flush	USA			*	*	4+	*	*	*	L	2nd Home	
	Aqua Sans	USA			*	*	4+	*	*	*	L	Recreat.	
	Sarmax	USA			*	*	4-6	*	*	*	L	Home/Rec.	

u = use. A = ash; S = solid; L = liquid.

final product is in a concentrated form which is contained and therefore more easily disposable.

The newer methane plants were not included because the technical considerations of air emissions and the size of operation required for profitable development would not be conducive for their consideration in unsewered low density areas. The initial investment in such plants is large, but continuing operation expenses are small so that methane plants are more suitable for larger permanent sites.

Units with greater capacity on the average cost more than those which are for only three or four persons, though the per person cost was less. Many units were limited to only three or four persons by the design. The more complete waste treatment devices were more expensive with the incinerating and aerobic devices lying in the higher cost range.

All the waste processing methods require some form of energy with the exception of a few composting devices. The amount of energy is dependent upon the method with the incinerating and aerobic methods being the highest consumers. Efficiency of the individual unit produced some variation but to a lesser degree. Comparable treatment processes were found to be competitive.

The most successful devices would have to be termed the most reliable with the exception of developmental ones. Since the treatment of the waste is on-site, failures have resulted in immediate sales losses in the respective marketing areas. U.S. manufacturers have purchased patents as they became available from other devices resulting in products with greater reliability.

The devices examined have aimed at two primary markets, namely, the vacation home or recreation market and the industrial market, where conditions have warranted a waste processing method for on-site treatment. Both markets have been willing to pay the slightly higher price required in the developmental stage. Recent developments indicate a broader application is foreseeable with a substantial cost reduction implied by mass production methods.

The user has accepted these various methods of treatment on-the-job or vacationing as circumstances have required. There are at least an estimated total of 200,000 units in present day use.

Advanced systems. Advanced methods of sewerless treatment have been classified into five categories: Incinerating toilets, composting toilets, biological toilets, vacuum systems, and aerobic tanks. A sixth category, oil-flush toilets, are finding increased application in remote areas. An ever-expanding list of manufacturers are supplying and promoting units in these categories.

A major concern which has been expressed about sewerless treatment is the energy requirement. Units within any of the six categories have varying energy requirements depending on the climate and their capacity and specific treatment process. The composting variety can be operated without electricity in some instances.

The major advantage with these systems, with the exception of the aerobic tanks, is the decrease in water consumption. By U.S. standards this would equal approximately thirty to forty percent of domestic use. Some other advantages are that composting toilets produce a humus product suitable for fertilizer while incinerating toilets destroy the waste material leaving an inert ash residue. Most of the toilets can

be installed in existing dwellings, although two of the composting toilets do require two story structures or raised dwellings.

Many of these systems require a gray water disposal system. Gray water is the discharge water from the bath, kitchen, and laundry which usually contains soaps, fats, and viruses from the skin and clothes.

Incineration of waste represents a waterless, sanitary method which produces an inert ash that is easily disposed of with no detrimental environmental effect. Over 15,000 units are now in operation in the United States.

Composting as a method for decomposition of animal and human waste to provide fertilizer has been in practice for centuries. A container is used to catch the waste together with additions of garbage. Air is circulated through the mass, and in some circumstances manual stirring is required and heat is added in order to maintain a normal temperature range or to speed up processing. Some difficulty has been experienced with improperly placed heating and wiring systems required for operation in cold climates. The waste is eventually reduced to about ten percent of the original volume and can be removed by a door in the lower portion of the container. Difficulty with this method is experienced when the system is overtaxed or the bio-organisms die off. The fertilizer is high in nitrogen and suitable for use in a varying time frame dependent on the particular device. The largest and most successful marketed composting device is the Clivus Multrum from which the waste product is usually ready for removal in about two years.

Biological processing consists of the addition of chemicals to liquify the solid waste, inhibit biological decomposition, and colorize

the liquid. This type of toilet is currently used in commercial passenger planes. The system uses very little water, and wastes must ultimately be disposed of. Electric power is also required.

Vacuum systems have the advantage of requiring very little water for unit operation, about one quart. This system was developed in 1957 in Sweden and overcomes gravity flow problems. Sewage could be transported up to 640 feet away horizontally and sixteen feet vertically to a collection tank if desirable. Both vacuum and pressure collection systems have been suggested for the central areas of small towns.

The aerobic systems combine the traditional flush toilet with aerobic decomposition rather than with anaerobic or septic tank treatment. These systems may or may not be recirculating ones, but the principle is to aerate the liquid to aid in decomposition before injection into a tile field. In a recirculating system odors develop when the system is overused or not used for a few days. These aerobic devices have been very successful in the replacement of septic systems which have failed because of soil conditions.

In oil base type methods a non-water soluble fluid is substituted in a water-tight tank and recirculates in one or more toilets after a separation process. Eventual breakdown of the liquid occurs after one year or sooner depending upon use. Some color problems have been experienced in the otherwise odorless colorless fluid. This type of toilet has been used at several national parks in the United States.

(Incinolet Figure IX.7) (33) This uses heat alone to reduce human waste, both solids and urine, to inorganic, odorless and bacterial-free ash. All models are equipped with a blower which is always on



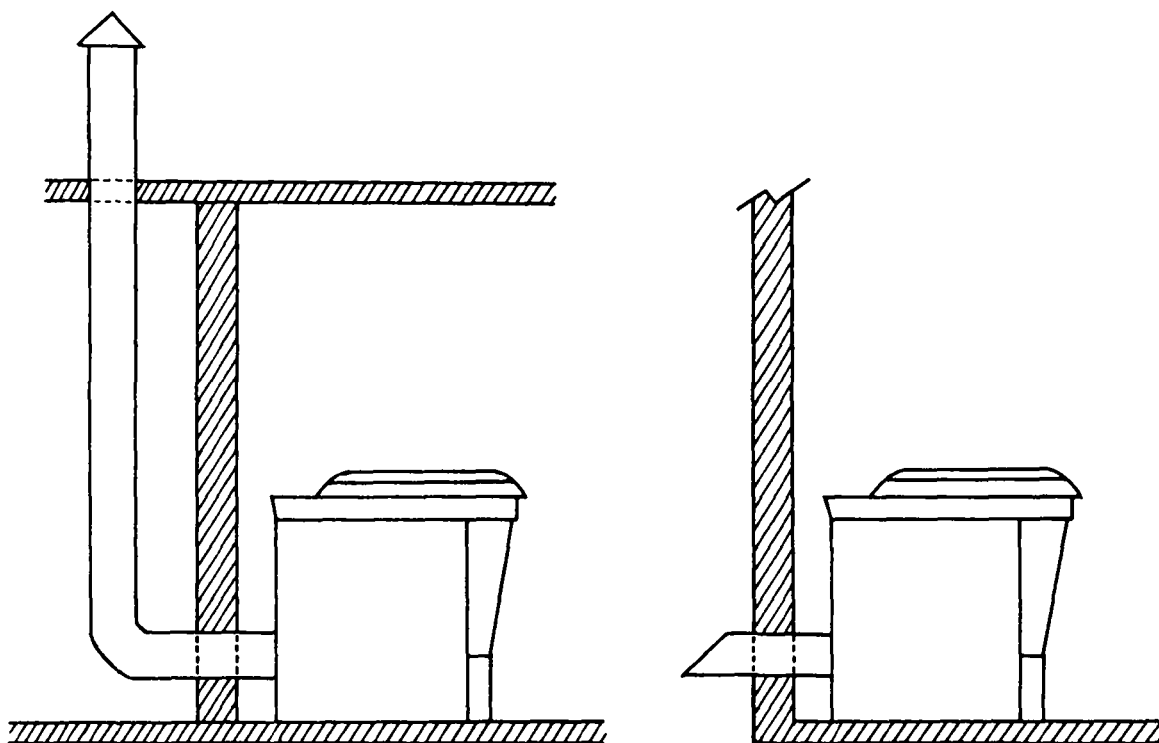

1. Bolt unit to floor.
2. Install ventline.
3. Connect unit to electric power.
4. Put up Bowl-liner Holder with bowl liners inside.

Fig. IX.7. Incinolet installation.

SOURCE: Research Products/Blankenship, 2639 Andjon, Dallas, Texas 75220.

when the heater is on. After the heater cuts off, the blower stays on until the incinerator chamber cools to room temperature. Moisture and other vapors driven off during incineration are vented to the atmosphere by the blower and vent line. Residual ash is accumulated in an ashpan located at the bottom of the unit and is emptied once or twice monthly. The user drops a wax-vapor liner into the bowl prior to use. The liner prevents the waste from contacting the bowl surfaces. After use the Incinolet is flushed by stepping on a foot pedal, and the incineration cycle is actuated by the flushing action.

A catalytic odor control device is associated with the heater. The catalyst, when heated, causes the odor molecules to degenerate into other types of molecules.

(RSC Xpurgator, Figure IX.8.) (34) Cost: \$2,000. The unit is a screening and incineration unit. It involves the moving of the sewage to a filtration area. Solids are removed by deposit on a moving porous medium through which the aqueous medium passes to a filtered liquid accumulator. The porous medium carries the deposited solids through a thermal chamber where the deposited materials are destroyed. All fluids are chemically disinfected and deodorized.

The Xpurgator system filters, sanitizes and recirculates flushing water, separates solids and destroys them thermally without odors or fumes. Fluid amounts are automatically controlled with excess fluids being thermally vaporized.

The Xpurgator II system is built to provide maintenance-free operation. The only service required is infrequent removal of ash from the ash receptacle conveniently located at the side of the unit.

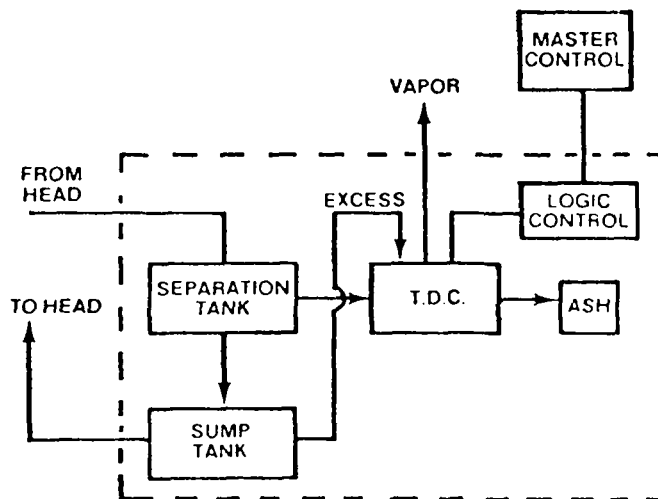
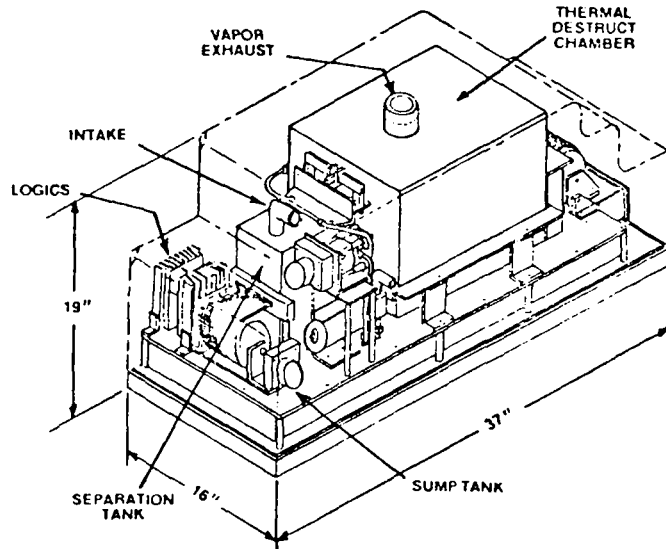

Fig. IX.8. Expurgator II.

SOURCE: RSC Industries, Inc., 245 West 74th Place, Hialeah, Florida 33014.

(Destroilet, Figure IX.9.) (18) The Destroilet is an incinerator enclosed in a functional housing. It disposes of wastes by way of a gas flame that operates automatically only after the lid has been closed. It has the capacity to accommodate the toilet facility needs of twelve people for up to approximately sixty individual uses per day. Operation of the Destroilet is automatic. Raising the seat winds the timer, lifts the heat shield and actuates a forced draft system which draws air through the lid. Then, the timer begins its cycle, the heat shield is lowered, the burner is started. The burn cycle is followed by a cool down cycle.

Destroilets operate on either natural or LP (liquified petroleum) gas. Installation amounts to simply connecting the gas supply pipe, attaching an outside standing vent, and connecting a source of electricity. Residential models require either 115 or 220-240 volt AC household electricity, and mobile models require 12 volt DC battery electricity.

(Clivus Multrum, Figure IX.10 and Tables IX.11-12.) (8) Cost: approximately \$1500/installation. This composting device can function without an external supply of energy or maintenance. It is an organic waste treatment system. Developed by Rikard Lindstrom some thirty years ago in Sweden for his house on one of the fingers of the Baltic, this system employs the principles of gravity, natural draft, and unaided microbial decomposition processes. The container is nine feet long, four feet wide, and five feet high, large enough to hold all the organic wastes of a family for several years while the waste decomposes. It can be located either in a basement directly below the toilet and garbage inlet, with gravity-feed by means of vertical pipes, or it can go

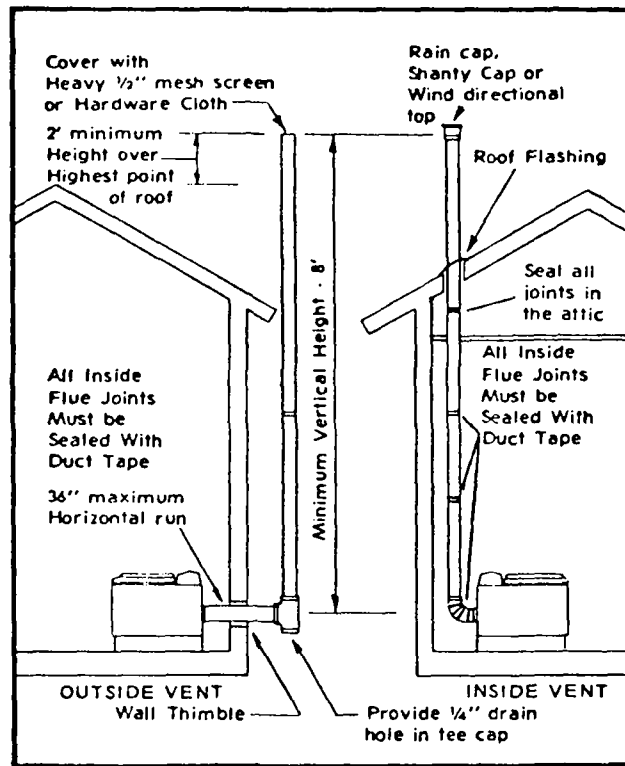

Fig. IX.9. Destroilet, venting schematic.

SOURCE: La Mere Industries, Walworth, Wisconsin 53184.

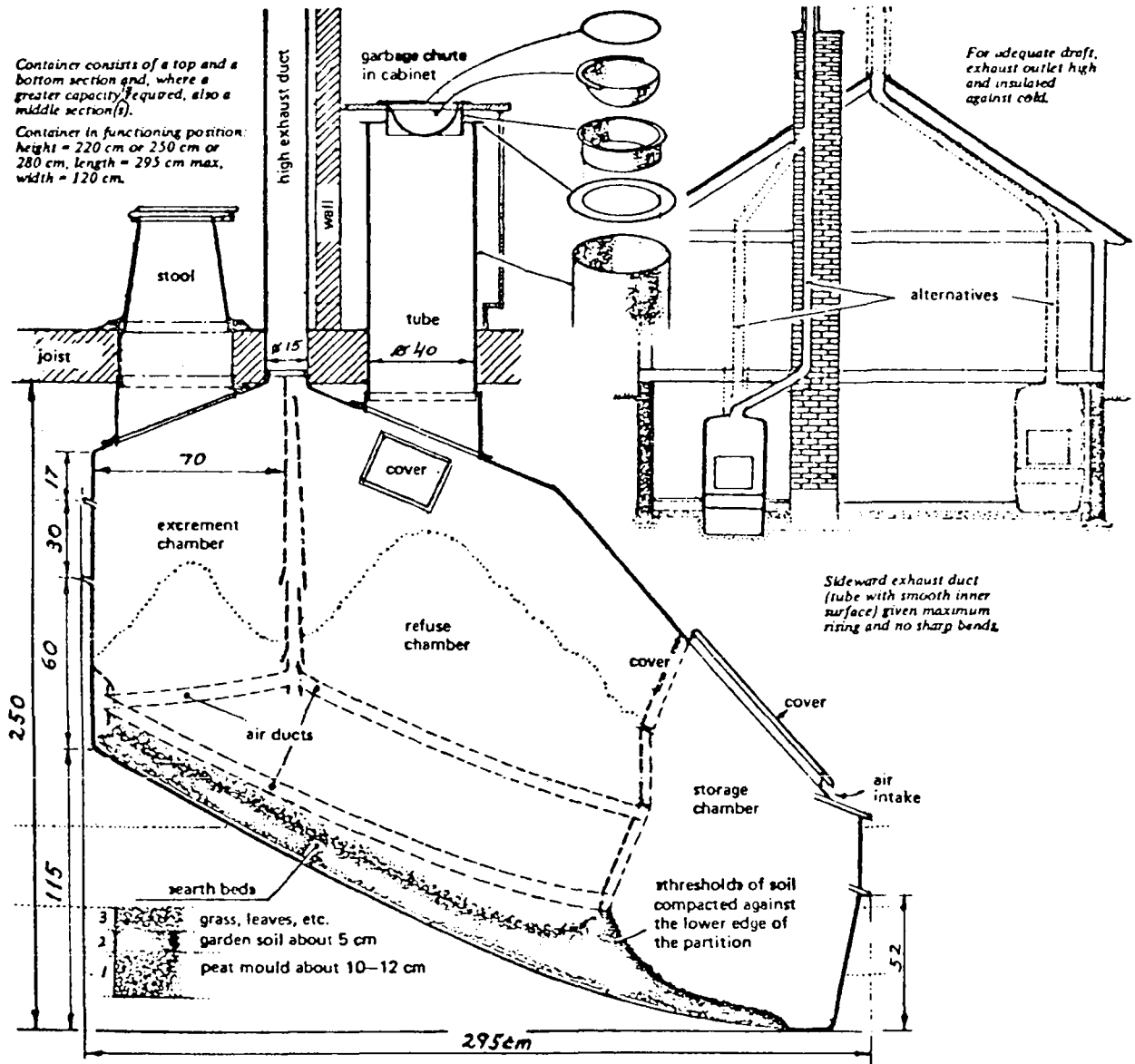

Fig. IX.10. Clivus Multrum.

SOURCE: Clivus Multrum USA, Organic Waste Treatment System, 14A Eliot Street, Cambridge, Mass. 02138.

TABLE IX.11  
COST DETAIL, CLIVUS MULTRUM SYSTEM

	List Price	Community,	Costs
	Single Unit Sale	Each Home	300 Homes
I. Toilet and garbage waste system:			
Multrum tank, small . . . . .	975	300	90,000
Garbage inlet assembly . . . . .	75	40	12,000
Pipes for garbage assembly . . . . .	27	14	4,200
Pipes for ventilation system . . . . .	60	30	9,000
Ventilator roof cap . . . . .	18	14	4,200
Ventilator fan . . . . .	37	30	9,000
Total equipment costs . . . . .	1192	428	128,400
Freight and handling . . . . .	70	20	6,000
Installation . . . . .	300	200	60,000
II. Conveyor system for one-half of homes:			
Horizontal conveyor systems parts . . . . .	400	300	45,000
Installation . . . . .	200	100	15,000
Sub-total . . . . .	2162	1048	254,400

TABLE IX.11--Continued

	List Price Single Unit Sale	Community, Each Home	Costs 300 Homes
III. Greywater pre-treatment system ( $\frac{1}{2}$ of homes)			
Trickling filter . . . . .	300	150	23,000
Pipes to connect . . . . .	150	100	15,000
Installation . . . . .	150	100	15,000
Sub-total (greywater treatment system)	600	350	53,000
Total installed cost	2762	1398	307,400
Average cost per home (installed) . . . . .			1,024

SOURCE: Clivus Multrum USA, Organic Waste Treatment System, 14A Eliot Street, Cambridge, Mass.



TABLE IX. 12  
COMPARISON OF CLIVUS TO CENTRAL SEWERAGE COSTS  
(\$ U.S.)

	Groveland, Mass.		Peperell, Mass.	
	Total Costs	Local Share Costs	Total Costs	Local Share Costs
Number of homes served	500	500	300	300
Construction costs:				
Treatment plant	1,170,000	117,000	2,480,000	248,000
Interceptor sewers	2,904,000	290,400	806,000	80,600
Lateral sewer lines	1,905,000	1,905,000	1,133,000	1,133,000
Total construction costs	5,979,000	2,312,400	4,419,000	1,461,600
Cost per home served	11,958	4,624	14,715	4,867
Comparable cost of Clivus Multrum system				1,024
Percentage saving--Clivus Multrum				79%

SOURCE: Clivus Multrum USA, Organic Waste Treatment System, 14A Eliot Street, Cambridge, Mass.

in the ground outside the house and be fed by a horizontal spiral conveyor powered by a small motor.

Because of the inclination of the floor of the container and the air flow through the mass, no turning of the wastes is necessary. As the bacteria doing the decomposing are naturally predacious on most organisms harmful to people, the humus produced is safe to use in vegetable gardens.

There are never any odors in the bathroom or kitchen because of the draft caused by negative pressure in the tank which carries them away through a vent. The kitchen garbage, which is mostly carbon, contains the energy which the microorganisms (occurring naturally in the wastes) use to do the work of conversion.

(Toa-Throne, Figure IX.11.) (14) Cost: \$1190.00, complete unit. The Toa-throne is a composting device which has the capacity to accept both body waste and organic garbage for a family of from four to six people. At less than 45<sup>o</sup>F the decay process stops and it may be necessary to insulate the unit and to heat the incoming air in certain climates. If the device is used only occasionally during cold weather, a heat source is not required. The micro-organisms will become active again as soon as the temperature rises.

For the technique of the process, see Figure IX.11.

1. Body wastes and garbage enter the container through the toilet stool.
2. An electric blower draws in air to carry evaporated liquid from the container. Where no electricity is available, invection created by heat from the process is used for ventilation. Gases and evaporated liquids are then conveyed to the outlet above the roof by a ventilation tube. Therefore, no odor from the container penetrates into the room.
3. Longitudinal distribution conduits loosen up and prevent the waste material from packing together. This insures thorough aeration of the entire mass.

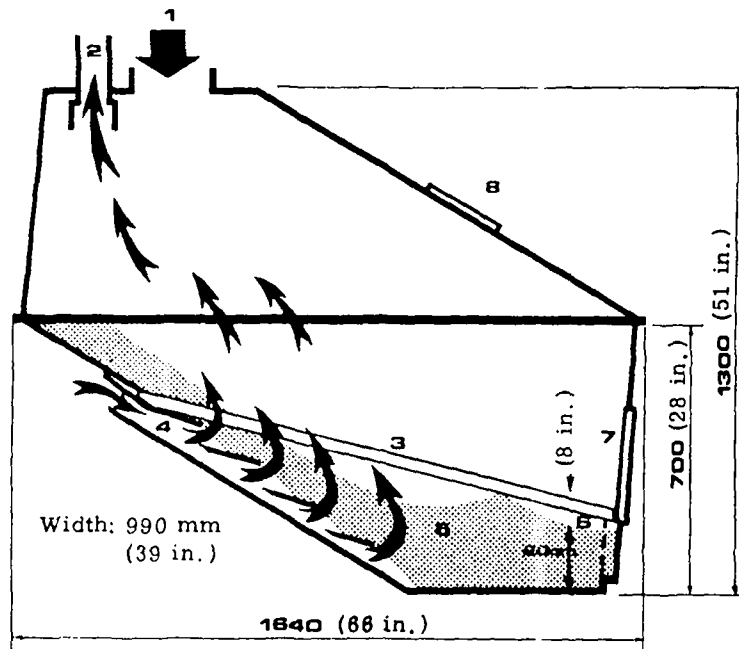

Fig. IX.11. Toa-Throne decay container diagram.

SOURCE: Enviroscope, Inc., Introducing Toa-Throne Aerobic Decay Toilet: A Natural Method of Waste Disposal. P. O. Box 752, Corona del Mar, California 92625, 1975.

4. An "air staircase" allows the air to penetrate the decay bed from below. The stairs are inclined downwards and cannot be obstructed. Thus, fresh air is continuously circulating through the refuse mass. After it passes through the decaying matter, it is drawn off with the gases and evaporated liquid, exiting through the roof vent. (Patent applied for on air staircase.)
5. The waste ends up on an initial bed of peat moss and compost soil or bark humus. This bed is prepared only once. The micro-organisms are continuously propagating, therefore, there is a new bed constantly forming as the first one decays.
6. As the micro-organisms decompose the waste, it is transformed into what is called humus at the bottom of the container.
7. The humus is removed through the access door from one to three times per year, depending upon the size of the household. It should be placed on a compost heap for six months prior to use in gardening as a precautionary measure.
8. Inspection opening. (14)

The first removal of decayed matter takes place after one and one-half to two years from the initial installation. There will be approximately sixty pounds of humus per person per year.

(Ecolet, Figure IX.12.) (29) The Ecolet is a composting device which is made of polystyrene plastic. Additional heat is provided by heating coils located inside the unit. Oxygen is forced through the pile by an electric fan that draws air from an intake located at the bottom of the Ecolet and exhausts it through a wall or ceiling vent. Moisture is added to the waste pile through urine, and mixing human waste with paper and small amounts of kitchen scraps occurs naturally as the Ecolet is used. At the time the Ecolet is installed, a layer of peat moss--approximately twenty pounds furnished with the unit---is spread evenly over the heating coils.

At the beginning, waste builds up rapidly, but decomposition begins at once. Within a short time the waste level diminishes and remains constant. The bottom layer of the waste deposit should be periodically scraped down through the heating coil into the collecting tray. The emptying of the tray should be done when the unit has not been in use for some time. After a year of normal use, an odorless, powder-dry

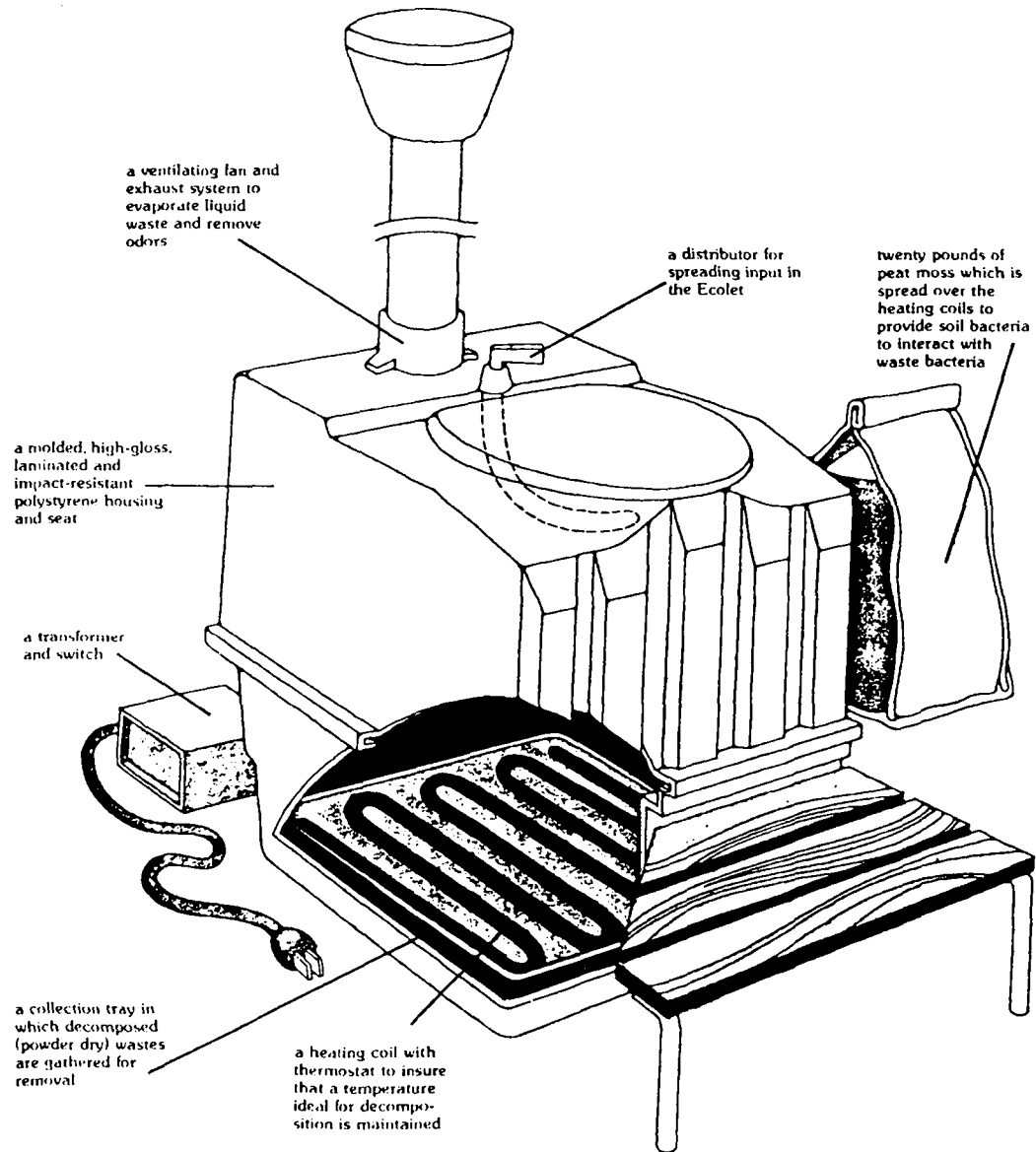

Fig. IX.12. Ecolet.

SOURCE: Recreation Ecology Conservation of the United States, Inc., 9800 West Bluemound Road, Milwaukee, Wisconsin 53226.

residue is removed from the collecting tray at the bottom of the unit and may be used as a fertilizer. If the unit is unused for a period of two weeks or more, it may be necessary to add one or two quarts of water to the waste material. In winter the pile of waste freezes, and the process of decomposition goes into a state of suspension. After thawing, the process begins again.

The Ecolet is thirty-two inches high, weighs less than 100 pounds and requires a floor space of twenty-four inches by forty-two inches. It should be installed in as warm a place as possible. For year-round, continuous use, the Ecolet is best suited for a family of five or six.

(Vacu-Flush, Figure IX.13.) (20) Cost: \$1400-2000. The automatic Vacu-Flush system operates on the vacuum principle. It is odor free and can flush on less than one pint of water. The Vacu-Flush also has "self pump-out" capabilities at septic tank facilities. The system is designed to meet any present or future pollution control law. In dual head installations, each head has its own accumulator tank thus making it possible to flush both at the same time.

(Lectra/San, Figure IX.14.) (30) Cost: \$200-400. Lectra/San is a compact, flow-through waste treatment system which may be used on ships and which efficiently reduces solids, destroys bacteria, eliminates odors, and lowers the biochemical oxygen demand. No chemicals are necessary since the disinfecting agent is produced as needed by the electrolysis of the seawater used in flushing the toilet. When operating on fresh or brackish water, a small amount of table salt is used as the source of the disinfecting agent. Lectra/San is completely automatic and operates on standard marine batteries.

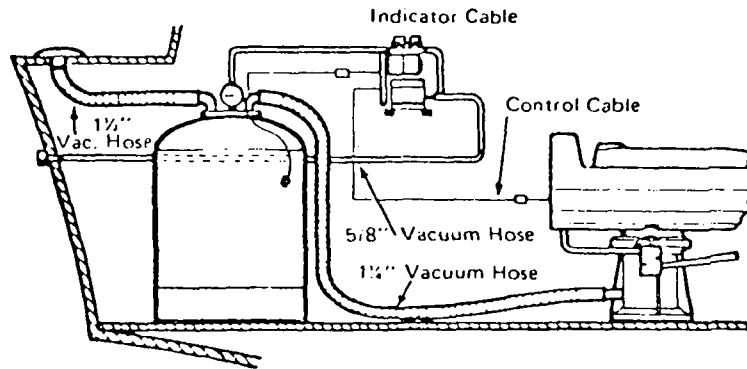

Fig. IX.13. Vacu-Flush.

SOURCE: Mansfield Sanitary, Inc., 150 First Street, Derrysville, Ohio, 44864.

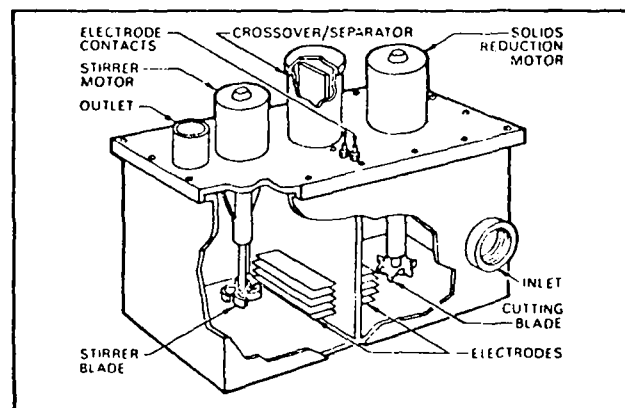

Fig. IX.14. Lectra/San.

SOURCE: Raritan Engineering Co., 1025 North High Street, Millville, N. J. 08332.

The Lectra/San system consists of a two-chambered treatment unit equipped with motors and electrode pack, a control unit with treatment indicator, a logic unit containing relays and the solid state timing circuit, and the salt feed unit. The treatment unit is located between the toilet and the discharge line. It has a total volume of approximately three gallons and is 15" x 8 3/4" x 8 1/2". Overall height, including motors, is 13 inches. The treatment unit is made of tough, chemically-resistant polyvinyl chloride (PVC).

(Magic/Flush Toilet, Figure IX.15.) (26) Cost: 1975--\$3,000; 1976 projected--\$2,000. This sewerless system looks and works like a home toilet, but it uses no water. Instead, a clear, odorless, mineral-derived liquid flushes the bowl. The non reactive fluid looks like water, but unlike water, can be used over and over again. Repeated use of the fluid is made possible by a simple purifier that is part of the underground holding tank. Gravity carries wastes from the toilet to the tank where it stays until a truck hauls it away. At certain Magic/Flush installations a small, 3/4 horsepower gas generator is used to periodically charge the 12-volt batteries that operate the system.

(Chrysler Aqua-Sans, Figure IX.16.) (2) Cost: \$4000. The Chrysler Aqua-Sans systems are designed to use oil as the flushing medium. The density of the oil is some seventeen percent less than that of human waste permitting gravity separation. It is immiscible with the waste and chemically stable under the operating conditions and in the presence of human waste. Four models are available for capacities at 600 gpd, 1500 gpd, 5000 gpd, and 10,000 gpd.

Waste is transferred by the flush liquid from the commodes to the separation tank where the solids are separated and settled in the sump



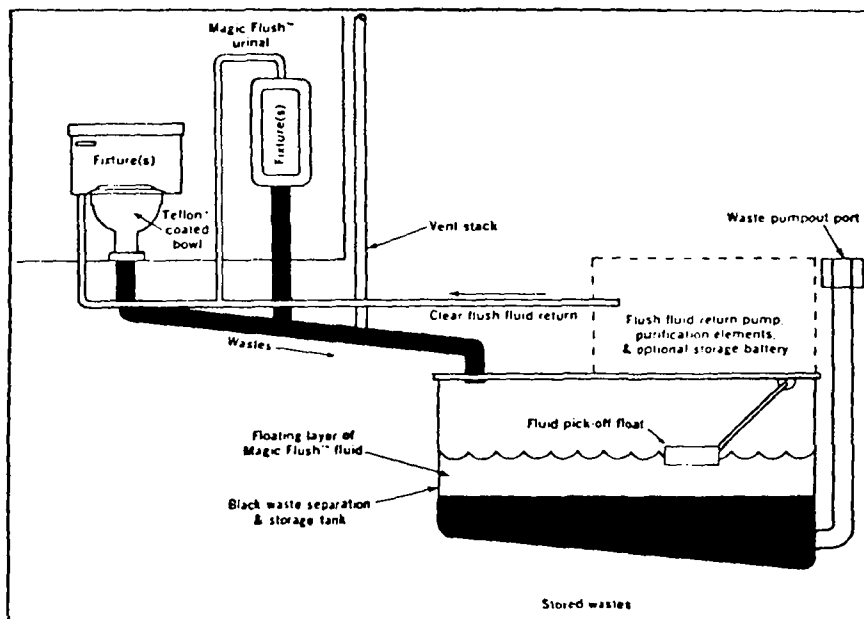

Fig. IX.15. Magic/Flush.

SOURCE: Monogram Industries, Inc., 1165 East 230th Street, Carson, California 90745.



while the flush fluid rises to the top due to the differences in density of the oil and the waste. The flush fluid rises, passing through a coalescer which removes entrained urine, and then flows over a weir through a bag filter into the second stage tank.

Flush fluid is recirculated to the commode by a pressure pump which is activated by a pressure switch. A bladder type accumulator is provided to prevent surges and to meet peak flow conditions. Circulating the flush fluid through a pre-filter, an activated carbon column, and a clay filter, removes fine particles and dissolved contaminants. Bacteria and odor are controlled by the periodic addition of chlorine compounds to the flush fluid.

When sufficient waste accumulates in the sump, it is detected by a waste sensor. This activates the macerator pump which transports the waste to the waste holding tank. The dump switch actuates when the waste holding tank is half full and initiates the incinerator warm-up. Waste transfer start, stop, and incinerator shut down are controlled automatically.

(Sarmax 500 R Series, Figure IX.17.) (23) This system uses an oil-base crystal-clear flushing fluid which is purified and reused over and over again. There is no discharge. The waterlike fluid flushes the waste to a special tank where it separates from the waste. At the same time, a fresh charge of clear fluid is returned to the flush tank passing through the purification unit, emerging crystal-clear and ready for service again. The special tank stores the waste from 7500 uses, or the equivalent of about one year of use in a normal household, before needing to be pumped out. The stored wastes are

233

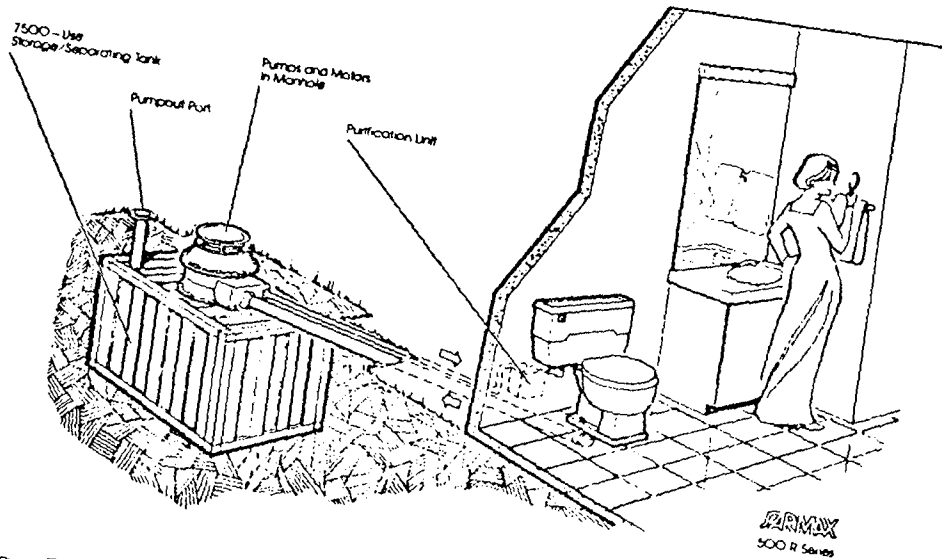

Fig. IX.17. Sarmax 500R Series installed in a home.

SOURCE: Mechanical Engineering, Feb. 1976.

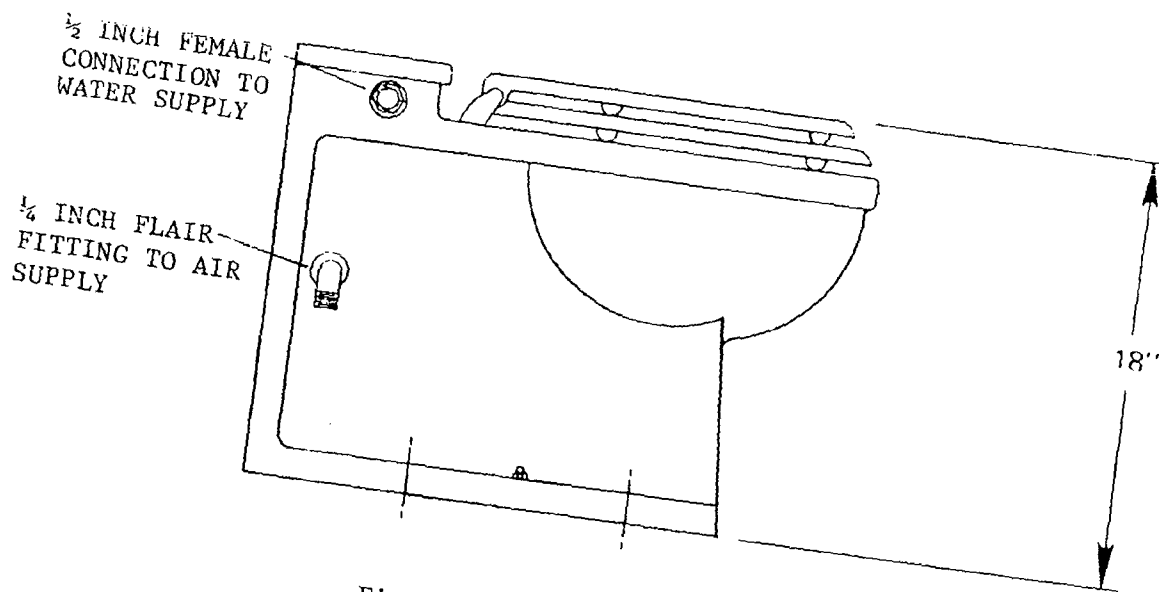

Fig. IX.18. Microphor.

SOURCE: Microphor, P. O. Box 490, Willits, California 95490.

quiescent and odorless, without the addition of chemicals and consequently, the pumped-out wastes can be delivered to treatment plants for final disposal while the fluid remains behind for continued use. Purification units are checked at the time of pumpout and the filter canisters exchanged, if necessary.

The system was designed to minimize maintenance and maximize fail-safe operation. Each fixture is independent of all other fixtures with individual motors, pumps, controls, and purification units. Infrequent maintenance could be accomplished without tools.

(Microphor, Figure IX.18.) (25) The system requires 60-100 pounds per square inch of compressed air and a small amount of water (about 1½ quarts) from gravity flow. The flush button activates a flow of water into the bowl and opens a valve in the toilet. A charge of air ejects waste material into the discharge line, and the valve automatically closes. All Microphor minimum water toilets can be used with any type of sewage treatment system.

#### COST-EFFECTIVENESS ANALYSIS METHODOLOGY

Evaluation criteria for treatment system alternatives. Effectiveness is reflected in the process methods in such terms as reliability, operational simplicity, public acceptability, and adaptability or adoptability. Within the criteria functional to the dynamics of any wastewater system, there are five which are commonly used and should not be ignored. These are: costs, facility requirements, manpower

demands, resource requirements, and time demand. Criteria for selection or evaluation of a potentially successful wastewater treatment system may include such things as the achievement of economic, sociological, cultural, or health-oriented benefits.

(Costs.) Costs, particularly those for typical treatment plants, are available in various forms. Costs beyond the boundaries of centralized facilities are often more difficult to obtain or even estimate due to the complexity of financing and budgeting and the number of various governmental entities included. Recent rises in cost-of-living prices have also affected the values of previous estimates and the financing of matching funds by local governments. Maintenance costs and extensions of services, due to the higher manpower requirements, would by nature show a higher rate of increase. If recent U.S. consumer complaints are an indication, then both construction and maintenance projects are being greatly affected by these rising costs.

Health and socio-economic costs have always been hard to isolate and quantify. Reports of contaminated supplies and consequential illnesses have depended upon awareness, communication, and reporting systems. Remedial or curative treatment have been the significant factors in estimating costs on the reported incidences. Costs which have accrued as direct costs to the individuals and indirect costs to the community and nation have not been as visible as curative treatment costs. These individual and community costs are also cumulative and especially diffi-

cult to obtain for developing countries. Therefore, only an estimate of total costs in terms of health benefits may be obtained in developing countries through use of isolated incidences.

(Facility requirements.) The effluent quality, system size and performance, and the population to be served are very greatly influenced by the previous costs. In addition, the level of acceptable treatment, required dependability, and the number of households which will be reached initially with a wastewater treatment system, will also be dependent upon perceived needs.

(Manpower demands.) Lesser skilled jobs show the most immediate return in terms of manpower/labor dollars while the middle management positions supply the most stability. Management level positions must be obtained through experience and made viable by training, for the economic stability of treatment systems. The differences in manpower structures for developing and developed countries are demonstrated in Figure IX.19.

Water and wastewater should be tied to any available public service (such as electricity) in a developing community until such time as a separate water and wastewater service would be self-sufficient. This is particularly appropriate since some of the same skills are common among utility services. Manpower which can be self-sustaining and/or self-employed must be encouraged. This would include the trades in particular. Training, of course, must be provided for individuals showing initiative in order to establish a self-sustaining service. Self-sustaining manpower is more likely to be found in industrial positions

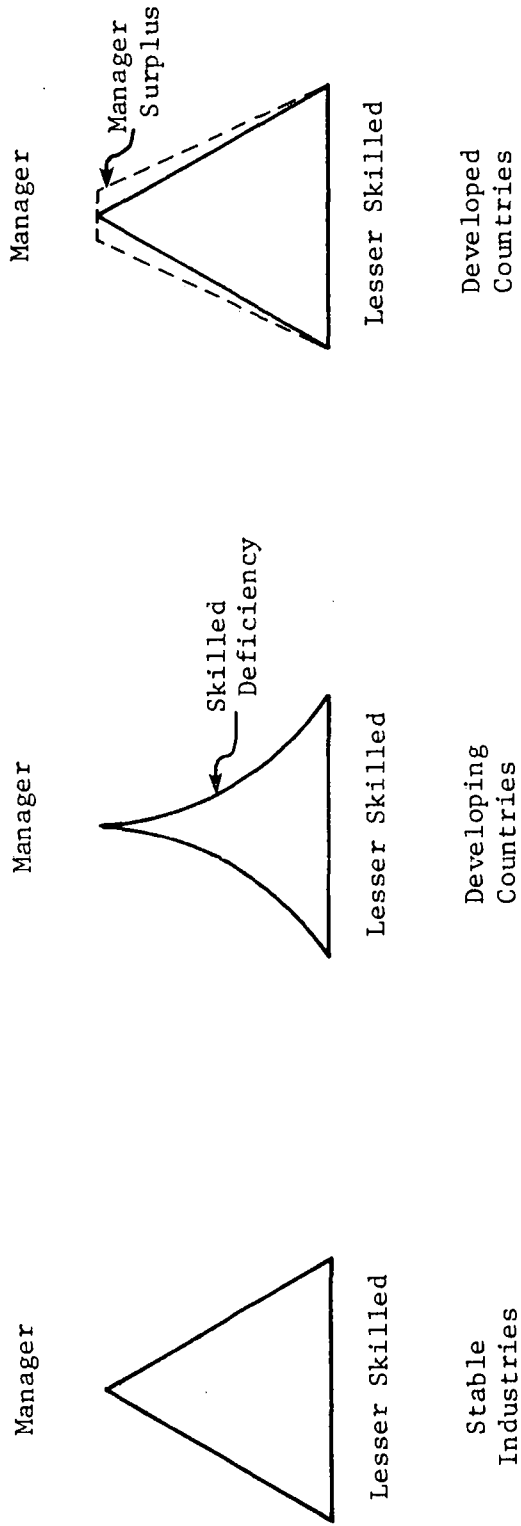

Fig. IX.19. Manpower structures.



where duties include more than one plant. This is true for two reasons: (1) operation of an industrial treatment facility, waste disposal activity, or related maintenance duties are not full time; and (2) retention of manpower, full utilization, and low turnover are industrial requirements for profit making. Manpower in public service occupations has typically received less pay, been utilized on a part-time basis, required more training dollars because of higher turnover, and had less opportunity for economic advancement within the public service arena. These factors have led to the utilization by industry of public service occupations as a training ground for future employees, thus encouraging the cycle of greater public employment turnover and training needs.

(Resource requirements.) The question of local resources and available materials is of major importance. The fact that local resources are available influences the longevity of any system. The ease of obtaining materials and supplies for replacement or system expansion is not just a problem of lesser developed countries but also of developed ones, especially in small communities and rural areas.

(Time demands.) During a health crisis, it is relatively easy to justify a sanitary water supply or waste treatment program on the basis of an existing or clear and present danger to the public health from a hepatitis outbreak. On the other hand, justification, on the basis of improving general health, residential satisfaction and community pride, of the provision of water plus wastewater facilities has limited political appeal, especially because such things are long range.

Most governments will pay much more attention to economically active environments, such as industrial communities, recreational facilities, eating establishments, and transportation services. Environments

which do not show a direct relationship to the economic well-being of the community, that is, long-term efforts which are not self-sustaining, will always be second or extras. Therefore, any effort to undertake long-term efforts must be tied to immediate returns in a step-wise projection of economic benefits in order to facilitate its acceptance.

In the aggregate, resources can be freed up readily for much needed environmental programs in wastewater, as they can be for individual health care problems, but rather in the manner of dealing with a heavily traveled road. Resources can be found to patch the road but not to overhaul the transportation system. To proceed beyond curative or patchwork efforts in establishing adequate wastewater treatments systems requires organization, planning, and allocation of resources within the context of a time frame.

(Health implications.) For those wastewater systems which reduce or eliminate water usage in treatment systems the health implications can only be viewed as beneficial. The role of water as a vehicle for the transmission of bacterial and viral diseases is well established in numerous health publications. Control of water as a vehicle or intermediary transfer agent is necessary for health benefits in whatever system is adopted. Several different patterns of water-related disease transmission are recognized. Table IX.13 demonstrates some of these.

Many studies have shown the health benefits of sanitary facilities vs. no facilities. Two such studies were conducted in rural populations. In the first study, a United States Public Health Service program evaluated the health effects of the installation of basic sanitation facilities in American Indian homes (44). Analyses showed that the morbidity rates of the members of homes equipped with sanitary facilities were

TABLE IX. 13

## WATER AND HEALTH

Role of Water	Disease	Remarks
Major Vehicle for Direct Transmission	cholera diarrhea and enteritis dracontiasis (guinea worm disease) hepatitis, infectious leptospirosis (Weil's disease) paratyphoid fever schistosomiasis (bilharziasis)	Classic example of water-borne disease Symptomatic of many infections and toxemias; often non-specific Ingestion of infected <u>Cyclops</u> (water flea); 50,000,000 active cases 100,000 cases in 1955 Delhi outbreak A zoonosis; ingestion of urine of infected animal Milder than typhoid Requires aquatic snail as intermediate host and water contact, with skin penetration by cercariae, or, less often, their ingestion; over 150,000,000 active cases Major 19th-century U.S. disease
Occasional Vehicle	typhoid fever dysentery, amebic (amebiasis) dysentery, bacillary (shigellosis)	World-wide endemicity Many outbreaks due to cross-connections
Possible Vehicle	poliomyelitis pleurodynia tularemia	Virus is found in sewage Non-fatal; Coxsackie virus A zoonosis; usually direct contact

TABLE IX.13--Continued

Role of Water	Disease	Remarks
Lack of Safe Water or a Clean Environment	All above except schistosomiasis and dracontiasis ancyclostomiasis (hookworm) ascariasis (roundworm) echinococcosis (hydatidosis) enterobiasis (pinworms) mycoses relapsing fever scabies trachoma trichomoniasis typhus fever	Water-borne sanitation best preventive Avoid ingestion Food and drink contaminated by dog feces Personal hygiene Fungal diseases; personal hygiene Louse-borne; poor sanitation Personal hygiene 150,000,000 victims with impaired vision <u>Trichomonas hominus</u> , <u>Giardia lamblia</u> , con- taminated food and drink Louse-borne; crowding, poor sanitation
Vector Habitat	clonorchiasis dengue diphyllobothriasis encephalitis fasciolopiasis filariasis loaiasis malaria onchocerciasis paragonimiasis rift valley fever yellow fever	ingestion of parasitized fish mosquito ingestion of parasitized fish mosquito ingestion of water chestnuts containing cercariae mosquito aquatic fly ( <u>Chrysops</u> ) mosquito aquatic fly ( <u>Simulium</u> ) ingestion of parasitized crabs and crayfish mosquito mosquito
Carrier	chemical poisoning radiation exposure	Natural and polluted waters; acute and chronic Cumulative

significantly lower than the morbidity rates of members of homes without such facilities for the two years during and after construction. There had been no significant difference between the two types of homes before the installation of the facilities.

A second study involved an extensive investigation among sixty-two rural communities (including eleven coal mining camps in eastern Kentucky) for the purposes of developing specific environmental control measures against diarrheal diseases (35). It was found that the lowest rates of prevalence of Shigella and Ascaris occurred among families served by complete facilities (Table IX.14). A marked variation was demonstrated by the accessibility of the facilities.

In a recent study about the separation of grey water from black water the following figure (Figure IX.20) was developed to demonstrate the average daily household water use in the United States (36). Results of the study showed that grey water has potentially a much lower pathogenic and virus contamination than black water. Black waters were also shown to contain the majority of nitrogen and suspended solids in addition to significant quantities of BOD<sub>5</sub> and phosphorous, as well as the majority of pathogenic organisms.

(Cultural Implications.) Acceptance of change in human habits regarding sanitation practices has always been a slow and difficult process. Various methods have been used by decision makers to stimulate such acceptance when change has been deemed important for human health. Stimulants have typically been in the form of education, training, examples and/or sample experiences. These methods have consistently required a long-term commitment of manpower and/or financial resources.

TABLE IX.14

PREVALENCE RATES FOR SHIGELLA BY DATE AND BY SELECTED  
SANITARY FACILITIES IN KENTUCKY, CALIFORNIA, AND GEORGIA

Sanitary Facilities	Kentucky <sup>a</sup> 1954-56		California <sup>b</sup> 1952-53		Georgia <sup>c</sup> 1949-52	
	No. of Cultures	% Positive	No. of Cultures	% Positive	No. of Cultures	% Positive
Water and Flush Toilet inside Dwelling	5,017	1.1	985 <sup>d</sup>	1.6	2,988	0.4
Water inside Dwelling Privy Outside	2,195	2.4	688	3.0	5,392 <sup>e</sup>	2.2
Water and Privy outside Dwelling	3,994	5.9	4,438	5.8	5,586	5.0
Water on Premises	1,988	5.8			2,791	4.1
Water off Premises	2,006	6.0			2,975	5.8

SOURCE: D. J. Schliessman et al., "Relation of Environmental Factors to the Occurrence of Enteric Disease in Areas of Eastern Kentucky," USPHS Monographs, no. 54 (1958).

<sup>a</sup>Cultures from preschool children.

<sup>b</sup>Cultures from children ten years and younger.

<sup>c</sup>Cultures from children of unspecified ages.

<sup>d</sup>Water and flush toilet and/or shower inside dwelling.

<sup>e</sup>Single source of water only inside dwelling.

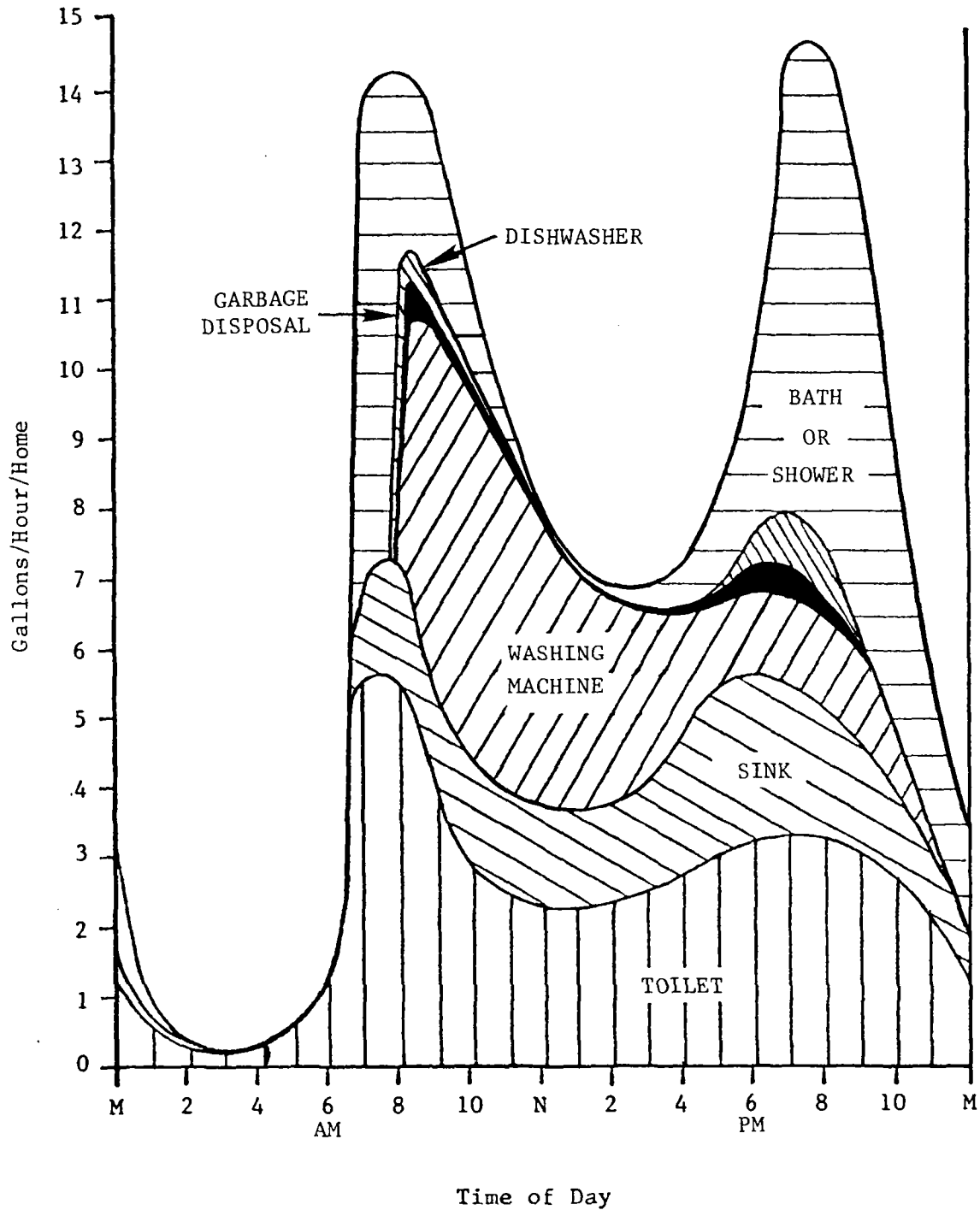

Fig. IX.20. Daily household water use.

SOURCE: Siegrist, Robert. Segregation and Separate Treatment of Black and Grey Household Waters to Facilitate On-site Surface Disposal. Madison: University of Wisconsin, November 1976.

The ease with which reorientation to a new treatment may be made should be of influence in its selection.

(Social Concepts.) One of the greatest problems in assessing social concepts is the assignment of a numerical and/or quantitative value to qualitative measures of human perceptions and attitudes. This type of analysis is performed by taking a population whose choices are ranked from high to low, best to worst, or as positive and negative impacts for the purpose of demonstrating the relative differences of such rankings or ratings among the population. Common applications of this form of rating are frequently printed in such indices as the Gallup Poll. From such an analysis values can be assigned which will portray a multi-dimensional scaling so that the relative values of social change can be measured for a proposed project. Limitations to the amount of variance, interactions among the social levels, and problems in the selection of the most appropriate parameters can reduce the benefits of this sort of analysis.

Rating of disposal methods according to weighted criteria. In Table IX.15 comparison is made of wastewater disposal methods for rest areas using selected criteria. For each criterion, the eight disposal methods are ranked most advantageous to least advantageous, from eight to one or ten to three depending on the weight given that criterion. The total score is summed for each process, and the process with the largest sum receives first place in the overall ratings.

#### COST-EFFECTIVENESS GUIDE

This guide has been prepared as a reference or aid for use in selecting appropriate wastewater treatment systems in developing



TABLE IX.15

RATING OF WASTEWATER DISPOSAL METHODS  
USING CRITERIA RANKING AND WEIGHTING

Disposal Method	Simplicity	Provides Entire Treatment and Disposal Required	Treatment or Disposal Effectiveness, in Practice	Aesthetic Qualities, in Practice	Effect of Weather Extremes	Accommodate Load Fluctuations	Accommodate Extreme Loadings	Suitability for Use in Most Rest Areas	Cost	Corrosion; Vandalism; Hazards	Acceptability to Regulatory Agencies	Local Pollution Possibility	Summation Criteria Ratings	Rating
Chemical toilet	7	5	8	1	5	4	4	1	7	2	6	6	56	5 <sup>a</sup>
Holding tank (dry)	8	4	6	2	8	5	7	7	8	5	7	7	74	3 <sup>a</sup>
Septic tank system	6	8	4	3	7	6	5	4	4	8	8	4	67	4
Ponds (evaporative)	5	7	9	5	4	8	8	5	5	7	9	5	77	2
Recycle and holding tank	4	6	10	8	6	7	6	8	6	6	10	8	85	1
Physical-chemical treatment	2	3	5	7	3	2	3	3	2	3	4	3	40	7
Biological treatment (package)	3	2	7	6	1	3	1	6	3	4	5	1	42	6
Proprietary processes	1	1	3	4	2	1	2	2	1	1	3	2	23	8
Weight assigned criterion	8	8	10	8	8	8	8	8	8	8	10	8	100	

SOURCE: Sylvester et al., Rest Area Wastewater Disposal Study.

<sup>a</sup>These methods are unsuitable for most major rest areas.

countries. It is not intended to supplant the need for engineering or health consultants in the actual selection of appropriate facilities. Its particular value should be found in waste problem areas of unserved population not amenable to sewerage. It is intended to encourage environmentally sound policy planning in developing countries.

Sewerless treatment systems occupy part of the waste disposal facilities market in several countries. Extensions of conventional systems into communities with a population of less than 10,000 has sometimes required 100 percent financing. These extremely high-cost projects are functioning with government support while less costly replacement alternatives continue to be sought. Changes have taken place in the last five to seven years which have led international engineers and health officials to seek alternative technology because the rate of sewerage construction has fallen behind world population growth.

Over 200,000 sewerless units have been sold in the last ten years in the United States, thus demonstrating their effectiveness, appropriateness, and acceptability. (It would be arbitrary to limit the systems in their effectiveness evaluation because of state and federal regulations or a lack of recognition on the part of users.) Reluctance among federal officials to accept new technology in on-site units will fade as their public acceptance increases. That reluctance has obviously lingered in part because of the difficulty in administering to individual households federal funds granted on a regional basis. Growing state responsibilities in the functional application of federal program grants and surveillance activities should also increase the potential for on-site facilities funding. Heretofore the sewerless systems were merchan-

dised for vacation homes, isolated residential areas, industries, and public transportation carriers (such as railroads and airplanes), and these are markets which are usually financed by private lending institutions or other agencies than those that traditionally finance conventional wastewater treatment type activities.

With reference to developing countries the following assumptions can be made:

1. Sewered and centralized sewage treatment may not be the solution to all needs in every city or community.
2. This is particularly true of the needs in large cities which are as yet unsewered.
3. An alternative to the sewerage system and central plant concept is the on-site treatment plant. This may vary from hydraulic and biological systems to those requiring energy.
4. The selected alternative may not be constrained by lack of energy since various programs have sought to provide electricity in these areas.
5. Nonstructural solutions should include at least three management approaches:
  - a. private enterprise,
  - b. private enterprise for unit construction and public for installation and management,
  - c. public management and process manufacturing.
6. Both on-site as well as aggregate systems may be used.

Manufacturing cost analysis. A representative group of manufacturers were approached to obtain specific information about their products.

Detailed cost figures were subsequently developed for Destroilet and Toa-Throne units. From the information supplied by the manufacturer as well as other sources, it appeared that under production levels at low volume, the manufacture of Destroilet units resembles the vacuum cleaner manufacturing industry (Table IX.16). The Destroilet plant manager described their assembly operation as labor intensive. For the Destroilet, projections of high production levels were estimated to be similar to those for electric housewares and fans manufacture. Thus through comparison with the figures for the stated industries which are given in Table IX.16, the estimated cost figures were derived for the Destroilet and are given in Table IX.17.

The evaluation of the Toa-Throne's low and high production volume was much more difficult to formulate based upon the information provided. It was assumed that high volume production would produce a cost structure similar to that for miscellaneous plastic products (Table IX.16), and allowance was made for a thirty percent profit level. The Toa-Throne was provided with the estimated high volume production costs shown in Table IX.18. Working backwards from the high production estimate the volume wholesale and low production volume prices provided by the manufacturer were used as final unit costs allowing for: a suitable profit margin, an increase for materials costs due to reduced price quantity breaks, and an increase in fixed costs for the overhead allowance. This resulted in the low and moderate volume production figures as shown in Table IX.18. The manufacturing costs for low and volume wholesale production has a percentage distribution somewhere between electric housewares and fans manufacture and household laundry

TABLE IX.16  
 LABOR, MATERIAL, OVERHEAD, AND PROFIT  
 FOR PARTICULAR PRODUCT GROUPS

	Value of Shipments <sup>a</sup>			Percentage Production by Fifty Largest Companies
	Labor (%)	Material (%)	Overhead and Profit (%)	
household laundry equipment	16	51	34	100
electric housewares and fans	22	46	34	32
household vacuum cleaners	21	38	43	100
miscellaneous plastic products	25	45	31	5

SOURCE: Census of Manufactures, 1972.

<sup>a</sup>Value of shipments = net selling values, FOB plant, after discount and allowances and excluding freight charges and excise taxes.

TABLE IX.17  
ESTIMATED COST - DESTROILET

	Cost (\$/Unit)	Cost (%)	Cost (Including Profit) (%)
Low Production Volume (Price, \$599)			
Materials	148	43	33
Labor	108	31	24
Fixed Costs	<u>89</u>	<u>26</u>	
	345	100	
@ 30% profit	<u>104</u>		all other <u>43 (+)</u>
	449		100 (+)
Wholesale Volume (Price, \$449)			
Materials	137	49	38
Labor	76	27	21
Fixed Costs	<u>74</u>	<u>27</u>	
	277	100	
@ 30% profit	<u>83</u>		all other <u>41 (+)</u>
	360		100 (+)
High Production Volume (Price, \$360)			
Materials	119	55	44
Labor	59	27	22
Fixed Costs	<u>38</u>	<u>18</u>	
	216	100	
@ 25% profit	<u>54</u>		all other <u>34</u>
	270		100

TABLE IX.18  
ESTIMATED COSTS--TOA-THRONE

	Cost (\$/unit)	Cost (%)	Cost (Including Profit) (%)
Low Production Volume (Price, \$1045)			
Materials	406	60	46
Labor	160	24	18
Fixed Costs	<u>114</u>	<u>17</u>	
	680	100	
@ 30% profit	<u>204</u>		all other <u>36</u>
	884		100
Wholesale Volume (Price, \$952)			
Materials	337	60	46
Labor	146	26	20
Fixed Costs	<u>80</u>	<u>14</u>	
	563	100	
@ 30% profit	<u>169</u>		all other <u>34</u>
	732		100
High Production Volume (Price, \$806)			
Materials	307	59	43
Labor	144	28	21
Fixed Costs	<u>65</u>	<u>13</u>	
	516	100	
@ 35% profit	<u>181</u>		all other <u>35</u>
	697		100
or	516		
@ 30% profit	<u>155</u>		
	671		

equipment manufacture. An estimated price table as opposed to cost was developed as Table IX.19. Figures IX.21-25 show the reductions which occur with high volume production, in terms of the total cost, material cost, labor costs, fixed costs, and total price.

Costs of low and high level production related to developing countries. Utilizing the manufacturing cost data developed for two sewerless systems, the Destroilet and the Toa-Throne, the potential savings in developing country application were sought. A comparison is made in Table IX.20, between relevant labor costs in developing countries and those same costs in the United States.

With in-country, LDC manufacture and/or assembly of the Destroilet and the Toa-Throne, certain savings could be expected from the lower labor costs. Figures for U.S. low production volume labor costs of \$108 (Destroilet) and \$160 (Toa Throne) were used. The ratios of (LDC Labor Cost)/(U.S. Labor Cost) contained in Table IX.20 were used to compute in-country LDC labor costs for low-volume production of the Destroilet and the Toa-Throne. The results are given in Table IX.21.

Therefore, production in Korea of the Destroilet would result in a sixteen percent savings in labor alone, when compared to the retail price of \$599. The production of the Toa-Throne in Korea would result in a thirteen percent savings when compared to the list price of \$1045. Using the LDC labor costs from Table IX.21, the retail prices for low-volume production would be reduced from \$599 for the Destroilet, and \$1045 for the Toa-Throne, to those values given in Table IX.22. High production volumes would show a greater reduction in price in



TABLE IX.19

ESTIMATED PRICE TABLE OF SEWERLESS MANUFACTURE  
WITH VOLUME PROJECTIONS (\$U.S.)<sup>b</sup>

	List Price	Wholesale Price	Estimated Unit Price--High Production (1000-5000 Units/Order)
<u>Incinerating</u>			
Destroilet	599	449	360
Xpurgator	2,000 <sup>a</sup>		
<u>Composting</u>			
Clivus Community Production	1,685	605	200
Toa-Throne	1,045	952	806
Ecolet	736 <sup>a</sup>		
Mull-Toa	795 <sup>a</sup>		
Bio Loo	795 <sup>a</sup>		
<u>Biological</u>			
Mod A	980		
Mod 75	1400-1700 <sup>a</sup>		
Bio-Flo #512	402		

<sup>a</sup>It is felt that large-scale production should provide a figure of from thirty to forty percent less for these systems. This level had not yet been attempted.

<sup>b</sup>Depending on the marketing strategy selected, profits could vary widely, thereby altering these figures.

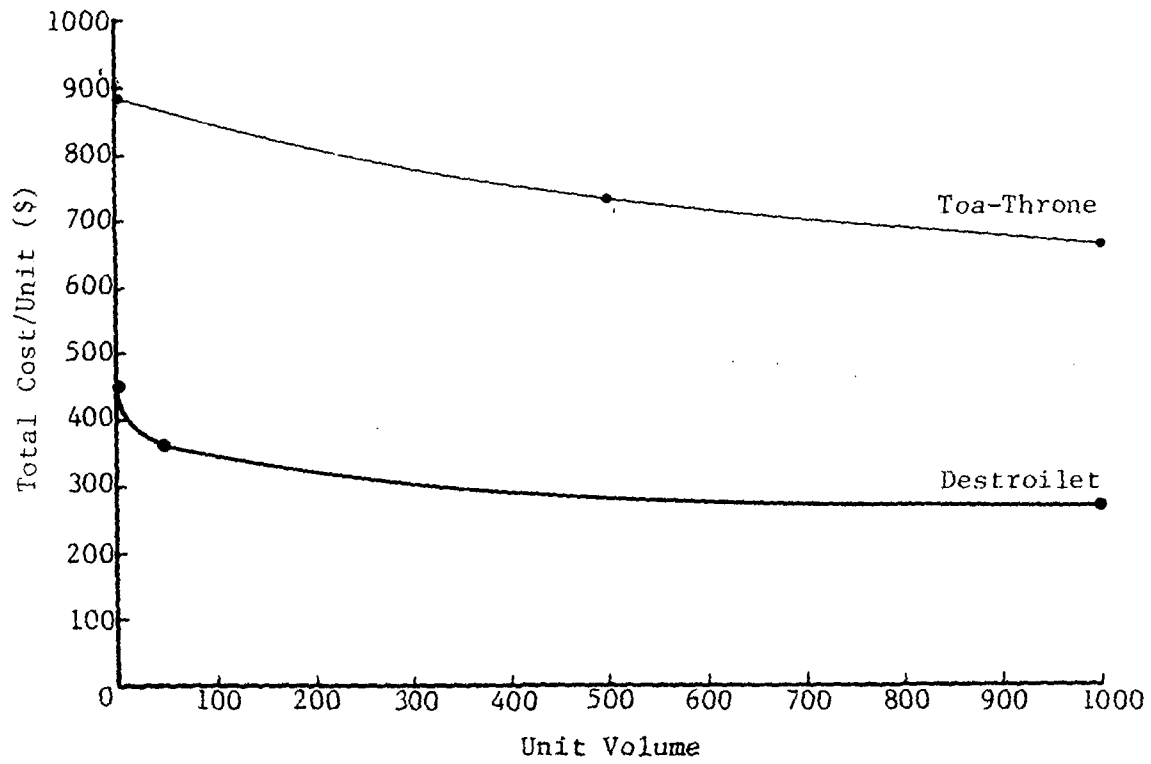

Fig. IX.21. Reduction in total costs with volume production.

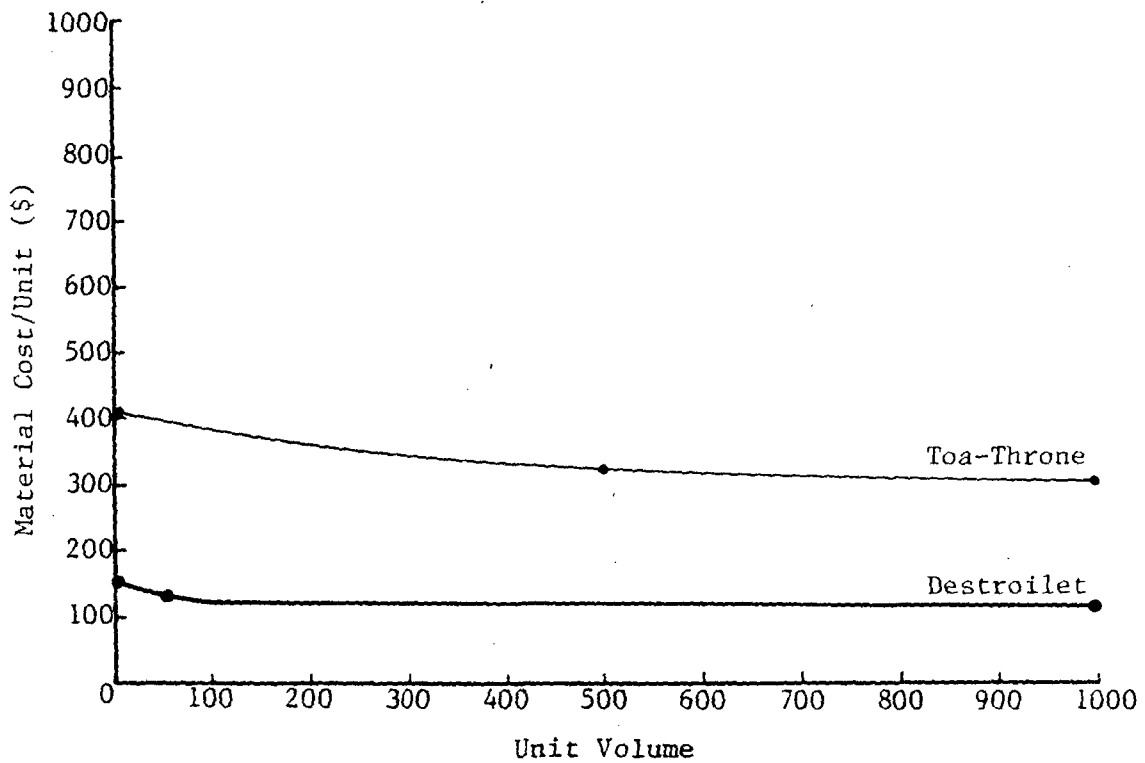

Fig. IX.22. Reduction in material costs with volume production.

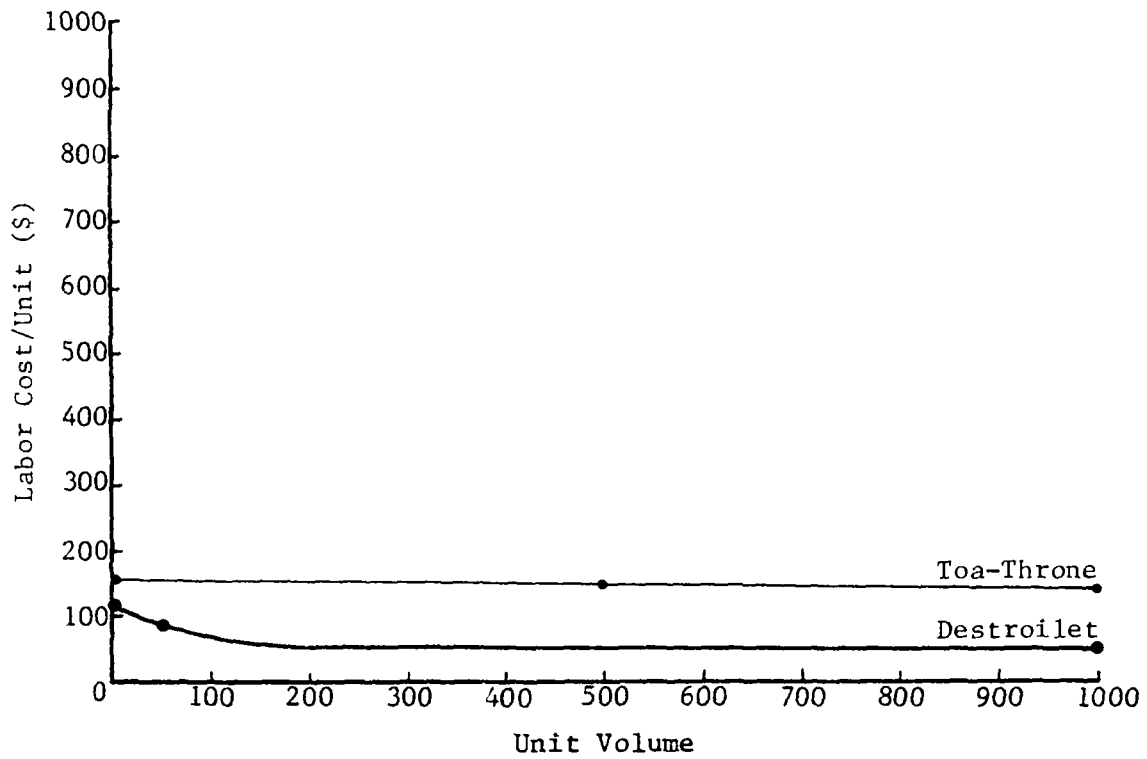

Fig. IX.23. Reduction in labor costs with volume production.

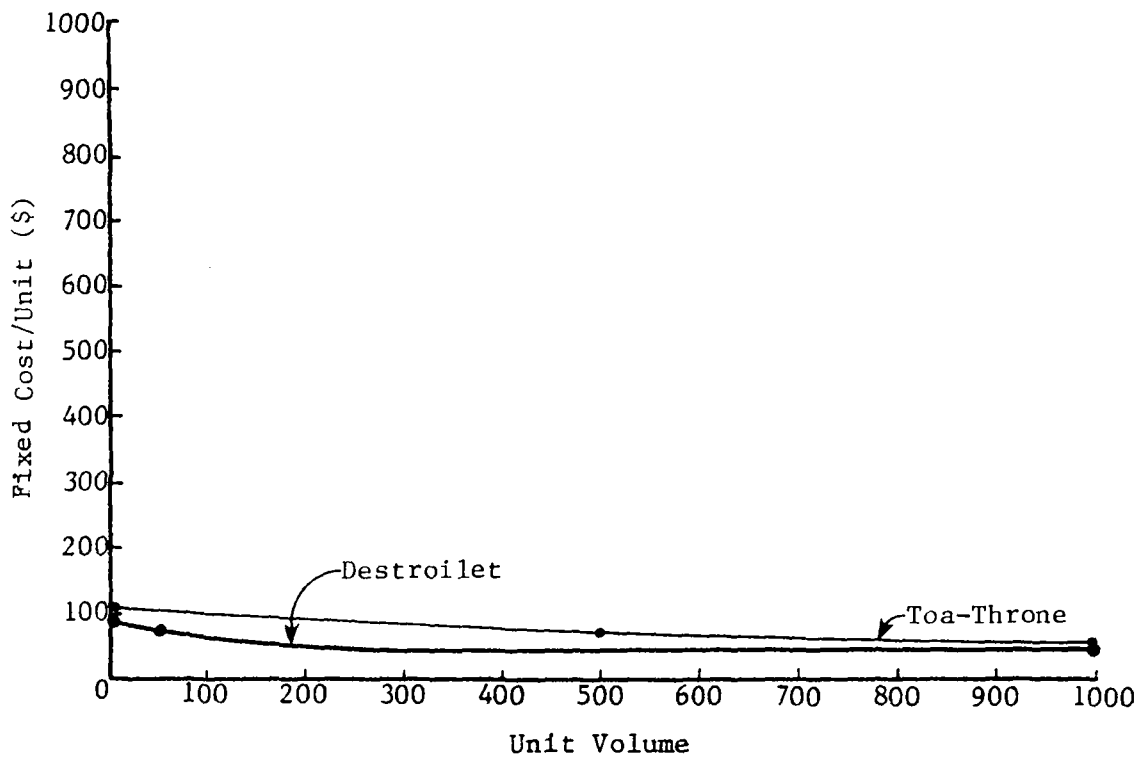

Fig. IX.24. Reduction in fixed costs with volume production.

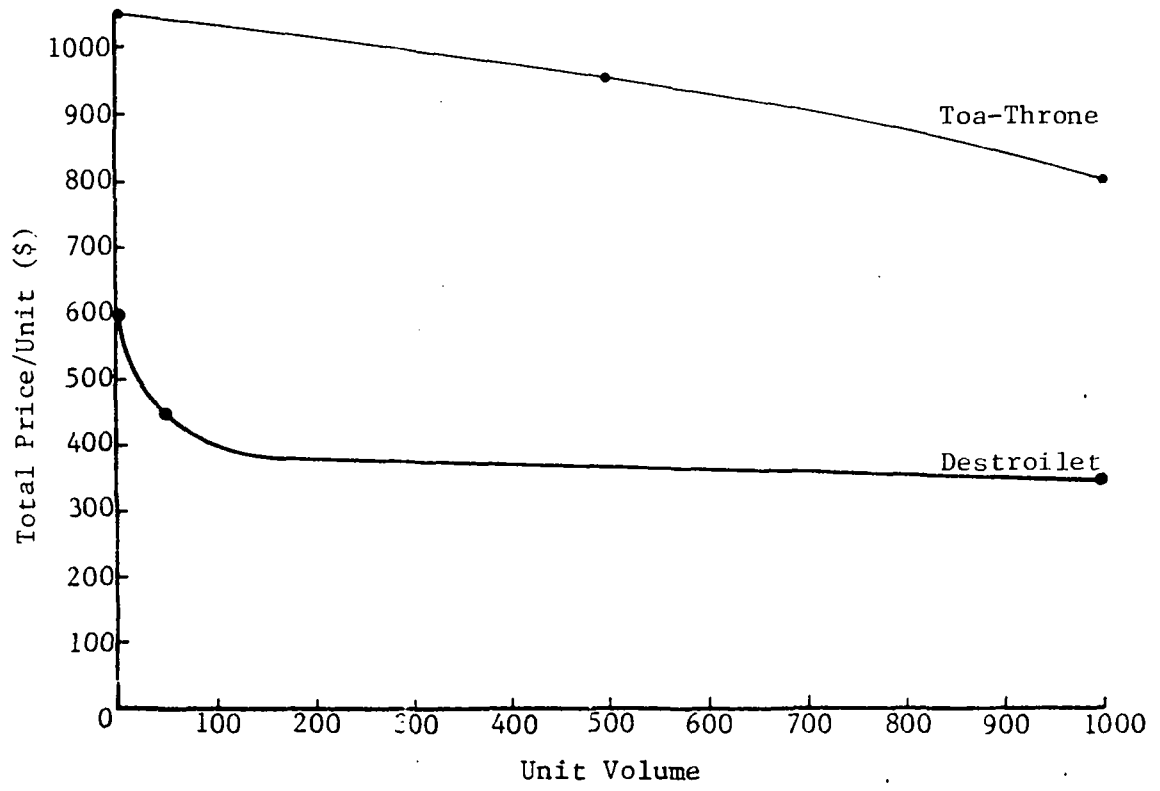

Fig. IX.25. Reduction in total price with volume production.

TABLE IX.20  
 COMPARISON OF SELECTED LABOR COSTS IN  
 DEVELOPING COUNTRIES AND IN THE UNITED STATES

	Electrical Machinery		Plastic Products	
	(U.S.\$/Month/ Individual)	<u>LDC Cost</u> <u>U.S. Cost</u>	(U.S.\$/Month/ Individual)	<u>LDC Cost</u> <u>U.S. Cost</u>
Malawi <sup>a</sup>	78.9	.099		
Puerto Rico <sup>a</sup>	487.0	.614	443.6	.588
Bolivia <sup>a</sup>	64.5	.081		
United States <sup>b</sup>	793.8	1.00	753.9	1.00
Korea <sup>a</sup>	78.3	.098	95.9	.127
Syria <sup>a</sup>	94.3	.119	74.6	.099

SOURCE: <sup>a</sup>Reference Yearbook of Labour Statistics (Geneva: International Labour Office, 1976). (Figures are for 1975.)

<sup>b</sup>Census of Manufacturers (1972).

These are sources for the cost figures. The ratios were derived by dividing the country cost by the U.S. costs given in this table.

TABLE IX.21

SAMPLE LDC LABOR COSTS FOR  
 LOW-VOLUME PRODUCTION  
 OF THE DESTROILET AND  
 TOA-THRONE  
 (U.S. DOLLARS)

	Destroilet (Using Electric Machines Ratio)	Toa-Throne (Using Plastic Production Ratio)
Malawi	10.69	not available
Puerto Rico	66.31	94.08
Bolivia	8.75	not available
Korea	10.58	20.32
Syria	12.85	15.84

TABLE IX.22

SAMPLE LDC RETAIL PRICES FOR  
 LOW-VOLUME PRODUCTION OF THE  
 DESTROILET AND TOA-THRONE--ADJUSTED  
 FOR LOWER LDC LABOR COSTS  
 (U.S. DOLLARS)

	Destroilet	Toa-Throne
Malawi	501.69	not available
Puerto Rico	557.31	979.08
Bolivia	499.75	not available
Korea	501.58	905.32
Syria	503.85	900.84

developing countries due to the rise in labor costs per unit when the volume of production is increased.

Alternative costs and effectiveness. Presently in the United States conventional and sewerless systems would be considered concurrently for application in the case of smaller towns, more difficult (costly) projects, or in lower density population areas such as urban/suburban fringe areas. According to the experiences of manufacturers, health officials, and federal funding agencies such as the U.S. Environmental Protection Agency (EPA) and Farmers Home Administration (FHA), such communities would be appropriate for consideration of the alternatives of conventional as well as sewerless systems.

In 1976 in a survey of communities with less than 50,000 people, 258 wastewater facility plans in forty-nine states were analyzed by EPA (43). Results for the cost per household, shown in Table IX.23, showed that only about five percent of the new facilities cost less than \$100 per year. This compared to about fifty percent for the 258 facilities. The survey showed that for communities with a population of less than 10,000, the costs were much higher than for the larger communities surveyed. Figures for the user charges per month gathered in the survey are shown in Table IX.24. Over 1.5 percent of the U.S. family's median annual income of \$13,000, or approximately \$195/year/household could be required for payback. This would be equivalent to \$16.25/month in user charges. Following this survey, EPA guidelines were promulgated and published calling for the cost-effectiveness analysis of conventional versus sewerless treatment systems. Cost estimates for on-site and water-saving alternatives are given in Tables IX.25 and 26. Costs for the water-saving alternatives under mass production could be reduced.

TABLE IX.23

COST PER HOUSEHOLD PER YEAR FOR WASTEWATER  
SERVICES IN COMMUNITIES WITH POPULATION  
OF LESS THAN FIFTY THOUSAND

Cost/Household/ Year (\$U.S.)	258 Facilities (%)	83 New Facilities (%)
100-200	40	75
200-300	10	20
more than 300	>0	>0
less than 100	50	5

SOURCE: USEPA, O & M Cost Considerations for Small Municipal Waste-  
water Treatment Facilities (Washington, D.C., 1977).

TABLE IX.24

USER CHARGES PER MONTH FOR WASTEWATER  
SERVICES IN COMMUNITIES WITH A POPULATION  
OF LESS THAN FIFTY THOUSAND

User Charge/Month (\$U.S.)	Community Size
less than 12	all other communities
12 - 20	10,000 or smaller
20 - 30	some communities

SOURCE: USEPA, O & M Cost Considerations for Small Municipal  
Wastewater Treatment Facilities (Washington, D.C., 1977).



TABLE IX.25  
 COST ESTIMATES FOR ON-SITE  
 WASTEWATER SYSTEM ALTERNATIVES

Alternative	Soil	Capital Cost (\$U.S.)	Operation and Maintenance Cost (\$U.S./Year)	Total <sup>a</sup> (\$U.S./Year)
Septic Tank--Conventional Soil Absorption System (SAS)	Good	975	10	85
	Fair	1288	10	109
	Poor	1600	10	134
Septic--Pressurized Distribution (Dosing)--SAS	Good	1317	35	134
	Fair	1641	35	159
	Poor	1964	35	194
Septic Tank--Alternating Beds	Good	1700	10	141
	Fair	2326	10	189
	Poor	2950	10	238
Septic Tank--Mound System	--	3500	35	305
Septic Tank--Evapo-transpiration (ET)	--	4000	10	319
Septic Tank--Sand Filter-Disinfection	--	3415	150	421
Aerobic Unit--Pressurized Distribution (Dosing)	Good	2347	122	326
	Fair	2671	122	351
	Poor	2994	122	376
Aerobic Unit--Sand Filter-Disinfection	--	3395	207	492
Aerobic Unit--Disinfection	--	2645	147	374

SOURCE: Jim Kreissel, U.S. Environmental Protection Agency.

<sup>a</sup>EDITOR'S NOTE: Knowledge of the lifetimes is needed for further analysis of these figures.

TABLE IX.26  
 COST ESTIMATES FOR  
 WATER-SAVING ALTERNATIVES

Alternative	Soil	Capital Cost (\$U.S.)	Operation and Maintenance Cost (\$U.S./Year)	Total <sup>a</sup> (\$U.S./Year)
Large Biological Toilet + Septic Tank (ST) - Soil Absorption System (SAS)	Good	2900	20	244
	Fair	3200	20	268
	Poor	3500	20	291
Small Biological Toilet + ST-SAS	Good	1900	90	237
	Fair	2200	90	260
	Poor	2500	90	283
Incinerator Toilet + ST-SAS	Good	1650	180	308
	Fair	1950	180	331
	Poor	2250	180	354
Low-Flush Toilet + ST-SAS	Good	1400	96	210
	Fair	1700	96	234
	Poor	2000	96	257

SOURCE: Jim Kreissel, U.S. Environmental Protection Agency.

<sup>a</sup>EDITOR'S NOTE: Complete interpretation of these figures would require knowing the lifetime of the various alternatives listed.

Essential manpower and resources required for waste treatment processes are given in Table IX.27. The conventional processes are listed as PS1 through PS12. The individual treatment methods are listed as PS13 and PS14. In Table IX.28, the two categories of PS13 and PS14 are expanded, modified and shown in more detail as PSS1 through PSS7.

In Table IX.29, information is presented on waste treatment processes concerning available loan sources, community types appropriate for use of each process, and the life expectancy of each process, assuming proper operation and maintenance. There could be variations within this dependent upon a variety of factors such as siting, engineering design, and community acceptance.

There are many measurements of effectiveness which can be used to determine the most appropriate waste disposal treatment system for any size community. Usually in the past this determination has been made on the basis of economic measurements alone, or on the basis of the most units for the least cost. Unfortunately, an economic system will not necessarily provide the most acceptable solution. The economic approach does not take into consideration other factors which affect the eventual success of a project. Such other factors (often socio-cultural in value) are not always compatible to the assignment of consistent monetary values that are repeatable or comparable.

Another measurement of effectiveness has been the regulatory requirements of effluent standards and the cost of meeting those standards with various systems. Criticism of this measurement may be based both on the determination of the standards and the process of provision for alternative systems. That is, standards often need to be arbitrary

TABLE IX.27

PROCESS CONSTRAINTS--WASTE TREATMENT  
PROCESSES WITH ESSENTIAL MANPOWER  
AND RESOURCES REQUIRED

Treatment Methods	Process Requirements	Process Number	Manpower			Resources Required				
			Unskilled	Skilled	Professional	Operation Equipment	Process Materials	Maintenance Supplies	Chemical Supplies	Water Source (Groundwater Availability)
Waste Processes	Primary--Conventional	PS1	x							
	Primary--Stabilization Pond	PS2	x							
	Sludge--Conventional	PS3	x	x			x	x	x	
	Sludge--Advanced	PS4	x	x		x	x	x	x	
	Sludge--Combined (Imhoff)	PS5	x			x		x		
	Secondary--Standard Filter	PS6	x	x		x		x		
	Secondary--High Rate Filter	PS7	x	x	x	x	x	x	x	
	Secondary--Activated Sludge	PS8	x	x	x	x	x	x		
	Secondary--Extended Aeration	PS9	x	x		x		x		
	Disinfection	PS10		x		x	x			
	Aqua Culture	PS11	x							
	Dilution	PS12	x							
	Individual	PS13	x							x
	Individual (Advanced)	PS14		x		x		x		x

SOURCE: George W. Reid and Richard Discenza, Prediction Methodology for Suitable Water and Wastewater Processes (Norman: University of Oklahoma Office of Research Administration, 1975), p. 21.

TABLE IX .28

PROCESS CONSTRAINTS--WASTE TREATMENT  
PROCESSES WITH ESSENTIAL MANPOWER  
AND RESOURCES REQUIRED (DETAILS  
OF INDIVIDUAL PROCESSES,  
PS13 AND PS14)

Treatment Methods	Process Requirements	Process Number	Manpower			Resources Required			
			Unskilled	Skilled	Professional	Operation Equipment	Process Materials Maintenance Supplies	Chemical Supplies Water Source (Groundwater Availability)	
Sewerless Processes	Septic Tank (PS13)	PSS1	x	*	*	x		x	
	Incinerating Toilet (PS14)	PSS2	x	*	*	x	x	x	
	Biological Toilet (PS14)	PSS3	x	x	*	x	x	x	x
	Composting Toilet (PS14)	PSS4	x	*	*	x		x	
	Vacuum System (PS14)	PSS5	x	*	x	x	x	x	
	Oil Base Toilet (PS14)	PSS6	x	*	*	x	x	x	x
	Aerobic Tank (PS14)	PSS7	x	*	*	x		x	x

\*Consultation basis or part-time.

TABLE IX.29

WASTE TREATMENT PROCESSES WITH AVAILABLE  
LENDING SOURCES, APPROPRIATE COMMUNITY  
TYPES, AND LIFE EXPECTANCY OF PROCESS

Treatment Methods	Process Number	Loan Source			Community Type						Life Expectancy of Method		
		State Funds	In-Country Funds	International Loans	Village	Unsewered Community	Sewered Community	Suburban	Urban	Temporary	Short-Term	Long-Term	
Primary--Conventional	PS1	x				x	x	x				x	
Primary--Stabilization Pond	PS2	x				x	x	x				x	
Sludge--Conventional	PS3		x			x		x				x	
Sludge--Advanced	PS4		x			x		x				x	
Sludge--Combination (Imhoff)	PS5		x					x				x	
Secondary--Standard Filter	PS6			x				x				x	
Secondary--High Rate Filter	PS7			x				x				x	
Secondary--Activated Sludge	PS8			x				x				x	
Secondary--Extended Aeration	PS9			x				x				x	
Disinfection	PS10		x	x		x	x				x	x	
Aqua Culture	PS11	x			x	x						x	
Dilution	PS12		x			x		x		x			
Individual	PS13	x	x		x	x		x		x	x		
Individual (Advanced)	PS14	x	x			x	x	x	x			x	
Septic Tank (PS13)	PSS1	x	x		x	x	x	x			x	x	
Incinerating Toilet (PS14)	PSS2	x	x			x	x	x	x		x	x	
Biological Toilet (PS14)	PSS3	x	x			x	x	x			x	x	
Composting Toilet (PS14)	PSS4	x	x		x	x	x	x	x		x	x	
Vacuum/Pressure System (PS14)	PSS5			x		x			x			x	
Oil Base Toilet (PS14)	PSS6			x				x	x			x	
Aerobic Tank (PS14)	PSS7	x	x			x	x	x			x	x	

because of their diverse application. The development of alternative systems has often been inhibited by limitation in field data, engineering design, and equipment availability.

Various other schemes have been proposed to measure effectiveness. The acceptance of these has varied depending upon their particular application and dissemination. Table IX.30 presents an example of a rating system for alternative toilet systems which uses low to high values. Human waste disposal in developing countries has often been handled with the same reasoning that was used in Great Britain and northern Europe until the 1800's, namely, that dilution is the answer to pollution. Removal of wastewater from the human environment has been the effectiveness criterion.

The higher costs of conventional sewerage and treatment has limited the applicability of present-day, developed-country conventional wastewater systems. In certain cases, the new sewerless technology with reduced water-use and sewerage requirements does show advantages in greater cost-effectiveness over the conventional systems, creating new cost-effective alternatives. This comparison could then be favorable to U.S. purchase as described. The residual question relates to LDC comparisons.

A cost comparison for sewerless systems is given in Table IX.31. Table IX.32 contains conventional conveyance and treatment cost figures. Table IX.33 contains a summary of the estimated total annual costs per capita for conventional systems as well as an incinerating toilet, biological toilet, and composting toilet. All three sewerless units appear to be competitive with conventional systems in each population

TABLE IX. 30  
ALTERNATIVE TOILET SYSTEM CHARACTERISTICS<sup>a</sup>

Toilet System	Similarity to Conventional System		Approximate Resource Requirements				Final Product Disposal	Scheduled Maintenance
	Appearance	Use	Water	Power	Fuel	Pumping		
Composting Separated	low	low	none	low	none	none	soil amendment	periodic residue removal
Non-Separated	low	low	none	moderate	none	none	soil amendment	periodic residue removal
Incinerating	moderate	moderate	none	low--high	low--high	none	refuse	weekly ash removal and periodic unit cleaning
Recycle	moderate--high	moderate--high	none	low	none	yes	treatment plant or land disposal	annual servicing and accumulated solids pumping
Low Flush/Holding Tank	high	high	two quarts per use	low	none	yes	treatment plant or land disposal	semi-annual tank pumping

SOURCE: Robert Siegrist, Segregation and Separate Treatment of Black and Grey Household Wastewaters to Facilitate On-site Surface Disposal (Madison: University of Wisconsin, November 1976.)

<sup>a</sup>The characteristics shown may vary considerably depending on the individual unit and/or application in question.



TABLE IX.31  
ESTIMATED COST COMPARISON FOR SEWERLESS SYSTEMS

Treatment Method	Process Number	Initial Capital Cost (\$U.S./Home Unit)	Operation and Maintenance Cost (\$U.S./Year)	Annual Cost (\$U.S./Capita/Year) (Assume 6 persons/unit)
Septic tank (with soil absorption system, SAS)	PSS1	975 <sup>a</sup>	10 <sup>a</sup>	10 <sup>d</sup>
Incinerating toilet	PSS2	500 <sup>b</sup> (Destroilet--wholesale)	180 <sup>c</sup> (with septic tank and SAS)	38 <sup>e</sup>
Biological toilet	PSS3	980 <sup>b</sup> (Mod A--retail)	90 <sup>c</sup> (with septic tank and SAS)	23 <sup>d</sup>
Composting toilet	PSS4	800 <sup>b</sup> (Toa-Throne--high volume)	10 <sup>f</sup>	8 <sup>d</sup>
Vacuum/pressure system	PSS5	site intensive (varies according to terrain and population density)	96 <sup>c,f</sup> (figure for low-flush toilet with septic tank and SAS)	site intensive (varies according to terrain and population density)
Oil base toilet	PSS6	2000 <sup>f</sup>	100 (estimated)	50 <sup>e</sup>
Aerobic tank (pressurized distribution or dosing)	PSS7	2350 <sup>a</sup>	122 <sup>a</sup>	40 <sup>d</sup>

<sup>a</sup>From Table IX.1.25. The septic tank and aerobic unit figures assume good soil conditions.

<sup>b</sup>From Table IX.1.19.

<sup>c</sup>From Table IX.1.26.

<sup>d</sup>Assumes twenty year life for biological units.

<sup>e</sup>Assumes ten year life for mechanical units.

<sup>f</sup>EDITOR'S NOTE: The origin of this figure is not clear.

TABLE IX. 32

CONVENTIONAL CONVEYANCE AND TREATMENT COST  
(\$/Capita/Year)

Population Size	Construction <sup>a</sup>	Operation and Maintenance <sup>a</sup>	Conveyance <sup>b</sup>	Total
500 - 2,500	6.70	5.20	58 - 32	70 - 44
2,500 - 15,000	2.00	3.52	58 - 32	64 - 38
15,000 - 50,000	1.60	2.98	32 - 21	37 - 26
50,000 - 100,000	1.30	2.52	32 - 21	36 - 25

SOURCE: <sup>a</sup>George W. Reid and Richard Discenza, Prediction Methodology for Suitable Water and Wastewater Processes (Norman: University of Oklahoma, 1975).

<sup>b</sup>Keith W. Dearth, Office of Water Programs Operations, U.S. Environmental Protection Agency, report for a Seminar on Technology Transfer for Small Wastewater Treatment Systems, Denver, July 1977.

<sup>a</sup>Conventional activated sludge process with a twenty-year lifetime.

<sup>b</sup>Conveyance cost is based on population density as follows:

$$\$/\text{capita}/\text{year} = 86 e^{-.1(\text{persons}/\text{acre})}$$

<u>persons/acre</u>	<u>\$/capita/year</u>
---------------------	-----------------------

low density	58
moderate density	32
high density	21

TABLE IX.33  
 ESTIMATED TOTAL ANNUAL COST PER CAPITA  
 FOR REPRESENTATIVE SEWERLESS AND CONVENTIONAL  
 WASTE TREATMENT/DISPOSAL METHODS  
 (\$U.S.)

Treatment Method	Process Number	Population Size			
		500 - 2,500	2,500 - 15,000	15,000 - 50,000	50,000 - 100,000
Incinerating toilet	PSS2	38	38	38	38
Biological toilet	PSS3	23	23	23	23
Composting toilet	PSS4	8	8	8	8
Conventional system		70 - 44	63 - 37	35 - 25	33 - 25

category, with a decrease in competetiveness occurring with an increase in the size of the population group to be served.

#### CONCLUSIONS

With only a small percentage of the population in LDC's being serviced by sewage treatment facilities and the majority of the people being without piped water, the necessity for consideration of alternatives to centralized treatment practices is evident. A review of international documents on wastewater practices together with a comparison of waterborne, cartage, and on-site systems supports the consideration of on-site alternatives. See Table IX.34.

Conclusions reached during the course of this study are as follows:

1. Developing and/or less-developed countries have one thing in common, namely, the lack of, or minimal level of organized sewage collection and disposal of waste, in particular, domestic sewage.
2. To transfer developed country (DC) technology in the form of conventional sewerage and sewage disposal systems is fiscally prohibitive, and alternatives must be explored.
3. On-site systems for individual households or small groupings of homes and community centers are technically available and are to be found in several variations. They are characterized as hydraulic, biological, and chem/thermal, and are in use in sufficient numbers to warrant further applications and demonstrations.
4. Some on-site units have been manufactured on a production level,

TABLE IX. 34

ASSESSMENT OF IMPORTANT ATTRIBUTES RELATED  
TO SYSTEMS OF WASTE DISPOSAL/TREATMENT

	System Type		
	Waterborne	Cartage	On-Site
Capital Cost	High	High/Low	Low
Operating Cost	Low	High	Low
Offshore Cost Component <sup>a</sup>	High	High/Low	Nil
Water Consumption	High	Low/Nil	Low/Nil
Optimal Density	High Density (High Rise)	High Density (Low Rise)	High and Low Density (Low Rise)
Adaptability to Incremental Implementation	Nil	High	High
Adaptability to Self-Help	Nil	Low	High

SOURCE: Witold Rybczynski; Chongrak, Polprasert; and Michael McGarry, Stop the Faecal Peril: A Technology Review (Ottawa: IDRC, July 1977).

<sup>a</sup>Offshore cost component refers to materials not available locally.

but substantial site data is not available, particularly for chem/thermal units in LDC's.

5. Evidence in the United States indicates the acceptance of the biological units for small rural communities or dispersed housing areas.
6. Lacking hard data, in-country (LDC) application of chem/thermal methods appears feasible from synthesized costs for units as compared to conventional systems (Table IX.33).
7. Consumer acceptance is not always a matter of cost (as demonstrated by DC acceptance) but can rest on health factors and socio-cultural factors.
8. What is needed is an LDC demonstration-level study to validate the findings of this study, that is, a comparative study of conventional solutions versus on-site ones, including considerations of site feasibility and an in-place practice demonstration.
9. Such a study would consider cost, capital as well as operation and maintenance. It would look at various units or combinations of them for several LDC sites including large, medium, and small urban areas. The primary goal would be nuisance and health control. Various waste considerations such as laundry wastewater may require separate handling.
10. For chem/thermal units electricity can be assumed to be available since it will probably be provided to a community at a reasonable price as a social good.
11. Several management schemes should be explored: private enterprise; private manufacture, public installation and control; and public manufacturing and installation.

12. All schemes should have a built-in, public incentive or incentive concept.
13. Performance, for example, effluent quality should be in accordance with local standards.
14. Consumer acceptance should also be considered during the in-place studies.

Because of their low domestic water requirements, absence of waste disposal standards, and only small amounts of industrial and trade wastes, it is clear that LDC's have a unique opportunity to explore an alternative solution to waste disposal and avoid certain of the pitfalls that have been encountered during the process of development in the DC's. In DC's present use of water reaches more than 2000 gallons per capita per day for all purposes, 160 gallons per capita per day being municipal water, and a large percent of it ends up as waste, whereas with on-site systems the savings achieved in reducing water consumption can be significant. Regional systems or large metropolitan systems, even at greater than ninety percent efficient treatment levels, still discharge unacceptable waste loads. Thus, the correct focus is a reversal of the trend and a move towards segregated and manageable units utilizing sequential use and re-use and in-place control. On-site treatment should be encouraged as LDC's develop economically as this will be beneficial to their future development.





# Expedient Technologies

George W. Reid

Several types of technology related to methods of water and waste treatment are presented in this chapter as well as information concerning related areas. These represent technologies which either were not included in the more formal classifications of previous chapters or which it seemed beneficial to introduce here from the particular point of view of application in village or individual dwelling situations, where maintenance is often accomplished on an individual or purely voluntary basis. Though this material can be useful for wider application, a nucleated population of about 300 persons would probably be the upper limit in size for volunteer operation to be feasible. Rather than attempting to include detailed designs or descriptions of technologies, the objective was to facilitate access to a part of the enormous amount of material that is already available. Each

reference abounds in ideas, most of them specifically applicable to LDC's, and most are available through international sources.

The rural global population not yet having reasonable access to a safe water supply number 1000 million, and the number is twice that in the case of sewage disposal or treatment. Substantial material is available on the general dimensions of the problem. One particular area which is important in a global sense is delineated and involves health aspects, that is, infections through water, questions of personal hygiene, and water-related vectors. Economic, social, and environmental concerns are also illuminated. In this group of works the main emphasis is not on technology although they do contain numerous examples of technology appropriate to LDC's.

1. Feachem, Richard; McGarry, Michael; Mara, Duncan, eds. Water, Wastes, and Health in Hot Climates. London: John Wiley & Sons, 1977.
2. Intermediate Technology Group. Water for the Thousand Millions. Oxford, Great Britain: Pergamon Press, 1977.
3. Miller, Arthur P. Water and Man's Health. Washington, D.C.: U.S. Department of State, Agency for International Development (AID), Office of Health, 1967.
4. Report of the United Nations Water Conference, Mar del Plata, Argentina, 14-25 March 1977. Part 1: Decisions of the Conference. Sales no. E.77.II.A.12.
5. Saunders, Robert T., and Warford, Jeremy J. Village Water Supply: Economics and Policy in the Developing World. Johns Hopkins University Press, 1976.  
 Address: World Bank  
 1818 H Street, N.W.  
 Washington, D.C. 20433  
 U.S.A.
6. Stein, Jane. Water: Life or Death. Report for the United Nations Water Conference, Mar del Plata, Argentina, March 1977. International Institute for Environment and Development. (Library of Congress Catalog Card #77-73172.)

7. White, Anne U., and Seviour, Chris. Rural Water Supply and Sanitation in Less-Developed Countries: Selected Annotated Bibliography. Ottawa, Canada: International Development Research Centre, 1974.  
Address: International Development Research Centre  
60 Queen Street  
Ottawa, Canada K1G3H9
8. White, Gilbert F.; Bradley, David J.; White, Anne U. Drawers of Water: Domestic Water Use in East Africa. Illinois: University of Chicago Press, 1972.
9. World Health Statistics Report." Water and Sanitation 29, no. 10 (1976) Geneva: WHO.

In a small village or nucleated settlement, water supply (not treatment) is frequently all that is needed, though often there is no separation made in the literature between consideration of water supply and that of waste disposal and treatment. In the case of water supply, wells, surface supplies, simple impoundments and storage, pipelines, pumps, small storage/filter combinations, water quality criteria, and water analysis are all of importance. As part of the OU/USAID contract, three works were made available. One consisted of the results of a mail survey of unpublished literature on LDC technologies. Another, in two parts, comprised a discussion of rural water supply and related technologies in developing countries. The third was a compendium of technologies relating to individual units.

10. Contributions to a Mail Survey on Practical Solutions in Drinking Water Supply and Waste Disposal for Developing Countries. Okla. (AID/CM/ta-C-73-13 Res.) (PN-AAD-287.) The Hague: WHO International Reference Center for Community Water Supply, 1977.
11. Gorkum, Willem van, and Kempenaar, Kees. Rural Water Supply in Developing Countries. Okla. (AID/CM/ta-c-73-13 Res.) (PN-AAD-285.) 1975.
12. Huisman, L. Treatment Methods for Water Supplies in Rural Areas of Developing Countries. Okla. (AID/CM/ta-C-73-13 Res.) (PN-AAD-284.) 1975. (Part 2 is PN-AAD-285.)

13. Reid, George W. A Catalog of Water Supply and Waste Disposal Methods for Individual Units. Okla. (AID/CM/TA/C-73-13 Res.) (PN-AAD-283.) 1975.

Wells were discussed previously in Chapter VII, and there are numerous publications available on wells, well construction, and the sanitary protection of wells.

14. Baldwin, Helene L., and McGuinness, C. L. A Primer on Groundwater. U.S. Government Printing Office, 1963.
15. Gibson, Ulric P., and Singer, Rexford D. Small Wells Manual. Washington, D.C.: U.S. Department of State, Agency for International Development, January 1969. (156 pages.)
16. \_\_\_\_\_ . Water Well Manual. Premier Press, 1971.
17. Manual of Individual Water Supply Systems. (EPA 430/9-74-007.) U.S. Environmental Protection Agency, Office of Water Programs, Water Supply Division, 1975.
18. Manual of Individual Water Supply Systems. Pub. no. 24. Washington, D.C.: U.S. Department of Health, Education, and Welfare, Public Health Service, 1963.

Larger well supplies warrant more detailed studies of groundwater and well hydraulics. Ample material in this area is available in the literature, but there is seldom sufficient LDC data.

19. Campbell and Lehr. Well Water Technology. McGraw-Hill, 1973.
20. Groundwater and Wells. 1st ed. Saint Paul, Minn.: Edward E. Johnson, 1966.
21. Groundwater Studies. Paris: UNESCO Press, 1975.

Surface water supplies generally are developed for much larger groups of users, but there are unique, LDC/rural applications to be found.

22. Community Water Supply and Sewage Disposal Programs in Latin America and Caribbean Countries. Document no. ES.5. Geneva: World Health Organization, 1969.

23. Darrow, Ken, and Pam, Rick. Appropriate Technology Sourcebook. 2nd ed. Stanford, Calif.: Volunteers in Asia, November 1976. (304 pages.)  
Address: Appropriate Technology Project  
Volunteers in Asia  
Box 4543  
Stanford, California 94305  
U.S.A.
24. Falkenmark, Malin, and Lindh, Gunnar. Water for a Starving World. Westview Press, 1976.
25. Guidelines and Criteria for Community Water Supplies in the Developing Countries. Washington, D.C.: U.S. Department of State, Agency for International Development, Office of Health, 1969.
26. Mann, H. T., and Williamson, D. Water Treatment and Sanitation: A Handbook of Simple Methods for Rural Areas in Developing Countries. London: Intermediate Technology Development Group, 1973.
27. Village Water Supply. A World Bank paper. Washington, D.C., March 1976. (94 pages.)  
Address: World Bank  
1818 H Street, N.W.  
Washington, D.C. 20433  
U.S.A.
28. Volunteers in Technical Assistance (VITA). Village Technology Handbook. Mt. Rainier, Maryland, 1977. (387 pages.)  
Address: Volunteers in Technical Assistance  
3706 Rhode Island Avenue  
Mt. Rainier, Maryland 20822  
U.S.A.
29. Wright, Forrest B. Rural Water Supply and Sanitation. 2nd ed. New York: John Wiley & Sons; London: Chapman & Hall, 1956. (Library of Congress Catalog Card #56-7166.)

Frequently, the pumps and pipes for water development in LDC's are entirely imported. Some attention has been given to pipe materials, particularly plastic pipe. A great deal of attention has been focused on the in-country development of hand pumps.

The Moyno (trade name) progressing cavity pump is composed of a single-threaded screw-like rotor that turns with a minimum of

clearance in a double-threaded helix. It can handle abrasive sand, and has no valves, gaskets, or leathers.

With the hydraulic ram pump, a pipe carries water by gravity from the source to the valve box of the pump where a waste valve opens downward and a delivery valve opens upward. Water pours through the waste valve till it is shut suddenly. Then water hammer pressure forces some water through the delivery valve and up the delivery pipe. When the wave of negative pressure returns from the reservoir, the delivery valve is pulled shut and the waste valve open, and the cycle will be repeated. The ratio of wasted water to pumped water will vary from 6:1 to 2:1, and a considerable amount of noise is produced.

30. Billings, C. H.; Conner, Samuel H., Kircher, James R., eds. Public Works Manual and Catalog File, 1977. Ridgewood, N.J.: Public Works Journal Corporation.  
Address: Public Works Journal Corporation  
200 S. Broad Street  
Ridgewood, N.J. 07451  
U.S.A.
31. Buyer's Guide. Journal of the American Water Works Association 68, no. 11 (November 1976). (Part 2, 1977.)
32. Hand Pumps. Technical Paper, no. 10. The Hague: WHO International Reference Centre for Community Water Supply/United Nations Environmental Programme, July 1977.  
Address: International Reference Center for  
Community Water Supply  
P. O. Box 140  
Leidschendam  
The Netherlands
33. Linsley, Ray K., and Franzini, Joseph B. Water-Resources Engineering. New York: McGraw-Hill Book Co., 1964.
34. McJunkin, Frederick E., and Pineo, Charles S. Role of Plastic Pipe in Community Water Supplies in Developing Countries. Washington, D.C.: U.S. Department of State, AID, Office of Health, 1971.
35. Robbins & Myers. Moyno Hand Pumps for Rural Water Systems. Bulletin 277. 1895 Jefferson Street, Springfield, Ohio 45501, 1977.

36. Utilization/Evaluation of the AID/Battelle Hand Operated Water Pump. Washington, D.C.: U.S. Dept. of State, Agency for International Development, Office of Health, 1978.
37. Watt, S. B. A Manual on the Hydraulic Ram for Pumping Water. London: Intermediate Technology Publications, 1975.

Operational water quality criteria can and should vary from site to site, both in the attributes controlled and in the levels allowed. Several documents address this question. Economists frequently subscribe to the acceptance of higher concentration levels in the case of LDC's.

38. Drinking Water Standards. Pub. no. 956. Washington, D.C.: U.S. Department of Health, Education, and Welfare, Public Health Service, 1962.
39. European Standards for Drinking Water. Geneva: World Health Organization, 1970.
40. Evaluation of Water Laboratories. Pub. no. 999-EE-1. Washington, D.C.: U.S. Department of Health, Education, and Welfare, Public Health Service, 1966.
41. International Standards for Drinking Water. Geneva: World Health Organization, 1971.
42. Manual for Evaluating Public Drinking Water Supplies. Cincinnati, Ohio: U.S. Department of Health, Education, and Welfare, Public Health Service, Environmental Control Administration, Bureau of Water Hygiene, 1969.

In the analysis of water and wastewater, several approaches are possible, among them, in-country supportable technology and operator training programs.

43. Okun, D.A. Manpower Development and Training in Water Sector: Responsibilities of the World Bank. Public Utilities Notes. International Bank for Reconstruction and Development, International Development Association, Energy Water and Telecommunications Department, June 1977.
44. Reid, George W., and Yang, Weigun W. Water Test Kit I: User's Manual and Water Test Kit II: User's Manual. (English, Chinese, Spanish, French, Persian and Arabic.) University of Oklahoma, 1975.

For larger community systems, the American Water Works Association, the American Public Health Association, associations of manufacturers, and specific catalogues of manufacturers provide valuable source material. The OU/USAID project has also developed a catalogue of processes and equipment.

45. Reid, George W.; Unsell, C. W.; and White, Thomas E. Catalog of Water and Wastewater Treatment Processes, Equipment and Manufacturers. Norman: University of Oklahoma Bureau of Water and Environmental Resources Research, 1978. (Currently under contract.)

Some very useful and unique techniques are to be found through the use of two quite diverse sources. One describes methods appropriate for use in emergency situations. The other source consists of LDC research centers and contacts. In this literature, in particular, considerations of water are rarely separated from those of sewage.

46. Assar, M. Guide to Sanitation in Natural Disasters. Geneva: WHO, 1971.
47. Environmental Health Practice in Recreational Areas. Pub. No. 1195. Washington, D.C.: U.S. Department of Health, Education, and Welfare, Public Health Service.
48. Manual for Village Health Workers. Washington, D.C.: U.S. Agency for International Development, Office of Health, 1970. (74 pages.)
49. Philippines National Pollution Control Commission. A Water Sterilization Study in the Philippines. (AID/CM/ta-C-73-13 Res.) (PN-AAD-282.) 1976.
50. Rajagopalan, S., and Shiffman, M. A. Guide to Simple Sanitary Measures for the Control of Enteric Diseases. Geneva: World Health Organization, 1974.
51. Thailand Ministry of Public Health. Study of an Existing Water Treatment Plant of Simple Design and Operating System for Supplying Drinking Water to Rural Communities in the Lower Mekong Basin Countries. Okla. (AID/CM/ta-C-73-13 Res.) (PN-AAD-280.) 1976.



52. Werner, David. Where There is No Doctor: A Village Health Care Handbook. 1st English ed., rev. from Spanish. Hesperian Foundation, 1977.

For on-site waste disposal technology three categories are usually considered: Hydraulic, biological, and thermal/chemical. These devices were discussed above in Chapter IX. Off-site waste disposal and treatment was discussed previously in Chapter VIII.

53. Bendixen, T. W., et al. Development of Practical Design Criteria for Seepage Pits as a Method for Disposal of Septic Tank Effluent. Cincinnati, Ohio: Robert A. Taft Sanitary Engineering Center, 1963.
54. Canter, L. W., and Malina, J. F. Sewage Treatment in Developing Countries. Okla. (AID/CM/ta-C-73-13 Res.) (PN-AAD-286.) 1976.
55. Central Public Health Engineering Research Institute. Proceedings of a Symposium on Low Cost Waste Treatment. Nagpur, India, 1972.
56. Water Supply and Waste Disposal for Greater Bombay. Part 2: Waste Disposal. Nagpur, India, 1971.
57. Considerations for Designing and Improving Individual Sewage Disposal Systems. U.S. Department of Agriculture, Oklahoma State Department of Health, and the Oklahoma State University Cooperative Extension Service.
58. Gloyna, Earnest F. Waste Stabilization Ponds. Monograph Series no. 60. Geneva: World Health Organization, 1971.
59. Gotaas, H. B. Composting: Sanitary Disposal and Reclamation of Organic Wastes. WHO Monograph Series, no. 131. Geneva: 1956.
60. Howard, J. C. Oxfam Sanitation Unit in Bangladesh. England: University of Loughborough, 1976.
61. Mohanrao, G. Wastewater Treatment and Disposal. Nagpur, India: Central Public Health Engineering Research Institute, 1973.
62. Okun, D. A., and Ponghis. Community Wastewater Collection and Disposal. Geneva: World Health Organization, 1975.
63. Pescod, M. B. Investigation of Rational Effluent and Stream Standards for Tropical Countries. Bangkok, Thailand: Asian Institute of Technology, 1974.

64. Pickford, J. Indexed Bibliography of Publications on Water and Waste Engineering for Developing Countries. United Kingdom: Loughborough University, 1977.
65. Rybczynski, Witold; Polprasert, Chongrak; and McGarry, Michael. Stop the Faecal Peril: A Technology Review. IDRC Preliminary Report. Ottawa: International Development Research Centre, July 1977.
66. Sewage Treatment in Small Towns and Rural Areas. Office of Regional Programs at Dartmouth College, 1971.
67. Siddiqi, R. H. Characteristics of Domestic and Municipal Sewage in India. Nagpur, India: Central Public Health Engineering Research Institute.
68. U.S., Department of Health, Education, and Welfare. Manual of Septic Tank Practice. Washington, D.C., U.S.A.
69. Wagner, E. G., and Lanoix, J. N. Excreta Disposal For Rural Areas and Small Communities. Geneva: World Health Organization, 1958.
70. World Health Organization. Reuse of Effluents: Methods of Wastewater Treatment and Health Safeguards. Technical Report Series, no. 517. Geneva, 1973.

In summary, an attempt has been made to indicate numerous materials that adequately handle areas on the periphery of the central theme of this text. Those authors, institutions, and works indicated will in turn lead to other worthwhile sources.

# APPENDIXES

## APPENDIX (CHAPTER III).

The following tables were developed for use in the predictive model to select suitable water and wastewater processes, presented in Chapter III.

Tables of per capita cost and operation and maintenance manpower requirements:

- III.1.5-14 water processes PW1 - PW10
- III.1.15-24 wastewater processes PS1 - PS10.

TABLE III.1.5

PER CAPITA COST PARAMETERS (\$U.S.) AND  
OPERATION AND MAINTENANCE MANPOWER REQUIREMENTS

PROCESS: NO TREATMENT (PW1)

Population Scale	Type of Cost	Social-Technological Levels					Manpower Required (Number of workers)		
		I	II	III	IV	Unskilled	Skilled	Professional	
1 (500 - 2,499)	Construction	8.65	6.45	5.50	6.00				
	Operation and Maintenance	0.50	0.90	1.02	2.00	1			
2 (2,500 - 14,999)	Construction	2.16	1.61	1.48	1.50				
	Operation and Maintenance	0.31	0.56	0.64	1.25	2			
3 (15,000 - 49,999)	Construction	1.08	0.80	0.66	0.75				
	Operation and Maintenance	0.12	0.25	0.31	0.50	4			
4 (50,000 - 100,000)	Construction	0.72	0.53	0.51	0.50				
	Operation and Maintenance	0.06	0.13	0.16	0.25	8			

TABLE III.1.1.6

PER CAPITA COST PARAMETERS (\$U.S.) AND  
OPERATION AND MAINTENANCE MANPOWER REQUIREMENTS

PROCESS: PRE-TREATMENT (PW2)

Population Scale	Type of Cost	Social-Technological Levels				Manpower Required (Number of workers)		
		I	II	III	IV	Unskilled	Skilled	Professional
1 (500 - 2,499)	Construction	8.87	10.76	12.51	14.59			
	Operation and Maintenance	3.27	2.95	2.19	4.00	1	1	
2 (2,500 - 14,999)	Construction	7.29	8.85	10.56	12.00			
	Operation and Maintenance	1.63	1.35	1.10	2.00	1	1	
3 (15,000 - 49,999)	Construction	4.86	6.96	7.59	8.00			
	Operation and Maintenance	0.82	0.73	0.62	1.00	3	2	1
4 (50,000 - 100,000)	Construction	1.22	1.49	2.03	2.00			
	Operation and Maintenance	0.41	0.37	0.31	0.50	5	4	1

TABLE III.1.1.7

PER CAPITA COST PARAMETERS (\$U.S.) AND  
OPERATION AND MAINTENANCE MANPOWER REQUIREMENTS

PROCESS: SLOW SAND FILTER (PW3)

Population Scale	Type of Cost	Social-Technological Levels				Manpower Required (Number of workers)		
		I	II	III	IV	Unskilled	Skilled	Professional
1 (500 - 2,499)	Construction	12.65	16.50	16.00	20.00			
	Operation and Maintenance	1.33	2.00	2.33	5.00	1		
2 (2,500 - 14,999)	Construction	9.03	11.72	11.85	14.28			
	Operation and Maintenance	0.60	0.90	1.05	2.25	2		
3 (15,000 - 49,999)	Construction	6.33	7.18	7.68	10.01			
	Operation and Maintenance	0.33	0.58	0.73	1.25	5		
4 (50,000 - 100,000)	Construction	3.95	6.98	5.21	6.25			
	Operation and Maintenance	0.20	0.35	0.44	0.75	8		

TABLE III.1.8  
 PER CAPITA COST PARAMETERS (\$U.S.) AND  
 OPERATION AND MAINTENANCE MANPOWER REQUIREMENTS  
 PROCESS: RAPID SAND FILTER--CONVENTIONAL (PW4)

Population Scale	Type of Cost	Social-Technological Levels				Manpower Required (Number of workers)		
		I	II	III	IV	Unskilled	Skilled	Professional
1 (500 - 2,499)	Construction	9.51	9.24	14.56	11.20			
	Operation and Maintenance	1.80	2.20	2.17	4.00	1	1	
2 (2,500 - 14,999)	Construction	7.47	7.26	11.51	8.80			
	Operation and Maintenance	0.90	1.10	1.08	2.00	1	1	1
3 (15,000 - 49,999)	Construction	4.24	5.58	5.25	5.00			
	Operation and Maintenance	0.79	1.05	1.12	1.75	8	2	1
4 (50,000 - 100,000)	Construction	2.25	2.96	2.83	2.65			
	Operation and Maintenance	0.67	0.90	0.89	1.50	10	3	1



TABLE III.1.1.9  
 PER CAPITA COST PARAMETERS (\$U.S.) AND  
 OPERATION AND MAINTENANCE MANPOWER REQUIREMENTS

PROCESS: RAPID SAND FILTER--ADVANCED (PW5)

Population Scale	Type of Cost	Social-Technological Levels				Manpower Required (Number of workers)		
		I	II	III	IV	Unskilled	Skilled	Professional
1 (500 - 2,499)	Construction	323.61	280.21	272.35	209.50			
	Operation and Maintenance	19.77	15.77	14.19	17.77	1	1	1
2 (2,500 - 14,999)	Construction	72.75	63.00	61.61	47.10			
	Operation and Maintenance	13.37	10.67	9.60	12.02	1	1	1
3 (15,000 - 49,999)	Construction	32.44	26.59	22.04	21.00			
	Operation and Maintenance	9.90	7.86	7.11	8.90	6	2	2
4 (50,000 - 100,000)	Construction	15.60	12.84	10.77	10.10			
	Operation and Maintenance	4.95	3.93	3.55	4.45	10	5	2

TABLE III.1.1.10  
 PER CAPITA COST PARAMETERS (\$U.S.) AND  
 OPERATION AND MAINTENANCE MANPOWER REQUIREMENTS

PROCESS: SOFTENING (PW6)

Population Scale	Type of Cost	Social-Technological Levels				Manpower Required (Number of workers)		
		I	II	III	IV	Unskilled	Skilled	Professional
1 (500 - 2,499)	Construction	255.95	221.62	215.41	165.70			
	Operation and Maintenance	14.93	11.91	10.72	13.42	1	1	1
2 (2,500 - 14,999)	Construction	172.69	149.53	146.23	111.80			
	Operation and Maintenance	8.83	7.05	6.37	7.94	1	1	1
3 (15,000 - 49,999)	Construction	127.90	104.82	86.91	82.80			
	Operation and Maintenance	6.54	5.19	4.70	5.88	6	2	2
4 (50,000 - 100,000)	Construction	63.95	52.41	44.16	41.40			
	Operation and Maintenance	3.27	2.60	2.35	2.94	10	5	2

TABLE III.1.1.11  
 PER CAPITA COST PARAMETERS (\$U.S.) AND  
 OPERATION AND MAINTENANCE MANPOWER REQUIREMENTS  
 PROCESS: DISINFECTION (PW7)

Population Scale	Type of Cost	Social-Technological Levels				Manpower Required (Number of workers)		
		I	II	III	IV	Unskilled	Skilled	Professional
1 (500 - 2,499)	Construction	5.26	5.30	5.43	4.00			
	Operation and Maintenance	9.29	6.37	5.01	5.00	1		
2 (2,500 - 14,999)	Construction	3.05	1.06	1.09	0.80			
	Operation and Maintenance	4.27	2.93	2.30	2.30	1	1	
3 (15,000 - 49,999)	Construction	1.97	2.04	1.49	1.50			
	Operation and Maintenance	3.25	2.16	1.69	1.75	2	1	1
4 (50,000 - 100,000)	Construction	1.58	1.63	1.21	1.20			
	Operation and Maintenance	2.79	1.85	1.45	1.50	4	1	1

TABLE III.1.1.12  
 PER CAPITA COST PARAMETERS (\$U.S.) AND  
 OPERATION AND MAINTENANCE MANPOWER REQUIREMENTS

PROCESS: TASTE, ODOR - Fe, Mn (PW8)

Population Scale	Type of Cost	Social-Technological Levels				Manpower Required (Number of workers)		
		I	II	III	IV	Unskilled	Skilled	Professional
		1	200.65	173.74	168.87	129.90		
(500 - 2,499)	Operation and Maintenance	23.41	12.61	16.80	21.04	1	1	1
2	Construction	135.47	117.30	114.71	87.70			
(2,500 - 14,999)	Operation and Maintenance	15.81	12.61	11.35	14.21	1	1	1
3	Construction	49.89	40.89	33.90	32.30			
(15,000 - 49,999)	Operation and Maintenance	11.70	9.29	8.40	10.52	6	2	2
4	Construction	94.38	77.35	65.17	61.10			
(50,000 - 100,000)	Operation and Maintenance	5.85	4.64	4.20	5.26	10	5	2

TABLE III.1.13

PER CAPITA COST PARAMETERS (\$U.S.) AND  
OPERATION AND MAINTENANCE MANPOWER REQUIREMENTS

PROCESS: DESALTING - SALT (PW9)

Population Scale	Type of Cost	Social-Technological Levels				Manpower Required (Number of workers)		
		I	II	III	IV	Unskilled	Skilled	Professional
1 (500 - 2,499)	Construction	326.85	283.01	275.08	211.60			
	Operation and Maintenance	8.23	6.57	5.91	7.40	1	1	1
2 (2,500 - 14,999)	Construction	233.55	202.23	197.77	151.20			
	Operation and Maintenance	7.68	6.12	5.51	6.90	1	1	1
3 (15,000 - 49,999)	Construction	167.44	137.23	113.78	108.40			
	Operation and Maintenance	5.12	4.06	3.67	4.60	6	2	2
4 (50,000 - 100,000)	Construction	83.26	68.24	57.49	53.90			
	Operation and Maintenance	2.56	2.03	1.84	2.30	10	5	2

TABLE III.1.14  
 PER CAPITA COST PARAMETERS (\$U.S.) AND  
 OPERATION AND MAINTENANCE MANPOWER REQUIREMENTS

PROCESS: DESALTING - BRACKISH (PW10)

Population Scale	Type of Cost	Social-Technological Levels				Manpower Required (Number of workers)		
		I	II	III	IV	Unskilled	Skilled	Professional
1 (500 - 2,499)	Construction	236.95	205.17	199.42	153.40			
	Operation and Maintenance	15.66	12.50	11.25	14.08	1	1	1
2 (2,500 - 14,999)	Construction	160.03	138.56	135.51	103.60			
	Operation and Maintenance	11.74	9.36	8.43	10.55	1	1	1
3 (15,000 - 49,999)	Construction	118.48	97.10	80.51	76.70			
	Operation and Maintenance	7.82	6.21	5.61	7.03	6	2	2
4 (50,000 - 100,000)	Construction	59.32	48.61	40.96	38.40			
	Operation and Maintenance	3.97	3.15	2.85	3.57	10	5	2

TABLE III.1.15  
 PER CAPITA COST PARAMETERS (\$U.S.) AND  
 OPERATION AND MAINTENANCE MANPOWER REQUIREMENTS

PROCESS: PRIMARY - CONVENTIONAL (PS1)

Population Scale	Type of Cost	Social-Technological Levels				Manpower Required (Number of workers)		
		I	II	III	IV	Unskilled	Skilled	Professional
1 (500 - 2,499)	Construction	70.34	80.30	88.00	88.00			
	Operation and Maintenance	1.65	0.99	1.17	2.56	1		
2 (2,500 - 14,999)	Construction	19.18	21.90	24.41	24.00			
	Operation and Maintenance	1.25	0.75	0.89	1.94	1		
3 (15,000 - 49,999)	Construction	15.59	16.05	16.91	19.50			
	Operation and Maintenance	1.10	0.78	0.77	1.71	2	1	
4 (50,000 - 100,000)	Construction	12.39	14.35	13.17	15.50			
	Operation and Maintenance	0.98	0.69	0.67	1.51	4	2	

TABLE III.1.16  
 PER CAPITA COST PARAMETERS (\$U.S.) AND  
 OPERATION AND MAINTENANCE MANPOWER REQUIREMENTS

PROCESS: PRIMARY - STABILIZATION POND (PS2)

Population Scale	Type of Cost	Social-Technological Levels				Manpower Required (Number of workers)		
		I	II	III	IV	Unskilled	Skilled	Professional
1 (500 - 2,499)	Construction	28.46	43.55	55.27	67.00			
	Operation and Maintenance	0.16	0.45	0.60	1.70	1		
2 (2,500 - 14,999)	Construction	2.55	3.90	5.05	6.00			
	Operation and Maintenance	0.13	0.35	0.47	1.34	2		
3 (15,000 - 49,999)	Construction	1.70	2.73	3.17	4.00			
	Operation and Maintenance	0.12	0.44	0.44	1.26	4		
4 (50,000 - 100,000)	Construction	1.64	1.82	3.59	2.70			
	Operation and Maintenance	0.10	0.35	0.45	0.65	6		



TABLE III.1.17

PER CAPITA COST PARAMETERS (\$U.S.) AND  
OPERATION AND MAINTENANCE MANPOWER REQUIREMENTS

PROCESS: SLUDGE - CONVENTIONAL (PS3)

Population Scale	Type of Cost	Social-Technological Levels				Manpower Required (Number of workers)		
		I	II	III	IV	Unskilled	Skilled	Professional
1 (500 - 2,499)	Construction	162.49	136.13	99.40	103.72			
	Operation and Maintenance	8.04	6.69	6.83	12.45	1	1	
2 (2,500 - 14,999)	Construction	95.80	80.26	61.54	61.15			
	Operation and Maintenance	4.74	3.95	4.03	7.34	1	1	
3 (15,000 - 49,999)	Construction	70.94	62.50	49.76	45.28			
	Operation and Maintenance	3.51	3.21	2.84	5.43	2	1	
4 (50,000 - 100,000)	Construction	56.37	49.66	32.38	35.98			
	Operation and Maintenance	2.78	2.55	2.15	4.31	4	2	1

TABLE III.1.18  
 PER CAPITA COST PARAMETERS (\$U.S.) AND  
 OPERATION AND MAINTENANCE MANPOWER REQUIREMENTS

PROCESS: SLUDGE - ADVANCED (PS4)

Population Scale	Type of Cost	Social-Technological Levels				Manpower Required (Number of workers)		
		I	II	III	IV	Unskilled	Skilled	Professional
1 (500 - 2,499)	Construction	201.74	169.01	123.40	128.77			
	Operation and Maintenance	16.43	18.30	18.48	25.45	1	1	
2 (2,500 - 14,999)	Construction	103.87	87.02	66.72	66.30			
	Operation and Maintenance	5.14	4.28	4.37	7.96	1	1	
3 (15,000 - 49,999)	Construction	74.42	65.57	38.30	47.50			
	Operation and Maintenance	3.68	3.37	2.98	5.70	2	1	
4 (50,000 - 100,000)	Construction	57.87	50.99	33.25	36.94			
	Operation and Maintenance	2.86	2.62	2.21	4.43	4	2	1

TABLE III.1.19

PER CAPITA COST PARAMETERS (\$U.S.) AND  
OPERATION AND MAINTENANCE MANPOWER REQUIREMENTS

PROCESS: SLUDGE - COMBINED IMHOFF (PS5)

Population Scale	Type of Cost	Social-Technological Levels				Manpower Required (Number of workers)		
		I	II	III	IV	Unskilled	Skilled	Professional
1 (500 - 2,499)	Construction	197.16	138.47	151.58	136.76			
	Operation and Maintenance	10.60	8.82	9.00	16.41	1	1	
2 (2,500 - 14,999)	Construction	112.23	78.82	88.15	77.85			
	Operation and Maintenance	6.03	5.02	5.12	9.34	1	1	
3 (15,000 - 49,999)	Construction	70.58	51.72	41.98	48.96			
	Operation and Maintenance	3.79	3.47	3.07	3.87	2	1	
4 (50,000 - 100,000)	Construction	49.82	36.51	31.10	34.56			
	Operation and Maintenance	2.67	2.45	2.06	4.14	4	1	

TABLE III.1.20  
 PER CAPITA COST PARAMETERS (\$U.S.) AND  
 OPERATION AND MAINTENANCE MANPOWER REQUIREMENTS

PROCESS: SECONDARY - STANDARD FILTER (PS6)

Population Scale	Type of Cost	Social-Technological Levels				Manpower Required (Number of workers)		
		I	II	III	IV	Unskilled	Skilled	Professional
1 (500 - 2,499)	Construction	112.89	121.59	141.57	137.00			
	Operation and Maintenance	1.40	1.81	2.06	3.92	1		
2 (2,500 - 14,999)	Construction	33.37	35.94	43.23	40.50			
	Operation and Maintenance	0.81	1.05	1.19	2.27	1	1	
3 (15,000 - 49,999)	Construction	27.19	30.83	31.22	33.00			
	Operation and Maintenance	0.64	0.94	0.91	1.79	4	1	1
4 (50,000 - 100,000)	Construction	21.84	24.76	23.85	26.50			
	Operation and Maintenance	0.51	0.75	0.70	1.42	6	2	1

TABLE III.1.1.21

PER CAPITA COST PARAMETERS (\$U.S.) AND  
OPERATION AND MAINTENANCE MANPOWER REQUIREMENTS

PROCESS: SECONDARY - HIGH RATE FILTER (PS7)

Population Scale	Type of Cost	Social-Technological Levels				Manpower Required (Number of workers)		
		I	II	III	IV	Unskilled	Skilled	Professional
1 (500 - 2,499)	Construction	336.79	291.31	238.46	225.00			
	Operation and Maintenance	35.48	40.31	40.33	42.15	1		
2 (2,500 - 14,999)	Construction	205.26	177.54	151.08	179.79			
	Operation and Maintenance	4.70	5.30	5.34	10.35	2	1	
3 (15,000 - 49,999)	Construction	148.09	135.98	133.13	129.71			
	Operation and Maintenance	1.41	1.73	1.52	3.10	4	1	1
4 (50,000 - 100,000)	Construction	49.38	45.34	44.60	43.25			
	Operation and Maintenance	0.42	0.52	0.63	0.98	6	1	1

TABLE III.1.22  
 PER CAPITA COST PARAMETERS (\$U.S.) AND  
 OPERATION AND MAINTENANCE MANPOWER REQUIREMENTS  
 PROCESS: SECONDARY - ACTIVATED SLUDGE (PS8)

Population Scale	Type of Cost	Social-Technological Levels				Manpower Required (Number of workers)		
		I	II	III	IV	Unskilled	Skilled	Professional
1 (500 - 2,499)	Construction	197.05	162.47	186.48	134.00			
	Operation and Maintenance	2.86	3.12	3.34	5.20	1	1	
2 (2,500 - 14,999)	Construction	58.82	48.74	54.67	40.00			
	Operation and Maintenance	1.94	2.11	2.26	3.52	2	1	
3 (15,000 - 49,999)	Construction	47.06	38.94	31.74	32.00			
	Operation and Maintenance	1.64	1.94	1.81	2.98	4	1	1
4 (50,000 - 100,000)	Construction	38.23	31.64	25.33	26.00			
	Operation and Maintenance	1.39	1.64	1.45	2.52	8	2	2

TABLE III.1.1.23

PER CAPITA COST PARAMETERS (\$U.S.) AND  
OPERATION AND MAINTENANCE MANPOWER REQUIREMENTS

PROCESS: SECONDARY - EXTENDED AERATION (PS9)

Population Scale	Type of Cost	Social-Technological Levels				Manpower Required (Number of workers)		
		I	II	III	IV	Unskilled	Skilled	Professional
1 (500 - 2,499)	Construction	154.00	158.81	255.37	165.00			
	Operation and Maintenance	33.21	52.82	38.86	73.14	1	1	
2 (2,500 - 14,999)	Construction	102.78	105.99	106.34	110.12			
	Operation and Maintenance	3.38	5.31	3.96	7.45	2	1	
3 (15,000 - 49,999)	Construction	88.67	93.26	81.45	95.00			
	Operation and Maintenance	1.26	2.08	1.55	2.78	4	1	1
4 (50,000 - 100,000)	Construction	23.33	24.54	21.25	25.00			
	Operation and Maintenance	0.24	0.39	0.28	0.52	6	2	1

TABLE III.1.1.24  
 PER CAPITA COST PARAMETERS (\$U.S.) AND  
 OPERATION AND MAINTENANCE MANPOWER REQUIREMENTS

PROCESS: DISINFECTION (PS10)

Population Scale	Type of Cost	Social-Technological Levels				Manpower Required (Number of workers)		
		I	II	III	IV	Unskilled	Skilled	Professional
1  (500 - 2,499)	Construction	32.01	48.72	54.13	24.32			
	Operation and Maintenance	2.12	4.20	4.23	7.50	1		
2  (2,500 - 14,999)	Construction	42.93	36.41	35.60	17.42			
	Operation and Maintenance	2.42	2.71	2.73	1.50	2		
3  (15,000 - 49,999)	Construction	20.55	27.86	27.25	15.61			
	Operation and Maintenance	1.21	2.46	2.17	0.75	4	1	1
4  (50,000 - 100,000)	Construction	14.10	20.18	19.07	10.71			
	Operation and Maintenance	0.58	1.79	1.49	0.36	6	1	1



APPENDIX (CHAPTER IV).

The following four-page "Questionnaire for Water and Waste Studies for Developing Countries" was employed to gather field data which was used in deriving predictive equations for the water/wastewater demand-cost model of Chapter IV.

For selected socio-economic and technological conditions of developing countries, the following tables contain results obtained using the prediction methodology presented in Chapter IV.

Tables of estimates of demand:

- IV.10 mean water demand (gpcd)
- IV.11 wastewater disposal (gpcd).

Tables of estimates of water treatment costs (\$1000 U.S., MGD):

- IV.12 slow sand filters
- IV.13 rapid sand filters
- IV.14 stabilization lagoons
- IV.15 aerated lagoons
- IV.16 activated sludge systems
- IV.17 trickling filters.

QUESTIONNAIRE FOR  
WATER AND WASTE STUDIES  
FOR DEVELOPING COUNTRIES  
BUREAU OF WATER RESOURCES AND ENVIRONMENTAL SCIENCES RESEARCH  
UNIVERSITY OF OKLAHOMA  
NORMAN, OKLAHOMA 73069  
U.S.A.

April 1974

1. Please supply flowing data as shown in the tables for water treatment processes. Indicate if the flow is in metric system or English (MGD), and if the cost is in local currency or in U.S. equivalent dollars.
2. Have you ever had any problem with operation and maintenance of your plants? \_\_\_\_\_ Yes \_\_\_\_\_ No  
If yes, which one and how did you overcome it? \_\_\_\_\_  
\_\_\_\_\_
3. What is the estimated daily water demand in gallons per capita per day (gpcd) \_\_\_\_\_ in litres per day \_\_\_\_\_.
4. What is the estimated wastewater demand (discharge)\* \_\_\_\_\_ (gpcd) or litres \_\_\_\_\_
5. What is the average annual local temperature\* in  $^{\circ}\text{F}$  \_\_\_\_\_ or  $^{\circ}\text{C}$  \_\_\_\_\_.
6. What is the average annual precipitation in inches\* \_\_\_\_\_.
7. Estimated price of treated water per 1000 gallons\* \_\_\_\_\_.
8. Estimated national average of persons in each household \_\_\_\_\_.
9. Estimate percent of household systems (septic tank, privy, etc.)\*  
\_\_\_\_\_.

10. Estimate percent connected to public sewerage system\* \_\_\_\_\_.
11. Estimate percent cost of imported materials for sewage treatment to the total cost\* \_\_\_\_\_.
12. Estimate percent cost of imported materials for water treatment to the total cost\* \_\_\_\_\_.
13. Average annual income in local currency \_\_\_\_\_ or U.S. dollars \_\_\_\_\_.
14. Estimate percent of national literacy \_\_\_\_\_.
15. Estimate percent of public stand post\* \_\_\_\_\_.
16. Estimate percent number of homes connected to water supply\* \_\_\_\_\_.

Please do not hesitate to send any information on water and waste treatment in your country which you feel might be of help in our studies.

Would you like to have a final report of the study? \_\_\_\_\_yes \_\_\_\_\_no.

Name and Title of individual completing questionnaire \_\_\_\_\_

Address \_\_\_\_\_

\_\_\_\_\_ Date \_\_\_\_\_

\*If local data are not available, give national data.

## WATER TREATMENT PROCESSES

(AID - UNIVERSITY OF OKLAHOMA LDC PROJECT)

Name of the Country \_\_\_\_\_

Name of City or Town							
Population							
Year Construction Completed							
Type of Treatment Plant (e.g. slow sand filter or rapid sand filter)							
Population Served***							
Design Capacity Million Gallons per Day (MGD)*							
Construction Cost (in local currency or U.S. dollars)**							
Operation & Maintenance Cost/Year (in local currency or U.S. dollars)**							

\* If design capacity is in metric system please indicate

\*\* Please indicate currency

\*\*\*Is population served (population of the city) same as design population? Yes \_\_\_\_\_ No \_\_\_\_\_ If no, what is the number \_\_\_\_\_

WASTEWATER TREATMENT PROCESSES  
(AID - UNIVERSITY OF OKLAHOMA LDC PROJECT)

Name of the Country \_\_\_\_\_

Name of City or Town							
Population							
Year Construction Completed							
Type of Treatment Plant (e.g. Lagoon Activated Sludge, etc.)							
Population Served***							
Flow into Treatment Plant							
5-Day BOD of Influent							
5-Day BOD of Effluent							
Construction Cost (in local currency or U.S. Dollars)**							
Operation & Maintenance Cost per Year (in local currency or U.S. dollars)**							

TABLE IV.10

ESTIMATED MEAN WATER DEMAND IN GALLONS PER CAPITA  
PER DAY FOR SELECTED CONDITIONS

$X_2$	$X_5$	$X_6$	$D_{w.af}$	$D_{w.as}$	$D_{w.la}$
5	5	75	21	10	17
5	5	325	25	17	25
5	5	575	28	23	33
5	5	825	32	30	42
5	5	1075	35	36	50
5	5	1325	39	43	58
5	5	1575	42	49	66
5	5	1825	46	56	75
5	5	2075	50	63	83
5	5	2325	53	69	91
5	5	2575	57	76	99
5	5	2825	60	82	108
5	5	3075	64	89	116
5	5	3325	67	95	124
5	5	3575	71	102	132
5	5	3825	74	109	141
5	25	75	21	14	18
5	25	325	25	21	27
5	25	575	28	28	35
5	25	825	32	34	43
5	25	1075	35	41	51
5	25	1325	39	47	60
5	25	1575	42	54	68
5	25	1825	46	60	76
5	25	2075	50	67	84
5	25	2325	53	74	93
5	25	2575	57	80	101
5	25	2825	60	87	109
5	25	3075	64	93	117
5	25	3325	67	100	126
5	25	3575	71	106	134
5	25	3825	74	113	142
5	45	75	21	19	20
5	45	325	25	25	28
5	45	575	28	32	36
5	45	825	32	39	44
5	45	1075	35	45	53
5	45	1325	39	52	61
5	45	1575	42	58	69
5	45	1825	46	65	77
5	45	2075	50	71	86
5	45	2325	53	78	94
5	45	2575	57	85	102
5	45	2825	60	91	110
5	45	3075	64	98	119
5	45	3325	67	104	127
5	45	3575	71	111	135
5	45	3825	74	117	143
5	65	75	21	23	21
5	65	325	25	30	29
5	65	575	28	36	37
5	65	825	32	43	46
5	65	1075	35	50	54
5	65	1325	39	56	62
5	65	1575	42	63	71
5	65	1825	46	69	79
5	65	2075	50	76	87
5	65	2325	53	82	95
5	65	2575	57	89	104
5	65	2825	60	96	112
5	65	3075	64	102	120
5	65	3325	67	109	128
5	65	3575	71	115	137

TABLE IV.10--Continued

$X_2$	$X_5$	$X_6$	$D_{w.af}$	$D_{w.as}$	$D_{w.la}$
5	65	3825	74	122	145
5	85	75	21	28	22
5	85	325	25	34	31
5	85	575	28	41	39
5	85	825	32	47	47
5	85	1075	35	54	55
5	85	1325	39	60	64
5	85	1575	42	67	72
5	85	1825	46	74	80
5	85	2075	50	80	88
5	85	2325	53	87	97
5	85	2575	57	93	105
5	85	2825	60	100	113
5	85	3075	64	107	121
5	85	3325	67	113	130
5	85	3575	71	120	138
5	85	3825	74	126	146
40	5	75	24	12	19
40	5	325	27	18	27
40	5	575	31	25	36
40	5	825	34	31	44
40	5	1075	38	38	52
40	5	1325	41	44	60
40	5	1575	45	51	69
40	5	1825	48	58	77
40	5	2075	52	64	85
40	5	2325	55	71	93
40	5	2575	59	77	102
40	5	2825	63	84	110
40	5	3075	66	90	118
40	5	3325	70	97	126
40	5	3575	73	104	135
40	5	3825	77	110	143
40	25	75	24	16	21
40	25	325	27	23	29
40	25	575	31	29	37
40	25	825	34	36	45
40	25	1075	38	42	54
40	25	1325	41	49	62
40	25	1575	45	55	70
40	25	1825	48	62	78
40	25	2075	52	69	87
40	25	2325	55	75	95
40	25	2575	59	82	103
40	25	2825	63	88	111
40	25	3075	66	95	120
40	25	3325	70	101	128
40	25	3575	73	108	136
40	25	3825	77	115	144
40	45	75	24	20	22
40	45	325	27	27	30
40	45	575	31	34	38
40	45	825	34	40	47
40	45	1075	38	47	55
40	45	1325	41	53	63
40	45	1575	45	60	71
40	45	1825	48	66	80
40	45	2075	52	73	88
40	45	2325	55	80	96
40	45	2575	59	86	104
40	45	2825	63	93	113
40	45	3075	66	99	121
40	45	3325	70	106	129
40	45	3575	73	112	137
40	45	3825	77	119	146
40	65	75	24	25	23

TABLE IV.10--Continued

$X_2$	$X_5$	$X_6$	D w.af	D w.as	D w.1a
40	65	325	27	31	31
40	65	575	31	38	40
40	65	825	34	45	48
40	65	1075	38	51	56
40	65	1325	41	58	65
40	65	1575	45	64	73
40	65	1825	48	71	81
40	65	2075	52	77	89
40	65	2325	55	84	98
40	65	2575	59	91	106
40	65	2825	63	97	114
40	65	3075	66	104	122
40	65	3325	70	110	131
40	65	3575	73	117	139
40	65	3825	77	123	147
40	85	75	24	29	25
40	85	325	27	36	33
40	85	575	31	42	41
40	85	825	34	49	49
40	85	1075	38	56	58
40	85	1325	41	62	66
40	85	1575	45	69	74
40	85	1825	48	75	82
40	85	2075	52	82	91
40	85	2325	55	88	99
40	85	2575	59	95	107
40	85	2825	63	102	115
40	85	3075	66	108	124
40	85	3325	70	115	132
40	85	3575	73	121	140
40	85	3825	77	128	148
75	5	75	26	13	21
75	5	325	29	20	30
75	5	575	33	26	38
75	5	825	37	33	46
75	5	1075	40	40	54
75	5	1325	44	46	63
75	5	1575	47	53	71
75	5	1825	51	59	79
75	5	2075	54	66	87
75	5	2325	58	72	96
75	5	2575	61	79	104
75	5	2825	65	86	112
75	5	3075	69	92	120
75	5	3325	72	99	129
75	5	3575	76	105	137
75	5	3825	79	112	145
75	25	75	26	18	23
75	25	325	29	24	31
75	25	575	33	31	39
75	25	825	37	37	48
75	25	1075	40	44	56
75	25	1325	44	50	64
75	25	1575	47	57	72
75	25	1825	51	64	81
75	25	2075	54	70	89
75	25	2325	58	77	97
75	25	2575	61	83	105
75	25	2825	65	90	114
75	25	3075	69	97	122
75	25	3325	72	103	130
75	25	3575	76	110	138
75	25	3825	79	116	147
75	45	75	26	22	24
75	45	325	29	29	32



TABLE IV.10--Continued

$X_2$	$X_5$	$X_6$	$D_{w.af}$	$D_{w.as}$	$D_{w.la}$
75	45	575	33	35	41
75	45	825	37	42	49
75	45	1075	40	48	57
75	45	1325	44	55	65
75	45	1575	47	61	74
75	45	1825	51	68	82
75	45	2075	54	75	90
75	45	2325	58	81	98
75	45	2575	61	88	107
75	45	2825	65	94	115
75	45	3075	69	101	123
75	45	3325	72	107	131
75	45	3575	76	114	140
75	45	3825	79	121	148
75	65	75	26	26	25
75	65	325	29	33	34
75	65	575	33	40	42
75	65	825	37	46	50
75	65	1075	40	53	59
75	65	1325	44	59	67
75	65	1575	47	66	75
75	65	1825	51	72	83
75	65	2075	54	79	92
75	65	2325	58	86	100
75	65	2575	61	92	108
75	65	2825	65	99	116
75	65	3075	69	105	125
75	65	3325	72	112	133
75	65	3575	76	118	141
75	65	3825	79	125	149
75	85	75	26	31	27
75	85	325	29	37	35
75	85	575	33	44	43
75	85	825	37	51	52
75	85	1075	40	57	60
75	85	1325	44	64	68
75	85	1575	47	70	76
75	85	1825	51	77	85
75	85	2075	54	83	93
75	85	2325	58	90	101
75	85	2575	61	97	109
75	85	2825	65	103	118
75	85	3075	69	110	126
75	85	3325	72	116	134
75	85	3575	76	123	142
75	85	3825	79	129	151
110	5	75	28	15	24
110	5	325	32	21	32
110	5	575	35	28	40
110	5	825	39	35	48
110	5	1075	42	41	57
110	5	1325	46	48	65
110	5	1575	50	54	73
110	5	1825	53	61	81
110	5	2075	57	67	90
110	5	2325	60	74	98
110	5	2575	64	81	106
110	5	2825	67	87	114
110	5	3075	71	94	123
110	5	3325	74	100	131
110	5	3575	78	107	139
110	5	3825	82	113	148
110	25	75	28	19	25
110	25	325	32	26	33
110	25	575	35	32	42
110	25	825	39	39	50

TABLE IV.10--Continued

$X_2$	$X_5$	$X_6$	$D_{w.af}$	$D_{w.as}$	$D_{w.la}$
110	25	1075	42	46	58
110	25	1325	46	52	66
110	25	1575	50	59	75
110	25	1825	53	65	83
110	25	2075	57	72	91
110	25	2325	60	78	99
110	25	2575	64	85	108
110	25	2825	67	92	116
110	25	3075	71	98	124
110	25	3325	74	105	132
110	25	3575	78	111	141
110	25	3825	82	118	149
110	45	75	28	24	26
110	45	325	32	30	35
110	45	575	35	37	43
110	45	825	39	43	51
110	45	1075	42	50	59
110	45	1325	46	57	68
110	45	1575	50	63	76
110	45	1825	53	70	84
110	45	2075	57	76	92
110	45	2325	60	83	101
110	45	2575	64	89	109
110	45	2825	67	96	117
110	45	3075	71	103	125
110	45	3325	74	109	134
110	45	3575	78	116	142
110	45	3825	82	122	150
110	65	75	28	28	28
110	65	325	32	35	36
110	65	575	35	41	44
110	65	825	39	48	53
110	65	1075	42	54	61
110	65	1325	46	61	69
110	65	1575	50	67	77
110	65	1825	53	74	86
110	65	2075	57	81	94
110	65	2325	60	87	102
110	65	2575	64	94	110
110	65	2825	67	100	119
110	65	3075	71	107	127
110	65	3325	74	114	135
110	65	3575	78	120	143
110	65	3825	82	127	152
110	85	75	28	32	29
110	85	325	32	39	37
110	85	575	35	46	46
110	85	825	39	52	54
110	85	1075	42	59	62
110	85	1325	46	65	70
110	85	1575	50	72	79
110	85	1825	53	78	87
110	85	2075	57	85	95
110	85	2325	60	92	103
110	85	2575	64	98	112
110	85	2825	67	105	120
110	85	3075	71	111	128
110	85	3325	74	118	136
110	85	3575	78	124	145
110	85	3825	82	131	153
145	5	75	31	16	26
145	5	325	34	23	34
145	5	575	38	30	42
145	5	825	41	36	51
145	5	1075	45	43	59
145	5	1325	48	49	67

TABLE IV.10--Continued

$X_2$	$X_5$	$X_6$	$D_{w.af}$	$D_{w.as}$	$D_{w.la}$
145	5	1575	52	56	75
145	5	1825	56	62	84
145	5	2075	59	69	92
145	5	2325	63	76	100
145	5	2575	66	82	108
145	5	2825	70	89	117
145	5	3075	73	95	125
145	5	3325	77	102	133
145	5	3575	80	108	142
145	5	3825	84	115	150
145	25	75	31	21	27
145	25	325	34	27	36
145	25	575	38	34	44
145	25	825	41	41	52
145	25	1075	45	47	60
145	25	1325	48	54	69
145	25	1575	52	60	77
145	25	1825	56	67	85
145	25	2075	59	73	93
145	25	2325	63	80	102
145	25	2575	66	87	110
145	25	2825	70	93	118
145	25	3075	73	100	126
145	25	3325	77	106	135
145	25	3575	80	113	143
145	25	3825	84	119	151
145	45	75	31	25	29
145	45	325	34	32	37
145	45	575	38	38	45
145	45	825	41	45	53
145	45	1075	45	52	62
145	45	1325	48	58	70
145	45	1575	52	65	78
145	45	1825	56	71	86
145	45	2075	59	78	95
145	45	2325	63	84	103
145	45	2575	66	91	111
145	45	2825	70	98	119
145	45	3075	73	104	128
145	45	3325	77	111	136
145	45	3575	80	117	144
145	45	3825	84	124	153
145	65	75	31	30	30
145	65	325	34	36	38
145	65	575	38	43	47
145	65	825	41	49	55
145	65	1075	45	56	63
145	65	1325	48	63	71
145	65	1575	52	69	80
145	65	1825	56	76	88
145	65	2075	59	82	96
145	65	2325	63	89	104
145	65	2575	66	95	113
145	65	2825	70	102	121
145	65	3075	73	109	129
145	65	3325	77	115	137
145	65	3575	80	122	146
145	65	3825	84	128	154
145	85	75	31	34	31
145	85	325	34	41	40
145	85	575	38	47	48
145	85	825	41	54	56
145	85	1075	45	60	64
145	85	1325	48	67	73
145	85	1575	52	74	81

TABLE IV.10--Continued

$X_2$	$X_5$	$X_6$	D. w.af	D. w.as	D. w.la
145	85	1825	56	80	89
145	85	2075	59	87	97
145	85	2325	63	93	106
145	85	2575	66	100	114
145	85	2825	70	106	122
145	85	3075	73	113	130
145	85	3325	77	120	139
145	85	3575	80	126	147
145	85	3825	84	133	155

TABLE IV.11  
ESTIMATED WASTEWATER DISPOSAL IN GALLONS PER CAPITA  
PER DAY FOR SELECTED CONDITIONS

$D_w$	$X_{10}$	$X_{11}$	$D_{ww.af}$	$D_{ww.as}$	$D_{ww.la}$
10	5	2	5	6	6
10	5	4	5	6	6
10	5	6	5	6	6
10	5	8	5	6	6
10	5	10	5	6	6
10	5	12	5	6	6
10	5	14	5	6	6
10	20	2	5	6	6
10	20	4	5	6	6
10	20	6	5	6	6
10	20	8	5	6	6
10	20	10	5	6	6
10	20	12	5	6	6
10	20	14	5	6	6
10	35	2	5	6	6
10	35	4	5	6	6
10	35	6	5	6	6
10	35	8	5	6	6
10	35	10	5	6	6
10	35	12	5	6	6
10	35	14	5	6	6
10	50	2	5	6	6
10	50	4	5	6	6
10	50	6	5	6	6
10	50	8	5	6	6
10	50	10	5	6	6
10	50	12	5	6	6
10	50	14	5	6	6
10	65	2	6	6	6
10	65	4	5	6	6
10	65	6	5	6	6
10	65	8	5	6	6
10	65	10	5	6	6
10	65	12	5	6	6
10	65	14	5	6	6
10	80	2	6	6	6
10	80	4	6	6	6
10	80	6	5	6	6
10	80	8	5	6	6
10	80	10	5	6	6
10	80	12	5	6	6
10	80	14	5	6	6
25	5	2	12	13	16
25	5	4	12	13	15
25	5	6	12	13	15
25	5	8	11	13	15
25	5	10	11	13	15
25	5	12	11	13	15
25	5	14	11	13	15
25	20	2	12	13	16
25	20	4	12	13	15
25	20	6	12	13	15
25	20	8	12	13	15
25	20	10	11	13	15
25	20	12	11	13	15
25	20	14	11	13	15
25	35	2	12	13	16
25	35	4	12	13	15
25	35	6	12	13	15
25	35	8	12	13	15
25	35	10	12	13	15
25	35	12	12	13	15
25	35	14	11	13	15
25	50	2	12	13	16

TABLE IV.11--Continued

D <sub>w</sub>	X <sub>10</sub>	X <sub>11</sub>	D <sub>w.af</sub>	D <sub>w.as</sub>	D <sub>w.la</sub>
25	50	4	12	13	15
25	50	6	12	13	15
25	50	8	12	13	15
25	50	10	12	13	15
25	50	12	12	13	15
25	50	14	12	13	15
25	65	2	12	13	16
25	65	4	12	13	15
25	65	6	12	13	15
25	65	8	12	13	15
25	65	10	12	13	15
25	65	12	12	13	15
25	65	14	12	13	15
25	80	2	12	13	16
25	80	4	12	13	15
25	80	6	12	13	15
25	80	8	12	13	15
25	80	10	12	13	15
25	80	12	12	13	15
25	80	14	12	13	15
40	5	2	18	19	25
40	5	4	18	19	25
40	5	6	18	19	25
40	5	8	18	19	25
40	5	10	18	19	24
40	5	12	18	19	24
40	5	14	18	19	24
40	20	2	18	20	25
40	20	4	18	20	25
40	20	6	18	20	25
40	20	8	18	20	25
40	20	10	18	20	24
40	20	12	18	20	24
40	20	14	18	20	24
40	35	2	19	20	25
40	35	4	18	20	25
40	35	6	18	20	25
40	35	8	18	20	25
40	35	10	18	20	24
40	35	12	18	20	24
40	35	14	18	20	24
40	50	2	19	20	25
40	50	4	19	20	25
40	50	6	18	20	25
40	50	8	18	20	25
40	50	10	18	20	24
40	50	12	18	20	24
40	50	14	18	20	24
40	65	2	19	20	25
40	65	4	19	20	25
40	65	6	19	20	25
40	65	8	19	20	25
40	65	10	18	20	24
40	65	12	18	20	24
40	65	14	18	20	24
40	80	2	19	20	25
40	80	4	19	20	25
40	80	6	19	20	25
40	80	8	19	20	25
40	80	10	19	20	24
40	80	12	19	20	24
40	80	14	18	20	24
55	5	2	25	26	34
55	5	4	25	26	34
55	5	6	25	26	34
55	5	8	25	26	34

TABLE IV.11--Continued

$D_w$	$X_{10}$	$X_{11}$	$D_{ww.af}$	$D_{ww.as}$	$D_{ww.la}$
55	5	10	25	26	34
55	5	12	25	26	34
55	5	14	24	26	34
55	20	2	25	26	34
55	20	4	25	26	34
55	20	6	25	26	34
55	20	8	25	26	34
55	20	10	25	26	34
55	20	12	25	26	34
55	20	14	25	26	34
55	35	2	25	27	34
55	35	4	25	27	34
55	35	6	25	27	34
55	35	8	25	27	34
55	35	10	25	27	34
55	35	12	25	27	34
55	35	14	25	27	34
55	50	2	25	27	34
55	50	4	25	27	34
55	50	6	25	27	34
55	50	8	25	27	34
55	50	10	25	27	34
55	50	12	25	27	34
55	50	14	25	27	34
55	65	2	25	27	34
55	65	4	25	27	34
55	65	6	25	27	34
55	65	8	25	27	34
55	65	10	25	27	34
55	65	12	25	27	34
55	65	14	25	27	34
55	80	2	25	27	34
55	80	4	25	27	34
55	80	6	25	27	34
55	80	8	25	27	34
55	80	10	25	27	34
55	80	12	25	27	34
55	80	14	25	27	34
70	5	2	32	33	43
70	5	4	31	33	43
70	5	6	31	33	43
70	5	8	31	33	43
70	5	10	31	33	43
70	5	12	31	33	43
70	5	14	31	33	43
70	20	2	32	33	43
70	20	4	32	33	43
70	20	6	31	33	43
70	20	8	31	33	43
70	20	10	31	33	43
70	20	12	31	33	43
70	20	14	31	33	43
70	35	2	32	33	43
70	35	4	32	33	43
70	35	6	32	33	43
70	35	8	32	33	43
70	35	10	31	33	43
70	35	12	31	33	43
70	35	14	31	33	43
70	50	2	32	34	43
70	50	4	32	34	43
70	50	6	32	34	43
70	50	8	32	34	43
70	50	10	32	34	43
70	50	12	32	34	43

TABLE IV.11--Continued

$D_w$	$X_{10}$	$X_{11}$	$D_{w.af}$	$D_{w.as}$	$D_{w.la}$
70	50	14	31	34	43
70	65	2	32	34	43
70	65	4	32	34	43
70	65	6	32	34	43
70	65	8	32	34	43
70	65	10	32	34	43
70	65	12	32	34	43
70	65	14	32	34	43
70	80	2	32	34	43
70	80	4	32	34	43
70	80	6	32	34	43
70	80	8	32	34	43
70	80	10	32	34	43
70	80	12	32	34	43
70	80	14	32	34	43
85	5	2	38	40	53
85	5	4	38	40	52
85	5	6	38	40	52
85	5	8	38	40	52
85	5	10	38	40	52
85	5	12	38	40	52
85	5	14	38	40	52
85	20	2	38	40	53
85	20	4	38	40	52
85	20	6	38	40	52
85	20	8	38	40	52
85	20	10	38	40	52
85	20	12	38	40	52
85	20	14	38	40	52
85	35	2	38	40	53
85	35	4	38	40	52
85	35	6	38	40	52
85	35	8	38	40	52
85	35	10	38	40	52
85	35	12	38	40	52
85	35	14	38	40	52
85	50	2	38	40	53
85	50	4	38	40	52
85	50	6	38	40	52
85	50	8	38	40	52
85	50	10	38	40	52
85	50	12	38	40	52
85	50	14	38	40	52
85	65	2	39	41	53
85	65	4	39	41	52
85	65	6	38	41	52
85	65	8	38	41	52
85	65	10	38	41	52
85	65	12	38	41	52
85	65	14	38	41	52
85	80	2	39	41	53
85	80	4	39	41	52
85	80	6	39	41	52
85	80	8	39	41	52
85	80	10	38	41	52
85	80	12	38	41	52
85	80	14	38	41	52
100	5	2	45	47	62
100	5	4	45	47	62
100	5	6	45	47	62
100	5	8	45	47	62
100	5	10	44	47	61
100	5	12	44	47	61
100	5	14	44	47	61
100	20	2	45	47	62
100	20	4	45	47	62



TABLE IV.11--Continued

$D_w$	$X_{10}$	$X_{11}$	$D_{w.af}$	$D_{w.as}$	$D_{w.la}$
100	20	6	45	47	62
100	20	8	45	47	62
100	20	10	45	47	61
100	20	12	45	47	61
100	20	14	44	47	61
100	35	2	45	47	62
100	35	4	45	47	62
100	35	6	45	47	62
100	35	8	45	47	62
100	35	10	45	47	61
100	35	12	45	47	61
100	35	14	45	47	61
100	50	2	45	47	62
100	50	4	45	47	62
100	50	6	45	47	62
100	50	8	45	47	62
100	50	10	45	47	61
100	50	12	45	47	61
100	50	14	45	47	61
100	65	2	45	47	62
100	65	4	45	47	62
100	65	6	45	47	62
100	65	8	45	47	62
100	65	10	45	47	61
100	65	12	45	47	61
100	65	14	45	47	61
100	80	2	45	48	62
100	80	4	45	48	62
100	80	6	45	48	62
100	80	8	45	48	62
100	80	10	45	48	61
100	80	12	45	48	61
100	80	14	45	48	61

TABLE IV.12

ESTIMATED COST OF WATER TREATMENT PER MGD FOR SELECTED CONDITIONS  
(SLOW SAND FILTER) IN 1000 U.S. DOLLARS

$D_w$	$X_{13}$	$X_{14}$	$X_{15}$	$C''_{w.af}$	$C'''_{w.af}$	$C''_{w.as}$	$C'''_{w.as}$	$C''_{w.la}$	$C'''_{w.la}$
5	3	5	0.25	26	12	43	15	39	13
5	3	5	2.50	26	3	34	5	39	3
5	3	5	4.75	26	2	31	4	39	2
5	3	5	7.00	26	2	30	3	39	2
5	3	5	9.25	26	1	29	3	39	1
5	3	5	11.50	26	1	29	2	39	1
5	3	35	0.25	20	12	43	13	34	13
5	3	35	2.50	20	3	34	4	34	3
5	3	35	4.75	20	2	31	3	34	2
5	3	35	7.00	20	2	30	2	34	2
5	3	35	9.25	20	1	29	2	34	1
5	3	35	11.50	20	1	29	2	34	1
5	3	65	0.25	18	12	43	12	32	13
5	3	65	2.50	18	3	34	4	32	3
5	3	65	4.75	18	2	31	3	32	2
5	3	65	7.00	18	2	30	2	32	2
5	3	65	9.25	18	1	29	2	32	1
5	3	65	11.50	18	1	29	2	32	1
5	7	5	0.25	26	12	43	15	39	13
5	7	5	2.50	26	3	34	5	39	3
5	7	5	4.75	26	2	32	4	39	2
5	7	5	7.00	26	2	30	3	39	2
5	7	5	9.25	26	1	30	3	39	1
5	7	5	11.50	26	1	29	2	39	1
5	7	35	0.25	20	12	43	13	34	13
5	7	35	2.50	20	3	34	4	34	3
5	7	35	4.75	20	2	32	3	34	2
5	7	35	7.00	20	2	30	2	34	2
5	7	35	9.25	20	1	30	2	34	1
5	7	35	11.50	20	1	29	2	34	1
5	7	65	0.25	18	12	43	12	32	13
5	7	65	2.50	18	3	34	4	32	3
5	7	65	4.75	18	2	32	3	32	2
5	7	65	7.00	18	2	30	2	32	2
5	7	65	9.25	18	1	30	2	32	1
5	7	65	11.50	18	1	29	2	32	1
5	11	5	0.25	26	12	44	15	39	13
5	11	5	2.50	26	3	34	5	39	3
5	11	5	4.75	26	2	32	4	39	2
5	11	5	7.00	26	2	31	3	39	2
5	11	5	9.25	26	1	30	3	39	1
5	11	5	11.50	26	1	29	2	39	1
5	11	35	0.25	20	12	44	13	34	13
5	11	35	2.50	20	3	34	4	34	3
5	11	35	4.75	20	2	32	3	34	2
5	11	35	7.00	20	2	31	2	34	2
5	11	35	9.25	20	1	30	2	34	1
5	11	35	11.50	20	1	29	2	34	1
5	11	65	0.25	18	12	44	12	32	13
5	11	65	2.50	18	3	34	4	32	3
5	11	65	4.75	18	2	32	3	32	2
5	11	65	7.00	18	2	31	2	32	2
5	11	65	9.25	18	1	30	2	32	1
5	11	65	11.50	18	1	29	2	32	1
25	3	5	0.25	26	12	43	15	39	13
25	3	5	2.50	26	3	34	5	39	3
25	3	5	4.75	26	2	31	4	39	2
25	3	5	7.00	26	2	30	3	39	2
25	3	5	9.25	26	1	29	3	39	1
25	3	5	11.50	26	1	29	2	39	1
25	3	35	0.25	20	12	43	13	34	13
25	3	35	2.50	20	3	34	4	34	3

TABLE IV.12--Continued

$D_w$	$X_{13}$	$X_{14}$	$X_{15}$	$C''_{w.af}$	$C''''_{w.af}$	$C''_{w.as}$	$C''''_{w.as}$	$C''_{w.la}$	$C''''_{w.la}$
25	3	35	4.75	20	2	31	3	34	2
25	3	35	7.00	20	2	30	2	34	2
25	3	35	9.25	20	1	29	2	34	1
25	3	35	11.50	20	1	29	2	34	1
25	3	65	0.25	19	12	43	12	32	13
25	3	65	2.50	19	3	34	4	32	3
25	3	65	4.75	19	2	31	3	32	2
25	3	65	7.00	19	2	30	2	32	2
25	3	65	9.25	19	1	29	2	32	1
25	3	65	11.50	19	1	29	2	32	1
25	7	5	0.25	26	12	43	15	39	13
25	7	5	2.50	26	3	34	5	39	3
25	7	5	4.75	26	2	32	4	39	2
25	7	5	7.00	26	2	30	3	39	2
25	7	5	9.25	26	1	30	3	39	1
25	7	5	11.50	26	1	29	2	39	1
25	7	35	0.25	20	12	43	13	34	13
25	7	35	2.50	20	3	34	4	34	3
25	7	35	4.75	20	2	32	3	34	2
25	7	35	7.00	20	2	30	2	34	2
25	7	35	9.25	20	1	30	2	34	1
25	7	35	11.50	20	1	29	2	34	1
25	7	65	0.25	19	12	43	12	32	13
25	7	65	2.50	19	3	34	4	32	3
25	7	65	4.75	19	2	32	3	32	2
25	7	65	7.00	19	2	30	2	32	2
25	7	65	9.25	19	1	30	2	32	1
25	7	65	11.50	19	1	29	2	32	1
25	11	5	0.25	26	12	44	15	39	13
25	11	5	2.50	26	3	34	5	39	3
25	11	5	4.75	26	2	32	4	39	2
25	11	5	7.00	26	2	31	3	39	2
25	11	5	9.25	26	1	30	3	39	1
25	11	5	11.50	26	1	29	2	39	1
25	11	35	0.25	20	12	44	13	34	13
25	11	35	2.50	20	3	34	4	34	3
25	11	35	4.75	20	2	32	3	34	2
25	11	35	7.00	20	2	31	2	34	2
25	11	35	9.25	20	1	30	2	34	1
25	11	35	11.50	20	1	29	2	34	1
25	11	65	0.25	19	12	44	12	32	13
25	11	65	2.50	19	3	34	4	32	3
25	11	65	4.75	19	2	32	3	32	2
25	11	65	7.00	19	2	31	2	32	2
25	11	65	9.25	19	1	30	2	32	1
25	11	65	11.50	19	1	29	2	32	1
45	3	5	0.25	26	12	43	15	39	13
45	3	5	2.50	26	3	34	5	39	3
45	3	5	4.75	26	2	31	4	39	2
45	3	5	7.00	26	2	30	3	39	2
45	3	5	9.25	26	1	29	3	39	1
45	3	5	11.50	26	1	29	2	39	1
45	3	35	0.25	20	12	43	13	34	13
45	3	35	2.50	20	3	34	4	34	3
45	3	35	4.75	20	2	31	3	34	2
45	3	35	7.00	20	2	30	2	34	2
45	3	35	9.25	20	1	29	2	34	1
45	3	35	11.50	20	1	29	2	34	1
45	3	65	0.25	19	12	43	12	32	13
45	3	65	2.50	19	3	34	4	32	3
45	3	65	4.75	19	2	31	3	32	2
45	3	65	7.00	19	2	30	2	32	2
45	3	65	9.25	19	1	29	2	32	1
45	3	65	11.50	19	1	29	2	32	1
45	7	5	0.25	26	12	43	15	39	13

TABLE IV.12--Continued

D <sub>w</sub>	X <sub>13</sub>	X <sub>14</sub>	X <sub>15</sub>	C'' w.af	C'''' w.af	C'' w.as	C'''' w.as	C'' w.la	C'''' w.la
45	7	5	2.50	26	3	34	5	39	3
45	7	5	4.75	26	2	32	4	39	2
45	7	5	7.00	26	2	30	3	39	2
45	7	5	9.25	26	1	30	3	39	1
45	7	5	11.50	26	1	29	2	39	1
45	7	35	0.25	20	12	43	13	34	13
45	7	35	2.50	20	3	34	4	34	3
45	7	35	4.75	20	2	32	3	34	2
45	7	35	7.00	20	2	30	2	34	2
45	7	35	9.25	20	1	30	2	34	1
45	7	35	11.50	20	1	29	2	34	1
45	7	65	0.25	19	12	43	12	32	13
45	7	65	2.50	19	3	34	4	32	3
45	7	65	4.75	19	2	32	3	32	2
45	7	65	7.00	19	2	30	2	32	2
45	7	65	9.25	19	1	30	2	32	1
45	7	65	11.50	19	1	29	2	32	1
45	11	5	0.25	26	12	44	15	39	13
45	11	5	2.50	26	3	34	5	39	3
45	11	5	4.75	26	2	32	4	39	2
45	11	5	7.00	26	2	31	3	39	2
45	11	5	9.25	26	1	30	3	39	1
45	11	5	11.50	26	1	29	2	39	1
45	11	35	0.25	20	12	44	13	34	13
45	11	35	2.50	20	3	34	4	34	3
45	11	35	4.75	20	2	32	3	34	2
45	11	35	7.00	20	2	31	2	34	2
45	11	35	9.25	20	1	30	2	34	1
45	11	35	11.50	20	1	29	2	34	1
45	11	65	0.25	19	12	44	12	32	13
45	11	65	2.50	19	3	34	4	32	3
45	11	65	4.75	19	2	32	3	32	2
45	11	65	7.00	19	2	31	2	32	2
45	11	65	9.25	19	1	30	2	32	1
45	11	65	11.50	19	1	29	2	32	1
65	3	5	0.25	27	12	43	15	39	13
65	3	5	2.50	27	3	34	5	39	3
65	3	5	4.75	27	2	31	4	39	2
65	3	5	7.00	27	2	30	3	39	2
65	3	5	9.25	27	1	29	3	39	1
65	3	5	11.50	27	1	29	2	39	1
65	3	35	0.25	21	12	43	13	34	13
65	3	35	2.50	21	3	34	4	34	3
65	3	35	4.75	21	2	31	3	34	2
65	3	35	7.00	21	2	30	2	34	2
65	3	35	9.25	21	1	29	2	34	1
65	3	35	11.50	21	1	29	2	34	1
65	3	65	0.25	19	12	43	12	32	13
65	3	65	2.50	19	3	34	4	32	3
65	3	65	4.75	19	2	31	3	32	2
65	3	65	7.00	19	2	30	2	32	2
65	3	65	9.25	19	1	29	2	32	1
65	3	65	11.50	19	1	29	2	32	1
65	7	5	0.25	27	12	43	15	39	13
65	7	5	2.50	27	3	34	5	39	3
65	7	5	4.75	27	2	32	4	39	2
65	7	5	7.00	27	2	30	3	39	2
65	7	5	9.25	27	1	30	3	39	1
65	7	5	11.50	27	1	29	2	39	1
65	7	35	0.25	21	12	43	13	34	13
65	7	35	2.50	21	3	34	4	34	3
65	7	35	4.75	21	2	32	3	34	2
65	7	35	7.00	21	2	30	2	34	2
65	7	35	9.25	21	1	30	2	34	1

TABLE IV.12--Continued

$D_w$	$X_{13}$	$X_{14}$	$X_{15}$	$C''_{w.af}$	$C''''_{w.af}$	$C''_{w.as}$	$C''''_{w.as}$	$C''_{w.la}$	$C''''_{w.la}$
65	7	65	2.50	19	3	34	4	32	3
65	7	65	4.75	19	2	32	3	32	2
65	7	65	7.00	19	2	30	2	32	2
65	7	65	9.25	19	1	30	2	32	1
65	7	65	11.50	19	1	29	2	32	1
65	11	5	0.25	27	12	44	15	39	13
65	11	5	2.50	27	3	34	5	39	3
65	11	5	4.75	27	2	32	4	39	2
65	11	5	7.00	27	2	31	3	39	2
65	11	5	9.25	27	1	30	3	39	1
65	11	5	11.50	27	1	29	2	39	1
65	11	35	0.25	21	12	44	13	34	13
65	11	35	2.50	21	3	34	4	34	3
65	11	35	4.75	21	2	32	3	34	2
65	11	35	7.00	21	2	31	2	34	2
65	11	35	9.25	21	1	30	2	34	1
65	11	35	11.50	21	1	29	2	34	1
65	11	65	0.25	19	12	44	12	32	13
65	11	65	2.50	19	3	34	4	32	3
65	11	65	4.75	19	2	32	3	32	2
65	11	65	7.00	19	2	31	2	32	2
65	11	65	9.25	19	1	30	2	32	1
65	11	65	11.50	19	1	29	2	32	1

TABLE IV.13

ESTIMATED MEAN COST OF WATER TREATMENT PER MGD FOR SELECTED CONDITIONS  
(RAPID SAND FILTER) IN 1000 U.S. DOLLARS

D <sub>w</sub>	X <sub>13</sub>	X <sub>14</sub>	X <sub>15</sub>	C'' <sub>w.af</sub>	C''' <sub>w.af</sub>	C'' <sub>w.as</sub>	C''' <sub>w.as</sub>	C'' <sub>w.la</sub>	C''' <sub>w.la</sub>
5	4	5	0.25	357	127	564	183	478	137
5	4	5	4.00	357	114	564	157	448	118
5	4	5	7.75	357	112	564	151	441	114
5	4	5	11.50	357	110	564	148	437	112
5	4	45	0.25	341	127	518	183	478	137
5	4	45	4.00	341	114	518	157	448	118
5	4	45	7.75	341	112	518	151	441	114
5	4	45	11.50	341	110	518	148	437	112
5	4	85	0.25	336	127	506	183	478	137
5	4	85	4.00	336	114	506	157	448	118
5	4	85	7.75	336	112	506	151	441	114
5	4	85	11.50	336	110	506	148	437	112
5	24	5	0.25	363	132	570	191	480	148
5	24	5	4.00	363	119	570	164	450	128
5	24	5	7.75	363	116	570	158	443	124
5	24	5	11.50	363	115	570	155	439	121
5	24	45	0.25	347	132	524	191	480	148
5	24	45	4.00	347	119	524	164	450	128
5	24	45	7.75	347	116	524	158	443	124
5	24	45	11.50	347	115	524	155	439	121
5	24	85	0.25	342	132	512	191	480	148
5	24	85	4.00	342	119	512	164	450	128
5	24	85	7.75	342	116	512	158	443	124
5	24	85	11.50	342	115	512	155	439	121
5	44	5	0.25	365	134	572	194	481	152
5	44	5	4.00	365	121	572	167	450	131
5	44	5	7.75	365	118	572	161	443	127
5	44	5	11.50	365	116	572	157	439	124
5	44	45	0.25	349	134	527	194	481	152
5	44	45	4.00	349	121	527	167	450	131
5	44	45	7.75	349	118	527	161	443	127
5	44	45	11.50	349	116	527	157	439	124
5	44	85	0.25	344	134	514	194	481	152
5	44	85	4.00	344	121	514	167	450	131
5	44	85	7.75	344	118	514	161	443	127
5	44	85	11.50	344	116	514	157	439	124
5	64	5	0.25	367	135	574	196	481	155
5	64	5	4.00	367	122	574	168	451	134
5	64	5	7.75	367	119	574	162	444	129
5	64	5	11.50	367	117	574	159	440	126
5	64	45	0.25	350	135	528	196	481	155
5	64	45	4.00	350	122	528	168	451	134
5	64	45	7.75	350	119	528	162	444	129
5	64	45	11.50	350	117	528	159	440	126
5	64	85	0.25	345	135	515	196	481	155
5	64	85	4.00	345	122	515	168	451	134
5	64	85	7.75	345	119	515	162	444	129
5	64	85	11.50	345	117	515	159	440	126
45	4	5	0.25	357	127	564	183	478	137
45	4	5	4.00	357	114	564	157	448	118
45	4	5	7.75	357	112	564	151	441	114
45	4	5	11.50	357	110	564	148	437	112
45	4	45	0.25	341	127	518	183	478	137
45	4	45	4.00	341	114	518	157	448	118
45	4	45	7.75	341	112	518	151	441	114
45	4	45	11.50	341	110	518	148	437	112
45	4	85	0.25	336	127	506	183	478	137
45	4	85	4.00	336	114	506	157	448	118
45	4	85	7.75	336	112	506	151	441	114
45	4	85	11.50	336	110	506	148	437	112
45	24	5	0.25	363	132	570	191	480	148
45	24	5	4.00	363	119	570	164	450	128
45	24	5	7.75	363	116	570	158	443	124

TABLE IV.13--Continued

D <sub>w</sub>	X <sub>13</sub>	X <sub>14</sub>	X <sub>15</sub>	C <sup>''</sup> <sub>w.af</sub>	C <sup>'''</sup> <sub>w.af</sub>	C <sup>''</sup> <sub>w.as</sub>	C <sup>'''</sup> <sub>w.as</sub>	C <sup>''</sup> <sub>w.la</sub>	C <sup>'''</sup> <sub>w.la</sub>
45	24	5	11.50	363	115	570	155	439	121
45	24	45	0.25	347	132	524	191	480	148
45	24	45	4.00	347	119	524	164	450	128
45	24	45	7.75	347	116	524	158	443	124
45	24	45	11.50	347	115	524	155	439	121
45	24	85	0.25	342	132	512	191	480	148
45	24	85	4.00	342	119	512	164	450	128
45	24	85	7.75	342	116	512	158	443	124
45	24	85	11.50	342	115	512	155	439	121
45	44	5	0.25	365	134	572	194	481	152
45	44	5	4.00	365	121	572	167	450	131
45	44	5	7.75	365	118	572	161	443	127
45	44	5	11.50	365	116	572	157	439	124
45	44	45	0.25	349	134	527	194	481	152
45	44	45	4.00	349	121	527	167	450	131
45	44	45	7.75	349	118	527	161	443	127
45	44	45	11.50	349	116	527	157	439	124
45	44	85	0.25	344	134	514	194	481	152
45	44	85	4.00	344	121	514	167	450	131
45	44	85	7.75	344	118	514	161	443	127
45	44	85	11.50	344	116	514	157	439	124
45	64	5	0.25	367	135	574	196	481	155
45	64	5	4.00	367	122	574	168	451	134
45	64	5	7.75	367	119	574	162	444	129
45	64	5	11.50	367	117	574	159	440	126
45	64	45	0.25	350	135	528	196	481	155
45	64	45	4.00	350	122	528	168	451	134
45	64	45	7.75	350	119	528	162	444	129
45	64	45	11.50	350	117	528	159	440	126
45	64	85	0.25	345	135	515	196	481	155
45	64	85	4.00	345	122	515	168	451	134
45	64	85	7.75	345	119	515	162	444	129
45	64	85	11.50	345	117	515	159	440	126
85	4	5	0.25	357	127	564	183	478	137
85	4	5	4.00	357	114	564	157	448	118
85	4	5	7.75	357	112	564	151	441	114
85	4	5	11.50	357	110	564	148	437	112
85	4	45	0.25	341	127	518	183	478	137
85	4	45	4.00	341	114	518	157	448	118
85	4	45	7.75	341	112	518	151	441	114
85	4	45	11.50	341	110	518	148	437	112
85	4	85	0.25	336	127	506	183	478	137
85	4	85	4.00	336	114	506	157	448	118
85	4	85	7.75	336	112	506	151	441	114
85	4	85	11.50	336	110	506	148	437	112
85	24	5	0.25	363	132	570	191	480	148
85	24	5	4.00	363	119	570	164	450	128
85	24	5	7.75	363	116	570	158	443	124
85	24	5	11.50	363	115	570	155	439	121
85	24	45	0.25	347	132	524	191	480	148
85	24	45	4.00	347	119	524	164	450	128
85	24	45	7.75	347	116	524	158	443	124
85	24	45	11.50	347	115	524	155	439	121
85	24	85	0.25	342	132	512	191	480	148
85	24	85	4.00	342	119	512	164	450	128
85	24	85	7.75	342	116	512	158	443	124
85	24	85	11.50	342	115	512	155	439	121
85	44	5	0.25	365	134	572	194	481	152
85	44	5	4.00	365	121	572	167	450	131
85	44	5	7.75	365	118	572	161	443	127
85	44	5	11.50	365	116	572	157	439	124
85	44	45	0.25	349	134	527	194	481	152
85	44	45	4.00	349	121	527	167	450	131
85	44	45	7.75	349	118	527	161	443	127
85	44	45	11.50	349	116	527	157	439	124
85	44	85	0.25	344	134	514	194	481	152
85	44	85	4.00	344	121	514	167	450	131
85	44	85	7.75	344	118	514	161	443	127
85	44	85	11.50	344	116	514	157	439	124
85	44	85	0.25	344	134	514	194	481	152
85	44	85	4.00	344	121	514	167	450	131

TABLE IV.13--Continued

D <sub>w</sub>	X <sub>13</sub>	X <sub>14</sub>	X <sub>15</sub>	C'' w.af	C''' w.af	C'' w.as	C''' w.as	C'' w.la	C''' w.la
85	44	85	7.75	344	118	514	161	443	127
85	44	85	11.50	344	116	514	157	439	124
85	64	5	0.25	367	135	574	196	481	155
85	64	5	4.00	367	122	574	168	451	134
85	64	5	7.75	367	119	574	162	444	129
85	64	5	11.50	367	117	574	159	440	126
85	64	45	0.25	350	135	528	196	481	155
85	64	45	4.00	350	122	528	168	451	134
85	64	45	7.75	350	119	528	162	444	129
85	64	45	11.50	350	117	528	159	440	126
85	64	85	0.25	345	135	515	196	481	155
85	64	85	4.00	345	122	515	168	451	134
85	64	85	7.75	345	119	515	162	444	129
85	64	85	11.50	345	117	515	159	440	126
125	4	5	0.25	357	127	564	183	478	137
125	4	5	4.00	357	114	564	157	448	118
125	4	5	7.75	357	112	564	151	441	114
125	4	5	11.50	357	110	564	148	437	112
125	4	45	0.25	341	127	518	183	478	137
125	4	45	4.00	341	114	518	157	448	118
125	4	45	7.75	341	112	518	151	441	114
125	4	45	11.50	341	110	518	148	437	112
125	4	85	0.25	336	127	506	183	478	137
125	4	85	4.00	336	114	506	157	448	118
125	4	85	7.75	336	112	506	151	441	114
125	4	85	11.50	336	110	506	148	437	112
125	24	5	0.25	363	132	570	191	480	148
125	24	5	4.00	363	119	570	164	450	128
125	24	5	7.75	363	116	570	158	443	124
25	24	5	11.50	363	115	570	155	439	121
125	24	45	0.25	347	132	524	191	480	148
125	24	45	4.00	347	119	524	164	450	128
125	24	45	7.75	347	116	524	158	443	124
125	24	45	11.50	347	115	524	155	439	121
125	24	85	0.25	342	132	512	191	480	148
125	24	85	4.00	342	119	512	164	450	128
125	24	85	7.75	342	116	512	158	443	124
125	24	85	11.50	342	115	512	155	439	121
125	44	5	0.25	365	134	572	194	481	152
125	44	5	4.00	365	121	572	167	450	131
125	44	5	7.75	365	118	572	161	443	127
125	44	5	11.50	365	116	572	157	439	124
125	44	45	0.25	349	134	527	194	481	152
125	44	45	4.00	349	121	527	167	450	131
125	44	45	7.75	349	118	527	161	443	127
125	44	45	11.50	349	116	527	157	439	124
125	44	85	0.25	344	134	514	194	481	152
125	44	85	4.00	344	121	514	167	450	131
125	44	85	7.75	344	118	514	161	443	127
125	44	85	11.50	344	116	514	157	439	124
125	64	5	0.25	367	135	574	196	481	155
125	64	5	4.00	367	122	574	168	451	134
125	64	5	7.75	367	119	574	162	444	129
125	64	5	11.50	367	117	574	159	440	126
125	64	45	0.25	350	135	528	196	481	155
125	64	45	4.00	350	122	528	168	451	134
125	64	45	7.75	350	119	528	162	444	129
125	64	45	11.50	350	117	528	159	440	126
125	64	85	0.25	345	135	515	196	481	155
125	64	85	4.00	345	122	515	168	451	134
125	64	85	7.75	345	119	515	162	444	129
125	64	85	11.50	345	117	515	159	440	126
165	4	5	0.25	357	127	564	183	478	137
165	4	5	4.00	357	114	564	157	448	118
165	4	5	7.75	357	112	564	151	441	114



TABLE IV.13--Continued

$D_w$	$X_{13}$	$X_{14}$	$X_{15}$	$C''_{w.af}$	$C'''_{w.af}$	$C''_{w.as}$	$C'''_{w.as}$	$C''_{w.la}$	$C'''_{w.la}$
165	4	5	11.50	357	110	564	148	437	112
165	4	45	0.25	341	127	518	183	478	137
165	4	45	4.00	341	114	518	157	448	118
165	4	45	7.75	341	112	518	151	441	114
165	4	45	11.50	341	110	518	148	437	112
165	4	85	0.25	336	127	506	183	478	137
165	4	85	4.00	336	114	506	157	448	118
165	4	85	7.75	336	112	506	151	441	114
165	4	85	11.50	336	110	506	148	437	112
165	24	5	0.25	363	132	570	191	480	148
165	24	5	4.00	363	119	570	164	450	128
165	24	5	7.75	363	116	570	158	443	124
165	24	5	11.50	363	115	570	155	439	121
165	24	45	0.25	347	132	524	191	480	148
165	24	45	4.00	347	119	524	164	450	128
165	24	45	7.75	347	116	524	158	443	124
165	24	45	11.50	347	115	524	155	439	121
165	24	85	0.25	342	132	512	191	480	148
165	24	85	4.00	342	119	512	164	450	128
165	24	85	7.75	342	116	512	158	443	124
165	24	85	11.50	342	115	512	155	439	121
165	44	5	0.25	365	134	572	194	481	152
165	44	5	4.00	365	121	572	167	450	131
165	44	5	7.75	365	118	572	161	443	127
165	44	5	11.50	365	116	572	157	439	124
165	44	45	0.25	349	134	527	194	481	152
165	44	45	4.00	349	121	527	167	450	131
165	44	45	7.75	349	118	527	161	443	127
165	44	45	11.50	349	116	527	157	439	124
165	44	85	0.25	344	134	514	194	481	152
165	44	85	4.00	344	121	514	167	450	131
165	44	85	7.75	344	118	514	161	443	127
165	44	85	11.50	344	116	514	157	439	124
165	64	5	0.25	367	135	574	196	481	155
165	64	5	4.00	367	122	574	168	451	134
165	64	5	7.75	367	119	574	162	444	129
165	64	5	11.50	367	117	574	159	440	126
165	64	45	0.25	350	135	528	196	481	155
165	64	45	4.00	350	122	528	168	451	134
165	64	45	7.75	350	119	528	162	444	129
165	64	45	11.50	350	117	528	159	440	126
165	64	85	0.25	345	135	515	196	481	155
165	64	85	4.00	345	122	515	168	451	134
165	64	85	7.75	345	119	515	162	444	129
165	64	85	11.50	345	117	515	159	440	126

TABLE IV.14

ESTIMATED MEAN COST OF WASTEWATER TREATMENT PER MGD FOR  
SELECTED CONDITIONS (STABILIZATION LAGOON) IN 1000 U.S. DOLLARS

$X_{16}$	$X_{20}$	$C''_{ww.af}$	$C''''_{ww.af}$	$C''_{ww.as}$	$C''''_{ww.as}$	$C''_{ww.la}$	$C''''_{ww.la}$
5	0.25	55	6	96	9	105	9
5	3.50	55	5	96	9	103	9
5	6.75	55	5	96	9	103	9
5	10.00	55	5	96	9	103	9
20	0.25	52	4	67	9	103	7
20	3.50	52	3	67	9	102	7
20	6.75	52	3	67	9	102	7
20	10.00	52	3	67	9	102	7
35	0.25	50	3	58	9	103	6
35	3.50	50	3	58	9	102	6
35	6.75	50	3	58	9	102	6
35	10.00	50	3	58	9	101	6
50	0.25	50	3	53	9	103	6
50	3.50	50	3	53	9	102	6
50	6.75	50	3	53	9	101	6
50	10.00	50	3	53	9	101	6
65	0.25	49	3	50	9	103	5
65	3.50	49	3	50	9	101	5
65	6.75	49	2	50	9	101	5
65	10.00	49	2	50	9	101	5
80	0.25	49	3	47	9	102	5
80	3.50	49	2	47	9	101	5
80	6.75	49	2	47	9	101	5
80	10.00	49	2	47	9	101	5
95	0.25	48	3	45	9	102	5
95	3.50	48	2	45	9	101	5
95	6.75	48	2	45	9	101	5
95	10.00	48	2	45	9	101	5
110	0.25	48	2	43	9	102	5
110	3.50	48	2	43	9	101	5
110	6.75	48	2	43	9	101	5
110	10.00	48	2	43	9	100	5
125	0.25	48	2	42	9	102	5
125	3.50	48	2	42	9	101	5
125	6.75	48	2	42	9	101	5
125	10.00	48	2	42	9	100	5
140	0.25	47	2	41	9	102	5
140	3.50	47	2	41	9	101	4
140	6.75	47	2	41	9	100	4
140	10.00	47	2	41	9	100	4
155	0.25	47	2	40	9	102	4
155	3.50	47	2	40	9	101	4
155	6.75	47	2	40	9	100	4
155	10.00	47	2	40	9	100	4
170	0.25	47	2	39	9	102	4
170	3.50	47	2	39	9	101	4
170	6.75	47	2	39	9	100	4
170	10.00	47	2	39	9	100	4
185	0.25	47	2	38	9	102	4
185	3.50	47	2	38	9	101	4
185	6.75	47	2	38	9	100	4
185	10.00	47	2	38	9	100	4

TABLE IV.14--Continued

$X_{16}$	$X_{20}$	$C''_{ww.af}$	$C''''_{ww.af}$	$C''_{ww.as}$	$C''''_{ww.as}$	$C''_{ww.la}$	$C''''_{ww.la}$
200	0.25	47	2	37	9	102	4
200	3.50	47	2	37	9	100	4
200	6.75	47	2	37	9	100	4
200	10.00	47	2	37	9	100	4
215	0.25	47	2	36	9	102	4
215	3.50	47	2	36	9	100	4
215	6.75	47	2	36	9	100	4
215	10.00	47	2	36	9	100	4
230	0.25	46	2	36	9	102	4
230	3.50	46	2	36	9	100	4
230	6.75	46	2	36	9	100	4
230	10.00	46	2	36	9	100	4
245	0.25	46	2	35	9	101	4
245	3.50	46	2	35	9	100	4
245	6.75	46	2	35	9	100	4
245	10.00	46	2	35	9	100	4

TABLE IV.15

ESTIMATED MEAN COST OF WASTEWATER TREATMENT PER MGD FOR  
SELECTED CONDITIONS (AERATED LAGOON) IN 1000 U.S. DOLLARS

$X_{16}$	$X_{20}$	$X_{21}$	$C''_{ww.af}$	$C''''_{ww.af}$	$C''_{ww.as}$	$C''''_{ww.as}$	$C''_{ww.la}$	$C''''_{ww.la}$
5	0.25	3	155	65	195	70	284	93
5	0.25	5	155	65	195	71	284	93
5	0.25	7	155	65	195	71	284	93
5	0.25	9	155	65	195	71	284	93
5	0.25	11	155	65	195	71	284	93
5	3.50	3	112	31	112	40	184	35
5	3.50	5	112	31	112	40	184	35
5	3.50	7	112	31	112	40	184	35
5	3.50	9	112	31	112	40	184	35
5	3.50	11	112	31	112	40	184	35
5	6.75	3	104	25	98	34	165	28
5	6.75	5	104	25	98	35	165	28
5	6.75	7	104	25	98	35	165	28
5	6.75	9	104	25	98	35	165	28
5	6.75	11	104	25	98	35	165	28
5	10.00	3	99	23	90	32	155	24
5	10.00	5	99	23	90	32	155	24
5	10.00	7	99	23	90	32	155	24
5	10.00	9	99	23	90	32	155	24
5	10.00	11	99	23	90	32	155	24
20	0.25	3	154	65	183	70	284	93
20	0.25	5	154	65	183	71	284	93
20	0.25	7	154	65	183	71	284	93
20	0.25	9	154	65	183	71	284	93
20	0.25	11	154	65	183	71	284	93
20	3.50	3	112	31	105	40	184	35
20	3.50	5	112	31	105	40	184	35
20	3.50	7	112	31	105	40	184	35
20	3.50	9	112	31	105	40	184	35
20	3.50	11	112	31	105	40	184	35
20	6.75	3	103	25	91	34	165	28
20	6.75	5	103	25	91	35	165	28
20	6.75	7	103	25	91	35	165	28
20	6.75	9	103	25	91	35	165	28
20	6.75	11	103	25	91	35	165	28
20	10.00	3	98	23	84	32	155	24
20	10.00	5	98	23	84	32	155	24
20	10.00	7	98	23	84	32	155	24
20	10.00	9	98	23	84	32	155	24
20	10.00	11	98	23	84	32	155	24
35	0.25	3	154	65	178	70	284	93
35	0.25	5	154	65	178	71	284	93
35	0.25	7	154	65	178	71	284	93
35	0.25	9	154	65	178	71	284	93
35	0.25	11	154	65	178	71	284	93
35	3.50	3	112	31	102	40	184	35
35	3.50	5	112	31	102	40	184	35
35	3.50	7	112	31	102	40	184	35
35	3.50	9	112	31	102	40	184	35
35	3.50	11	112	31	102	40	184	35
35	6.75	3	103	25	89	34	165	28
35	6.75	5	103	25	89	35	165	28
35	6.75	7	103	25	89	35	165	28
35	6.75	9	103	25	89	35	165	28
35	6.75	11	103	25	89	35	165	28
35	10.00	3	98	23	82	32	155	24
35	10.00	5	98	23	82	32	155	24
35	10.00	7	98	23	82	32	155	24

TABLE IV.15--Continued

$X_{16}$	$X_{20}$	$X_{21}$	$C''_{ww.af}$	$C'''_{ww.af}$	$C''_{ww.as}$	$C'''_{ww.as}$	$C''_{ww.la}$	$C'''_{ww.la}$
35	10.00	9	98	23	82	32	155	24
35	10.00	11	98	23	82	32	155	24
50	0.25	3	154	65	175	70	284	93
50	0.25	5	154	65	175	71	284	93
50	0.25	7	154	65	175	71	284	93
50	0.25	9	154	65	175	71	284	93
50	0.25	11	154	65	175	71	284	93
50	3.50	3	112	31	100	40	184	35
50	3.50	5	112	31	100	40	184	35
50	3.50	7	112	31	100	40	184	35
50	3.50	9	112	31	100	40	184	35
50	3.50	11	112	31	100	40	184	35
50	6.75	3	103	25	88	34	165	28
50	6.75	5	103	25	88	35	165	28
50	6.75	7	103	25	88	35	165	28
50	6.75	9	103	25	88	35	165	28
50	6.75	11	103	25	88	35	165	28
50	10.00	3	98	23	81	32	155	24
50	10.00	5	98	23	81	32	155	24
50	10.00	7	98	23	81	32	155	24
50	10.00	9	98	23	81	32	155	24
50	10.00	11	98	23	81	32	155	24
65	0.25	3	154	65	173	70	284	93
65	0.25	5	154	65	173	71	284	93
65	0.25	7	154	65	173	71	284	93
65	0.25	9	154	65	173	71	284	93
65	0.25	11	154	65	173	71	284	93
65	3.50	3	111	31	99	40	184	35
65	3.50	5	111	31	99	40	184	35
65	3.50	7	111	31	99	40	184	35
65	3.50	9	111	31	99	40	184	35
65	3.50	11	111	31	99	40	184	35
65	6.75	3	103	25	86	34	165	28
65	6.75	5	103	25	86	35	165	28
65	6.75	7	103	25	86	35	165	28
65	6.75	9	103	25	86	35	165	28
65	6.75	11	103	25	86	35	165	28
65	10.00	3	98	23	80	32	155	24
65	10.00	5	98	23	80	32	155	24
65	10.00	7	98	23	80	32	155	24
65	10.00	9	98	23	80	32	155	24
65	10.00	11	98	23	80	32	155	24
80	0.25	3	154	65	171	70	284	93
80	0.25	5	154	65	171	71	284	93
80	0.25	7	154	65	171	71	284	93
80	0.25	9	154	65	171	71	284	93
80	0.25	11	154	65	171	71	284	93
80	3.50	3	111	31	98	40	184	35
80	3.50	5	111	31	98	40	184	35
80	3.50	7	111	31	98	40	184	35
80	3.50	9	111	31	98	40	184	35
80	3.50	11	111	31	98	40	184	35
80	6.75	3	103	25	86	34	165	28
80	6.75	5	103	25	86	35	165	28
80	6.75	7	103	25	86	35	165	28
80	6.75	9	103	25	86	35	165	28
80	6.75	11	103	25	86	35	165	28
80	10.00	3	98	23	79	32	155	24
80	10.00	5	98	23	79	32	155	24
80	10.00	7	98	23	79	32	155	24
80	10.00	9	98	23	79	32	155	24
80	10.00	11	98	23	79	32	155	24
95	0.25	3	153	65	170	70	284	93
95	0.25	5	153	65	170	71	284	93
95	0.25	7	153	65	170	71	284	93

TABLE IV.15--Continued

X <sub>16</sub>	X <sub>20</sub>	X <sub>21</sub>	C <sup>n</sup> <sub>ww.af</sub>	C <sup>'''</sup> <sub>ww.af</sub>	C <sup>n</sup> <sub>ww.as</sub>	C <sup>'''</sup> <sub>ww.as</sub>	C <sup>n</sup> <sub>ww.la</sub>	C <sup>'''</sup> <sub>ww.la</sub>
95	0.25	9	153	65	170	71	284	93
95	0.25	11	153	65	170	71	284	93
95	3.50	3	111	31	97	40	184	35
95	3.50	5	111	31	97	40	184	35
95	3.50	7	111	31	97	40	184	35
95	3.50	9	111	31	97	40	184	35
95	3.50	11	111	31	97	40	184	35
95	6.75	3	103	25	85	34	165	28
95	6.75	5	103	25	85	35	165	28
95	6.75	7	103	25	85	35	165	28
95	6.75	9	103	25	85	35	165	28
95	6.75	11	103	25	85	35	165	28
95	10.00	3	98	23	78	32	155	24
95	10.00	5	98	23	78	32	155	24
95	10.00	7	98	23	78	32	155	24
95	10.00	9	98	23	78	32	155	24
95	10.00	11	98	23	78	32	155	24
110	0.25	3	153	65	169	70	284	93
110	0.25	5	153	65	169	71	284	93
110	0.25	7	153	65	169	71	284	93
110	0.25	9	153	65	169	71	284	93
110	0.25	11	153	65	169	71	284	93
110	3.50	3	111	31	97	40	184	35
110	3.50	5	111	31	97	40	184	35
110	3.50	7	111	31	97	40	184	35
110	3.50	9	111	31	97	40	184	35
110	3.50	11	111	31	97	40	184	35
110	6.75	3	103	25	84	34	165	28
110	6.75	5	103	25	84	35	165	28
110	6.75	7	103	25	84	35	165	28
110	6.75	9	103	25	84	35	165	28
110	6.75	11	103	25	84	35	165	28
110	10.00	3	98	23	78	32	155	24
110	10.00	5	98	23	78	32	155	24
110	10.00	7	98	23	78	32	155	24
110	10.00	9	98	23	78	32	155	24
110	10.00	11	98	23	78	32	155	24

TABLE IV.16

ESTIMATED MEAN COST OF WASTEWATER TREATMENT PER MGD FOR  
SELECTED CONDITIONS (ACTIVATED SLUDGE) IN 1000 U.S. DOLLARS

$X_{16}$	$X_{20}$	$X_{21}$	$C''_{ww.af}$	$C''''_{ww.af}$	$C''_{ww.as}$	$C''''_{ww.as}$	$C''_{ww.la}$	$C''''_{ww.la}$
5	0.25	3	1110	268	277	88	2358	463
5	0.25	5	1111	268	317	88	2358	463
5	0.25	7	1111	268	347	89	2358	463
5	0.25	9	1112	268	370	89	2358	463
5	0.25	11	1113	268	391	89	2358	463
5	3.50	3	500	110	277	88	918	165
5	3.50	5	501	110	317	88	918	165
5	3.50	7	501	110	347	89	918	165
5	3.50	9	501	110	370	89	918	165
5	3.50	11	501	110	391	89	918	165
5	6.75	3	410	89	277	88	726	128
5	6.75	5	411	89	317	88	726	128
5	6.75	7	411	89	347	89	726	128
5	6.75	9	411	89	370	89	726	128
5	6.75	11	411	89	391	89	726	128
5	10.00	3	364	78	277	88	631	110
5	10.00	5	365	78	317	88	631	110
5	10.00	7	365	78	347	89	631	110
5	10.00	9	365	78	370	89	631	110
5	10.00	11	365	78	391	89	631	110
20	0.25	3	1110	268	192	60	2346	458
20	0.25	5	1111	268	220	60	2346	458
20	0.25	7	1111	268	240	60	2346	458
20	0.25	9	1112	268	257	60	2346	458
20	0.25	11	1113	268	271	60	2346	458
20	3.50	3	500	110	192	60	913	163
20	3.50	5	501	110	220	60	913	163
20	3.50	7	501	110	240	60	913	163
20	3.50	9	501	110	257	60	913	163
20	3.50	11	501	110	271	60	913	163
20	6.75	3	410	89	192	60	722	127
20	6.75	5	411	89	220	60	722	127
20	6.75	7	411	89	240	60	722	127
20	6.75	9	411	89	257	60	722	127
20	6.75	11	411	89	271	60	722	127
20	10.00	3	364	78	192	60	627	109
20	10.00	5	365	78	220	60	627	109
20	10.00	7	365	78	240	60	627	109
20	10.00	9	365	78	257	60	627	109
20	10.00	11	365	78	271	60	627	109
35	0.25	3	1110	268	166	52	2342	456
35	0.25	5	1111	268	190	52	2342	456
35	0.25	7	1111	268	207	52	2342	456
35	0.25	9	1112	268	221	52	2342	456
35	0.25	11	1113	268	233	52	2342	456
35	3.50	3	500	110	166	52	912	163
35	3.50	5	501	110	190	52	912	163
35	3.50	7	501	110	207	52	912	163
35	3.50	9	501	110	221	52	912	163
35	3.50	11	501	110	233	52	912	163
35	6.75	3	410	89	166	52	721	126
35	6.75	5	411	89	190	52	721	126
35	6.75	7	411	89	207	52	721	126
35	6.75	9	411	89	221	52	721	126
35	6.75	11	411	89	233	52	721	126
35	10.00	3	364	78	166	52	626	108
35	10.00	5	365	78	190	52	626	108
35	10.00	7	365	78	207	52	626	108
35	10.00	9	365	78	221	52	626	108
35	10.00	11	365	78	233	52	626	108
50	0.25	3	1110	268	151	47	2339	455

TABLE IV.16--Continued

$X_{16}$	$X_{20}$	$X_{21}$	$C''_{ww.af}$	$C''''_{ww.af}$	$C''_{ww.as}$	$C''''_{ww.as}$	$C''_{ww.la}$	$C''''_{ww.la}$
50	0.25	5	1111	268	172	47	2339	455
50	0.25	7	1111	268	189	47	2339	455
50	0.25	9	1112	268	201	47	2339	455
50	0.25	11	1113	268	212	47	2339	455
50	3.50	3	500	110	151	47	910	162
50	3.50	5	501	110	172	47	910	162
50	3.50	7	501	110	189	47	910	162
50	3.50	9	501	110	201	47	910	162
50	3.50	11	501	110	212	47	910	162
50	6.75	3	410	89	151	47	720	126
50	6.75	5	411	89	172	47	720	126
50	6.75	7	411	89	189	47	720	126
50	6.75	9	411	89	201	47	720	126
50	6.75	11	411	89	212	47	720	126
50	10.00	3	364	78	151	47	625	108
50	10.00	5	365	78	172	47	625	108
50	10.00	7	365	78	189	47	625	108
50	10.00	9	365	78	201	47	625	108
50	10.00	11	365	78	212	47	625	108
65	0.25	3	1110	268	141	44	2336	454
65	0.25	5	1111	268	161	44	2336	454
65	0.25	7	1111	268	176	44	2336	454
65	0.25	9	1112	268	188	44	2336	454
65	0.25	11	1113	268	198	44	2336	454
65	3.50	3	500	110	141	44	910	162
65	3.50	5	501	110	161	44	910	162
65	3.50	7	501	110	176	44	910	162
65	3.50	9	501	110	188	44	910	162
65	3.50	11	501	110	198	44	910	162
65	6.75	3	410	89	141	44	719	125
65	6.75	5	411	89	161	44	719	125
65	6.75	7	411	89	176	44	719	125
65	6.75	9	411	89	188	44	719	125
65	6.75	11	411	89	198	44	719	125
65	10.00	3	364	78	141	44	625	108
65	10.00	5	365	78	161	44	625	108
65	10.00	7	365	78	176	44	625	108
65	10.00	9	365	78	188	44	625	108
65	10.00	11	365	78	198	44	625	108
80	0.25	3	1110	268	133	41	2335	453
80	0.25	5	1111	268	152	41	2335	453
80	0.25	7	1111	268	166	41	2335	453
80	0.25	9	1112	268	178	41	2335	453
80	0.25	11	1113	268	188	41	2335	453
80	3.50	3	500	110	133	41	909	162
80	3.50	5	501	110	152	41	909	162
80	3.50	7	501	110	166	41	909	162
80	3.50	9	501	110	178	41	909	162
80	3.50	11	501	110	188	41	909	162
80	6.75	3	410	89	133	41	719	125
80	6.75	5	411	89	152	41	719	125
80	6.75	7	411	89	166	41	719	125
80	6.75	9	411	89	178	41	719	125
80	6.75	11	411	89	188	41	719	125
80	10.00	3	364	78	133	41	624	107
80	10.00	5	365	78	152	41	624	107
80	10.00	7	365	78	166	41	624	107
80	10.00	9	365	78	178	41	624	107
80	10.00	11	365	78	188	41	624	107
95	0.25	3	1110	268	127	39	2333	453
95	0.25	5	1111	268	146	39	2333	453
95	0.25	7	1111	268	159	39	2333	453
95	0.25	9	1112	268	170	39	2333	453
95	0.25	11	1113	268	179	39	2333	453
95	3.50	3	500	110	127	39	908	162
95	3.50	5	501	110	146	39	908	162



TABLE IV.16--Continued

$X_{16}$	$X_{20}$	$X_{21}$	$C''_{ww.af}$	$C''''_{ww.af}$	$C''_{ww.as}$	$C''''_{ww.as}$	$C''_{ww.la}$	$C''''_{ww.la}$
95	3.50	7	501	110	159	39	908	162
95	3.50	9	501	110	170	39	908	162
95	3.50	11	501	110	179	39	908	162
95	6.75	3	410	89	127	39	718	125
95	6.75	5	411	89	146	39	718	125
95	6.75	7	411	89	159	39	718	125
95	6.75	9	411	89	170	39	718	125
95	6.75	11	411	89	179	39	718	125
95	10.00	3	364	78	127	39	624	107
95	10.00	5	365	78	146	39	624	107
95	10.00	7	365	78	159	39	624	107
95	10.00	9	365	78	170	39	624	107
95	10.00	11	365	78	179	39	624	107
110	0.25	3	1110	268	122	38	2332	452
110	0.25	5	1111	268	140	38	2332	452
110	0.25	7	1111	268	153	38	2332	452
110	0.25	9	1112	268	164	38	2332	452
110	0.25	11	1113	268	172	38	2332	452
110	3.50	3	500	110	122	38	908	161
110	3.50	5	501	110	140	38	908	161
110	3.50	7	501	110	153	38	908	161
110	3.50	9	501	110	164	38	908	161
110	3.50	11	501	110	172	38	908	161
110	6.75	3	410	89	122	38	718	125
110	6.75	5	411	89	140	38	718	125
110	6.75	7	411	89	153	38	718	125
110	6.75	9	411	89	164	38	718	125
110	6.75	11	411	89	172	38	718	125
110	10.00	3	364	78	122	38	624	107
110	10.00	5	365	78	140	38	624	107
110	10.00	7	365	78	153	38	624	107
110	10.00	9	365	78	164	38	624	107
110	10.00	11	365	78	172	38	624	107

TABLE IV.17

ESTIMATED MEAN COST OF WASTEWATER TREATMENT PER MGD FOR  
SELECTED CONDITIONS (TRICKLING FILTER) IN 1000 U.S. DOLLARS

$X_{16}$	$X_{20}$	$X_{21}$	$C''_{ww.af}$	$C'''_{ww.af}$	$C''_{ww.as}$	$C'''_{ww.as}$	$C''_{ww.la}$	$C'''_{ww.la}$
5	0.25	3	2990	268	2532	128	1706	593
5	0.25	5	2990	269	2532	130	1706	593
5	0.25	7	2990	269	2532	131	1706	593
5	0.25	9	2990	269	2532	131	1706	593
5	0.25	11	2990	269	2532	132	1706	593
5	3.50	3	700	111	561	128	715	272
5	3.50	5	700	111	561	130	715	272
5	3.50	7	700	111	561	131	715	272
5	3.50	9	700	111	561	131	715	272
5	3.50	11	700	111	561	132	715	272
5	6.75	3	487	89	386	128	576	224
5	6.75	5	487	89	386	130	576	224
5	6.75	7	487	89	386	131	576	224
5	6.75	9	487	89	386	131	576	224
5	6.75	11	487	89	386	132	576	224
5	10.00	3	393	78	308	128	506	199
5	10.00	5	393	78	308	130	506	199
5	10.00	7	393	78	308	131	506	199
5	10.00	9	393	78	308	131	506	199
5	10.00	11	393	78	308	132	506	199
20	0.25	3	2990	268	2532	89	1706	593
20	0.25	5	2990	269	2532	90	1706	593
20	0.25	7	2990	269	2532	90	1706	593
20	0.25	9	2990	269	2532	91	1706	593
20	0.25	11	2990	269	2532	91	1706	593
20	3.50	3	700	111	561	89	715	272
20	3.50	5	700	111	561	90	715	272
20	3.50	7	700	111	561	90	715	272
20	3.50	9	700	111	561	91	715	272
20	3.50	11	700	111	561	91	715	272
20	6.75	3	487	89	386	89	576	224
20	6.75	5	487	89	386	90	576	224
20	6.75	7	487	89	386	90	576	224
20	6.75	9	487	89	386	91	576	224
20	6.75	11	487	89	386	91	576	224
20	10.00	3	393	78	308	89	506	199
20	10.00	5	393	78	308	90	506	199
20	10.00	7	393	78	308	90	506	199
20	10.00	9	393	78	308	91	506	199
20	10.00	11	393	78	308	91	506	199
35	0.25	3	2990	268	2532	76	1706	593
35	0.25	5	2990	269	2532	77	1706	593
35	0.25	7	2990	269	2532	78	1706	593
35	0.25	9	2990	269	2532	78	1706	593
35	0.25	11	2990	269	2532	79	1706	593
35	3.50	3	700	111	561	76	715	272
35	3.50	5	700	111	561	77	715	272
35	3.50	7	700	111	561	78	715	272
35	3.50	9	700	111	561	78	715	272
35	3.50	11	700	111	561	79	715	272
35	6.75	3	487	89	386	76	576	224
35	6.75	5	487	89	386	77	576	224
35	6.75	7	487	89	386	78	576	224
35	6.75	9	487	89	386	78	576	224
35	6.75	11	487	89	386	79	576	224
35	10.00	3	393	78	308	76	506	199
35	10.00	5	393	78	308	77	506	199
35	10.00	7	393	78	308	78	506	199
35	10.00	9	393	78	308	78	506	199

TABLE IV.17--Continued

$X_{16}$	$X_{20}$	$X_{21}$	$C''_{ww.af}$	$C''''_{ww.af}$	$C''_{ww.as}$	$C''''_{ww.as}$	$C''_{ww.la}$	$C''''_{ww.la}$
35	10.00	11	393	78	308	79	506	199
50	0.25	3	2990	268	2532	70	1706	593
50	0.25	5	2990	269	2532	70	1706	593
50	0.25	7	2990	269	2532	71	1706	593
50	0.25	9	2990	269	2532	71	1706	593
50	0.25	11	2990	269	2532	72	1706	593
50	3.50	3	700	111	561	70	715	272
50	3.50	5	700	111	561	70	715	272
50	3.50	7	700	111	561	71	715	272
50	3.50	9	700	111	561	71	715	272
50	3.50	11	700	111	561	72	715	272
50	6.75	3	487	89	386	70	576	224
50	6.75	5	487	89	386	70	576	224
50	6.75	7	487	89	386	71	576	224
50	6.75	9	487	89	386	71	576	224
50	6.75	11	487	89	386	72	576	224
50	10.00	3	393	78	308	70	506	199
50	10.00	5	393	78	308	70	506	199
50	10.00	7	393	78	308	71	506	199
50	10.00	9	393	78	308	71	506	199
50	10.00	11	393	78	308	72	506	199
65	0.25	3	2990	268	2532	65	1706	593
65	0.25	5	2990	269	2532	66	1706	593
65	0.25	7	2990	269	2532	66	1706	593
65	0.25	9	2990	269	2532	66	1706	593
65	0.25	11	2990	269	2532	67	1706	593
65	3.50	3	700	111	561	65	715	272
65	3.50	5	700	111	561	66	715	272
65	3.50	7	700	111	561	66	715	272
65	3.50	9	700	111	561	66	715	272
65	3.50	11	700	111	561	67	715	272
65	6.75	3	487	89	386	65	576	224
65	6.75	5	487	89	386	66	576	224
65	6.75	7	487	89	386	66	576	224
65	6.75	9	487	89	386	66	576	224
65	6.75	11	487	89	386	67	576	224
65	10.00	3	393	78	308	65	506	199
65	10.00	5	393	78	308	66	506	199
65	10.00	7	393	78	308	66	506	199
65	10.00	9	393	78	308	66	506	199
65	10.00	11	393	78	308	67	506	199
80	0.25	3	2990	268	2532	61	1706	593
80	0.25	5	2990	269	2532	62	1706	593
80	0.25	7	2990	269	2532	63	1706	593
80	0.25	9	2990	269	2532	63	1706	593
80	0.25	11	2990	269	2532	63	1706	593
80	3.50	3	700	111	561	61	715	272
80	3.50	5	700	111	561	62	715	272
80	3.50	7	700	111	561	63	715	272
80	3.50	9	700	111	561	63	715	272
80	3.50	11	700	111	561	63	715	272
80	6.75	3	487	89	386	61	576	224
80	6.75	5	487	89	386	62	576	224
80	6.75	7	487	89	386	63	576	224
80	6.75	9	487	89	386	63	576	224
80	6.75	11	487	89	386	63	576	224
80	10.00	3	393	78	308	61	506	199
80	10.00	5	393	78	308	62	506	199
80	10.00	7	393	78	308	63	506	199
80	10.00	9	393	78	308	63	506	199
80	10.00	11	393	78	308	63	506	199
95	0.25	3	2990	268	2532	59	1706	593
95	0.25	5	2990	269	2532	59	1706	593
95	0.25	7	2990	269	2532	60	1706	593
95	0.25	9	2990	269	2532	60	1706	593

TABLE IV.17--Continued

$X_{16}$	$X_{20}$	$X_{21}$	$C''_{ww.af}$	$C''''_{ww.af}$	$C''_{ww.as}$	$C''''_{ww.as}$	$C''_{ww.la}$	$C''''_{ww.la}$
95	0.25	11	2990	269	2532	60	1706	593
95	3.50	3	700	111	561	59	715	272
95	3.50	5	700	111	561	59	715	272
95	3.50	7	700	111	561	60	715	272
95	3.50	9	700	111	561	60	715	272
95	3.50	11	700	111	561	60	715	272
95	6.75	3	487	89	386	59	576	224
95	6.75	5	487	89	386	59	576	224
95	6.75	7	487	89	386	60	576	224
95	6.75	9	487	89	386	60	576	224
95	6.75	11	487	89	386	60	576	224
95	10.00	3	393	78	308	59	506	199
95	10.00	5	393	78	308	59	506	199
95	10.00	7	393	78	308	60	506	199
95	10.00	9	393	78	308	60	506	199
95	10.00	11	393	78	308	60	506	199
110	0.25	3	2990	268	2532	56	1706	593
110	0.25	5	2990	269	2532	57	1706	593
110	0.25	7	2990	269	2532	57	1706	593
110	0.25	9	2990	269	2532	58	1706	593
110	0.25	11	2990	269	2532	58	1706	593
110	3.50	3	700	111	561	56	715	272
110	3.50	5	700	111	561	57	715	272
110	3.50	7	700	111	561	57	715	272
110	3.50	9	700	111	561	58	715	272
110	3.50	11	700	111	561	58	715	272
110	6.75	3	487	89	386	56	576	224
110	6.75	5	487	89	386	57	576	224
110	6.75	7	487	89	386	57	576	224
110	6.75	9	487	89	386	58	576	224
110	6.75	11	487	89	386	58	576	224
110	10.00	3	393	78	308	56	506	199
110	10.00	5	393	78	308	57	506	199
110	10.00	7	393	78	308	57	506	199
110	10.00	9	393	78	308	58	506	199
110	10.00	11	393	78	308	58	506	199

APPENDIX (CHAPTER V).

The four questionnaires presented in the following pages were used in obtaining data for the development and testing of the model for establishing priorities among water supply programs.

- (A) Village Water Supply Project Planning Data Sheet,
  - (B) Tabulation at Kecamatan Level of Village Water Supply and Sanitation Projects; Data Collection for Planning,
  - (C) Tabulation at Kabupaten Level of Village Water Supply and Sanitation Projects; Data Collection for Planning,
- (Part I) Rural Water Supply and Sanitation Data Sheet.

QUESTIONNAIRE A  
VILLAGE WATER SUPPLY PROJECT PLANNING  
DATA SHEET

Note.

- This form is to be completed by sanitarians at the Kecamatan Level or Health Center personnel.
- Check the appropriate blank.
- To be filled out through direct observation of the clusters within the village.

A. 1. Province \_\_\_\_\_  
Kabupaten \_\_\_\_\_  
Kecamatan \_\_\_\_\_

A. 2. Name of Village \_\_\_\_\_  
Number of houses \_\_\_\_\_  
Number of people \_\_\_\_\_

A. 3. How do the villagers get water?

Note.

- Unprotected water sources with piped systems; the use of bamboo is an unprotected piped system.
- Evaluation is based on general conditions.
- A map which indicates the number of water sources and their locations is usually available at the Health

Center. If there is no map, the locations of water sources should be estimated by general investigation of the village and consultation with the community leaders.

A. 3.1. With piped system.

1. Unprotected:

Sources	Systems	Pipes
<input type="checkbox"/> Springs	<input type="checkbox"/> Gravity	<input type="checkbox"/> G.I. <sup>1</sup>
<input type="checkbox"/> Rivers	<input type="checkbox"/> Pumping	<input type="checkbox"/> PVC <sup>2</sup>
<input type="checkbox"/> Others		<input type="checkbox"/> Asbestos
		<input type="checkbox"/> Bamboo

Population served by unprotected system \_\_\_\_\_

2. Protected:

Source	System	Pipe
<input type="checkbox"/> Springs	<input type="checkbox"/> Gravity	<input type="checkbox"/> G.I. <sup>1</sup>
<input type="checkbox"/> Artesian wells	<input type="checkbox"/> Pumping	<input type="checkbox"/> PVC <sup>2</sup>
<input type="checkbox"/> Rivers with treatment		<input type="checkbox"/> Asbestos
<input type="checkbox"/> Others		

Population served by protected system \_\_\_\_\_

A. 3.2. Without piped system.

1. Unprotected:

Sources	Number of sources	Population served
<input type="checkbox"/> Wells	_____	_____
<input type="checkbox"/> Springs	_____	_____

1

2

Galvanized Iron; Polyvinyl Chloride.

Sources	Number of sources	Population served
____ Rivers/Irrigation canals	____	____
____ Lakes	____	____
____ Rain water collections	____	____
Total population served		____

## 2. Protected:

Sources	Number of sources	Population served
____ Shallow hand-pumps	____	____
____ Deep handpumps	____	____
____ Spring protections	____	____
____ Free-flowing artesian wells	____	____
____ Rain water collections	____	____
Total population served		____

## A. 3.3. Summary of all systems

	Unprotected	Protected	Total
Population served by piped systems	____	____	____
Population served by other systems	____	____	____
Total population served by all systems			____

## A. 4. Are the existing sources becoming dry?

	Yes	No
Wells/Ground water	____	____



	Yes	No
Springs	___	___
Rivers/Surface water	___	___

A. 5. How are the physical and chemical characteristics of water currently used?

	Ground water	Springs	Surface water
Good: Clear	___	___	___
Poor: Salty	___	___	___
Contains iron	___	___	___
Hard	___	___	___
Turbid	___	___	___

A. 6. Distances between water source and communities.

\_\_\_ Less than 200 meters.  
 \_\_\_ Between 200 and 1,000 meters.  
 \_\_\_ More than 1,000 meters.

A. 7. Villagers must climb or descend to get to water source.

\_\_\_ No.  
 \_\_\_ Less than 150 meters.  
 \_\_\_ More than 150 meters.

A. 8. The depth of ground water to ground level.

\_\_\_ Less than 7 meters.  
 \_\_\_ Between 7 to 15 meters.  
 \_\_\_ More than 15 meters.

## A. 9. General topographical conditions.

 Mountainous. Rocky. Flat.

## A.10. Does the community need an improved water supply system?

 No. Yes, because: The water quality is poor. The water source is too far. Villagers must climb/descend to get to the water source. The capacity of the water source is not sufficient. The villagers are aware that the water source is polluted and have required an improved water system for their health.

## A.11. If the water supply is to be installed, the communities:

Yes No

Are willing to contribute to the construction cost.  Are willing to contribute to the operation and maintenance costs.  

## A.12. Suggested water supply system to improve the existing system.

## Note.

- In making suggestions the opinions of the community and its leader should be taken into account.

- A suggested system is determined in the field.

- The water supply system is divided into four groups. Group I is considered to be more economical, practical and simple, in other words, Group I is of a higher priority than Groups II, III and IV, and Group II is higher priority than Groups III and IV, and so on.
- Choose the best alternative for every cluster of the village according to their priority ranking.
- The suggested system should be discussed with the Health Center Officer and the Kabupaten Public Works.

A.12.1. The suggested water supply system for this village is:

	Number of projects	Population served
Group I. Gravitational Piped system.		
_____ Spring protection. The capacity of the spring must be at least 1 liter/second per 1,000 people, a good water quality, and an elevation higher than the community.	_____	_____
Group III. Piped system with pump.		
_____ Spring protection. The capacity of the spring must be at least 1 liter/second per 700 people, a good water quality, and an elevation lower than the community.	_____	_____
_____ Artesian wells. Where artesian wells exist.	_____	_____
_____ Surface water treatment. There is a river or an irrigation canal which never dries.	_____	_____

	Number of projects	Pop. served
Group II. Source protection without piped system.		
<p>_____ Spring protection. There is a spring close to the community.</p>	_____	_____
<p>_____ Free-flowing well. There is at least one free-flowing well in use in this area and it is possible to build some artesian wells. One well is designed for 400 to 500 people.</p>	_____	_____
<p>_____ Wells with shallow hand-pumps. The ground water table is not more than 7 meters below ground level, a good water quality, and one well for every 100 people.</p>	_____	_____
<p>_____ Wells with deep handpumps. The ground water table is more than 7 meters below ground level, but not more than 15 meters all year round, a good water quality, and one well for every 100 people.</p>	_____	_____
Group IV.		
<p>_____ Rain water collection. The only water source available in this area and presently the community is using it. One collection basin for every 100 people.</p>	_____	_____
	<b>Total</b>	_____*

\* Total designed population from Groups I, II, III and IV.

## A.12.2. Summary of Population.

- Population to be served with safe water. \_\_\_\_\_
  - Population can not be designed because a more detailed survey is required. \_\_\_\_\_
  - Population does not need water because it has a protected system. \_\_\_\_\_
- Total \_\_\_\_\_

## A.13. Do the villagers use household latrines?

- \_\_\_\_\_ Estimate the percentage of houses using individual latrines (with or without water seals). \_\_\_\_\_
- \_\_\_\_\_ Number of houses in the village. \_\_\_\_\_
- \_\_\_\_\_ Number of houses using latrines. \_\_\_\_\_
- \_\_\_\_\_ Number of people using latrines (based on average number of residents per family). \_\_\_\_\_
- \_\_\_\_\_ Number of people not using household latrines. \_\_\_\_\_

Name of Surveyor: \_\_\_\_\_

Date of survey : \_\_\_\_\_

## QUESTIONNAIRE B

VILLAGE WATER SUPPLY AND SANITATION PROJECTS  
 DATA COLLECTION FOR PLANNING  
 TABULATION AT KECAMATAN LEVEL

Note: Write the names of villages in the same order.

B. 1. Province \_\_\_\_\_

Kabupaten \_\_\_\_\_

Kecamatan \_\_\_\_\_

B. 2. Number of villages in Kecamatan \_\_\_\_\_

Number of families in Kecamatan \_\_\_\_\_

Number of people in Kecamatan \_\_\_\_\_

TABLE B. 2.

NUMBER OF FAMILIES AND PEOPLE IN EACH SURVEYED VILLAGE

Village	Number of Families	Number of People
Total		







TABLE B. 3.3.  
(From A. 3.3.)

FILL IN THE NUMBER IN THE APPROPRIATE BLANK

Summary of Population		Protected			Unprotected		
		Population using piped systems	Population using other systems	Total population using all of the systems	Population using piped systems	Population using other systems	Total population using all of the systems
Village							
Total							

TABLE B. 4.  
(From A. 4.)

CHECK THE APPROPRIATE BLANK

Villages	Water Sources which are running dry					
	Dry			Not Dry		
	Wells	Springs	Rivers/Irrigation canal	Wells	Springs	Rivers/Irrigation canal
<b>Total</b>						



## CHECK THE APPROPRIATE BLANK

TABLE B. 6. (From A. 6.)

B. 7. (From A. 7.)

Village	Distances			Climbing/Descending		
	Less than 200 meters	Between 200 and 100 meters	More than 1,000 meters	None	Less than 150 meters	More than 150 meters
<b>Total</b>						





FILL IN THE APPROPRIATE BLANK OF EACH VILLAGE ACCORDING TO ITS PROBLEMS, (a), (b), (c) AND (d)

TABLE B. 13. (From B. 4.) (From B. 5.) (From B. 6.; B.7.) (From B. 8.)

	(a) Classification Ground water running dry	(b) Classification Water quality is poor, salty, hard or turbid	(c) Classification Difficulty in getting water; the source is more than 1,000 m or climbing/descending more than 150m	(d) Classification One or more diseases present
Village				
Total				

TABLE B. 14  
(From B. 13. and A. 12. 1.)

SUGGESTIONS FOR IMPROVEMENT OF WATER SUPPLY SYSTEMS OF VILLAGE CLASSIFICATION

Village Classification	Suggestions for improvement of water supply systems											Total Population Served		Total Population Unserved					
	Wells with handpumps		Spring protections		Free-flowing wells		Rain water collections		Piped systems			Total Population Served		Total Population Unserved					
	Shallow pumps	Deep pumps	No	Pop	No	Pop	No	Pop	No	Pop	Artesian wells	Springs	River water treatment	No Pop	No Pop				
Village																			
Total																			

Note: No = Number of systems  
Pop = Population using the systems



TABLE B. 15.  
(From A. 12. 2.)

SUMMARY OF B. 2. THROUGH B. 14.

Village	Number of designed population	Number of uncovered population	Population using unpro- tected sys- tems	Population using pro- tected sys- tems	Total popu- lation in villages
<b>Total</b>					

TABLE B. 16  
(From A. 13)

FAMILIES AND PEOPLE USING HOUSEHOLD LATRINES

Village	Number of families using latrines	Number of people latrines
Total		

## QUESTIONNAIRE C

VILLAGE WATER SUPPLY AND SANITATION PROJECTS  
 DATA COLLECTION FOR PLANNING  
 TABULATION AT KABUPATEN LEVEL

(Note: Write down all names of Kecamatans in the same order).

C.1. Province : \_\_\_\_\_

Kabupaten : \_\_\_\_\_

C.2. At Kabupaten Level

Surveyed Kecamatans	Number of villages	Population
_____	_____	_____
_____	_____	_____
_____	_____	_____
_____	_____	_____
_____	_____	_____

C.3. Piped systems

	Protected	Unprotected
C.3.1. Population using piped systems	_____	_____
Villages using piped systems	_____	_____
Breakdown:		
Villages using sources:		
Springs	_____	_____
Artesian wells	_____	_____
Others	_____	_____

	Protected	Unprotected
<b>Villages using systems:</b>		
Gravity	_____	_____
Pumping	_____	_____
<b>Villages using pipes:</b>		
G.I.	_____	_____
PVC	_____	_____
Asbestos	_____	_____
Bamboo	_____	_____
 <b>C.3.2. Other systems</b>		
Population using unprotected sources		_____
Number of wells		_____
Number of springs		_____
Number of rivers		_____
Number of collection basins		_____
Population using protected sources	_____	
Number of wells with hand-pumps	_____	
Number of protected springs	_____	
Number of free-flowing wells	_____	
Number of rain water collection basins	_____	
 <b>C.3.3. All systems</b>		
Population using piped systems	_____	_____
Population using other systems	_____	_____

	Protected	Unprotected
Total populations using all systems	_____	_____
Percentage of population using all systems (from total populations surveyed)	_____	_____
C.4. Number of villages whose sources dry		
Wells		_____
Springs		_____
Rivers		_____
C.5. Number of villages with clear ground water		
		_____
Number of villages with poor ground water (salty, contains iron, hard or turbid)		
		_____
C.6. Number of villages having distances from the sources:		
Less than 200 meters		_____
Between 200 to 1,000 meters		_____
More than 1,000 meters		_____
C.7. Number of villages to get water have to climb/descend:		
No		_____
Up to 150 meters		_____
More than 150 meters		_____
C.8. Number of villages where waterborne diseases present:		
* Five diseases present		_____
* Four diseases present		_____

- \* Three disease present \_\_\_\_\_
- \* Two diseases present \_\_\_\_\_
- \* One disease present \_\_\_\_\_
- \* Cholera is present \_\_\_\_\_
- C. 9. Number of villages having ground water table:
- \* Less than 7 meters \_\_\_\_\_
- \* Between 7 to 15 meters \_\_\_\_\_
- \* More than 15 meters \_\_\_\_\_
- C.10. Number of villages with topographical conditions:
- \* Mountainous \_\_\_\_\_
- \* Rocky \_\_\_\_\_
- \* Flat \_\_\_\_\_
- C.11. Number of villages do not need improved water supply systems. \_\_\_\_\_
- Number of villages needing water due to difficulty in obtaining water, the existing source is not sufficient, does not meet the minimum standard, need improved water for basic health care. \_\_\_\_\_
- Based on 4 reasons \_\_\_\_\_
- Based on 3 reasons \_\_\_\_\_
- Based on 2 reasons \_\_\_\_\_
- Based on 1 reason \_\_\_\_\_
- C.12. Villages willing to contribute funds
- For construction and operation costs \_\_\_\_\_
- For construction only \_\_\_\_\_

For operation only \_\_\_\_\_

- C.13. Villages are classified as below:
- a. Having source but dry during the dry season.
  - b. Poor quality (salty, contains iron, hard or turbid).
  - c. Difficult to get water (villagers have to travel 1,000 meters or more or to climb/descend 150 meters or more).
  - d. There are waterborne diseases (Cholera, Gastroenteric, typhoid, trachoma and skin diseases).

TABLE C.13.1

VILLAGE CLASSIFICATION ASSOCIATED TO THE NEED  
OF SAFE WATER

Classification	Number of villages	Number of people
a b c d		
a b c		
a b d		
a c d		
b c d		
a b		
a c		
a d		
b c		
b d		
c d		
a		
b		
c		
d		

Number of villages belong to one class, included combination with other classes:

- a. \_\_\_\_\_
- b. \_\_\_\_\_
- c. \_\_\_\_\_
- d. \_\_\_\_\_







QUESTIONNAIRE - PART I  
RURAL WATER SUPPLY AND SANITATION  
DATA SHEET

- Note 1. To be completed by the SANITATION DIVISION of the Kabupaten/Kecamatan.
2. The survey data should be shown in this completed Questionnaire and a Drawing prepared to Guide 4.
3. All survey data (Questionnaire and Drawing) should be sent as follows:
- three (3) copies of the Questionnaires and one original drawing to the Provincial Health Office.
  - one (1) copy of the Questionnaire and one drawing (copy) kept at the Kabupaten Health Office.

1. AREA LOCATION

1. 1. Area in which the community has been surveyed, data collected and the drawing prepared.

Province \_\_\_\_\_

Kabupaten \_\_\_\_\_

Kecamatan \_\_\_\_\_

1. 2. Desas that have been surveyed.

Name of Desa	Total Population	Population Surveyed
_____	_____	_____
_____	_____	_____
_____	_____	_____

1. 3. Institutions and Public Places in the survey area.

\_\_\_ Hospital with \_\_\_\_\_ beds  
 \_\_\_ Health Center with \_\_\_\_\_ beds  
 \_\_\_ Polyclinic  
 \_\_\_ MCH Center  
 \_\_\_ Number of Markets \_\_\_\_\_  
 \_\_\_ Number of religious places \_\_\_\_\_  
 \_\_\_ Others - give details: \_\_\_\_\_  
 \_\_\_\_\_  
 \_\_\_\_\_

## 1. 4. Distances from Survey Area:

	Distances	Road Conditions
to Kecamatan Town	_____	_____
to Kabupaten Town	_____	_____

## 2. EXISTING CONDITIONS

## 2. 1. Diseases in the survey area associated with use of un-safe water.

Disease	Year _____	Fatality	Year _____	Year _____
	Incidence		Inc.	Fat.
_____				
_____				
_____				

## 2. 2. Sources of water now used by the community in survey area.

## 2. 2. 1. Without piped system:

<u>Unprotected</u> <u>sources</u>	No. of sources Pop. using	Water condition			
		<u>Clear</u>	<u>Turbid</u>	<u>Salty</u>	<u>Odor</u>
Dug well		_____	_____	_____	_____
		_____	_____	_____	_____

<u>Unprotected</u>		Water condition			
<u>sources</u>		<u>Clear</u>	<u>Turbid</u>	<u>Salty</u>	<u>Odor</u>
Spring at sources					
	No. of sources	—	—	—	—
	Pop. using	—	—	—	—
Spring river					
	No. of sources	—	—	—	—
	Pop. using	—	—	—	—
River	No. of sources	—	—	—	—
	Pop. using	—	—	—	—
Canal	No. of sources	—	—	—	—
	Pop. using	—	—	—	—
Pond	No. of sources	—	—	—	—
	Pop. using	—	—	—	—
_____	No. of sources	—	—	—	—
	Pop. using	—	—	—	—
<u>Protected sources</u>					
Well with handpump					
	No. of sources	—	—	—	—
	Pop. using	—	—	—	—
Protected spring					
	No. of sources	—	—	—	—
	Pop. using	—	—	—	—
Deep artesian well					
	No. of sources	—	—	—	—
	Pop. using	—	—	—	—
_____	No. of sources	—	—	—	—
	Pop. Using	—	—	—	—

## 2. 2. 2. With piped systems

Source	Pop. using	Water condition			
		<u>Clear</u>	<u>Turbid</u>	<u>Salty</u>	<u>Odor</u>
_____	_____	—	—	—	—
_____	_____	—	—	—	—

## Details of systems:

Description _____	Structure	
	<u>Good</u>	<u>Broken</u>
Source: Type _____ Capacity _____	_____	_____
Reservoir: Capacity _____ cu.m	_____	_____
Reservoir stand: Height _____ m	_____	_____
Pump house: Size _____	_____	_____
Pumps: Diesel _____ ea Electric _____ ea	_____	_____
Filter bed: area _____ sq.m	_____	_____
Pipes G.I.: Total length _____ m AC. : Total length _____ m Bamboo: Tct. " _____ m	_____	_____
Public reservoir No. _____ Capacity _____ cu.m	_____	_____
Public taps No. _____	_____	_____

## 2. 3. How far away are the present sources of water.

\_\_\_ The sources are in the community area.

\_\_\_ The sources are about \_\_\_\_\_ km. from the community area.

## 2. 4. Existing method of excreta disposal.

	<u>Number Existing</u>	<u>Number used</u>	<u>Pop. using</u>
Water seal bowl with septic tank	_____	_____	_____
Water seal bowl with pit	_____	_____	_____
Open hole pit latrine	_____	_____	_____
Latrine overhanging ponds and rivers	_____	_____	_____
Other methods: _____	_____	_____	_____

## 3. FIELD INVESTIGATION

## 3. 1. Sources of water which have been measured for yield.

	Location Desa	Yield L/sec	How measured
___ Spring, at source	_____	_____	_____
___ Spring river	_____	_____	_____
___ River	_____	_____	_____
___ Existing deep artesian well with positive head	Location Desa _____		
	Diameter _____		m
	Depth _____		m
	Positive head above ground level _____		m
	Discharge _____		L/sec
___ Existing well artesian negative shallow well	Location Desa _____		
	Diameter _____		m
	Depth from ground level to well bottom _____		m
	Depth from ground level to water level in dry season _____		m
	Depth from ground level to water level in rainy season _____		m
Dates of pumping	Pumping hours	Pump dis- charge L/sec	Depth from ground to static water when pumping
_____	_____	_____	_____
_____	_____	_____	_____
_____	_____	_____	_____

\_\_\_ There is no suitable source to measure the yield.

\_\_\_ The rainfall in the area is

Month	Average monthly rainfall(mm)	
	<u>Figures for Kecamatan</u>	<u>For Kabupaten</u>
_____	_____	_____
_____	_____	_____
_____	_____	_____

3. 2. What is the depth of ground water from ground level.

\_\_\_ in dry season \_\_\_\_\_ m

\_\_\_ in rainy season \_\_\_\_\_ m

3. 3. What is the Electric Power Supply available in survey area:

\_\_\_ No supply

\_\_\_ A supply of \_\_\_\_\_ Volts.

\_\_\_ Continuously  
\_\_\_ from \_\_\_\_\_ hrs. to \_\_\_\_\_ hrs.

\_\_\_ The supply is

\_\_\_ by P.L.N. (Government Electric Company).

\_\_\_ by Local Generator.

#### 4. STAFF & COMMUNITY ORGANIZATION

4. 1. What is the existing sanitation staff.

	<u>Names</u>		
	<u>Health Controller</u>	<u>Sanitarian</u>	<u>Assistant Sanitarian</u>
Full time			
-At the Desa	_____	_____	_____
-At the Kecamatan	_____	_____	_____
-At the Kabupaten	_____	_____	_____

	<u>Health Con- troller</u>	<u>Names Sanitarian</u>	<u>Assistant Sanitarian</u>
Part time			
-At the Desa	_____	_____	_____
-At the Kecamatan	_____	_____	_____
-At the Kabupaten	_____	_____	_____

4. 2. What is the number of existing staff at the Kabupaten Public Works.

Engineer	_____
Bachelor	_____
Technician (High School)	_____
Technician (Junior School)	_____

4. 3. Give names of Kabupaten Public Works or other officials who will assist the Projects.

	<u>Name</u>	<u>Title</u>
Survey	_____	_____
	_____	_____
Preliminary Design	_____	_____
	_____	_____
Detailed Design for construction	_____	_____
Construction	_____	_____
Operation & Maintenance	_____	_____

4. 4. Is there an active community organization in the area.

\_\_\_ Yes. Give a list of some works done by the organization during the past six months:

\_\_\_\_\_

\_\_\_\_\_

\_\_\_ No.



4. 5. Give the name of a member of the community (not an official) who could be trained to operate and maintain the water supply systems.

<u>Name</u>	<u>Address</u>
_____	_____

4. 6. Give the names of officers doing the following work.

<u>Item</u>	<u>Dates work done</u>	<u>Names and Title of officers Doing the work</u>	<u>Assisting</u>
Data collection	_____	_____	_____
	_____	_____	_____
Filling out questionnaire	_____	_____	_____
	_____	_____	_____
Preparing the drawing	_____	_____	_____
	_____	_____	_____

4. 7. Attach a letter signed by Desa Chief:

-requesting a Project.

-agreeing to assist in construction, operation and maintenance.

Date \_\_\_\_\_

\_\_\_\_\_  
 Name, Title and Signature of Responsible Officer.



## SELECTED BIBLIOGRAPHY

PUBLICATIONS PRODUCED DURING THE  
UNIVERSITY OF OKLAHOMA STUDY ON APPROPRIATE  
LDC WATER/WASTEWATER TREATMENT METHODS

The following titles were produced under the sponsorship of the U.S. Agency for International Development under the contract number (AID/CM/ta-C-73-13 Res.) The issuing office was the Bureau of Water and Environmental Resources Research, the University of Oklahoma, Norman, Oklahoma 73069. A publication number for each title is given and indicated by the letters PN.

1. Canter, L. W., and Malina, J. F. Sewage Treatment in Developing Countries. PN-AAD-286. 1976.
2. Coffey, Kay, and Reid, G. W. Historic Implication for Developing Countries of Developed Countries Water and Wastewater Technology. PN-AAD-288. 1976.
3. Gorkum, Willem van, and Kempenaar, Kees. Rural Water Supply in Developing Countries. Part 2. PN-AAD-285. 1975.
4. Huisman, L. Treatment Methods for Water Supplies in Rural Areas of Developing Countries. Part 1. PN-AAD-284. 1975.

5. Muga, Erasto. Socio-Economic Conditions Which Pertain to Cost of Construction and Operation of Water and Sewage Treatment Facilities and Quantity of Water Consumption in Kenya. PN-AAD-290. 1976.
6. Pan American Center for Sanitary Engineering and Environmental Sciences, Lima. Evaluation of Lower Cost Methods of Water Treatment in Latin America. PN-AAD-289. 1976.
7. Philippines, National Pollution Control Commission. A Water Sterilization Study in the Philippines. PN-AAD-282. 1976.
8. Reid, G. W. A Catalog of Water Supply and Waste Disposal Methods for Individual Units. PN-AAD-283. 1975.
9. \_\_\_\_\_. Appropriate Methods of Treating Water and Wastewater in Developing Countries: Data Requirements. PN-AAD-295. 1975.
10. \_\_\_\_\_. Low Cost Methods of Treating Water and Sewage in Developing Countries: Summary Report. PN-AAD-219. 1974.
11. Reid, G. W., and Discenza, Richard. Prediction Methodology for Suitable Water and Wastewater Processes. PN-AAB-419, English; PN-AAD-291, Spanish. 1975.
12. \_\_\_\_\_. Prediction Methodology for Suitable Water and Wastewater Processes. Supplement 1: Manual Computation Method. PN-AAD-292. 1975.
13. \_\_\_\_\_. Prediction Methodology for Suitable Water and Wastewater Processes. Supplement 2: Computer Program. PN-AAD-293. 1975.
14. Reid, G. W., and Muiga, M. I. A Mathematical Model for Predicting Water Demand, Wastewater Disposal, and Cost of Water and Wastewater Treatment Systems in Developing Countries. PN-AAD-294. 1976.
15. Taiwan, Institute of Environmental Sanitation. The Study of Microbial Treatment of Nightsoil. PN-AAD-281. 1976.
16. Thailand, Ministry of Public Health, Rural Water Supply Division. Study of an Existing Water Treatment Plant of Simple Design and Operating System for Supplying Drinking Water to Rural Communities in the Lower Mekong Basin Countries. PN-AAD-280. 1976.
17. World Health Organization International Reference Centre for Community Water Supply, The Hague. Contributions to a Mail Survey on Practical Solutions in Drinking Water Supply and Waste Disposal for Developing Countries. PN-AAD-287. 1977.

The following two titles were published in the Netherlands by the World Health Organization International Reference Centre for Community Water Supply.

18. Reid, G. W., and Discenza, Richard. Prediction Methodology for Suitable Water and Wastewater Processes. Technical Paper Series, no. 8. The Hague, The Netherlands: WHO International Reference Centre for Community Water Supply, September 1976.
19. World Health Organization, International Reference Centre for Community Water Supply. A Report on the Global Workshop on Appropriate Water and Wastewater Treatment Technology for Developing Countries, Voorburg, The Netherlands, 17-22 November 1975. Bulletin Series, no. 7. Voorburg (The Hague), April 1977.

CHAPTER I. INTRODUCTION:  
INTERFACE FOR DECISION

1. Abelishvilli, G. Soviet Scientists Waterproof Ponds. Moscow: Novosti Press Agency.
2. Agency for International Development. Technology and Economics in International Development. Springfield, Virginia: National Technical Information Service (NTIS), 1972.
3. Biological Filters, Community Water Supply Research and Development, WHO/CWS/RD/70.1.
4. Campbell, Michael D., and Lehr, Jay H. Rural Water Systems Planning and Engineering Guide. Washington, D.C.: Commission on Rural Water, 1973.
5. Cleary, Edward J., et al. International Program in Sanitary Engineering Design Evaluation and Recommendations. Washington, D.C.: Agency for International Development, 1971.
6. Community Water Supply Unit. The Village Tank as a Source of Drinking Water. RD/69.1. Geneva: World Health Organization, 1969.
7. Cost of Water Treatment in Illinois. Technical Letter 11. Urbana, Illinois: Illinois State Water Survey, 1968.
8. Cox, C. R. Operation and Control of Water Treatment Processes. Monograph Series no. 49. World Health Organization, 1969.
9. Cunningham, J. H. "Potable Water for Nigeria." Water and Wastes Engineering (July 1973).

10. Dawes, J. H., and Wathne, M., Cost of Reservoirs in Illinois. Circular 96. Urbana, Illinois: Illinois State Water Survey, 1968.
11. Dennis, J. M. "Infectious Hepatitis Epidemic in Delhi, India." Journal of the American Water Works Association (October 1959).
12. Donaldson, David. Progress in the Rural Water Programs of Latin America (1961-1971). Washington, D.C.: Pan American Health Organization, 1973.
13. Extended Aeration System in India. Nagpur, India: Central Public Health Engineering Research Institute, 1972.
14. Fair, G. M., Geyer, J. C., and Okun, D. A. Water and Wastewater Engineering. New York: John Wiley & Sons, 1968.
15. Finch, J. The Planning and Organization of Industrial Waste Programs. WHO/WD/70.6.
16. Fourth Annual Report. The Hague, The Netherlands: World Health Organization International Reference Center for Community Water Supply, 1972.
17. Gloyna, E. F. Waste Stabilization Ponds. WHO Monograph no. 60. Geneva: WHO, 1971.
18. Green, Paul E., and Tull, Donald S. Research for Marketing Decisions. 2nd ed. Englewood Cliffs, N. J.: Prentice-Hall, 1970.
19. Guidelines and Criteria for Community Water Supplies in the Developing Countries. Rockville, Maryland: Consumer Protection and Environmental Health Service, 1969.
20. Herfindahl, Orris C. Natural Resource Information for Economic Development. Baltimore, Maryland: The Johns Hopkins Press, 1969.
21. Intermediate Technology Development Group, Water Panel. Water for the Thousand Millions. Edited by Arnold Pacey. Oxford: Pergamon Press, 1977.
22. Koenig, L. "Cost of Water Treatment by Coagulation, Sedimentation, and Rapid Sand Filtration." Journal of the American Water Works Association 59, no. 3 (1967).
23. Lauria, Donald. Report on Water Demand Study. Chapel Hill, N.C.: International Program in Sanitary Engineering Design, University of North Carolina, 1969.

24. McGarry, M. G. Photosynthetic Yields and By-Product Recovery from Sewage Oxidation Ponds. Bangkok, Thailand: Asian Institute of Technology.
25. McGarry, M. G. Water and Protein Reclamation from Sewage. Bangkok, Thailand: Asian Institute of Technology.
26. McJunkin, Frederick E. Community Water Supply in Developing Countries: A Quarter-Century of United States Assistance. Washington, D.C.: Agency for International Development, 1969.
27. "Mzima Pipeline: The World's Largest Gravity Flow." Water and Wastes Engineering 7 (1970).
28. Paul, Benjamin D., and Miller, Walter B. Health Culture and Community: Case Studies of Public Reactions to Health Programs. New York: Russell Sage Foundation, 1955.
29. Pavanello, R., and Vouk, V. B. Health Aspects of Water Pollution. EP/70.4. Geneva: World Health Organization, 1970.
30. Reid, George W. Lower Cost Methods of Water and Waste Treatment in Less Developed Countries. Norman, Oklahoma: The University of Oklahoma Research Institute, 1973.
31. Reuse of Effluents: Methods of Wastewater Treatment and Health Safeguards. Technical Report no. 517. Geneva: WHO.
32. Robbins, Michael C., and Kilbride, Philip L. "Microtechnology in Rural Buganda." In Technology and Social Change, pp. 202-225. Edited by H. Russell Bernard and Pertti Pelto. New York: The Macmillan Company, 1972.
33. Shaner, Willis W. "Some Problems Associated with the Use of Expatriate Advisors in Developing Countries." In Transfer of Water Resources Knowledge, pp. 315-317. Edited by Evan Vlachos. Proceedings of the First International Conference on Transfer of Water Resources Knowledge, September 1972, Fort Collins, Colorado, U.S.A. Fort Collins: Water Resources Publications, 1973.
34. Standardized Procedure for Estimating Costs of Conventional Water Supplies. Kansas City, Mo.: Black and Veatch Consulting Engineers, 1963.
35. "Survey of Water Treatment Plants." Technical Digest no. 13. Nagpur, India: Central Public Health Engineering Research Institute, January 1971.
36. Taylor, Charles Lewis, and Hudson, Michael C. World Handbook of Political and Social Indicators. 2nd ed. New Haven: Yale University Press, 1972.

37. Tjiok, T. K. An Integrated Program of Development and Promotion of Appropriate Technology in Community Water Supply. Bilthoven, The Netherlands: WHO International Reference Center for Community Water Supply, April 1973.
38. U.S., Agency for International Development. Economic Data Book. Washington, D.C.: U.S. Department of State, Statistics and Reports Division, 1973.
39. U.S., Department of Labor. Demographic Techniques for Manpower Planning in Developing Countries. Washington, D.C.: The Agency for International Development, 1968.
40. Village Technology Handbook. Rev. ed. Schenectady, N.Y.: Volunteers for International Technical Assistance (VITA), 1970.
41. von der Mehden, Fred R. Politics of the Developing Nations. 2nd ed. Englewood Cliffs, N.J.: Prentice-Hall, 1969.
42. Wagner, E. G., and Lanoix, J. N. Excreta Disposal for Rural Areas and Small Communities. Geneva: World Health Organization, 1958.
43. \_\_\_\_\_. Water Supply for Rural Areas and Small Communities. Monograph Series no. 42. Geneva: World Health Organization, 1959.
44. Water and Wastewater Problems in Rural America. Washington, D.C.: Commission on Rural Water, 1973.
45. Water Pollution Control in Developing Countries. Technical Report no. 404. Geneva: WHO.
46. Water Supply and Sewerage. Sector Working Paper. World Bank, October 1971.
47. White, G. F., et al. Drawers of Water: Domestic Water Use in East Africa. Chicago: The University of Chicago Press, 1972.
48. World Health Organization, Division of Environmental Health, Community Water Supply and Sanitation. Research Needs in WHO Member States. Background Document 1. Bilthoven, The Netherlands: WHO International Reference Center for Community Water Supply, April 1973.
49. WHO Expert Committee. Community Water Supply. Technical Report Series no. 420. Geneva: World Health Organization, 1969.
50. \_\_\_\_\_. Solid Wastes Disposal and Control. Technical Report Series no. 484. Geneva: World Health Organization, 1971.



51. \_\_\_\_\_. Reuse of Effluents: Methods of Wastewater Treatment and Health Safeguards. Technical Report Series no. 517. Geneva: World Health Organization, 1973.
52. \_\_\_\_\_. Water Pollution Control in Developing Countries. Technical Report Series no. 404. Geneva: World Health Organization, 1968.
53. World Health Organization, International Reference Centre for Community Water Supply. A Report on the Global Workshop on Appropriate Water and Wastewater Treatment Technology for Developing Countries, Voorburg, The Netherlands, 17-22 November, 1975. Bulletin Series, no. 7. Voorburg (The Hague), April 1977.
54. \_\_\_\_\_. "Rural Water Supply in Nigeria." The Newsletter no. 20 (1972).
55. \_\_\_\_\_. Sewage Lagoons for Developing Countries. Ideas and Methods, no. 62. Washington, D.C.: U.S., Agency for International Development, Jan. 1966.
56. \_\_\_\_\_. Problems in Community Waste Management. Public Health Papers no. 30. Geneva: WHO, 1969.
57. WHO Programme in Basic Sanitary Services, Community Water Supply and Wastes Disposal: The Advancement and Transfer of Knowledge and Methods. Geneva: World Health Organization, 1973.
58. WHO Scientific Group. Treatment and Disposal of Wastes. Technical Report Series no. 367. Geneva: World Health Organization, 1967.
59. Zimmerman, Stanley, and Cobb, Edwin L. Guide for the Development of Local Water Projects. Washington, D.C.: Commission on Rural Water, 1973.

## CHAPTER II. TECHNOLOGY TRANSFER, ADAPTATION, AND UTILIZATION

1. Allen, Thomas J. "The International Technological Gatekeeper." Technology Review (March 1971):36-43.
2. Balasubramanyam, V. N. International Transfer of Technology to India. New York: Praeger Publishers, 1973.
3. Barb, Charles E., Jr. "The Evolution of GBF-Dime Technology in the United States." University of Oklahoma, 1977.

4. Carruthers, I. D. Impact and Economics of Community Water Supply: A Study of Rural Water Investment in Kenya. Ashford, Kent, England: School of Rural Economics and Related Studies, Wye College, 1973.
5. Churchman, C. West. The Systems Approach. New York: Dell Publishers, 1968.
6. Darrow, Ken and Rick, Pam. Appropriate Technology Sourcebook. Stanford: Volunteers in Asia, 1976.
7. David, Paul A. Technical Choice Innovation and Economic Growth: Essays on American and British Experience in the Nineteenth Century. London: Cambridge University Press, 1975.
8. Dorf, Richard C. Energy, Resources, and Policy. London: Addison-Wesley Publishing Company, 1978.
9. Exxon Company. U.S.A.'s Energy Outlook 1977-1990. January 1977.
10. Falkenmark, Malin, and Lindh, Gunnar. Water for a Starving World. Translated by Roger G. Tanner. Boulder, Colorado: Westview Press, 1976.
11. Flack, J. Ernest, ed. Proceedings of the Conference on Interdisciplinary Analysis of Water Resource Systems, June 19-22, 1973, University of Colorado, Boulder, Colorado. New York: American Society of Civil Engineers, 1975.
12. Florman, Samuel C. "In Praise of Technology." Harper's (November 1975):53.
13. Gee, Sherman. "The Role of Technology Transfer in Innovation." Research Management (November 1974):32.
14. Glennan, T. Keith. Technology and Foreign Affairs. Washington, D.C.: United States Department of State, 1976.
15. Goulet, Denis. "The Paradox of Technology Transfer: The Third World's Ladder to Development Can Also Be the Avenue to Colonialism." Bulletin of the Atomic Scientists (June 1975): 39.
16. Jones, Graham. The Role of Science and Technology in Developing Countries. London: Oxford University Press, 1971.
17. Kuznets, Simon. Economic Growth of Nations: Total Output and Production Structure. London: The Belknap Press of Harvard University Press, 1971.
18. Lembaga Ilmu Pengetahuan Indonesia and National Academy of Sciences of the United States. Workshop on Industrial and Technological Research. Vol. 1: Overall Findings and Recommendations. Djakarta, Indonesia, January 1971.

19. Mason, R. Hal. The Transfer of Technology and the Factor Proportions Problem: The Philippines and Mexico. New York: United Nations Institute for Training and Research, 1971.
20. McNow, John S., ed. Technical Education in Africa. Nairobi, Kenya: East African Publishing House, 1970.
21. Meadows, Donella H. et al. The Limits to Growth. New York: Universe Books, 1972.
22. Meguid, A. R. Abdel. "Economics and Technology of Development." In Views of Science Technology and Development. Oxford, 1975.
23. Meyer, K. Rudy. The Transfer of Technology to Developing Countries: The Pulp and Paper Industry. New York: United Nations Institute for Training and Research, 1974.
24. National Academy of Sciences. Meeting the Challenge of Industrialization: A Feasibility Study for an International Industrialization Institute. Report of a Special International Panel of the Board on Science and Technology for International Development Office of the Foreign Secretary. Washington, D.C.: U.S. Government Printing Office, 1973.
25. \_\_\_\_\_. Research Management and Technical Entrepreneurship: A U.S. Role in Improving Skills in Developing Countries. Report of an Ad Hoc Advisory Panel of the Board on Science and Technology for International Development. Washington, D.C.: U.S. Government Printing Office, 1973.
26. \_\_\_\_\_. Scientific and Technical Information for Developing Countries. Washington, D.C.: U.S. Government Printing Office, April 1972.
27. \_\_\_\_\_. Technology: Processes of Assessment and Choice. Washington, D.C.: U.S. Government Printing Office, July 1969.
28. National Institute of Sciences of India and National Academy of Sciences of the United States. Report of the Indo-U.S. Workshop on the Management and Organization of Industrial Research. Baroda, India, March 2-6 1970.
29. National Science Foundation. The Effects of International Technology Transfers on U.S. Economy. Papers and proceedings of a colloquium held in Washington, D.C., November 17, 1973. Washington, D.C.: U.S. Government Printing Office, July 1974.
30. Oldham, C. D. G.; Freeman, C.; and Turkcan, E. Transfer of Technology to Developing Countries. Study of the Science Policy Research Unit of the University of Sussex, for the U.N. Conference on Trade and Development, Second Session. TD/28/Supp. 1. November 10, 1967.

31. Perrin, J. Choice and Adaptation of Technology in Developing Countries. Paris, 1974.
32. Renis, Gustav. "Some Observations on the Economic Framework for Optimum LDC Utilization of Technology." Economic Growth Center paper no. 152. Yale University, August 1972.
33. Rosenberg, Nathan. Perspectives on Technology. Cambridge: Cambridge University Press, 1976.
34. Rubenstein, Albert H. et al. Research Priorities on Technology Transfer to Developing Countries. Report of Two NU/NSF Workshops Held at Northwestern University, May 1973 and Washington, D.C., September 1973. Washington, D.C.: U.S. Government Printing Office, January 1974.
35. Schumacher, E. F. "Intermediate Technology." The Center Magazine. The Center for the Study of Democratic Institutions.
36. \_\_\_\_\_. Small is Beautiful: Economics as if People Mattered. New York: Harper & Row, 1973.
37. Steele, R. D. Multinational Corporations, Technology Transfer, and the Developing Countries: An Introductory Bibliography. Council of Planning Librarians, Exchange Bibliography #745. Monticello, Illinois, 1975.
38. Stobaugh, Robert B. The International Transfer of Technology in the Establishment of the Petrochemical Industry in Developing Countries. United Nations Institute for Training and Research. New York, 1971.
39. Torto, F. G. "Some Problems of Development in African Countries: Foreign Assistance in Development Research Capability." In Views of Science Technology and Development. Oxford, 1975.
40. United Nations Conference on Trade and Development. The Reverse Transfer of Technology: Economic Effects of the Outflow of Trained Personnel from Developing Countries (Brain-Drain). Trade and Development Board, Intergovernmental Group on Transfer of Technology, Third Session. Geneva, 15 July 1974.
41. \_\_\_\_\_. The Role of the Patent System in the Transfer of Technology to Developing Countries. Trade and Development Board, Intergovernmental Group on Transfer of Technology, Third Session. Geneva, 15 July 1974.
42. U.S., House of Representatives, Committee on Science and Astronautics. Government, Science, and International Policy. Washington, D.C.: U.S. Government Printing Office, 1967.

43. U.S., House of Representatives, Committee on Science and Technology. Review of Technology Transfer to the Organization of Petroleum Exporting Countries. Washington, D.C.: U.S. Government Printing Office, 1976.
44. \_\_\_\_\_. Technology Transfer to the Middle East O.P.E.C. Nations and Egypt, 1970-1975. Washington, D.C.: U.S. Government Printing Office, 1976.
45. Vemuri, V. "Multiple Objective Optimization." ASCE Annual and National Environmental Engineering Meeting, October 16-22, 1972, Meeting Preprint 1837.
46. Wexler, Alvin, ed. Large Engineering Systems. Proceedings of the International Symposium Held at the University of Manitoba, Winnipeg, Canada, August, 1976. Oxford: Pergamon Press, 1977.

CHAPTER III. PREDICTION METHODOLOGY  
FOR SELECTION OF SUITABLE WATER AND  
WASTEWATER PROCESSES

1. Donaldson, David. "Progress in the Rural Water Programs of Latin America." Bulletin of the Pan-American Health Organization 8,1(1974):41-42.
2. Reid, George W., and Discenza, Richard. Prediction Methodology for Suitable Water and Wastewater Processes. Norman: University of Oklahoma Bureau of Water and Environmental Resource Research, October 1975.
3. Reid, George W., and Discenza, Richard. Prediction Methodology for Suitable Water and Wastewater Processes. Technical Paper Series, no. 8. The Hague: WHO International Reference Centre for Community Water Supply, September 1976.
4. Reid, George W., and Discenza, Richard. Prediction Methodology for Suitable Water and Wastewater Processes. Supplement II: Computer Program. Norman: The University of Oklahoma Bureau of Water and Environmental Resources Research, May 1975.

CHAPTER IV. METHODOLOGY FOR PREDICTION  
OF WATER AND WASTEWATER VOLUMES AND  
TREATMENT COSTS

1. Ackerman. Journal of American Water Works Association (1968).
2. Black and Veatch (engineering firm). Manual for Calculation of Conventional Water Treatment Costs. Office of Saline Water Research and Development Report 917. U.S. Department of Interior, March 1972.

3. Butts, T. A., and Evans, R. L. Cost of Municipal Sewage Treatment Plants in Illinois. Urbana: State Water Survey, 1970.
4. Capen, Charles H., Jr. "How Much Water Do We Consume? How Much Do We Pay?" Journal of American Water Works Association 29 (1937):202-212.
5. Chenery. Journal of American Water Association (1952).
6. "Cost of Rural and Village Sanitation in Southeast Asian Region." World Health Organization Chronicle 21 (1967).
7. Diachishin, A. M. "New Guide to Sewage Plants Costs." Engineering News Record 159, No. 15 (October 1957):316.
8. Dieterich, B. H., and Henderson, J. M. Urban Water Supply Conditions and Needs in Seventy-Five Developing Countries. Geneva: World Health Organization Public Health, Paper 23, 1967.
9. Dixon, Wilfrid J. and Massey, Frank J. Introduction to Statistical Analysis. New York: McGraw-Hill Book Co., 1969.
10. Draper, N. R., and Smith H. Applied Regression Analysis. New York: John Wiley & Sons, 1960.
11. Durfor, Charles N., and Becker, Edith. Public Water Supplies of the 100 Largest Cities in the United States. U.S. Geological Survey, 1964.
12. Eckenfelder, W. W., Jr. Effluent Quality and Treatment Economics for Industrial Wastewater. U.S. Department of Interior, Federal Water Pollution Control Administration, 1967.
13. Fourt, Louis. "Forecasting the Urban Residential Demand for Water." Agriculture Economic Seminar, Department of Agricultural Economics, University of Chicago, February 1958.
14. Goldberger, Arthur S. Econometric Theory. New York: John Wiley & Sons, 1964.
15. Hanke, Steve H. "Demand for Water under Dynamic Conditions." Water Resources Research 6, No. 5 (October 1970).
16. Henderson, John M. Report on Global Urban Water Supply Costs in Developing Nations, 1961-1975. Washington, D.C.: International Cooperation Administration, 1961.
17. Howe, Charles W., and Linaweaver, F. P., Jr. "The Impact of Price on Residential Demand and its Relation to System Design and Price Structure." Water Resources Research 3, No. 1 (1967).

18. Howe et al. "Future Water Demands: The Impact of Technological Change, Public Policies, and Changing Market Conditions on the Water Use Patterns of Selected Sectors of the United States Economy: 1970-1990." A Study for the National Water Commission by Resources for the Future, Inc., June 1970.
19. Howell, D. H., and Buboiss, D. P. "Design Practices and Costs for Small Secondary Sewage Treatment Plants in the Upper Midwest." Sewage and Industrial Wastes 30, No. 1 (1958).
20. International Financial Statistics. International Monetary Fund, August 1974.
21. Koenig, Louis. "Cost of Water Treatment by Coagulation, Sedimentation, and Rapid Sand Filtration." Journal of American Water Works Association 59, No. 3 (March 1967).
22. Lauria, Donald T. Planning Small Water Supplies in Developing Countries. U.S. Agency for International Development, Office of Health, 1972.
23. Lee, Terence R. Residential Water Demand and Economic Development. University of Toronto, Department of Geography, Research Publication No. 2. University of Toronto Press, 1969.
24. Logan, J. A. et al. "Analysis of the Economics of Wastewater Treatment." Journal of Water Pollution Control Federation 34, No. 9 (September 1962).
25. Low Cost Waste Treatment. Nagpur, India: Central Public Health Engineering Research Institute, 1972.
26. Merrill, William C. and Fox, Karl A. Introduction to Economic Statistics. New York: John Wiley & Sons, 1970.
27. Meyer, John M., Jr., and Mangan, George F. "System Pinpoints Urban Water Needs." Environmental Science and Technology 3, No. 10 (October 1969).
28. Park, W. "Make Quick Sewage Plant Construction Estimates." Engineering News Record 1968, No. 12 (March 1962).
29. Parzen, E. Modern Probability Theory and Its Application. New York: John Wiley & Sons, 1960.
30. Reid, George W. "Multi-structured Municipal Water Demand." Water Resources Bulletin (Journal of the American Water Resources Association) 7, No. 6 (December 1971).
31. \_\_\_\_\_. Water Requirements for Pollution Abatement Committee. Print No. 29. Water Resources Activities in United States for the U.S. Senate Committee on National Water Resources, July 1960.

32. Reid, George W., and Muiga, Michael I. "Aggregate Modeling of Water Demands for Developing Countries Utilizing Socio-Economic Growth Pattern." UNDP/UN Interregional Seminar on River Basin and Interbasin Development, Budapest, Hungary, September 1975.
33. Sasaki, K., and Sasaki, S. The Methods of Water Requirements Forecasting in Japan. United Nations, ESA, 1972.
34. Shah, Kanti L., and Reid, George W. "Techniques for Estimating Construction Costs of Wastewater Treatment Plants." Journal of Water Pollution Control Federation (May 1970).
35. Smith and Eiler, Cost to Consumer for Collection of Wastewater. United States Environmental Protection Agency, July 1970.
36. Tahol Water Planning, Ltd., and Engineering Science, Inc. Master Plan for Water Supply and Sewerage, Government of Ghana. Vol. 1: Engineering Report for Accra-Tema Metropolitan Area. October 1965.
37. Thoman, R. V., and Jenkins, K. H. "How to Estimate Sewage Plants Quickly." Engineering News Record 161, No. 26 (December 1958).
38. United Nations Conference on Human Environment. Stockholm, Sweden, 1972.
39. United Nations Statistics Data. 1971, 1972, 1973.
40. United Nations, Urban and Rural. ESA/P/WP, 33/Rev./New York.
41. U.S. Department of Health Education and Welfare. Modern Sewage Treatment Plants -- How Much Do They Cost? Washington, D.C.
42. Velz, C. J. "How Much Should Sewage Treatment Cost?" Engineering News Record 141, No. 6.
43. White, G. F.; Bradley, David J.; and White, Anne U. Drawers of Water. Chicago: University of Chicago Press, 1972.
44. Wolman, A. Forecasts of Water Use and Water Quality: A Model for the United States. April 1970.
45. Wolman, Abel. "Assessing Water Uses and Minimal Requirements." Ad Hoc Group of Experts in Water Requirements Forecasting, Budapest, 10-17 May 1972. United Nations, ESA/RT/AC.3/14.
46. Wollman, N. Cost of Treatment. New Mexico: University of New Mexico, 1963.
47. Wong, S. T. et al. Multivariate Statistical Analysis of Metropolitan Area Water Supplies. Chicago: Northeastern Illinois Metropolitan Area Planning Commission, May 1963.



48. Wood, W. E. "National Rural Water Supply Programmes." Paper presented by the World Health Organization at the Economic Commission for Africa Working Group of Experts in Water Resources Planning, Addis Ababa, 19-25 June 1970.
49. World Health Organization EH/712.
50. World Health Organization, International Reference Centre for Community Water Supply. "Water Dispensing Devices Aid Methods for Public Water Supply in Developing Countries." Interim Report. The Hague, Netherlands.
51. Yamane, Taro. Elementary Sampling Theory. Englewood Cliffs, N. J.: Prentice-Hall, 1967.

CHAPTER V. METHODOLOGY FOR ESTABLISHING  
PRIORITIES AMONG WATER SUPPLY PROGRAMS:  
A CASE STUDY

1. Indonesian Ministry of Health, Directorate General of Communicable Diseases, Directorate of Hygiene and Sanitation. Jakarta, Indonesia. Personal Communication.
2. Pineo, C. S., and Subrahmanyam, D. V. Community Water Supply and Excreta Disposal Situation in Developing Countries, A Commentary. Offset Publication no. 15. Geneva: World Health Organization, 1975.
3. Project System Analysis Group, World Health Organization. A Priority Setting for Rural Water Supply Program in the West Java Province, Indonesia. January 3 - March 3, 1973.
4. Reid, George W., and Discenza, Richard. Prediction Methodology for Suitable Water and Wastewater Treatment Processes. Norman: University of Oklahoma, Office of Research Administration, 1975.
5. Republic of Indonesia. Guidelines of INPRES Program in Rural Water Supply and Sanitation. April 1974.
6. Republic of Indonesia. "Guidelines of the Improvement in Health Care." Second Five-Year Development Plan, 1974 - 1979.
7. Republic of Indonesia, National Committee for the World Population Year 1974. Population and Development in Indonesia. Report for the World Population Conference, Bucharest, Romania, 19 - 30 August 1974.
8. Saunders, R. J., and Warford, J. J. "Village Water Supply and Sanitation in Less Developed Countries: Economics and Policy." Draft, January 1975.

9. United Nations Children's Fund. "Assignment Children." Water and Community Development 34 (April - June 1976).
10. United Nations Children's Fund and World Health Organization. Report on Rural Water Supply in Indonesia. EH/SEARO/75.1. April 1975.
11. Wheelwright, Steven C., and Makridakis, Spyros. Forecasting Methods for Management. New York: John Wiley & Sons, 1973.
12. World Bank. "Village Water Supply." March 1976.
13. World Health Organization, Regional Office for Southeast Asia. Annual Report of the Regional Director. 1972 - 1973.

CHAPTER VI. IMPLICATION OF PAST  
DEVELOPMENTS IN WATER AND  
WASTEWATER TECHNOLOGY

1. Ainge, Thomas S. The Sanitary Sewerage of Buildings. Chicago: Domestic Engineering, 1907.
2. Baker, M. N. The Quest for Pure Water: The History of Water Purification from the Earliest Records to the Twentieth Century. New York: American Water Works Association, 1949.
3. Broadhurst, Jean. Home and Community Hygiene: A Textbook of Personal and Public Health. 4th ed. rev. Lippincott's Home Manuals, edited by Benjamin R. Andrews. Philadelphia: J. B. Lippincott Co., 1929.
4. Chadwick, Edwin. Report on the Sanitary Condition of the Labouring Population of Great Britain, 1842. Edited by M. W. Flinn. Edinburgh: Edinburgh University Press, 1965.
5. Compton's Pictured Encyclopedia and Fact-Index, 1952 ed. S. v. "Water."
6. Council of the Citizens' Association. Report of the Council of Hygiene and Public Health of the Citizens' Association of New York, Upon the Sanitary Condition of the City. 2nd ed. New York: D. Appleton & Co., 1866; reprint ed., New York: Arno Press and New York Times, 1970.
7. Daumas, Maurice, ed. A History of Technology and Invention: Progress Through the Ages. Vol. 1: The Origins of Technological Civilization. Translated by Eileen B. Hennessy. New York: Crown Publishers, 1969.
8. \_\_\_\_\_ . A History of Technology and Invention: Progress Through the Ages. Vol. 2: The First Stages of Mechanization. Translated by Eileen B. Hennessy. New York: Crown Publishers, 1969.

9. Don, Graham. London School of Hygiene and Tropical Medicine.
10. Draffin, Jasper Owen. The Story of Man's Quest for Water. Champaign, Ill.: Garrard Press, 1939.
11. Duffy, John. A History of Public Health in New York City, 1625-1866. New York: Russell Sage Foundation, 1968.
12. Ehlers, Victor Marcus, and Steel, Ernest W. Municipal and Rural Sanitation. 6th ed. New York: McGraw-Hill Book Co., 1965.
13. Frontinus, Sextus Julius. The Two Books on the Water Supply of the City of Rome of Sextus Julius Frontinus, Water Commissioner of the City of Rome, A.D. 97. Translation and explanatory chapters by Clemens Herschel. Boston: Dana Estes & Co., 1899.
14. Gay, Charles Merrick, and De van Fawcett, Charles. Mechanical and Electrical Equipment for Buildings. New York: John Wiley & Sons, 1935.
15. Jephson, Henry. The Sanitary Evolution of London. London: T. Fisher Unwin, 1907.
16. Mumford, Lewis. Technics and Civilization. New York: Harcourt, Brace & Co., 1934.
17. Pritchard, James B. The Water System of Gibeon. Museum Monographs. Philadelphia: University Museum, University of Pennsylvania, 1961.
18. Read, Brian. Healthy Cities: A Study of Urban Hygiene. Topics in Modern History Series. Gen. ed. Ivor D. Astley. Glasgow: Blackie, 1970.
19. Robins, F. W. The Story of Water Supply. London: Oxford University Press, 1946.
20. Small, F. L. The Influent and the Effluent: The History of Urban Water Supply and Sanitation. Manitoba, Canada: Underwood McLellan and Associates, Modern Press, 1974.
21. Weber, H., and Wasmer, H. R. Swiss Federal Institute for Water Resources and Water Pollution Control (EAWAG). WHO International Reference Centre for Water Disposal. "A Study on Historical Methods of Water and Sewage Treatment." EAWAG Project, number 4498. Dübendorf, Switzerland, May 31, 1975.
22. Wolman, Abel, and Bosch, Herbert M. "U.S. Water Supply Lessons Applicable to Developing Countries," Water, Health and Society. Edited by Gilbert F. White. Bloomington: Indiana University Press, 1969; reprinted from Journal American Water Works Association 55 (August 1963).

## CHAPTER VII. WATER SUPPLY AND TREATMENT

VII. 1. PART ONE. WATER SUPPLIES IN RURAL  
AREAS OF DEVELOPING COUNTRIES (PART ONE)

1. Miller, Arthur P. Water and Man's Health. Community Water Supply Technical Series, no. 5. Washington, D.C.: U.S. Agency for International Development, 1962.
2. "The Village Tank as Source of Drinking Water." WHO/CWS/RD/69.1.
3. White, Gilbert F.; Bradley, David J.; and White, Anne U. Drawers of Water: Domestic Water Use in East Africa. Chicago: University of Chicago Press, 1972.

VII. 1. PART TWO. WATER SUPPLIES IN RURAL  
AREAS OF DEVELOPING COUNTRIES (PART TWO)

1. Agarwal, I. C., and Agrawal, G. D. "Operating Slow Sand Filters with Alum Coagulated Water." Proceedings of a Symposium on Environmental Pollution. Nagpur, India: Central Public Health Engineering Research Institute, 1973.
2. Agromisa. "Techniek" (Technique). Vraagbaak second file, no. 3 (September 1974):30-58.
3. Arboleda, J. "Expansion of Cucuta, Colombia, Water Treatment Plant Using Dual Media Filtration." Paper presented at the Aidis Congress. Caracas, August 1970.
4. Assaduzaman, M., and Khan, O. K. "Bamboo Tube Well." The Bangladesh Observer, 12 July 1974.
5. Australian Water Resources Council. Evaporation from Water Storages. Hydrological Series, no. 4. Canberra, 1970.
6. Batemann, G. H. A Bibliography of Low Cost Water Technologies. London: Intermediate Technology Development Group, October 1974.
7. Borjesson, E. K. G., and Bobeda, C. M. "New Concept in Water Service for Developing Countries." Journal of the American Water Works Association 56 (1964):853-862.
8. Brace Research Institute. How to Make a Solar Still Plastic Covered. Do It Yourself Leaflet, no. L-1. Quebec, Canada, February 1975.
9. Brett-Young, A. "Saael Drought: Voluntary Agencies' Crucial Role." Overseas Development 48 (Sept. 1974).

10. Briggs, G. F., and Mogg, J. L. "Modern Wells Produce Quality Water Economically." Proceedings of a Water Supply and Sanitation Seminar, Bangkok, Thailand, 19-23 Jan. 1970. Asian Institute of Technology.
11. Bryant, E. A. "Forecasting Urban Water Demands in Developing Countries." Water for Peace. Vol. 7: Planning and Developing Water Programs. 1967.
12. Bureau Central d'Études pour les Équipements d'Outre Mer. Techniques rurales en Afrique. Numéro 7: Hydraulic pastorale. 1969.
13. Burton, I. E., Idelovitch, E., and Maystre, J. Technology Assessment and Research Priorities for Water Supply and Sanitation in Developing Countries (with special reference to rural populations and small communities). Ottawa, Canada: International Development Research Centre, 22 Nov. 1973.
14. Caponera, D. A. Water Laws in Moslem Countries. United Nations Food and Agriculture Organization Development Paper, no. 42. March 1954.
15. Central Public Health Engineering Research Institute. Defluoridation. Nagpur, India: Nehru Marg, December 1973.
16. Central Public Health Engineering Research Institute. Disinfection for Small Community Water Supplies. Nagpur, India.
17. \_\_\_\_\_. Disinfection Techniques for Small Community Water Supplies. Nagpur, India, 1969.
18. \_\_\_\_\_. Indian Literature in Environmental Engineering: Annual Bibliography. 1971.
19. \_\_\_\_\_. Iron and Manganese Removal in Rural Water Supplies. Technical Digest, no. 9 Nagpur, India, Sept. 1970.
20. \_\_\_\_\_. Membrane Filter. Technical Digest, no. 14. Nagpur, India, Feb. 1971.
21. \_\_\_\_\_. Survey of Water Treatment Plants. Technical Digest, no. 13. Nagpur, India, Jan. 1971.
22. \_\_\_\_\_. "Water Supply and Waste Disposal for Greater Bombay." Part I: "Water Supply." 1970-1971.
23. Channabasappa, K. "Reverse Osmosis Desalination Process as a Village Water Supply System." Proceedings of a Water Supply and Sanitation Seminar Held in Bangkok, Thailand, 19-23 Jan. 1970. Edited by Pescod and Okun. Asian Institute of Technology.
24. Chatterjee, A. K., Srivastava, G. C. "Sterilisation of Water under Field Conditions." Proceedings of a Symposium on Environmental Pollution. Nagpur: Central Public Health Engineering Research Institute, 1973.

25. Cleasby, J. C. "New Ideas in Filter Control Systems." Proceedings of a Symposium on New Methods of Water Treatment, Asuncion, Paraguay, 14-18 Aug. 1972.
26. Cox, C. R. Operation and Control of Water Treatment Processes. Monograph Series, no. 49. Geneva: WHO, 1969.
27. Diamant, B. Z. A Portable Unit for the Supply of Drinking Water in Emergencies. Community Water Supply Research and Development Programme, WHO/C.S.W./72.3.5.
28. Dieterich, B. H., and Henderson, J. H. Urban Water Supply Conditions and Needs in Seventy-Five Developing Countries. Public Health Paper, no. 23. Geneva: WHO, 1963.
29. Dixey, F. A Practical Handbook of Water Supply. London: Thomas Murby and Co., 1950.
30. Duin, J. F. "Energievoorziening, Pompen en Motoren" (Energy Supply, Pumps and Engines). Delft University of Technology, Department of Civil Engineering, 1974.
31. Dunn, P. D. "The Humphrey Pump." Appropriate Technology 2, no. 1 (May 1975): 20-21.
32. Eubanks, B. M. "A Pictorial History of the Handpump." Water Well Journal (July 1972).
33. Fair, G. M., Geyer, J. C., and Okun, D. A. Water and Wastewater Engineering. 2 vols. 1966, 1968.
34. Feachem, R. Domestic Water Use in the New Guinea Highlands: The Case of the Raiapu Enga. Report, no. 132. Australia: Water Research Laboratory, University of New South Wales, 1973.
35. Filtres à sable lents et aération intermittante à Bujumbura. Burundi, 1975.
36. Frankel, R. J. Evaluation of Effectiveness of Community Water Supply in Northeast Thailand. Bangkok: Asian Institute of Technology, 1973.
37. \_\_\_\_\_. Evaluation of Low Cost Water Filters in Rural Communities of the Lower Mekong Basin. Bangkok: Asian Institute of Technology, 1974.
38. Frink, D. W., and Fannon, Jr., R. D. "The Development of a Water Pump for Underdeveloped Countries." Final report to Agency for International Development. Batelle Memorial Institute, Columbus Laboratories, 505 King Avenue, Columbus, Ohio 43201: Sept. 29, 1967.

39. Gibson, U. P., and Singer, R. D. Small Wells Manual. Washington, D.C.: U.S. Department of State, Agency for International Development.
40. Grover, B. Harvesting Precipitation for Community Water Supplies. International Bank for Reconstruction and Development, 1971.
41. Hackett, O. M., and Davis, G. H. "Water Data for Progress." Proceedings of a Water Supply and Sanitation Seminar Held in Bangkok, Thailand, 19-23 Jan. 1970. Asian Institute of Technology.
42. Hintz, D. M. "Packaged Water Treatment Plants for Small Communities, Industries, Institutions and Camps." Proceedings of a Water Supply and Sanitation Seminar Held in Bangkok, Thailand, 19-23 Jan. 1970. Edited by Pescod and Okun. Asian Institute of Technology.
43. Huisman, L. "Artificial Groundwater Recharge." Delft University of Technology, Department of Civil Engineering, Division of Sanitary Engineering, 1975.
44. \_\_\_\_\_. "Sedimentation and Flotation, Mechanical Filtration." Delft University of Technology, Department of Civil Engineering, Division of Sanitary Engineering, 1973.
45. Huisman, L. "Rapid Filtration." Delft University of Technology, Department of Civil Engineering, Division of Sanitary Engineering, 1974.
46. Huisman, L., and Wood, W. E. Slow Sand Filtration. Geneva: World Health Organization, 1974.
47. Idelovitch, E. "The Technological Frontier: A State-of-the-Art Review." Lausanne Seminar, working paper, no. 6. May 1973.
48. International Bank for Reconstruction and Development. Public Utilities Department Documents Series: Index. Feb. 1975.
49. Ionides, M. "Water in Dry Places." Engineering 27 (October 1967): 662-666.
50. Jahn, S. A. A. Sudanese Native Methods for the Purification of Nile Water during the Flood Season with Clay Soil and Plant Material. Sudan, University of Khartoum.
51. Jain, J. S., Shaikj, S. G., and Dhabadgaonkar, S. M. "Studies on Solar Still for Production of Water for Small Communities in Arid Zones." Proceedings of a Symposium on Community Water Supply and Waste Disposal, Dec. 19-21, 1966. Nagpur, India: Central Public Health Engineering Research Institute, pp. 146-154.
52. Jaksirinont, N. Development of a Series Filtration Water Treatment Method for Small Communities of Asia. Thesis no. 509. Bangkok, Thailand, Asian Institute of Technology.

53. Kreysler, J. "Total Coli Counts: A Method to Determine Biological Contamination of Rural Water Supplies: The Ismani Example." Workshop, Dar es Salaam, 17-19 Dec. 1969.
54. Lawand, T. A., and Alward, R. "An Analysis of Cost and Production Factors in Operating Solar Stills." Brace Research Institute Report, no. R.55. Proceedings of the Third National Symposium on Fresh Water from the Sea, Dubrovnik, Yugoslavia, 13-17 Sept. 1970. Vol. I.
55. Lloyd, R. D. C. "Some Practical Problems with Water Treatment in a Technical Age." Proceedings of a Water Supply and Sanitation Seminar Held in Bangkok, Thailand, 19-23 Jan. 1970. Asian Institute of Technology.
56. Maddocks, D. Methods of Creating Low Cost Waterproof Membranes for Use in the Construction of Rainwater Catchment and Storage. Intermediate Technology Development Group, Feb. 1975.
57. Mann, H. T., and Williamson, D. Water Treatment and Sanitation: A Handbook of Simple Methods for Rural Areas in Developing Countries. Intermediate Technology Development Group, June 1973.
58. Marais, G. V. R., and McJunkin, F. E. "A Proportional Chemical Feeder for Small Water Purification Plants." Water Supply and Sanitation in Developing Countries. Aid-UNC/IPSED Series, no. 5. University of North Carolina, Oct. 1966.
59. \_\_\_\_\_. "Bottle Hypochlorite Solution Feeder." Water Supply and Sanitation in Developing Countries. Aid-UNC/IPSED Series, item 10. University of North Carolina, Oct. 1966.
60. \_\_\_\_\_. "Floating Platform Hypochlorite Solution Feeder," "V-Notch Constant Head Solution Feeder," "Floating Bowl Hypochlorite Solution Feeder." Water Supply and Sanitation in Developing Countries. Aid-UNC/IPSED Series, nos. 7, 8, and 9. University of North Carolina, Oct. 1966.
61. \_\_\_\_\_. "Float Valve Hypochlorite Solution Feeder." Water Supply and Sanitation in Developing Countries. Aid-UNC/IPSED Series, no. 4. University of North Carolina, Oct. 1966.
62. \_\_\_\_\_. "Individual Household Disinfection and Filter Unit for Turbid Waters." Water Supply and Sanitation in Developing Countries. Aid-UNC/IPSED Series, item no. 6. University of North Carolina, Oct. 1966.
63. \_\_\_\_\_. "Water Supply Using Bamboo Pipes." Water Supply and Sanitation in Developing Countries. Aid-UNC/IPSED Series, item no. 3. University of North Carolina, Oct. 1966.
64. McJunkin, F. E., and Pineo, C. S. Role of Plastic Pipe in Community Water Supplies in Developing Countries. Contract Aid/csd--888. 1969.



65. Miller, D. G. "Solid Contact Reactors." Proceedings of a Symposium on New Methods of Treatment of Water, Asuncion, Paraguay, 14-18 Aug. 1972.
66. Monkhouse, R. A. The Use and Design of Sand Screens and Filter Packs for Abstraction Wells. Water Services, May 1974.
67. Morfitt, R. P., et al. "A Non-Conventional Mass Approach to Rural Village Water Projects." A report to the Pan-American Health Organization, Corvallis, Oregon, 1969.
68. Mostertman, L. J. "Water Quality." United Nations Environmental Program paper.
69. National Academy of Sciences. More Water for Arid Lands. Washington, D.C., 1974.
70. National Environmental Engineering Research Institute, Nagpur, India. "Defluoridation of Water by Nalgonda Technique." Technical Digest 46 (October, 1974).
71. National Institute of Agricultural Engineering. Simple Waterpump. Tropical Agricultural Engineering Information Bulletin no. 1. Silsoe Bedfordshire, England: Overseas Liaison Department.
72. Nyerges, N. V., and Ganrales, E. R. Planta movil experimental de tratamiento de agua (Experimental Mobil Water Treatment Plant). Caracas, Venezuela, 1966.
73. O'Meara, J. W. "Feasibility of Desalination for Water Supply." Proceedings of a Water Supply and Sanitation Seminar Held in Bangkok, Thailand, 19-23 Jan. 1970. Edited by Pescod and Okun. Asian Institute of Technology.
74. Ontario Water Resources Commission, Training and Licensing Branch. Basic Gas Chlorination Workshop Manual.
75. Organización Panamericana de la Salud. Manual de operación y mantenimiento de instalaciones y equipos de un acueducto (Manual on Operation and Maintenance of Installations and Equipment of a Water Supply). Série Técnica del Departamento de Ingeniería y Ciencias del Ambiente, ES.7. 1970.
76. \_\_\_\_\_. Manual de referencia, medidores de agua domiciliar (Reference Book on Domestic Water Meters). Lima: Inter-American Development Bank, 1972.
77. Oza, P. P., Srizamulu, N., and Chandhury, M. "Preliminary Investigations on the Use of Coal for Removing Viruses from Water." Proceedings of a Symposium on Environmental Pollution. Nagpur: Central Public Health Engineering Research Institute, 1973.

78. Paichayon, Shonvanavirakul. Demand for Potable Water in Small Communities of Thailand. Thesis no. 341. Bangkok: Asian Institute of Technology.
79. Paramasivam, R., Gadkari, S. K., Deshpande, A. K., and Joshi, N. S. Some Performance Observations on an Upflow Filter. India, National Environmental Engineering Research Institute.
80. Raghu, V. "Cement Joint for Cast-Iron Water Pipe." Proceedings of a Symposium on Community Water Supply and Waste Disposal, Dec. 19-21, 1966. Nagpur, India: Central Public Health Engineering Research Institute, pp. 177-184.
81. Rama Mohano Rao, N. V. and Subba Rao, K. U. "Endemic Fluorosis in Andhra Pradesh." Proceedings of a Symposium on Community Water Supply and Waste Disposal, Dec. 19-21, 1966. Nagpur, India: Central Public Health Engineering Research Institute.
82. Ramaswamy, J. N. "Screen Wells Improve the Yield of Community Water Supplies." Proceedings of a Symposium on Community Water Supply and Waste Disposal, Dec. 19-21, 1966. Nagpur, India: Central Public Health Engineering Research Institute, pp. 58-64.
83. Riel, J. van. L'eau en milieu rural Centre-Africain. 1964.
84. Robeck, G. G. "Modern Concepts in Water Filtration." Proceedings of a Symposium on New Methods of Treatment of Water, Asuncion, Paraguay, 14-18 Aug. 1972.
85. Sevilla, A. S. A Study of Filtration Methods for Providing Inexpensive Potable Water to Small Communities in Asia. Thesis no. 442. Bangkok, Asian Institute of Technology.
86. Singley, J. E. "Experiences with the Magnesium Carbonate Coagulation Process in North America." Proceedings of a Symposium on New Methods of Treatment of Water, Asuncion, Paraguay, 14-18 Aug. 1972.
87. \_\_\_\_\_. "State of the Art of Coagulation." Proceedings of a Symposium on New Methods of Water Treatment, Asuncion, Paraguay, 14-18 Aug. 1972.
88. Talib, et al. The Pahang Continuous Chlorinator (Coconut Type). Dicitak dan diterbitkan oleh kementerian kesihatan malaysia kk pu/104/10/72.
89. Taylor, F. B. Hygienic and Technical Guidelines for Water Supply and Wastewater Systems in Buildings. WHO Technical Report. 1975.
90. Tschannerl, G. Water Supply: Proceedings of the Conference on Rural Water Supply in East Africa, 5-18 April 1971. Bralup Research Paper, 10. University of Dar es Salaam.

91. Turpie, R. M. "Laying Small Diameter PVC Pipes." Paper to the Institute of Civil Engineers, 1972.
92. Unakul, S. "Thailand's Rural Community Water Supply Program." Proceedings of a Water Supply and Sanitation Seminar Held in Bangkok, Thailand, 19-23 Jan. 1970. Asian Institute of Technology.
93. United Nations. Water Desalination in Developing Countries. 1964.
94. \_\_\_\_\_. Water Legislation in Asia and the Far East. Water Resources Series, no. 31. 1967.
95. \_\_\_\_\_. Water Legislation in Asia and the Far East. Water Resources Series, no. 35. 1968.
96. United Nations Children's Fund. Rural Water Supply and Sanitation in the Developing Countries. UNICEF Guidelist OLGA, OSU 6400, May 1975.
97. \_\_\_\_\_. The Persson Pump: A New Construction. WS/217/75, 5.1.3.1.1.1.4. 29 July 1975.
98. United Nations, Department of Economic and Social Affairs. Solar Distillation as a Means of Meeting Small-Scale Water Demands. ST/ECA/121. New York, 1970.
99. United States and Canada. Annotated Bibliography on Hydrology and Sedimentation, 1963-1965. Joint Hydrology-Sedimentation Bulletin, no. 9. June 1969.
100. \_\_\_\_\_. Annotated Bibliography on Hydrology and Sedimentation, 1966-1968. Joint Hydrology-Sedimentation Bulletin, no. 10. July 1970.
101. U.S., Department of Agriculture, and the National Science Foundation. Sedimentation: Annotated Bibliography of Foreign Literature, 1968-1969. Survey no. 6. Washington D.C.: Israel Program for Scientific Translations.
102. U.S., Environmental Protection Agency. Water Quality Criteria. Washington, D.C., 1972.
103. U.S.S.R., Ministry of Health. Maximum Permissible Concentrations of Harmful Substances in the Water of Water Sources Used for Hygienic and Domestic Purposes. WHO, 1971.
104. Vaillant, J. R., and Loussouarn, J. L. Le choix des matériaux pour les conduites d'adduction et de distribution d'eau (The Choice of Materials for Conduits for Supply and Distribution of Water). Secrétariat d'Etat aux Affaires Etrangères, 1970.
105. Volunteers for International Technical Assistance (VITA). Village Technology Handbook.

106. Wagner, E. G., and Lanoix, J. N. Water Supply for Rural Areas and Small Communities. Monograph Series, no. 42. Geneva: WHO, 1959.
107. Water Research Association. World Health Organization-Assisted CIPHERI Course on Preventive Maintenance of Water Distribution Systems. WHO Project no. India 017603. Medmenham, Marlow, Buckinghamshire, England and Bombay, Sept. 1972.
108. Watt, S. B. A Manual on the Hydraulic Ram for Pumping Water. Silsoe, Bedford, U.K.: Intermediate Technology Development Group, Water Development Unit, National College of Agricultural Engineering.
109. White, A. U., and Seviour C. Rural Water Supply and Sanitation in Less Developed Countries. Ottawa, Canada: International Development Research Centre, 1974.
110. White, G. F., Bradley, D. J., and White, A. U. Drawers of Water: Domestic Water Use in East Africa. Chicago: University of Chicago Press, 1972.
111. Wignot, R. E. A Report on the Condition of UNICEF-Assisted Demonstration Rural Water Supplies in Kenya. Nairobi, Kenya: UNICEF Regional Office, Dec. 1974.
112. World Health Organization. "Biological or Slow Sand Filters." Background paper of community water supply research and development programme, WHO/CWS/RD/70.1.
113. \_\_\_\_\_. "Ground Water Resources in Kenya." Sectorial study and national programming for community and rural water supply, sewerage and water pollution control, report no. 7. Brazzaville, 1973.
114. \_\_\_\_\_. International Standards for Drinking Water. 3rd ed. Geneva, 1971.
115. \_\_\_\_\_. Techniques for the Collection and Reporting of Data on Community Water Supply. Technical Report Series, 490.
116. \_\_\_\_\_. The Village Tank as a Source of Drinking Water: An Outline for a Coordinated Research and Development Project. WHO/CWS/RD/69.1.
117. \_\_\_\_\_. World Health Organization Publications: Catalogue 1947-1973.
118. World Health Organization, International Reference Centre for Community Water Supply. Health Aspects Relating to the Use of PVC Pipes for Community Water Supply. Technical Paper, no. 4. The Hague, July 1973.

119. \_\_\_\_\_. Plastic Pipe in Drinking Water Distribution Practice. Technical Paper, no. 1. The Hague, June 1971.
120. \_\_\_\_\_. The Purification of Water on a Small Scale. Technical Paper, no. 3. The Hague, March 1973.
121. World Health Organization, Regional Office for Southeast Asia. Report on Rural Water Supply Nepal. EH/SEARO/74.8. 26 July 1974.
122. Wulff, H. E. "The Qanats of Iran." Scientific American 218, no. 4 (April 1968):94-105.
123. Yao, K. M. "High Rate Settlers." Proceedings of a Symposium on New Methods of Water Treatment, Asuncion, Paraguay, 14-18 Aug. 1972.
124. Yung, D. G. Rural Water Supply in Taiwan. Taiwan Institute of Environmental Sanitation, P.H.A., 20 Dec. 1957.
125. Zdravkov, M. New Method of Chlorinating Drinking Water. WHO/Env. San/124, 25 Nov. 1959.
126. Zoeteman, B. C. J. The Suitability of Iodine and Iodine Compounds as Disinfectants for Small Water Supplies. WHO International Reference Centre For Community Water Supply, Technical Paper, no. 2. The Hague, July 1972.

VII. 3. SMALL WELLS, SLOW SAND FILTRATION,  
AND RAPID SAND FILTRATION FOR WATER SUPPLIES  
IN DEVELOPING AREAS

1. American Society of Civil Engineers, American Water Works Association, and Conference of State Sanitary Engineers. Water Treatment Plant Design. 1969.
2. American Water Works Association. Water Quality and Treatment. 3rd ed. New York, 1967.
3. Babbitt, H. E.; Doland, J. J.; and Cleasby, J. L. Water Supply Engineering. 6th ed. New York: McGraw-Hill, 1967.
4. Camp, T. R. "Flocculation and Flocculation Basins." Transactions of the American Society of Civil Engineers 120(1955).
5. Chow, V. T., ed. Handbook of Applied Hydrology. McGraw-Hill, 1964.
6. Clark, J. W.; Viessman, W., Jr.; and Hammer, M. J. Water Supply and Pollution Control. New York: IEP--A Dun-Donnelley Publisher, 1977.
7. Fair, G. M.; Geyer, J. C.; and Okun, D. A. Elements of Water Supply and Wastewater Disposal. New York: John Wiley & Sons, 1971.

8. Feachem, R.; McGarry, M.; and Mara, D., eds. Water, Wastes and Health in Hot Climates. New York: John Wiley & Sons, 1977.
9. Gibson, V. P., and Singer, R. D. Small Wells Manual. Washington, D.C.: U.S. Agency for International Development, 1969.
10. Hoover, C. P. Water Supply and Treatment. National Lime Association.
11. Huisman, L., and Wood, W. E. Slow Sand Filtration. Geneva: World Health Organization, 1974.
12. Johnson Division, Universal Oil Products Co. Groundwater and Wells. Saint Paul, Minnesota, 1972.
13. Water Supply for Rural Areas and Small Communities. WHO Monograph Series, no. 42. 1959.

#### CHAPTER VIII. WASTEWATER DISPOSAL AND TREATMENT

##### VIII. 1. SEWAGE TREATMENT IN DEVELOPING COUNTRIES, "Stabilization Ponds"

1. Amin, P. M., and Ganapati, S. V. "Biochemical Changes in Oxidation Ponds," Journal Water Pollution Control Federation 44 (February 1972):183-200.
2. Barsom, George. Lagoon Performance and the State of Lagoon Technology. Washington, D.C.: Report No. EPA-R2-73-144, U.S. Environmental Protection Agency, 1973.
3. Barth, Edwin F. "Measurement and Forms of Nitrogen and Phosphorus." Advanced Waste Treatment and Water Reuse Symposium, Dallas, Texas, January 12-14, 1971.
4. Blattler, Paul X. Haile Selassie I University Sewage Treatment Plant. Report to the Agency for International Development, United States Mission in Ethiopia, April 15, 1964. Washington, D.C.: Associated Engineers, Inc., 1964.
5. Calaway, W. T. "The Metazoa of the Waste Treatment Processes--Rotifers." Journal Water Pollution Control Federation, Research Supplement, 40 (November 1968):R412-R422.
6. Caldwell, D. H. "Sewage Oxidation Ponds:Performance, Operation and Design." Sewage Works Journal 18 (May 1956):433.
7. Callaway, T., and Wagner, B. Sewage Lagoons for Developing Countries. Ideas and Methods Exchange No. 62. Washington D.C. Department of Housing and Urban Development, 1966.

8. Canter, Larry W. "Waste Stabilization Pond Performance and Effectiveness in the Removal of Pathogenic Organisms." Final Report to the International Center for Medical Research and Training, Tulane University, New Orleans, November 1969.
9. Canter, L.; Englande, A.; and Mauldin, A. "Loading Rates on Waste Stabilization Ponds." Paper presented at the ASCE National Meeting on Water Resources Engineering, New Orleans, Louisiana, February 3-7, 1969.
10. Carpenter, Philip L. Microbiologia. Trad. por J. Benglio. Mexico: Editorial Interamericana, 1969.
11. Childers, Williams, and Bennett, George. "Experimental Vegetation Control by Large Mouth Bass-Tilapia Combinations." Journal of Wildlife Management 31 (July 1967):401-407.
12. Cubillos, Armando. "Lagunas de Establizacion, Su Eficiencia en la Remocion de Materia Organica y Microorganismos en las Condiciones del Tropico." Informe Final, Universidad del Valle, Cali, Colombia, Julio 1970.
13. Dave, J. M., and Jain, J. S. "Status of Stabilization Ponds in Sewage Treatment." Environmental Health 8 (March 1963): 228-249.
14. Davidson, F. F. "Antibacterial Activity of Oscillatoria Formosa Body Extract." Water and Sewage Works (November 1961).
15. DeNoyelles, Frank. "Factors Affecting Phytoplankton Distribution in a Double-Cell Sewage Lagoon." Journal of Phycology 3 (1967):174-181.
16. Diaz, Juan H. "A Study of the Design, Operation, and Performance of Waste Stabilization Ponds in Tropical Environments." Master thesis, University of Oklahoma, 1975.
17. Duffer, William R. "Lagoon Effluent Solids Control by Biological Harvesting." Symposium on Upgrading Wastewater Stabilization Ponds to Meet New Discharge Standards. Logan, Utah, August 21-23, 1974.
18. Duttweiler, D., and Burgh, J. "Lagoons for Military Sewage Treatment in South Vietnam." Civil Engineering-ASCE (May 1969):47-49.
19. Eckley, Louis E.; Canter, Larry; and Reid, George. Operation of Stabilization Ponds in a Tropical Area. Final Report, U.S. Army Medical Research and Development Command. Washington, D.C.: October 1974.

20. Fisher, C. P.; Drynan, W.; and Van Fleet, G. "Waste Stabilization Pond Practices in Canada." In Advances in Water Quality Improvement. Edited by E. Gloyna and W. Eckenfelder. Austin: University of Texas Press, 1968.
21. Fitzgerald, George, and Rohlich, Gerald. "An Evaluation of Stabilization Pond Literature." Sewage and Industrial Wastes 30 (October 1958):1213-1224.
22. Gann, J. D.; Collier, R. E.; and Lawrence, C. H. "Aerobic Bacteriology of Waste Stabilization Ponds." Journal Water Pollution Control Federation 40 (February 1968):185-191.
23. Gloyna, Earnest F. "Basis of Waste Stabilization Pond Designs." In Advances in Water Quality Improvement. Edited by E. Gloyna and W. Eckenfelder. Austin: University of Texas Press, 1968.
24. Gloyna, E. F. Waste Stabilization Pond Concepts and Experiences. WHO/Wastes Disposal/1.65. Geneva, Switzerland: World Health Organization, 1965.
25. Gloyna, Earnest F. Waste Stabilization Ponds. World Health Organization Monograph Series No. 60. Geneva, Switzerland, 1971.
26. Hodgson, H. T. "Stabilization Ponds for a Small African Urban Area." Journal Water Pollution Control Federation 36 (January 1964):51-67.
27. Jayangoudar, I.; Kothandaraman, V.; Thergaonkar, V.; and Shaik, S. "Rational Process Design Standards for Aerobic Oxidation Ponds in Ahmedabad, India." Journal Water Pollution Control Federation 42 (August 1970):1501-1514.
28. Jordao, E. Letter to J. F. Malina from Rio de Janeiro, Brazil.
29. Jourdan, R. P. "Bacteriology of Waste Stabilization Ponds." Unpublished Master's Thesis, Tulane University, 1969.
30. Kimmerle, Richard, and Enns, W. R. "Aquatic Insects Associated with Midwestern Waste Stabilization Lagoons." Journal Water Pollution Control Federation, Research Supplement 40 (February 1968):R31-R41.
31. Longley, Karl E.; Young, Martin; and Ashmore, Lee. Operation of Stabilization Ponds in a Tropical Area. Annual Report, U.S. Army Medical Research and Development Command. Washington, D.C., August 1970.
32. Low Cost Waste Treatment. Nagpur, India: Central Public Health Engineering Research Institute, 1972.



33. Mackenthum, K. M. "Biology of Waste Stabilization Ponds." Bio-Oxidation of Industrial Waste Course Manual. Cincinnati, Ohio: Public Health Service, 1964.
34. Marais, G. v. R. "New Factors in the Design, Operation and Performance of Waste-Stabilization Ponds." Bulletin of the World Health Organization 34 (1966):737-763.
35. Marais, G. v. R. "Dynamic Behavior of Oxidation Ponds." Second International Symposium for Waste Treatment Lagoons. Kansas City, Missouri: n.p., 1970.
36. McGarry, M. G. The Treatment of Sewage and Production of Protein through the Mass Culture of Algae. Report No. 1. Bangkok: Asian Institute of Technology, 1970.
37. McGarry, M. G., and Pescod, M. B. "Stabilization Pond Design Criteria for Tropical Asia." Second International Symposium for Waste Treatment Lagoons. Kansas City, Missouri: n.p., 1970.
38. McKinney, Ross E. Microbiology for Sanitary Engineers. New York: McGraw-Hill, 1962.
39. Merz, R. C.; Zehnpfennig, R. G.; and Klima, J. R. "Chromatographic Assay of Extracellular Products of Algal Metabolism." Journal Water Pollution Control Federation 34 (February 1962):103-115.
40. Mills, D. A. "Depth and Loading Rates of Oxidation Ponds." Water and Sewage Works (September 1962):R283-R286.
41. Mitchell, Ralph. Introduction to Environmental Microbiology. New Jersey: Prentice-Hall, 1974.
42. Mortimer, C. H. and Hickling C. F. "Fertilizers in Fish Ponds." Fishery Publications 5 (1954):1-155.
43. Oswald, W. J. "Advances in Anaerobic Pond Systems Design." In Advances in Water Quality Improvement. Edited by E. F. Gloyna and W. W. Eckenfelder, Jr. Austin: Univ. of Texas Press, 1968.
44. Oswald, W. J. "Quality Management by Engineered Ponds." In Engineering Management of Water Quality. By P. H. McGauhey. New York: McGraw-Hill, 1968.
45. Oswald, W. J., and Gotaas, H. B. "Photosynthesis in Sewage Treatment." ASCE Proceedings 81 (May 1955).
46. Palmer, C. M. Algae in Water Supplies. Publication No. 657. Washington, D.C.: Government Printing Office, U.S. Public Health Services, 1962.

47. Parhad, N. M., and Rao, N. U. "Effect of pH on Survival of Escherichia Coli." Journal Water Pollution Control Federation 46 (May 1974):980-986.
48. Pavanello, R., and Mohanrao, G. "Considerations on Water Pollution Problems in Developing Countries." In Water Quality: Management and Pollution Control Problems. 6th Conference of the International Association on Water Pollution Research held in Jerusalem, June 1973. Edited by S. H. Jenkins. New York: Pergamon Press, 1973.
49. Pennak, Robert W. Fresh-Water Invertebrates of the United States. New York: The Ronald Press Company, 1953.
50. Purushothaman, Krishnier. "Field Studies on Stabilization Ponds in South India." Second International Symposium for Waste Treatment Lagoons. Kansas City, Missouri: n.p., 1970.
51. Reid, George W. "Lower Cost Methods of Water and Waste Treatment in Less Developed Countries." Norman, Oklahoma: The University of Oklahoma. First Annual Report to the Office of Health, Agency for International Development, May 31, 1974.
52. Ruttner, Franz. Limnology. 3rd ed. Toronto: University of Toronto Press, 1973.
53. Saenz, Rodolfo. "Leccion No. 5, Experiencias Efectuadas en Varios Paises: Normas Existentes." Diseno de Lagunas de Estabilizacion: Manual del Curso. Panama: Universidad de Panama, 1969.
54. Shuval, Hillel I. "Detection and Control of Enteroviruses in the Water Environment." In Development in Water Quality Research. Edited by H. I. Shuval. Michigan: Ann Arbor Science Publishers Inc., 1973.
55. Siddiqi, R. H., and Handa, B. K. "Evaluation of Some Stabilization Ponds in India." ASCE Proceedings (February 1971): 91-99.
56. Slanetz, L. W.; Bartley, Clara H.; Metcalf, T. G.; and Nesman, R. "Survival of Enteric Bacteria and Viruses in Municipal Sewage Lagoons." Second International Symposium for Waste Treatment Lagoons. Kansas City, Missouri: n.p., 1970.
57. Smallhorst, D. F.; Walton, B. N.; and Meyers, J. "Design and Application of Oxidation Ponds." Public Works (December 1953):89-90, 111-114.
58. Smallhorst, David. "History of Oxidation Ponds in the Southwest." Proceedings of a Symposium at Kansas City, Missouri. August 1-5, 1960.

59. Smith and Eiler. Cost to Consumer for Collection and Treatment of Waste Water. United States Environmental Protection Agency, July 1970.
60. Stander, G; Meiring, P.; Drews, R.; and Van Eck, H. "A Guide to Pond Systems for Wastewater Purification." In Developments in Water Quality Research. Edited by H. I. Shuval. Michigan: Ann Arbor Science Publishers Inc., 1973.
61. Svore, Jerome H. "Waste Stabilization Pond Practices in the United States." In Advances in Water Quality Improvement. Edited by E. Gloyna and W. Eckenfelder. Austin: University of Texas Press, 1968.
62. Swingle, H. S. "Comparative Evaluation of Two Tilapias as Pond Fishes in Alabama." Trans-American Fish Society 89 (1960): 142-148.
63. Talboys, Albert P. Lagunas de Estabilizacion en America Latina. Lima, Peru: CEPIS, 1971.
64. Thirumurthi, D., and Nashashibi, O. I. "A New Approach for Designing Waste Stabilization Ponds." Water and Sewage Works (November 1967):R208-R218.
65. Tschortner, U. S. "Biological Parameters for the Operation and Control of Oxidation Ponds-II." Water Research 2 (1967): 327-346.
66. Vennes, John W. "State of the Art--Oxidation Ponds." Second International Symposium for Waste Treatment Lagoons. Kansas City, Missouri: n.p., 1970.
67. Wilson, J. N. "Performance of a Sewage Stabilization Pond in a Maritime Climate." Proceeding, Fifteenth Purdue Industrial Waste Conference. 1960.
68. World Health Organization, and Government of Kenya. Selection and Design Criteria for Sewerage Projects. Report No. 9. Brazzaville: World Health Organization, May 1973.
69. Zajic, J. E. Water Pollution Disposal and Reuse. Vol. 1. New York: Marcel Dekker, Inc., 1971.

VIII. 1. SEWAGE TREATMENT  
IN DEVELOPING COUNTRIES, "Fish Production"

1. Bagnall, L. O.; Furman, T. DeS.; Hentges, J. F.; Nolan, W. J.; and Shirley, R. L. "Food and Fiber from Effluent: Grown Water Hyacinth." In Waste Water Use in the Production of Food and Fiber. Proceedings EPA 660/2-74-041, June 1974.
2. Bardock; Rither; McLamey. Aqua-Culture. John Wiley and Sons.

3. Boyd, Claude E. "Vascular Aquatic Plants for Mineral Nutrient Removal from Polluted Waters." Economic Botany 23 (January-March 1970).
4. Bryan, Frank L. "Diseases Transmitted by Foods Contaminated by Waste Water." In Waste Water Use in the Production of Food and Fiber. Proceedings EPA 660/2-74-041, June 1974.
5. Carpenter, R. LeRoy; Coleman, Mark S.; and Jarman, Ron. "Aquaculture as an Alternative Waste Water Treatment System." In Biological Control of Water Pollution. International Conference on Biological Water Quality Improvement Alternatives. Philadelphia: University of Pennsylvania, 1976, pp. 215-224.
6. Carpenter, R. LeRoy; Malone, Harold K.; Roy, Ara F.; Mitchum, Aaron L.; Beauchamp, Herbert E.; and Coleman, Mark. "The Evaluation of Microbial Pathogens in Sewage and Sewage-Grown Fish." In Waste Water Use in the Production of Food and Fiber. Proceedings EPA 660/2-74-041, June 1974.
7. Carpenter, R. LeRoy; Coleman, Mark S.; Henderson, James P.; and Chichester, H. G. "Aquaculture as a Means to Achieve Effluent Standards." In Waste Water Use in the Production of Food and Fiber. Proceedings EPA 660/2-74-041, June 1974.
8. Dinges, Ray. "The Availability of Daphnia for Water Quality Improvement and as an Animal Food Source." In Waste Water Use in the Production of Food and Fiber. Proceedings EPA 660/2-74-041, June 1974.
9. Donaszy, Erno. "Principles of Sewage Treatment Through Utilization in Fish Ponds." In Waste Water Use in the Production of Food and Fiber. Proceedings EPA 660/2-74-041, June 1974.
10. Golombek, J. M., and Schurr, Karl. "Calculated Yield of Sewage Lagoon Biomass: A Plan for Production, and Some of the Problems Inherent in Using Biomass or Lagoon Water for Production of Food and Fiber." In Waste Water in the Production of Food and Fiber. Proceedings EPA 660/2-74-041, June 1974.
11. Hopher, B. and Schroeder, G. L. "Wastewater Utilization in Integrated Aquaculture and Agriculture Systems." In Waste Water Use in the Production of Food and Fiber. Proceedings EPA 660/2-74-041, June 1974.
12. Hickling, C. F. Fish Culture. Foter and Faber, 1962.
13. Hileman, L. H. "Mineral Quality of Fish Pond Effluent Related to Soil Properties and Crop Production." In Waste Water Use in the Production of Food and Fiber. Proceedings EPA 660/2-74-041, June 1974.

14. Odum, H. T. Environment, Power and Society. John Wiley and Sons, 1971.
15. Spear, Michael R. "Algae Removal in Oxidation Ponds Utilizing Black Bigmouth Buffalo Fish under Wintertime Conditions." Class paper, University of Oklahoma, Norman, Oklahoma, May 1974.
16. Walker, William R. and Cox, William E. "Legal Constraints on the Use of Wastewater for Food and Fiber." In Waste Water in the Production of Food and Fiber. Proceedings EPA 660/2-74-041, June 1974.

#### VIII. 2. AERATED LAGOONS

1. Arceivala, S. J.; Alagarsamy, S. R.; and Lakshminarayana, J. S. S. "Design and Construction of Aerated Lagoons in India." Proceedings of a Symposium on Low Cost Waste Treatment. Nagpur, India: Central Public Health Engineering Research Institute, October 1969.
2. Clark, John W.; Viessman, Jr., Warren; and Hammer, Mark J. Water Supply and Pollution Control. New York: IEP--A Dun-Donnelley Publisher, 1977.
3. Feachem, R.; McGarry, M.; and Mara, D., eds. Water, Wastes and Health in Hot Climates. New York: John Wiley & Sons, 1977.
4. Metcalf & Eddy. Wastewater Engineering: Collection, Treatment, Disposal. New York: McGraw-Hill, 1972.
5. Parker, H. W. Wastewater Systems Engineering. New Jersey: Prentice-Hall, 1975.
6. Subba Rao, S. "Design and Construction of Mechanically Aerated Lagoons." Proceedings of a Symposium on Low Cost Waste Treatment. Nagpur, India: Central Public Health Engineering Research Institute, October 1969.
7. Thackston, E. L., and Eckenfelder Jr., W. W., eds. Process Design in Water Quality Engineering. New York: Jenkins Publishing, 1972.

#### VIII. 3. LAND APPLICATION OF WASTEWATER

1. Alternate Waste Management Technology for Best Practicable Waste Treatment. EPA-430/9-75-013. October 1975.
2. Atkins, Water D. Design Guidelines for Land Application of Municipal Wastewater. Oklahoma State Department of Health, April 1976.

3. Clark, John W.; Viessman, Warren Jr.; and Hammer, Mark J. Water Supply and Pollution Control. 3rd ed. New York: IEP-- A Dun-Donnelley Publisher, 1977.
4. de Haan, S. "Land Application of Liquid Municipal Wastewater Sludges." Journal of the Water Pollution Control Federation (Nov. 1975):47.
5. Evaluation of Land Application Systems. Technical Bulletin (EPA-430/9-75-001). Washington, D.C.: U.S. Environmental Protection Agency, Office of Water Program Operations, March 1975.
6. Godfrey, K. A., Jr. "Land Treatment of Municipal Sewage." Civil Engineering (September 1973):103-109.
7. Bouwer, Herman; Bauer, W. J.; and Dryden, Franklin D. "Land Treatment of Wastewater in Today's Society." Civil Engineering (January 1978):78-81.
8. Johnson, R. D. "Land Treatment of Wastewater." The Military Engineer 65, no. 428(1973):375.
9. Land Treatment of Municipal Wastewater Effluents. U.S. Environmental Protection Agency, January 1946.
10. Malhotra, S. K., and Meyers, E. A. "Design, Operation and Monitoring of Municipal Irrigation Systems." Journal of the Water Pollution Control Federation (Nov. 1975):2627-2639.
11. Pound, Charles E.; Crites, Ronald W.; Griffes, Douglas A. Costs of Wastewater Treatment by Land Application. EPA-430/9-75-003. Washington, D.C.: U.S. Environmental Protection Agency, Office of Water Program Operations, June 1975.
12. Texas A & M University, Office of Educational Information Services. "Land Application Studied." Water Research in Action, 2, no. 8 (December 1977).
13. Wastewater Treatment and Reuse by Land Application. Vol. 1: Summary. Environmental Protection Technology Series (EPA-660/2-73-006a). Washington, D.C.: U.S. Environmental Protection Agency, Office of Research and Development, August 1973.

#### CHAPTER IX. ON-SITE DISPOSAL AND TREATMENT

1. Abney, Jack L. "Technical Considerations and Recommended Design Approaches." In On-Site Sewage Disposal Systems. Appalachian Environmental Demonstration Project, Dept. for National Resources and Environmental Protection. Corbin, Kentucky, June 1973.

2. Babcock and Wilcox. Barberton, Ohio.
3. Bechtel Incorporated. A Guide to the Selection of Cost-Effective Wastewater Treatment Systems. Technical Report, EPA-430/9-75-002. Washington, D.C.: U.S. Government Printing Office, 1975-680-844/238.
4. Berg, Hugo J. van den. "Sanitation for Developing Countries." World Health Organization, International Reference Center for Community Water Supply Project. November 1975.
5. Brady, Goodman, Kerri, and Reed. "Performance Indicators for Wastewater Collection Systems." Report to the Fiftieth Annual Conference, Water Pollution Control Federation, Philadelphia, Pennsylvania, October 2-7, 1977.
6. Briscoe, John. Public Health in Rural India: The Case of Excreta Disposal. Research Paper, no. 12. Ph.D. dissertation. Center for Population Studies, Harvard University, February 1976.
7. Census of Manufactures, 1972.
8. Clivus Multrum USA. Organic Waste Treatment System, 14A Eliot Street, Cambridge, Mass. 02138.
9. Committee on Technology and Social Change in Foreign Cultures. Technology and Social Change in Foreign Cultures. Ames: Iowa State University, 1973.
10. Costle, Douglas. "Encouraging Less Costly Wastewater Facilities for Small Communities." Address to National Conference on Less Costly Wastewater Treatment Systems for Small Communities, Reston, Va., April 1977.
11. Curran Associates. "A Preliminary Assessment of Wet Systems for Residential Refuse Collection: Summary Report." EPA Contract, no. 68-03-0183. March 1974.
12. Dearth, Keith H. Office of Water Programs Operations, U.S. Environmental Protection Agency. Report for a Seminar on Technology Transfers for Small Wastewater Treatment Systems, July 1977.
13. Development Centre of the Organisation for Economic Cooperation and Development. Choice and Adaptation of Technology in Developing Countries. Paris, 1974.
14. Enviroscope, Inc. Introducing Toa-Throne Aerobic Decay Toilet: A Natural Method of Waste Disposal. P. O. Box 752, Corona del Mar, Calif. 92625, 1975.

15. Global Workshop on Appropriate Water and Wastewater Treatment Technology for Developing Countries, Voorburg, the Netherlands, 17-22 November 1975. Bulletin Series, no. 7. The Hague: WHO International Reference Centre for Community Water Supply, April 1977.
16. Intermediate Technology Group, London, United Kingdom.
17. Kreissel, Jim, U.S. Environmental Protection Agency.
18. La Mere Industries. Walworth, Wisconsin 53184.
19. Leich, Harold H. Address to the American Society of Agricultural Engineers. Chicago, December 1974.
20. Mansfield Sanitary, Inc. 150 First Street Perrysville, Ohio 44864.
21. McGarry, Michael; Rybczynski, Witold; Polprasert, Chongrak. Stop the Faecal Peril: A Technology Review. IRDC Preliminary Report. Ottawa: International Development Research Centre, July 1977.
22. McJunkin, F. E. Water, Engineers, Development, and Disease in the Tropics. U.S. Agency for International Development, 1975.
23. Mechanical Engineering February 1976.
24. Metcalf and Eddy, Engineers. Land Treatment of Municipal Wastewater Effluents. 3 vols. Vol. 1: Design Factors I. Vol. 2: Design Factors II. Vol. 3: Case Histories. Technology Transfer Seminar Publication. U.S. Environmental Protection Agency, 1976.
25. Microphor. P. O. Box 490, Willits, Calif. 95490.
26. Monogram Industries, Inc. 1165 East 230th Street, Carson, Calif. 90745.
27. National Association of Public Health Enterprises and Industries. Regulations and Information Concerning Sanitation for Single Family Homes and Small Communities. 3rd ed. 1969.
28. On-site Disposal of Small Wastewater Flows. Small Scale Waste Management Project. Madison: University of Wisconsin, January 1976.
29. Recreation Ecology Conservation of the United States, Inc. 9800 West Bluemound Road, Milwaukee, Wisc. 53226.
30. Raritan Engineering Co. 1025 North High Street, Millville, N.J. 08332.
31. Reference Yearbook of Labour Statistics, 1975. Geneva: International Labour Office, 1976.



32. Reid, George W., and Discenza, Richard. Prediction Methodology for Suitable Water and Wastewater Processes. Norman: University of Oklahoma, 1975.
33. Research Products/Blankenship. 2639 Andjon, Dallas, Tex. 75220.
34. RSC Industries, Inc. 245 West 74th Place, Hialeah, Florida 33014.
35. Schliessmann, D. J., et al. "Relation of Environmental Factors to the Occurrence of Enteric Disease in Areas of Eastern Kentucky." U.S. Public Health Service Monographs, no. 54. 1958.
36. Siegrist, Robert. Segregation and Separate Treatment of Black and Grey Household Wastewaters to Facilitate On-site Surface Disposal. Madison: University of Wisconsin, November 1976.
37. Stewart, David E. Alternative Methods of Regulating On-Site Domestic Sewerage Systems. Madison, Wisconsin: National Sanitation Foundation, 1976.
38. Sylvester et al. Rest Area Wastewater Disposal Study.
39. Taggart, W. F.; Armstrong, John H.; et al. "Considerations for Designing and Improving Individual Sewage Disposal Systems." United States Department of Agriculture/Oklahoma State Department of Health Ad Hoc Committee. Oklahoma City, 1977.
40. Train, Russell, U.S. Environmental Protection Agency Administrator, to Regional Administrators.
41. U.S., Environmental Protection Agency. Technology Transfer: Choosing Optimum Management Strategies. EPA-625-77-008. May 1977.
42. U.S., Environmental Protection Agency, Construction Grants Program Information. An Analysis of Construction Cost Experience for Wastewater Treatment Plants. MCD-22, EPA-430/9-76-002. February 1976.
43. U.S., Environmental Protection Agency, Municipal Operations Branch. O & M Cost Considerations for Small Municipal Wastewater Treatment Facilities. Washington, D.C.: USEPA Office of Water Programs Operations, 1977.
44. U.S., Public Health Service, Division of Indian Health, Health Program Systems Center. Health Program Evaluation: Impact Study of the Indian Sanitation Facilities Construction Act. Tucson, Arizona, July 1968.
45. Winneberger, John H. Timothy. Manual of Grey Water Treatment Practice. Ann Arbor, Michigan: Ann Arbor Science, 1974.