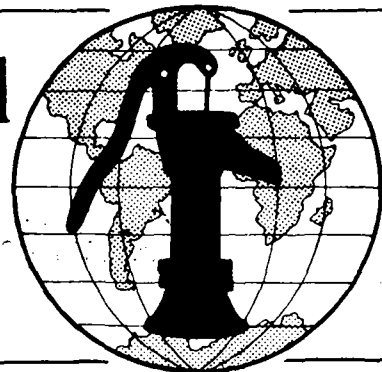


# Water for the World



## Overview of Sanitation Technical Note No. SAN. G

The technical notes on sanitation are divided into three series as shown on Table 1: SAN.1 - Simple Excreta and Washwater Disposal; SAN.2 - Combined Excreta and Washwater Disposal; and SAN.3 - Solid Waste Disposal. Within each series, the technical notes are organized according to methods (M), planning (P), design (D), construction (C), and operation and maintenance (O). All technical notes have both a title and a number within each category indicating where they fit on Table 1. For example, SAN.2.P.3, "Determining Soil Suitability," is part of the Combined Excreta and Washwater Disposal series (2), discusses planning (P), and is the third technical note (3) in the 2P series. See "Overview of Water and Sanitation System Development," HR.G, for a full discussion of the organization of the technical notes and a list of all of them. The sanitation technical notes are listed at the end of this note.

If possible, the technical notes should be read and used in order of methods, planning, design, construction, and operation and maintenance. This will give the reader a thorough understanding of the subject covered and allow him or her to proceed with the activity in an orderly manner. The methods, planning and design technical notes were written for people with some experience with sanitation systems who are responsible for project design and decision-making. The construction and operation and maintenance technical notes, in most cases, may be used by people with less experience since these activities require little or no decision-making. Thus, the construction and operation and maintenance technical notes may be used by someone who is carrying out their tasks, but is working under another person who has consulted the methods, planning and design notes for that particular project.

## Sources of Further Information

The books listed below will be useful to those interested in further reading on the subjects covered by the technical notes on sanitation.

Appropriate Sanitation Alternatives: Field Manual, 1980. The World Bank, 1818 H Street, N.W., Washington, D.C. 20433 U.S.A.

Bamboo as a Building Material, F.A. McClure, 1953. U.S. Department of Agriculture, 14th and Independence Avenues, S.W., Washington, D.C. 20250 U.S.A.

Community Wastewater Collection and Disposal, D.A. Okun and G. Ponghis, 1975. World Health Organization, Av. Appia, 1211 Geneva 27 Switzerland.

Compost, Fertilizer and Biogas Production from Human and Farm Wastes in the People's Republic of China, edited by Michael G. McGarry and Jill Stainforth, 1978. International Development Research Center, Ottawa, Canada.

Composting: Sanitary Disposal and Reclamation of Organic Wastes, Harold B. Gotaas, 1956. World Health Organization, Av. Appia, 1211 Geneva 27 Switzerland.

Excreta Disposal for Rural Areas and Small Communities. E.G. Wagner and J.N. Lanoix, 1958. World Health Organization, Av. Appia, 1211 Geneva 27 Switzerland.

Management of Solid Wastes in Developing Countries, Frank Flintoff, 1976. World Health Organization, Av. Appia, 1211 Geneva 27 Switzerland.

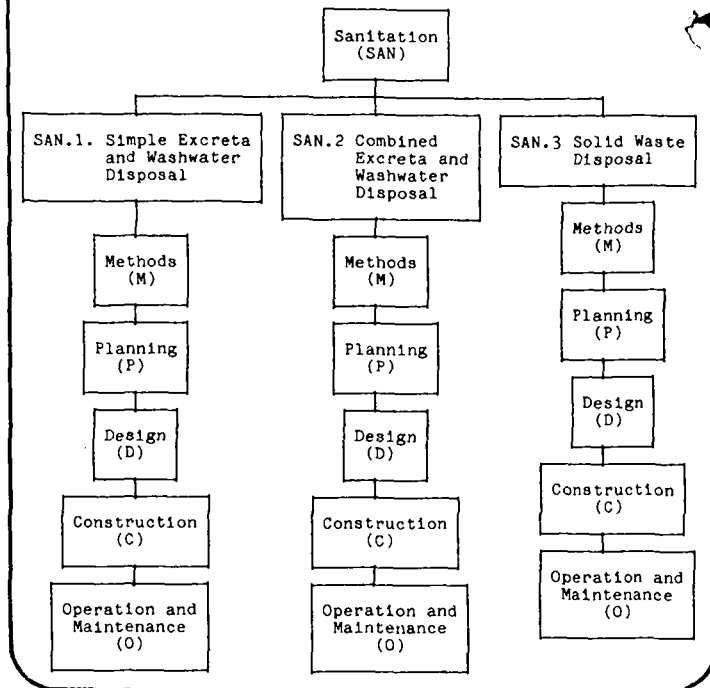
301-7289 }

Sanitation Without Water, Uno Winblad, 1980. Swedish International Development Authority, Stockholm, Sweden.

Small Excreta Disposal Systems, Richard Feachem and Sandy Cairncross, 1978. The Ross Institute of Tropical Hygiene, London School of Hygiene and Tropical Medicine, Keppel Street, Gower Street, London WC1E 7HT United Kingdom.

State of the Art Manual of On-Site Wastewater Management, 1979. National Environmental Health Association, 1200 Lincoln Street, Suite 704, Denver, Colorado 80203 U.S.A.

**Table 1. Organization of Sanitation Technical Notes**



## List of Technical Notes

The following is a list of all the technical notes on sanitation.

### SANITATION

SAN.G Overview of Sanitation

#### SAN.1 Simple Excreta and Washwater Disposal

##### Methods

SAN.1.M.1 Simple Methods of Excreta Disposal

SAN.1.M.2 Simple Methods of Washwater Disposal

##### Planning

SAN.1.P Planning Simple Excreta and Washwater Disposal Systems

##### Design

SAN.1.D.1 Designing Slabs for Privies

SAN.1.D.2 Designing Pits for Privies

SAN.1.D.3 Designing Privy Shelters

SAN.1.D.4 Designing Aqua Privies

SAN.1.D.5 Designing Bucket Latrines

SAN.1.D.6 Designing Compost Toilets

SAN.1.D.7 Designing Sumps, Soakage Pits and Trenches

## Construction

- SAN.1.C.1 Constructing Slabs for Privies
- SAN.1.C.2 Constructing Pits for Privies
- SAN.1.C.3 Constructing Privy Shelters
- SAN.1.C.4 Constructing Aqua Privies
- SAN.1.C.5 Constructing Bucket Latrines
- SAN.1.C.6 Constructing Compost Toilets
- SAN.1.C.7 Constructing, Operating, and Maintaining Sumps, Soakage Pits, and Trenches

## Operation and Maintenance

- SAN.1.O.1 Operating and Maintaining Privies
- SAN.1.O.4 Operating and Maintaining Aqua Privies
- SAN.1.O.5 Operating and Maintaining Bucket Latrines
- SAN.1.O.6 Operating and Maintaining Compost Toilets

### **SAN.2 Combined Excreta and Washwater Disposal**

## Methods

- SAN.2.M Methods of Combined Washwater and Excreta Disposal

## Planning

- SAN.2.P.1 Planning Combined Washwater and Excreta Disposal Systems
- SAN.2.P.2 Estimating Sewage or Washwater Flows
- SAN.2.P.3 Determining Soil Suitability

## Design

- SAN.2.D.1 Designing Subsurface Absorption Systems
- SAN.2.D.2 Designing Cesspools
- SAN.2.D.3 Designing Septic Tanks
- SAN.2.D.4 Designing Sewer Systems
- SAN.2.D.5 Designing Stabilization Ponds
- SAN.2.D.6 Designing a System of Stabilization Ponds
- SAN.2.D.7 Designing Mechanically Aerated Lagoons
- SAN.2.D.8 Designing Non-Conventional Absorption Disposal Systems

## Construction

- SAN.2.C.1 Constructing, Operating and Maintaining Subsurface Absorption Systems

- SAN.2.C.2 Constructing Cesspools
- SAN.2.C.3 Constructing Septic Tanks
- SAN.2.C.4 Constructing Sewer Systems
- SAN.2.C.5 Constructing Stabilization Ponds
- SAN.2.C.7 Constructing Mechanically Aerated Lagoons
- SAN.2.C.8 Constructing, Operating and Maintaining Non-Conventional Absorption Systems

Operation and Maintenance

- SAN.2.0.3 Operating and Maintaining Septic Tanks
- SAN.2.0.4 Operating and Maintaining Sewer Systems
- SAN.2.0.5 Operating and Maintaining Stabilization Ponds
- SAN.2.0.7 Operating and Maintaining Mechanically Aerated Lagoons

**SAN.3 Solid Water Disposal**

Methods

- SAN.3.M Methods of Solid Waste Management

Planning

- SAN.3.P Planning Solid Waste Management Systems

Design

- SAN.3.D.1 Designing a Landfill
- SAN.3.D.2 Designing a Composting System
- SAN.3.D.3 Designing a Solid Waste Collection System
- SAN.3.D.4 Designing a Biogas System

Construction

- SAN.3.C.4 Constructing a Biogas System

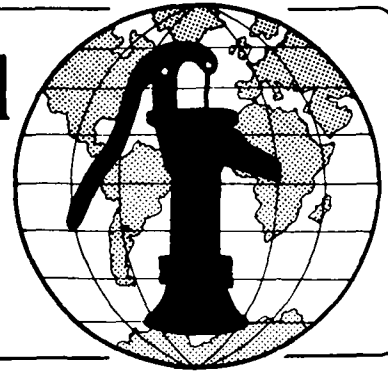
Operation and Maintenance

- SAN.3.0.1 Operating and Maintaining a Landfill
- SAN.3.0.2 Operating and Maintaining a Composting System
- SAN.3.0.3 Operating a Solid Waste Collection System
- SAN.3.0.4 Operating and Maintaining a Biogas System

**Technical Notes** are part of a set of "Water for the World" materials produced under contract to the U.S. Agency for International Development by National Demonstration Water Project, Institute for Rural Water, and National Environmental Health Association. Artwork was done by Redwing Art Service. Technical Notes are intended to provide assistance to a broad range of people with field responsibility for village water supply and sanitation projects in the developing nations. For more detail on the purpose, organization and suggestions for use of Technical Notes, see the introductory Note in the series, titled "Using 'Water for the World' Technical Notes." Other parts of the "Water for the World" series include a comprehensive Program Manual and several Policy Perspectives. Further information on these materials may be obtained from the Development Information Center, Agency for International Development, Washington, D.C., 20523, U.S.A.



# Water for the World



## Simple Methods of Excreta Disposal Technical Note No. SAN. 1.M.1

Simple methods of excreta disposal use a pit, vault, or bucket to hold the excreta. This reduces the chance of contaminating water supplies and of spreading diseases caused by poor sanitation (see "Means of Disease Transmission," DIS.1.M.1). These methods also help control the spread of disease by keeping animals and insects away from excreta. Simple methods of excreta disposal are easy to build, inexpensive, and can be made from locally available materials.

This technical note describes five simple methods of excreta disposal: pit privy, pit privy with improvements, aqua privy, compost toilet, and bucket latrine.

### Useful Definitions

**COMPOST** - A dark, fairly dry, crumbly, odorless material that is produced by sealing excreta, ashes, woodchips, straw, and vegetable waste for 6-12 months; compost can be used to fertilize crops.

**CONTAMINATE** - To make unclean by introducing an infectious (disease-causing) impurity such as bacteria from excreta.

**EXCRETA** - Human body wastes.

**PERMEABLE** - Allowing liquid to soak in.

**SLUDGE** - Solids settled from water-carried wastes.

### Pit Privy

Pit privies are probably the cheapest and easiest excreta disposal method to build and the simplest to maintain. The four main features of a pit privy are the shelter, pit, slab with hole or seat, and lid. See Figure 1.

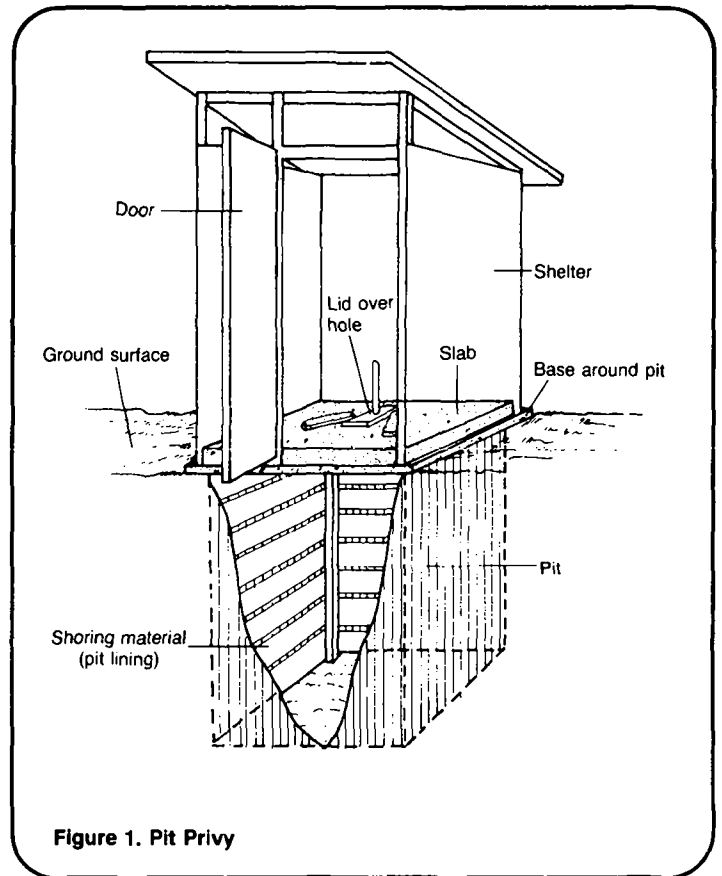


Figure 1. Pit Privy

The shelter gives the user privacy and, depending on the design, may protect the user and the privy from the weather. It should be made from local materials such as palm thatch, bamboo, wood, or bricks. It can have a screening wall or door, depending on local preference.

The pit is dug in permeable soil and holds the excreta. The bottom of the pit must be at least 1m above groundwater levels. The size of the pit will vary, depending on the number of users, the type of anal-cleaning material used, and the desired lifetime of the pit. For example, a pit that is 1m square and 1.5m deep can be used by a family of five for about six years.

The pit has a base for the slab and sometimes a lining, as well, depending on the type of soil in which it is dug. The lining shores up the sides of the pit. It is made from bamboo, boards, brick, or select field stones. The base encircles the top of the pit and supports the slab. It is made of logs, bricks, or concrete.

The slab covers the pit and has a hole near the center through which to defecate. It can have either a squatting hole or a seat and pedestal, depending on local preference. The slab can be made from bamboo, wood, or concrete.

The lid covers the hole in the slab when the privy is not in use. It is made of local material, and it should fit tightly over the hole to keep flies and other insects out of the pit.

The pit will eventually fill with excreta. When it is filled to within 0.5m below the slab, the slab and shelter are moved to a new pit and the old pit is filled with dirt.

### Privies with Improvements

Improved privies have all the features of a pit privy plus either a vent pipe, pour-flush bowl, off-set pit, or some combination of the three. Like pit privies, improved privies must be no deeper than 1m above groundwater levels, and they will eventually fill with excreta. These privies cost about one-and-a-half times as much as a pit privy.

A vent pipe is 75-150mm in diameter, usually metal painted black, and topped with a fly-proof screen and cone-shaped cover to keep out rain. See Figure 2. The purpose of the vent pipe is to remove odors from the privy. The vent pipe is installed outside the shelter, on its sunny side. The pipe's bottom end is mortared to a hole in the slab and the top end is attached to the roof of the shelter. The sun heats the pipe causing an updraft. As a result, air moves down through the squatting hole or seat, through the pit, and up the vent. The screen on the top end of the vent pipe traps flies that may get into the pit.

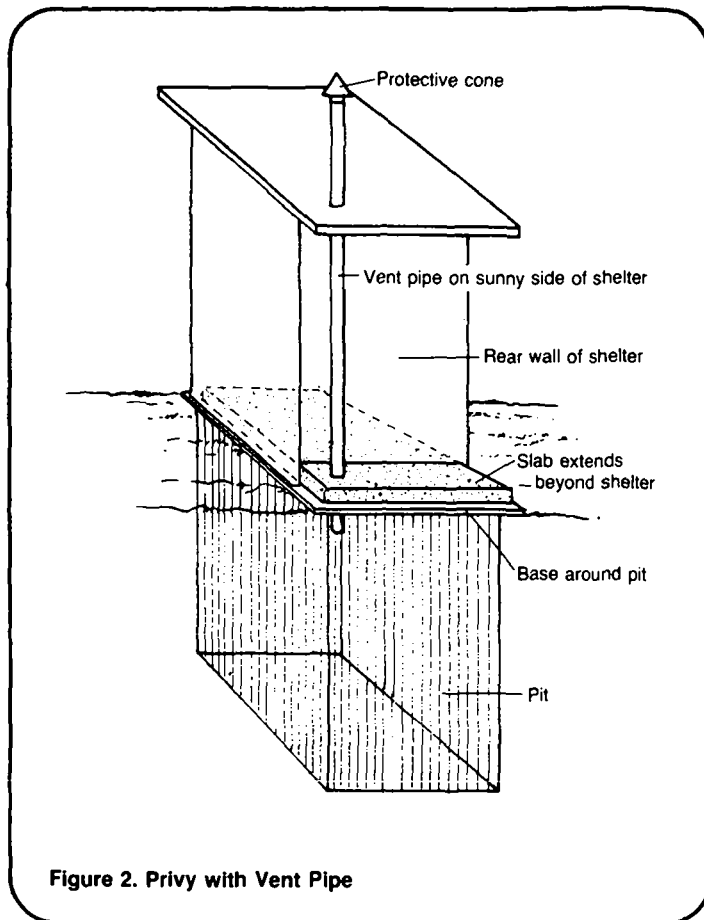


Figure 2. Privy with Vent Pipe

A pour-flush bowl is a bowl with a U-shaped pipe attached below the squatting slab or the seat and pedestal, as shown in Figure 3. After each use, 1-3 liters of water are poured into the bowl. Part of the water flushes excreta into the pit, and part forms a water seal in the bowl to prevent odors from rising from the pit into the shelter.

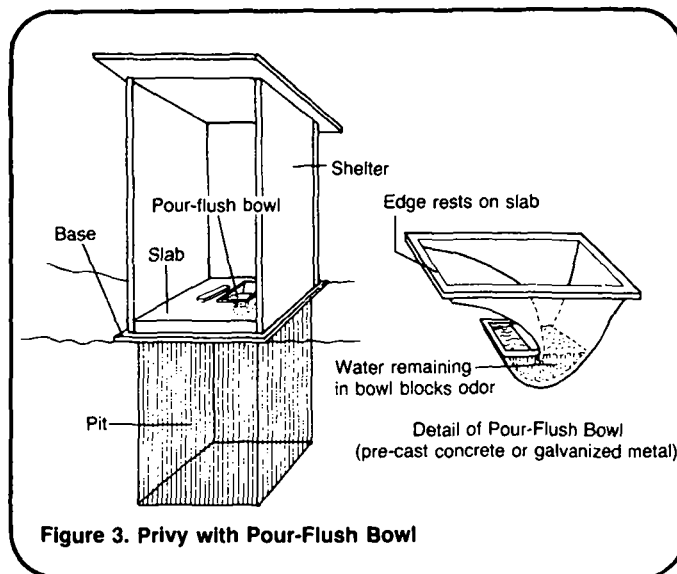


Figure 3. Privy with Pour-Flush Bowl

A pour-flush bowl requires a water source, such as a standpipe, near the privy. Washwater can also be used to operate a pour-flush bowl. Bulky anal-cleansing materials should not be used because they will clog the pipe.

An off-set pit is not directly under the slab and shelter and can be larger than a standard pit, as shown in Figure 4. Off-set pits are at least 1m wide, 1.5m long, and 3.0m deep. Because of their size, they last longer than standard pits. Another feature, which may be considered an advantage, is that the excreta in the pit cannot be seen.

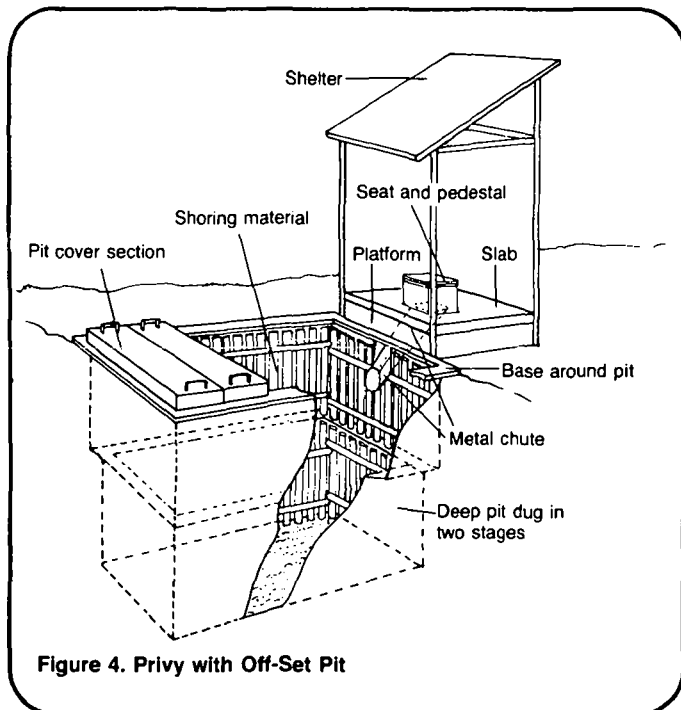


Figure 4. Privy with Off-Set Pit

An off-set pit can be fitted with a pour-flush bowl or a chute and cover. The chute, usually made of galvanized metal, carries excreta downward from the squatting hole or seat to the pit. The cover is generally made of concrete.

### Aqua Privy

An aqua privy costs about twice as much as a pit privy. Its four main features are a water-tight vault, slab, shelter, and soakaway as shown in Figure 5.

The vault is about 1m square and 1-2m deep. It is made of reinforced concrete or brick and mortar, and is

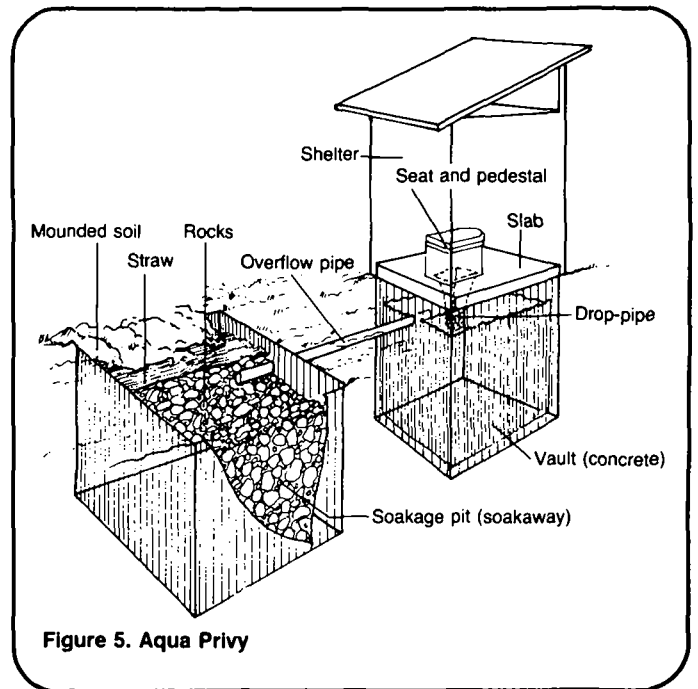


Figure 5. Aqua Privy

installed underground and filled with water. Excreta passes from a drop-pipe in the slab into the vault. The bacteria in the vault breaks down the excreta, and the solids settle to the bottom. The excess liquid flows through an overflow pipe from the vault to a soakaway.

The slab covers the vault and has a metal drop-pipe that extends from the squatting hole or seat down into the water in the vault. The water in the drop-pipe forms a seal, much like a pour-flush bowl, and prevents odors from rising into the shelter.

The shelter is the same as the shelter for a pit privy or improved privy.

The soakaway can be a soakage pit or trench (see "Simple Methods of Wash-water Disposal," SAN.1.M.2). It receives excess liquid run-off from the vault through an overflow pipe.

The water level in the vault and the water seal in the drop-pipe must be maintained or there will be severe problems with odors, flies, and mosquitoes. Enough water, possibly wash-water, must be added to the vault to replace any water that evaporates. This will vary from 1-10 liters per day.

The vault will gradually fill with sludge. The sludge must be cleaned out and buried when the vault is about two-thirds full and the vault must be re-filled with water. This will occur every two to six years.

## Compost Toilet

The compost toilet described here is the double-vault type. It costs about twice as much as a pit privy. The five main features of a compost toilet are two water-tight vaults, two slabs, and a shelter, as shown in Figure 6.

The shelter is larger than a shelter for a pit privy, because it must enclose two slabs.

The slabs are the same as for a pit privy, and may have squatting holes or seats and pedestals.

The vaults, which may really be one large vault divided in half, are made of reinforced concrete or brick and mortar. They rest above ground on a concrete or brick base and are each about 1m square and 1m high.

Only one vault is used at a time. It holds the excreta, to which is added ashes, sawdust, woodchips, or vegetable wastes. When the vault becomes two-thirds full, which takes six to 12 months, it is filled with dirt and sealed. The second vault is then used until it becomes two-thirds full. At that time, it is filled with dirt and sealed, and the first vault is opened. The contents of the first vault will have changed into compost material. The compost is removed from the first vault through the door at the back and used to fertilize crops. The first vault is now ready to use again.

## Bucket Latrine

The construction cost of a bucket latrine is about the same as a pit privy. However, operating costs can make a bucket latrine the most expensive excreta disposal method described in this technical note. The four main features of a bucket latrine are a platform, slab, shelter, and bucket, as shown in Figure 7.

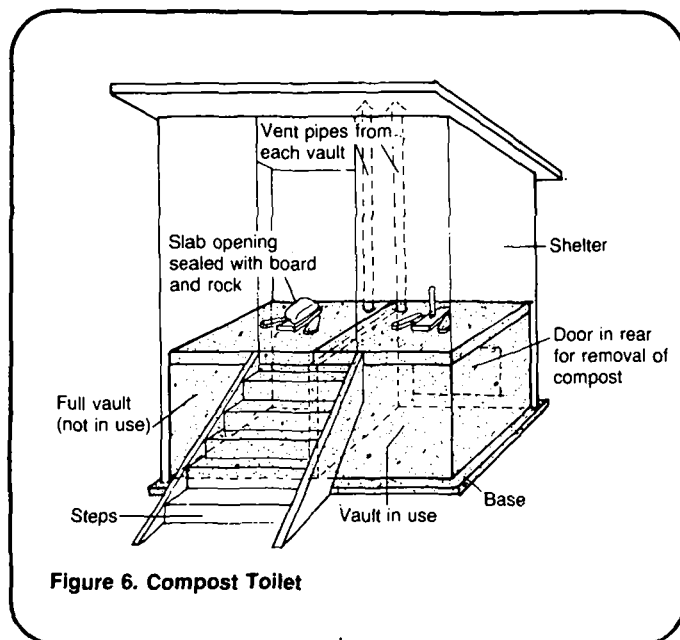


Figure 6. Compost Toilet

The platform can be made of wood, concrete, or brick and mortar. It elevates the slab and encloses the bucket.

The slab is the same as for a pit privy, and may have a squatting hole or a seat and pedestal.

The shelter is the same as for a pit privy, with the addition of a fly-proof door in the rear wall for removal of the bucket.

The bucket is made of rubber, enamel, galvanized metal, or lacquered wood. It is placed under the slab, in the compartment created by the platform.

The bucket holds excreta and must be emptied every one to three days, preferably every day. A laborer replaces the bucket with a clean one, empties the excreta into a larger container, and takes it to a trenching ground where the excreta is buried. Water must be available at the trenching ground so the laborer can wash the containers and buckets. It is also possible to compost the excreta.

This method of excreta disposal can be unpleasant and unsanitary. There is a risk of spreading disease because the excreta and excreta containers must be handled continually. This method also can be quite expensive because

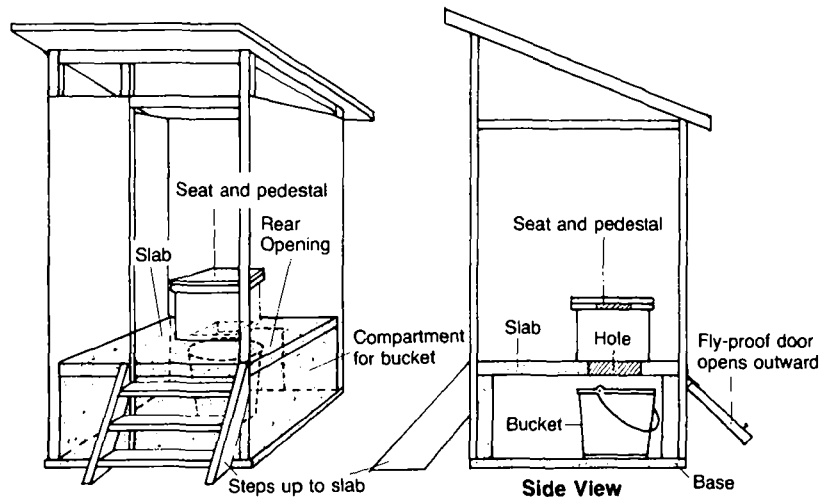


Figure 7. Bucket Latrine

workers must be paid to empty the buckets and bury the excreta. In some regions, however, the excreta is composted successfully with no odor, flies or disease. It is then used to fertilize crops. In most circumstances bucket latrines should probably only be used where there is a dense population on rocky ground or as a temporary solution to an emergency situation. Existing bucket latrines should be replaced with other, more sanitary means of excreta disposal as soon as possible.

### Comparison of Methods

Table 1 summarizes each of the five simple methods of excreta disposal. The methods are listed across the top of the chart, and the factors to be compared are listed down the left side. The table can be used as an aid in selecting a method (see "Planning Simple Systems of Excreta and Washwater Disposal," SAN.1.P).

Table 1. Comparison of Simple Methods of Excreta Disposal

Factor	Disposal Method				
	Pit Privy	Pit Privy with Improvements	Aqua Privy	Compost Toilet	Bucket Latrine
Cost	None	1½ times pit privy	2 times pit privy	2 times pit privy	No construction cost but operation may be costly depending on community
Design Features	Pit; slab (squat or seat); lid; shelter	Same as pit privy plus either pour-flush bowl, vent pipe, off-set pit, or combination	Vault; slab (squat or seat); shelter; soakaway	Double vault; two slabs (squat or seat); shelter	Platform; slab (squat or seat); bucket; shelter; large containers' cart
Construction Skills	Minimal	Minimal	Some masonry	Some masonry	Minimal
Slab Material	Bamboo, wood, or concrete	Bamboo, wood, concrete, ceramic, or plastic	Concrete	Concrete	Bamboo, wood, or concrete
Water Requirement	No	No, except for pour-flush	Yes	No	No for operation, but yes for washing at trenching ground
Handling of Wastes	None	None	Every 2-6 years as sludge	Every 6-12 months as compost	Every 1-3 days as excreta
Maintenance	Clean slab weekly; dig new pit and move slab and shelter every 4-6 years	Same as pit privy; if off-set pit, clean chute weekly and dig new pit every 10 or more years	Maintain water level in vault; clean slab weekly; remove sludge and refill with water every 2-6 years	Clean slab weekly; alternate use of vaults every 6-12 months by removing compost, cleaning one vault, sealing the other	Clean slab weekly; remove excreta every 1-3 days; clean buckets every 1-3 days; cart excreta to trenching ground and bury it or to composting area

## Notes

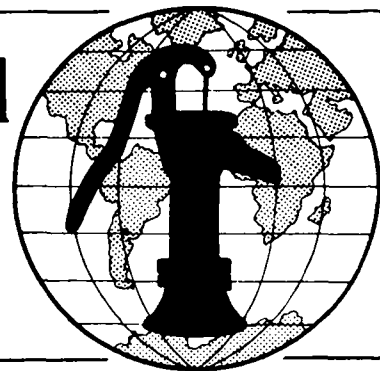
## Notes

## Notes

**Technical Notes** are part of a set of "Water for the World" materials produced under contract to the U.S. Agency for International Development by National Demonstration Water Project, Institute for Rural Water, and National Environmental Health Association. Artwork was done by Redwing Art Service. Technical Notes are intended to provide assistance to a broad range of people with field responsibility for village water supply and sanitation projects in the developing nations. For more detail on the purpose, organization and suggestions for use of Technical Notes, see the introductory Note in the series, titled "Using 'Water for the World' Technical Notes." Other parts of the "Water for the World" series include a comprehensive Program Manual and several Policy Perspectives. Further information on these materials may be obtained from the Development Information Center, Agency for International Development, Washington, D.C., 20523, U.S.A.



# Water for the World



## Simple Methods of Washwater Disposal

Technical Note No. SAN. 1.M.2

Some method of washwater disposal is important wherever water is used inside or near a dwelling for bathing, washing, or cooking. Simple disposal methods confine washwater to a sump, pit, or trench and allow it to soak safely into the ground. This reduces the chance of contaminating water supplies and prevents mosquitoes from breeding by eliminating surface pools. All of these methods are inexpensive, easy to build, and can be made from locally available materials.

This technical note describes three simple methods of washwater disposal: sump, soakage pit, and soakage trench.

### Useful Definitions

**CONTAMINATE** - To make unclean by introducing an infectious (disease-causing) impurity such as bacteria from washwater.

**PERMEABLE** - Allowing liquid to soak in.

**WASHWATER** - Water that has been used for bathing or washing clothes, dishes or kitchen utensils.

### Sump

There are two types of sump: pit and drum. The pit-type, shown in Figure 1, is a hole 0.5-1m deep dug in permeable soil, lined with concrete blocks, bricks or stones, and covered with a lid to keep out flies and mosquitoes and to prevent children from falling in. The bottom of the sump is covered with 50-100mm of gravel or crushed rock.

The drum-type sump shown in Figure 2 uses a 200-liter steel drum with holes punched in the sides and bottom. A hole large enough to hold the drum is dug in permeable soil, and the drum is lowered into it and covered with a lid.

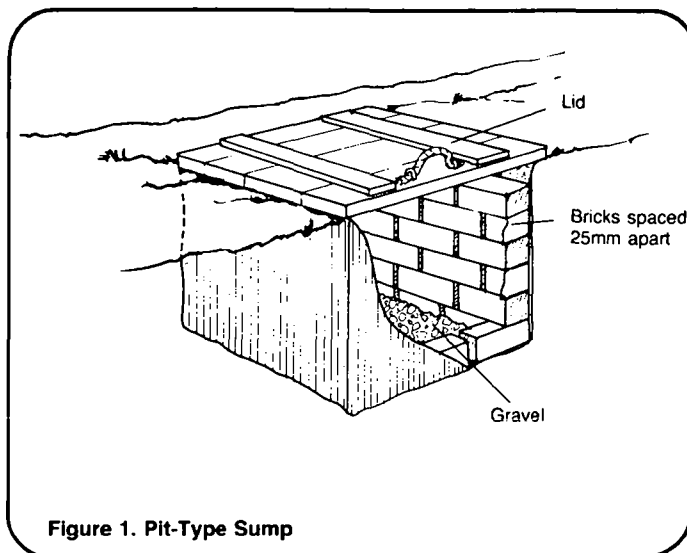


Figure 1. Pit-Type Sump

Washwater is poured directly into a sump and gradually soaks into the ground. Sumps are to be used only where there are 5 liters or less of washwater per person per day. Larger quantities of washwater require a soakage pit or soakage trench.

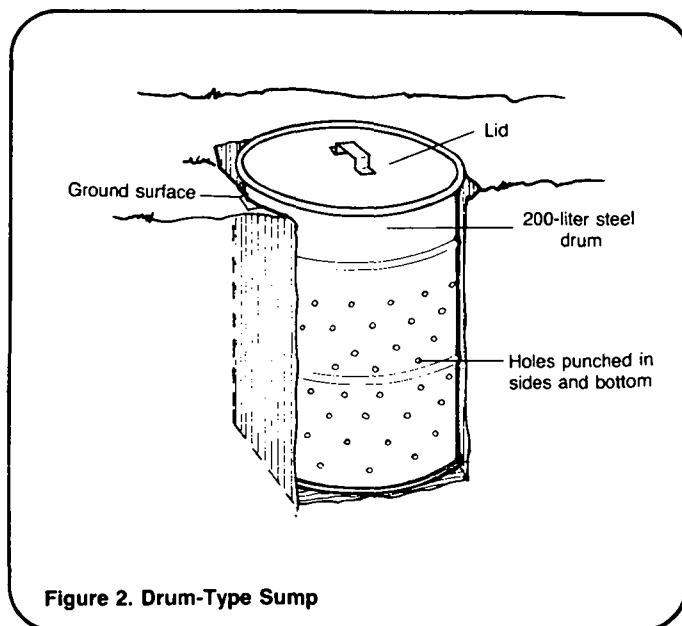


Figure 2. Drum-Type Sump

## Soakage Pit

A soakage pit, shown in Figure 3, is a medium to large hole in permeable soil that is filled with rocks, equipped with a pipeline, covered with straw, and mounded with dirt. The rocks prevent the pit walls from collapsing and allow washwater to drain through to the sides and bottom of the pit. The straw prevents soil from sifting between the rocks and clogging the flow of washwater. The pipe carries washwater from a sink or drain in the dwelling, or excess liquid run-off from an aqua privy. The pipe extends to the top center of the pit.

Soakage pits may be round, square, or rectangular. They vary in size from 1-3m in diameter and from 1-3m deep, depending on the quantities of washwater and the permeability of the soil. The bottom of the pit must be at least 1m above groundwater levels.

## Soakage Trench

A soakage trench, shown in Figure 4, is a relatively long, narrow, sloping hole dug in permeable soil. It is partly filled with gravel or crushed rock, equipped with a pipeline and a perforated or open-jointed distribution pipe, covered with straw, and mounded

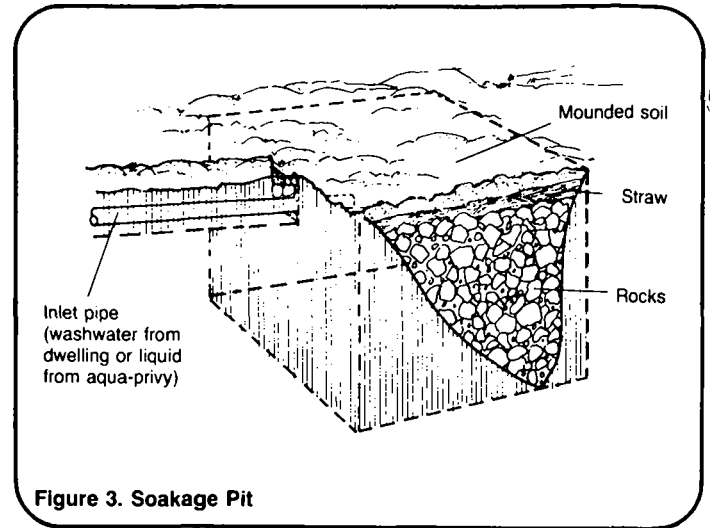


Figure 3. Soakage Pit

with dirt. The gravel prevents the sides of the trench from collapsing and allows washwater to flow through and drain to the bottom of the trench. If distribution pipe is not available, concrete blocks can be used instead. The straw prevents soil from sifting down and clogging the flow of washwater. The pipeline carries washwater from a sink or drain in the dwelling, or excess liquid run-off from an aqua privy. The pipe extends into the higher end of the trench.

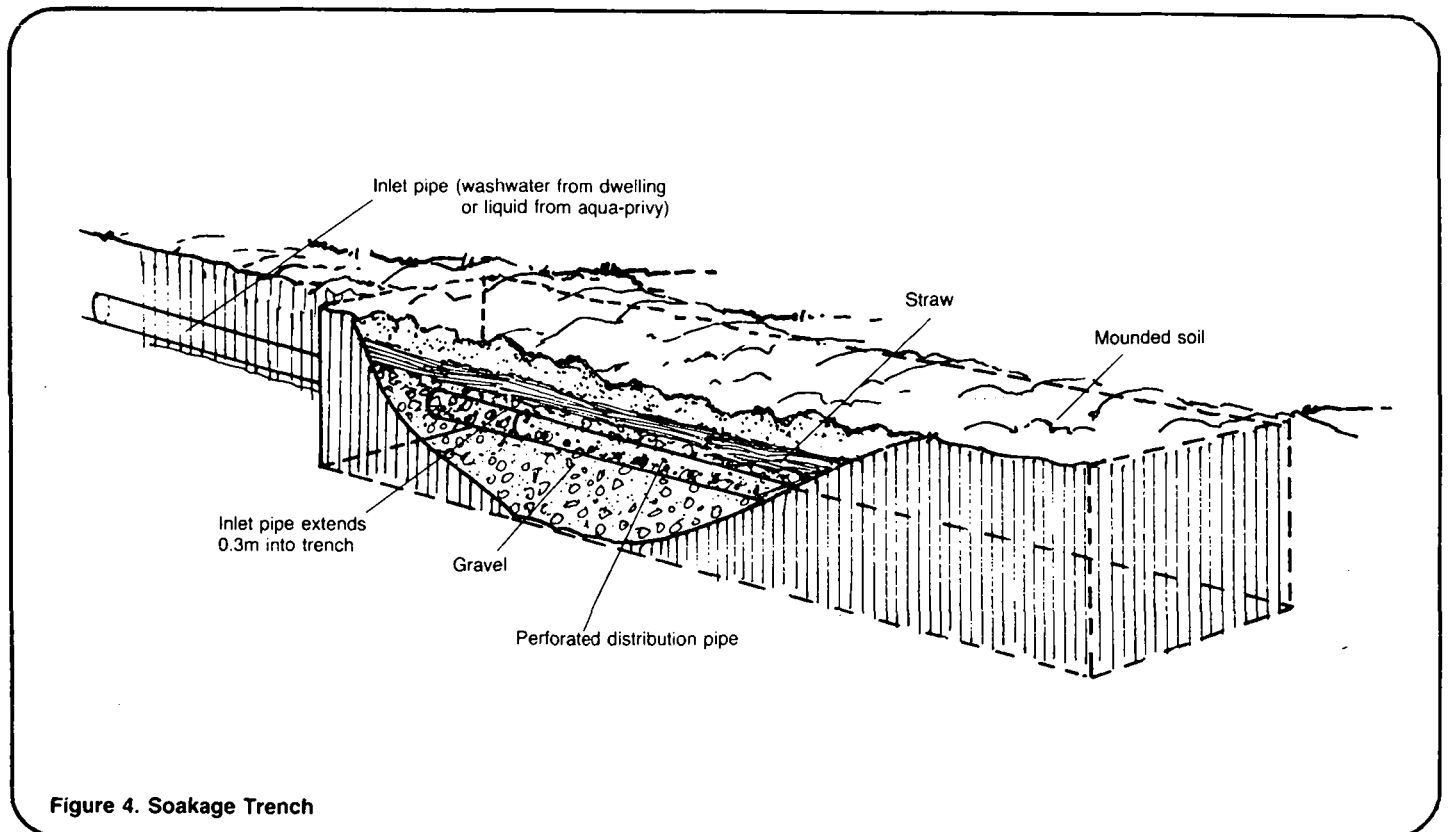


Figure 4. Soakage Trench

Soakage trenches are 0.6-1m wide, 0.6-1m deep, and vary in length from 6-30m depending on the quantities of washwater and the permeability of the soil. The bottom of the trench must be at least 1m above groundwater levels, and it must slope gradually downward away from the inlet end.

## Comparison of Methods

Table 1 summarizes each of the three methods of washwater disposal. The methods are listed across the top of the chart, and the factors to be compared are listed down the left side. The table can be used as an aid in selecting a method (see "Planning Simple Excreta and Washwater Disposal Systems," SAN.1.P).

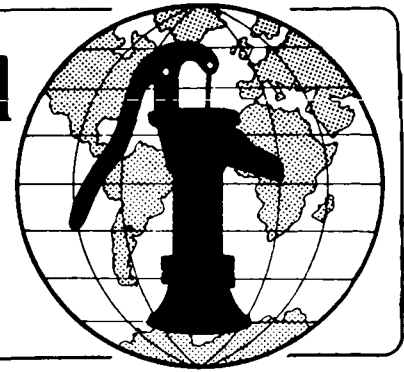
**Table 1. Comparison of Washwater Disposal Methods**

Factor	Disposal Method			
	Sump		Soakage Pit	Soakage Trench
	Pit-type	Drum-type		
Depth	0.5-1m	Height of drum	1-3m	0.6-1m
Diameter, or Length and Width	0.5-1m diameter	Diameter of drum	1-3m in diameter	0.6-1m wide and 6-30m
Materials Required	Concrete blocks, bricks, or stones; gravel or pebbles; wood or metal lid	200-liter steel drum; wood or metal lid	Rocks; straw, hay, or grass; length of clay, plastic, or galvanized metal pipe extending from dwelling or aqua privy to pit	Gravel, pebbles, concrete blocks, open-joint or perforated sewer pipe; straw, hay, or grass; length of clay, plastic, or galvanized metal pipe extending from dwelling or aqua privy to trench
Operation	Remove lid, pour washwater into pit	Remove lid, pour washwater into drum	Pour or drain washwater into sink, pipe, or aqua privy	Pour or drain washwater into sink, pipe, or aqua privy
Suitability	Low quantities of washwater (5 liters per person per day or less)	Low quantities of washwater (5 liters per person per day or less)	Small plot size or low groundwater levels	Large plot size or high groundwater levels

## Notes

**Technical Notes** are part of a set of "Water for the World" materials produced under contract to the U.S. Agency for International Development by National Demonstration Water Project, Institute for Rural Water, and National Environmental Health Association. Artwork was done by Redwing Art Service. Technical Notes are intended to provide assistance to a broad range of people with field responsibility for village water supply and sanitation projects in the developing nations. For more detail on the purpose, organization and suggestions for use of Technical Notes, see the introductory Note in the series, titled "Using 'Water for the World' Technical Notes." Other parts of the "Water for the World" series include a comprehensive Program Manual and several Policy Perspectives. Further information on these materials may be obtained from the Development Information Center, Agency for International Development, Washington, D.C., 20523. U.S.A.

# Water for the World



## Planning Simple Excreta and Washwater Disposal Systems Technical Note No. SAN. 1.P

Simple systems of excreta and washwater disposal are appropriate where moderate or small quantities of washwater are generated. The advantages of these systems are sanitary protection and low capital costs. The main disadvantage is their inability to handle greater water use in the future. The purpose of planning for these systems is to determine their specific nature and suitability.

Planning involves setting goals, then establishing step-by-step procedures to meet those goals. There are eight major actions involved in project development for which planning is important. It is necessary to: 1) recognize the problem, 2) organize community support and set objectives, 3) collect data, 4) formulate alternatives, 5) select the most suitable method, 6) establish the system, 7) operate and maintain the system, and 8) evaluate the system.

This technical note discusses planning and implementation of these eight activities. Read the entire technical note before beginning the planning process. Worksheet A may be adapted for use in cataloging information collected as planning proceeds.

### Recognize the Problem

This is done by gathering information from regional and national governments, questioning villagers and village leaders, and observing actual conditions in the field. Decide if the present methods of excreta and washwater disposal pose a health hazard to the people in the community. That is, determine whether the people suffer from diseases caused by poor sanitation (see "Means of Disease Transmission," DIS.1.M.1). In general, the village should consider simple systems of excreta and washwater disposal if the answer is "yes" to the following questions.

- Yes/No Are wells, springs, or community standpipes the major sources of community water?
- Yes/No Does the community generate less than 50 liters of washwater per person per day?
- Yes/No Are present methods of excreta and washwater disposal creating health hazards?
- Yes/No Do children or adults suffer from illnesses related to water supply or sanitation?

When the problem has been identified as unsanitary, improper, or inefficient disposal of excreta or washwater, then goals can be set to solve the problem.

### Organize Community Support and Set Goals

The main goal is to establish an effective system of excreta and washwater disposal. This is a major step toward improving the health of the community.

This goal cannot be met without strong community support (see "Methods of Initiating Community Participation in Water Supply and Sanitation Programs," HR.2.M). Establish close working relations with community leaders and organizers. Actively solicit their ideas and suggestions. The people in the community should be involved from the start of the project, because all stages of the project must be understood and accepted by them.

**Worksheet A. Planning a Simple Excreta and Washwater System**

1. Problems indicating a need for action are:

- (1) \_\_\_\_\_
- (2) \_\_\_\_\_
- (3) \_\_\_\_\_

2. Community support will be organized and oriented by (name and position):

- (1) \_\_\_\_\_
- (2) \_\_\_\_\_
- (3) \_\_\_\_\_

2. a. Major objectives of the program are:

- (1) \_\_\_\_\_
- (2) \_\_\_\_\_
- (3) \_\_\_\_\_

3. Data which will influence decisions are:

- (1) Need: \_\_\_\_\_
- (2) Present Methods: \_\_\_\_\_
- (3) Community Acceptance: \_\_\_\_\_
- (4) Resources: \_\_\_\_\_
- (5) Geography: \_\_\_\_\_

4. Alternatives to be considered are:

- (1) \_\_\_\_\_
- (2) \_\_\_\_\_
- (3) \_\_\_\_\_

**Worksheet A. Planning a Simple Excreta and Washwater Disposal System (continued)**

5. The method(s) selected is (are):

- (1) \_\_\_\_\_
- (2) \_\_\_\_\_
- (3) \_\_\_\_\_

6. The system will be established by:

- (1) Ensuring public acceptance by building demonstration models or by: \_\_\_\_\_
- (2) Submitting plans to (government or lending agency): \_\_\_\_\_  
\_\_\_\_\_
- (3) Obtaining financing from (local sources, government, lending agency, or other): \_\_\_\_\_
- (4) Planning the construction within \_\_\_\_\_ weeks.
- (5) Constructing the system within \_\_\_\_\_ months.

7. The operation and maintenance of the system will be supervised by (name and position):

- (1) \_\_\_\_\_
- (2) \_\_\_\_\_
- (3) \_\_\_\_\_

8. The system will be evaluated during (month and year) \_\_\_\_\_, by (name and position):

- (1) \_\_\_\_\_
- (2) \_\_\_\_\_
- (3) \_\_\_\_\_

Another part of the main goal is setting secondary goals such as a time span for establishing the system (for example, three months or one year). Secondary goals should be set with the participation and agreement of community leaders. Be realistic when setting goals. Consider local customs and resources such as money, material, and talent. Do not set goals that may be impossible for the community to reach. Set goals that are definite and can be measured, so people will know when they have reached them. For example, build ten privies within six months; or provide effective excreta disposal methods to half the families in the village within one year.

Your goals must: 1) clearly state what the project will accomplish, 2) state the methods that will be used, and 3) specify when these accomplishments will be made. At the end of the specified length of time, it should be possible to determine if your goals have been met.

When the goals have been set, proceed with the next step in planning: data collection.

### Collect Data

To plan the system you must have correct data. The data can be roughly divided into five categories: (a) environmental conditions in the village, (b) present methods of excreta and washwater disposal, (c) attitude of the people, (d) resources, and (e) geography. Collecting data will be an ongoing process; some of the data will be used now, some later.

Keep a written record of all data collected. Some data will be specific (for example, number of persons living in a dwelling or a family's source of drinking water). Other data will be more general (for example, villagers' attitudes toward new methods of excreta disposal). Use the following checklist to help organize data collection.

#### (a) Environmental Conditions in the Village

1. Determine the incidence of disease associated with poor sanitation (see "Means of Disease Transmission," DIS.1.M.1) by personal observation, questioning villagers and village leaders, and checking health records if available. Local health clinics may have this information.

2. Observe and record evidence of excreta or washwater on the surface of the ground.

3. Determine whether excreta or washwater is being disposed of in or near sources of drinking water. Do this by questioning villagers and by personal observation.

4. Determine whether there are bothersome numbers of flies or mosquitoes.

5. Determine whether there are foul odors.

#### (b) Present Methods of Excreta and Washwater Disposal

1. List the present methods of excreta and washwater disposal.

2. Determine how many of each method are in use.

3. Determine how many persons use each facility.

4. Determine if the present methods can be upgraded or converted to those methods listed in "Simple Methods of Excreta Disposal," SAN.1.M.1 and "Simple Methods of Washwater Disposal," SAN.1.M.2.

#### (c) Attitude of the People

1. Question the villagers and village leaders about their attitudes toward excreta and washwater disposal in general.



2. Question villagers and village leaders about their preferences concerning specific excreta and washwater disposal methods.

3. Identify local customs and taboos.

(d) Resources

1. List sources of money (private sources, local funds, government grants, taxes, general fund, and so on) and amounts available.

2. List types and quantities of available tools and equipment.

3. List types and quantities of available materials.

4. List names and special skills of available skilled workers.

5. List the names of available unskilled workers.

(e) Geography

1. Record the type (well, spring, stream, standpipe, piped into dwelling), number, and location of all drinking water supplies.

2. Test and record soil conditions for suitability for excreta and washwater disposal (see "Determining Soil Suitability," SAN.2.P.3).

3. Determine and record groundwater levels for the wettest season.

4. Record the number of villagers and the physical size of the village.

5. Record the number of family lots, the size of each lot, and the number of persons per lot.

### Formulate Alternatives

Use the collected data and the information in "Simple Methods of Excreta Disposal," SAN.1.M.1, and "Simple Methods of Washwater Disposal," SAN.1.M.2, to formulate alternative systems of excreta and washwater disposal. Each alternative may be a

combination of one or more methods of excreta disposal or one or more methods of washwater disposal, or it may be a single method of disposal. When formulating alternatives, use only those that are practical for your community and are basically acceptable to the community members. Reject those methods which, for any reason, are inappropriate, impractical, or unacceptable.

The remaining alternatives are possible solutions to the problem. To determine the best method for your situation, proceed to the next step: selecting a method.

### Select a Method

When selecting a simple method of excreta or washwater disposal, carefully study the features of each alternative and thoroughly analyze the collected data. The selection of a method should be based on the following considerations:

Need. Are present methods of excreta and washwater disposal inadequate? Do people in the community suffer from disease caused by poor sanitation?

Social acceptability. This is a most important consideration, for if the system is unacceptable to the people, it will surely fail. Will the method of disposal violate local customs, taboos, or preferences? Is the method likely to be maintained? Have the people indicated that they prefer this system, or at least are willing to try it?

Resources. Is the desired method practical considering available money, materials, and workers? Is the regional or national government likely to provide monetary or other assistance?

Geography. Are soil conditions and groundwater levels acceptable for the desired method?

Plot size. Is the plot large enough for two alternating pit sites (at least 0.1 hectares)?

Washwater. Is the quantity of washwater generated more or less than 50 liters per person per day?

Use the comparison charts in "Simple Methods of Excreta Disposal," SAN.1.M.1 and "Simple Methods of Washwater Disposal," SAN.1.M.2, and Tables 1 and 2 in this technical note to help select methods of excreta and washwater disposal. These decision tables are not meant to be followed strictly; they are merely aids in selecting a method. If you need more specific information on the features of any method, consult the "design" or "construction" technical notes dealing with that particular method.

## **Establish the System**

There are three steps in establishing the system: involving the public, submitting your plan for approval, and planning for construction.

Involving Public. The first step in establishing the system is gaining public acceptance. Arrange a visit for community leaders to a similar community in the area that already has a system. This will stimulate interest in the community. It may be worthwhile to build an excreta disposal method for demonstration. This will allow the people to examine, understand, and use the facility. A demonstration model can serve as a final test of community acceptance before you construct a large number of facilities.

Submitting Plan for Approval. The second step in establishing the system is submitting your plan, if required, to the regional or national government or a lending agency. Since they will have to approve the entire plan before you can proceed, your submission should include: (a) the proposed technical system, (b) costs, (c) sources of finance, and (d) an implementation schedule similar to Figure 1.

(a) Proposed system. Submit designs, complete with drawings or photographs, of the methods selected. Decide how many units will be built and where they will be located. Be prepared to explain your decisions. Draw a map, perhaps a contour map, of the village and surrounding area. Include dwellings, sources of drinking water, and present and proposed locations of excreta and washwater disposal systems. Use the design drawings and maps in a presentation to the government agency or funding source. Bring village leaders, or others who speak for the community, to help explain the need for the project.

(b) Costs. Determine how much money will be needed to pay construction workers. This will depend on salary levels, number of workers, and estimated time for construction. Determine how much money will be needed for materials, tools, and equipment. Make every effort to use locally available materials. Estimate how much money will be needed to maintain and repair the system for a specific period of time--one year, for example.

(c) Sources of finance. Funds may be available locally, nationally, and internationally. If outside funds are needed, your government can explain how to get national or international funds, which can be in the form of grants or loans. Local funds can come from taxes, user fees, or a general fund. The tax can be a special tax or an increase of an existing tax. An example of a user fee is charging families for all or part of the construction costs for individual systems. The general fund could be a health fund, with the purpose of improving water supplies and sanitation, into which everyone in the village pays a certain amount.

Determine the villagers' ability and willingness to pay for building the excreta and washwater disposal system. It may be that local funds will not take the form of money, but rather of contributions of labor or materials. For example, villagers wanting pit privies could be required to contribute

**Table 1. Selecting a Simple Method of Excreta Disposal**

If	And	And	And	Then
Existing excreta and washwater disposal systems are creating health hazards, and quantities of washwater exceed 50 liters per person per day				Go to "Planning Combined Washwater and Excreta Disposal Systems," SAN.2.P.1
Quantities of washwater are less than 50 liters per person per day and plot size is larger than 0.1 hectares and soil is suitable for excreta disposal	Pit Privy is acceptable	Available money/materials for improvements	Convenient water source for pour-flush bowl (1-3 liters per use)	Pit privy with Pour-Flush Bowl
			No convenient water source	Pit Privy with Vent Pipe and/or Off-Set Pit
	Pit Privy is not acceptable	Reuse of excreta is acceptable	No available money/materials for improvements	Pit Privy
			Compost toilet will be maintained	Compost Toilet
Quantities of washwater are less than 50 liters per person per day and plot size is smaller than 0.1 hectares, or soil is not suitable for excreta disposal	Reuse of excreta is acceptable	Compost toilet will be maintained		Aqua Privy
				Compost Toilet
				Bucket Latrine

**How To Use Decision Table 1**

1. Find the statement in the "If" column that best describes your situation.
2. Move to the adjacent boxes in the first "And" column and select the statement that best fits your situation.
3. From your statement in the first "And" column, move to the adjacent boxes in the second "And" column and select the statement that best fits your situation.
4. From your statement in the second "And" column, move to the adjacent boxes in the third "And" column and select the statement that best fits your situation.
5. From your statement in the third "And" column, move to the adjacent box in the "Then" column to find the recommended method of excreta disposal.

**Table 2. Selecting a Simple Method of Washwater Disposal**

If the Quantity of Washwater Is:	Then the Disposal Method Should Be:
More than 50 liters per person per day <span style="float: right;">—————→</span>	Go to "Planning Combined Washwater and Excreta Disposal Systems," SAN.2.P.1
Less than 50 but more than 5 liters per person per day** <span style="float: right;">—————→</span>	Soakage Pit or Soakage Trench
Less than 5 liters per person per day <span style="float: right;">—————→</span>	Sump

\*\*If the excreta disposal method is a privy with a pour-flush bowl, some of the washwater (1-3 liters per use) can be used to flush the bowl. The remaining washwater must be disposed of in a soakage pit or soakage trench.

If the excreta disposal method is an aqua privy, all the washwater can be poured into it, because it is connected to a soakage pit or soakage trench.

### How To Use Decision Table 2

1. Find the statement in the left-hand column that best fits your situation.
2. Move to the adjacent box in the right-hand column to find the recommended method of washwater disposal.

all of the labor and the materials for the pit linings and shelters, and an outside funding source could supply the metal vent pipes and concrete for the slabs.

(d) Implementation schedule. Assign specific, reasonable time spans to each stage of the project. Allow time to collect data, formulate alternatives, select a method, establish the system,

and train workers to operate and maintain the system. To help visualize an entire project and establish timetables for it, draw a chart similar to Figure 1 with the month number across the top and the specific tasks on the left-hand side. Figure 1 also includes tasks performed from the start of the project such as recognizing problems, consulting with villagers, and early collection of data.

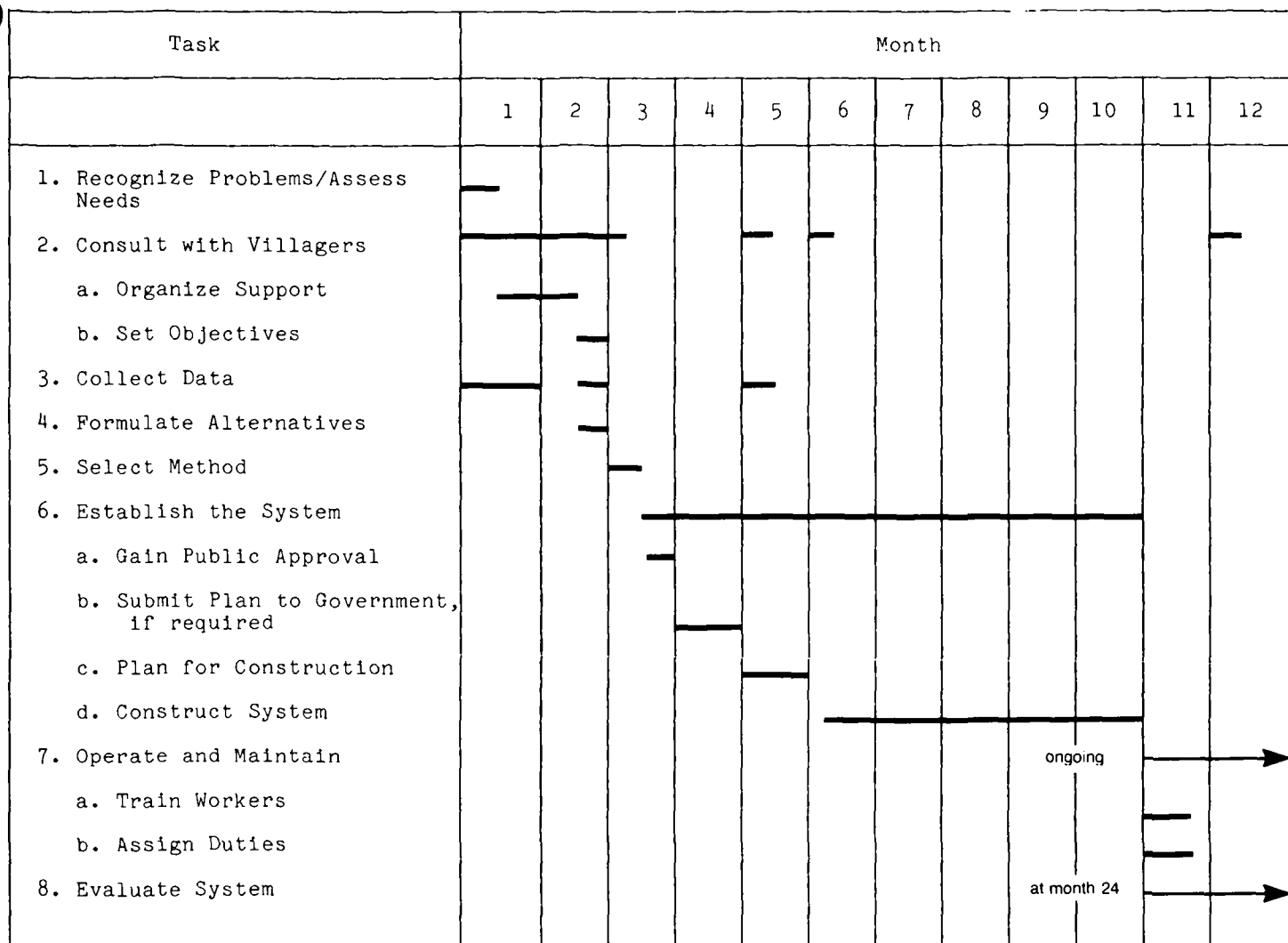


Figure 1. Sample Scheduling for a Simple Excreta and Wastewater Disposal Project

**Planning for Construction.** The third step in establishing the system is planning for construction. Determine which components of the excreta disposal system can be constructed in the community, perhaps the privy shelter, and which components will have to be purchased from outside the community, perhaps the pour-flush bowl.

Decide who will do the work, the type and amount of training they will require, and how much they must be paid. Determine which tools, equipment, and materials are needed for construction, and be prepared to assemble them. Organize construction. Be prepared to assign specific duties, set up time schedules, and designate someone to oversee the work.

### Operate and Maintain the System

Plan for the continued use of the facilities after they are built. This includes routine cleaning of privy slabs and inspection of shelters, and periodic removal of compost from compost toilets and sludge from aqua privies.

Establish a system of cleaning, maintenance, and repair. Workers must be trained, and money and materials must be made available to maintain the system. If these systems are not routinely maintained, they can become unsanitary and may pose a health hazard.

## Evaluate the System

Evaluate the project one year and five years after completion to determine whether project goals have been achieved. Determine the success of the project by: 1) questioning villagers on their use or neglect of the facilities, 2) comparing before and after health aspects (examine individuals and study health statistics, if available), and 3) comparing the conditions of the facilities with the conditions existing

before the project. Determine if old problems have been eliminated, and decide if any new problems have arisen. Perhaps the village now needs and can afford a more advanced system of excreta and wash water disposal, such as septic tanks and absorption fields.

Sanitation improvements in rural villages are usually made one step at a time. Therefore, your evaluation of this project should be the first step in planning the next sanitation improvement.

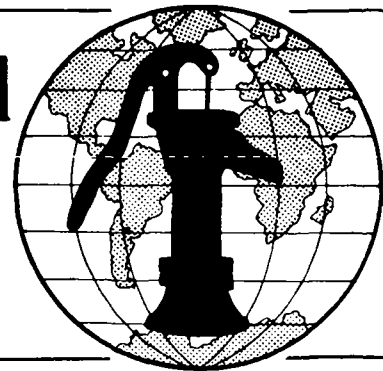
## Notes

## Notes

**Technical Notes** are part of a set of "Water for the World" materials produced under contract to the U.S. Agency for International Development by National Demonstration Water Project, Institute for Rural Water, and National Environmental Health Association. Artwork was done by Redwing Art Service. Technical Notes are intended to provide assistance to a broad range of people with field responsibility for village water supply and sanitation projects in the developing nations. For more detail on the purpose, organization and suggestions for use of Technical Notes, see the introductory Note in the series, titled "Using 'Water for the World' Technical Notes." Other parts of the "Water for the World" series include a comprehensive Program Manual and several Policy Perspectives. Further information on these materials may be obtained from the Development Information Center, Agency for International Development, Washington, D.C., 20523, U.S.A.



# Water for the World



## Designing Slabs for Privies

Technical Note No. SAN.1.D.1

The slab is the floor of the privy. It covers the pit and has a hole through which to defecate. Designing a slab involves selecting the type of slab (squatting or sitting), deciding which improvements the privy will have, calculating the dimensions of the slab, and determining the materials, labor, and tools needed to build it. The products of this process are design drawings of the slab and improvements, if any, and a detailed materials list. These items should be given to the person in charge of construction.

This technical note describes how to design a slab and arrive at these end-products. Read the entire technical note before beginning the design process.

## Materials Needed

Measuring tape - To check dimensions of previously constructed items (pit, base around pit, or pour-flush bowl, for instance)

## Selecting Slab Type

The type of slab selected depends on whether the users prefer to squat or sit when defecating.

Squatting Slab. The main features of a squatting slab are a hole, a pair of footrests, and a lid to cover the hole. See Figures 1 and 2.

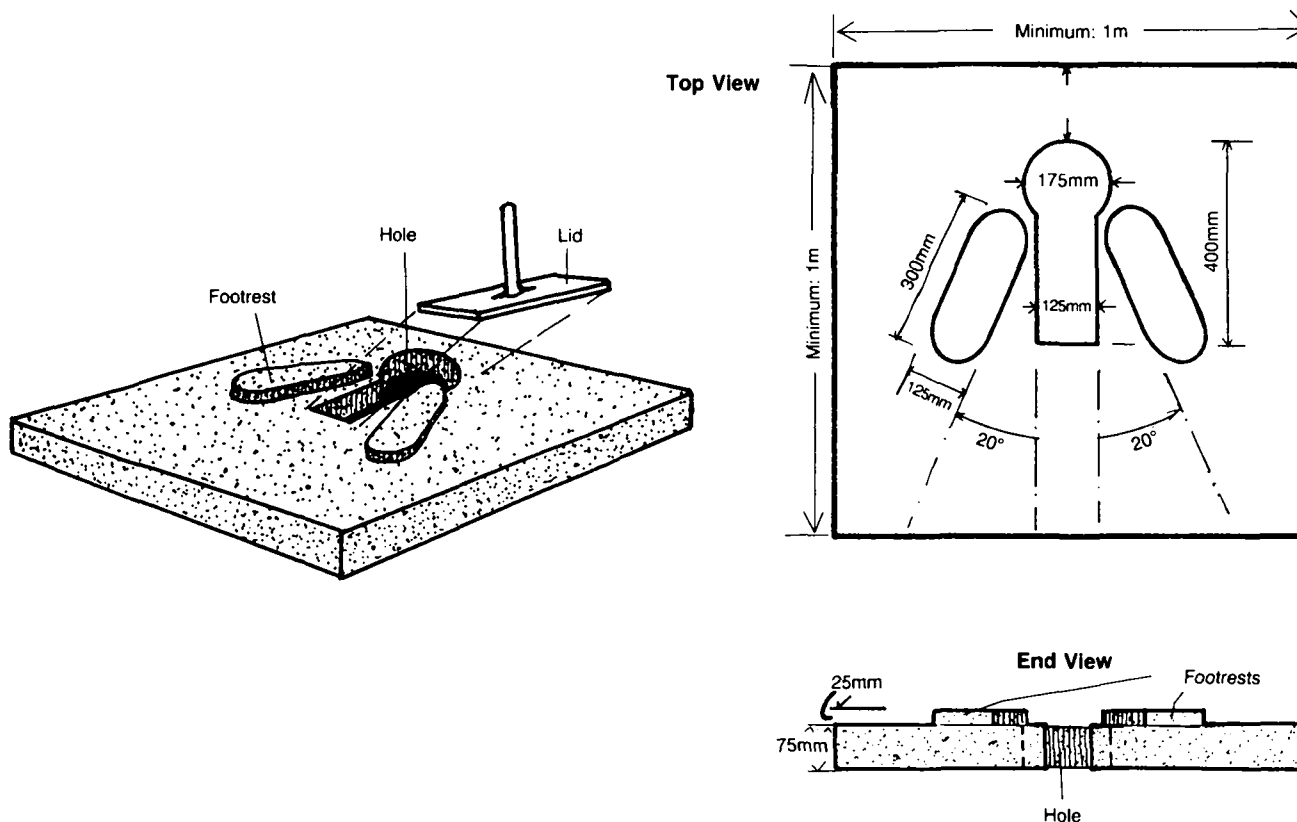


Figure 1. Squatting Slab

The hole is generally key-hole shaped, about 400mm long, and 125mm wide at the narrow end. The wide end is a circle 175mm in diameter. The back edge of the hole usually should be about 150mm from the back wall of the privy which, depending on the design, may be at the edge of the slab. If the distance between the wall and the hole is less than 150mm, there may not be enough space to squat. If the distance is more, there is a greater risk of soiling the floor. The distance between the edge of the hole and the edge of the slab may be greater than 150mm if the privy has a vent pipe.

Since the footrests ensure that the privy user is positioned correctly over the hole, their placement is important. They are oval-shaped, about 300mm long, 125mm wide, and 25mm high.

The lid should cover the hole but not fit inside it. It should have a handle. See Figure 2.

Sitting Slab. The main features of a sitting slab are a hole, a pedestal or riser, a seat, and a lid to cover the seat.

The hole is 250-300mm in diameter and should be about 150mm from the back wall of the privy which may be at the back edge of the slab, depending on the design. See Figure 3.

The pedestal is 275-350mm high and has the same inside diameter as the hole. The thickness of the pedestal walls depends on the materials used.

The seat is attached to the top of the pedestal. Its outside measurements are equal to or greater than the outside measurements of the pedestal. The seat has a hole in the center 200mm in diameter. A second seat with a smaller hole (150mm) in diameter can be included for children.

The lid covers the seat and is often attached to the back of the seat with a hinge. See Figure 3.

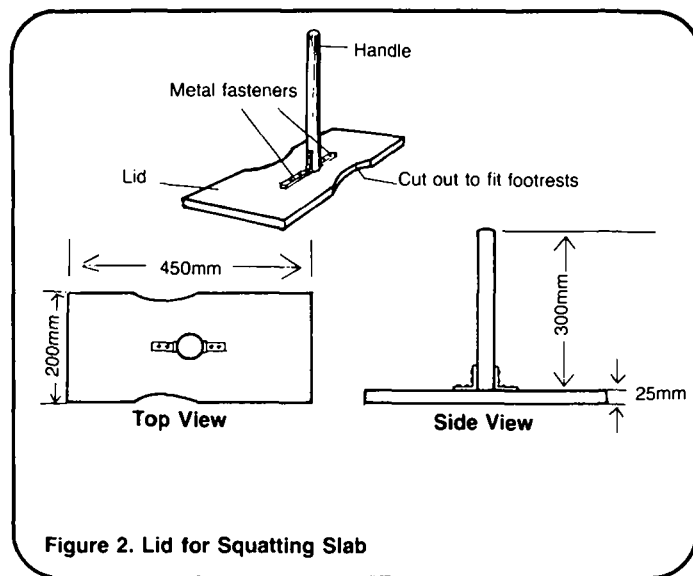


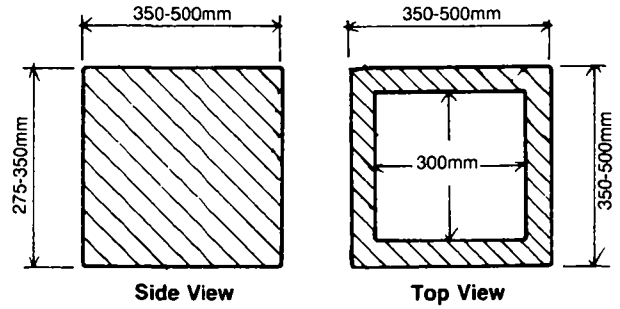
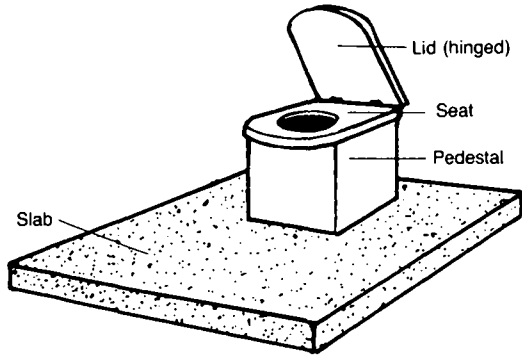
Figure 2. Lid for Squatting Slab

## Determining Improvements

The main improvements to a privy are a vent pipe, a pour-flush bowl, an off-set pit, or a combination of the three. Any privy improvement will modify the slab design.

Vent Pipe. If the privy is to have a vent pipe, the pit must be about 300mm longer than a pit for an unimproved privy (see "Designing Pits for Privies," SAN.1.D.2). The slab must also be longer by about 300mm. This means that the distance from the back edge of the squatting hole to the edge of the slab is 450mm--150mm for the basic design plus 300mm for the vent pipe. See Figure 4. The slab has a hole 100-150mm in diameter, depending on the size of the vent pipe, and is positioned as in Figure 5. The vent pipe can be made from a sheet of tin or galvanized metal and should be topped with a fly-proof screen.

Pour-Flush Bowl. If the privy is to have a pour-flush bowl, the squatting hole may not be key-hole shaped. The shape of the hole must conform to that of the bowl, and often the bowls are prefabricated as shown in Figure 6. The bowl should be positioned to flush forward, to prevent erosion of the pit wall.



PEDESTAL

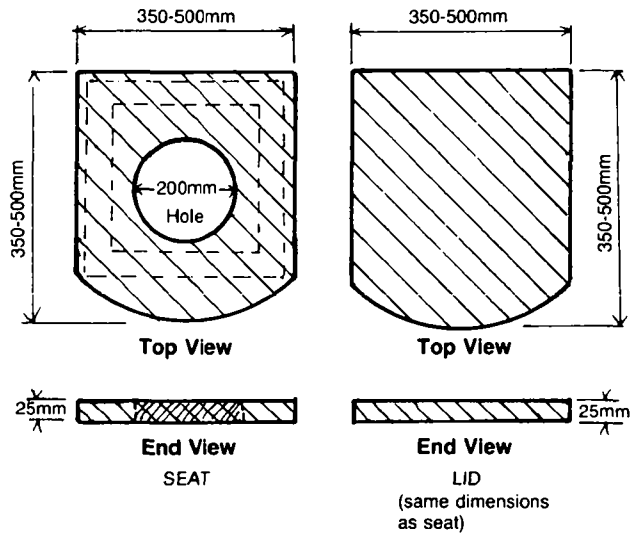
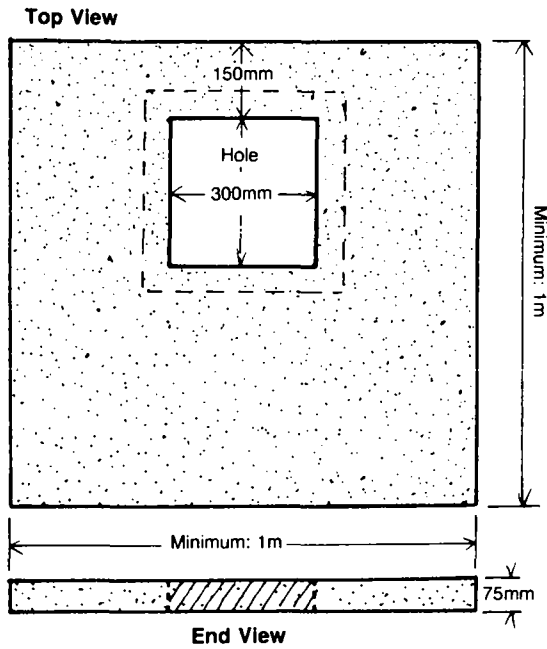


Figure 3. Sitting Slab with Pedestal, Seat and Lid

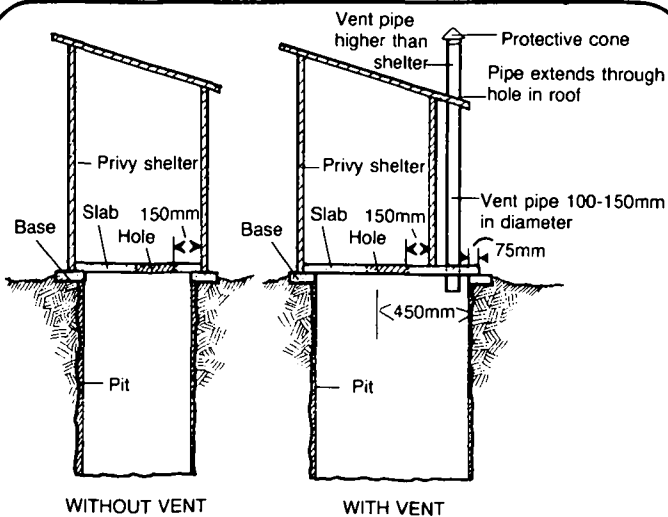


Figure 4. Comparison of Privies with and without Vent

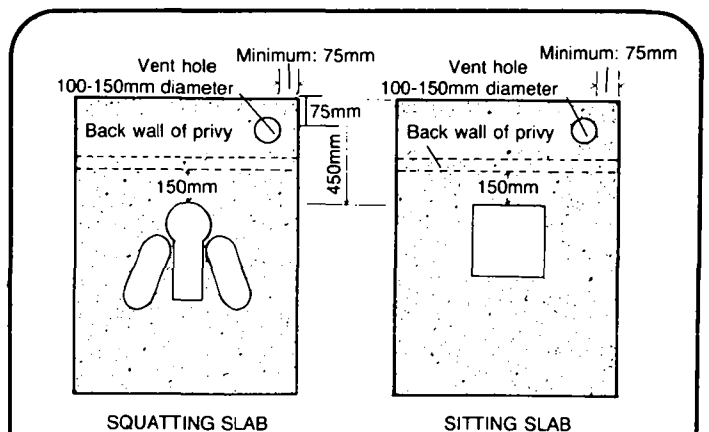


Figure 5. Top View of Slabs Showing Vent Hole Placement

**Off-Set Pit.** The slab for an off-set pit rests on a platform made of wood, bricks, or concrete and has a metal chute attached to the hole. The chute can be made from a sheet of tin or galvanized metal. It enters the pit below ground level at a downward angle of  $50^{\circ}$  to  $60^{\circ}$ . The upper end is mortared to the bottom of the slab and encircles the squatting hole. The lower end narrows to about 200mm in diameter and extends about 100mm beyond the pit wall. See Figure 7. The pit must have a cover which can be made in one piece or in sections. If the cover is made of concrete, it should be made in sections for easier handling as shown in Figure 8. The cover must be strong enough to prevent persons from falling into the pit.

**Combination.** If there is a combination of improvements, each improvement will modify the design of the slab as described above. For example, a privy with a vent pipe and a pour-flush bowl must have a longer slab to accommodate the vent and a specially shaped hole for the bowl. There is one exception. The slab design for an off-set pit is the same whether or not the pit has a vent pipe, because a vent pipe used with an off-set pit extends through the pit cover, not through the slab. See Figures 7 and 8.

### Calculating Dimensions

Unimproved, ventilated, or pour-flush privies must have slabs that cover the pit and overlap each edge

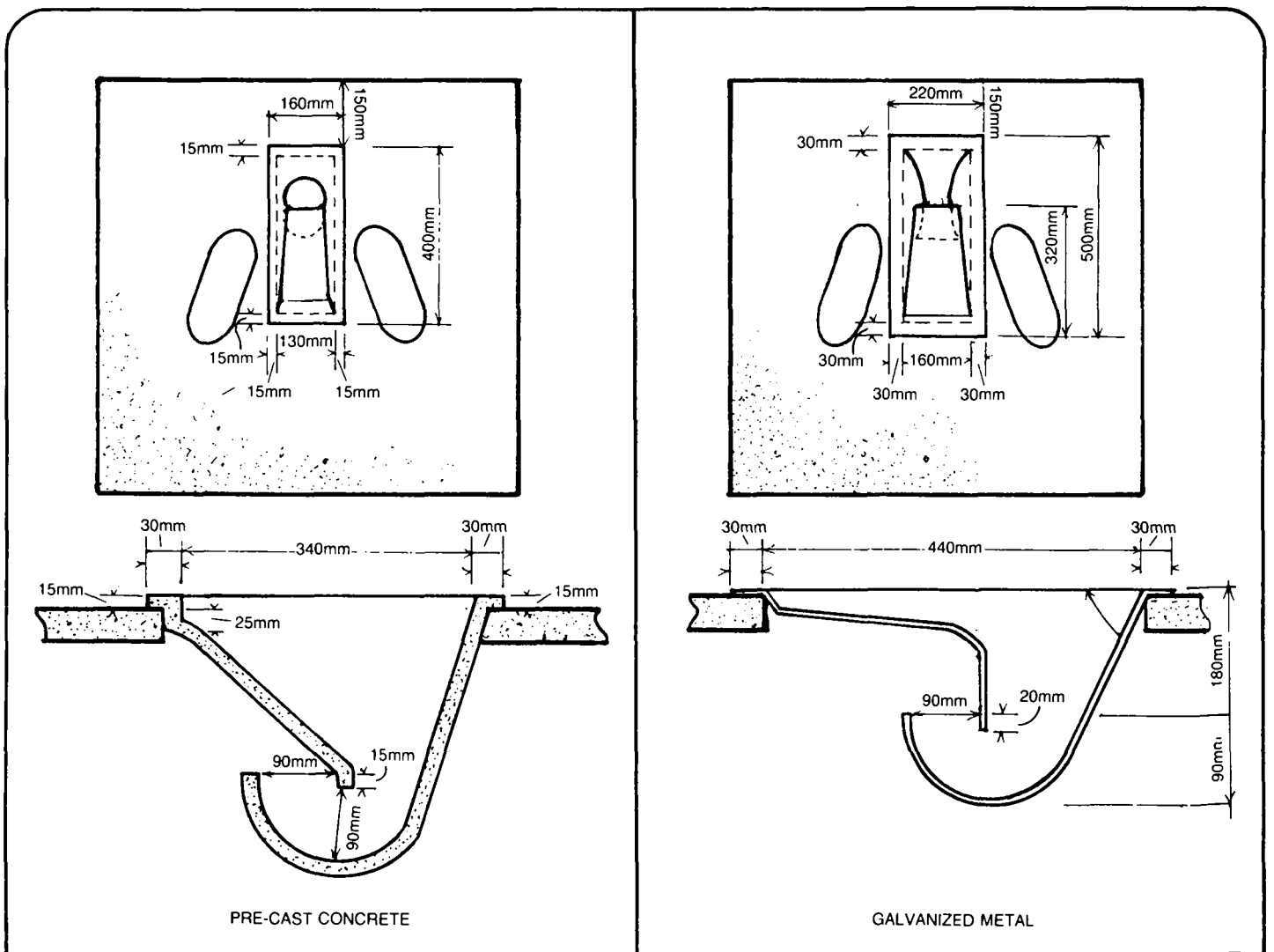


Figure 6. Pour-flush Bowls for Squatting Slabs

by at least 75mm. The length of the slab for these kinds of privies equals the length of the pit plus 150mm and the width of the slab equals the width of the pit plus 150mm. Worksheet A shows the steps in calculating slab dimensions. For example, suppose the pit is 1.5m long and 1.2m wide. Then the length of the slab is  $1.5\text{m} + 0.15\text{m} = 1.65\text{m}$ . The width of the slab is  $1.2\text{m} + 0.15\text{m} = 1.35\text{m}$ . See Worksheet A, step #1. For an off-set pit, the slab should be about 1m square. The thickness of a slab depends on the material used to make it. A reinforced concrete slab is 50-75mm thick.

The cover for an off-set pit must be large enough to cover the pit and overlap each edge by at least 75mm. The length of the cover equals the length of the pit plus 150mm, and the width of the cover equals the width of the pit plus 150mm. For example, suppose the pit is 1.7m long and 1.2m wide. Then the length of the cover is  $1.7\text{m} + 0.15\text{m} = 1.85\text{m}$ . The width of the cover is  $1.2\text{m} + 0.15\text{m} = 1.35\text{m}$ . See Worksheet A, step #3.

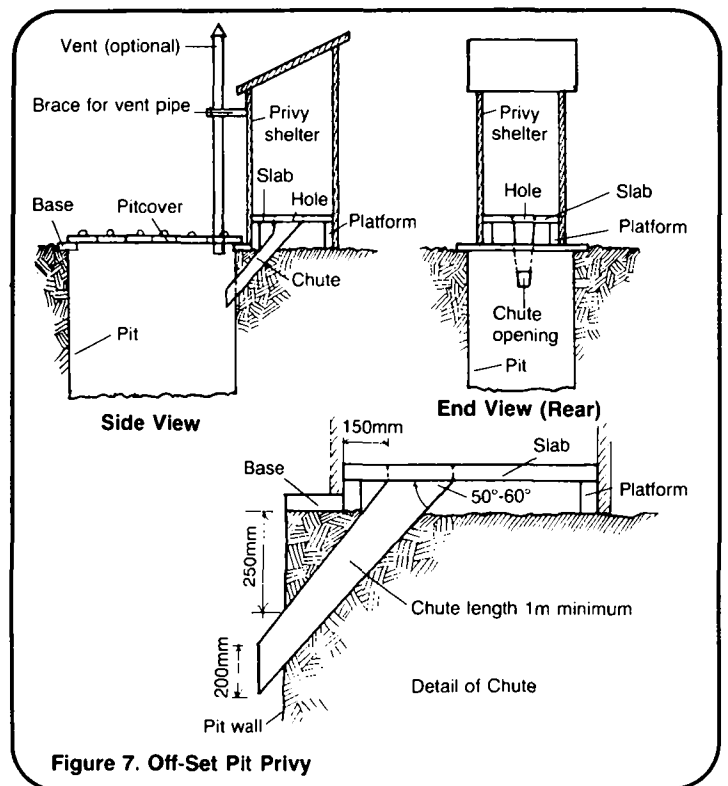


Figure 7. Off-Set Pit Privy

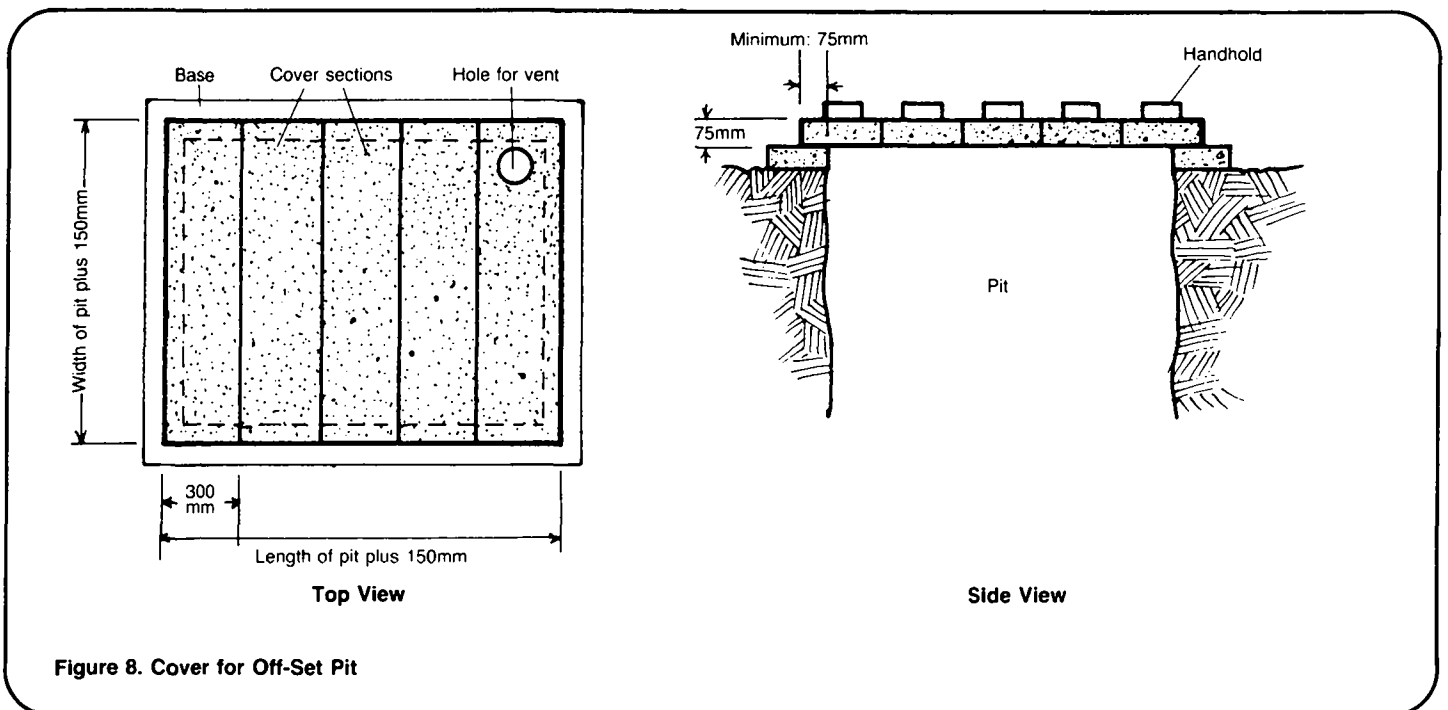


Figure 8. Cover for Off-Set Pit

## Worksheet A. Calculating Dimensions

1. Slab (sitting or squatting) for unimproved, ventilated, or pour-flush privy:

Length of slab = length of pit  $\frac{1.5}{m} + 0.15m = \frac{1.65}{m}$   
Width of slab = width of pit  $\frac{1.2}{m} + 0.15m = \frac{1.35}{m}$   
Thickness of slab (if concrete) = 50-75mm

2. Slab (sitting or squatting) for off-set pit privy:

Length of slab = 1.0m  
Width of slab = 1.0m  
Thickness of slab (if concrete) = 50-75mm

3. Cover for off-set pit:

Length of cover = length of pit  $\frac{1.7}{m} + 0.15m = \frac{1.85}{m}$   
Width of cover = width of pit  $\frac{1.2}{m} + 0.15m = \frac{1.35}{m}$   
Thickness of cover (if concrete) = 75mm

4. If cover is in sections:

Length of each section = width of cover =  $\frac{1.35}{m}$   
Width of each section except one = 300mm  
Width of one section = 300mm plus necessary width to total  
entire length of the cover =  $300mm + \frac{50}{mm} = \frac{350}{mm}$   
Combined widths of sections = total length of cover =  
 $300 + 300 + 300 + 300 + 300 + 350mm = 1850mm$

(NOTE: To calculate quantities of concrete, see "Designing Septic Tanks," SAN.2.D.3.)

If the cover is reinforced concrete, it should be made in sections. The length of each section equals the width of the pit plus 150mm and the width of each section, except for one end section, is 300mm. The width of one end section must be 300mm plus whatever measurement is necessary to add up to the total length of the cover. For example, suppose the total length of the cover must be 1850mm. Then the cover would be made in six sections with widths of  $300 + 300 + 300 + 300 + 300 + 350mm = 1850mm$ . See Worksheet A, step #4.

The thickness of a cover for an off-set pit depends on the material it is made from. A reinforced concrete cover should be about 75mm thick.

A vent pipe is 2-2.5m long and 100-150mm in diameter. A chute for an off-set pit is at least 1m long, with an average width of 200mm. Worksheet B shows how to calculate the dimensions of the materials needed to make vent pipes and chutes for off-set pits.

## Worksheet B. Calculating Quantities of Material for Vent Pipe and Chute

### Vent Pipe

Generally made from a sheet of tin or galvanized metal. The size of the sheet:

Length = height of privy shelter (from "Designing Privy Shelters,"  
SAN.1.D.3) plus 0.6m  
Width = diameter of vent pipe times 3.3

Example: Suppose that the height of the privy shelter is 2m and the diameter of the vent pipe is 150mm. Then the sheet of tin needed to make the pipe will have these dimensions:

Length = 2m + 0.6m = 2.6m  
Width = 150mm x 3.3 = 500mm

(NOTE: The method used to calculate the width allows the edges of the sheet to overlap about 25mm when the pipe is made.)

---

### Chute (for off-set pit)

Generally made from a sheet of heavy tin or galvanized metal. The size of the sheet:

Length = 1.5 times the distance from the front edge of the pit to the farthest edge of the hole in the slab.

Width = distance around the hole plus 25mm

(NOTE: The distance around the hole equals 2 times the length plus the width.)

Example: Suppose the hole in the slab is 150mm wide and 400mm long, and that the distance from the pit to the edge of the hole farthest from the pit is 700mm. Then the sheet of tin needed to make the chute will have these dimensions:

Length = 1.5 x 700mm = 1050mm  
Width = distance around hole + 25mm  
= 2 x (150mm + 400mm) + 25mm  
= 1125mm

(NOTE: The "width" of the sheet may be longer than the "length.")

When the type of improvements and dimensions have been determined, prepare design drawings similar to Figures 1-9, showing correct dimensions and top and side views of the slab and improvements. Give these drawings to the person in charge of construction.

### Materials List

Slabs can be made from a variety of materials, including reinforced concrete, wood or bamboo. Generally, they are made from concrete, because concrete is strong, long-lasting, and easy to clean.

A common mix by volume for concrete is one part cement, two parts sand, three parts gravel, and about 2/3 part water or enough water to make a fairly stiff mix. The cement should be Portland cement. The sand should be clean and sized fine to 6mm. The gravel should be clean and sized 6-25mm. The water should be clear. For details on calculating quantities for concrete mix, see "Designing Septic Tanks," SAN.2.D.3.

A concrete slab must have reinforcing material, such as steel bars 10mm in diameter, wire mesh, or split bamboo. To calculate the quantity of steel bars needed, draw a sketch similar to Figure 9, showing bars in place, and count the number and lengths of the bars. If wire mesh is used, the quantity is approximately equal to the area of the slab (length times width).

The reinforcing material must not block the hole in the slab. No part of it should stick out through the concrete.

The tools and labor required to build a slab depend on the materials used. If it is made of reinforced concrete, at least one worker should have some knowledge of or experience with concrete (mixing, pouring, and building forms). Common tools for working with concrete include hammer, saw, and nails for building forms; container, shovel, tamping rod, and trowel for mixing, pouring, and smoothing concrete.

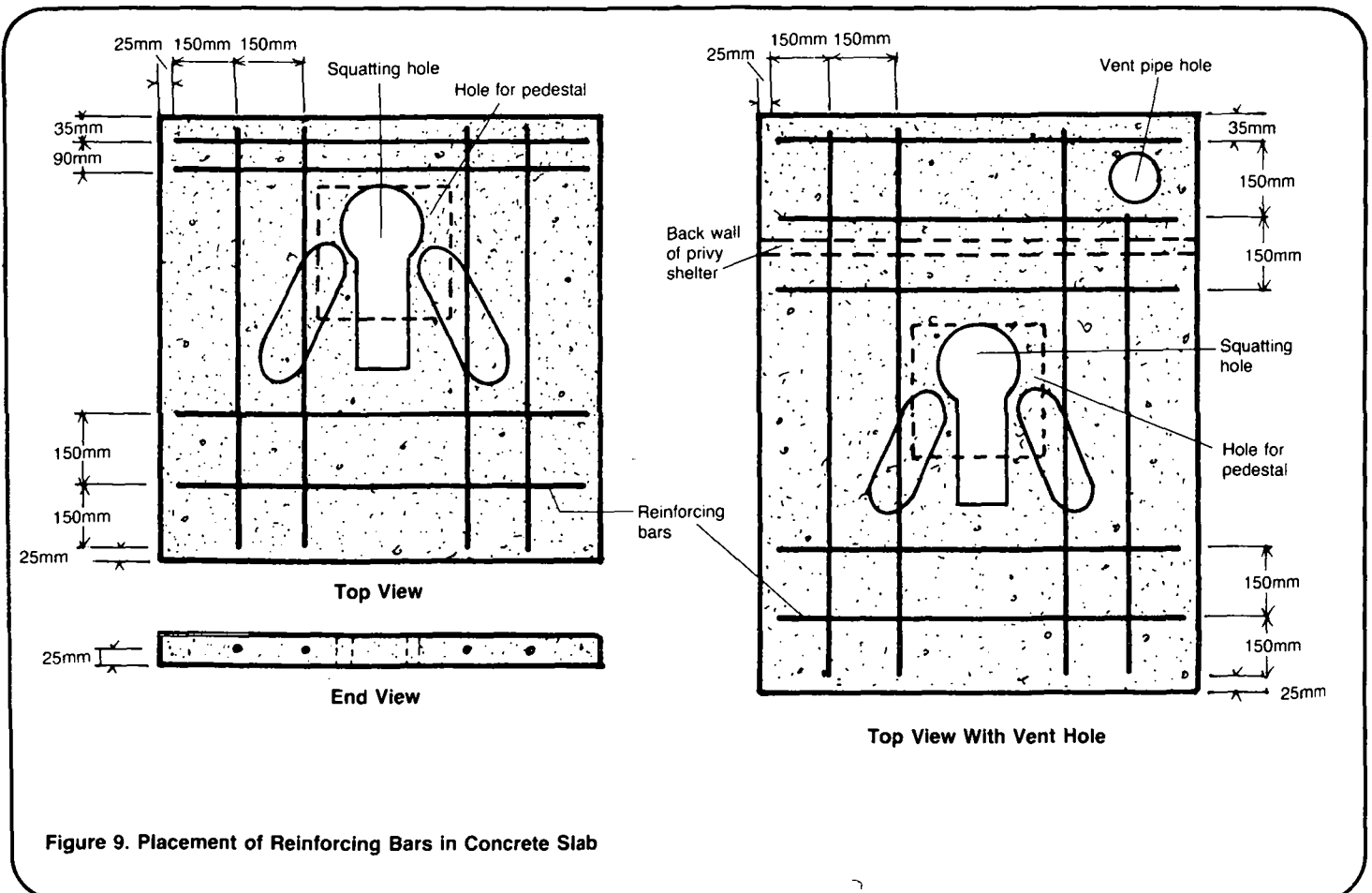


Figure 9. Placement of Reinforcing Bars in Concrete Slab



If the slab has a seat and pedestal, the pedestal can be made from brick, concrete blocks, or wood, and the seat can be made from wood. One-piece, ceramic seat-and-pedestal units may be available.

A cover made from wood should be provided for both sitting-type and squatting-type slabs. The cover for the seat and pedestal may be attached to the back of the seat with hinges.

A pour-flush bowl may be made from galvanized metal, concrete, molded rubber, or ceramic material. These units may be prefabricated and ready to install. A skilled craftsman could produce a galvanized metal or concrete pour-flush bowl using the design information in Figure 6. A metal bowl must have smooth, rounded edges dulled by a file. A concrete bowl must be cured in water for a week. A pour-flush bowl can be secured to the slab with concrete mortar.

A vent pipe can be made of galvanized metal by a semi-skilled workman using tinsnips, pliers, metal screws

and a screw driver (or other means of securing the metal), and black paint and a brush to paint the pipe black. Or, a section of bamboo with the nodes knocked out could be used as a vent pipe.

A chute for an off-set pit can be made of galvanized metal by a semi-skilled workman using tinsnips, pliers, metal screws and a screwdriver, or other means of securing the metal.

A cover for an off-set pit can be made from wood, metal, or reinforced concrete. If concrete is used, the tools and skills of the workmen are the same as for a concrete slab.

When the materials needed have been determined, prepare a detailed materials list, similar to the sample in Table 1, showing types and quantities of all materials, tools, and labor needed to construct the slab and improvements, and the estimated costs based on local prices. Give the materials list and design drawings, similar to Figures 1-9, to the person in charge of construction.

**Table 1. Sample Materials List**

ITEM	DESCRIPTION	QUANTITY	ESTIMATED COST
Labor	Foreman	1	_____
	Laborer (some experience with concrete)	1	_____
	Laborers (to move constructed slab)	4-6	_____
Supplies	Portland cement	_____ m <sup>3</sup>	_____
	Sand: Clean, size fine to 6mm	_____ m <sup>3</sup>	_____
	Gravel: Clean, size 6-38mm	_____ m <sup>3</sup>	_____
	Water: Clear, drinking water preferred	_____ liters	_____
	Wood (for concrete forms)	_____	_____
	Nails (for concrete forms)	_____	_____
	Reinforcing bars _____mm long	_____	_____
	_____mm long	_____	_____
	(or wire mesh)	_____ m <sup>2</sup>	_____
	Wood (for lid)	_____	_____
	-----		
	If seat and pedestal:		
	Bricks (for pedestal)	_____	_____
	Mortar (cement, sand, water)	_____ m <sup>3</sup>	_____
Wood (for seat and lid)	_____	_____	
-----			
Pour-flush bowl (prefabricated)	_____	_____	
Galvanized metal (for vent pipe)	_____ m <sup>2</sup>	_____	
Galvanized metal (for chute)	_____ m <sup>2</sup>	_____	
Metal screws or bands	_____	_____	
Screen (for vent)	_____	_____	
Tools	Measuring tape	1	_____
	Shovel	2	_____
	Bucket	1	_____
	Container for mixing concrete	1	_____
	Trowel	1	_____
	Saw	1	_____
	Hammer	1	_____
	Tinsnips	1	_____
	Pliers	1	_____
	Screwdriver	1	_____
	Other	_____	_____

Total Estimated Cost = \_\_\_\_\_

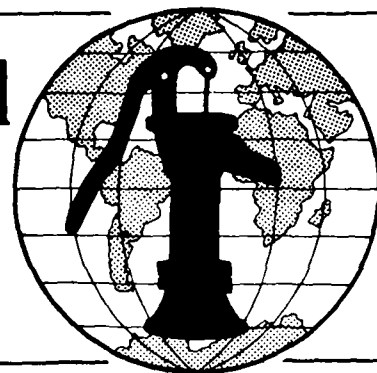
## Notes

## Notes

## Notes

**Technical Notes** are part of a set of "Water for the World" materials produced under contract to the U.S. Agency for International Development by National Demonstration Water Project, Institute for Rural Water, and National Environmental Health Association. Artwork was done by Redwing Art Service. Technical Notes are intended to provide assistance to a broad range of people with field responsibility for village water supply and sanitation projects in the developing nations. For more detail on the purpose, organization and suggestions for use of Technical Notes, see the introductory Note in the series, titled "Using 'Water for the World' Technical Notes." Other parts of the "Water for the World" series include a comprehensive Program Manual and several Policy Perspectives. Further information on these materials may be obtained from the Development Information Center, Agency for International Development, Washington, D.C., 20523, U.S.A.

# Water for the World



## Designing Pits for Privies Technical Note No. SAN. 1.D.2.

Designing a pit for a privy involves selecting its location, calculating its size, and determining the labor, materials, and tools needed for construction. The products of the design process are: (1) a location map, (2) technical drawings of the pit, (3) sketches of the pit lining, if needed, and base for the slab, and (4) a materials list. These products should be given to the construction supervisor before construction begins.

This technical note describes how to design a pit and arrive at these three end-products. Read the entire technical note before beginning the design process.

### Useful Definitions

**DECOMPOSE** - To decay and become reduced in volume due to bacterial action; this happens to excreta in a pit.

**IMPERVIOUS** - Not allowing liquid to pass through.

**PERMEABLE** - Allowing liquid to soak in.

### Materials Needed

**Measuring tape** - To obtain accurate field information for a location map.

**Ruler** - To draw a location map.

### Location

The major factors in selecting a location for a privy are: (1) location of water supplies, dwellings, and property lines, (2) soil type, (3) ground-water levels, and (4) impervious layers.

Location of Water Supplies, Dwellings, and Property Lines. A pit privy should be downhill from water wells. It should be at least:

20m from the nearest well or stream,  
6m from the nearest dwelling,  
3m from the nearest property line.

For the sake of convenience, the privy should be no farther than 30m from the building to be served. It should be on fairly level ground. When a proposed site has been selected, determine the soil type.

Soil Type. A pit should be dug in permeable soil so the liquid part of the excreta can soak into the ground. The rate at which liquid soaks in depends on the type of soil. If the rate is too fast or too slow, the soil is not suitable for a pit. The main types of soil are sand, sandy loam, loam, silt loam, clay loam, and clay. For a detailed description of soil types see "Determining Soil Suitability," SAN.2.P.4.

When the soil at the pit site has been identified, use the following chart to determine its suitability.

Table 1. Soil Suitability

Soil Type	Suitability
Sand	No
Sandy Loam	Yes
Loam	Yes
Silt Loam	Yes
Clay Loam	No
Clay	No

If the soil is not suitable, select another location for the pit. If no good location can be found, design an alternative excreta disposal system (see "Simple Methods of Excreta Disposal," SAN.1.M.1). If the soil is suitable, proceed to the next step.

**Groundwater Levels.** The bottom of the pit must be at least 1m above the groundwater level during the wettest season of the year. This information may be available from local residents, water well owners, or water well drillers. If the information is not available or reliable, field tests must be made. These tests are described in detail in "Determining Soil Suitability," SAN.2.P.4. In brief, a hole must be dug 1m deeper than the proposed pit. Dig the test hole during the wettest season. If no groundwater is observed, groundwater levels are suitable.

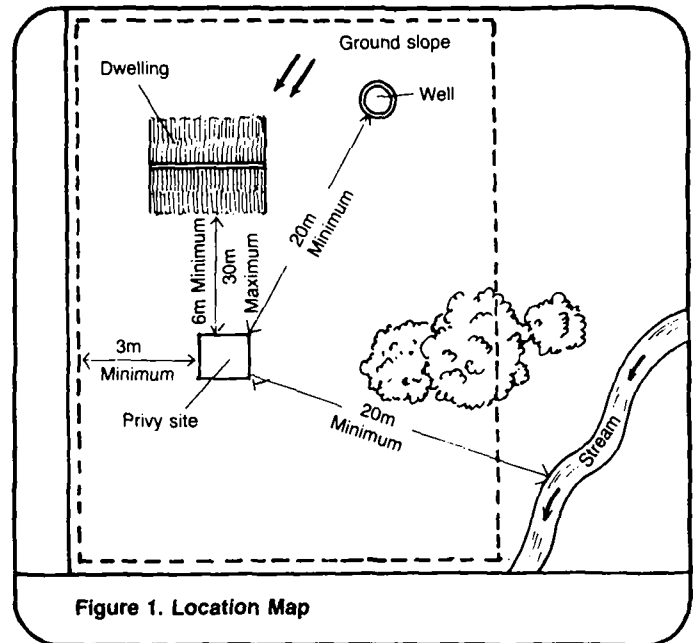
If groundwater levels are not suitable, select another location for the pit. If no acceptable location can be found, design an alternative excreta disposal system (see "Simple Methods of Excreta Disposal," SAN.1.M.1).

**Impervious Layers.** The bottom of a pit must be at least 1m above impervious layers such as creviced rock, hardpan, shale, or clay. The same test hole dug for determining groundwater levels can be used to check for impervious layers. If there are impervious layers in the test hole, the site is unacceptable for a pit and a new site must be found. If no suitable site can be found, design an alternative excreta disposal system (see "Simple Methods of Excreta Disposal," SAN.1.M.1).

When a suitable site has been found, draw a location map similar to Figure 1, showing the pit site and distances to water supplies, streams, dwellings, property lines, and any other nearby structures or prominent geographical features.

### Determining Pit Size

To determine the length, width and depth of a pit, first calculate the capacity. The capacity, or volume, of a pit is determined by the number of users of the privy, the number of years



the pit is expected to last, whether the privy will have a pour-flush bowl, and the type of anal cleansing material used. Worksheet A shows a sample calculation of the size of a pit.

The number of users equals the number of persons living in or using the building to be served (Worksheet A, Line 1).

The pit should be designed to last 5 to 10 years, preferably 10 (Worksheet A, Line 2).

If the privy will have a pour-flush bowl, the pit can be smaller because the water used to flush the bowl will cause the excreta in the pit to decompose more rapidly (Worksheet A, Line 4).

The capacity of the pit is calculated as follows:

For a pit without a pour-flush: number of persons times number of years times 0.06 equals volume in cubic meters (Worksheet A, Line 5).

For a pit with a pour-flush: number of persons times number of years times 0.04 equals volume in cubic meters (Worksheet A, Line 6).

## Worksheet A. Calculations for Privy Pit, Lining, and Base

### Capacity of Pit

1. Number of users = 6
2. Designed life of pit in years = 8
3. Line 1 x Line 2 = 48
4. Is there a pour-flush bowl?  no  yes
5. If "no," then Line 3 x 0.06 = 2.8 m<sup>3</sup>
6. If "yes," then Line 3 x 0.04 = \_\_\_\_\_ m<sup>3</sup>
7. Do anal cleansing materials readily decompose?  yes  no
8. If "yes," then capacity = Line 5 (or Line 6) = 2.8 m<sup>3</sup>
9. If "no," then capacity = 1.5 x (Line 5 or Line 6) = \_\_\_\_\_ m<sup>3</sup>

### Dimensions of Pit

10. Capacity (from Line 8 or Line 9) = 2.8 m<sup>3</sup>
11. Pit is for (check one):  pit privy  ventilated pit privy  
 offset pit privy
12. Width (from Table 2) = 1.1 m
13. Length (from Table 2) = 1.2 m
14. Line 12 x Line 13 = 1.32 m<sup>2</sup>
15. Depth =  $\frac{\text{Line 10}}{\text{Line 14}}$  = 2.1 m

### Quantity of Lining Material (area of pit walls)

16. 2 x Line 12 = 2.2 m
17. 2 x Line 13 = 2.4 m
18. Line 16 + Line 17 = 4.6 m
19. Area of walls = Line 15 x Line 18 = 9.7 m<sup>2</sup>

### Distance Around Pit (periphery)

20. Periphery = Line 16 + Line 17 = 4.6 m

### Volume of Poured Concrete Base

21. Width of base = 0.15 m
22. Thickness of base = 0.05 m
23. Volume = Line 20 x Line 21 x Line 22 = 0.03 m<sup>3</sup>

### Lengths for Wood or Log Base

24. Line 12 + 1.0m = 2.1 m
25. Line 13 + 1.0m = 2.1 m
26. Lengths of the four logs or wood beams:

- (1) Line 24 = 2.1 m
- (2) Line 24 = 2.1 m
- (3) Line 25 = 2.2 m
- (4) Line 25 = 2.2 m

LIBRARY  
INTERNATIONAL REFERENCE CENTER  
FOR COMMUNITY WATER SUPPLY AND  
SANITATION (IRC)

**Example 1.** Suppose a pit privy without a pour-flush is being designed for a family of six and is to last eight years. Then the capacity of the pit equals:

$$6 \times 8 \times 0.06 = 2.8 \text{ cubic meters} \\ \text{(Worksheet A, Lines 1-5).}$$

**Example 2.** Suppose a pit privy with a pour-flush is being designed for a family of six for eight years. Then the capacity of the pit equals:

$$6 \times 8 \times 0.04 = 1.9 \text{ cubic meters} \\ \text{(Worksheet A, Lines 1-6).}$$

If anal cleansing materials that do not readily decompose such as grass, leaves, corncobs or mudballs are used, the capacity of the pit should be multiplied by 1.5 (Worksheet A, Line 7). For example, if the capacity of the pit was calculated to be 3.0 cubic meters and corncobs are the usual anal cleansing material, the required capacity of the pit is:

$$3.0\text{m}^3 \times 1.5 = 4.5 \text{ cubic meters} \\ \text{(Worksheet A, Line 9).}$$

When the capacity has been calculated, determine the dimensions of the pit. First, find the length and width. They depend on the type of slab and shelter being used (see "Designing Slabs for Privies," SAN.1.D.1 and "Designing Privy Shelters," SAN.1.D.3).

In general, a pit for a privy is square and is directly beneath the slab and shelter. A pit for a ventilated pit privy is either slightly offset or slightly longer than it is wide to accommodate the vent pipe. A pit for an offset pit privy is longer than it is wide and larger than a pit that is not offset.

(NOTE: A pour-flush bowl is generally used with a ventilated pit privy or an offset pit privy.)

Table 2 shows the general width and length and the minimum depth of the pit for each type of privy.

Determine the correct depth by dividing the design capacity by the width times the length (Worksheet A, Lines 10-15).

**Table 2. Privy Type and Pit Dimensions**

Privy Type	Pit Dimensions		
	Width	Length	Depth
Pit Privy	1.0-1.2m	1.0-1.2m	at least 1.5m
Ventilated Pit	1.0-1.2m	1.1-1.5m	at least 1.5m
Offset Pit	1.0-1.2m	1.5-2.0m	at least 3.0m

For example, calculate the correct depth of a ventilated privy with a capacity of 2.8 cubic meters, a width of 1.1 meters, and a length of 1.2 meters.

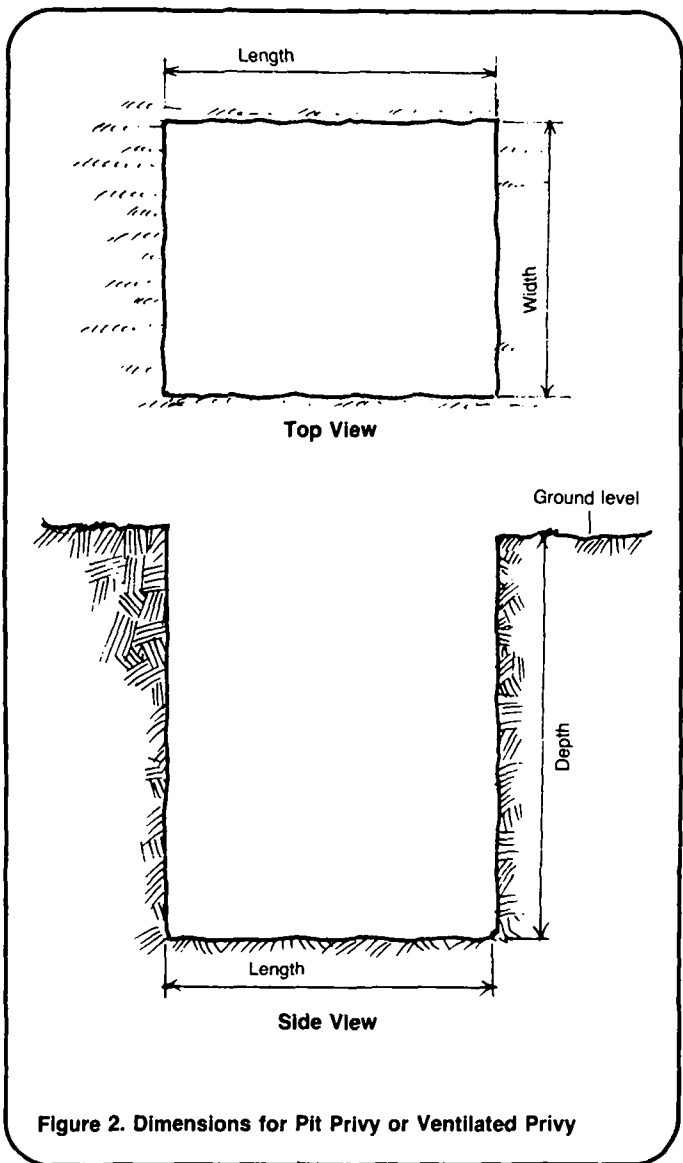
$$\text{depth} = \frac{2.8\text{m}^3}{1.1\text{m} \times 1.2\text{m}} \\ = \frac{2.8\text{m}^3}{1.32\text{m}} \\ = 2.1\text{m}$$

For pits 2.5-3.5m deep, add 0.15m to the length and 0.15m to the width to accommodate a step or ledge left in the walls during construction. For safety reasons, do not design a pit to be dug by hand deeper than 3.5m.

When the dimensions of the pit have been determined, make a technical drawing similar to Figure 2 showing length, width, and depth. For an offset pit privy, which requires a chute from the squatting slab to the pit, make a drawing similar to Figure 3 showing length, width, and depth of pit, and excavation for the chute. Give these drawings to the construction supervisor.

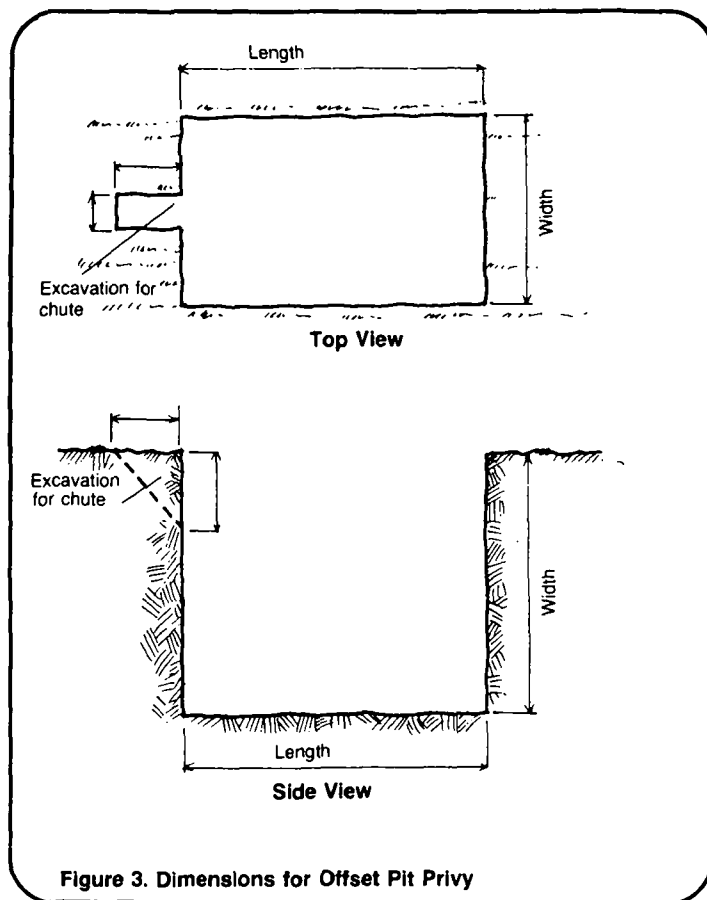
If the soil is such that the walls of the pit will not stand on their own in both the wet and dry seasons, the pit must have a lining. All pits need a base to support the slab (see "Designing Slabs for Privies," SAN.1.D.1).





The lining can be made of bamboo, logs, poles, boards, bricks, concrete blocks, or select field stones. Whatever material is used, it must have slits or open spaces to allow the liquid part of excreta to pass through to the soil. For an offset pit privy, a space must be left in the lining to allow for the chute.

Prepare a sketch similar to one of those in Figure 4 showing the lining material and a sketch similar to one of those in Figure 5 showing the materials to be used for the base, and give both of them to the construction supervisor.



### Caution!

Before the pit is excavated, design and construct the slab or, if it is an offset pit, the cover (see "Designing Slabs for Privies," SAN.1.D.1 and "Constructing Slabs for Privies," SAN.1.C.1). This is necessary so that when the pit is constructed, it can be covered immediately. A pit left open and unattended is a serious hazard. Whenever workers leave the site, they should cover the pit with the slab.

### Materials List

Prepare a materials list similar to Table 3, showing labor requirements, types and quantities of materials and tools, and the estimated funds needed to construct the pit, including lining and base. This technical note provides the means of determining some quantities. The remaining quantities will have to be determined by you as the project designer or by the construction supervisor.

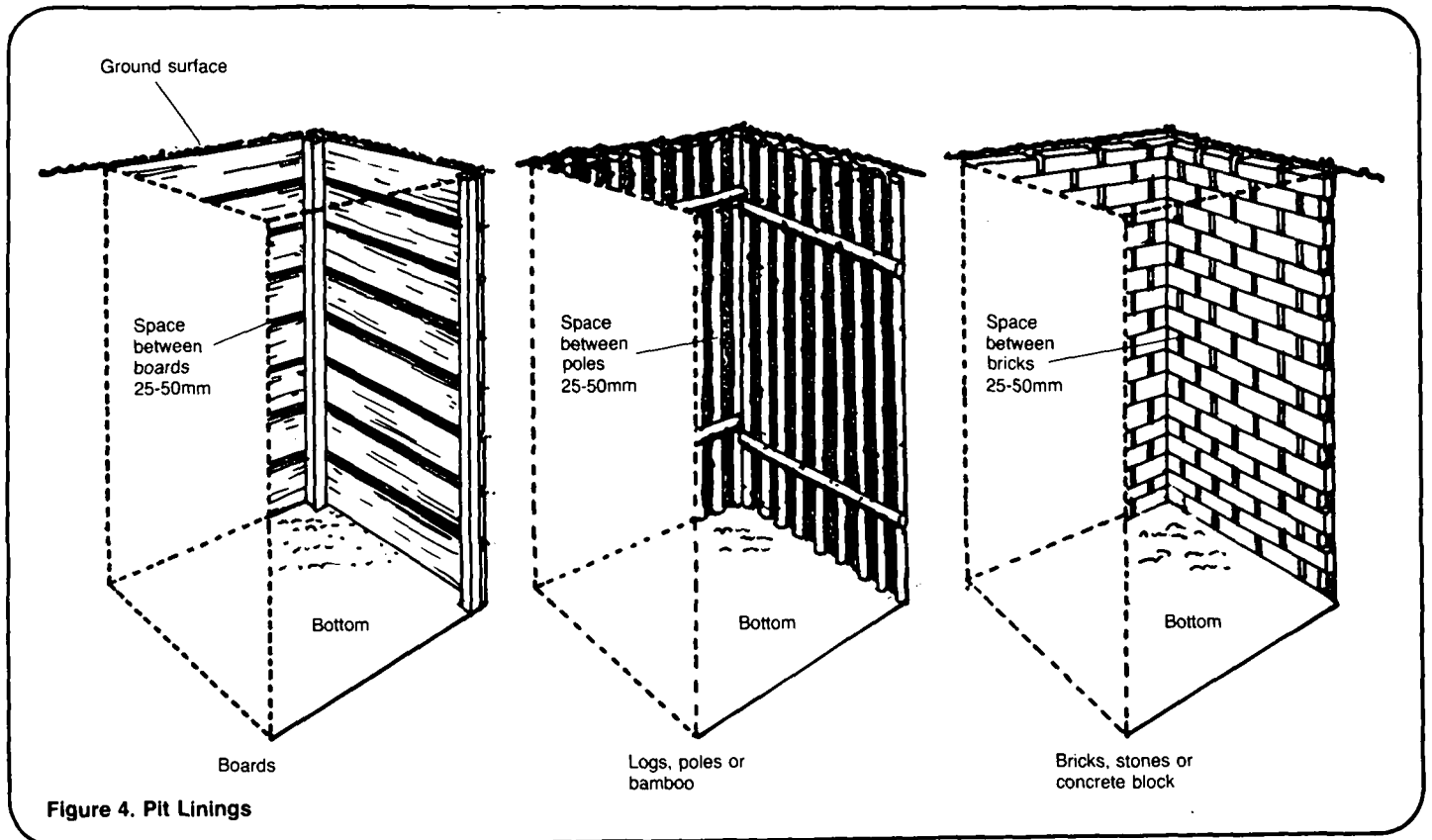


Figure 4. Pit Linings

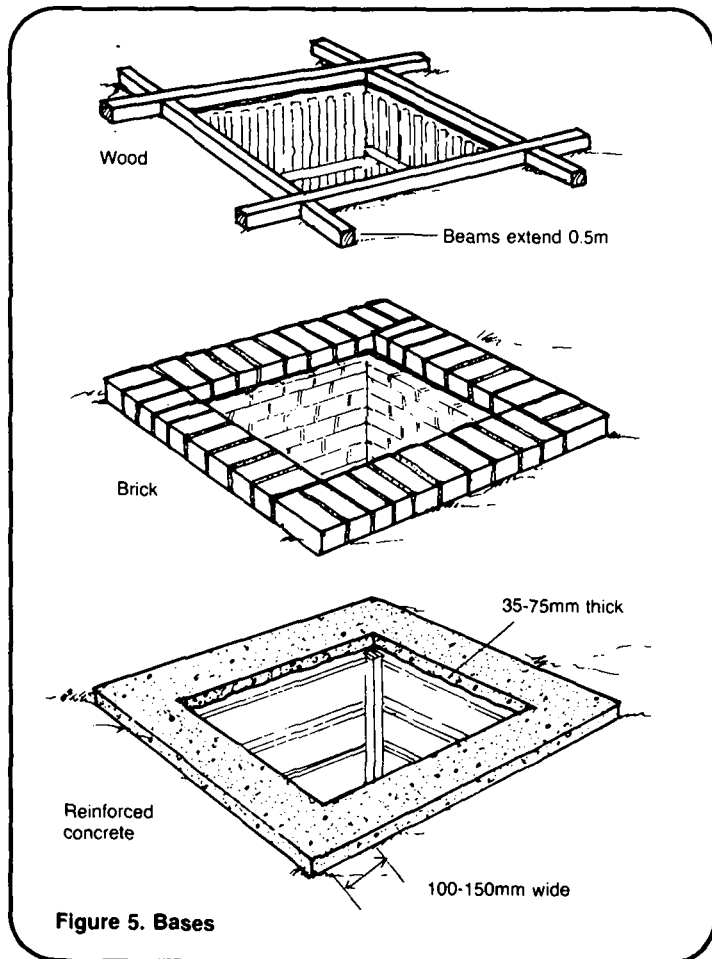


Figure 5. Bases

**Labor.** Ideally, there should be at least two laborers to dig the pit. If the pit lining or base is wood, one worker should have some carpentry skills; if the lining or base is brick or concrete block, one worker should have some masonry skills; if the base is poured concrete, one worker should have some concrete skills. If this number of laborers is not available, you can certainly make do with fewer. The person in charge of construction should be present during all stages of construction.

**Lining.** The material used for the lining, if needed, can be bamboo, logs, poles, boards, bricks, concrete blocks, or select field stones. Use a material that is readily available and that laborers are familiar with. The quantity depends on the type of material and the size of the pit. One way to estimate the quantity is to calculate the area of the pit walls, since the lining must cover nearly the entire wall area except for the spaces between the boards, poles, or bricks.

**Table 3. Sample Materials List**

Item	Description	Quantity	Estimated Cost
Labor	Foreman	1	_____
	Laborers (one experienced with carpentry, stone masonry, or poured concrete, whichever applies)	2 (at least)	_____
Supplies	For laying out the system: wooden stakes or sticks	_____	_____
	For the lining: bamboo, poles, logs, boards, bricks, concrete blocks, select field stones	_____	_____
	For the base: wood, bricks, concrete blocks	_____	_____
	For poured concrete or mortar:		
	Cement	_____	_____
	Sand	_____	_____
	Gravel	_____	_____
	Water	_____	_____
Other	_____	_____	
Tools and Equipment	Box or bucket	1	_____
	Sturdy rope or ladder	1	_____
	Measuring tape	1	_____
	Shovels	2 (at least)	_____
	Wheelbarrow	1	_____
	Hammer	1	_____
	Saw	1	_____
	Nails	--	_____
	Trowel	1	_____
	Plumb line (string and rock)	1	_____
	Hatchet or machete	1	_____
	Container (for mixing mortar)	1	_____
	Concrete slab	1	_____
Other	--	_____	

Total Estimated Cost = \_\_\_\_\_

The area of the pit walls equals two times the width plus two times the length multiplied by the depth (Worksheet A, Lines 16-19).

For example, suppose a pit is 1.1 meters wide, 1.2 meters long, and 2.1 meters deep. Then the area equals:

$$\begin{aligned} & (2 \times 1.1) + (2 \times 1.2) \times 2.1 \\ & = (2.2 + 2.4) \times 2.1 \\ & = 4.6 \times 2.1 \\ & = 9.7\text{m}^2 \end{aligned}$$

The lining material must cover an area equal to about 9.7 square meters.

**Base.** The material used for the base can be wood, bricks, concrete blocks, or poured concrete. Use a material that is readily available and that the laborers are familiar with. Figure 5 shows three different types of bases.

(NOTE: A wood base may not last as long as a brick, concrete block, or poured concrete base.)

The quantity depends on the type of material and the size of the pit. One way to estimate the quantity for a brick, concrete block, or poured concrete base is to calculate the distance around the top of the pit. This distance is called the periphery; it is equal to twice the length plus twice the width (Worksheet A, Line 20).

For a base made of bricks or concrete blocks, there must be a sufficient quantity to place the bricks or blocks side by side for a distance equal to the periphery of the pit.

For example, suppose a brick base is needed for a pit 1.1 meters wide and 1.3 meters long. Then the periphery equals:

$$\begin{aligned} & (2 \times 1.1) + (2 \times 1.3) \\ & = 2.2 + 2.4 \\ & = 4.6\text{m} \end{aligned}$$

There must be enough bricks to be placed side by side around a periphery of 4.6 meters.

For a poured concrete base, the quantity of poured concrete is equal to the periphery of the pit times the width of the base times the thickness of the base (Worksheet A, Lines 21-23).

For example, suppose a concrete base 0.15 meters wide and 0.05 meters thick is needed for a pit with a periphery of 4.6 meters. Then the quantity of concrete equals:

$$4.6\text{m} \times 0.15\text{m} \times 0.05\text{m} \\ = 0.03\text{m}^3$$

For a wood base, four logs or sturdy wooden beams are needed, one for each side of the pit. Each log should be 1 meter longer than the side of the pit on which it will be laid, as shown in Figure 5 (Worksheet A, Lines 24-26). For example, suppose a wood base is needed for a pit that is 1.2 meters wide and 1.3 meters long. Then the lengths of the four logs would be:

$$(1.2+1.0), (1.2+1.0), (1.3+1.0), (1.3+1.0) \\ = 2.2\text{m}, 2.2\text{m}, 2.3\text{m}, 2.3\text{m}.$$

Tools. The tools required will vary according to the type of pit lining and base. All types of pits require at least two shovels (one per laborer) or other digging implements. A wheelbarrow is useful for carting away excavated dirt and for bringing other material to the pit site. A saw and nails are needed if the lining or base is made of wood, logs or boards. If the lining or base is made of bricks or concrete blocks, or the base is made of poured concrete, a container for mixing the concrete or mor-

tar and a trowel for applying and smoothing concrete or mortar are needed.

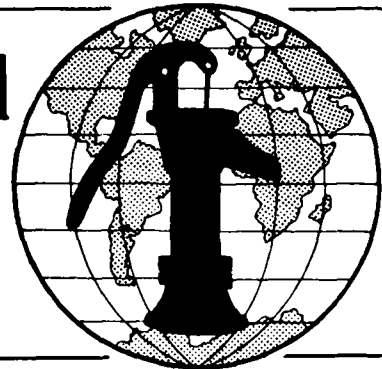
Also needed are a measuring tape to help determine the exact location of the pit, and wooden stakes or sticks to lay it out on the ground. A plumb line (long string with a rock tied to the end) will be useful to ensure that the pit walls are dug vertically. A sturdy rope or ladder should be available for the laborers to get into and out of the pit.

Cost. The cost of the pit depends on a number of variables: which materials are available and which must be purchased; how much labor will be volunteered and how much must be paid for; prices and wage rates; and so on. Make your best estimate based on local conditions.

When all calculations, determinations, and estimates have been made, prepare a materials list similar to Table 3, and give it to the construction supervisor. In summary, give the construction supervisor: (1) a location map similar to Figure 1, showing the location of the pit in relation to all nearby structures and geographical features; (2) a technical drawing similar to either Figure 2 or Figure 3, depending on the type of pit privy, showing correct dimensions of the pit; (3) sketches similar to those in Figure 4 and Figure 5, showing the general configuration of the pit lining and base; and (4) a materials list similar to Table 3 showing the labor, materials, tools, and money needed to construct the pit, lining, and base.

**Technical Notes** are part of a set of "Water for the World" materials produced under contract to the U.S. Agency for International Development by National Demonstration Water Project, Institute for Rural Water, and National Environmental Health Association. Artwork was done by Redwing Art Service. Technical Notes are intended to provide assistance to a broad range of people with field responsibility for village water supply and sanitation projects in the developing nations. For more detail on the purpose, organization and suggestions for use of Technical Notes, see the introductory Note in the series, titled "Using 'Water for the World' Technical Notes." Other parts of the "Water for the World" series include a comprehensive Program Manual and several Policy Perspectives. Further information on these materials may be obtained from the Development Information Center, Agency for International Development, Washington, D.C., 20523, U.S.A.

# Water for the World



## Designing Privy Shelters Technical Note No. SAN 1.D.3

A privy shelter is a screen or structure that gives the person using the privy privacy. Depending on the design, a shelter can protect the privy and the user from the weather and keep out flies, rats, scavenging dogs, and other pests. Designing a shelter involves selecting the type of shelter; determining shape, size, and special features; and selecting materials, tools, and labor. The products of the design process are (1) a plan view of the shelter; (2) a detailed view of any special features; and (3) a detailed materials list. This technical note describes how to design a privy shelter and produce these three products.

Read the entire technical note before beginning design procedures.

### Materials Needed

Measuring tape - To obtain field measurements.

Scale - To draw accurate diagrams.

### Selecting the Type of Shelter

The three basic types of privy shelters are a simple screen, a shelter with a roof, and a shelter with a roof and door. Figures 1, 2 and 3 show the types of privy shelters.

The most important factors in selecting a type of shelter are local customs and personal preferences of the users. Determine how much privacy people want and whether or not a roof and door are acceptable or desired. Other factors that influence selection are available money, materials, and skilled labor, and the extent to which control of pests is important. Table 1 compares these factors for each type of shelter.

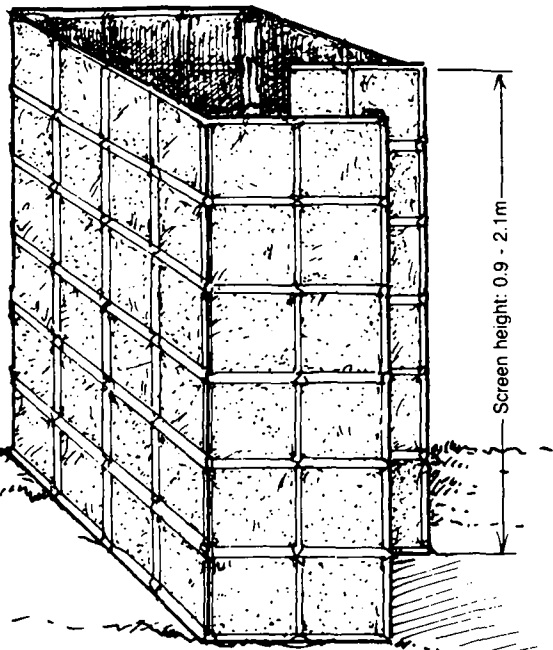
### Determining Shape, Size, and Special Features

Shape. The shelter can be square, rectangular, circular, or spiral-shaped, as shown in Figures 1 and 2,

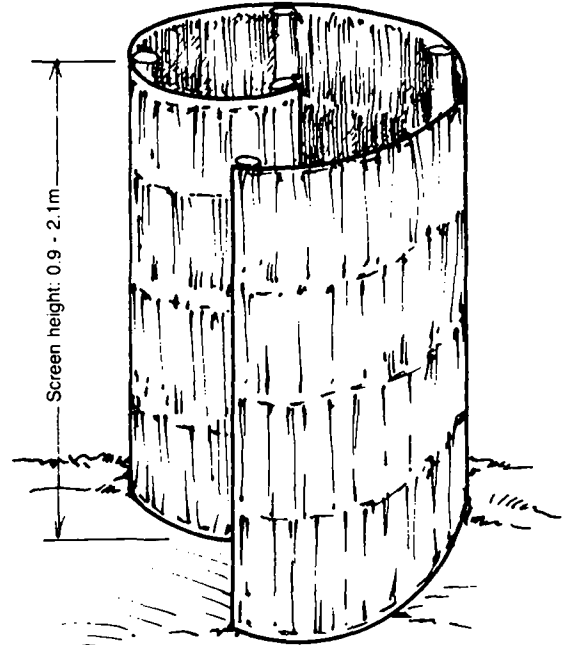
Table 1. Comparison of Shelter Types

Shelter Type	Advantages	Disadvantages
Simple Screen	User privacy; very inexpensive and easy to build	No protection from weather; not suitable for ventilated privy, compost toilet, bucket latrine, or aqua privy; no pest control*
With Roof	User privacy; suitable for all privies; protection from weather	Slightly more expensive; some construction skills needed; no pest control*
Roof and Door	Complete user privacy; suitable for all privies; protection from weather; pest control*	Moderately expensive; construction skills required

\*All privies must have a lid for the hole. This keeps pests out of the pit, but not out of the shelter.



RECTANGULAR (Wattle and Daub)



SPIRAL (Palm Thatch)

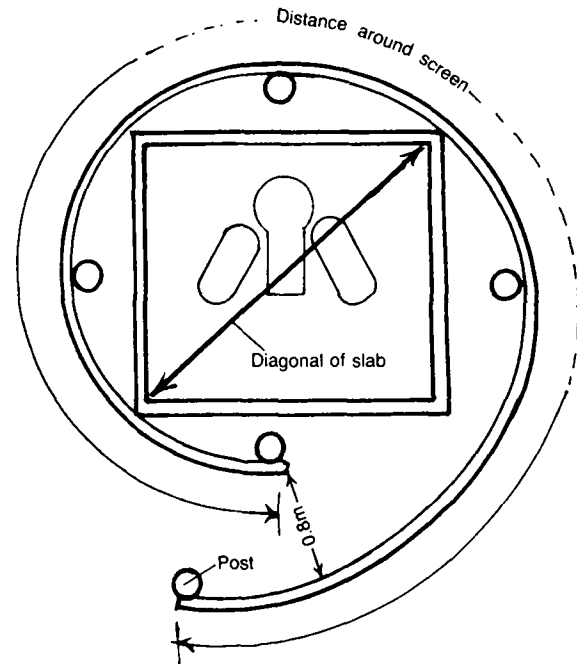
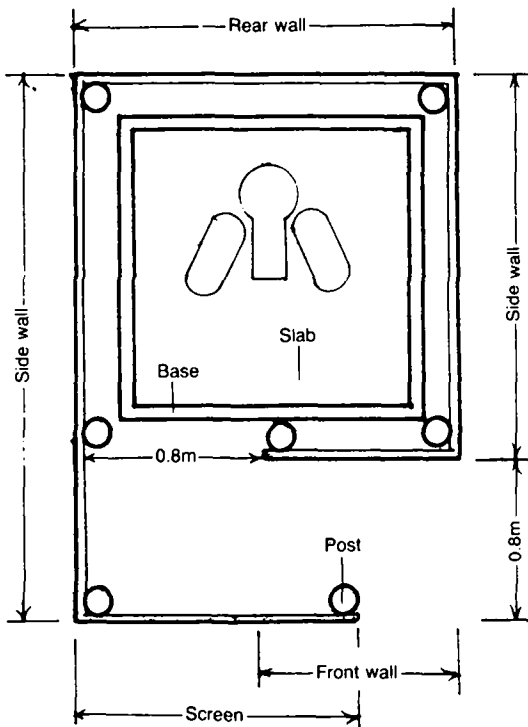
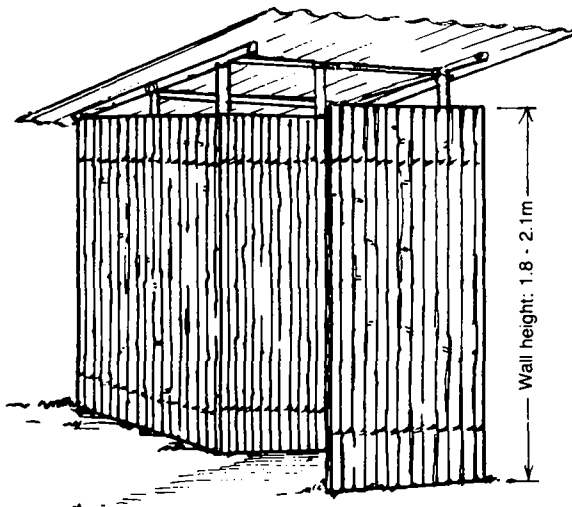


Figure 1. Simple Screen Shelters

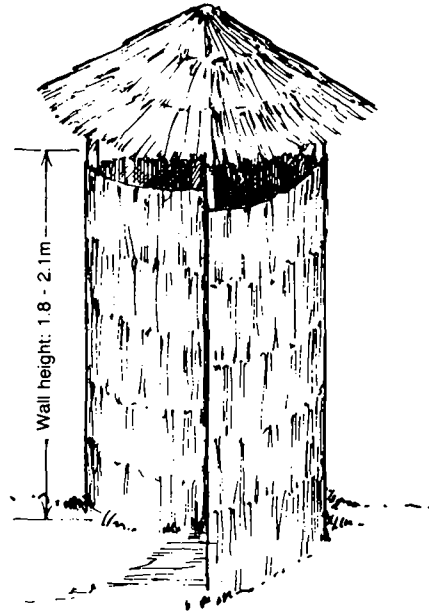
depending on local preference. The screen or walls should be vertical. The roof should slope to the rear or sides of the shelter to allow rainwater to run off.

Size. The area inside the shelter should be 1.0-2.3m<sup>2</sup>. This allows enough room for the user without

wasting building materials. Unless the privy is ventilated with a vent pipe, the shelter should completely enclose the privy slab. For a ventilated privy, the part of the slab that holds the vent pipe will be outside the shelter, as shown in Figure 4. The back wall of the shelter should be 150-200mm from the defecation hole.



BAMBOO SHELTER WITH CORRUGATED METAL ROOF



PALM THATCH SHELTER AND ROOF

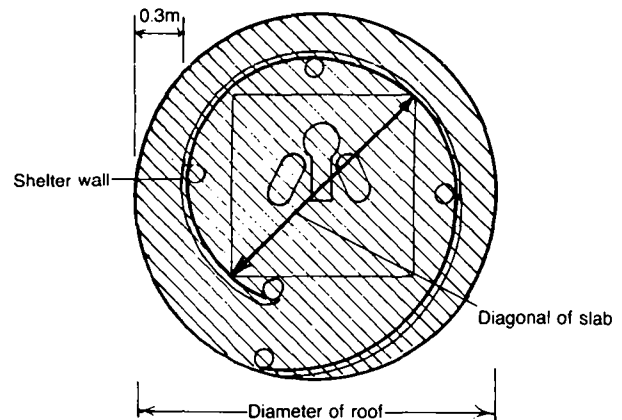
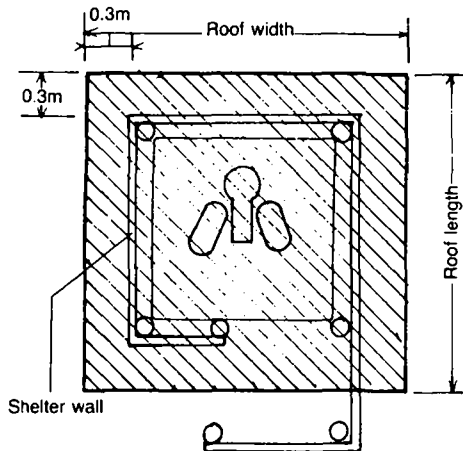


Figure 2. Privy Shelters with Roof

The shelter can be designed to rest on the base around the pit with the walls bordering the slab. With this design, the size of the slab determines the area within the shelter.

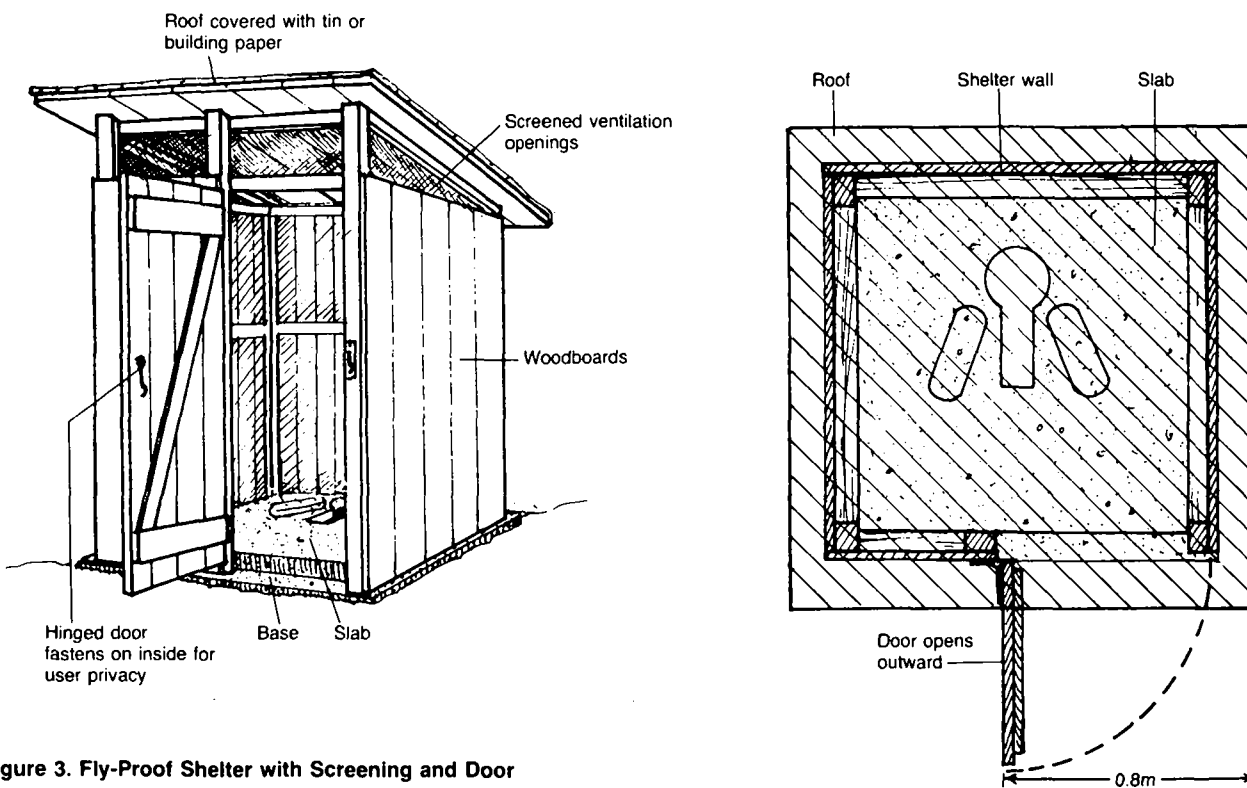
If the shelter is a simple screen with no roof, the bottom of the screen should touch the ground. The screen can be 1-2m high. If the shelter has a roof, the walls should be 1.8-2.1m high to allow enough headroom. The walls should rest on the ground.

Table 2 summarizes some requirements for a shelter.

**Special Features.** If the shelter has a roof, it should also have ventilation openings. The openings should be at least 100mm by 200mm and spaced along the top of the walls. One design has the entire roof raised above the walls on the corner posts, as shown in Figures 2 and 3.

**Table 2. Shelter Requirements**

Feature	Requirement
Walls	Vertical; touch ground
Wall Height (simple screen)	1-2m
Wall Height (with roof)	1.8-2.1m
Rear Wall	150-200mm from defecation hole
Roof	Sloped to rear or sides
Area in Shelter	1.0-2.3m <sup>2</sup>



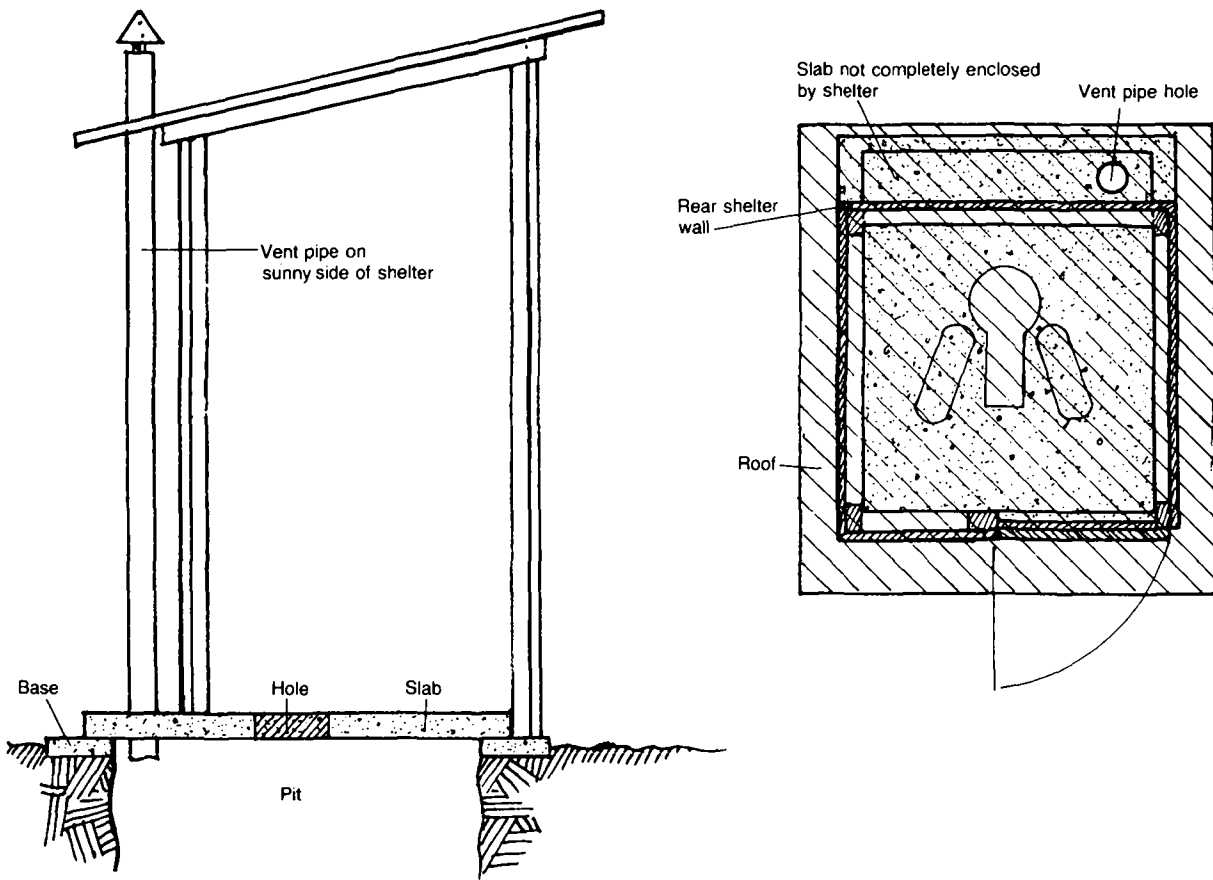
**Figure 3. Fly-Proof Shelter with Screening and Door**

If the shelter has a door, it must have sturdy hinges to keep the door in the correct position. An inside latch is needed to keep the door closed when the privy is in use. Figure 5 shows a well-designed privy door. The door may open from the right or left, but it should open outward unless this violates local custom. Ventilation openings are required. If pests are to

be kept out of the shelter, screens must cover all ventilation openings and the door must fit tightly, as shown in Figure 6.

If the shelter is for a ventilated privy, the vent pipe must be attached to an outside wall or to the roof, as shown in Figure 4.





4. Shelter for Ventilated Privy

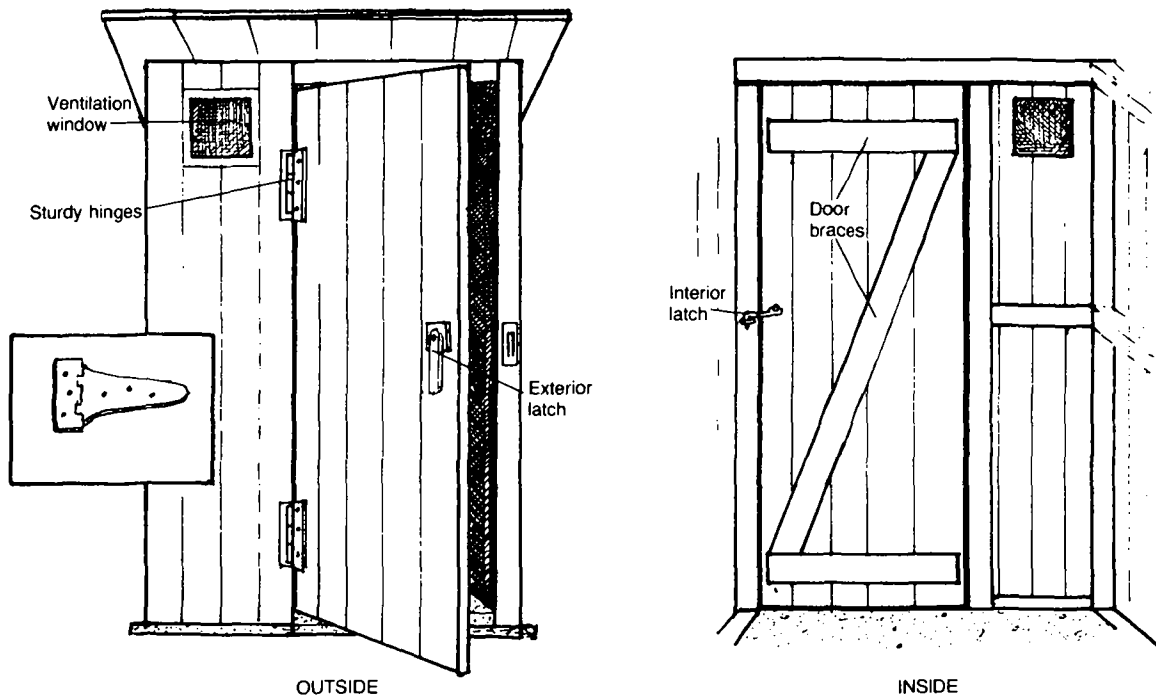


Figure 5. Detail of Door for Fly-Proof Shelter

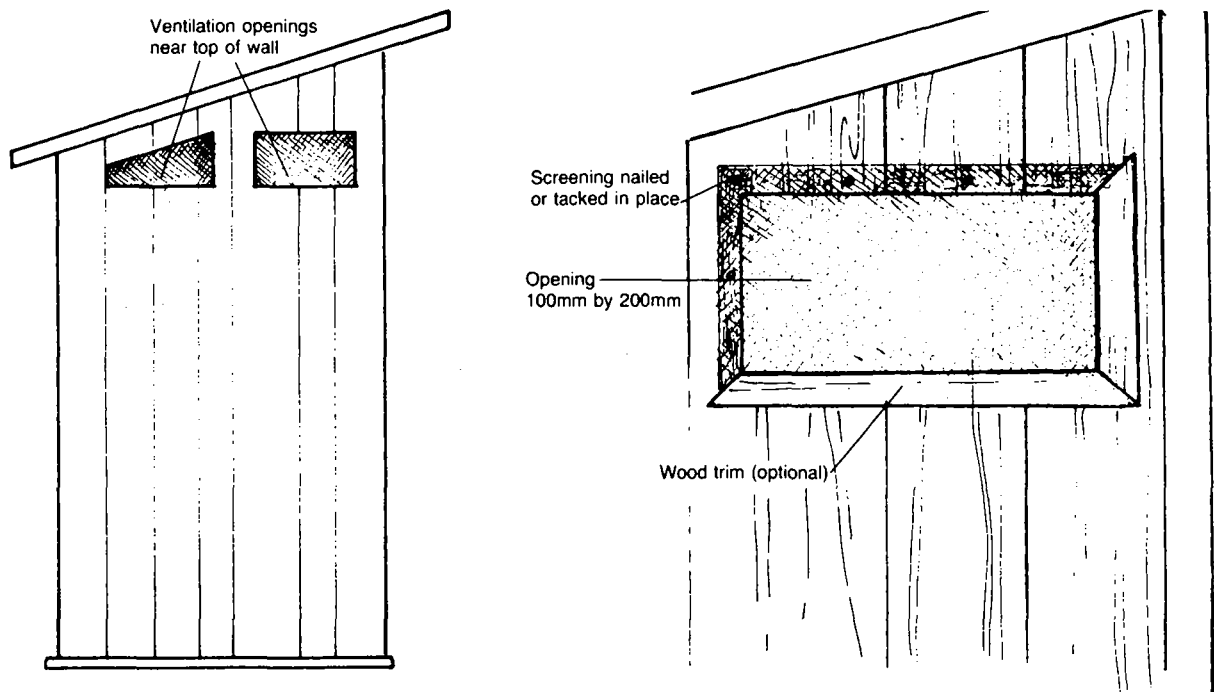


Figure 6. Fly-Proof Screening Covering Ventilation Openings

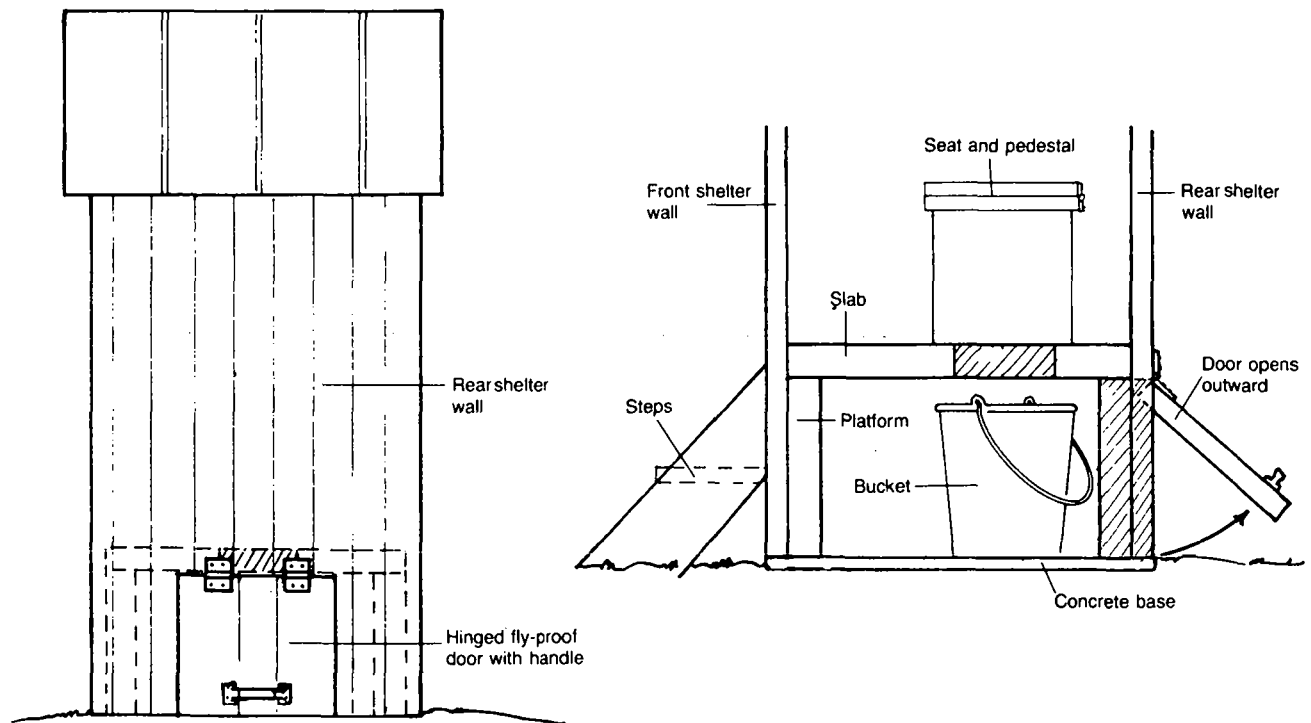


Figure 7. Detail of Shelter for Bucket Latrine

**Table 3. Special Feature Requirements**

Feature	Requirement
Ventilation Openings	At least 100 x 200mm; spaced along top of walls
Screens	Fly-proof; cover <u>all</u> openings
Door	Opens outward; sturdy hinges; inside latch
Vent Pipe	Attached to outside wall or roof
Privy Slab on Platform	Shelter rests on ground

**Table 4. Combinations of Materials for a Shelter**

		Feature		
		Walls	Roof	Door
Materials	Mud and Wattle	Palm Thatch	Mud and Wattle, Palm Thatch, or Bamboo	
	Bamboo	Palm Thatch	Mud and Wattle, Palm Thatch, or Bamboo	
	Palm Thatch	Palm Thatch	Mud and Wattle, Palm Thatch, or Bamboo	
	Wooden Boards	Wooden Boards or Corrugated Metal	Wooden Boards	
	Brick and Mortar or Concrete Block and Mortar	Wooden Boards or Corrugated Metal	Wooden Boards	

If the shelter is for a privy with a platform, such as an off-set pit, compost toilet, or bucket latrine, the walls should rest on the ground and enclose the platform. The height of the platform must be added to the height of the wall shown in Table 2. For a compost toilet or bucket latrine, the rear wall of the shelter must have a small door. It must be fly-proof for a bucket latrine and air-tight for a compost toilet. The door will allow for removal of the bucket or compost. This is shown in Figure 7.

Table 3 summarizes special feature requirements.

When the type of shelter, its shape, size, and special features have been decided, draw a plan view of the shelter showing all dimensions. Also prepare a detailed drawing of any special features. Give these drawings to the construction foreman before construction of the shelter begins.

### Selecting Materials

In general, a privy shelter should be built using locally available materials, tools, and labor. The sturdier the materials, the longer the life of the shelter.

A simple screen shelter can be bamboo, palm thatch, mud and wattle, or poles supporting canvas or fabric. A shelter with a roof, or roof and door, can be built from a variety of materials, some of which are shown in Table 4. The roof should be waterproof.

Depending on the area, termites may be a problem if wood structures are to be used. Special protection, such as a brick or concrete base, may be required to keep wood from coming into contact with the soil and giving termites access to the wood.

### Worksheet A. Calculating Quantities for a Privy Shelter

Shelter Type (check one):  simple screen     roof     roof and door

#### Simple Screen Shelter

1. Height of screen = 1.8 m
2. Length of sides = 0.3 m + 1.2 m + 1.2 m + 2.0 m + 1.2 m = 5.9 m
3. Quantity for screen = Line 1 x Line 2 = 1.8 m x 5.9 m = 10.6 m<sup>2</sup>

---

4. Distance around screen (for circular or spiral screen) = 6.1 m
5. Quantity for circular = Line 1 x Line 4 = 1.8 m x 6.1 m = 11.0 m<sup>2</sup>

---

6. Number of corner posts (or uprights) from drawing = 7
7. Minimum length of posts = Line 1 + 0.3m = 1.8 m + 0.3m = 2.1 m

#### Shelter with Roof

8. Width of shelter + 0.6m = 1.4 m + 0.6m = 2.0 m
9. Length of shelter + 0.6m = 1.5 m + 0.6m = 2.1 m
10. Quantity for roof = Line 8 x Line 10 = 2.0 m x 2.1 m = 4.2 m<sup>2</sup>

---

11. Diagonal of privy slab (measured in field) = 2.0 m
12. Diameter of circular roof = Line 11 + 0.9m = 2.0 m + 0.9m = 2.9 m
13. Quantity for circular roof =  $\frac{\text{Line 12}}{2} \times \frac{\text{Line 12}}{2} \times 3.1 = \frac{2.9}{2} \text{ m} \times \frac{2.9}{2} \text{ m} \times 3.1 = \frac{1.45}{2} \text{ m} \times \frac{1.45}{2} \text{ m} \times 3.1 = \frac{6.5}{2} \text{ m}^2$

---

14. Rear wall = height times width = 1.6 m x 1.4 m = 2.2 m<sup>2</sup>
15. Side wall = height times width = 1.8 m x 1.5 m = 2.7 m<sup>2</sup>
16. Side wall = height times width = 1.8 m x 1.5 m = 2.7 m<sup>2</sup>
17. Front wall = height times width = 2.0 m x 0.6 m = 1.2 m<sup>2</sup>
18. Screening wall = height times width = 2.0 m x 0.8 m = 1.6 m<sup>2</sup>
19. Screening wall = height times width = 2.0 m x 1.4 m = 2.8 m<sup>2</sup>
20. Quantity for shelter walls =  
 Line 14 + Line 15 + Line 16 + Line 17 + Line 18 + Line 19 =  
2.2 m<sup>2</sup> + 2.7 m<sup>2</sup> + 2.7 m<sup>2</sup> + 1.2 m<sup>2</sup> + 1.6 m<sup>2</sup> + 2.8 m<sup>2</sup> = 13.2 m<sup>2</sup>

#### Shelter with Roof and Door

For roof and walls, use Lines 8 through 20.

21. Quantity for door = height times width 1.8 m x 0.9 m = 1.6 m<sup>2</sup>.

## Calculating Quantities of Materials

The quantities of materials needed depend on the type and size of the shelter. Most quantities are calculated in square meters and then converted to material units such as numbers of bricks, numbers of bamboo poles, and numbers and lengths of boards. Other quantities are determined by measurements made on plan view drawings.

Simple Screen Shelter. Materials include screening material and corner posts, or an upright post for a circular or spiral screen. Calculate the amount of screening material needed by adding the lengths of each section of the screen and multiplying the total by the height, as shown in Figure 1. For example, suppose the height of the screen is 1.8m and the lengths of the sections are 0.3m, 1.2m, 1.2m, 2.0m, and 1.2m. Then the quantity of screen needed is  $(0.3\text{m} + 1.2\text{m} + 1.2\text{m} + 2.0\text{m} + 1.2\text{m}) \times 1.8\text{m} = 5.9\text{m} \times 1.8\text{m} = 10.6\text{m}^2$ . See Worksheet A, Lines 1, 2 and 3. For a circular or spiral screen multiply the distance around the screen as shown in Figure 1, times the height. For example, if the distance around the screen is 6.1m and the height is 1.8m, the quantity of screen needed is  $6.1\text{m} \times 1.8\text{m} = 11.0\text{m}^2$ . See Worksheet A, Lines 4 and 5.

A corner post is needed at the end of each section of screen. Count the number of posts in the plan view. In the example above there are seven posts as shown in Figure 1. The post near the center of the longest section is for added stability. For circular or spiral screens, place upright posts 0.9-1.2m apart. Posts should be 0.3-0.6m longer than the height of the screen. This extra length will be driven or buried in the ground to hold the screen securely. In the example above, the length of the posts should be at least  $1.8\text{m} + 0.3\text{m} = 2.1\text{m}$ . See Worksheet A, Lines 6 and 7.

Shelter with Roof. Materials include roof and wall materials, corner posts or uprights, cross poles, rafters, and foundation.

Roof materials are calculated by multiplying the width of the shelter plus 0.6m times the length of the shelter plus 0.6m. For example, if the

shelter is 1.4m wide and 1.5m long, the quantity of materials is  $(1.4\text{m} + 0.6\text{m}) \times (1.5\text{m} + 0.6\text{m}) = 2.0\text{m} \times 2.1\text{m} = 4.2\text{m}^2$ . See Worksheet A, Lines 8, 9 and 10.

To calculate the quantity of materials for a circular roof, which may be desirable for a circular or spiral-shaped shelter, first obtain the diagonal dimension of the privy slab by measuring it, as shown in Figure 2. The diagonal plus 0.9m is the diameter of the roof. The quantity of materials equals the diameter divided by 2, multiplied by the diameter divided by 2, multiplied by 3.1. For example, suppose the diagonal of the privy slab is 2.0m. Then the diameter of the roof is  $2.0\text{m} + 0.9\text{m} = 2.9\text{m}$ . The quantity of materials is  $(\frac{2.9\text{m}}{2} \times \frac{2.9\text{m}}{2}) \times 3.1 = (1.45\text{m} \times 1.45\text{m}) \times 3.1 = 2.1\text{m}^2 \times 3.1 = 6.5\text{m}^2$ . See Worksheet A, Lines 11, 12 and 13.

Wall materials are calculated by adding together the area of each wall, including the screening wall, if there is one. The area of a wall is its height times its width. If the top of the wall is sloped, use the height in the middle. For a circular or spiral-shaped shelter, the area of the wall is calculated the same way as for a simple screen shelter. That is, the distance around the shelter is multiplied by the height. For example, suppose a shelter is to have a screening wall, and the roof and sidewalls slope from front to back as in Figure 2, and the wall dimensions are as follows:

rear wall	=	1.6m by 1.4m
side walls	=	1.8m by 1.5m and 1.8m by 1.5m
front wall	=	2.0m by 0.6m
screening walls	=	2.0m by 0.8m and 2.0m by 1.4m

Then the wall area and the quantity of materials needed =  $(1.6\text{m} \times 1.4\text{m}) + (1.8\text{m} \times 1.5\text{m}) + (1.8\text{m} \times 1.5\text{m}) + (2.0\text{m} \times 0.6\text{m}) + 2.0\text{m} \times 0.8\text{m} + (2.0\text{m} \times 1.4\text{m}) = 2.2\text{m}^2 + 2.7\text{m}^2 + 2.7\text{m}^2 + 1.2\text{m}^2 + 1.6\text{m}^2 + 2.8\text{m}^2 = 13.2\text{m}^2$ . See Worksheet A, Lines 14-20.

The materials needed for cross poles, corner posts, rafters, and foundations, shown in Figures 8a and 8b are best calculated by drawing an accurate plan view and measuring lengths from the drawing. The length of each log, pole, or board used for the foundation equals

the width of the wall it supports. The length of each corner post or upright equals the height of the wall it supports. If the entire roof is to be raised above the walls for ventilation, add 0.15m to the length of each corner post or upright.

Shelter with Roof and Door. The materials needed for the roof are the same as those just discussed (see Worksheet A, Lines 8-20). Additional materials needed for the door are door braces, hinges, and latch.

Door materials are calculated by multiplying the height of the door times the width. For example, if the door is 1.8m high and 0.9m wide, the quantity of materials is  $1.8\text{m} \times 0.9\text{m} = 1.6\text{m}^2$ . See Worksheet A, Line 21.

The quantities of materials for the door braces are best obtained by drawing an accurate plan view similar

to Figure 3 and measuring lengths from the drawing. One inside latch and two hinges are needed.

### Materials List

The skills of the laborers and the tools needed depend on the materials used. For example, a wooden shelter requires a laborer with some carpentry skills and a hammer, saw, and nails. A brick-and-mortar shelter requires a laborer with some masonry skills and a shovel, mixing container, and trowel. When the materials, tools, and labor requirements have been determined, draw up a materials list similar to Table 5 and give it to the construction foreman.

In summary, give the construction foreman design drawings similar to Figures 1 through 8b, and a materials list similar to Table 5.

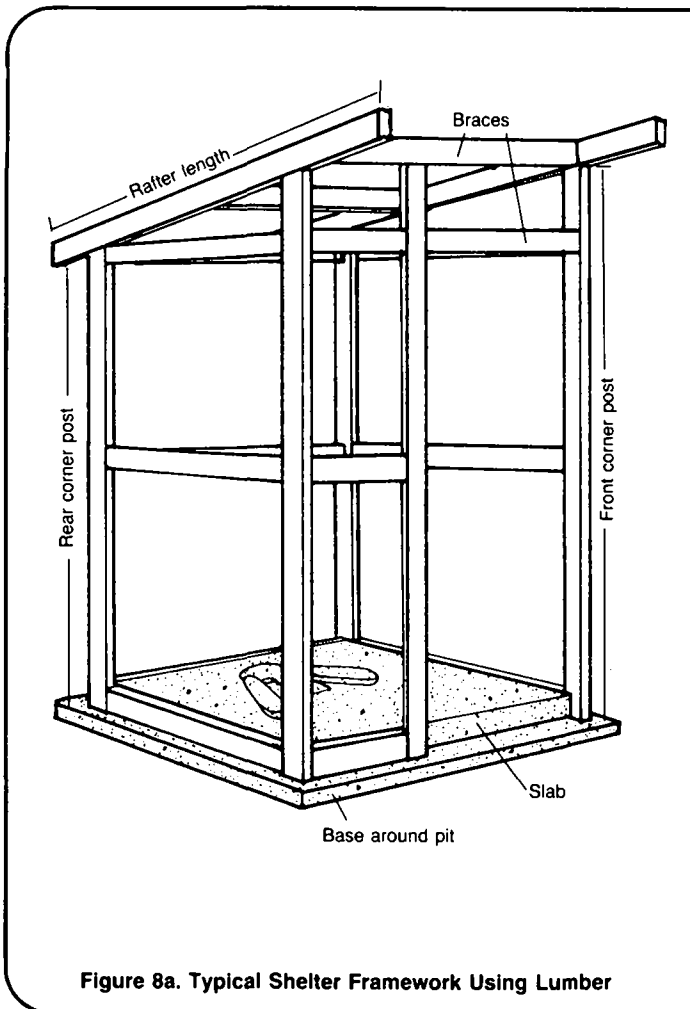


Figure 8a. Typical Shelter Framework Using Lumber

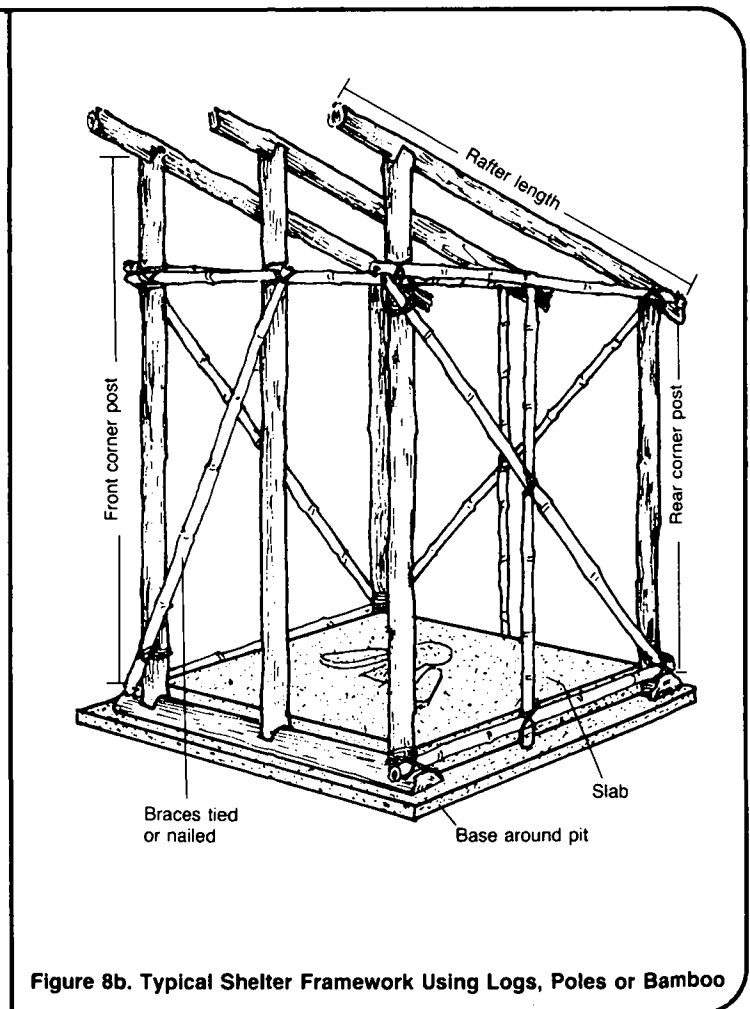


Figure 8b. Typical Shelter Framework Using Logs, Poles or Bamboo

**Table 5. Sample Materials List for Privy Shelter**

Item	Description	Quantity	Estimated Cost
Labor	Foreman	1	_____
	Laborer (carpentry skills)	1	_____
Supplies	Foundation: logs, 1.5m long, 100mm diam.	4	_____
	Corner posts: wood beams, 1.8m long, 50mm diam.	4	_____
	Walls: wood boards, various lengths, 25mm thick	13.2m <sup>2</sup>	_____
	Roof: Corrugated metal	4.2m <sup>2</sup>	_____
	Screens (flyproof) for ventilation openings, 150 x 250mm	12	_____
	Metal hinges	2	_____
	Latch	1	_____
	Nails	_____	_____
Other	_____	_____	
Tools	Measuring tape	1	_____
	Hammer	1	_____
	Saw	1	_____
	Carpenter's level or equivalent (not essential but very useful)	1	_____
	Carpenter's square or equivalent (not essential but very useful)	1	_____
	Other	_____	_____

Total Cost = \_\_\_\_\_

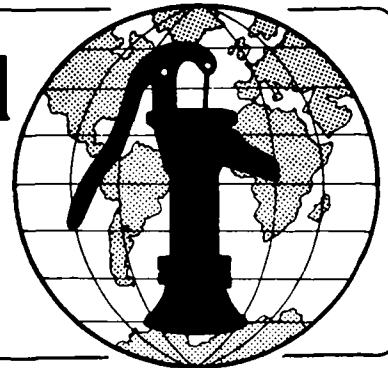
Do Not Use the Quantities in the Sample - Calculate Your Own

## Notes

**Technical Notes** are part of a set of "Water for the World" materials produced under contract to the U.S. Agency for International Development by National Demonstration Water Project, Institute for Rural Water, and National Environmental Health Association. Artwork was done by Redwing Art Service. Technical Notes are intended to provide assistance to a broad range of people with field responsibility for village water supply and sanitation projects in the developing nations. For more detail on the purpose, organization and suggestions for use of Technical Notes, see the introductory Note in the series, titled "Using 'Water for the World' Technical Notes." Other parts of the "Water for the World" series include a comprehensive Program Manual and several Policy Perspectives. Further information on these materials may be obtained from the Development Information Center, Agency for International Development, Washington, D.C., 20523, U.S.A.



# Water for the World



## Designing Aqua Privies Technical Note No. SAN. 1.D.4

An aqua privy is an underground watertight vault filled with water that receives excreta and washwater from a drop-pipe, allows solids to settle to the bottom and discharges effluent to a soakage pit. Designing an aqua privy involves selecting a location, calculating the size of the vault and the soakage pit, and determining the labor, materials, and tools needed for construction. The products of the design process are: (1) a location map, (2) design drawings of the aqua privy, and (3) a detailed materials list. These products should be given to the construction foreman before construction begins.

This technical note describes how to design an aqua privy and arrive at these three end-products. Read the entire technical note before beginning the design process.

### Useful Definitions

**CONTAMINATE** - To make unclean by introducing an infectious (disease-causing) impurity such as bacteria from excreta.

**EFFLUENT** - Settled sewage.

**EXCRETA** - Human body wastes.

**FLOW LINE** - The highest level to which liquid can rise in an aqua privy.

**GROUNDWATER LEVEL** - The level to which subsurface water rises during any given time of year.

**WASHWATER** - Water that has been used for bathing or washing clothes, dishes, or kitchen utensils.

### Materials Needed

**Measuring tape** - To obtain accurate field information for a location map.

**Ruler** - To draw a location map.

### General Design Information

The soakage pit or soakage trench connected to an aqua privy is identical to that described in "Designing Sumps, Soakage Pits and Trenches," SAN.1.D.7. For design information, and material on size, materials, and labor, refer to that technical note.

The walls and floor of an aqua privy vault must be waterproof. They are made from reinforced concrete or brick and mortar, and are 100mm thick. A sitting or squatting slab covers the vault. It is made from reinforced concrete and is 75mm thick. The drop-pipe is made from galvanized metal. It extends from the hole in the slab down into the liquid in the vault to a depth of 100mm. The overflow pipe extends from the back wall of the vault to the soakage pit or trench. It is 100mm in diameter and made from non-corrosive plastic or vitrified clay. The pipe is equipped with an elbow fitting or "T" fitting inside the vault. The bottom of the overflow pipe, and thus the flow line, is 300mm below the bottom of the slab as shown in Figure 2. The vent pipe extends upward from the rear wall of the vault just below the slab. It is 25mm in diameter and made from galvanized metal or similar material.

The minimum capacity of the vault should be 1.0m<sup>3</sup>. Capacity is deter-

mined by multiplying the inside length times the inside width times the liquid depth (distance from the flow line to the floor of the vault).

### Location

An aqua privy vault should be at least:

- 15m from the nearest water supply,
- 3m from the nearest dwelling,
- 3m from any property line.

A soakage pit or soakage trench should be downhill and at least:

- 30m from the nearest water supply,
- 6m from the nearest dwelling,
- 3m from any property line,
- 3m from trees or bushes.

The minimum distance between the vault and soakage pit is 3m. There is no maximum distance, but for practical reasons the vault and soakage pit are usually no more than 30m apart.

When sites for the aqua privy vault and soakage pit have been selected, the soakage pit site must be tested for soil suitability and groundwater levels to prevent contamination of water supplies. For details see "Designing Sumps, Soakage Pits, and Trenches," SAN.1.D.7.

When the soil has been found to be suitable, draw a location map similar to Figure 1 showing the aqua privy and soakage pit or trench in relation to all sources of drinking water, dwellings, property lines, and trees. Give the map to the construction foreman before construction begins.

### Determining Size

To determine the size of the soakage pit or trench, see "Designing Sumps, Soakage Pits, and Trenches," SAN.1.D.7.

To figure the size of the aqua privy vault, first determine the number of persons who will regularly use the privy, then consult Table 1.

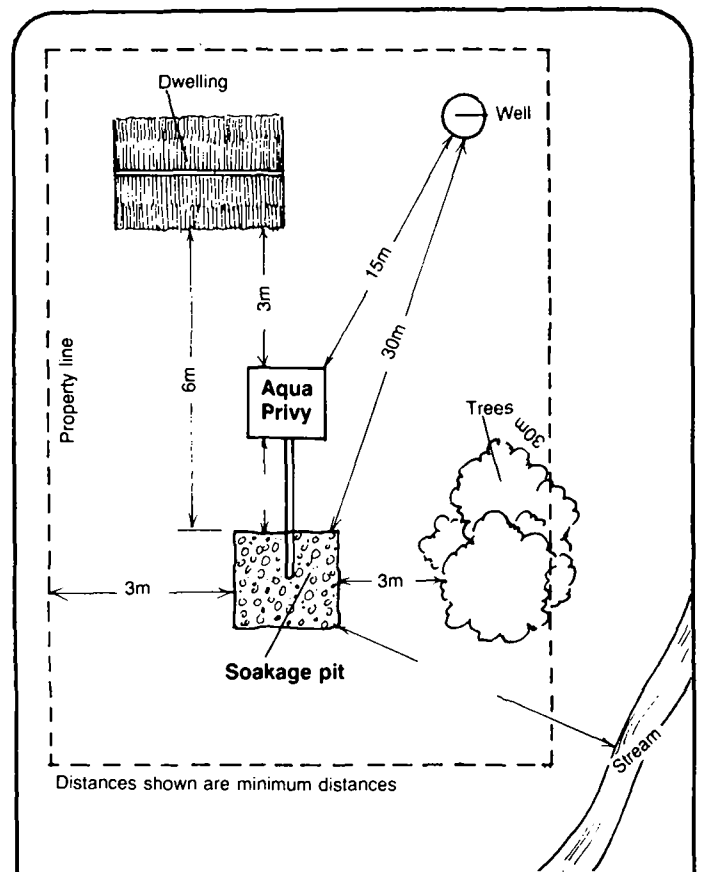


Figure 1. Location Map

Table 1. Recommended Measurements for an Aqua Privy Vault

Number of Persons	Capacity	Liquid Depth*	Inside Length	Inside Width	Inside Height**
8 or fewer	1.0m <sup>3</sup>	1.0m	1.0m	1.0m	1.3m
9	1.1m <sup>3</sup>	1.1m	1.0m	1.0m	1.4m
10	1.2m <sup>3</sup>	1.1m	1.1m	1.0m	1.4m
11	1.3m <sup>3</sup>	1.1m	1.1m	1.1m	1.4m
12	1.4m <sup>3</sup>	1.2m	1.1m	1.1m	1.5m
13	1.6m <sup>3</sup>	1.2m	1.2m	1.1m	1.5m
14	1.7m <sup>3</sup>	1.2m	1.2m	1.2m	1.5m
15 or more	Build two or more aqua privies				

\*Liquid depth is the distance from the flow line to the floor of the vault.

\*\*Inside height equals the liquid depth plus 300mm.

For example, if nine persons will use the aqua privy, then: capacity = 1.1m<sup>3</sup>; liquid depth = 1.1m; inside length = 1.0m; inside width = 1.0m; inside height = 1.4m. See Worksheet A, Lines 1-5.

### Worksheet A. Calculations for an Aqua Privy

1. Number of persons using aqua privy = 9
2. Liquid depth (from Table 1) = 1.1m
3. Inside length (from Table 1) = 1.0m
4. Inside width (from Table 1) = 1.0m
5. Inside height (from Table 1) = 1.4m
6. Outside length = Line 3 + 200mm = 1.0 m + 0.2m = 1.2 m
7. Outside width = Line 4 + 200mm = 1.0 m + 0.2m = 1.2 m
8. Outside height = Line 5 + 175mm = 1.4 m + 0.175m = 1.575 m

#### Quantities

9. Volume of slab = Line 6 x Line 7 x 0.075m = 1.2 m x 1.2 m x 0.075m = 0.1 m<sup>3</sup>
10. Volume of walls = (2 x Line 6 x Line 5 x 0.1m) + (2 x Line 7 x Line 5 x 0.1m) = (2 x 1.2 m x 1.4 m x 0.1m) + (2 x 1.2 m x 1.4 m x 0.1m) = 0.34 m<sup>3</sup> + 0.34 m<sup>3</sup> = 0.7 m<sup>3</sup>
11. Volume of floor = Line 6 x Line 7 x 0.1m = 0.1 m<sup>3</sup>

When the liquid depth and the inside measurements have been determined, calculate the outside dimensions. The outside length equals the inside length plus two end walls. The outside width equals the inside width plus two side walls. The outside height equals the inside height plus the floor and the slab. Table 2 shows the thicknesses to use in calculating outside dimensions.

In the example, the outside dimensions would be as follows:

$$\begin{aligned} \text{Outside length} &= 1.0\text{m} + 100\text{mm} + 100\text{mm} = 1.2\text{m} \\ \text{Outside width} &= 1.0\text{m} + 100\text{mm} + 100\text{mm} = 1.2\text{m} \\ \text{Outside height} &= 1.4\text{m} + 100\text{mm} + 75\text{mm} = 1.575\text{m} \end{aligned}$$

See Worksheet A, Lines 6-8.

**Table 2. Thickness of Walls, Floor, and Slab**

Feature	Thickness
Wall	100mm
Floor	100mm
Slab	75mm

When all dimensions have been calculated, prepare design drawings of the aqua privy vault similar to Figure 2, and the soakage pit similar to Figure 3, showing all measurements. Give these drawings to the construction foreman before construction begins.

#### Determining Materials, Tools, and Labor

The walls of an aqua privy are made from reinforced concrete or brick and mortar. The floor and the slab are made from reinforced concrete.

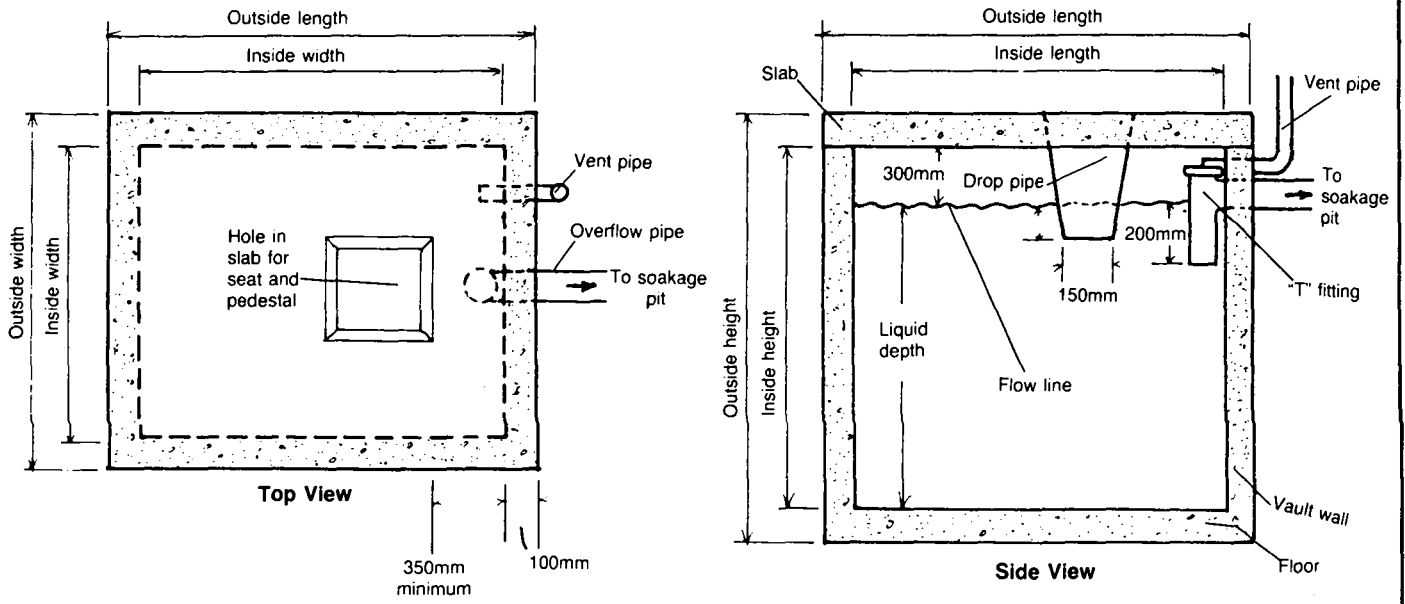


Figure 2. Aqua Privy

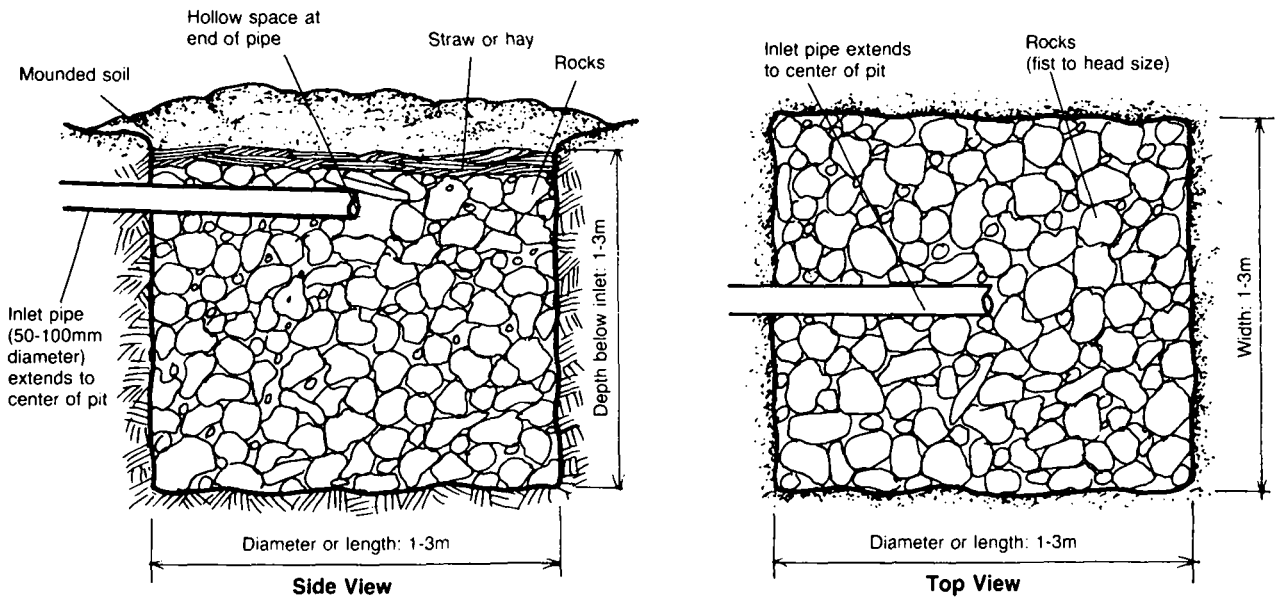


Figure 3. Soakage Pit

Concrete walls, floor, and slab require cement, sand, gravel, and water; containers and tools for mixing and smoothing concrete; reinforcing material; wood, hammer, saw, and nails for building forms; and at least one worker with some experience in concrete. See "Designing Septic Tanks," SAN.2.D.3, for complete details and specifications on concrete ingredients and reinforcing materials.

Brick and mortar walls require bricks or concrete blocks; cement, sand, and water for mortar and cement plaster; containers and tools for mixing and spreading mortar; and at least one worker with some experience with masonry. See "Designing Septic Tanks," SAN.2.D.3, for complete details.

For more information on slab design, see "Designing Slabs for Privies," SAN.1.D.1.

Quantities. The quantities of materials needed for the vault can be estimated by adding the volumes of the slab, walls, and floor.

Volume of the slab = outside length times outside width times thickness.

Volume of the walls = (2 x outside length x inside height x thickness) + (2 x outside width x inside height x thickness).

Volume of floor = outside length x outside width x thickness.

In the previous examples, the volumes would be as follows:

$$\text{Slab} = 1.2\text{m} \times 1.2\text{m} \times 0.075\text{m} = 0.1\text{m}^3$$

$$\text{Walls} = (2 \times 1.2\text{m} \times 1.4\text{m} \times 0.1\text{m}) + (2 \times 1.2\text{m} \times 1.4\text{m} \times 0.1\text{m}) = 0.34\text{m}^3 + 0.34\text{m}^3 = 0.7\text{m}^3$$

$$\text{Floor} = 1.2\text{m} \times 1.2\text{m} \times 0.1\text{m} = 0.1\text{m}^3$$

See Worksheet A, Lines 9-11.

Other quantities include an overflow pipe of non-corrosive material, 100mm in diameter, the length of which equals the distance from the aqua privy to the soakage pit; a "T" or elbow fitting for the overflow pipe; a vent pipe of galvanized metal, 25mm in diameter and 2.0-2.5m long; a drop-pipe of galvanized metal, about 400mm long, 150mm diameter at the lower end, and large enough at the upper end to enclose the hole in the slab.

When all materials, tools, and labor requirements have been determined, draw up a materials list similar to Table 3 and give it to the construction foreman before construction begins.

In summary, give the construction foreman a location map similar to Figure 1, design drawings similar to Figures 2 and 3, and a materials list similar to Table 3.

**Table 3. Sample Materials List for Aqua Privy**

Item	Description	Quantity	Estimated Cost
Labor	Foreman	1	—
	Worker (skilled with concrete)	1	—
	Worker (unskilled)	1	—
Supplies	Wood (for forms)	—	—
	Nails (for forms)	—	—
	Cement (Portland)	—	—
	Sand (clean, sized fine to 6mm)	—	—
	Gravel (clean, sized 6-25mm)	—	—
	Water (clear)	—	—
	Reinforcing material	—	—
	Overflow pipe (vitrified clay, 100mm diameter)	—	—
	Elbow fitting (vitrified clay, 100mm diameter)	—	—
	Vent pipe (galvanized metal, 25mm diameter)	—	—
	Drop-pipe (galvanized metal, 400mm long)	—	—
	Materials for soakage pit:	—	—
	rocks	—	—
	straw	—	—
Tools	Measuring tape	1	—
	Hammer	1	—
	Saw	1	—
	Shovels	2	—
	Trowel	1	—
	Container for mixing concrete	2	—
	Carpenter's level (optional)	1	—
	Carpenter's square (optional)	1	—
	Tar or equivalent (for sealing slab to vault)	—	—
		—	—

Total Estimated Cost = —

## Notes

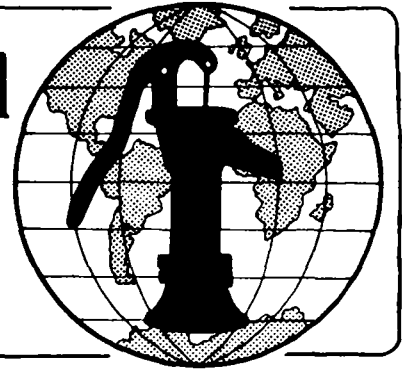
## Notes

## Notes

**Technical Notes** are part of a set of "Water for the World" materials produced under contract to the U.S. Agency for International Development by National Demonstration Water Project, Institute for Rural Water, and National Environmental Health Association. Artwork was done by Redwing Art Service. Technical Notes are intended to provide assistance to a broad range of people with field responsibility for village water supply and sanitation projects in the developing nations. For more detail on the purpose, organization and suggestions for use of Technical Notes, see the introductory Note in the series, titled "Using 'Water for the World' Technical Notes." Other parts of the "Water for the World" series include a comprehensive Program Manual and several Policy Perspectives. Further information on these materials may be obtained from the Development Information Center, Agency for International Development, Washington, D.C., 20523, U.S.A.



# Water for the World



## Designing Bucket Latrines Technical Note No. SAN. 1.D.5

A bucket latrine consists of a shelter and a platform which supports a slab and encloses a bucket. The bucket receives excreta, and it is emptied every one to three days by a laborer who carts the excreta to a disposal site. Designing a bucket latrine involves selecting locations for the latrines; determining latrine size; selecting materials, tools, and labor needed to build the latrines; determining the type and location of the disposal site; and determining personnel and equipment needed for the disposal operation. The products of the design process are: (1) a location map, (2) design drawings of the bucket latrine, (3) a construction materials list, and (4) an operation materials list.

This technical note describes how to design a bucket latrine and arrive at these three end-products. Read the entire technical note before beginning the design process.

### Useful Definitions

**CONTAMINATE** - To make unclean by introducing an infectious (disease-causing) impurity such as bacteria from excreta.

**EXCRETA** - Human body wastes.

**GROUNDWATER LEVEL**- The level to which subsurface water rises during any given time of year.

### Materials Needed

Measuring tape - To obtain field measurements.

Ruler - To draw a location map.

### Location

Because of possible odors, a bucket latrine should be located at least 3m from the dwelling. Select a site that is accessible both for use of the toilet and removal of the bucket. When the sites for the bucket latrines have been selected, draw a location map similar to Figure 1, showing latrines, dwellings, roads, and disposal site (see later section on "Determining Type and Location of Disposal Site"). Give the map to the construction supervisor before construction begins.

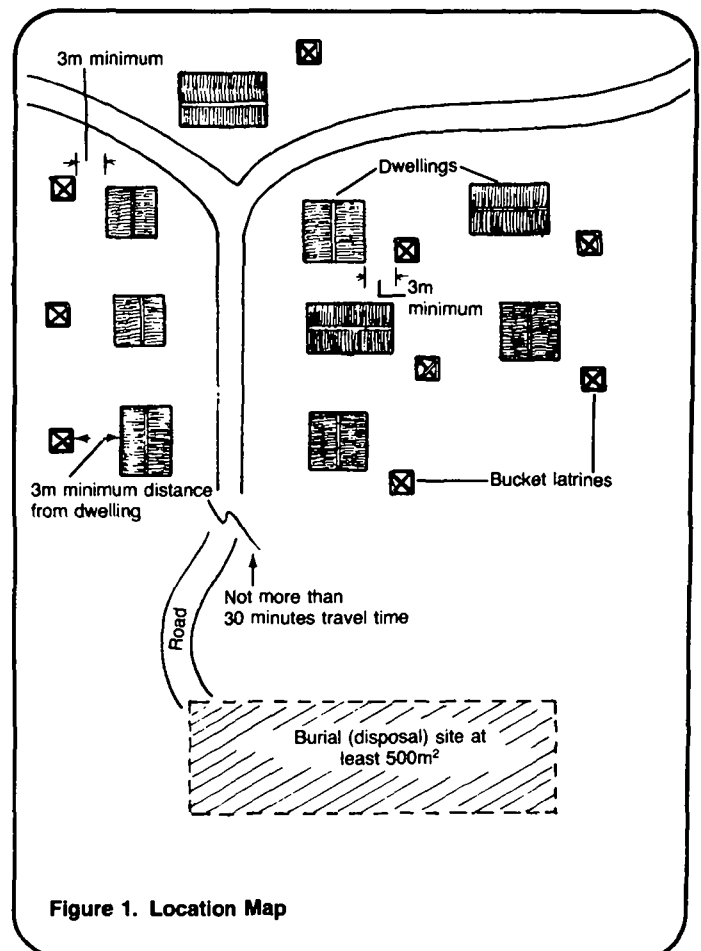


Figure 1. Location Map

## General Design Information

The main features of a bucket latrine are the slab, platform, base, shelter, and bucket.

The slab is generally made from reinforced concrete. It may be a squatting slab or have a seat and pedestal (see "Designing Slabs for Privies," SAN.1.D.1).

The platform is made from concrete or brick and mortar. It supports the slab, encloses the bucket, and has a fly-proof door for removal of the bucket.

The base is usually made from reinforced concrete or brick and mortar with a cement mortar coating. The base supports the platform and the shelter.

The shelter may be made from a variety of locally available materials. It has an opening in the rear to allow access to the fly-proof door in the platform. See "Designing Privy Shelters," SAN.1.D.3.

### Determining Size and Materials

Slab. Design the slab to be 1.0-1.2m wide, 1.0-1.2m long (front to rear), and 75mm thick. For complete details, see "Designing Slabs for Privies," SAN.1.D.1.

Platform. Design the platform so that the outside dimensions are the same as the dimensions of the slab. For example, if the slab is 1.0m wide and 1.1m long, the platform also should be 1.0m wide and 1.1m long. The height of the platform depends on the size of the bucket which will be used. The platform should be about 50mm higher than the bucket. For example, if the height of the bucket is 300mm, the platform height should be 300mm + 50mm = 350mm (Worksheet A, Lines 1-7). Table 1 summarizes the dimensions of the platform.

Include an opening for a fly-proof door in the rear wall of the platform. The opening must be large enough to remove and replace the bucket, and it should be flush with the bottom of the platform.

Table 1. Platform Dimensions for a Bucket Latrine

Feature	Measurement
Width	Width of the slab
Length (front to rear)	Length of the slab
Height	Bucket height plus 50mm

The door can be wood or metal. It must be hinged to open outward, and it must fit tightly around all edges.

The walls should be 50-100mm thick and strong enough to support the slab. If the walls are made of concrete, you need cement, sand, gravel, water, mixing containers, a shovel, a trowel, wood for forms, hammer, saw, nails, reinforcing material, and a laborer with some skills in working with concrete. If the walls are made of brick and mortar, you need bricks (or concrete blocks or select field stones), cement, sand, water, mixing container, shovel, trowel, and a laborer with some masonry skills. For complete details on working with cement or brick and mortar, including materials specifications and quantity calculations, see "Designing Septic Tanks," SAN.2.D.3.

To estimate the quantity of materials needed for the walls, use the following equation:  $(2 \times \text{length} \times \text{height} \times \text{thickness}) + (2 \times \text{width} \times \text{height} \times \text{thickness})$ . For example, if the walls are 0.075m thick, the platform height is 0.35m, the platform width is 1.0m, and the platform length is 1.1m, then the approximate quantity of wall materials needed is:

$$(2 \times 1.1\text{m} \times 0.35\text{m} \times 0.075\text{m}) + (2 \times 1.0\text{m} \times 0.35\text{m} \times 0.075\text{m}) = 0.06\text{m}^3 + 0.05\text{m}^3 = 0.11\text{m}^3 \text{ (Worksheet A, Lines 8-9).}$$

## Worksheet A. Calculations for a Bucket Latrine

### Slab

1. Width = 1.0 m
2. Length (front to rear) = 1.1 m
3. Thickness = 0.075m

### Bucket

4. Height = 0.30 m

### Platform

5. Width = Line 1 = 1.0 m
6. Length = Line 2 = 1.1 m
7. Height = Line 4 + 0.05m = 0.30m + 0.05m = 0.35 m
8. Wall thickness = 0.075m
9. Quantity of materials for platform walls =  
 $(2 \times \text{Line 5} \times \text{Line 7} \times \text{Line 8}) + (2 \times \text{Line 6} \times \text{Line 7} \times \text{Line 8}) =$   
 $(2 \times \underline{1.0} \text{ m} \times \underline{0.35} \text{ m} \times \underline{0.075} \text{ m}) + (2 \times \underline{1.1} \text{ m} \times \underline{0.35} \text{ m} \times \underline{0.075} \text{ m}) =$   
0.05 m<sup>3</sup> + 0.06 m<sup>3</sup> = 0.11 m<sup>3</sup>

### Base

10. Width = Line 5 + 0.15m = 1.0 m + 0.15m = 1.15 m
11. Length = Line 6 + 0.15m = 1.1 m + 0.15m = 1.25 m
12. Thickness = 0.10m
13. Quantity of materials for base = Line 10 x Line 11 x Line 12 =  
1.15 m x 1.25 m x 0.1 m = 0.14 m<sup>3</sup>

Base. Design the base so that its width equals the platform width plus 0.15m and its length equals the platform length plus 0.15m. For example, if the platform is 1.0m wide and 1.1m long, the base should be 1.15m wide and 1.25m long (Worksheet A, Lines 10-11). The base should be 0.1m thick. Table 2 summarizes the dimensions of the base.

If the base is made of concrete, you need the same materials as for a concrete platform. If the base is made of brick and mortar, you need the same materials as for a brick and mortar platform.

**Table 2. Base Dimensions for a Bucket Latrine**

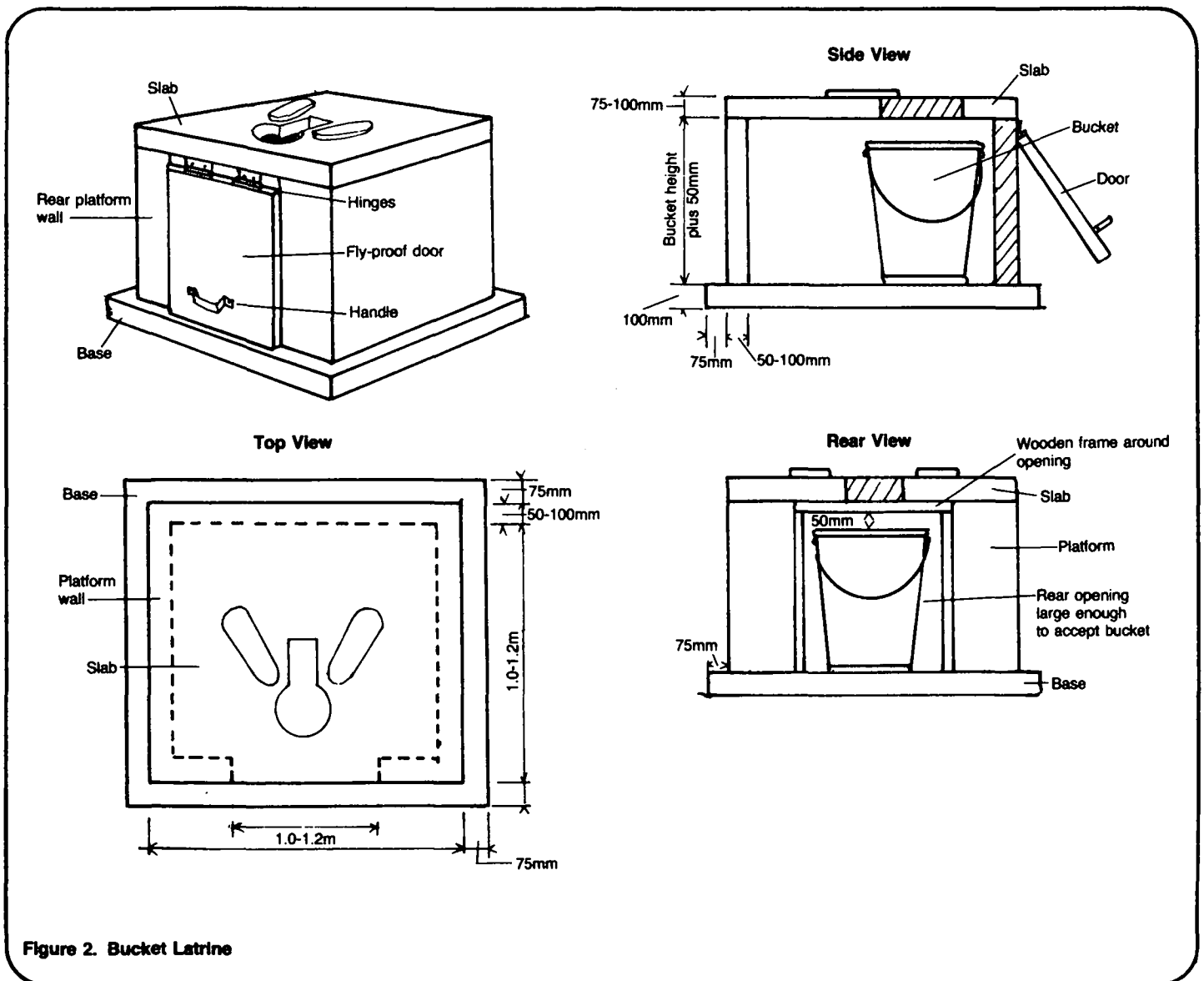
Feature	Measurement
Width	Width of platform plus 0.15m
Length	Length of platform plus 0.15m
Thickness	0.1m

To estimate the quantity of materials needed for the base, multiply the length times the width times the thickness. For example, if the length is 1.25m, the width 1.15m, and the thickness 0.1m, then the approximate quantity of materials needed is  $1.25\text{m} \times 1.15\text{m} \times 0.1\text{m} = 0.14\text{m}^3$  (Worksheet A, Lines 12-13).

**Shelter.** For details on materials, tools, and labor, see "Designing Privy Shelters," SAN.1.D.3. The shelter must have an opening in the rear wall to allow access to the opening in the platform.

**Bucket.** Buckets are usually made of galvanized metal, molded rubber or plastic, lacquered wood, or wood coated with creosote. The bucket should have a capacity of 20-30 liters and it should have a handle. It is necessary to have two buckets per latrine. When the dirty bucket is removed, it is replaced with the clean one.

When all dimensions, materials, tools, and labor have been determined, prepare design drawings similar to Figure 2 and a construction materials list similar to Table 3. Give them to the person in charge of construction before construction begins.



**Table 3. Sample Construction Materials**

Item	Description	Quantity	Estimated Cost
Labor	Foreman	1	_____
	Laborer (skilled with concrete)	1	_____
	Laborer (unskilled)	1	_____
Supplies	Wood (for forms and fly-proof door)	_____	_____
	Nails	_____	_____
	Cement (Portland)	_____	_____
	Sand (clean, sized fine to 6mm)	_____	_____
	Gravel (clean, sized 6-25mm)	_____	_____
	Water (clear)	_____	_____
	Reinforcing material	_____	_____
	Squatting slab	_____	_____
	Tin sheet (for fly-proof door)	_____	_____
	Hinges (for fly-proof door)	_____	_____
	Handle (for fly-proof door)	_____	_____
	Materials for shelter (see SAN.1.D.3)	-----	_____
	Buckets	_____	_____
Other	_____	_____	
Tools	Measuring tape	1	_____
	Hammer	1	_____
	Saw	1	_____
	Shovel	1	_____
	Trowel	1	_____
	Container for mixing concrete	1	_____
	Other	_____	_____

Total Estimated Cost = \_\_\_\_\_

**Determining Type and Location of Disposal Site**

There are four ways to dispose of excreta from a bucket latrine: biogas system, composting system, stabilization pond, and burial site.

Biogas and composting systems do not always satisfactorily destroy the disease-causing bacteria in excreta. They are excellent systems for conserving the energy and fertilizer value of the excreta. If either one of these systems is to be used, see "Designing a Composting System," SAN.3.D.2, or "Designing a Biogas System," SAN.3.D.4, for details.

A stabilization pond is a satisfactory disposal site, provided the excreta undergoes pre-treatment. For details, see "Designing Stabilization Ponds," SAN.2.D.5.

A burial site may be the simplest method of disposal, provided a suitable site can be located. The site should meet the following conditions:

1. The groundwater level should be at least 2m below ground to avoid contaminating water supplies. Test holes can be dug 2m deep and if no water is observed, the site is suitable.
2. The burial trench should have a maximum depth of 1m.
3. The soil should be suitable. That is, it must be neither predominantly clay nor sand.
4. The site should be no more than 30 minutes travel time from the latrines.
5. The area of the site should be at least 500m<sup>2</sup>.

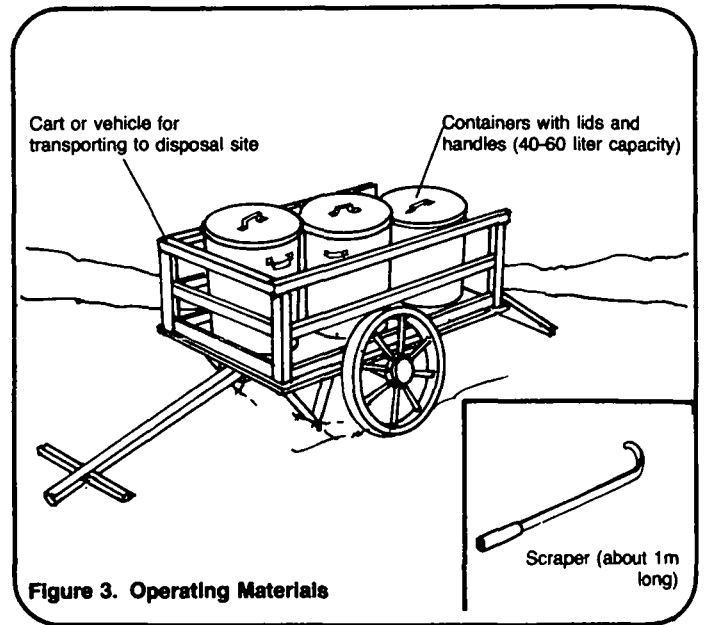
6. Water for washing hands and equipment should be available near the site.

When a suitable burial site has been found, prepare a location map similar to Figure 1, showing bucket latrines, dwellings, roads, and the disposal site. Give the map to the person in charge of construction.

**Determining Personnel and Equipment for Operation**

The number of workers needed depends on the type of disposal, the number of latrines to be serviced and on local work habits. Since the buckets should be emptied every day or every two days, there should be enough workers to empty at least half the buckets, dump excreta into larger containers and cart the containers to the disposal site. If the excreta is being buried, the workers must dig a short, shallow trench, bury the excreta, and wash their hands and equipment. All of this should occur within a reasonable length of time, for example, 6-10 hours.

To operate the latrines, materials needed include: large 40-60 liter containers equipped with lids, scrapers to empty buckets and containers, a vehicle to transport containers to the burial site (see Figure 3), shovels to bury the excreta, and brushes or other equipment to clean buckets and containers.



When all equipment and personnel needed to operate the system have been determined, prepare an operations materials list similar to Table 4 and give it to whoever will be in charge of operating and maintaining the latrine system.

In summary, give the person in charge of construction a location map similar to Figure 1, design drawings of the bucket latrine similar to Figure 2, and a construction materials list similar to Table 3. Give the person in charge of operations a materials list similar to Table 4.

**Table 4. Sample Operations Materials List**

Item	Description	Quantity	Estimated Cost
Labor	Foreman	1	_____
	Laborers	3	_____
Supplies, Tools, and Vehicles	Containers with lids (40-60 liters each)	_____	_____
	Scrapers with long handles	_____	_____
	Carts (hand-drawn)	_____	_____
	Shovels	_____	_____
	Gloves	_____	_____
	Boots	_____	_____
	Brushes for cleaning	_____	_____
	Containers for soap and water	_____	_____
Other	_____	_____	

Total Estimated Cost = \_\_\_\_\_

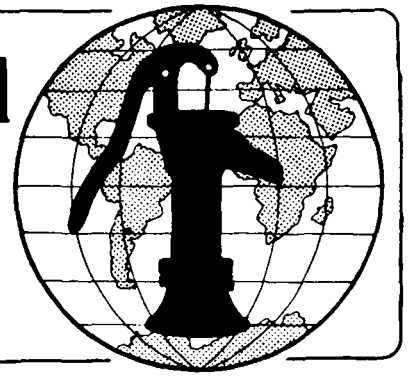
## Notes

## Notes

**Technical Notes** are part of a set of "Water for the World" materials produced under contract to the U.S. Agency for International Development by National Demonstration Water Project, Institute for Rural Water, and National Environmental Health Association. Artwork was done by Redwing Art Service. Technical Notes are intended to provide assistance to a broad range of people with field responsibility for village water supply and sanitation projects in the developing nations. For more detail on the purpose, organization and suggestions for use of Technical Notes, see the introductory Note in the series, titled "Using 'Water for the World' Technical Notes." Other parts of the "Water for the World" series include a comprehensive Program Manual and several Policy Perspectives. Further information on these materials may be obtained from the Development Information Center, Agency for International Development, Washington, D.C., 20523, U.S.A.



# Water for the World



## Designing Compost Toilets Technical Note No. SAN. 1.D.6

A compost toilet consists of a pair of waterproof vaults that receive excreta, ashes, sawdust, straw, and grass. Each vault is equipped with a slab for defecating, a rear opening for removing compost, and a hole for a vent pipe. Designing a compost toilet involves selecting a location, calculating the size of the vaults, and determining the labor, materials, and tools needed for construction. The products of the design process are: (1) a location map, (2) design drawings of the compost toilet, and (3) a materials list. These products should be given to the construction foreman before construction begins.

This technical note describes how to design a compost toilet and arrive at these three end-products. Read the entire technical note before beginning the design process.

### Useful Definitions

**BACTERIAL ACTION** - The process of organic matter being digested and broken down by tiny organisms.

**COMPOST** - A dark, fairly dry, crumbly, odorless material that is produced by sealing excreta, ashes, woodchips, straw, and vegetable wastes for 6-12 months in the vault of a compost toilet. Compost can be used to fertilize crops.

### Materials Needed

**Measuring tape** - To obtain accurate field information for a location map.

**Ruler** - To draw a location map.

### Location

The compost toilet should be on fairly level ground and at least:

- 6m from the nearest dwelling,
- 6m from the nearest water supply,
- 3m from the nearest property line.

Select a site that allows easy access to the toilet for use and for removing compost. If possible, the site should be downwind from the dwelling as there will be an odor. When the site has been selected, draw a location map similar to Figure 1 showing correct distances from the compost toilet to dwellings, water supplies, property lines, and roads. Give this map to the construction foreman before construction begins.

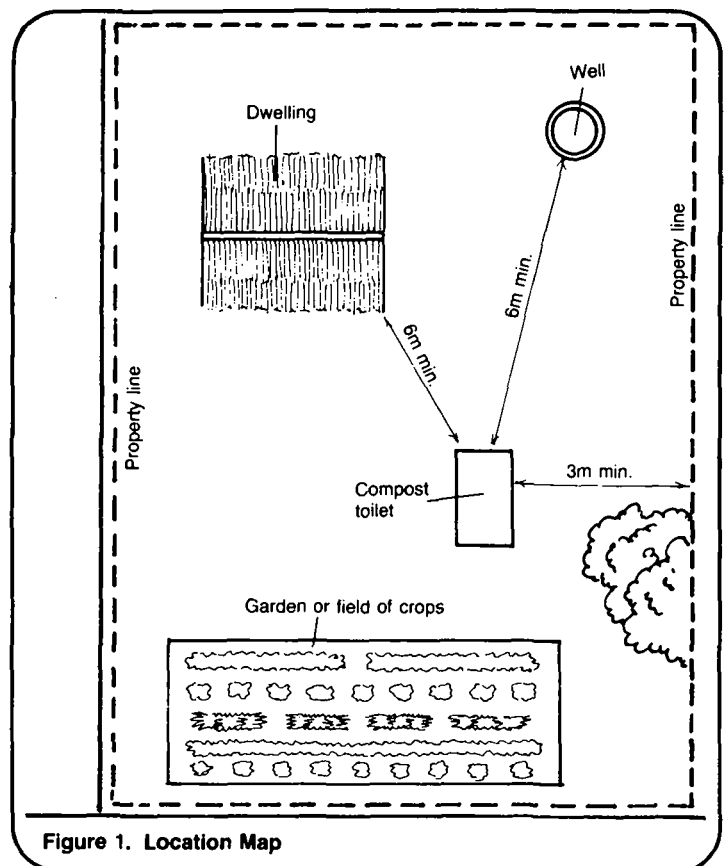


Figure 1. Location Map

## General Design Information

A double-vault compost toilet is usually made from reinforced concrete or brick and mortar, and it rests on a base of similar material. See Figure 2. The vaults must be waterproof. If they are made from brick and mortar, the inside walls should be coated with a 12-25mm thick coating of cement plaster. The minimum thickness of the walls and base are shown in Table 1.

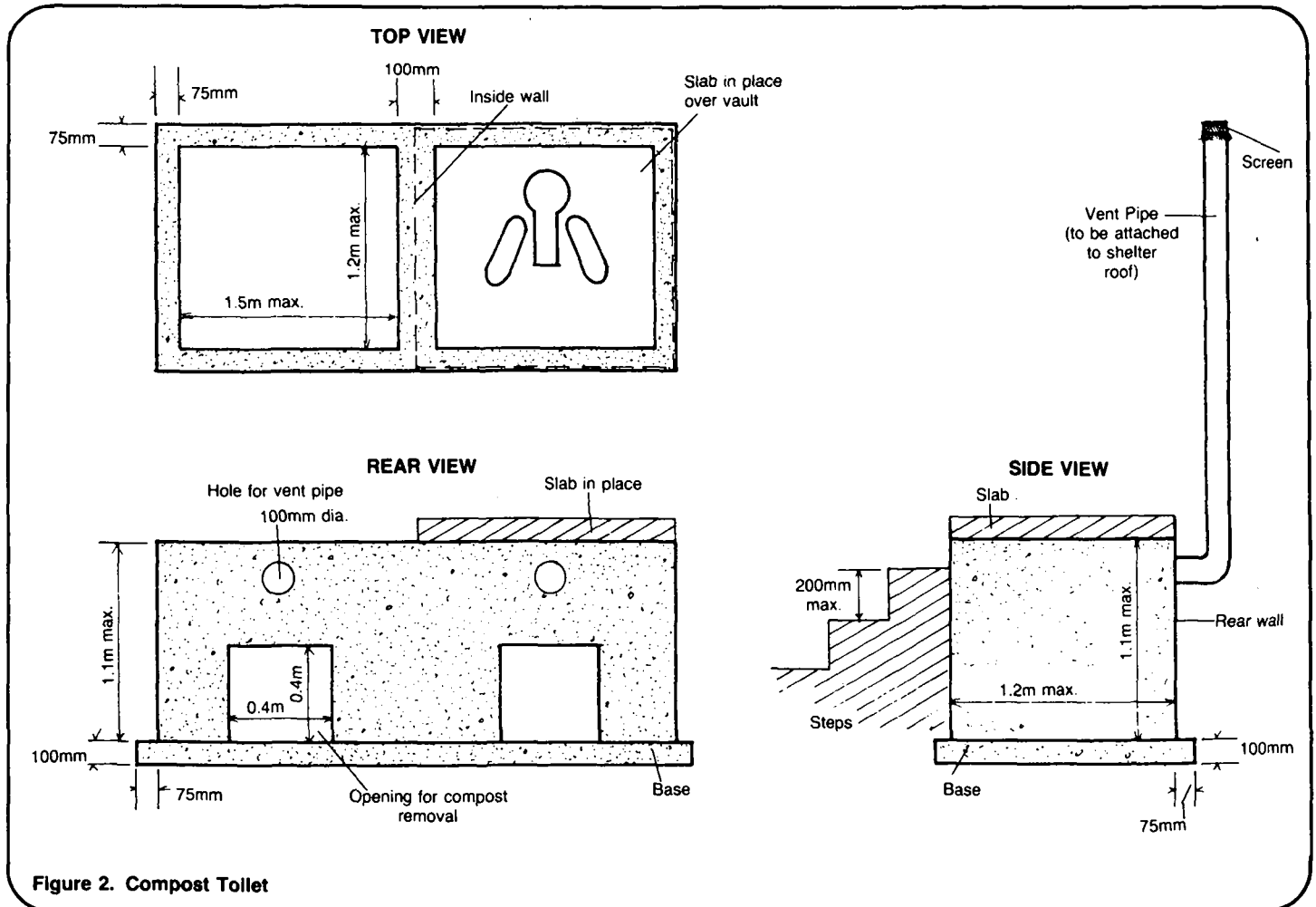
Design the vaults to be the same size. The maximum dimensions of each vault are shown in Table 2.

The rear wall of each vault must have an opening at least 0.4m by 0.4m for removal of compost, and a hole about 100mm in diameter for a vent pipe. The openings must have wood or metal covers that are larger than the openings themselves. The covers should be braced. The vent pipes are generally 100mm in diameter and made of galvanized metal.

**Table 1. Walls and Base Design Criteria**

Feature	Minimum Thickness
Outside Wall	75mm
Inside Wall (between vaults)	150mm
Base	100mm

The compost toilet may have two vent pipes which are permanently installed, or one vent pipe which is moved to whichever vault is in use. The vent hole in the vault not in use must be covered with wood or metal.



**Figure 2. Compost Toilet**

**Table 2. Vault Dimensions**

Feature	Maximum Dimension
Inside Height	1.1m
Inside Length (front to rear)	1.2m
Inside Width	1.5m

Design the steps leading up to the compost toilet so that the maximum height of each step is 200mm. See Figure 2.

Design the slab so that it is flush with the outside walls of the compost toilet. For details, see "Designing Slabs for Privies," SAN.1.D.1.

### Calculating Size

Volume. Each vault must be large enough so that it takes about one year to become 3/4 full. Each person produces about 0.2m<sup>3</sup> of waste per year, taking into account volume reduction to excreta and grass clippings by bacterial action. This number is multiplied by 1.33 because the vault is filled with soil and sealed when it becomes 3/4 full. Therefore, the volume factor equals:

$$0.2\text{m}^3 \times 1.33 = 0.27\text{m}^3 \text{ per person.}$$

To calculate the required volume of each vault, multiply the volume factor times the number of persons using the compost toilet. For example, if the toilet is to serve a family of five, the volume of each vault must be five times 0.27m<sup>3</sup>:

$$5 \times 0.27\text{m}^3 = 1.35\text{m}^3 \text{ (Worksheet A, Lines 1-2).}$$

Because of the limitations on dimensions shown in Table 2, this type of compost toilet will serve a maximum of seven persons. If eight or more persons must be served, design more than one toilet.

Inside Dimensions of Each Vault. Determine the inside dimensions of each vault based on the required volume and on the information in Table 2. The volume equals the inside height times the inside length times the inside width. For example, if the required volume of each vault is 1.35m<sup>3</sup>, the inside dimensions could be:

$$1.00\text{m (height)} \times 1.10\text{m (length)} \times 1.23\text{m (width)} = 1.35\text{m}^3 \text{ (Worksheet A, Lines 3-5).}$$

Outside Dimensions of Toilet. The outside dimensions of the toilet depend on the inside dimensions of each vault and on the information in Table 1.

The outside height equals the inside height.

The outside length (front to rear) equals the inside length plus two times the outside wall thickness.

The outside width equals two times the inside width plus two times the outside wall thickness plus the thickness of the inside wall between the vaults.

For example, if the inside dimensions of each vault are:

$$\begin{aligned} \text{height} &= 1.00\text{m, length} = 1.10\text{m,} \\ \text{width} &= 1.23\text{m, then the outside dimensions of the compost toilet are:} \end{aligned}$$

$$\begin{aligned} \text{outside height} &= 1.00\text{m;} \\ \text{outside length} &= 1.10\text{m} + (2 \times 0.075\text{m}) = 1.10\text{m} + 0.15\text{m} = 1.25\text{m;} \\ \text{outside width} &= (2 \times 1.23\text{m}) + (2 \times 0.075\text{m}) + 0.15\text{m} = 2.46\text{m} + 0.15\text{m} + 0.15\text{m} \\ &= 2.76\text{m (Worksheet A, Lines 6-8).} \end{aligned}$$

Dimensions of Base. The dimensions of the base are as follows:

$$\begin{aligned} \text{length (front to rear)} &= \text{toilet length plus } 0.15\text{m,} \\ \text{width} &= \text{toilet width plus } 0.15\text{m.} \end{aligned}$$

This leaves a 75mm area around the base to support the privy shelter. For example, if the outside dimensions of the toilet are:

$$\text{length} = 1.25\text{m, width} = 2.76\text{m, then the dimensions of the base are:}$$

length (front to rear) = 1.25m + 0.15m = 1.40m,  
width = 2.76m + 0.15m = 2.91m  
(Worksheet A, Lines 9-10).

Dimensions of Slabs. Each vault is covered with a squatting or sitting slab. For design criteria, see "Designing Slabs for Privies," SAN.1.D.1. The outside dimensions of each slab are as follows:

length (front to rear) = compost toilet length;  
width = compost toilet width divided by two. For example, if the dimensions of the toilet are:

length = 1.25m, width = 2.76m, then the dimensions of the slab are:

length = 1.25m  
width =  $\frac{2.76\text{m}}{2} = 1.38\text{m}$  (Worksheet A, Lines 11-12).

When all dimensions have been calculated, draw up a plan view similar to Figure 2 showing correct inside and outside dimensions. Give this drawing to the construction foreman before construction begins.

### Determining Materials, Tools and Labor

The walls and base of a compost toilet are made from reinforced concrete or brick and mortar. The slab is made from reinforced concrete. Concrete walls and base require cement, sand, gravel, and water; containers and tools for mixing and smoothing concrete; reinforcing materials; wood, hammer, saw, and nails for building forms; and at least one worker with some experience with concrete. See "Designing Septic Tanks," SAN.2.D.3, for complete details and specifications on concrete ingredients and reinforcing materials.

Brick and mortar walls and base require bricks or concrete blocks; cement, sand, and water for mortar and cement plaster; containers and tools for mixing and spreading mortar; and at least one worker with some experience with concrete.

A concrete slab requires the same materials, tools, and workers as for concrete walls and base.

Quantities. The quantities of materials needed can be estimated by adding the volumes of the slabs, outside walls, inside wall, and base.

Volume of slabs: see "Designing Slabs for Privies," SAN.1.D.1.

Volume of outside walls = 2 x [(length x height x thickness) + (width x height x thickness)].

Volume of inside wall = height times length times wall thickness (0.15m).

Volume of base = base length times base width times base thickness (0.10m).

For example, if the outside dimensions of the compost toilet are: height = 1.00m, length = 1.25m, width = 2.76m, base length = 0.40m, base width = 2.91m, then the approximate volume of materials equals:

volume of slabs

+ volume of outside walls = 2 x [(1.25m x 1.00m x 0.075m) + (2.76m x 1.00m x 0.075m)] = 2 x (0.094 + 0.207) = 0.60m<sup>3</sup>

+ volume of inside wall = 1.00m x 1.25m x 0.15m = 0.19m<sup>3</sup>

+ volume of base = 1.4m x 2.91m x 0.10m = 0.41m<sup>3</sup>.

Total volume equals volume of slabs + 0.60m<sup>3</sup> + 0.19m<sup>3</sup> + 0.41m<sup>3</sup> = volume of slabs + 1.20m<sup>3</sup> (Worksheet A, Lines 13-17).

When all materials, tools, and labor requirements have been determined, draw up a materials list similar to Table 3 and give it to the construction foreman before construction begins.

In summary, give the construction foreman a location map similar to Figure 1, design drawings similar to Figure 2, and a materials list similar to Table 3.

**Table 3. Sample Materials List**

Item	Description	Quantity	Estimated Cost
Labor	Foreman	1	_____
	Laborer (skilled with concrete)	1	_____
	Laborer (unskilled)	1	_____
Supplies	Wood (for forms)	_____	_____
	Nails (for forms)	_____	_____
	Cement (Portland)	_____	_____
	Sand (clean, sized fine to 6mm)	_____	_____
	Gravel (clean, sized 6-25mm)	_____	_____
	Water (clear)	_____	_____
	Reinforcing material	_____	_____
	Squatting slabs	_____	_____
	Vent pipes (with screens)	_____	_____
	Tin sheets (to cover rear wall openings)	_____	_____
Other	_____	_____	
Tools	Measuring tape	1	_____
	Hammer	1	_____
	Saw	1	_____
	Shovels	2	_____
	Trowel	1	_____
	Container for mixing concrete	2	_____
	Carpenter's level or equivalent (optional)	1	_____
	Carpenter's square or equivalent (optional)	1	_____
	Tar or equivalent (for sealing covers over rear openings)	_____	_____
	Other	_____	_____

Total Estimated Cost = \_\_\_\_\_

### Worksheet A. Compost Toilet Calculations

1. Number of persons using compost toilet = 5
2. Volume of each vault =  $0.27\text{m}^3 \times \text{Line 1} = 0.27\text{m}^3 \times \underline{5} = \underline{1.35}\text{m}^3$

#### Inside Dimensions of Each Vault

3. Proposed height = 1.00 m
4. Proposed length (front to rear) = 1.10 m
5. Required width =  $\frac{\text{Line 2}}{\text{Line 3} \times \text{Line 4}} = \frac{(1.35\text{m}^3)}{(1.00\text{m}) \times (1.10\text{m})} = \underline{1.23}\text{m}$

#### Outside Dimensions of Compost Toilet

6. Height = Line 3 = 1.00 m
7. Length (front to rear) = Line 4 + (2 x 0.075m) = 1.10 m + 0.15m + 1.25 m
8. Width = (2 x Line 5) + (2 x 0.075m) + 0.15m = (2 x 1.23 m) + 0.15m + 1.15m = 2.46 m + 0.30m = 2.76 m

#### Dimensions of Base

9. Length (front to rear) = Line 7 + 0.15m = 1.25 m + 0.15m = 1.40 m
10. Width = Line 8 + 0.15m = 2.76 m + 0.15m = 2.91 m

#### Dimensions of Each Slab

11. Length (front to rear) = Line 7 = 1.25 m
12. Width =  $\frac{\text{Line 8}}{2} = \frac{(2.76\text{m})}{2} = \underline{1.38}\text{m}$

#### Quantities

13. Volume of slabs - see "Designing Slabs for Privies," SAN.1.D.1
14. Volume of outside walls = 2 x [(Line 6 x Line 7 x 0.075m) + (Line 6 x Line 8 x 0.075m)]  
 $= 2 \times [(1.00\text{ m} \times 1.25\text{ m} \times 0.075\text{m}) + (1.00\text{ m} \times 2.76\text{ m} \times 0.075\text{m})]$   
 $= 2 \times (0.09\text{ m}^3 + 0.21\text{ m}^3) = 2 \times 0.30\text{ m}^3 = \underline{0.60}\text{ m}^3$
15. Volume of inside wall = Line 6 x Line 7 x 0.15m = 1.00 m x 1.25 m x 0.15m = 0.19 m<sup>3</sup>
16. Volume of base = Line 9 x Line 10 x 0.10m = 1.40 m x 2.91 m x 0.10m = 0.41 m<sup>3</sup>
17. Total volume - volume of slabs + line 14 + Line 15 + Line 16 =  
 volume of slabs +  $\underline{0.60}\text{ m}^3 + \underline{0.19}\text{ m}^3 + \underline{0.41}\text{ m}^3 =$   
 volume of slabs + 1.20 m<sup>3</sup>

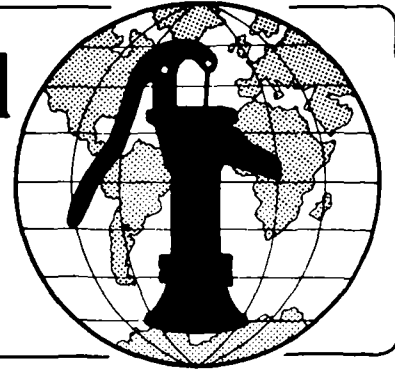
## Notes

## Notes

**Technical Notes** are part of a set of "Water for the World" materials produced under contract to the U.S. Agency for International Development by National Demonstration Water Project, Institute for Rural Water, and National Environmental Health Association. Artwork was done by Redwing Art Service. Technical Notes are intended to provide assistance to a broad range of people with field responsibility for village water supply and sanitation projects in the developing nations. For more detail on the purpose, organization and suggestions for use of Technical Notes, see the introductory Note in the series, titled "Using 'Water for the World' Technical Notes." Other parts of the "Water for the World" series include a comprehensive Program Manual and several Policy Perspectives. Further information on these materials may be obtained from the Development Information Center, Agency for International Development, Washington, D.C., 20523, U.S.A.



# Water for the World



## Designing Sumps, Soakage Pits and Soakage Trenches Technical Note No. SAN. 1.D.7

Sumps, soakage pits, and soakage trenches receive washwater or effluent from an aqua privy and allow it to soak safely into the ground. Designing these disposal systems involves selecting a location, determining the type and size of the system, and determining necessary labor, supplies, and tools for construction. The products of the design process are: (1) a location map, (2) technical drawings of the disposal system, and (3) a detailed materials list. These products will be given to the construction foreman before construction begins.

This technical note describes how to design sumps, soakage pits, and soakage trenches and how to produce the three end-products listed above. Read the entire technical note before beginning the design process.

### Useful Definitions

**CONTAMINATE** - To make unclean by introducing an infectious (disease-causing) impurity such as bacteria from washwater.

**EFFLUENT** - Settled sewage.

**GROUNDWATER LEVEL** - The level to which subsurface water rises during any given time of year.

**IMPERVIOUS** - Not allowing liquid to pass through.

**PERMEABLE** - Allowing liquid to soak in.

**WASHWATER** - Water that has been used for bathing, washing clothes, dishes, or kitchen utensils.

### Materials Needed

Measuring tape - To obtain accurate field information for a location map.

Scale - To draw a location map.

### Location

Washwater disposal systems should be downhill from water wells. They should be at least:

30m from the nearest water supply,  
6m from the nearest dwelling,  
3m from trees or bushes,  
3m from nearest property line.

Do not put the system in an area where surface water will stand on it or flow over it.

After a proposed site has been selected, it must be tested for soil suitability. The three tests which must be made are: soil type; groundwater levels; and impervious layers.

**Soil Type.** The soil must be permeable, but it must not allow washwater or effluent to soak in too fast or the groundwater may become contaminated. Soil may be divided into roughly six types:

(1) Sand. Individual grains are easily seen and felt.

(2) Sandy Loam. Contains a large percentage of sand, but squeezed when moist a handful will hold its shape.

(3) Loam. Feels fairly smooth, yet slightly gritty.

(4) Silt Loam. Feels soft and floury; clods are easily crumbled.

(5) Clay Loam. Fine-textured; clods are hard.

(6) Clay. Fine-textured; clods are very hard.

If you have trouble identifying the soil, see "Determining Soil Suitability," SAN.2.P.3, for a more complete description. When the soil at the proposed disposal site has been identified, use Table 1 to determine soil suitability.

**Table 1. Soil Suitability**

Soil Type	Suitable
Sand	No
Sandy loam	Yes
Loam	Yes
Silt loam	Yes
Clay loam	No
Clay	No

If the soil is not suitable, select another location. If no good location can be found on the lot, washwater will have to be piped or carted to another location. If no suitable location can be found, design a more complex disposal system (see "Designing Sewer Systems," SAN.2.D.4, and "Designing Non-Conventional Washwater and Excreta Disposal Systems," SAN.2.D.8). If the soil is suitable, test for groundwater levels.

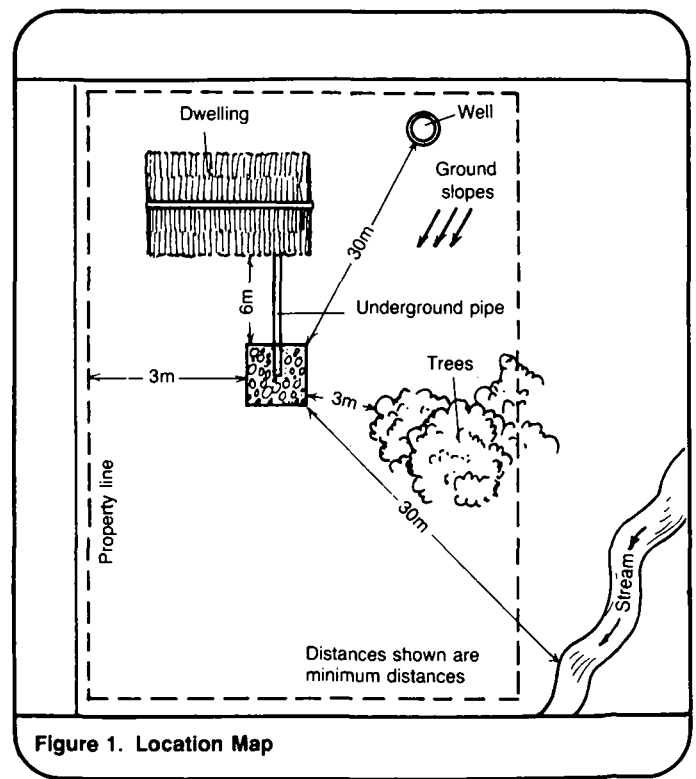
Groundwater Levels. Washwater disposal systems must be at least 1.0m above the groundwater level during the wettest season of the year. This information may be available from local residents, water well owners, or water well drillers. If the information is not available or reliable, field tests must be made. These tests are described in detail in "Determining Soil Suitability," SAN.2.P.3. In

brief, a test hole must be dug 1.0m deeper than the proposed disposal system. Dig the test hole during the wettest season. If no groundwater is observed, groundwater levels are suitable.

If groundwater levels are not suitable, select another location. If groundwater levels are suitable, test for impervious layers.

Impervious Layers. Washwater disposal systems must be at least 1.0m above impervious layers such as creviced rock, hardpan, shale, or clay. The same test hole dug for determining groundwater levels can be used to determine the presence or absence of impervious layers. If impervious layers appear while the test hole is being dug, another location must be found. If there are no impervious layers, the site is suitable for washwater disposal.

When a suitable site has been found, draw a location map similar to Figure 1, showing the disposal site and distances to water supplies, dwellings, and property lines. Give this map to the construction foreman before construction begins.



**Table 2. Selecting a Disposal Method Based on Washwater Quantities**

Quantity of Washwater	Disposal Method
More than 50 liters per person per day	See "Planning Combined Washwater and Excreta Disposal Systems," SAN.2.P.1
Less than 50 but more than 5 liters per person per day	Soakage pit or soakage trench
Less than 5 liters per person per day	Sump (pit-type or drum-type)

**Determining Type of Washwater Disposal Method**

There are four factors to consider when selecting a disposal method: quantity of washwater; available materials; depths of groundwater and impervious layers; and lot size.

Quantity of Washwater. Estimate the average amount of washwater generated daily by each person in the dwelling to be served. "Estimating Sewage or Washwater Flows," SAN.2.P.2, describes several ways of doing this. When the quantity has been determined, use Table 2 to select a washwater disposal method.

Available Materials. To keep costs down, washwater disposal systems should be made from locally available materials. Table 3 lists the materials required for each disposal method. The table can be used to help decide between a pit-type sump and drum-type sump, or between a soakage pit and a soakage trench.

Depths of Groundwater and Impervious Layers. These factors may affect the decision between a soakage pit and a soakage trench because trenches are shallower than pits. Trenches are 0.6-1.0m deep and pits are 1.0-3.0m deep. Groundwater levels and impervious layers must be at least 1.0m below the bottom of these systems. Groundwater and impervious levels for soakage trenches are 1.6-2.0m below ground, and for soakage pits they are 2.0-4.0m below ground. Table 4 summarizes this information.

**Table 4. Groundwater and Impervious Layers Affecting Disposal Methods**

Depth of Groundwater or Impervious Layers	Acceptable Disposal Method
1.6m - 2.0m	Soakage Trench
2.0 or more	Soakage Pit or Soakage Trench

**Table 3. Materials for Washwater Disposal Methods**

Method	Materials
Sump (pit-type)	Concrete blocks, bricks, or stones; gravel or pebbles; a lid (wood or metal)
Sump (drum-type)	200-liter steel drum; a lid (wood or metal)
Soakage Pit	Rocks; straw, hay, or grass; clay, plastic, or galvanized metal pipe (50-100mm diameter) long enough to extend from dwelling to pit
Soakage Trench	Gravel, pebbles; concrete blocks or perforated or open-jointed sewer pipe; clay, plastic, or galvanized metal pipe (50-100mm diameter) extending from dwelling to trench; straw, hay, or grass

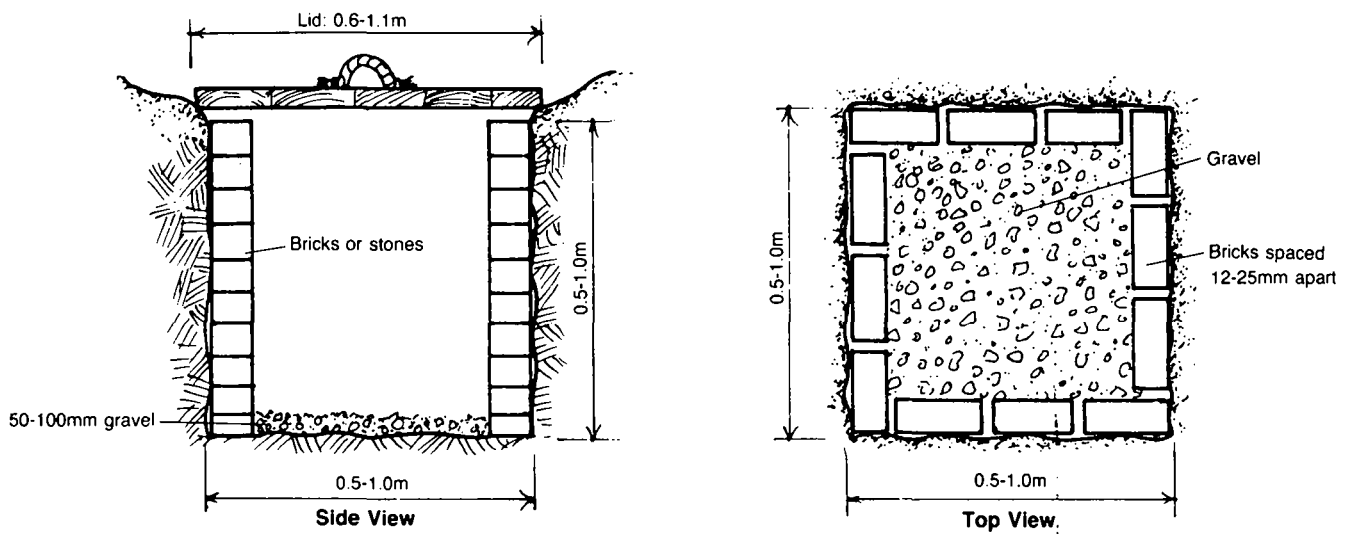


Figure 2. Pit-type Sump

Lot Size. This may affect the decision between a soakage pit and a soakage trench because trenches are longer than pits and may require more land area. Determine the size of the trench, then use the location map to determine if it will fit on the lot. If it will not, a pit may have to be used instead.

### Determining the Size of the System

Because of the small amounts of washwater disposed of in a sump, the size is not too critical and need not be calculated. For a pit-type sump, it is sufficient if the pit is 0.5-1.0m deep and 0.5-1.0m in diameter as shown in Figure 2. For a drum-type sump, the pit should be dug just large enough to contain the 200-liter steel drum as shown in Figure 3.

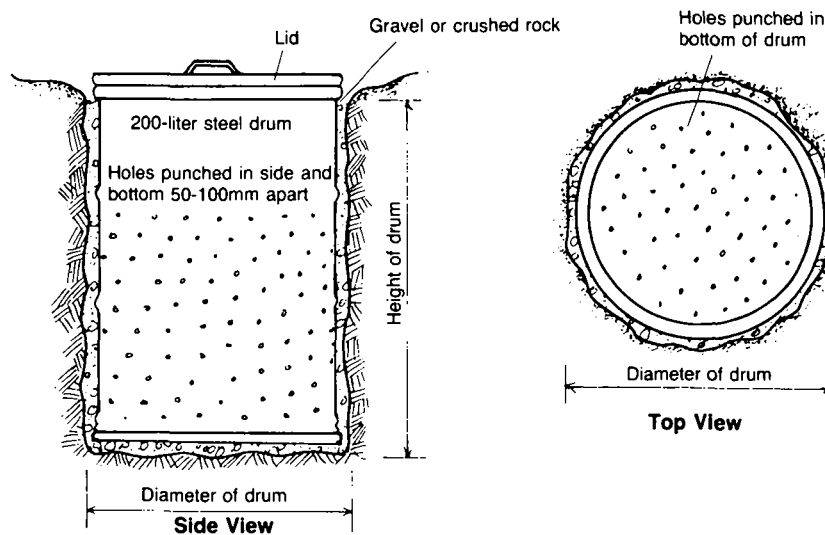


Figure 3. Drum-type Sump

The size of a soakage pit or soakage trench depends on the area of permeable soil needed. This varies according to the quantity of washwater generated each day and the rate at which the soil can soak up the liquid. It is safe to assume that the amount of washwater generated is 50 liters per person per day and that the soil will absorb liquid at a rate of 30 liters per square meter per day. The area of permeable soil needed for one person is 50 liters/day divided by 30 liters/day/square meter:

$$\frac{50 \text{ liters/day}}{30 \text{ liters/day/m}^2} = 1.7\text{m}^2$$

To find the area of permeable soil needed for washwater disposal for a dwelling, multiply 1.7m<sup>2</sup> times the number of people living in the dwelling. For example, if five persons live there, the required area for a disposal system is 5 x 1.7m<sup>2</sup> = 8.5m<sup>2</sup> (see Worksheet A, Lines 1 and 2).

Determining Trench Size. Trenches are 0.6-1.0m wide and can be as long as 30m as shown in Figure 4. The area of the bottom of the trench must be at least as great as the area of permeable soil needed. In the previous example, this area would be 8.5m<sup>2</sup>.

To find the length of the trench, divide the area by the width. For example, if the desired width is 0.8m, then the length is:

$$\frac{8.5\text{m}^2}{0.8\text{m}} = 10.7\text{m} \text{ (see Worksheet A, lines 3 and 4).}$$

Determining Pit Size. Pits may be square, rectangular, or circular, as shown in Figure 5. The area of the

pit below the inlet pipe must be at least as great as the area of permeable soil needed. If the pit is square or rectangular, find the area by adding the areas of the four earth walls below the inlet to the area of the bottom. If the pit is circular, find the area by adding the area of the circular wall below the inlet to the area of the bottom.

To find the size of a square or rectangular pit, first decide on the desired length and width, then calculate the depth below the inlet pipe that will give the pit the required area.

For example, suppose the area of permeable soil needed is 8.5m<sup>2</sup>, the desired length is 1.5m and the desired width is 1.2m. The area of the bottom is the length times width = 1.5m x 1.2m = 1.8m<sup>2</sup>. The area of the walls is the total area minus the bottom area = 8.5m<sup>2</sup> minus 1.8m<sup>2</sup> = 6.7m<sup>2</sup>. The circumference is the sum of the lengths of the sides = 1.2m + 1.5m + 1.2m + 1.5m = 5.4m. The necessary depth of the pit below the inlet pipe is the wall area divided by the circumference =  $\frac{6.7\text{m}^2}{5.4\text{m}} = 1.24\text{m}$  (see Worksheet A, Lines 5-10).

To find the size of a circular pit, first determine the desired diameter or circumference, then calculate the necessary depth below the inlet pipe. When calculating the area of a circular pit, the following information will be helpful:

$$d = \text{diameter} \quad \text{circumference} = 3.1 \times d$$

$$\text{area of bottom} = \frac{3.1}{4} \times d^2$$

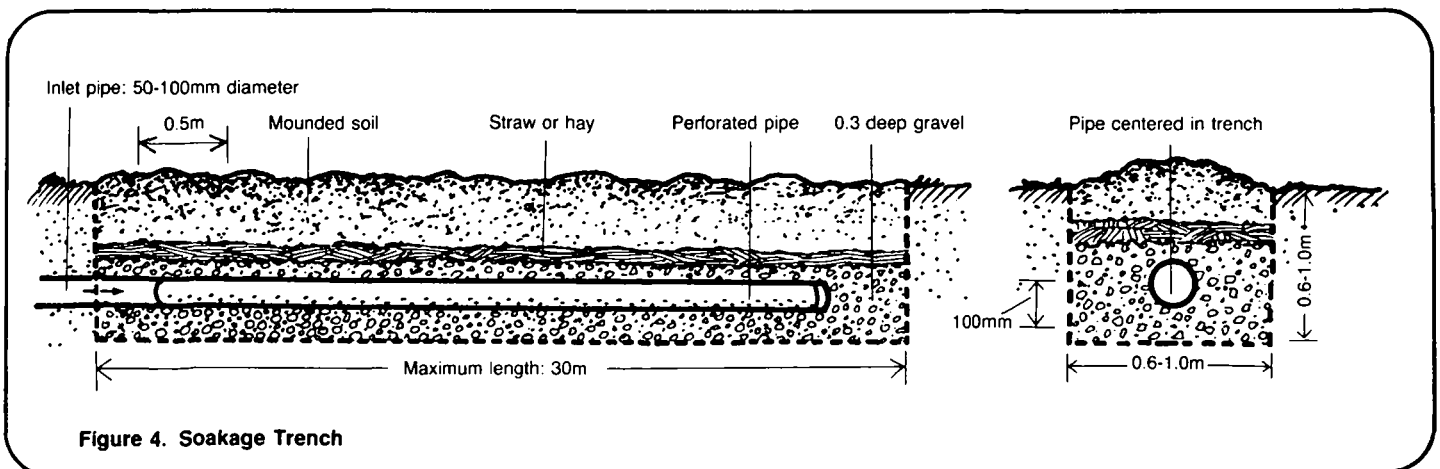


Figure 4. Soakage Trench

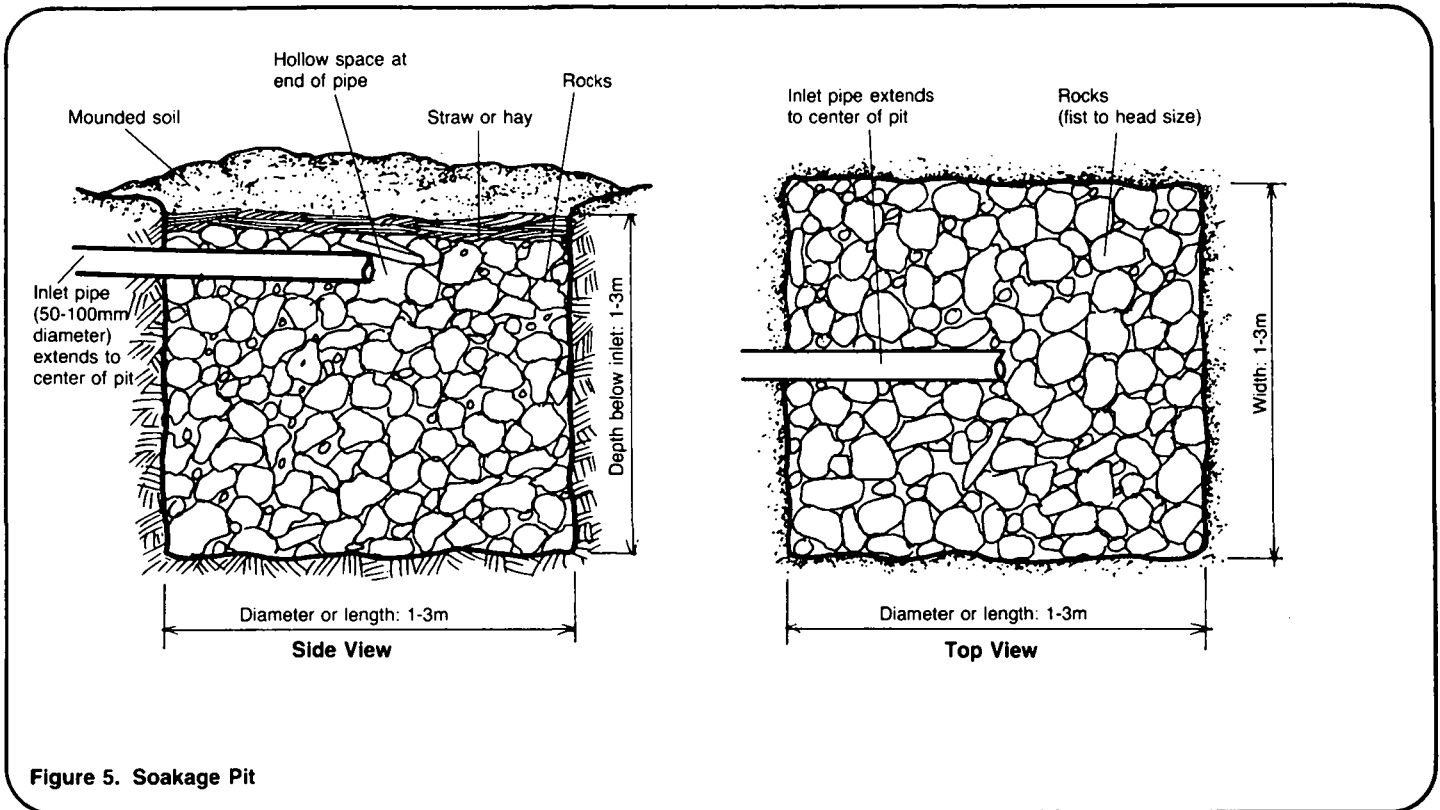


Figure 5. Soakage Pit

For example, suppose the necessary area of permeable soil is  $8.5\text{m}^2$  and the desired diameter is  $1.4\text{m}$ . The bottom area is the diameter squared times  $3.1 = 1.4 \times 1.4 \times .78 = 1.5\text{m}^2$ . The

wall area is the total area minus the bottom area  $= 8.5\text{m}^2 - 1.5\text{m}^2 = 7.0\text{m}^2$ . The circumference is the diameter times  $3.1 = 1.4\text{m} \times 3.1 = 4.34\text{m}$ . The necessary depth of the pit below the inlet pipe is the wall area divided by the circumference  $= \frac{7.0\text{m}^2}{4.34\text{m}} = 1.6\text{m}$

(see Worksheet A Lines 11-15).

### Summary of Design Information

**Pit-Type Sump.** The pit is  $0.5\text{--}1.0\text{m}$  deep and  $0.5\text{--}1.0\text{m}$  in diameter. It is lined with concrete blocks, bricks, or stones to prevent the sides from collapsing, and the bottom is covered with  $50\text{--}100\text{mm}$  of gravel or small pebbles. The pit is covered with a lid strong enough to prevent an adult from falling in.

**Drum-Type Sump.** The pit is deep enough and wide enough to just hold a  $200\text{-liter}$  drum, with holes punched in the bottom and the lower half of the sides. A strong lid covers the drum.

**Soakage Pit.** The pit is  $1.0\text{--}3.0\text{m}$  deep and  $1.0\text{--}3.0\text{m}$  in diameter and is nearly filled with rocks ranging from fist-size to head-size. A  $50\text{--}100\text{mm}$  pipe extends underground from the dwelling to a point near the top center of the pit and is covered with rocks. The pit is covered with hay or straw and mounded with soil.

**Soakage Trench.** The trench is  $0.6\text{--}1.0\text{m}$  deep,  $0.5\text{--}1.0\text{m}$  wide and up to  $30\text{m}$  long. It is filled to a depth of  $0.3\text{m}$  with gravel or small pebbles, equipped with open-jointed or perforated pipe or concrete blocks, covered with straw or hay, and mounded with soil. A  $50\text{--}100\text{mm}$  pipe extends underground from the dwelling to a point  $0.5\text{m}$  into the trench and about  $100\text{mm}$  above the bottom. The bottom of the trench slopes gradually away from the inlet end.

### Materials List

Building washwater disposal system requires a foreman and at least one laborer to excavate the sump, trench, or pit. Larger pits or trenches may require additional laborers. The type and amount of supplies needed depend on the size and kind of system. Table 5 shows a sample materials list.

**Worksheet A. Calculating the Size of a Soakage Trench or Soakage Pit**

System Type (check one)       Trench                       Pit

1. Number of persons in dwelling to be served = 5

2. Necessary area of permeable soil = Line 1 x 1.7m<sup>2</sup> = 5  
x 1.7m<sup>2</sup> = 8.5 m<sup>2</sup>

If System is a Trench

3. Proposed width of trench = 0.8 m

4. Necessary length of trench =  $\frac{\text{Line 2}}{\text{Line 3}} = \frac{8.5 \text{ m}^2}{0.8 \text{ m}} = \underline{10.7} \text{ m}$

If System is a Pit

Pit Type (check one)       square or rectangular       circular

For a square or rectangular pit:

5. Proposed length of pit = 1.5 m

6. Proposed width of pit = 1.2 m

7. Area of pit bottom = Line 5 x Line 6 = 1.5 m x 1.2 m = 1.8 m<sup>2</sup>

8. Wall area = Line 2 minus Line 7 = 8.5 m<sup>2</sup> - 1.8 m<sup>2</sup> = 6.7 m<sup>2</sup>

9. Circumference = Line 5 + Line 5 + Line 6 + Line 6 =  
1.5 m + 1.5 m + 1.2 + 1.2 m = 5.4 m

10. Required depth below inlet =  $\frac{\text{Line 8}}{\text{Line 9}} = \frac{6.7 \text{ m}^2}{5.4 \text{ m}} = \underline{12.4} \text{ m}$

For a circular pit:

11. Proposed diameter = 1.4 m

12. Area of bottom = Line 11 x Line 11 x  $\frac{3.1}{4}$  = 1.4 m x 1.4 m  
x .78 = 1.5 m<sup>2</sup>

13. Wall area = Line 2 minus Line 12 = 8.5 m<sup>2</sup> - 1.5 m<sup>2</sup> = 7.0 m<sup>2</sup>

14. Circumference = Line 11 x 3.1 = 1.4 m x 3.1 = 4.34 m

15. Required depth below inlet =  $\frac{\text{Line 13}}{\text{Line 14}} = \frac{7.0 \text{ m}^2}{4.34 \text{ m}} = \underline{1.6} \text{ m}$

**Table 5. Sample Materials List for Wastewater Disposal System**

Item	Description	Quantity	Estimated Cost
Labor	Foreman	1	_____
	Laborers	2	_____
Supplies	Gravel or pebbles (enough to fill trench to a depth of 0.3m)	_____ m <sup>3</sup>	_____
	Straw (enough to cover entire trench)	_____	_____
	Galvanized metal pipe, 100mm diameter, extends from dwelling to trench	_____ m	_____
	Open-jointed pipe (length of trench)	_____ m	_____
Tools	Measuring tape	1	_____
	Shovels	2	_____
	Wheelbarrow	1	_____
	Other	_____	_____

Total Estimated Cost = \_\_\_\_\_

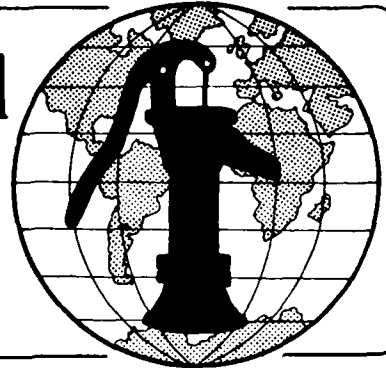
Few tools are required to build these systems. A measuring tape is needed to lay out the system on the ground. One or more shovels are necessary for excavation. A wheelbarrow is useful to haul materials to the site and haul away excavated soil. For a drum-type sump, you will need a hammer and a spike or large nail to punch holes in the drum.

When the necessary labor, tools, and materials have been determined, estimate the cost of each item. Prepare a materials list similar to Table 5 showing each item and its estimated cost. Give this to the construction foreman before construction begins. In summary, give the construction foreman a location map similar to Figure 1, technical drawings similar to one or more of Figures 2, 3, 4 and 5, and a materials list similar to Table 5.

**Technical Notes** are part of a set of "Water for the World" materials produced under contract to the U.S. Agency for International Development by National Demonstration Water Project, Institute for Rural Water, and National Environmental Health Association. Artwork was done by Redwing Art Service. Technical Notes are intended to provide assistance to a broad range of people with field responsibility for village water supply and sanitation projects in the developing nations. For more detail on the purpose, organization and suggestions for use of Technical Notes, see the introductory Note in the series, titled "Using 'Water for the World' Technical Notes." Other parts of the "Water for the World" series include a comprehensive Program Manual and several Policy Perspectives. Further information on these materials may be obtained from the Development Information Center, Agency for International Development, Washington, D.C., 20523, U.S.A.



# Water for the World



## Constructing Slabs for Privies Technical Note No. SAN.1.C.1

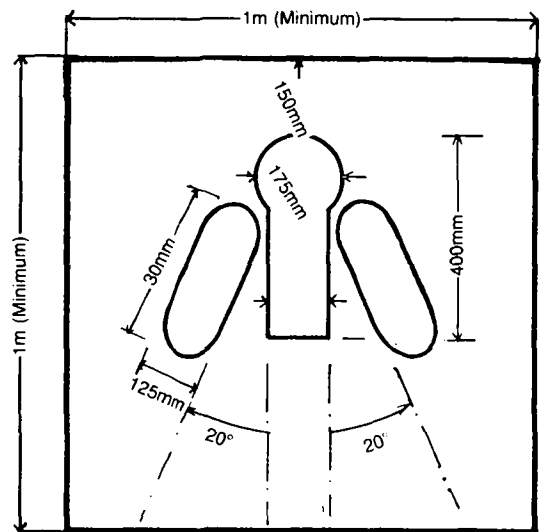
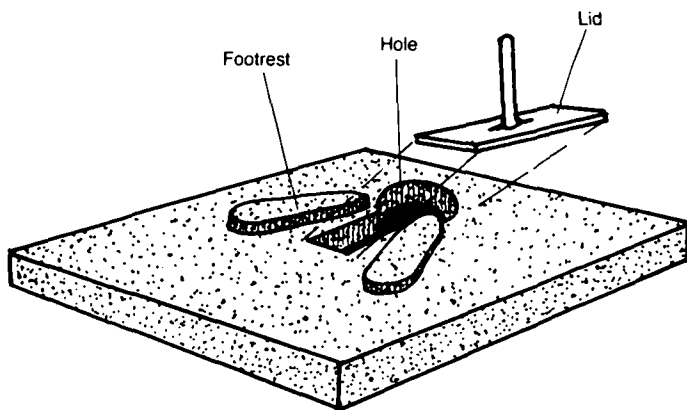
The slab is the floor of the privy. It covers the pit and has a hole through which to defecate. Constructing a slab involves assembling materials, tools, and labor, and building either a squatting slab or a sitting slab (seat and pedestal) to the correct dimensions. It may also involve building a cover for an off-set pit and building or installing improvements (vent pipe, pour-flush bowl, or chute).

This technical note describes each step in constructing a slab. Read the entire technical note before beginning construction.

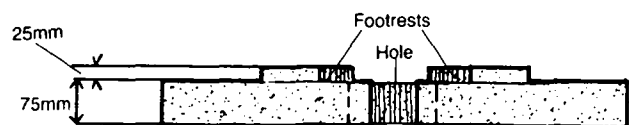
### Materials Needed

The project designer must provide several documents before construction can begin:

1. Technical drawings similar to Figures 1-9, showing correct dimensions of the slab, lid, pit cover (if off-set pit), and any improvements;
2. Materials list, similar to the sample shown in Table 1, noting all supplies, tools, and labor needed to construct the slab.

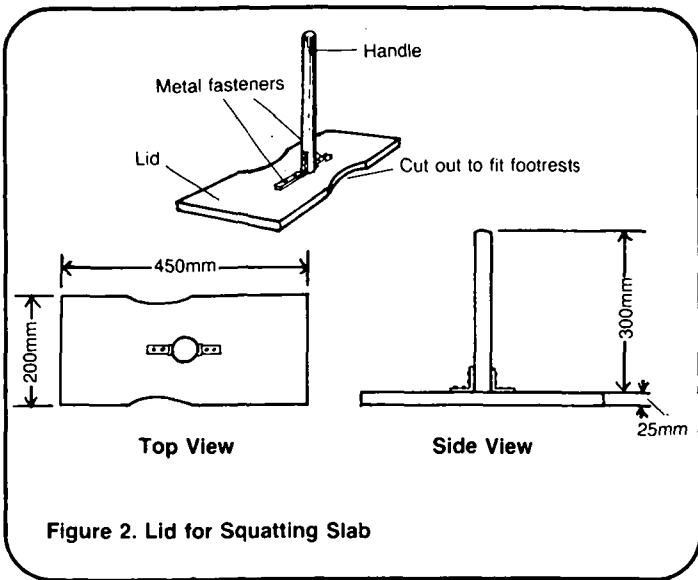


Top View



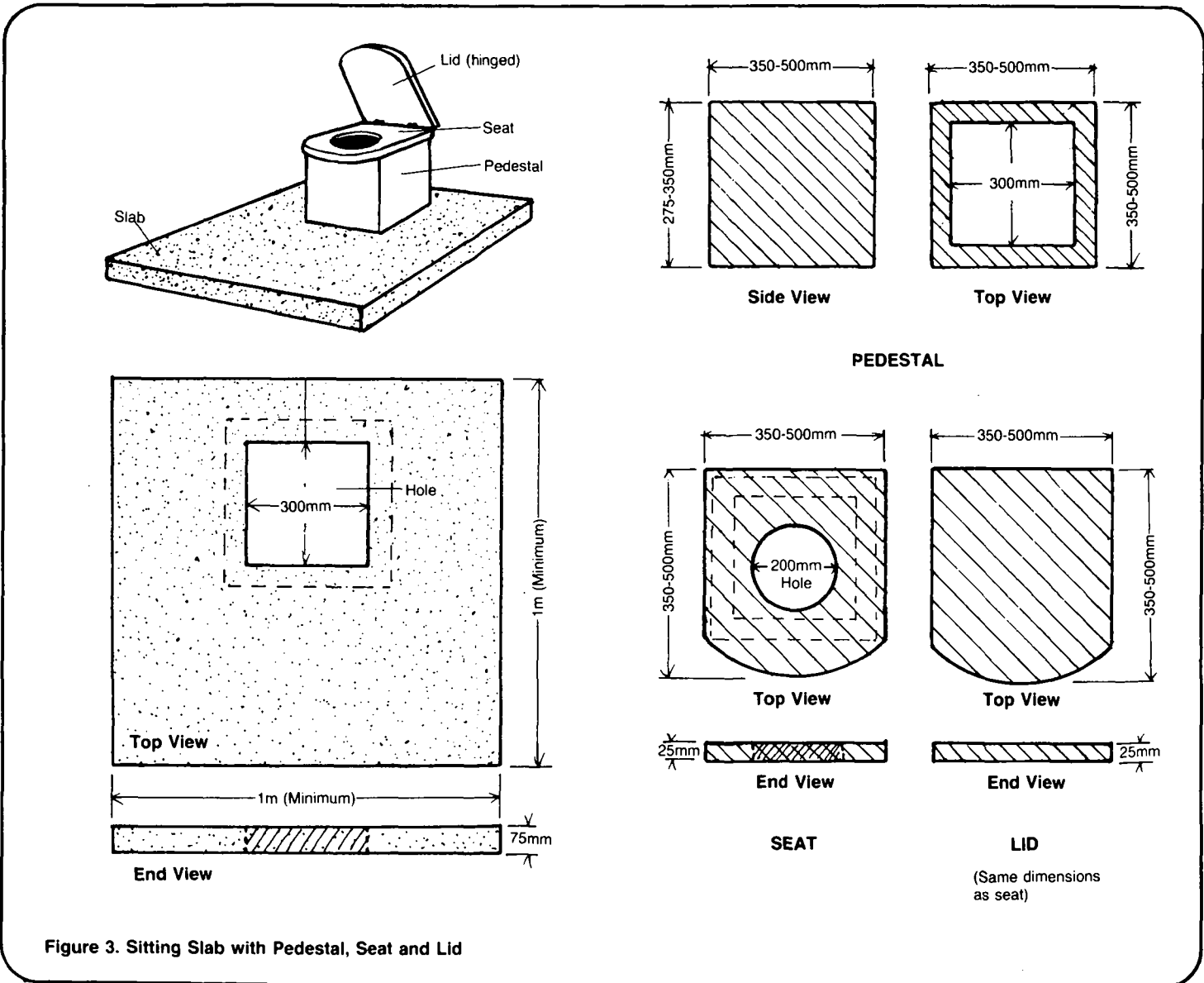
End View

Figure 1. Squatting Slab



**Caution!**

1. Wear gloves to prevent cuts when working with tin or galvanized metal sheets which may have sharp edges.
2. Pick up all metal scraps and nails after construction to prevent injuries to people walking barefoot in the area.
3. Avoid back and hand injuries when moving a completed slab into place. The slab may weigh over 180 kilos and will require four to eight men to move.



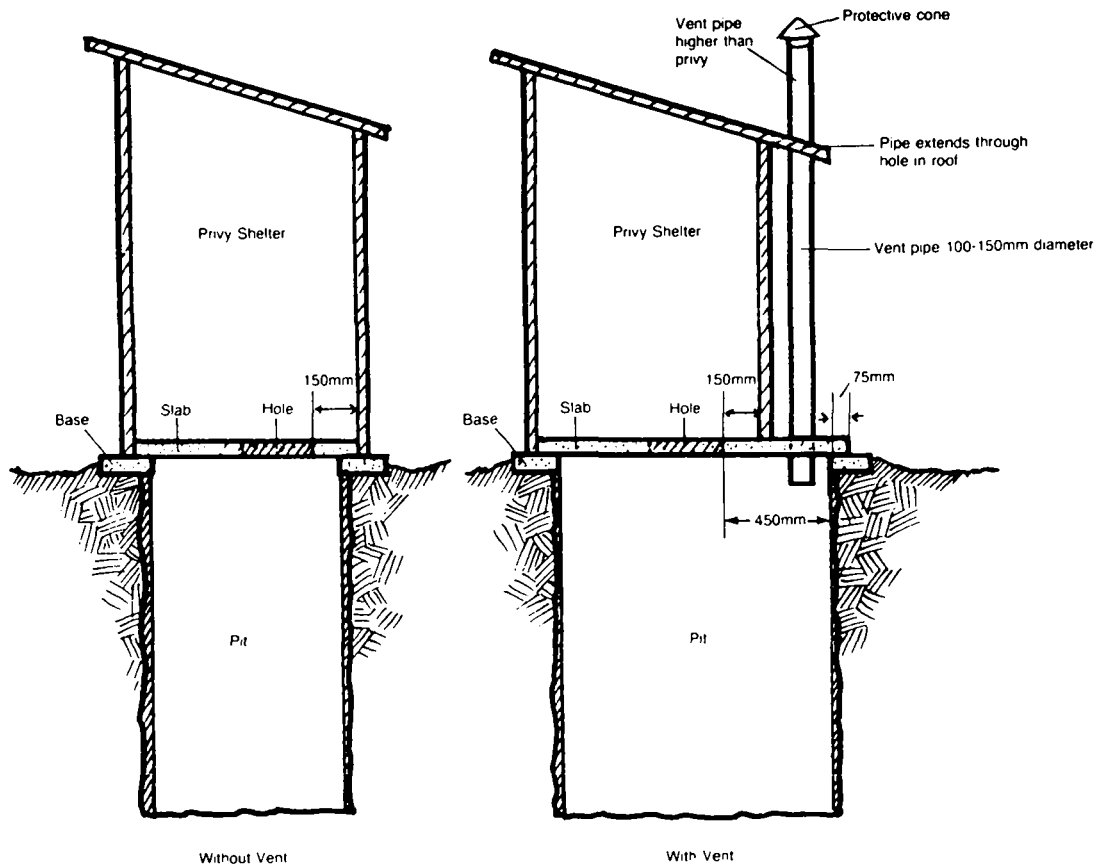


Figure 4. Comparison of Privies with and without Vent

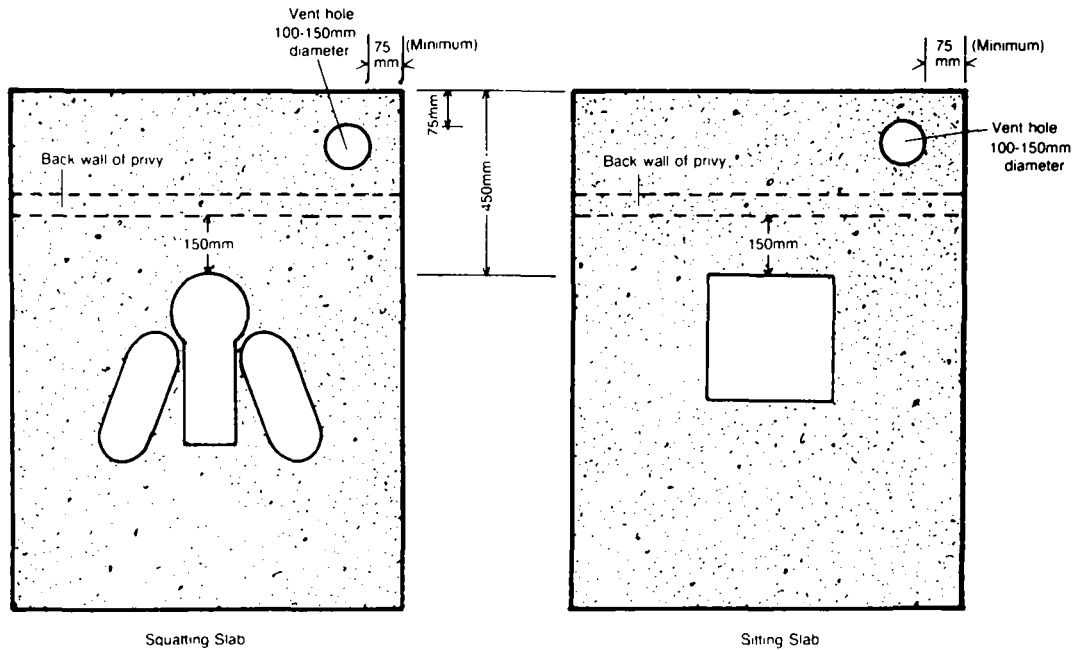
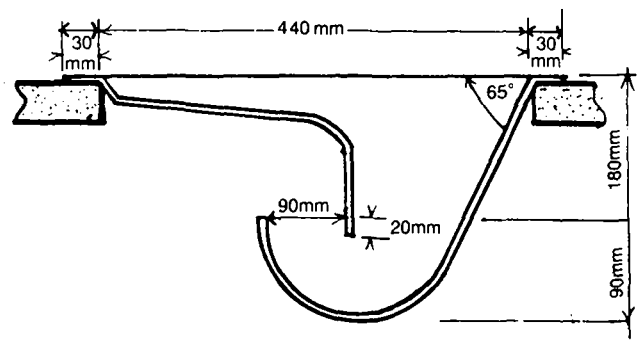
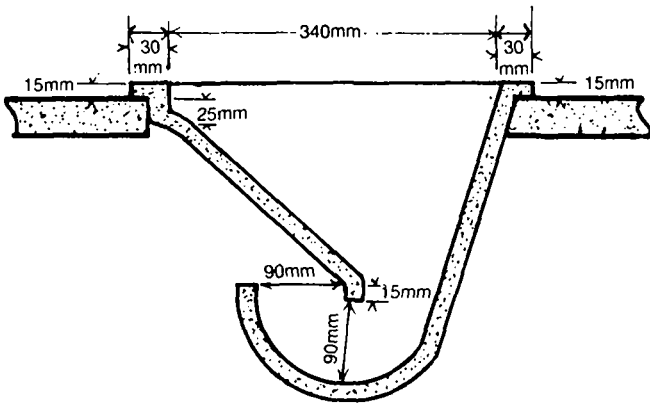
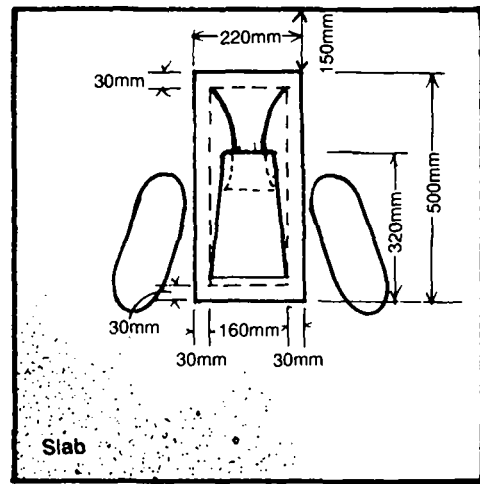
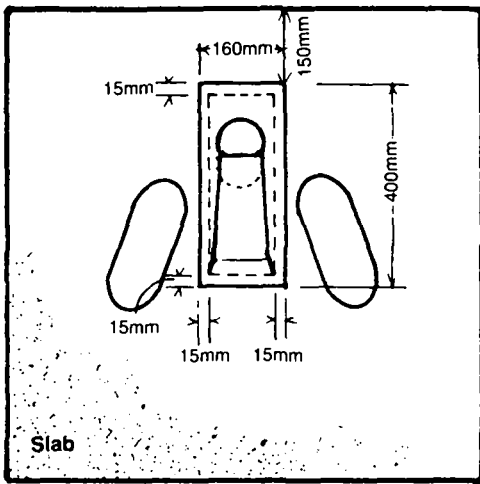


Figure 5. Top View of Slabs Showing Vent Hole Placement



a. Pre-cast Concrete

b. Galvanized Metal

Figure 6. Pour-Flush Bowls for Squatting Slabs

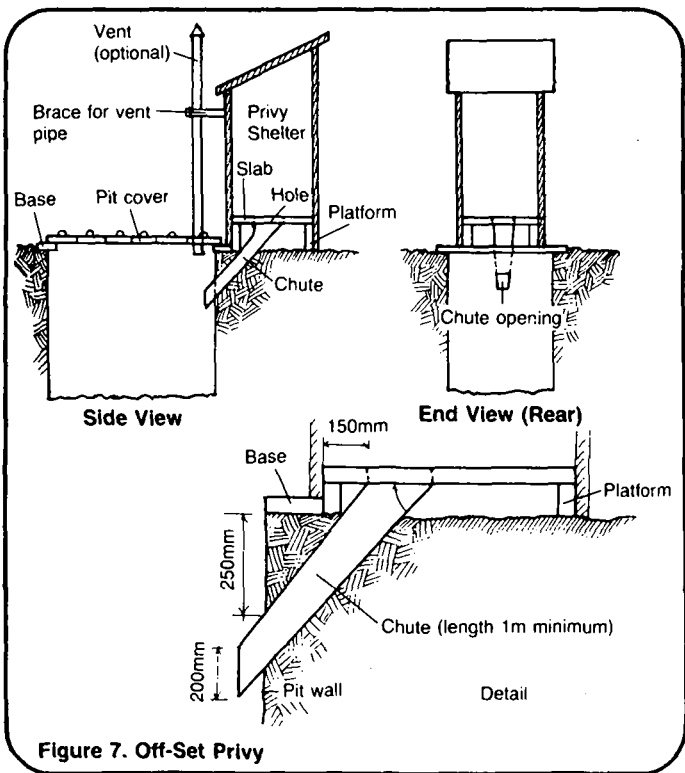
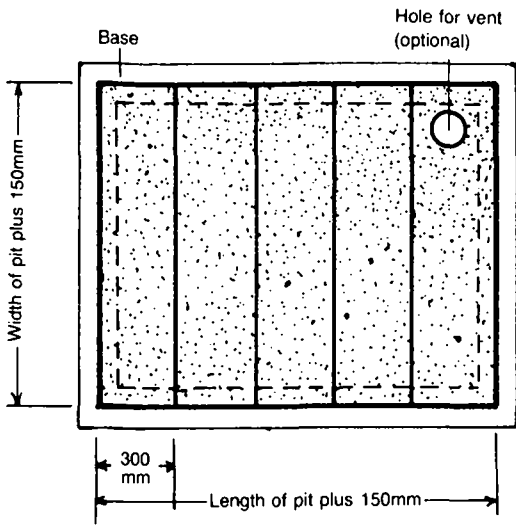
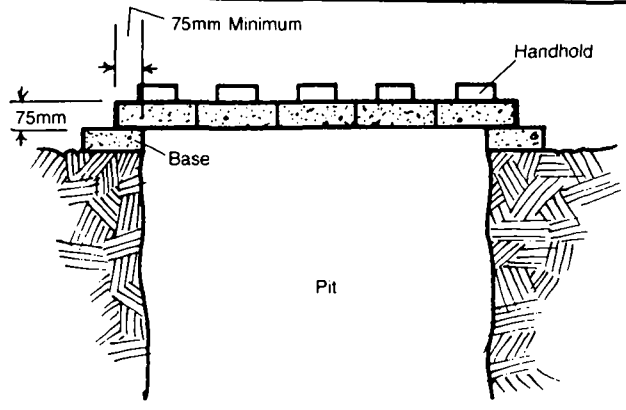


Figure 7. Off-Set Privy

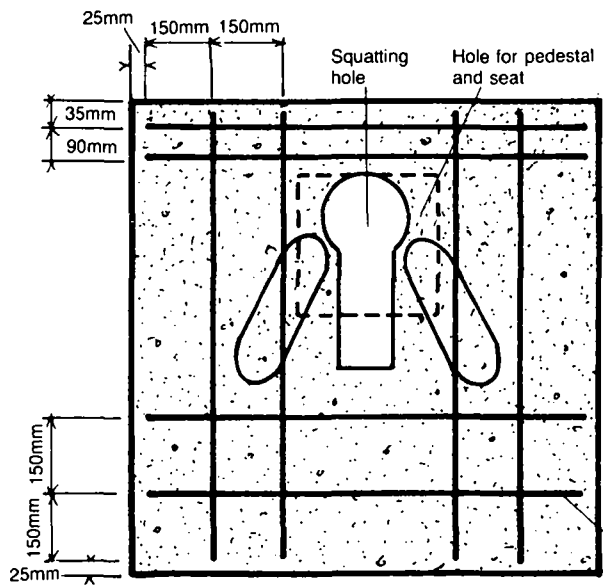


Top View



Side View

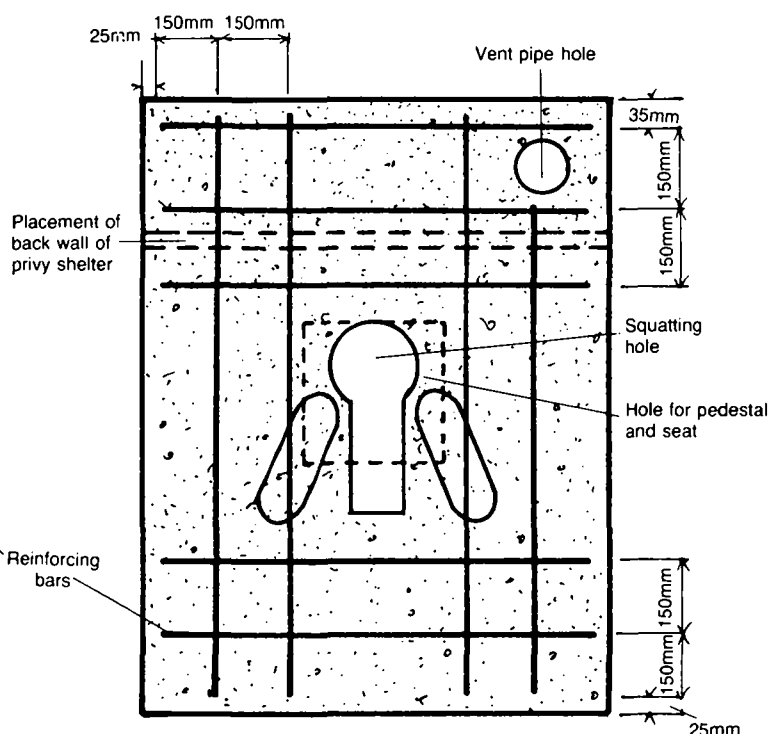
Figure 8. Cover for Offset Pit



Top View



End View



With Vent Hole

Figure 9. Placement of Reinforced Bars in Concrete Slab



**Table 2. Sample Work Plan for Constructing Reinforced Concrete Squatting Slab**

Time Estimate	Day Number	Task	Personnel	Tools/Materials
5 hours	1	Build wooden forms for the slab	Foreman and one skilled workman (Note: Foreman present during all phases of construction)	Measuring tape, wood, saw, hammer, nails, oil
5 hours	2	Mix and pour concrete; set reinforcing material	1 skilled workman, 2 laborers	Cement, sand, gravel, water, reinforcing material, container for mixing, 2 shovels, trowel
½ hour	2	Cover concrete and keep moist	1 laborer	Wet straw
½ hour	3	Remove wood plug for squatting hole, after concrete has taken initial set	1 laborer	None
5 days	3-7	Keep concrete covered and moist	1 laborer	Wet straw
3 hours	8	Separate slab from wooden forms; place slab over pit	4-8 laborers	Hammer (or nail-puller)
2 hours	8	Build lid for squatting hole; set in place	1 skilled workman	Measuring tape, wood, hammer, saw, nails

### Construction Steps

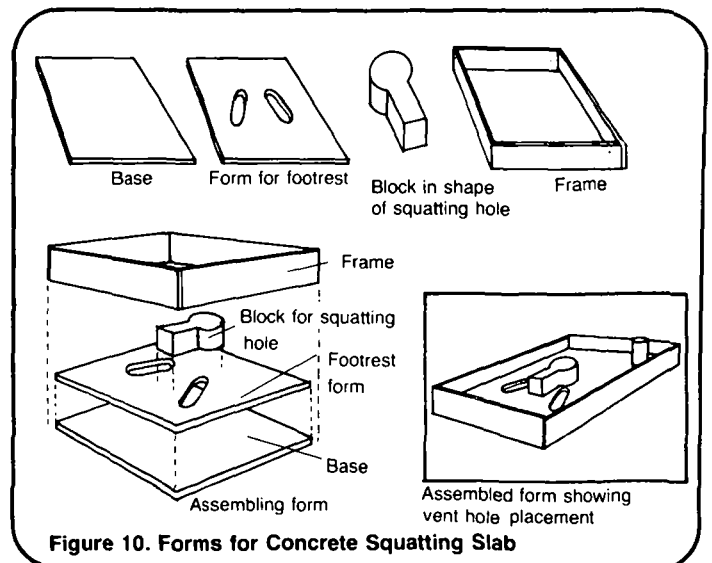
Depending on local conditions, availability of materials, skills of workers, and so on, some construction steps will take only a few hours, while others may require a day or more. Read the construction steps and make a rough estimate of the time required for each step, based on local conditions. You will then have an idea of when during the construction process specific laborers, supplies, and tools must be available. Draw up a work plan similar to Table 2 showing the construction steps and the time estimated for each.

Assemble all laborers, supplies, tools, and drawings needed to begin construction. Study all diagrams carefully.

For a reinforced concrete squatting slab:

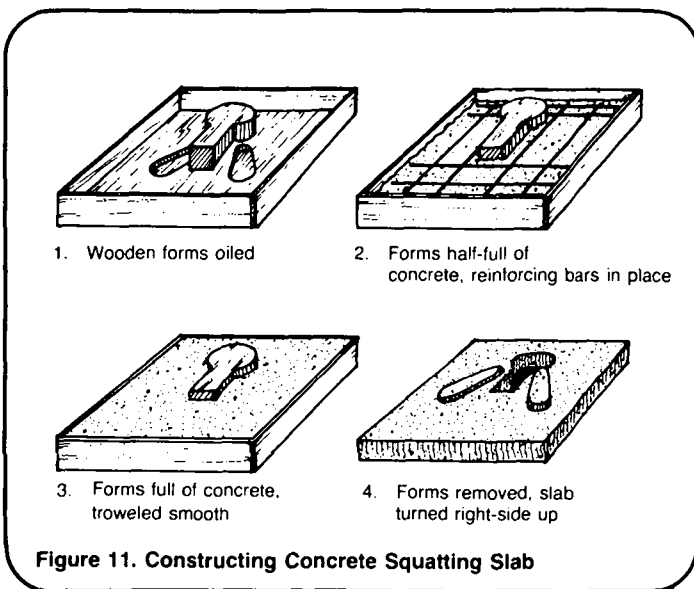
1. Build wooden forms similar to Figure 10. For a ventilated privy see the inset on Figure 10. Note that the

squatting hole and the hole for the vent pipe are produced from solid wood blocks and the raised footrests from holes cut in the form. The slab is made upside down. If the slab is to have a pour-flush bowl, the shape of the hole must conform to the shape of the bowl unit. Check all measurements from drawings provided by the project designer.



2. Treat the forms with oil or grease to make it easier to remove the slab after the concrete has set as shown in Figure 11.

3. Mix concrete with the correct proportions of cement, sand, gravel and water. A common mix by volume is one part cement, two parts sand, three parts gravel, and enough water to make a fairly stiff mix. The cement should be Portland cement. Remove any hard lumps of cement before mixing. The sand should be clean and sized fine to 6mm. The gravel should be clean and sized 6-25mm. The water should be clean and clear drinking water, if possible.



4. Pour concrete in the form to a depth of about 50mm and smooth surface with trowel. See Figure 11.

5. Set reinforcing material--bars or wire mesh--in place. Be sure the reinforcing material is positioned according to drawings supplied by the project designer and that the material does not touch the sides of the forms or the wooden block used to produce the squatting hole.

6. Pour in the remaining depth of concrete, about 25mm, and smooth surface with trowel. See Figure 11.

7. Cover concrete with wet straw or burlap bags. Keep shaded for one or two days until concrete takes its initial set.

8. Remove wood block used to produce squatting hole. See Figure 11. Keep concrete covered and wet for four to six days until it has firmly set. During this period, work can begin on the pit and the pit lining and base (see "Constructing Pits for Privies," SAN, 1.C.2).

9. After the concrete has set firmly, remove the slab from the wood form. See Figure 11. Set it in place on the base around the pit.

10. Build a lid for the squatting hole and set it in place.

For a wood or bamboo squatting slab:

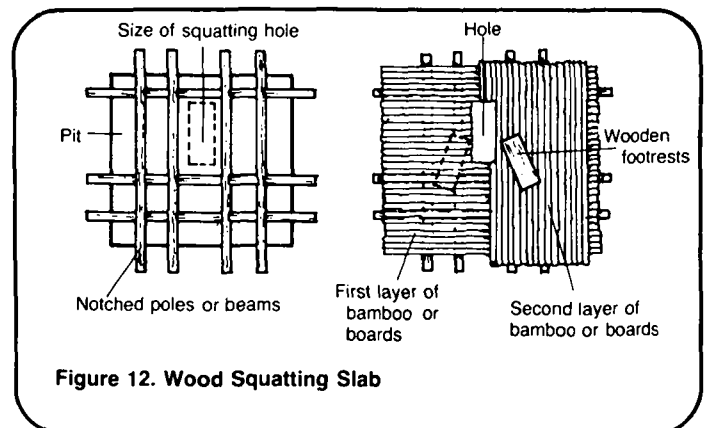
1. Build a gridwork of notched poles or stout bamboo as shown in Figure 12. The space for the squatting hole is 50mm longer and 50mm wider than the finished hole. Nail or tie the poles together.

2. Place poles, bamboo, or boards across gridwork as shown in Figure 12. Poles or boards overlap space for squatting hole so that actual hole is 400mm long and 150mm wide. Fasten together ends of poles, bamboo, or boards with binding or nails.

3. Place second layer of poles, bamboo, or boards across the first as shown in Figure 12. Secure each pole or board to the first layer with binding or nails.

4. Cut wood blocks or boards for footrests and nail them in place.

5. Set the completed slab in place over the pit.





6. Build a wooden lid to cover the squatting hole and set it in place.

For a concrete sitting slab with a brick and mortar pedestal:

1. Build wooden forms similar to Figure 13. For a ventilated privy, see Figure 13. Note that the hole for defecation is produced by a square wood frame. Do not pour concrete inside this frame.

2. Follow steps 2 through 9 for a reinforced concrete squatting slab. See Figure 14.

3. Mix concrete mortar with one part cement, three parts sand, and enough water to make a workable mix.

4. Lay bricks or selected stones around the hole in the slab as shown in Figure 14. Mortar the bricks to the slab and mortar them together.

5. Overlap the second row of bricks as shown in Figure 14. Continue laying bricks until the pedestal reaches 275-350mm.

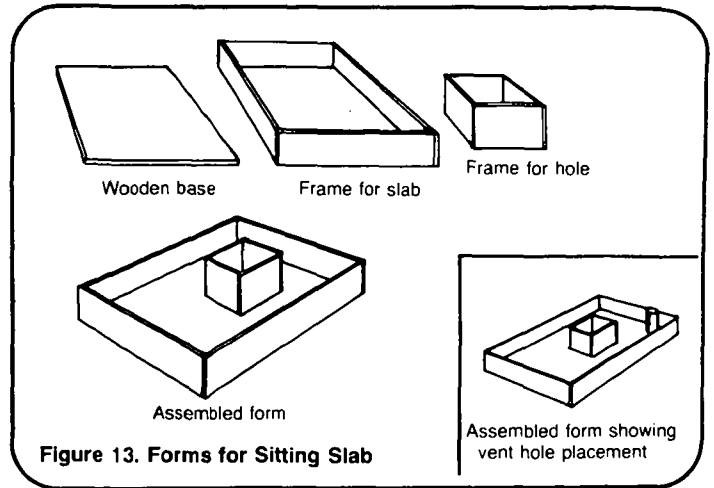


Figure 13. Forms for Sitting Slab

6. Wet the inside of the brick pedestal and plaster the inside with a 12mm thick layer of cement mortar. Smooth the mortar coating with a trowel.

7. Build a wood seat and lid similar to Figure 14 and set in place. Mortar seat to pedestal.

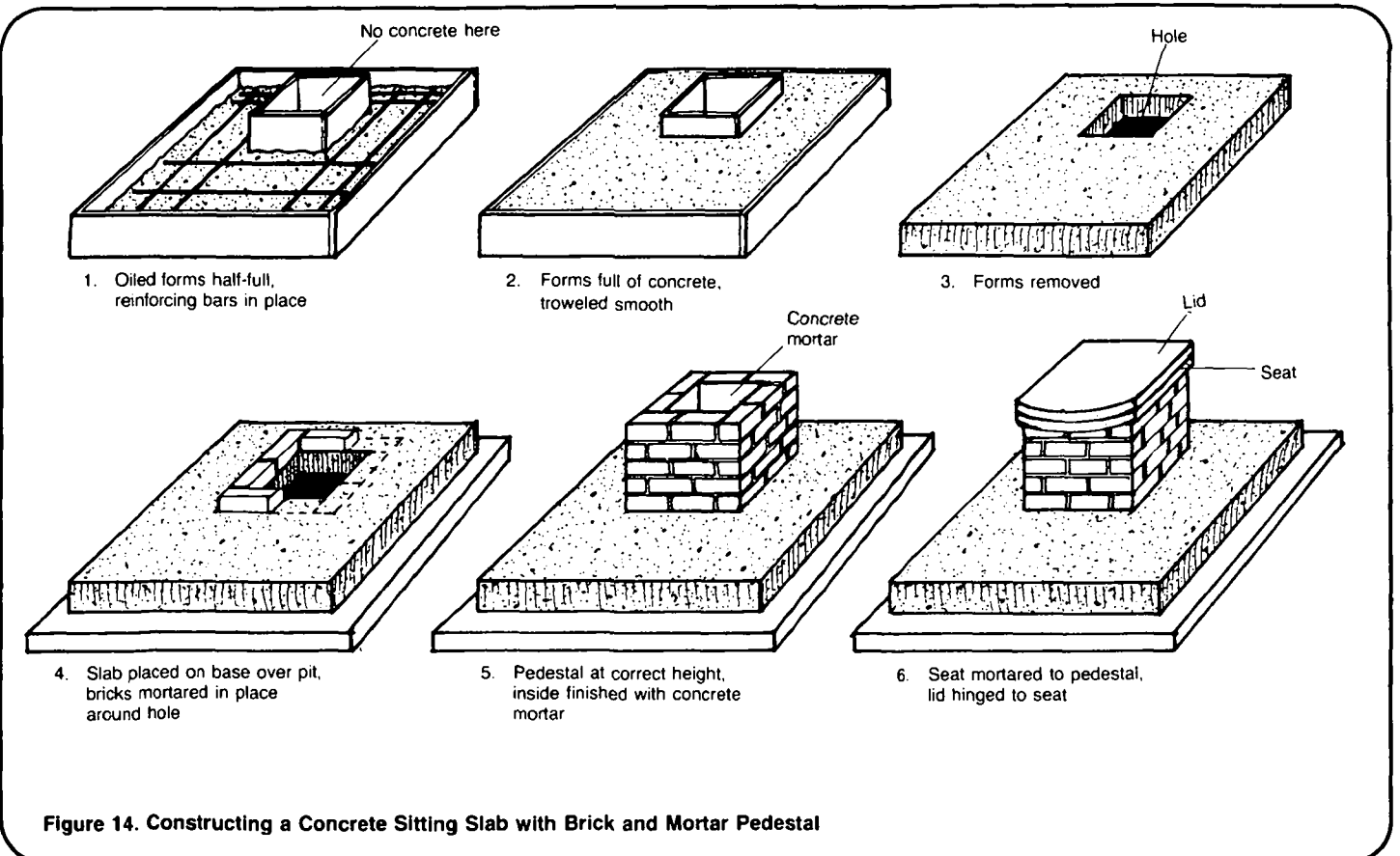


Figure 14. Constructing a Concrete Sitting Slab with Brick and Mortar Pedestal

For a wood sitting slab with a wood pedestal:

1. Cut two stout poles or beams the length of the pit plus 150-200mm. The beams should be 100mm by 100mm in size. Lay the beams on the base on each side of the pit as shown in Figure 15.

2. Nail 25mm thick boards to the beams as shown in Figure 15. The open space toward the rear of the slab should be about 450mm wide.

3. Build a bench 350-400mm high from 25mm thick boards. See Figure 15. The bench may have one or two holes for defecation. If two holes, make one 200-250mm diameter for adults and one about 150mm diameter for children. The edges of the holes should be sanded and free from splinters.

4. Build a hinged lid for each hole and attach in place.

5. Nail a board to each end of the privy floor to seal the pit. See Figure 15.

For a vent pipe:

1. Cut a rectangular sheet of tin to the dimensions provided by the project designer. See Figure 16.

2. Bend the tin to form the vent pipe. Overlap the edges about 25mm and fasten with metal screws. See Figure 16.

3. Cover one end of the pipe with fly-proof screen. See Figure 16.

4. A cone-shaped vent cover which is optional, but recommended in rainy regions, may be made from a round piece of tin about 250mm in diameter. Cut out a wedge with a base of about 150mm, bend tin to form a cone, and fasten with metal screws. See Figure 16. Attach the cone to the end of the vent pipe with metal struts to leave free air space.

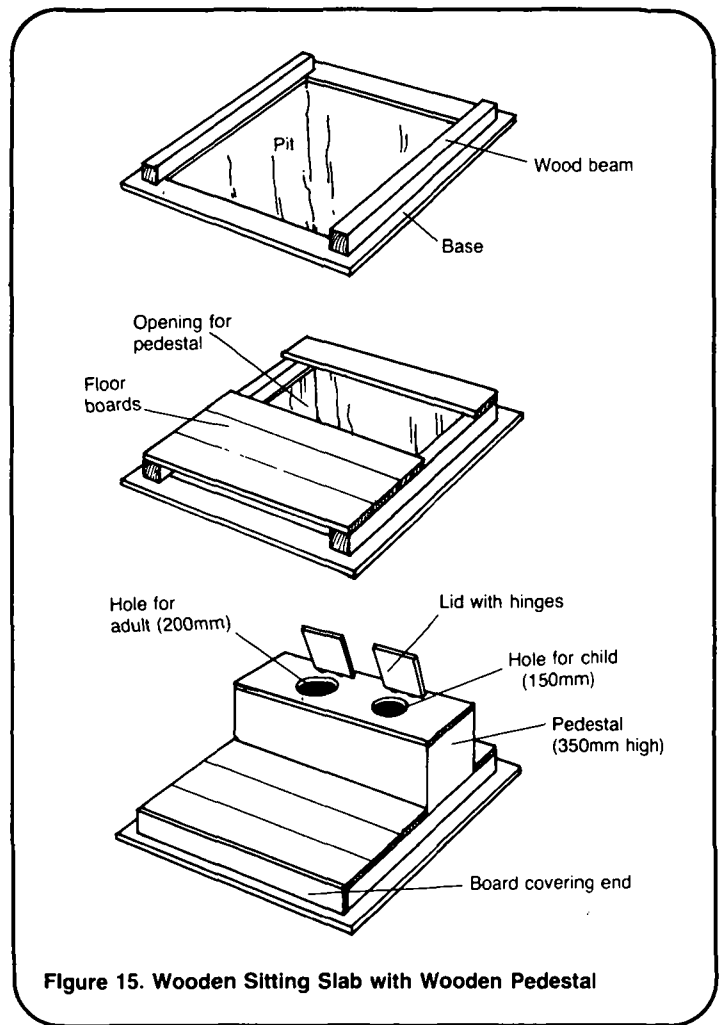


Figure 15. Wooden Sitting Slab with Wooden Pedestal

5. The vent pipe should not be installed until after the privy shelter is in place (see "Constructing Privy Shelters," SAN.1.C.3). Place the open end of the vent pipe in the hole in the slab and make the edges airtight with mortar or tar. Secure the vent pipe to the privy structure. The screened end of the pipe should be 0.3-0.6m above the roof of the privy.

For a pour-flush bowl:

1. Pour-flush bowls are often pre-fabricated units made from galvanized metal, concrete, molded rubber, or ceramic material. They are built to fairly exact specifications and may be difficult to produce in the field. A skilled craftsman could possibly build a concrete bowl using Figure 6a or, a galvanized metal pour-flush bowl using the design information in Figure 6b.

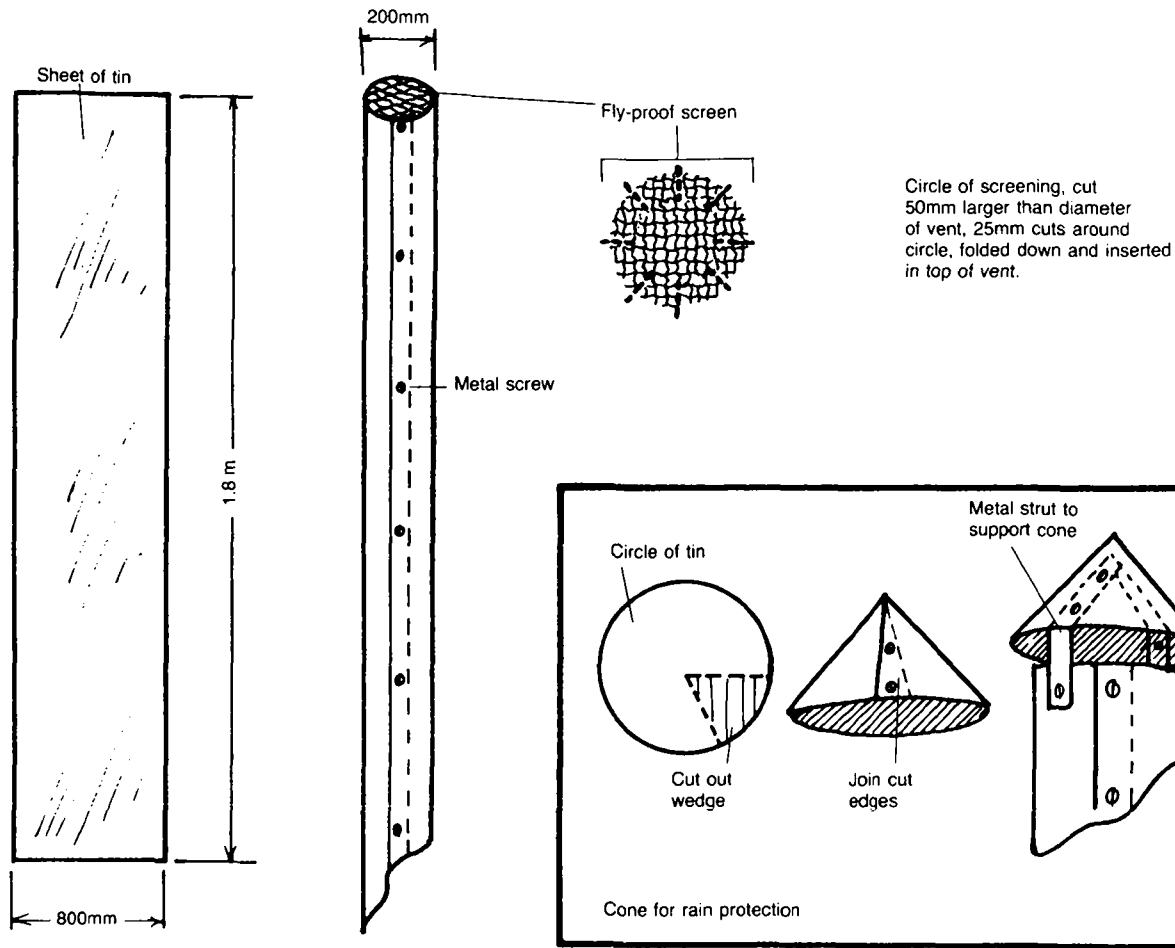


Figure 16. Constructing a Vent Pipe

LIBRARY  
 INTERNATIONAL REFERENCE CENTER  
 FOR COMMUNITY WATER SUPPLY AND  
 SANITATION (COWSS)

This technical note does not describe how to build a pour-flush unit, but if you try it keep the following two points in mind: the edges of a galvanized metal bowl should be rounded or dulled by a file; and a concrete bowl is generally cast in two halves in wooden molds, the halves mortared together, and the entire unit cured under water for a week.

2. Secure the pour-flush bowl to the slab with cement mortar and allow two or three days to set before use.

For a chute for an off-set pit:

1. Cut a rectangular sheet of tin or galvanized metal to the dimensions provided by the project designer. See Figure 17.

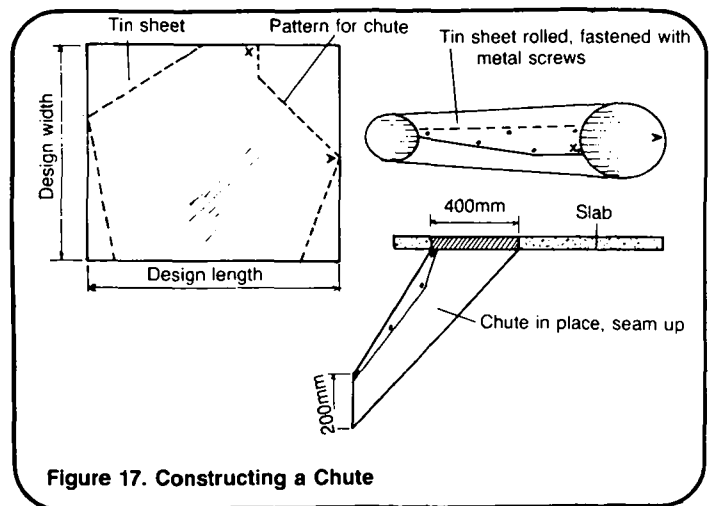


Figure 17. Constructing a Chute

2. Bend the sheet of tin to form the chute. Overlap the edges so that the overlapping seam is along the top edge and fasten with metal screws. Cut the sheet of tin in a shape like that shown in Figure 17 prior to bending.

3. Mortar the upper end of the chute in place below the squatting slab or seat, circling the squatting hole or the hole in the seat. See Figure 17.

For a wood platform for an off-set pit:

1. Build a framework to the dimensions of the slab, or slightly smaller, using poles or beams at least 50mm in diameter. See Figure 18a.

2. Add one or more rows of poles or beams to the framework, nailing or binding each row to the one below, until the correct height is reached. When the slab is in place, its top should be about 200mm above ground level. For example, if the slab is 75mm thick, the framework should be 125mm high:  $75\text{mm} + 125\text{mm} = 200\text{mm}$ .

3. When the platform reaches the correct height, nail or tie corner pieces inside each corner to further secure it. See Figure 18a.

4. When the platform is completed, place the slab on top. See Figure 18a.

For a brick and mortar platform for an off-set pit:

1. Lay a row of bricks, mortared together, to the dimensions of the slab at the desired slab location. See Figure 18b.

2. Continue mortaring rows of bricks in place until the correct height is reached as described in step 2 for wood platform. See Figure 18b.

3. After the mortar has set for two or three days, mortar the slab on top of the platform. See Figure 18b.

For a concrete platform for an off-set pit:

1. Build wooden forms for the concrete platform to the correct height as described in step 2 for wood platform and to the dimensions of the slab. Build the forms in place and so that the finished platform will have walls at least 75mm thick. See Figure 18c.

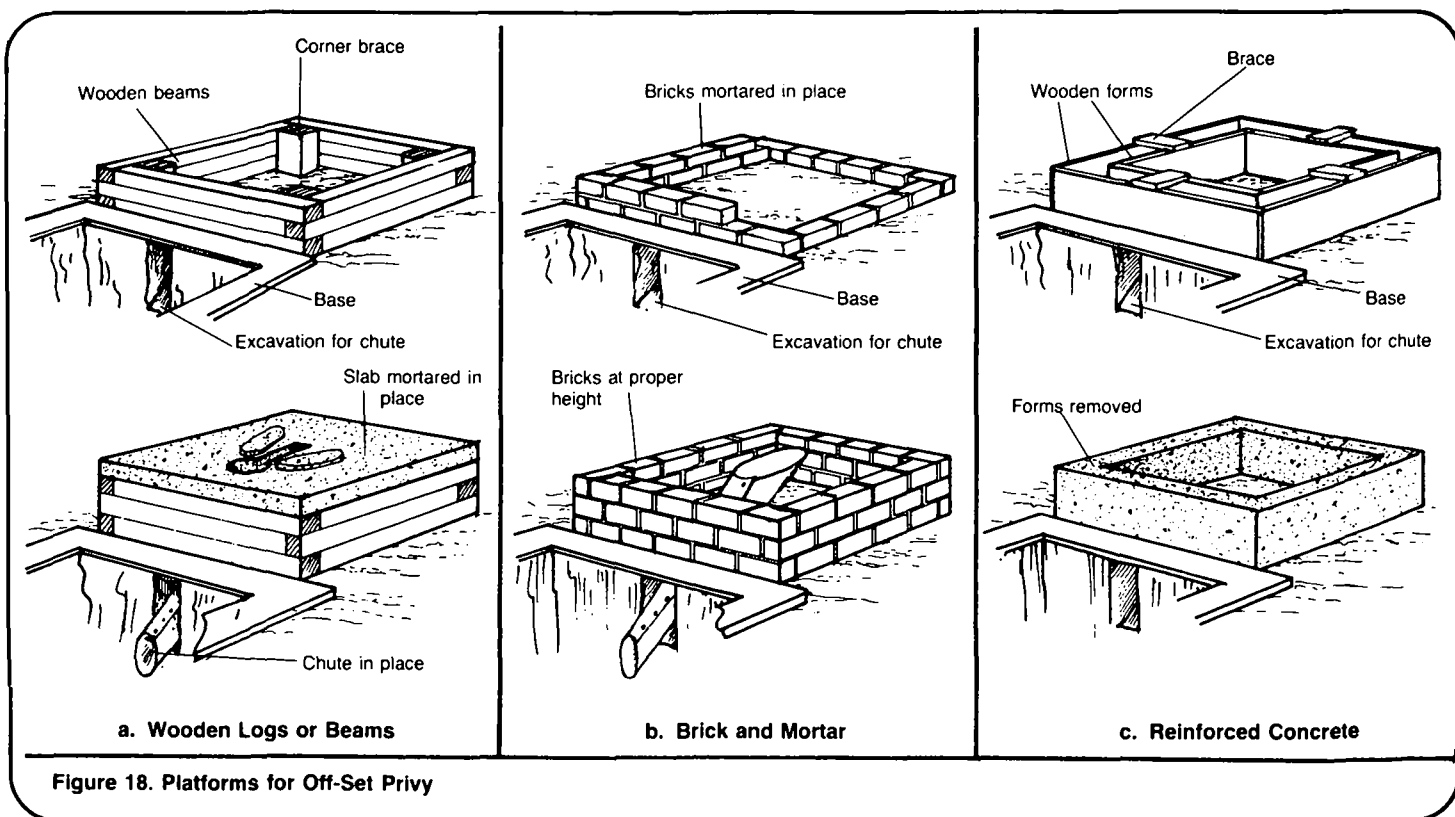


Figure 18. Platforms for Off-Set Privy

2. Mix concrete using the correct proportions of cement, sand, gravel and water as described in step 3 for a reinforced concrete squatting slab.

3. Pour concrete in the forms to about half their depth.

4. Lay reinforcing material in place.

5. Pour in the remaining depth of concrete and smooth the surface with a trowel.

6. Cover concrete with wet straw or burlap bags and allow it to set for three to seven days. Then, remove wood forms. See Figure 18c.

7. Mortar the slab on top of the platform.

For a reinforced concrete cover for an off-set pit:

1. Build wooden forms for the cover. See Figure 19. The cover is made in sections with each section about 75mm thick. The length of each section equals the width of the pit plus 150-200mm so that the sections overlap the pit on each side by 75-100mm. All sections but one are 300mm wide. One section is 300mm wide plus whatever measurement is necessary to add up to the total length of the pit plus 150mm. The width of this last section should be provided by the project designer or calculated in the field. For example, if the pit is 1500mm long, then the total widths of the sections should equal 1500mm plus 150mm, or 1650mm. The widths of the sections would be:

$$300\text{mm} + 300\text{mm} + 300\text{mm} + 300\text{mm} + 450\text{mm} = 1650\text{mm}$$

2. Mix concrete using the correct proportions of cement, sand, gravel and water as described in step 3 for a reinforced concrete squatting slab.

3. Pour concrete in the forms to about half their depth.

4. Lay reinforcing material in place.

5. Pour in the remaining depth of concrete and smooth the surface with a trowel.

6. Set handholds into the concrete near both ends of each section. See Figure 19.

7. Cover the concrete with wet straw or burlap bags and keep moist for five to seven days to allow concrete to set.

8. Remove wooden forms and place sections over the pit. Do not mortar. Waterproof between each section, and between the sections and the base around the pit, with tar or other material. See Figure 19.

9. Mound with soil. See Figure 19.

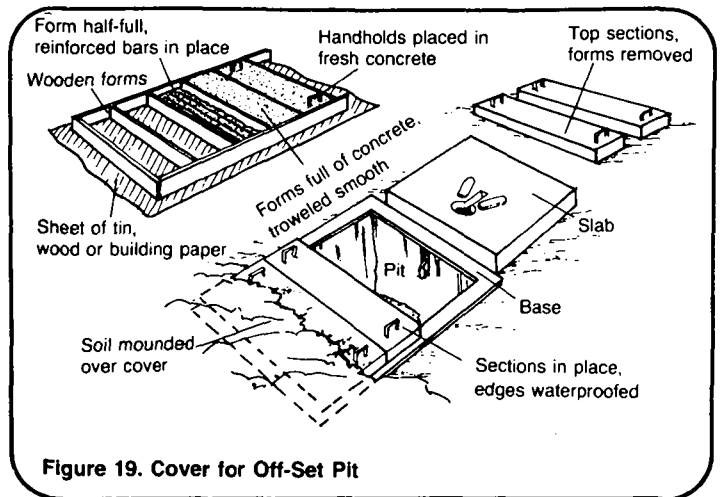


Figure 19. Cover for Off-Set Pit

## Notes

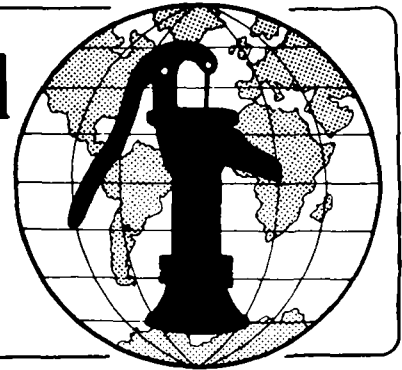
## Notes

## Notes

**Technical Notes** are part of a set of "Water for the World" materials produced under contract to the U.S. Agency for International Development by National Demonstration Water Project, Institute for Rural Water, and National Environmental Health Association. Artwork was done by Redwing Art Service. Technical Notes are intended to provide assistance to a broad range of people with field responsibility for village water supply and sanitation projects in the developing nations. For more detail on the purpose, organization and suggestions for use of Technical Notes, see the introductory Note in the series, titled "Using 'Water for the World' Technical Notes." Other parts of the "Water for the World" series include a comprehensive Program Manual and several Policy Perspectives. Further information on these materials may be obtained from the Development Information Center, Agency for International Development, Washington, D.C., 20523, U.S.A.



# Water for the World



## Constructing Pits for Privies Technical Note No. SAN. 1.C.2

The pit beneath a privy receives and holds excreta. The pit prevents contamination of groundwater and the spread of disease by keeping the excreta away from humans, animals and insects. At the top, the pit has a base for the slab. The pit often has a lining, also. If the pit walls will not stand on their own, a lining prevents them from caving in. Lining is installed after the pit is dug. Shoring, similar to lining, must be put in place during excavation of deeper pits and pits in crumbly soils to protect workers from cave-ins. The base supports the slab or cover (see "Constructing Slabs for Privies," SAN.1.C.1) and privy shelter (see, "Constructing Privy Shelters," SAN.1.C.3). Constructing a pit involves assembling laborers, materials, and tools to do the job, excavating the pit at the correct location, lining the pit walls, if necessary, and building a base for the slab.

A properly constructed pit will last 5 to 10 years. This technical note describes each step in constructing a pit. Read the entire technical note before beginning construction.

### Useful Definitions

**CONTAMINATE** - To make unclean by introducing an infectious (disease-causing) impurity such as bacteria from excreta.

**EXCRETA** - Human body waste.

**GROUNDWATER** - Water stored below the ground's surface.

### Materials Needed

The project designer must provide four items before construction can begin:

1. Location map, similar to Figure 1, showing the correct site where the pit is to be excavated. The map will show distances from the pit to nearby dwellings, sources of drinking water, property lines, and any other structures or prominent geographical features.

2. Technical drawings, similar to Figures 2 and 3, showing the correct dimensions of the pit.

3. Sketches, similar to Figures 4 and 5, showing the materials and general configuration of the pit lining and base.

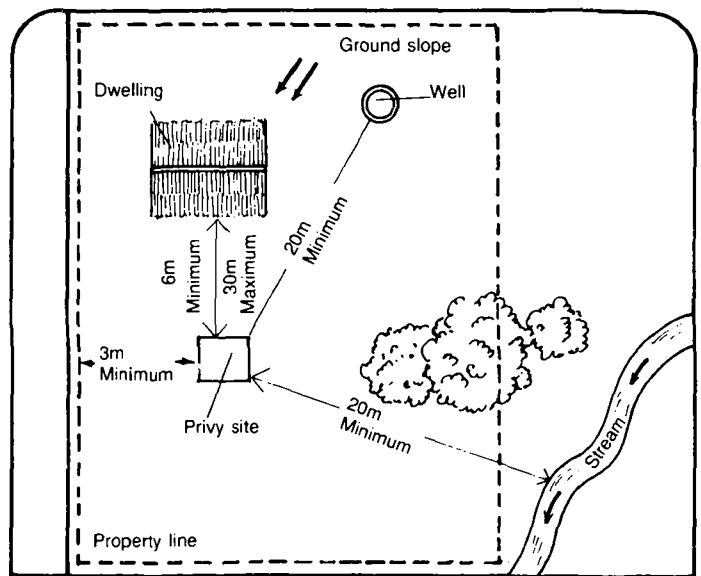


Figure 1. Location Map

4. Materials list, similar to Table 1, describing all labor, supplies, and tools needed to construct the pit, lining, and base.

You will also need a slab or cover (see "Constructing Slabs for Privies," SAN.1.C.1) to cover the pit immediately after the base and lining are in place.

(NOTE: Figures 1,2 and 3 and Table 1 are samples only and cannot be used to build the pit. The documents you need will be provided by the project designer.)

After the project designer has given you these documents and you have read this technical note carefully, begin assembling the necessary workmen, supplies, and tools.

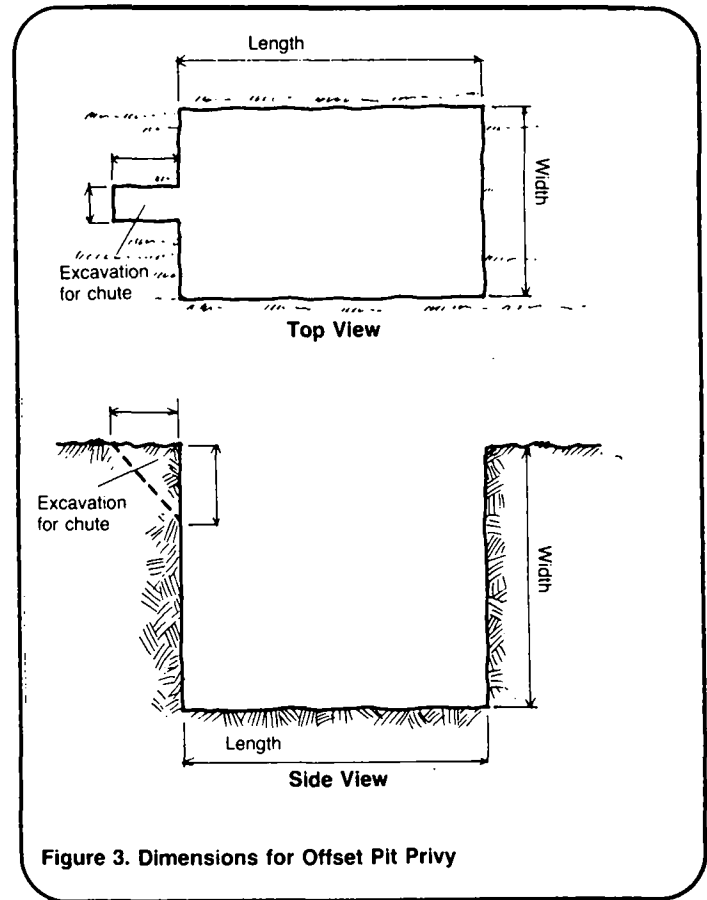


Figure 3. Dimensions for Offset Pit Privy

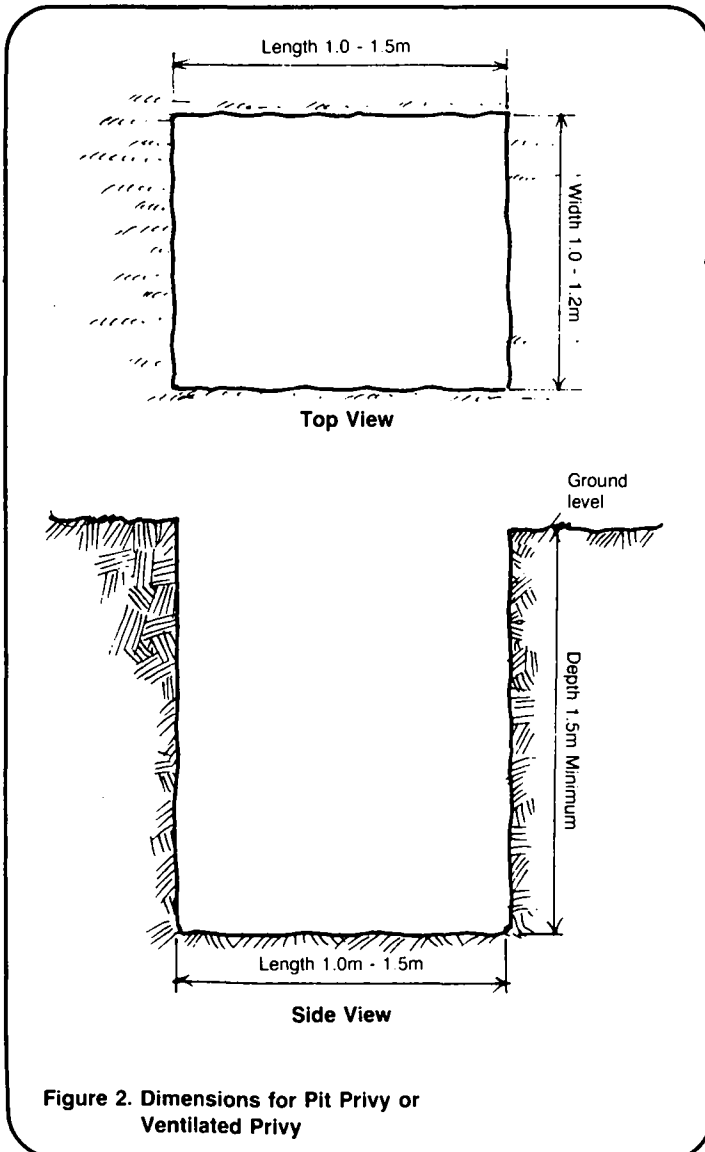


Figure 2. Dimensions for Pit Privy or Ventilated Privy

**Caution!**

1. If the pit is deeper than about 1.5m, the walls must be shored during excavation to prevent a cave-in that could be fatal to a worker in the pit.
2. Do not hand-dig a pit deeper than about 3.5m.
3. All pits must be dug at the exact site and to the dimensions specified by the project designer to protect groundwater and other sources of drinking water.
4. A pit must be covered with a slab or cover (see "Constructing Slabs for Privies," SAN.1.C.1) during construction when it is not attended and immediately after it is excavated and the lining and base are in place. A pit left open and unattended is a serious hazard.

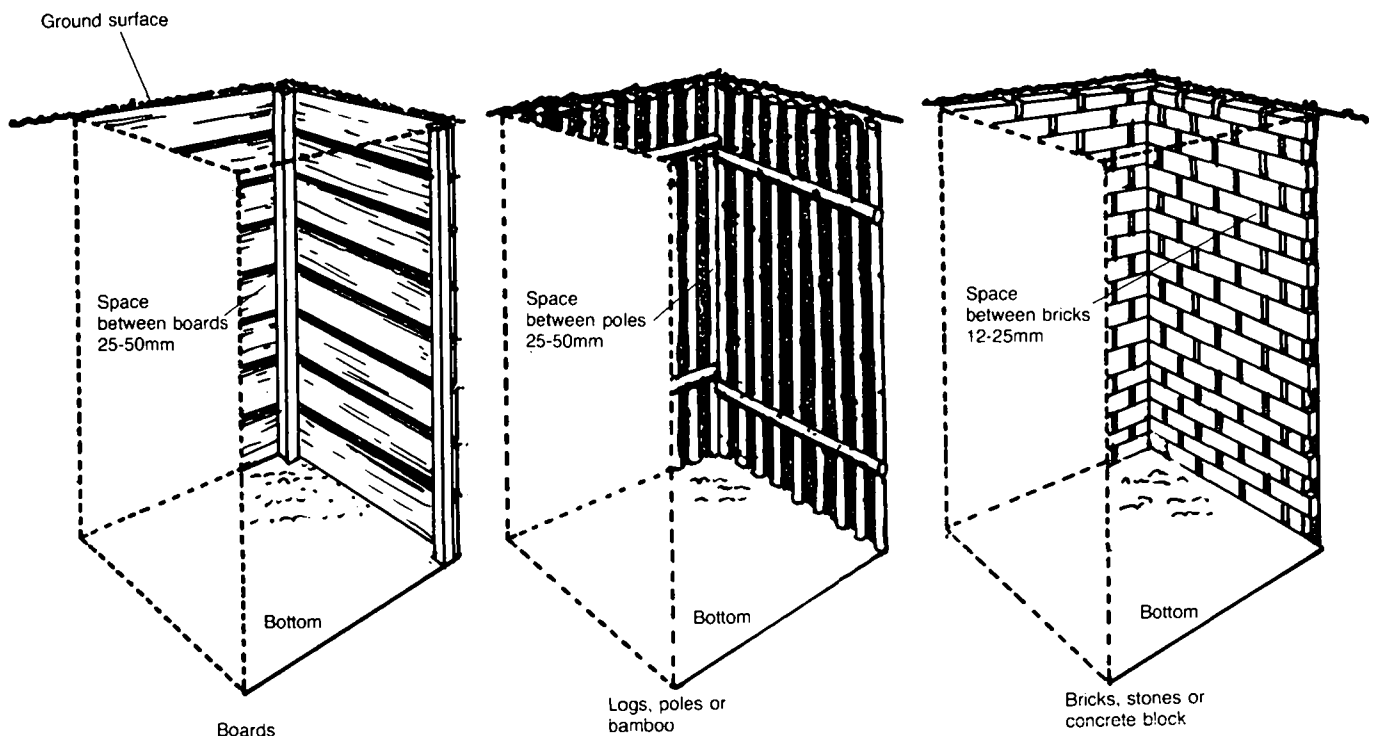


Figure 4. Pit Linings

## Construction Steps

Depending on local conditions, availability of materials, skills of workers, and so on, some construction steps will take only a few hours, while others may take a day or more. Table 2 shows a sample work plan for building a pit including time estimates for each step. Draw up a similar work plan with rough time estimates based on local conditions. You will then have an idea of when specific workmen, supplies and tools must be available during the construction process. The following are construction steps for building a pit.

1. Assemble all laborers, materials, tools, and drawings needed to begin construction. Study all diagrams carefully.

2. Determine the correct location of the pit, using the location map similar to Figure 1 and a measuring tape. Clear the area of any vegetation that might hinder construction. Lay out on the ground the correct dimensions of the pit, as shown in the technical drawing, and mark each corner of

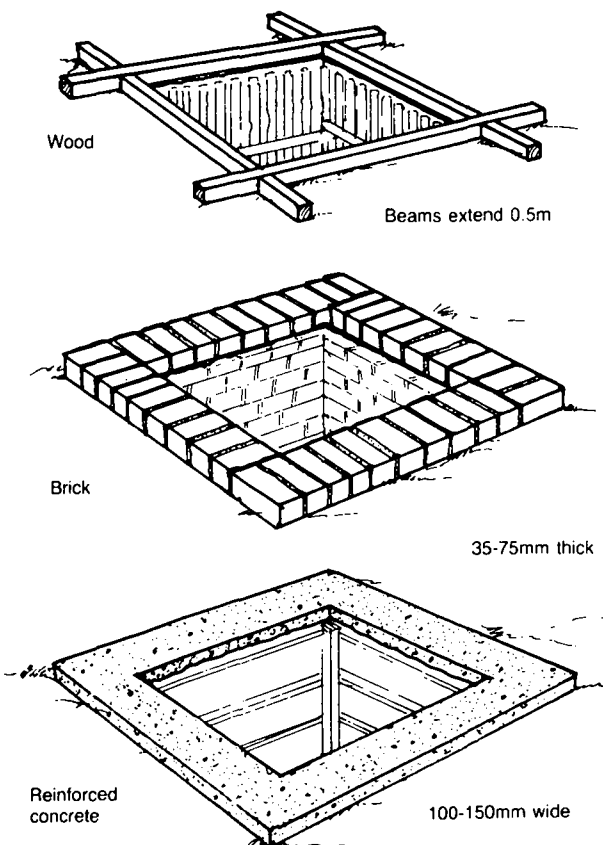


Figure 5. Bases

**Table 1. Sample Materials List**

Item	Description	Quantity	Estimated Cost
Labor	Foreman Laborers (one experienced with carpentry, stone masonry, or poured concrete, whichever applies)	1 2 (at least)	_____ _____
Supplies	For laying out the system; wooden stakes or sticks  For the lining: bamboo, poles, logs, boards, bricks, concrete blocks, select field stones  For the base: wood, bricks, concrete blocks  For poured concrete or mortar:  Cement Sand Gravel Water  Other	_____  _____  _____  _____ _____ _____ _____  _____	_____  _____  _____  _____ _____ _____ _____  _____
Tools and Equipment	Box or bucket Sturdy rope or ladder Measuring tape Shovels Wheelbarrow Hammer Saw Nails Trowel Plumb line (string and rock) Hatchet or machete Container (for mixing mortar) Concrete slab  Other	1 1 1 2 (at least) 1 1 1 -- 1 1 1 1  --	_____ _____ _____ _____ _____ _____ _____ _____ _____ _____ _____ _____ _____  _____

Total Estimated Cost = \_\_\_\_\_

**Table 2. Sample Work Plan for Constructing Pit, Lining, and Base**

Time Estimate	Day	Task	Personnel	Tools/Materials
2 hours	1	Mark pit location	Foreman and 1 laborer (NOTE: Foreman present during all construction steps)	Location map, and measuring tape, wooden stakes or sticks
6 hours	1	Build base	Skilled worker (familiar with masonry)	Bricks, container (for mixing mortar), cement, sand, gravel, water, shovel, trowel
2 days	2-3	Allow mortar to set		
2 days	4-5	Excavate pit	2 laborers (at least)	2 shovels, ladder, long rope, bucket or box, wheelbarrow, plumb line
4 hours	6	Line pit	1 laborer, 1 skilled worker (familiar with carpentry)	Boards, hammer, saw, nails
1 hour	6	Cover pit	2 laborers	Concrete slab
1 hour	6	Waterproof edges of slab; mound dirt around base and slab	1 laborer	Tar, shovel

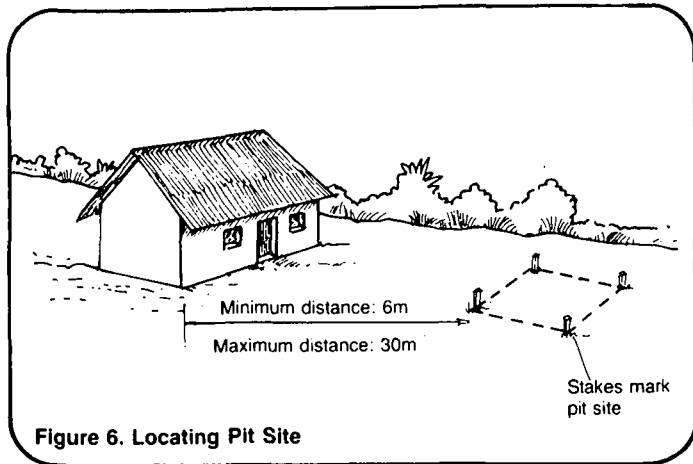


Figure 6. Locating Pit Site

the pit with a wooden stake or pointed stick as shown in Figure 6. Mark the excavation for the chute, if it is an offset pit.

3. Build the base around the pit site. This is done before digging the pit to prevent the top of the pit walls from crumbling and to ensure that the slab or cover can be put in place immediately after the pit is dug and lined. The corners of the base should be square.

For a wood base:

3a. Cut four logs, poles, or wood beams to the length determined by the project designer. Cut two notches halfway through each log, as shown in Figure 7, so the logs will fit together to form the base around the pit site. Bind the logs with heavy cord or twine or nail them together.

For a concrete block or brick base:

3b. Lay a straight row of bricks or blocks along each side of the pit site as shown in Figure 8. The blocks should either be mortared together or fit tightly. See "Constructing Septic Tanks," SAN.2.C.3, for details on mixing and applying mortar. Tamp the blocks in place or scrape away dirt to ensure that the rows of blocks are level. If the blocks or bricks are mortared together, cover them with damp straw, leaves, or grass and allow a few days for the mortar to set. Keep the cover material damp until the concrete has set.

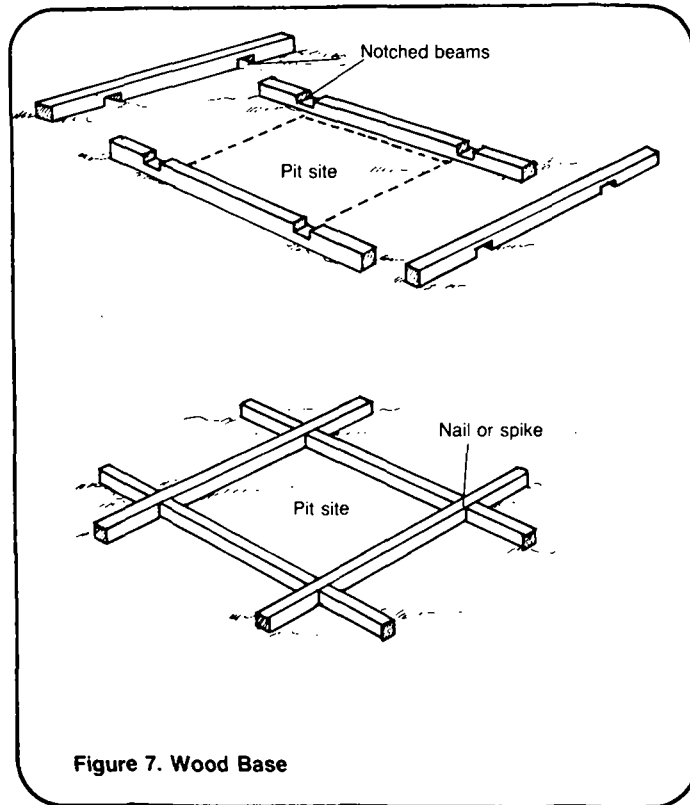


Figure 7. Wood Base

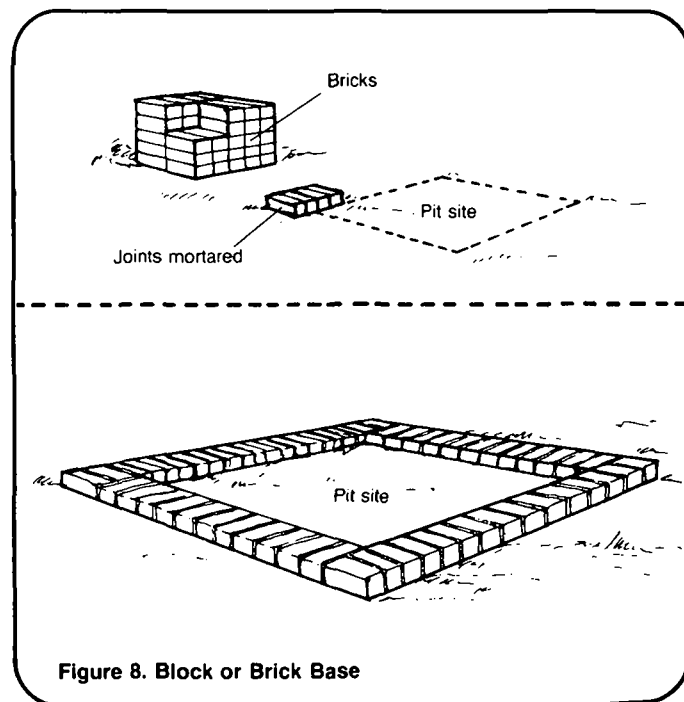


Figure 8. Block or Brick Base

For a poured concrete base:

3c. See "Constructing Septic Tanks," SAN.2.C.3, for details on concrete. Dig a shallow, level trench around the pit site. Make the trench

about 150mm wide and 50 to 75mm deep as shown in Figure 9. The width and depth of this trench determine the width and thickness of the base. The trench lines should be straight, the bottom tamped, and the sides and bottom clean and free of loose dirt. Mix the concrete and pour it evenly around the trench until the trench is about half full. Lay reinforcing material such as steel bars, wire mesh, or bamboo in place. Pour concrete until the trench is full. Smooth the surface with a trowel. Cover with wet straw, leaves, grass, burlap, or other material and allow three to seven days for the concrete to set. Keep the cover material damp until the concrete has set.

4. Begin digging the pit after the base has been constructed and is securely in place. Make the sides straight and smooth. Use a plumb line (string tied to rock or weight) to check the sides during excavation, as shown in Figure 10. Pile the dirt at least 1m away from the edge of the pit to prevent it from falling back in. For an offset pit, make the additional small excavation for the chute.

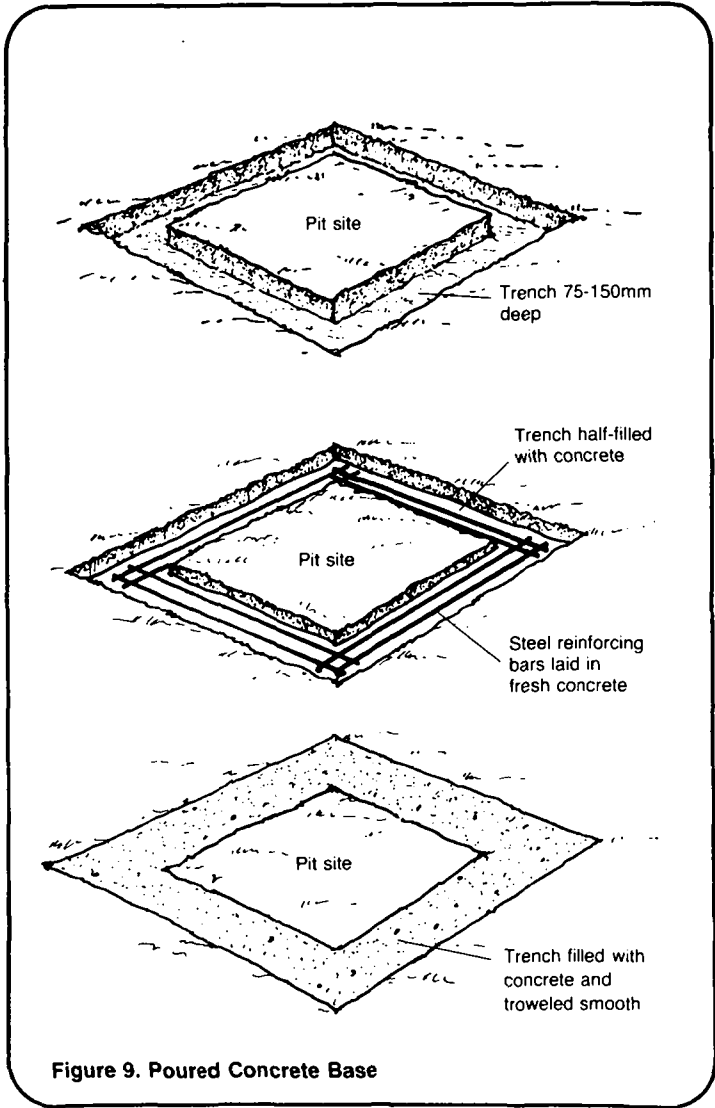


Figure 9. Poured Concrete Base

(NOTE: Depending on the dimensions of the pit, it is likely that there will be space for only one laborer to dig. Have laborers rotate every 20 to 40 minutes--one in the pit, one or two outside. When the pit reaches about shoulder level, it may be helpful to lower a bucket or box tied to a rope into the pit. The laborer in the pit can fill the container with dirt, and the laborer outside can haul the full container up and out. This method of excavation will be necessary for pits deeper than about 1.5m. Have a sturdy rope or ladder readily available for laborers to get in and out of the pit.)

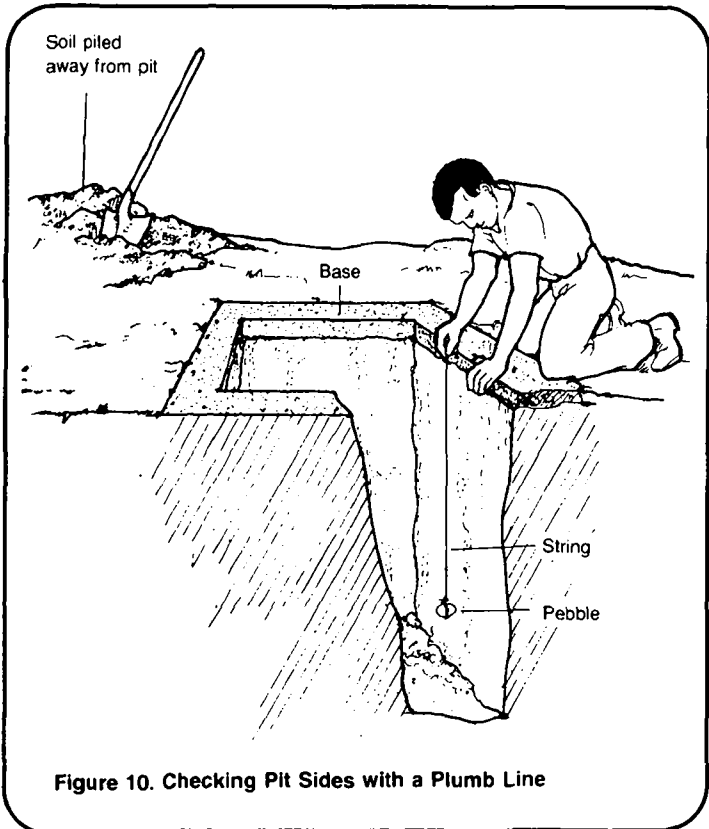
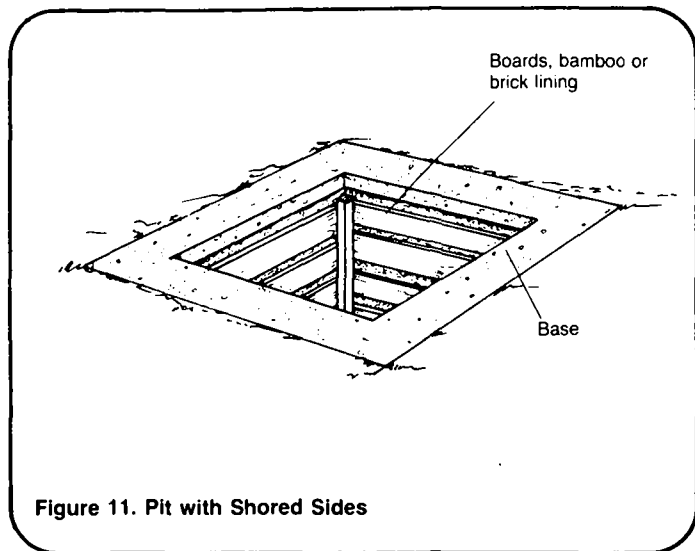
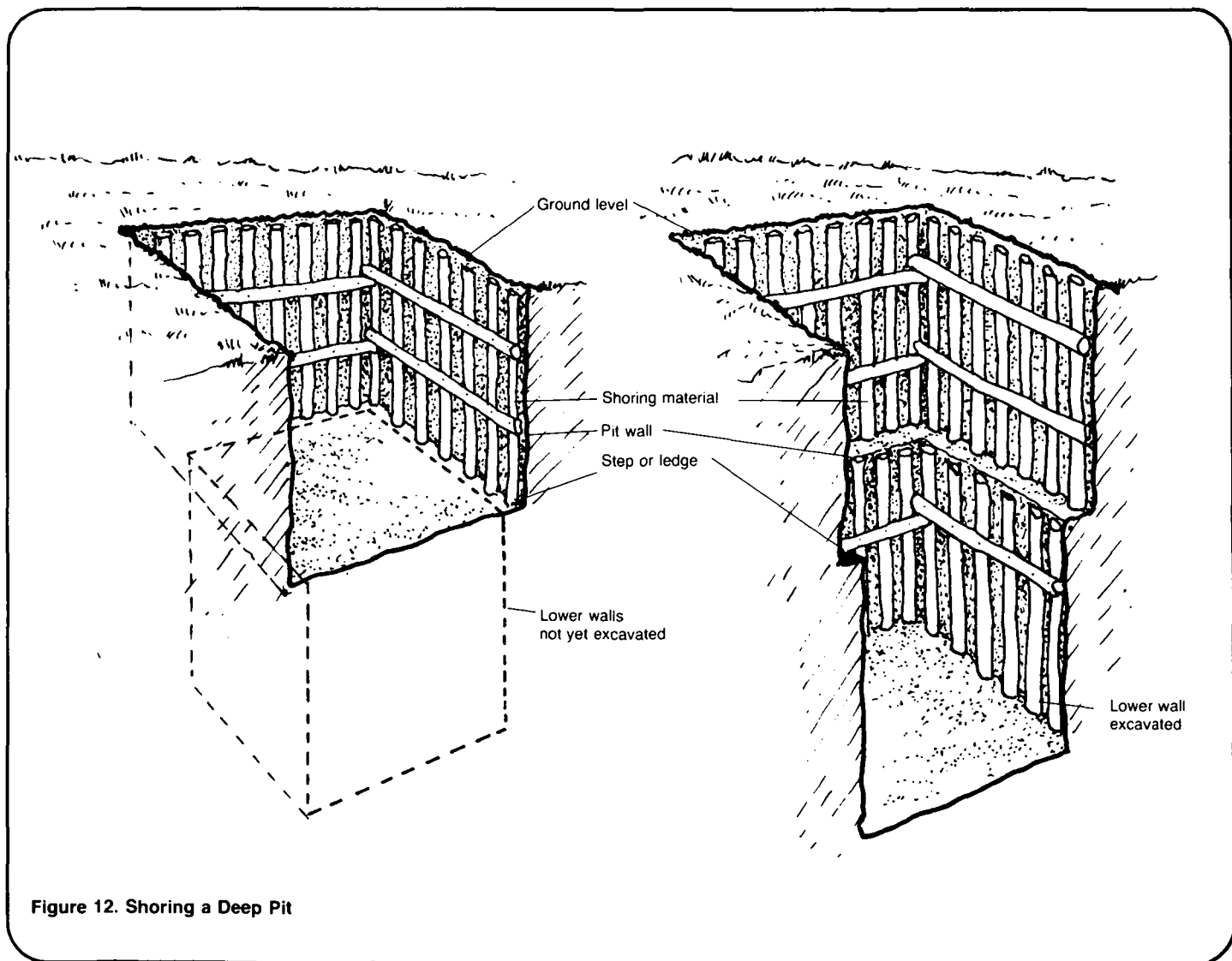


Figure 10. Checking Pit Sides with a Plumb Line



5. Shore up the sides of the pit to prevent possible cave-ins when excavating deeper than about 2m, as shown in Figure 11. Secure the sides with logs, poles, boards, bamboo, or other material when the depth reaches about 2m. Continue digging, leaving a 75 to 100mm step or ledge around the walls to support the shoring material as shown in Figure 12. Shore up the lower walls when the pit reaches the correct depth. Do not hand dig a pit deeper than about 3.5m.

6. Measure the depth as the pit is being dug. Make the pit floor fairly level when the correct depth has been reached.





7. Install the lining, if needed, after the pit is fully excavated. The lining should extend from the bottom of the pit to the base. If the pit has been shored, the shoring material can be left in place and serve as the lining.

For a log, pole, or bamboo lining:

7a. Cut logs or poles to a length equal to the depth of the pit. Place the logs or poles vertically along the sides of the pit. The poles should reach from the bottom of the pit to the base and should be placed 25 to 75mm apart. Cut four cross poles equal to the length of the pit, and four cross poles equal to the width. Nail or tie the cross poles in place about 0.5m from the top and bottom of the pit walls to secure the vertical poles, as shown in Figure 4.

For a wood or board lining:

7b. Place the boards either vertically or horizontally. To place them

vertically, use the same methods as for log, pole, or bamboo linings. To place them horizontally, cut boards to lengths equal to both the length and width of the pit. Cut four long boards or beams to a length equal to the depth of the pit. Put a long board or beam in each corner of the pit and place the shorter side boards horizontally along the pit walls and nail them to the corner beams. The side boards should be spaced about 25 to 75mm apart, as shown in Figure 4.

For a concrete block or brick lining:

7c. Stack the blocks or bricks up the sides of the pit as shown in Figure 4. Leave spaces between the bricks. Do not mortar. Stack the bricks up to the base. For additional strength, mortar the top two courses of bricks.

8. Remove any tools, equipment, or scrap material from the pit after the lining is in place.

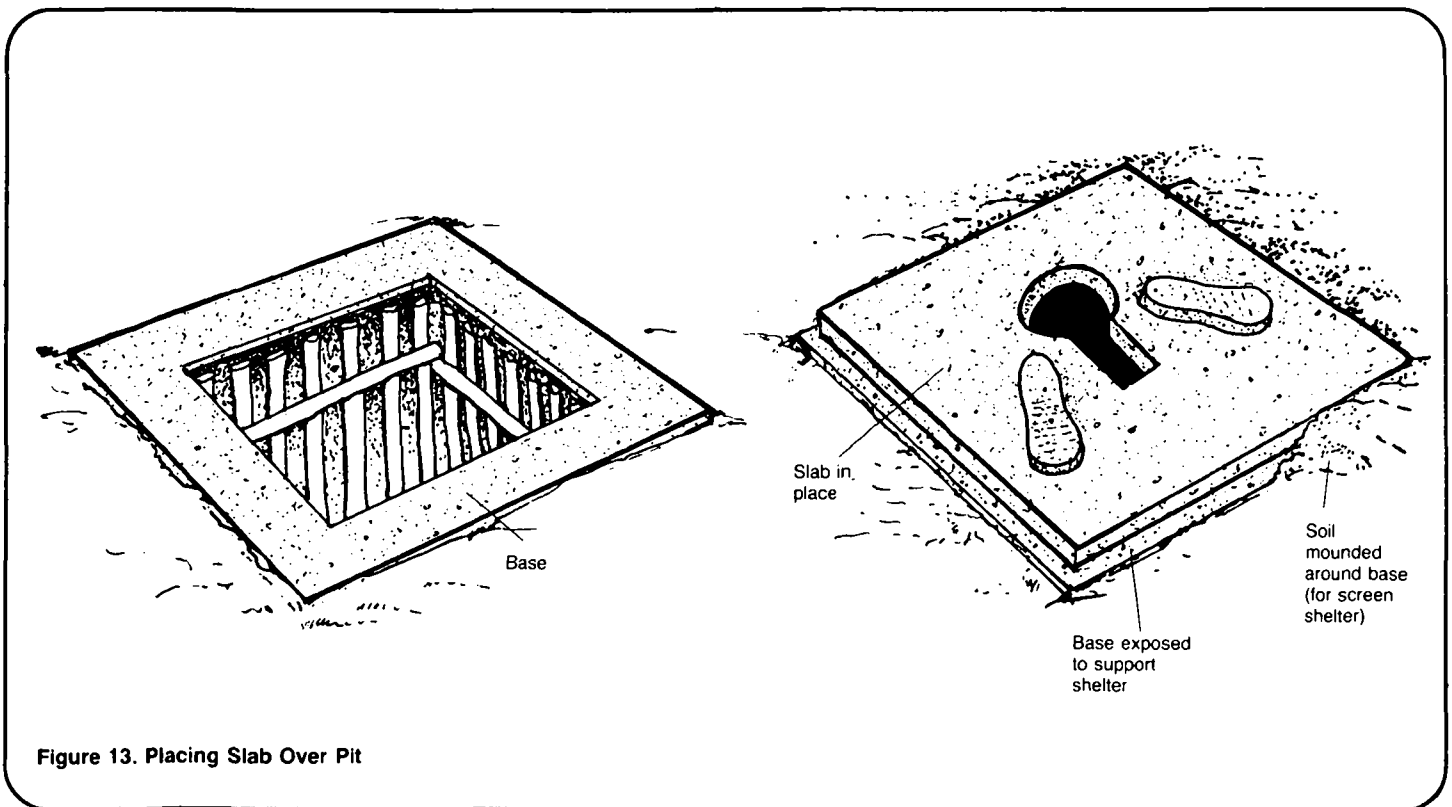


Figure 13. Placing Slab Over Pit

9. Set the slab or cover in place over the pit as shown in Figure 13. If the slab or cover is in sections, use tar, oakum or other material to waterproof where the sections fit together.

10. Waterproof around the edges of the slab or cover where it rests on the base. Do not mortar the slab or cover to the base because in 5 to 10 years, depending on the size of the pit, the slab or cover will be moved to a new pit.

11. Place dirt around the edges of the base and slab or cover, and tamp. This dirt will help seal the pit.

12. Set or build in place a privy shelter (see "Constructing Privy Shelters," SAN.1.C.3).

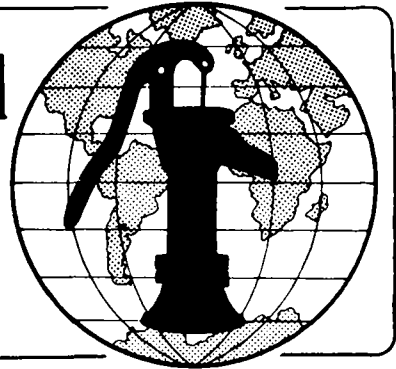
13. Place dirt around the edges of the shelter, and tamp.

## Notes

## Notes

**Technical Notes** are part of a set of "Water for the World" materials produced under contract to the U.S. Agency for International Development by National Demonstration Water Project, Institute for Rural Water, and National Environmental Health Association. Artwork was done by Redwing Art Service. Technical Notes are intended to provide assistance to a broad range of people with field responsibility for village water supply and sanitation projects in the developing nations. For more detail on the purpose, organization and suggestions for use of Technical Notes, see the introductory Note in the series, titled "Using 'Water for the World' Technical Notes." Other parts of the "Water for the World" series include a comprehensive Program Manual and several Policy Perspectives. Further information on these materials may be obtained from the Development Information Center, Agency for International Development, Washington, D.C., 20523, U.S.A.

# Water for the World



## Constructing Privy Shelters Technical Note No. SAN. 1.C.3

A privy shelter is a screen or structure that gives the person using the privy privacy. Depending on the design, a shelter can protect the user from the weather and keep out flies, rats, scavenging dogs, and other pests. Constructing a privy shelter involves assembling necessary labor, materials, and tools; building the shelter to the dimensions specified by the project designer; and building any special features.

A properly constructed shelter can last 5-10 years or more. This technical note describes each step in building a shelter. Read the entire technical note before beginning construction.

### Materials Needed

The project designer must provide three papers before construction can begin:

1. A plan view of the shelter similar to one or more of Figures 1-4, and 8a and 8b, showing the correct dimensions of the shelter.
2. A detailed view of any special features similar to one or more of Figures 5-7.
3. A detailed materials list similar to Table 1, showing all necessary labor, supplies and tools.

After the project designer has given you these documents and you have read this technical note carefully, begin assembling the necessary laborers, supplies and tools.

### Construction Steps

Depending on local conditions, availability of materials, and skills of workers, some construction steps will require only a few hours, while others may take a day or more. Table 2

shows a sample work plan for building a privy shelter including time estimates for each step. Draw up a similar work plan with rough time estimates based on local conditions. You will then have an idea of when specific workmen, supplies, and tools must be available during the construction process.

For a simple screen shelter:

1. Assemble all laborers, supplies, tools, and drawings needed to begin construction. Study all drawings carefully.
2. Cut corner posts or uprights to the correct lengths.
3. Set corner posts or uprights firmly in the ground in a vertical position around the privy slab to a depth of 0.3-0.6m as shown in Figure 9a. Thoroughly tamp the ground after the posts are in place.
4. Build or weave together the screening material and secure it to the corner posts with vine, wire, or equivalent. Begin at the end corner post and work your way around the screen. The screen should touch the ground and be as high as the tops of the corner posts as shown in Figure 9b.

For a bamboo shelter with roof or roof and door:

1. Assemble all laborers, supplies, tools, and diagrams needed to begin construction. Study all diagrams carefully.
2. Build a foundation around the privy slab from bamboo poles 50-100mm in diameter. Notch the ends of the poles, fit them together, and tie them with wire or vine, as shown in Figure 10a.

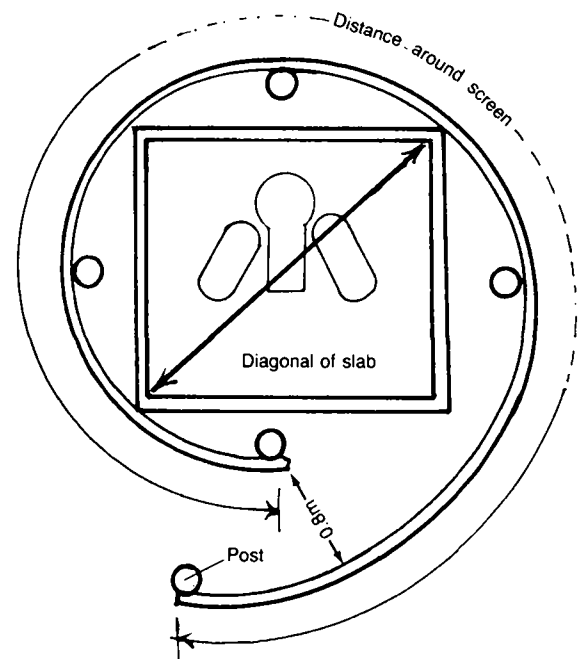
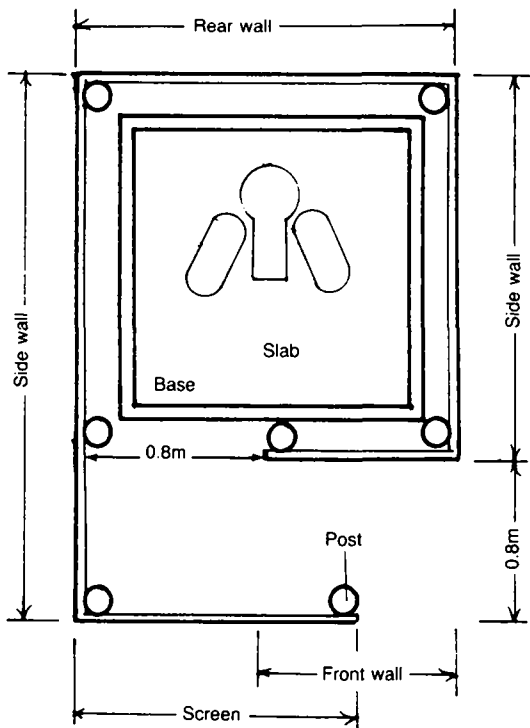
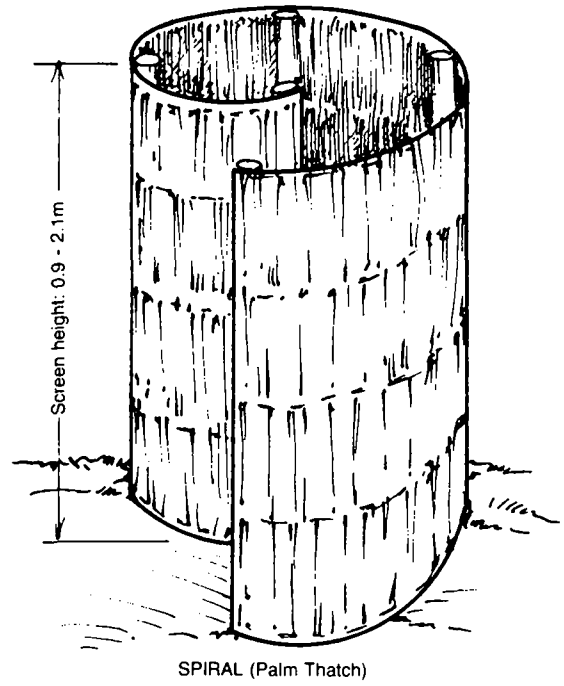
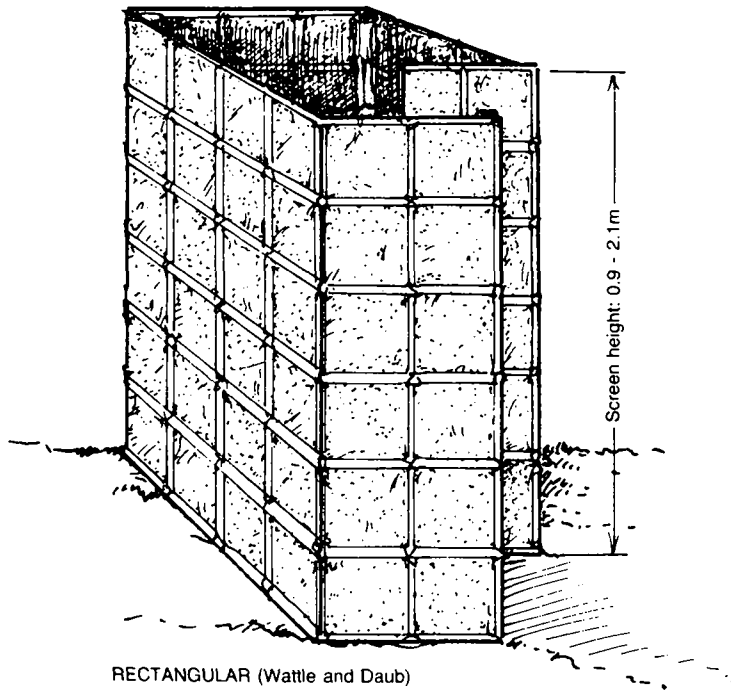
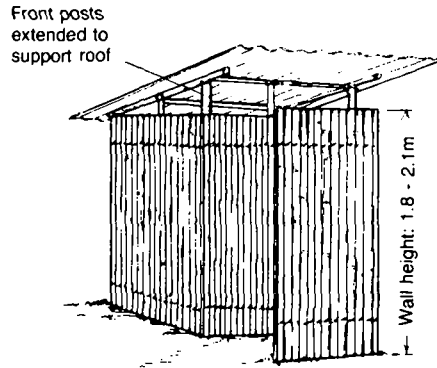
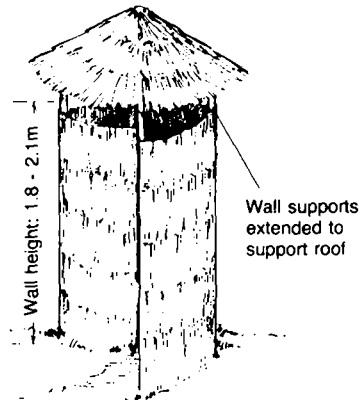
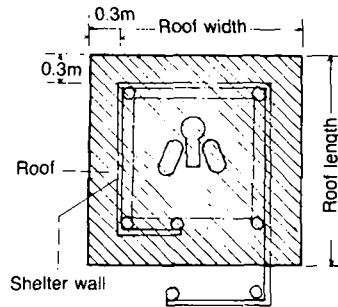


Figure 1. Simple Screen Shelters



BAMBOO SHELTER WITH CORRUGATED METAL ROOF



PALM THATCH SHELTER AND ROOF

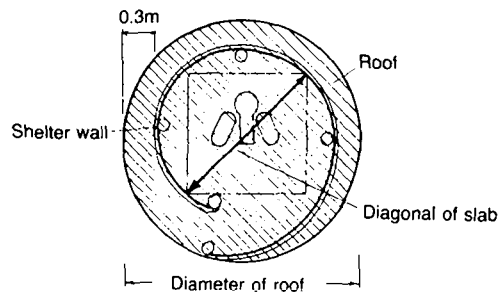


Figure 2. Privy Shelters with Roof

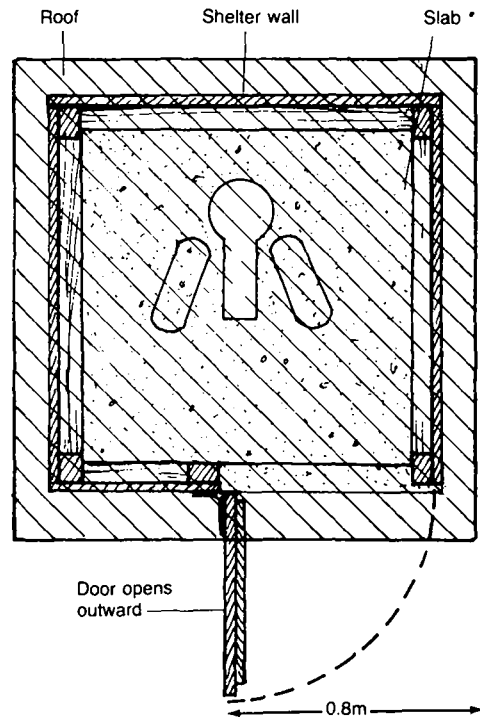
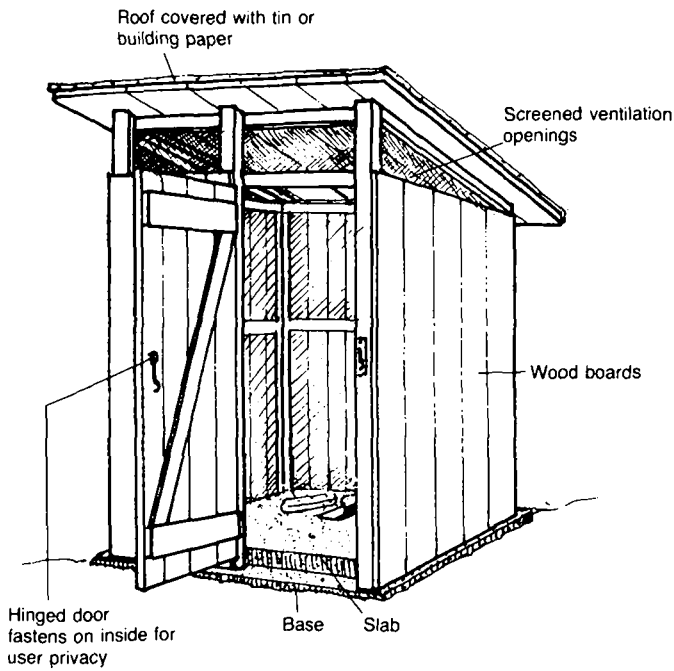


Figure 3. Fly-Proof with Screening and Door

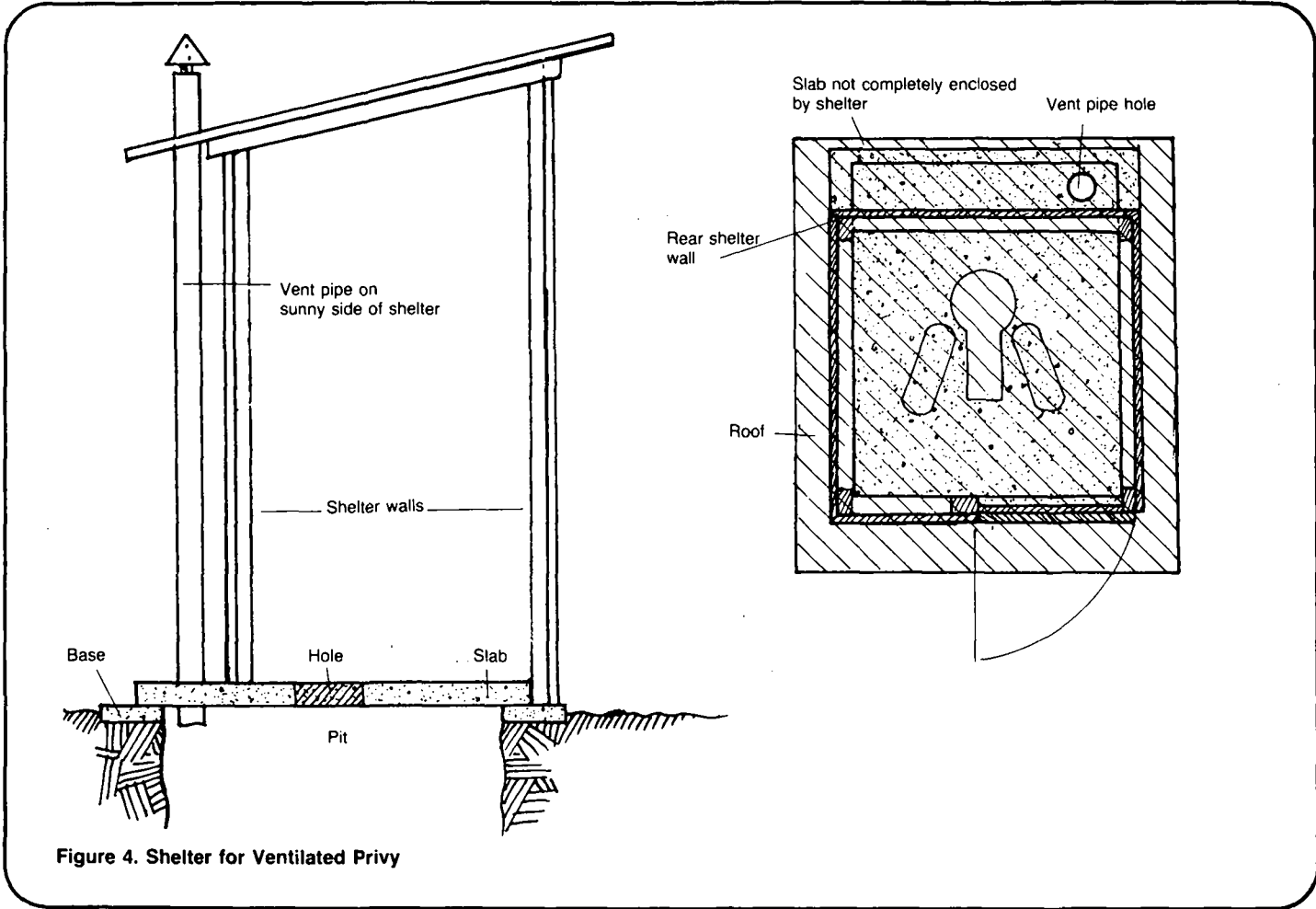


Figure 4. Shelter for Ventilated Privy

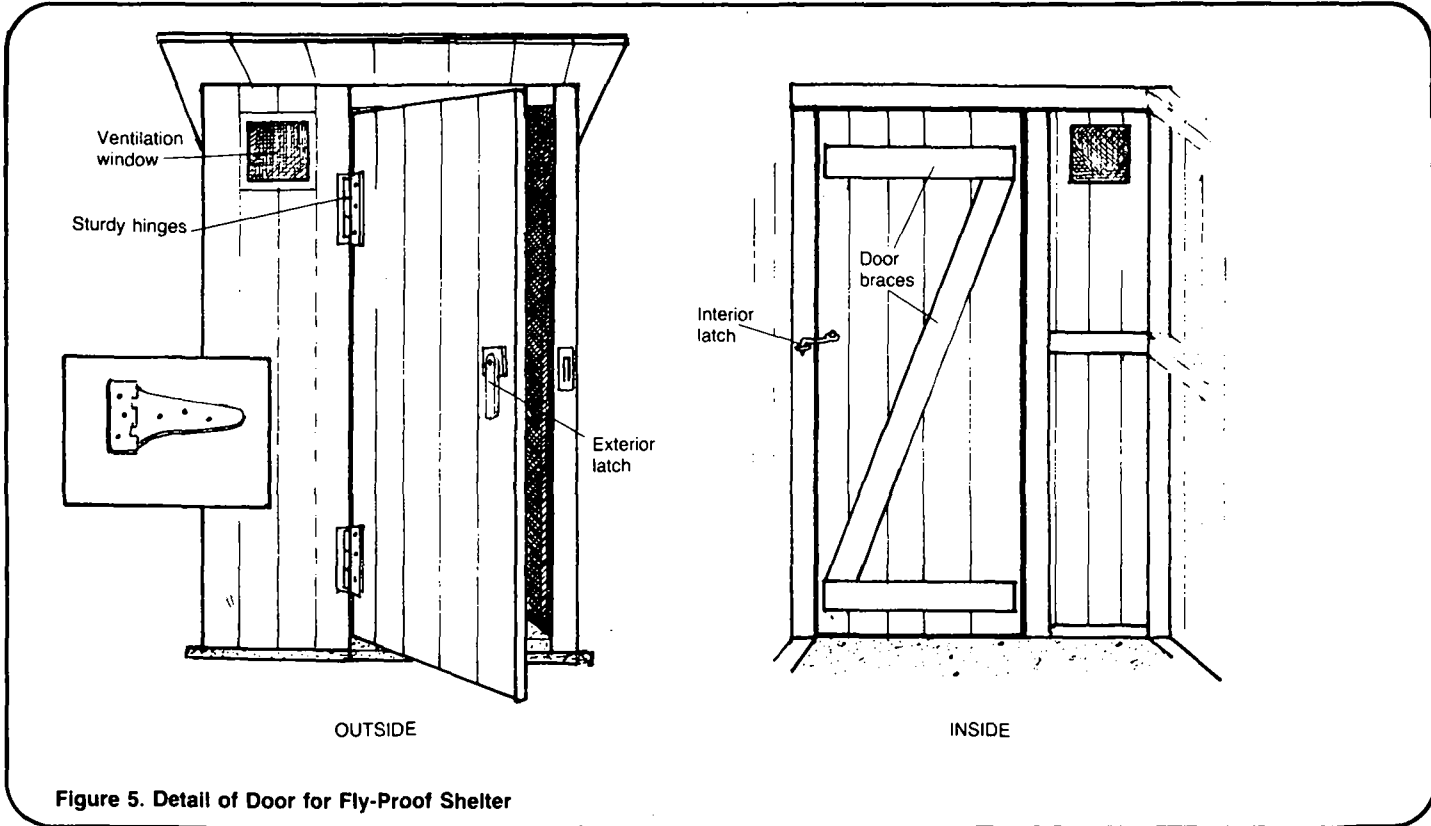


Figure 5. Detail of Door for Fly-Proof Shelter



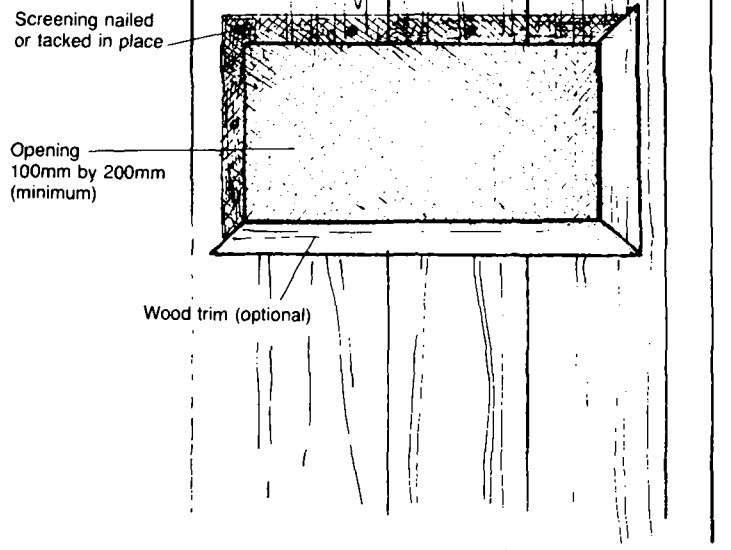
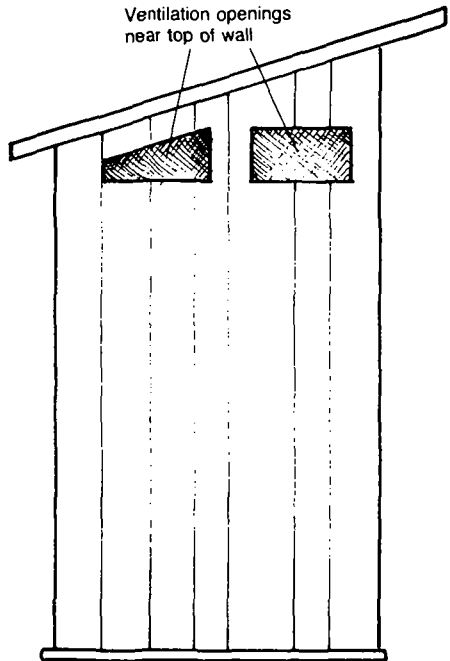


Figure 6. Fly-Proof Screening Covering Ventilation Openings

Rear View

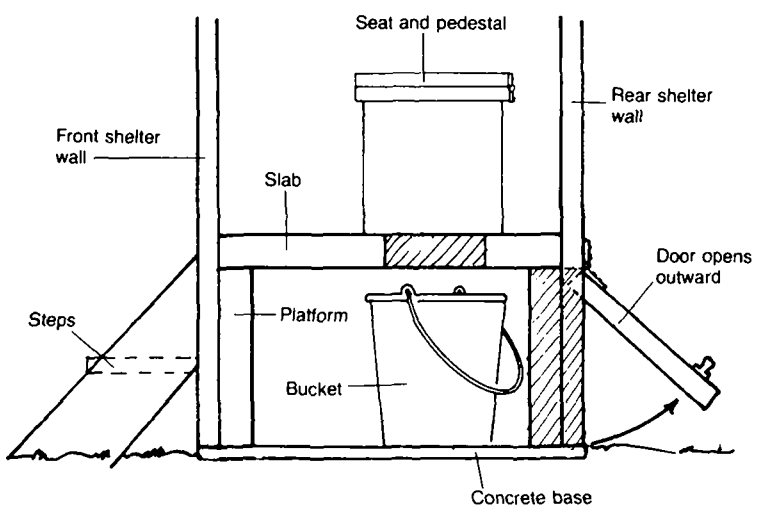
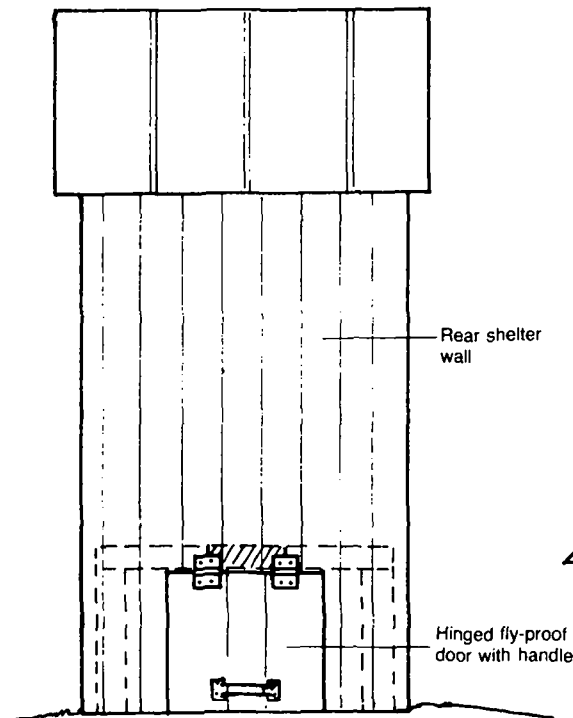


Figure 7. Detail of Shelter for Bucket Latrine

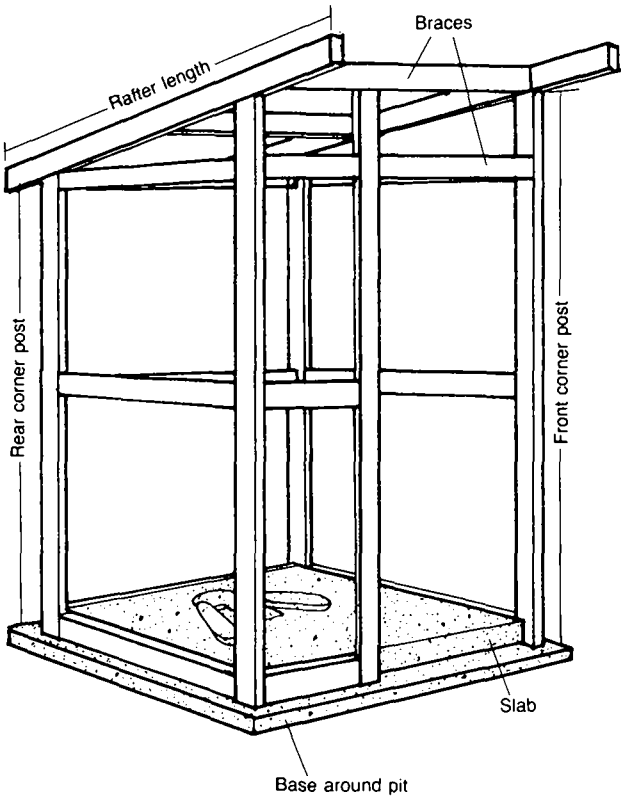


Figure 8a. Typical Shelter Framework Using Lumber

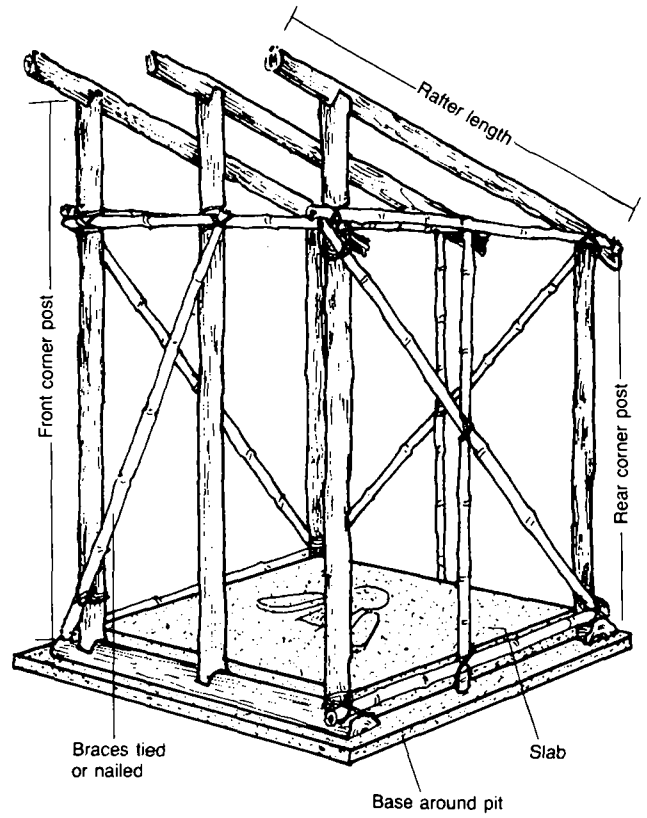


Figure 8b. Typical Shelter Framework Using Logs, Poles or Bamboo

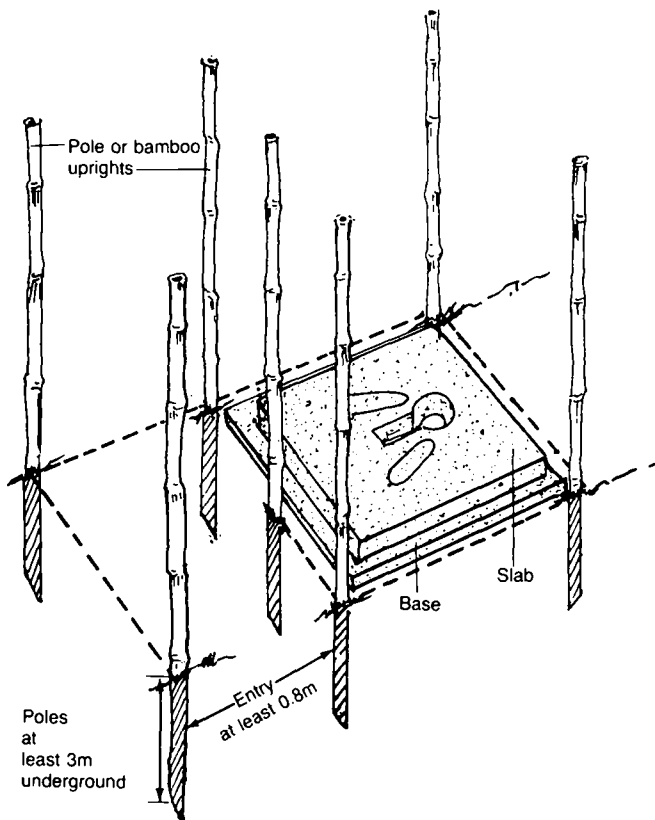
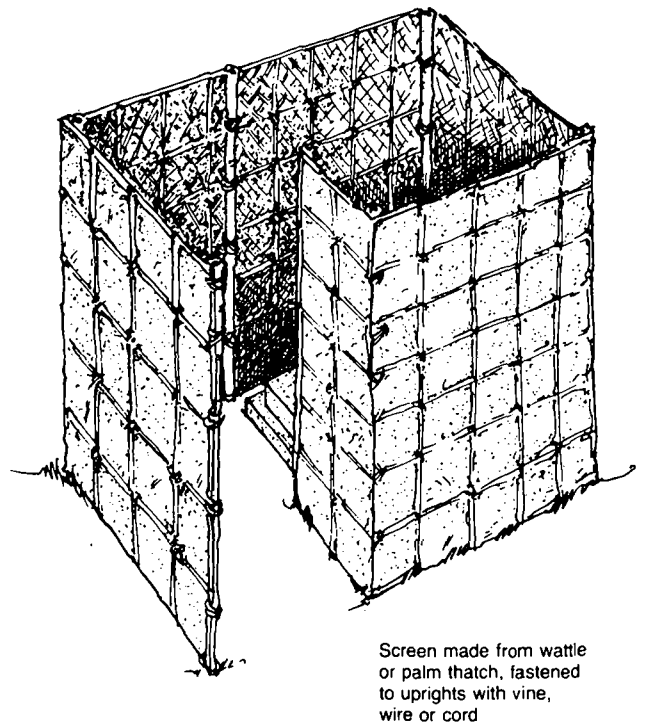
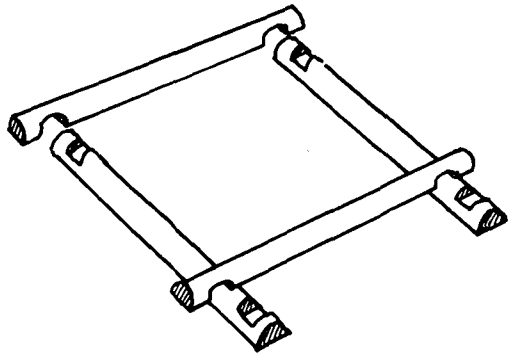


Figure 9a. Cornerposts for Screen Shelter

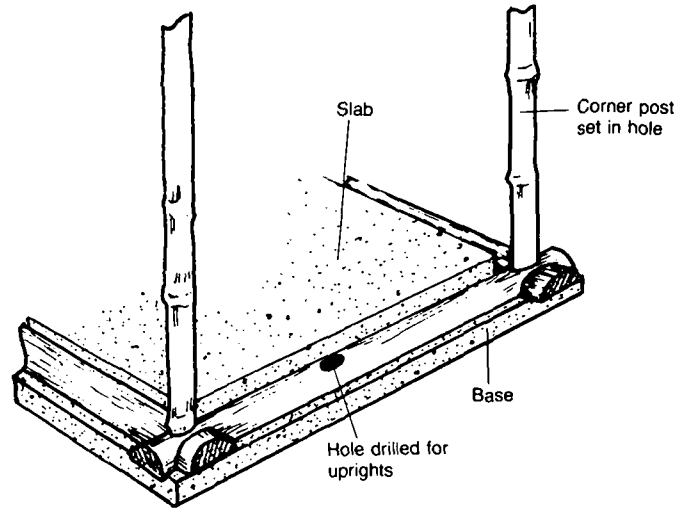


Screen made from wattle or palm thatch, fastened to uprights with vine, wire or cord

Figure 9b. Completed Screen Shelter



a. Poles notched to fit together



b. Poles on concrete base

Figure 10. Foundation for Bamboo Shelter

Table 1. Sample Materials List for Privy Shelter

Item	Description	Quantity	Estimated Cost
Labor	Foreman	1	_____
	Laborer (carpentry skills)	1	_____
Supplies	Foundation: logs, 1.5m long, 100mm diam.	4	_____
	Corner posts: wood beams, 1.8m long, 50mm diam.	4	_____
	Walls: wood boards, various lengths, 25mm thick	13.2m <sup>2</sup>	_____
	Roof: Corrugated metal	4.2m <sup>2</sup>	_____
	Screens flyproof for ventilation openings, 150 x 250mm	12	_____
	Metal hinges	2	_____
	Latch	1	_____
	Nails	_____	_____
Other	_____	_____	
Tools	Measuring tape	1	_____
	Hammer	1	_____
	Saw	1	_____
	Carpenter's level or equivalent (not essential but very useful)	1	_____
	Carpenter's square or equivalent (not essential but very useful)	1	_____
	Other	_____	_____
			_____

Total Cost = \_\_\_\_\_

Do Not Use The Quantities in the Sample - Calculate your Own

**Table 2. Sample Work Plan for Building a Wood Privy with a Door**

Time Estimate	Day	Task	Personnel	Tools and Materials
1 hour	1	Build foundation	Foreman; laborer with some carpentry skills	2 hammers; saw; nails; measuring tape (these will be needed throughout construction); 4 wood beams, 100mm by 100mm
1½ hours	1	Erect corner posts, uprights, and crossbraces	"	8 boards, 50mm by 100mm; 10 boards, 50mm by 50mm
½ hour	1	Build rafters	"	2 boards, 50mm by 100mm
3 hours	1	Build walls	"	14 square meters of boards, 25mm by 150mm
2 hours	2	Build roof	"	4 boards, 50mm by 50mm; 5 square meters of tin sheets; tin snips
1 hour	2	Build door and attach hinges and latch	"	1.7 square meters of boards, 25mm by 150mm; 3 boards, 25mm by 100mm; 2 metal hinges; screws and screwdriver; eyelet-and-hook latch
½ hour	2	Pick up scrap lumber, nails, and other leftover material	"	

3. Drill or cut holes in the foundation for the corner posts and uprights. Erect the posts, making sure they are vertical, and secure them to the foundation with wire or vine. Leave at least 0.8m space for the entryway or doorway. See Figure 10b. For a shelter with a door, the corner post and upright on each side of the doorway serve as the door frame.

4. Secure the crosspoles to the corner posts with wire or vine. The top crosspoles should be placed at the designed height of the walls. If the roof is raised for ventilation, the top crosspoles will be 100-150mm below the tops of the corner posts. For a shelter with a door, one crosspole will define the top of the doorway, which should be at least 2.0m high.

5. Secure the rafters to the corner posts with wire or vine. Rafters should extend about 0.3m beyond the front and rear walls.

6. Begin the screening wall, if there is one, by erecting two uprights as shown in Figure 11a. Bury the ends at least 0.3m in the ground and thoroughly tamp. Secure the crosspoles to the uprights.

7. Build the shelter walls and screening wall with bamboo, as shown in Figure 11b. Secure the bamboo to the crosspoles and uprights with wire or vine.

8. Build the roof with bamboo strips and palm thatch, as shown in Figure 11b. Start at the lower edge of the roof and work toward the higher edge, overlapping the thatch or palm leaves. The roof should extend about 0.3m beyond all walls.

9. Build a door, if there is one, with bamboo as shown in Figure 12. Attach the hinges, fasten the door to the door frame, and attach a latch, as described in the section on building special features.

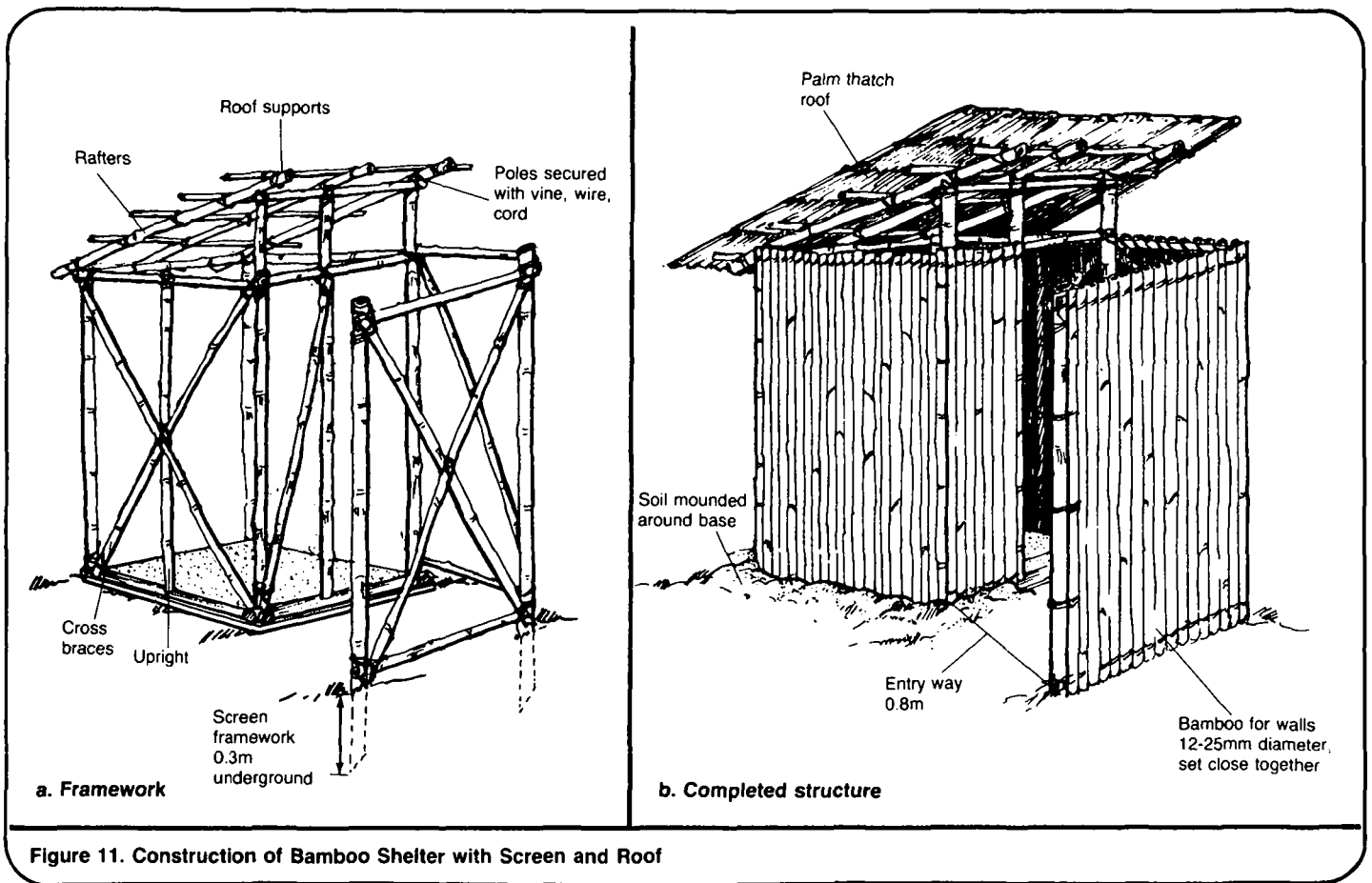


Figure 11. Construction of Bamboo Shelter with Screen and Roof

10. If the shelter has a door and is to be made fly-proof, cover all ventilation openings with screens, as described in the section on building special features.

11. Mound soil around the bottom of the walls to help keep out pests.

For a wood shelter with a roof or roof and door:

1. Assemble all laborers, supplies, tools, and diagrams needed to begin construction. Study all diagrams carefully.

2. Build a foundation around the privy slab from wood beams 50-100mm in diameter as shown in Figures 13a and 13b.

3. Erect the corner posts and uprights, making sure they are vertical, and nail them securely to the

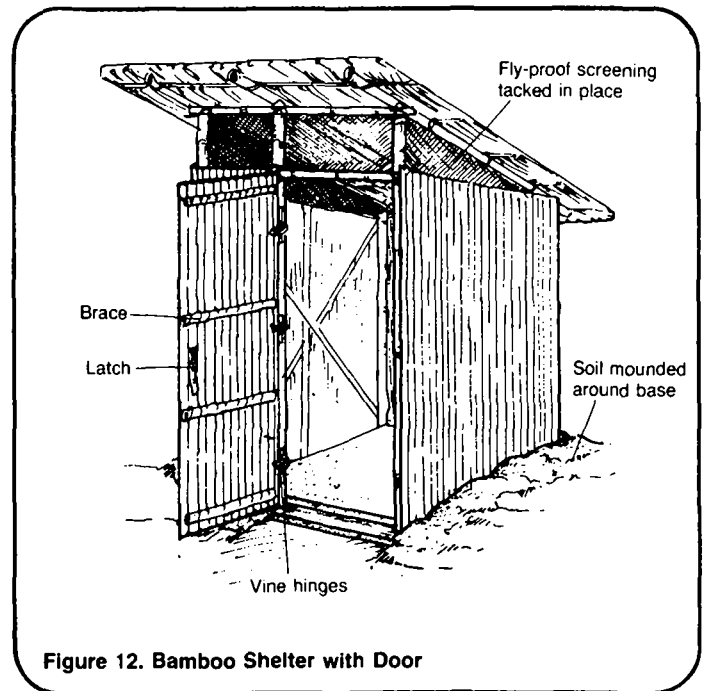


Figure 12. Bamboo Shelter with Door

foundation. Leave at least 0.8m space for the entryway or doorway, as shown in Figure 14. For a shelter with a door, the corner post and upright on each side of the doorway serve as the door frame.

4. Nail crossbraces to the inside edges of the corner posts and uprights. The top crossbrace should be at the designed height of the walls. If the roof is to be raised for ventilation, the top crossbraces will be 100-150mm below the tops of the corner posts. For a shelter with a door, one crossbrace will define the top of the doorway, which should be at least 2.0m high.

5. Nail the rafters on top of the cornerposts. The rafters should extend about 0.3m beyond the shelter walls.

6. Begin the screening wall, if there is one, by erecting two uprights as shown in Figure 14. Bury the ends 0.3-0.6m in the ground and thoroughly tamp. Nail crossbraces to the inside edges of the uprights.

7. Build the walls and screening wall by nailing boards to the outside edges of the corner posts and uprights, as shown in Figure 15.

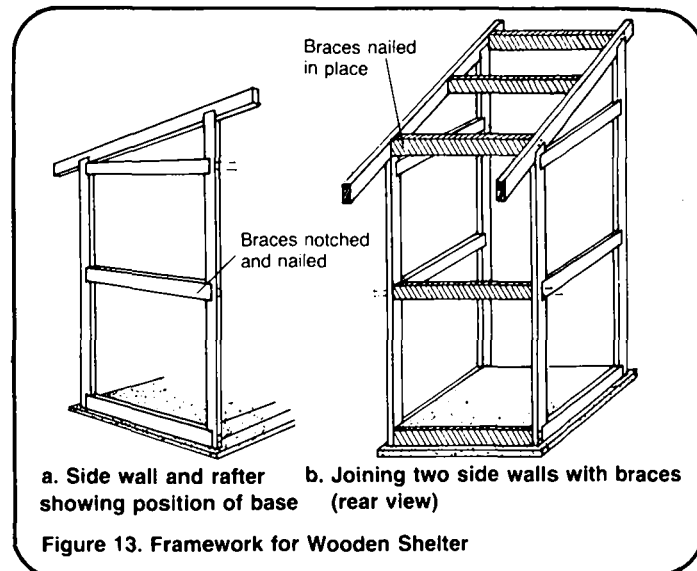


Figure 13. Framework for Wooden Shelter

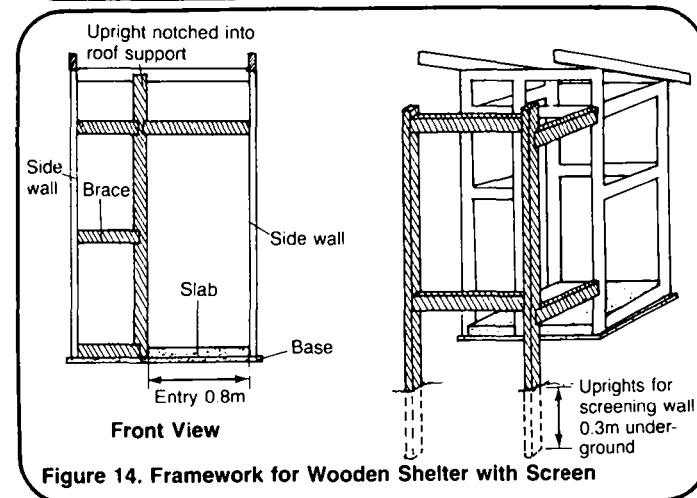


Figure 14. Framework for Wooden Shelter with Screen

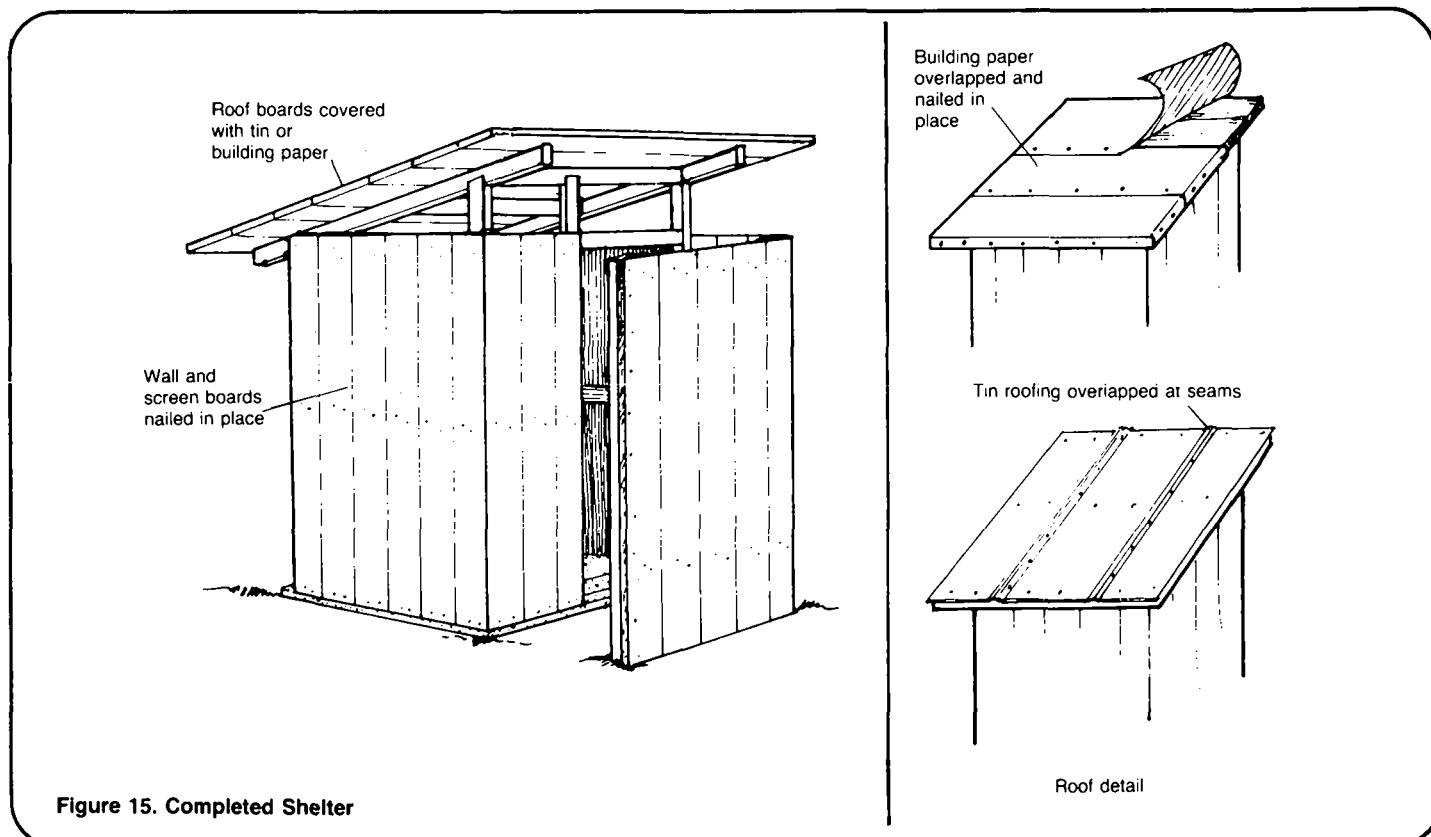


Figure 15. Completed Shelter

8. Build the roof by nailing crosspieces to the rafters, then nailing tin sheets to the crosspieces. Start from the lower edge of the roof and work toward the higher edge, overlapping the tin sheets as shown in Figure 15. The roof should extend about 0.3m beyond all walls.

9. Build a door, if there is one, with wood boards as shown in Figures 3 and 5. Attach the hinges, fasten the door to the door frame, and put on a latch as described in the section on building special features.

10. If the shelter has a door and is to be made fly-proof, cover all ventilation openings with screens as described in the section on building special features.

For a brick and mortar shelter with a roof or roof and door:

Since brick and mortar shelters should stand for more than 10 years, they are recommended for use with off-set pit privies or compost toilets, which generally last that long. Because of the weight of brick and mortar shelters, they are not recommended for use with ventilated pit privies in which the back wall of the privy rests on the privy slab.

1. Assemble all laborers, supplies, tools, and diagrams needed to begin construction. Study all diagrams carefully.

2. Mortar a row of bricks to the base of the pit, mortaring the inside edge of the bricks to the privy slab.

3. Mortar a second row of bricks overlapping the first row as shown in Figure 16. Leave at least 0.8m space for the entry.

4. For a shelter with a door, build the door frame with wood beams 50mm thick by 100mm wide, and set it in place with a temporary brace as shown in Figure 17. Fasten L-shaped metal strips to each side of the door frame

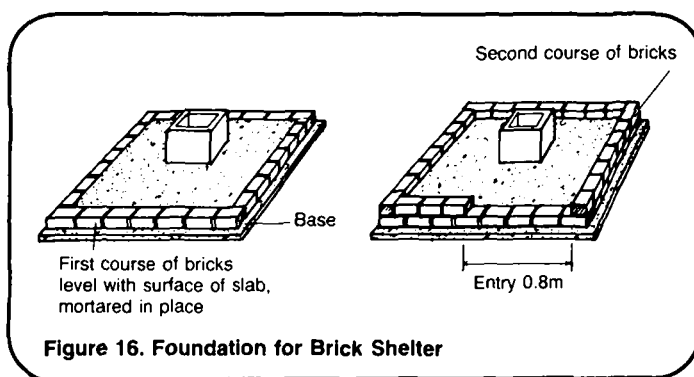


Figure 16. Foundation for Brick Shelter

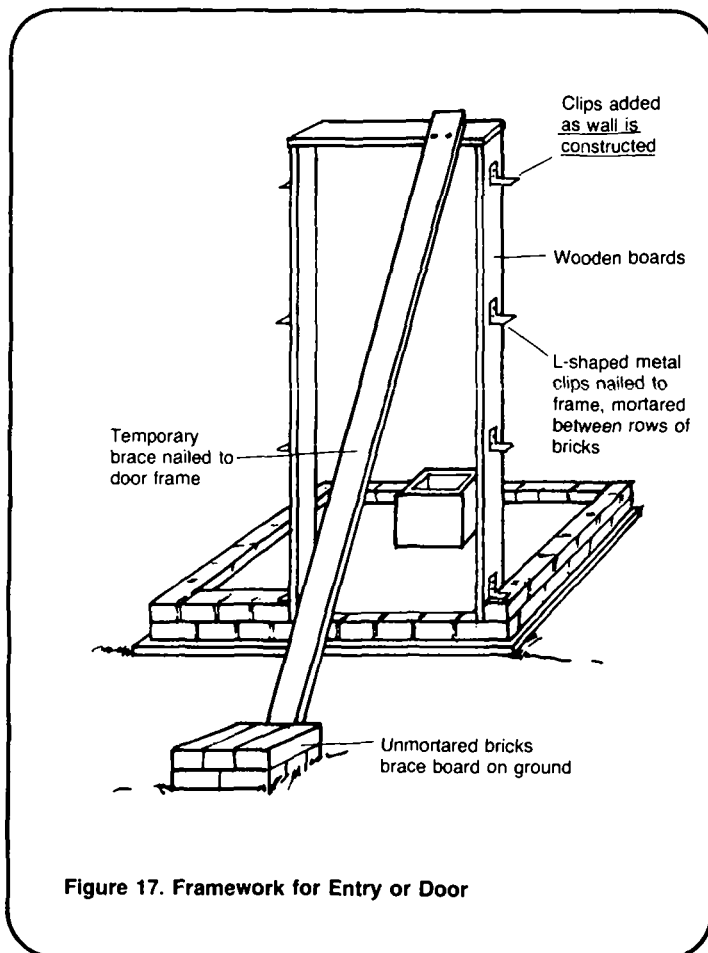
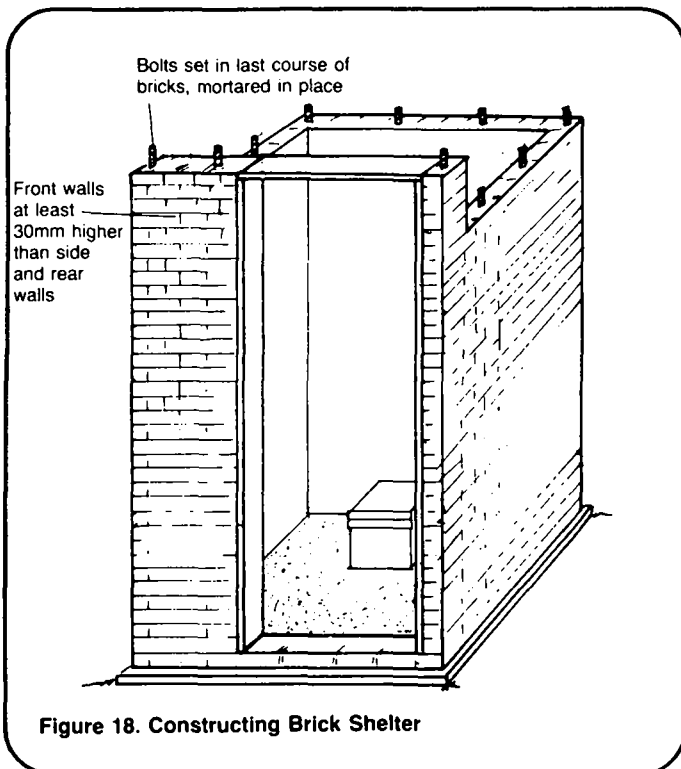


Figure 17. Framework for Entry or Door

with nails or screws. The horizontal part of the strip will be mortared between the rows of bricks to hold the frame in place. Attach a second pair of L-shaped strips when the walls reach about half their height, and a third pair when the walls reach nearly the total height.



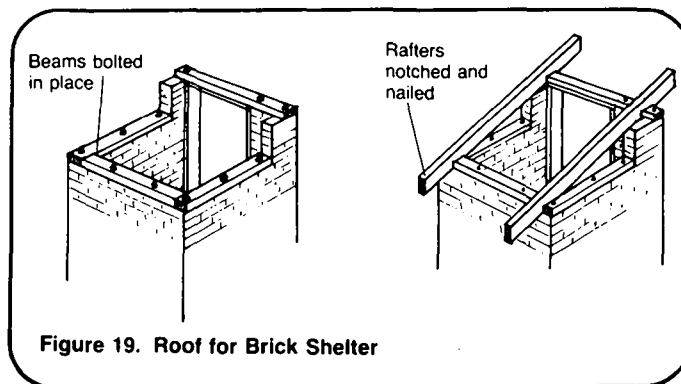
5. Continue laying rows of bricks up to the design height of the walls, being careful to keep the walls vertical.

6. Place bolts about 12mm diameter by at least 100mm long in the top bricks near the corners of each wall as shown in Figure 18. Mortar the bolts in place with the threaded ends up.

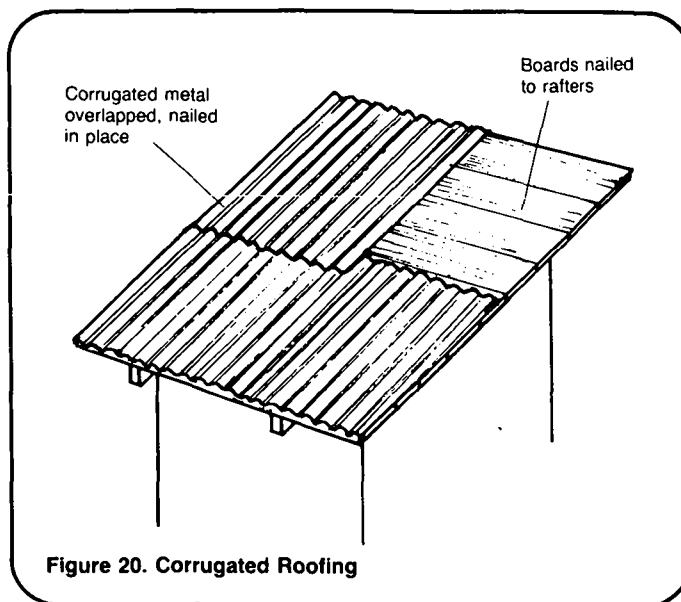
7. Allow a day or two for the mortar to set. Remove the temporary brace.

8. Drill or burn holes in wood beams 50mm thick by 100mm wide, matching the size and location of the holes to the bolts sticking up from the bricks. Set these top beams in place and fasten them to the bolts securely using nuts as shown in Figure 19.

9. Nail the rafters to the top beams. The rafters should extend about 0.3m beyond the walls as shown in Figure 19.



10. Build the roof by nailing cross-pieces to the rafters and nailing corrugated metal sheets to the cross-pieces. The furrows in the metal should be lined up in the direction of the roof slope. Start from the lower edge of the roof and work toward the higher edge, overlapping the corrugated sheets as shown in Figure 20. The roof should extend about 0.3m beyond all walls.



11. Build a screening wall, if there is one, by nailing uprights to the wood beam foundation. Nail the crossbraces to the uprights and to the top beam of the shelter. Nail the boards to the uprights as shown in Figure 21a.

12. Build a door, if there is one, with wood boards as shown in Figure 21b. Attach the hinges, fasten the door to the door frame, and put on a latch, as described in the section on building special features.

13. If the shelter has a door and is to be made fly-proof, cover all ventilation openings with screen as described in the section on building special features.



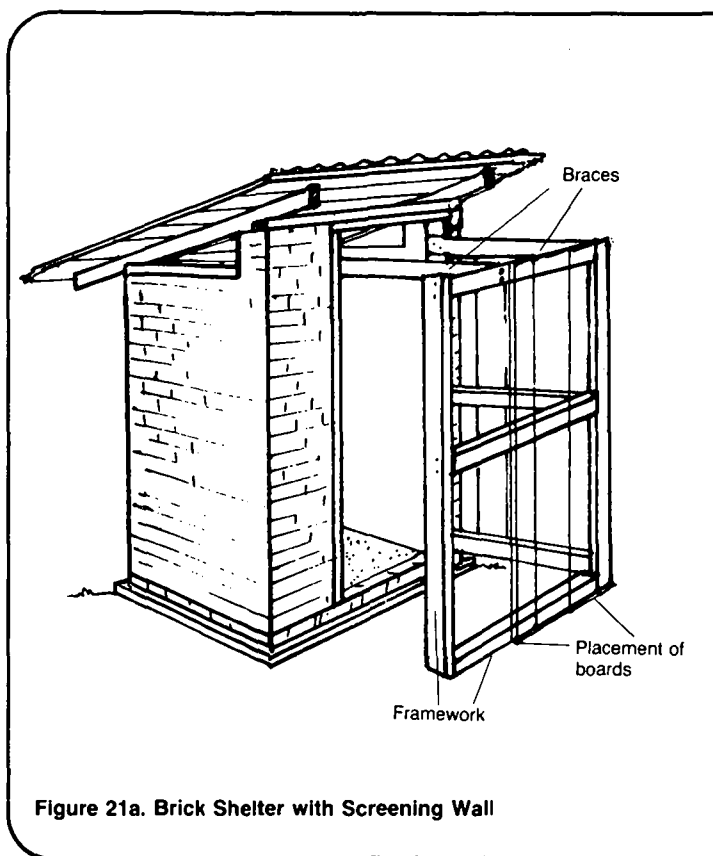


Figure 21a. Brick Shelter with Screening Wall

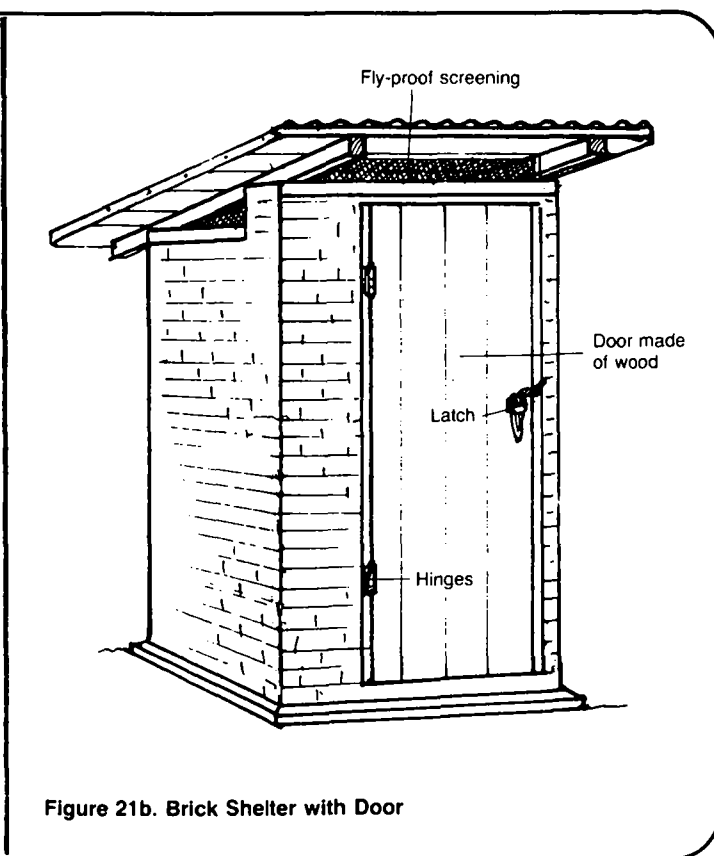


Figure 21b. Brick Shelter with Door

## Building Special Features

**Ventilation Openings.** If the roof is not raised above the walls for ventilation, and ventilation openings are desired, cut openings near the tops of the walls. The openings should be about 200mm wide by 100mm high and spaced around the walls about 150mm apart as shown in Figure 6.

**Screens.** Screens covering ventilation openings must have mesh no larger than 2mm in order to keep out flies. Screens should be made of rust-proof material such as bronze, copper, plastic, or aluminum. If the screens are not rust-proof, paint them to prevent rust.

To cover a ventilation opening, cut a section of screen large enough to overlap the opening by 25mm on all sides and nail it in place as shown in Figure 6.

**Door Hinges.** Before attaching the hinges, hold the door in place and mark the door and the door frame where the hinges should be placed. Hinges should be about 150mm from the top of the door and 250mm from the bottom. They should be placed so that the door opens outward, if this is culturally acceptable.

If you are using prefabricated metal hinges with removeable pins, remove the pin from each hinge and separate the two halves. Attach one half with screws or nails to the door frame and the other half to the door. Raise the door in place, fit the halves of the hinges together, and reinsert the pin in each hinge.

If you are using a strap hinge, install it on the door. Lift the door into place and use a temporary support to hold it off the floor in its correct position. Accurately mark the proper location of the hinge on the door frame. Take the hinge apart and install the frame half. Then, hang the door.

For hinges of stiff leather such as soles of discarded boots or sandals, nail the hinges to the door, raise the door in place, and nail the hinges to the door frame.

For hinges made of vine, raise the door in place and tie the vine around the bamboo poles of the door and door frame. Leave enough slack so the door can be easily opened and closed.

**Door Latch.** For an eyelet-and-hook latch, secure the eyelet to the inside

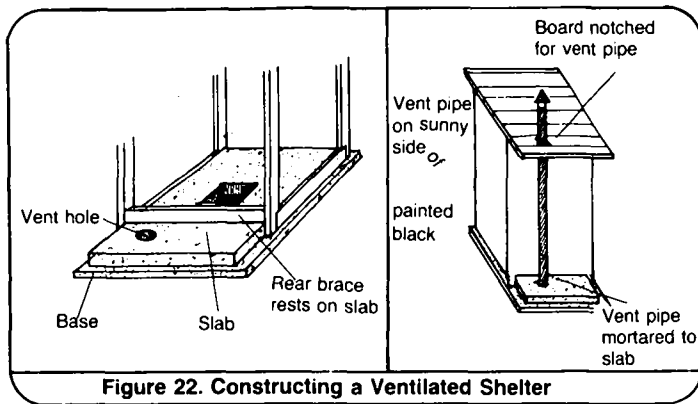


Figure 22. Constructing a Ventilated Shelter

of the door frame, and attach the hook to the inside of the door. The latch should be just above the middle of the door. For a bar latch, nail a piece of wood to the inside of the door. For a peg-and-loop latch, fasten the bamboo peg to the inside of the door frame and tie the vine loop to the inside of the door.

**Vent Pipe.** The vent pipe is mortared to the vent hole in the privy slab and attached to the shelter roof or the wall, if extra support is needed. The pipe should be vertical. If the roof overhangs the vent hole, cut a hole or notch in the roof to accommodate the vent pipe as shown in Figure 22. Attach the vent pipe to the roof and wall with either a metal band and screws, wood and nails, wire, or vine.

**Shelter for Off-set Pit Privy.** The foundation for the shelter must rest on the ground and abut the platform which supports the privy slab. Level the ground and thoroughly tamp it before building the foundation. The bottom of the privy walls begin at the foundation and completely enclose the platform. The bottom of the doorway or entryway begins at the privy slab and is higher than the foundation. For additional details see "Constructing Slabs for Privies," SAN.1.C.1.

**Shelter for Bucket Latrine.** The foundation for the shelter rests on the platform base and abuts the platform. Build the shelter walls to completely enclose the platform. The bottom of the entryway is level with the privy slab as shown in Figure 23. A fly-proof door for removal of the bucket

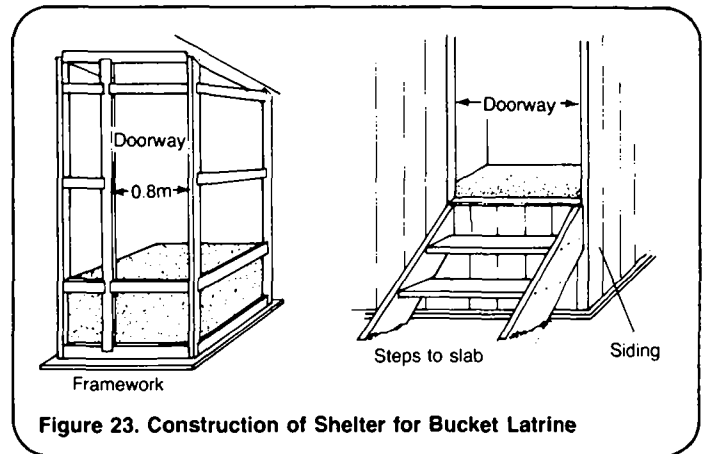


Figure 23. Construction of Shelter for Bucket Latrine

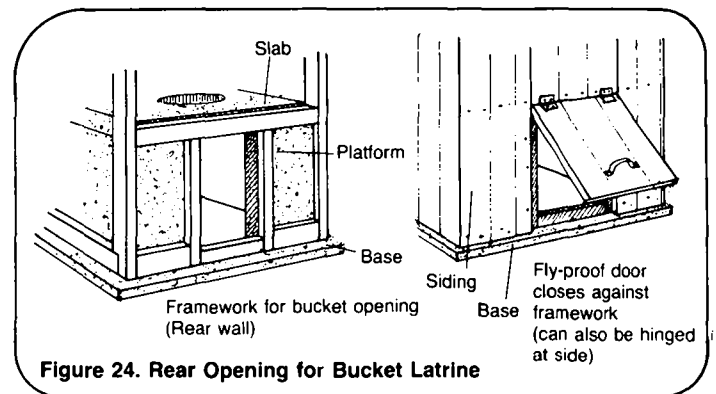
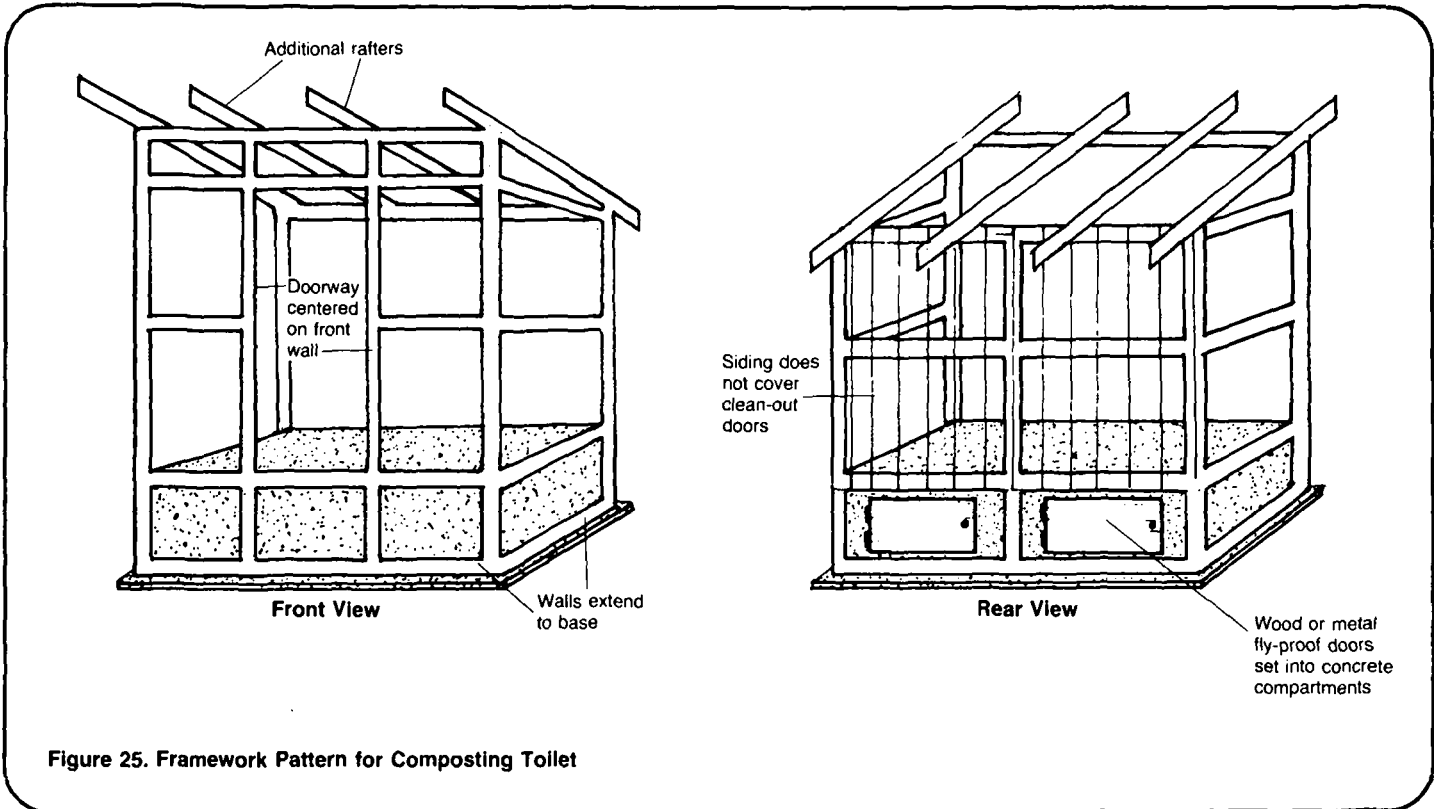


Figure 24. Rear Opening for Bucket Latrine

must be built into either the rear of the platform or the rear wall of the shelter. The door should have hinges and a latch to keep it tightly closed. If the door is built into the platform, leave an opening in the rear shelter wall as shown in Figure 24. For additional details, see "Constructing Bucket Latrines," SAN.1.C.5.

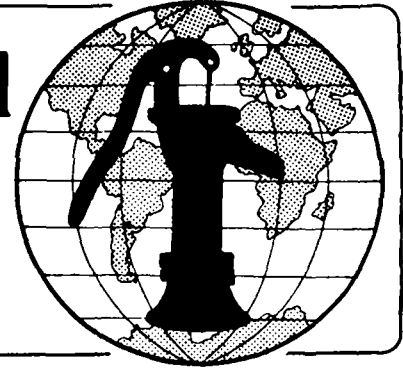
**Shelter for a Compost Toilet.** The foundation for the shelter rests on the base of the double vault and abuts the vault. Build the shelter walls to completely enclose the platform. The bottom of the entryway is level with the privy slab as shown in Figure 25. Airtight doors will be built into the rear of the vault. Leave openings in the rear shelter wall to allow access to these doors as shown in Figure 25. For additional details, see "Constructing Compost Toilets," SAN.1.C.6.



## Notes

**Technical Notes** are part of a set of "Water for the World" materials produced under contract to the U.S. Agency for International Development by National Demonstration Water Project, Institute for Rural Water, and National Environmental Health Association. Artwork was done by Redwing Art Service. Technical Notes are intended to provide assistance to a broad range of people with field responsibility for village water supply and sanitation projects in the developing nations. For more detail on the purpose, organization and suggestions for use of Technical Notes, see the introductory Note in the series, titled "Using 'Water for the World' Technical Notes." Other parts of the "Water for the World" series include a comprehensive Program Manual and several Policy Perspectives. Further information on these materials may be obtained from the Development Information Center, Agency for International Development, Washington, D.C., 20523, U.S.A.

# Water for the World



## Constructing Aqua Privies Technical Note No. SAN. 1.C.4

An aqua privy is an underground watertight vault filled with water that receives excreta and washwater from a drop-pipe, allows solids to settle to the bottom, and discharges effluent to a soakage pit. Constructing an aqua privy involves excavating two pits, building a vault from concrete or brick and mortar, installing a concrete slab with a drop-pipe, installing an overflow pipe and a vent pipe, laying sewer pipe from the vault to the soakage pit, and building a soakage pit.

With careful maintenance, a properly constructed aqua privy can last 10-20 years or more. This technical note describes each step in constructing an aqua privy. Read the entire technical note before beginning construction.

### Materials Needed

The project designer must provide three papers before construction can begin:

1. A location map similar to Figure 1.
2. Design drawings similar to Figures 2 and 3.
3. A materials list similar to Table 1.

After the project designer has given you these documents and you have read this technical note carefully, begin assembling the necessary workers, supplies and tools.

### Useful Definitions

**EFFLUENT** - Settled sewage; in an aqua privy, liquid flowing from the vault to a seepage pit.

**FLOW LINE** - The highest level to which liquid can rise in an aqua privy.

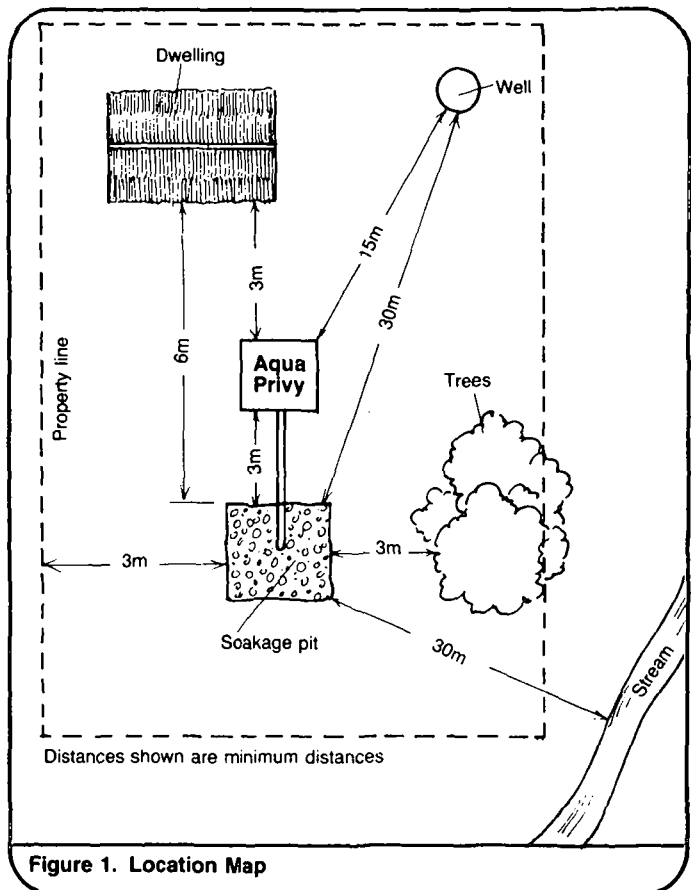


Figure 1. Location Map

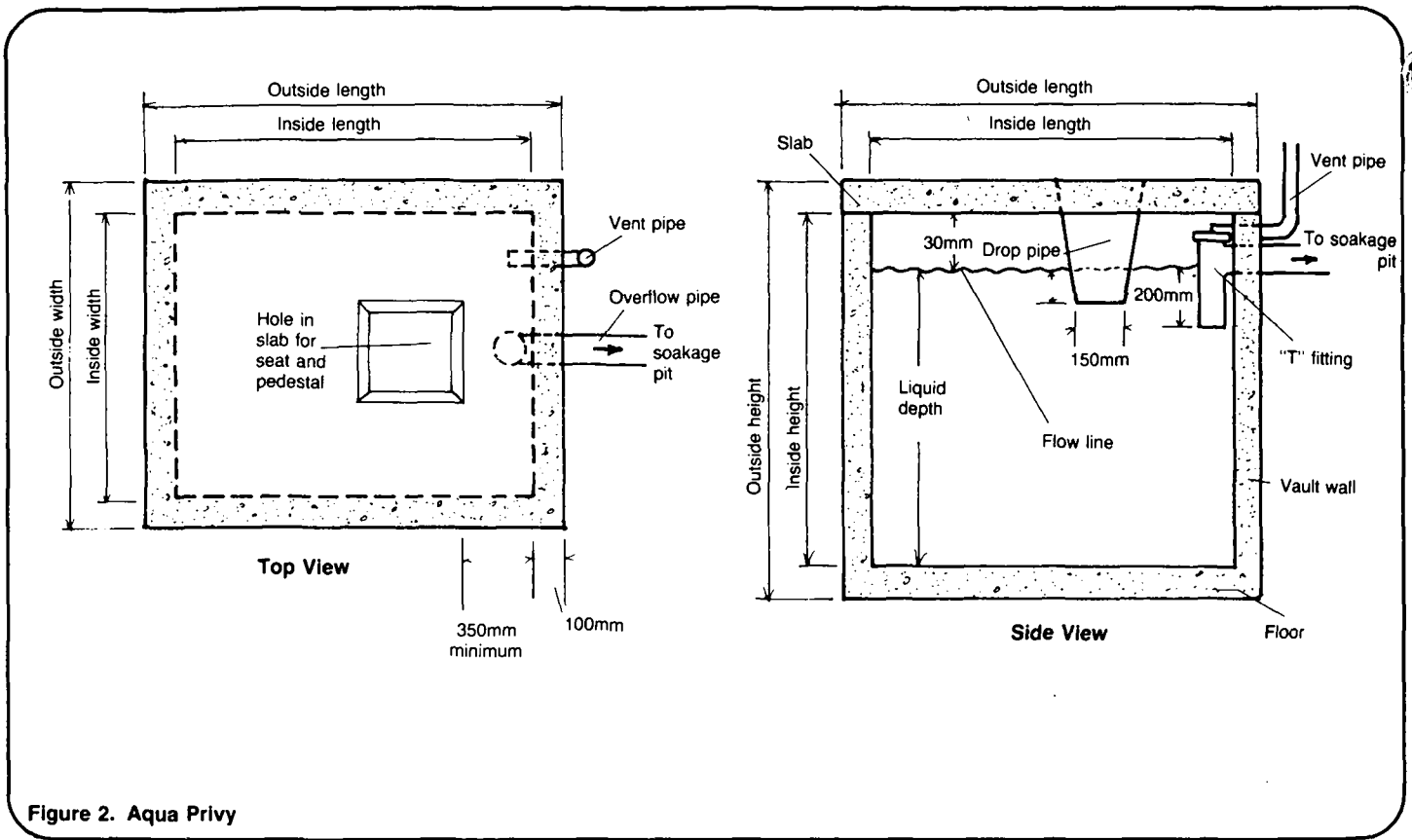


Figure 2. Aqua Privy

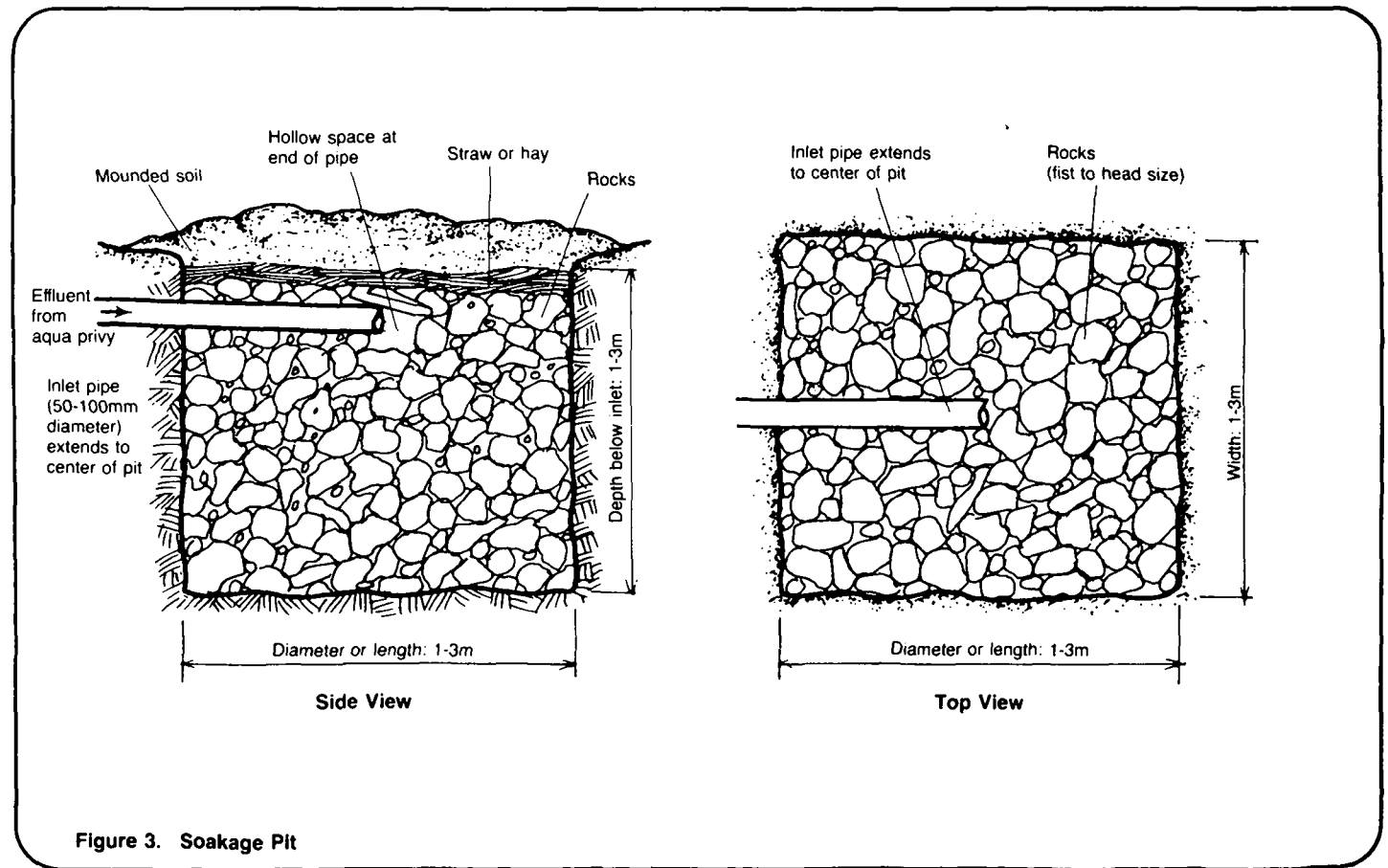


Figure 3. Soakage Pit

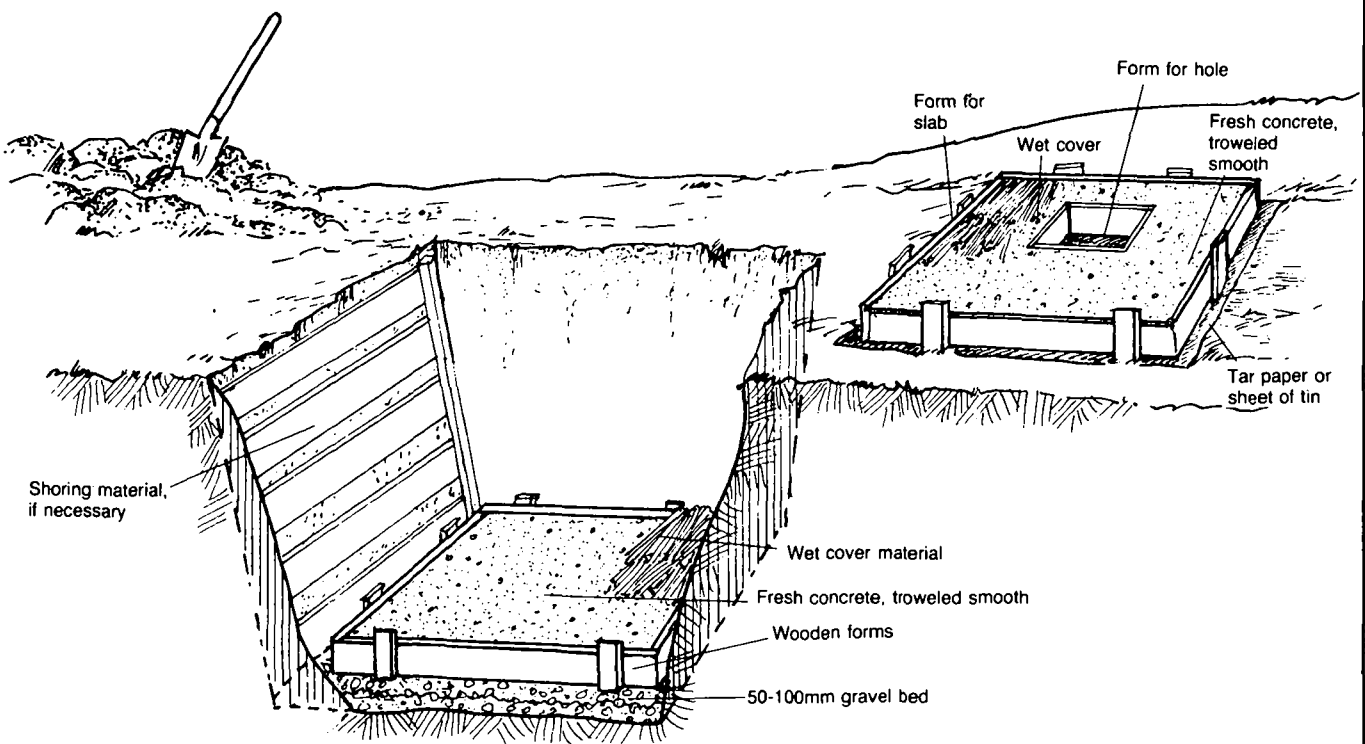


Figure 5. Fresh Concrete in Floor and Slab Forms

8. Cover the fresh concrete with wet straw, burlap bags, or equivalent, and keep moist for three to seven days. See Figure 5.

9. While the concrete floor is setting, build the forms for the slab. For details on slab construction, see "Constructing Slabs for Privies," SAN.1.C.1. The slab will be similar to the one for an off-set pit, with two exceptions: instead of installing a chute at an angle, install a drop-pipe extending straight down; the rear edge of the sitting or squatting hole is 450mm from the rear edge of the slab.

10. Half-fill the slab forms with concrete, lay in reinforcing material, and fill the forms the rest of the way. Smooth with a trowel and cover with wet straw or burlap. Keep moist for three to seven days. See Figure 5.

11. When the concrete floor has set, remove the cover material and the forms. Build the wall forms in place. Make two openings in the rear wall--one for the vent pipe and one for the overflow pipe. Make the vent pipe opening near the top corner of the wall. The position of the overflow pipe is critical, because it determines the flow line in the vault. The distance from the bottom of the overflow pipe to the floor of the vault must equal the liquid depth of the vault. The distance from the bottom of the overflow pipe to the top of the wall must be 300mm. Be certain these measurements are correct before pouring concrete. See Figure 6.

12. Position reinforcing material in the wall forms. Brace the forms to prevent them from collapsing when the concrete is poured. Coating the forms

with oil or grease will make them easier to remove so they can be used again.

13. Mix and pour the concrete into the wall forms. Be certain the concrete fills all voids in the forms. Use a steel rod or stout stick to work the concrete between the reinforcing material and the forms. Smooth the tops of the walls with a trowel.

14. Cover the tops of the walls with wet straw or burlap and keep them moist for three to seven days. See Figure 6.

15. Remove the cover material and wall forms.

16. Mortar the "T" fitting and overflow pipe in place. Attach about 0.6m of vent pipe in place. Mortar the joints between walls and floor. See Figure 7.

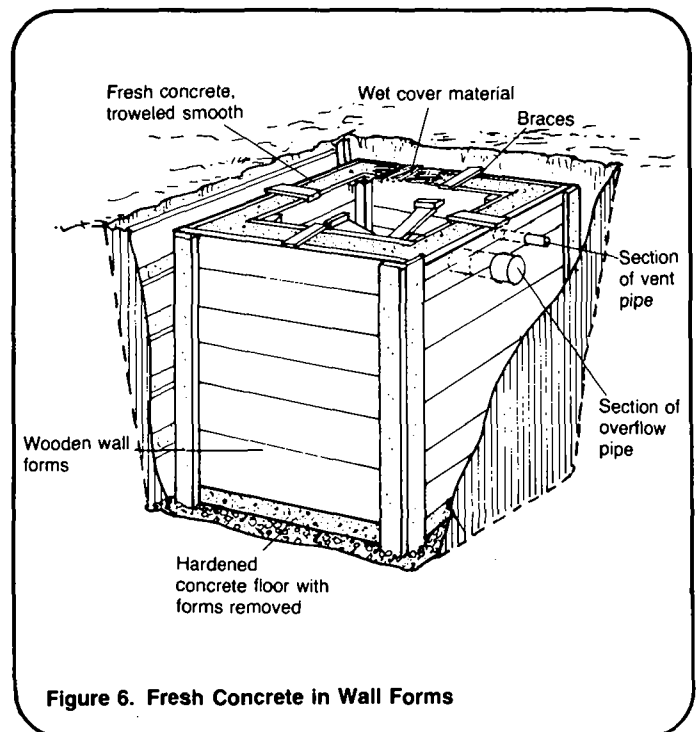


Figure 6. Fresh Concrete in Wall Forms

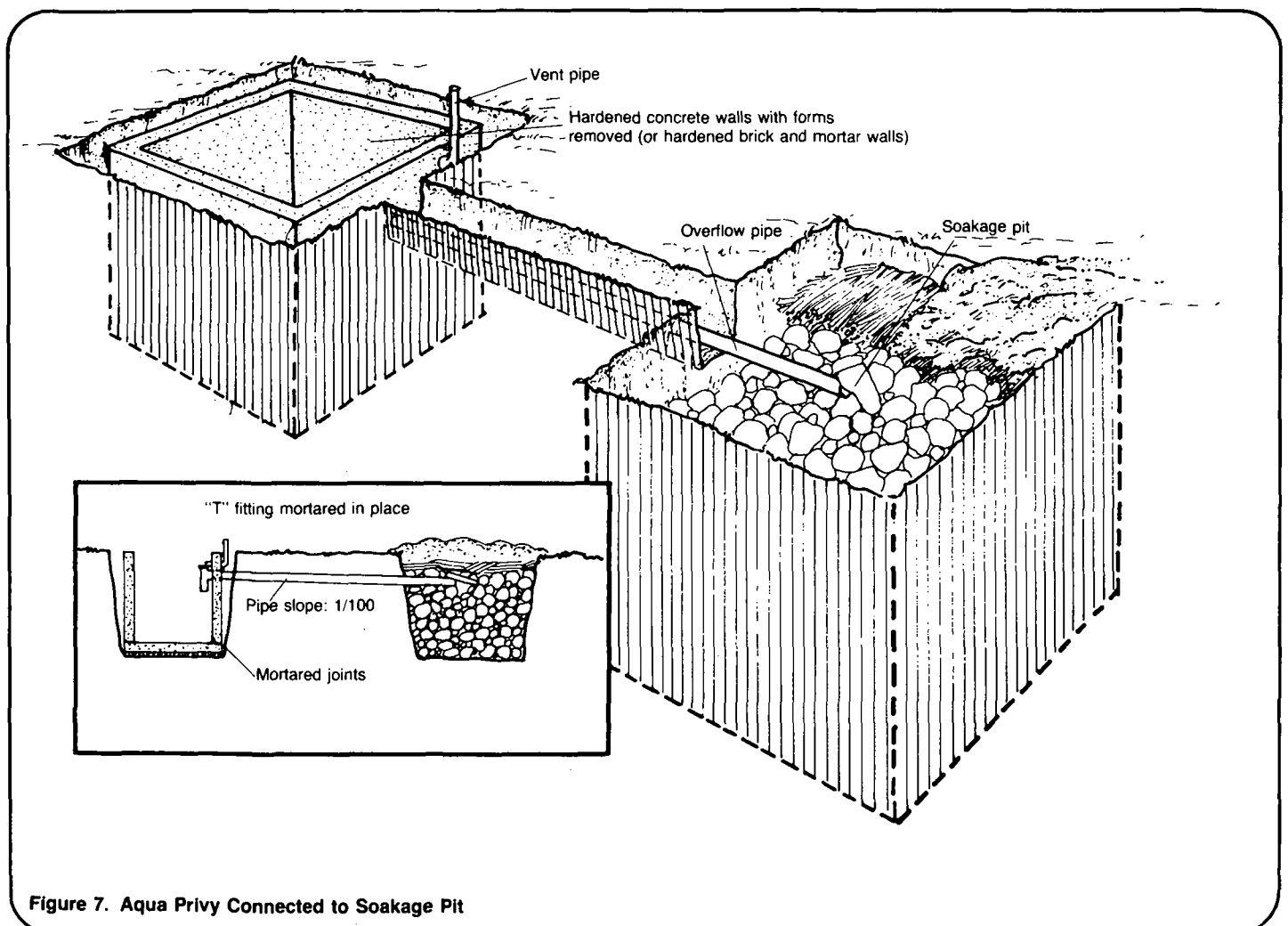


Figure 7. Aqua Privy Connected to Soakage Pit



**Table 1. Sample Materials List for Aqua Privy**

Item	Description	Quantity	Estimated Cost
Labor	Foreman	1	_____
	Worker (skilled with concrete)	1	_____
	Worker (unskilled)	1	_____
Supplies	Wood (for forms)	_____	_____
	Nails (for forms)	_____	_____
	Cement (Portland)	_____	_____
	Sand (clean, sized fine to 6mm)	_____	_____
	Gravel (clean, sized 6-25mm)	_____	_____
	Water (clear)	_____	_____
	Reinforcing material	_____	_____
	Overflow pipe (vitrified clay, 100mm diameter)	_____	_____
	Elbow fitting (vitrified clay, 100mm diameter)	_____	_____
	Vent pipe (galvanized metal, 25mm diameter)	_____	_____
	Drop-pipe (galvanized metal, 400mm long)	_____	_____
	Materials for soakage pit: rocks	_____	_____
	straw	_____	_____
	Tools	Measuring tape	1
Hammer		1	_____
Saw		1	_____
Shovels		2	_____
Trowel		1	_____
Container for mixing concrete		2	_____
Carpenter's level (optional)		1	_____
Carpenter's square (optional)		1	_____
Tar or equivalent (for sealing slab to vault)		_____	_____

Total Estimated Cost = \_\_\_\_\_

**Caution!**

1. When excavating in loose soil, or when digging deeper than 1.5m, shore up the sides of the pit to prevent a cave-in that could be fatal to a worker in the pit.
2. Build the aqua privy and soakage pit to the exact dimensions and at the site specified by the project designer.

**Construction Steps**

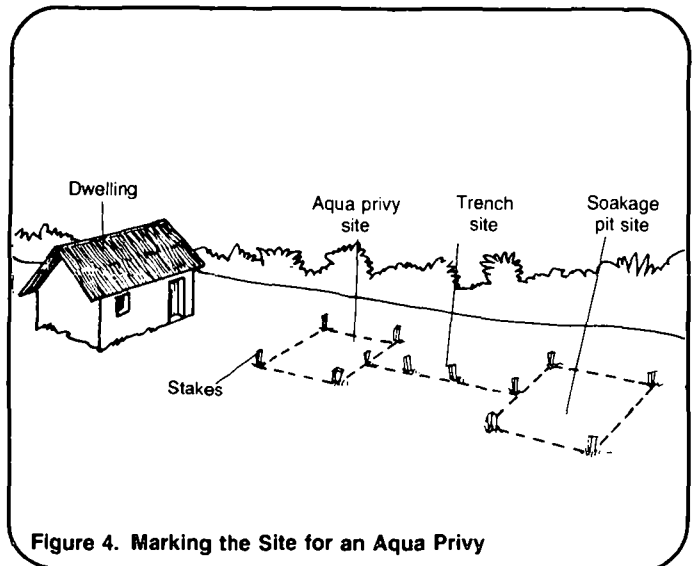
Depending on local conditions, availability of materials, and skills of workers, some construction steps will require only a few hours, while others may take a day or more. Read the construction steps and make a rough estimate of the time required for each step based on local conditions. You will then have an idea of when specific workers, materials, and tools must be available during the construction process. Draw up a work plan similar to Table 2 showing construction steps.

**Building a Concrete Aqua Privy**

1. Assemble all laborers, materials, tools, and drawings needed to begin construction. Study all drawings carefully.

2. Using the location map and a measuring tape, locate the sites for the aqua privy vault, soakage pit, and overflow pipe, and mark them on the ground with wooden stakes or sticks as shown in Figure 4.

3. Dig the hole for the aqua privy vault. The depth is the same as the outside height of the vault. Allow a working area of at least 0.3m around all sides.



**Figure 4. Marking the Site for an Aqua Privy**

4. Level the bottom of the hole and tamp it down. Spread 50-100mm of gravel, pebbles or crushed rock on the bottom of the hole.

5. Build forms for the floor as shown in Figure 5.

6. Mix concrete to the correct proportions. A common mix by volume is one part cement to two parts sand to three parts gravel plus enough water to make a fairly stiff mix. Mix until the sand and gravel are evenly coated with cement and water.

7. Pour in concrete until the forms are about half full. Then lay in reinforcing material such as steel rods, wire mesh or bamboo strips and pour in concrete until the forms are full. Smooth the surface with a trowel.

**Table 2. Sample Work Plan for Concrete Aqua Privy**

Time Estimate	Day	Task	Personnel	Tools and Materials
1 hour	1	Lay out system on ground	Foreman, present during entire construction; 1 laborer	Measuring tape, stakes, drawings
8 hours	1	Dig hole for aqua privy vault	2 or more laborers	2 or more shovels
2 hours	2	Spread gravel; build floor forms	2 laborers	Gravel, wood, hammer, saw, nails
4 hours	2	Mix and pour concrete for floor	2 laborers	Cement, sand, gravel, water, mixing container, reinforcing material, trowel
----	2-6	Cover; keep moist for 4 days	2 laborers	Wet straw
2 hours	3	Build form for slab	2 laborers	Wood, hammer, saw, nails
3 hours	3	Mix and pour concrete for slab	2 laborers	Cement, sand, gravel, water, container, reinforcing material, trowel
----	3-7	Cover; keep moist for 4 days	2 laborers	Wet straw
8 hours	7	Remove floor forms; build wall forms; allow for overflow and vent pipes; position reinforcing material	2 laborers	Wood, hammer, saw, nails, reinforcing material
5 hours	8	Mix and pour concrete for walls	2 laborers	Cement, sand, gravel, water, trowel, container
-----	8-12	Cover; keep moist for 4 days	2 laborers	Wet straw
9 hours	13	Remove wall forms; mortar "T" fitting; dig trench; lay overflow pipe	2 laborers	"T" fitting, overflow pipe, mortar, shovels
----	14-15	Build soakage pit	See "Constructing Sumps, Soakage Pits and Trenches," SAN.1.C.7	
7 hours	16	Mortar drop-pipe in place; fill vault with water; install slab	2 laborers	Drop-pipe, mortar, tar
----	17-18	Build privy shelter	See "Constructing Privy Shelters," SAN.1.C.3	

17. Excavate the trench line from the vault to the soakage pit site. The trench should be as straight as possible and slope evenly downward from the vault to the pit site, with a downward slope of about 1 in 100 (one unit down for every 100 units in distance).

18. Lay the overflow pipe in the trench and mortar all sections together. Cover with soil.

19. Excavate the soakage pit. See "Constructing, Operating and Maintaining Sumps, Soakage Pits and Trenches," SAN.1.C.7 for complete details. Remember that the effective depth of the soakage pit is measured downward from the end of the pipe, not from the surface of the ground: Fill in the pit with rocks, extend the pipe to the center of the pit, cover with straw, and mound with soil. See Figure 7.

20. Use soil to fill in the space between the aqua privy vault walls and the sides of the hole. Be careful not to disturb or damage the overflow pipe.

21. Remove the cover material and forms from the slab. Mortar the drop-pipe in place and set the slab over the vault. The drop-pipe should enter the water to a depth of at least 100mm. Waterproof the edges of the slab where they meet the vault. Use tar or an equivalent, not mortar, because the slab will eventually have to be removed. See Figure 8.

22. Fill the vault up to the flow line with water.

23. If there are any additions to the slab, build them now. See "Constructing Slabs for Privies," SAN.1.C.1.

24. Build a shelter around the aqua privy. See "Constructing Privy Shelters," SAN.1.C.3.

25. Attach the remaining sections of vent pipe to the rear wall or roof of the shelter. See Figure 8.

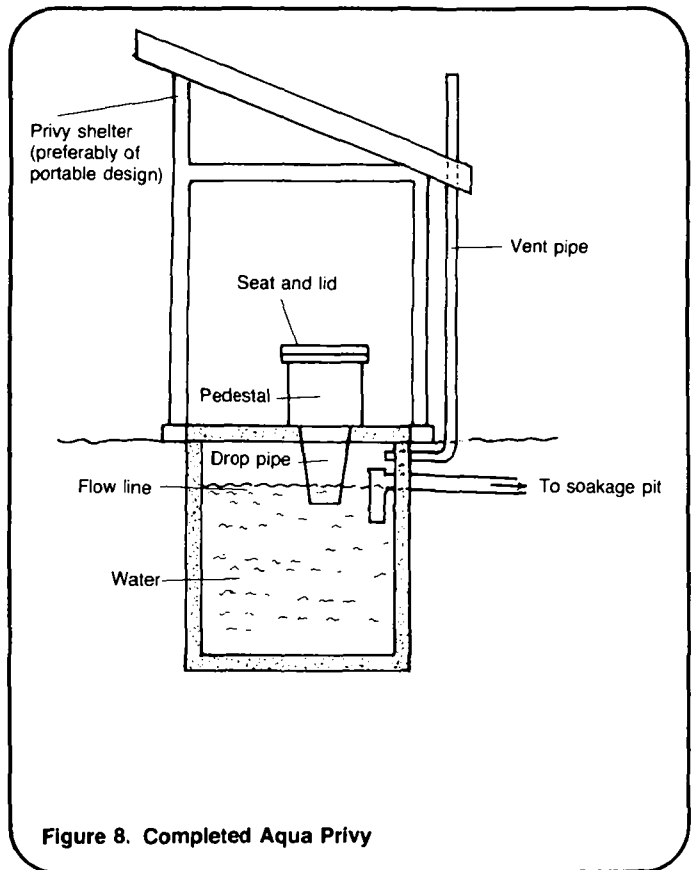


Figure 8. Completed Aqua Privy

### Building a Brick and Mortar Aqua Privy

1. Follow steps 1-10 for "Building a Concrete Aqua Privy."

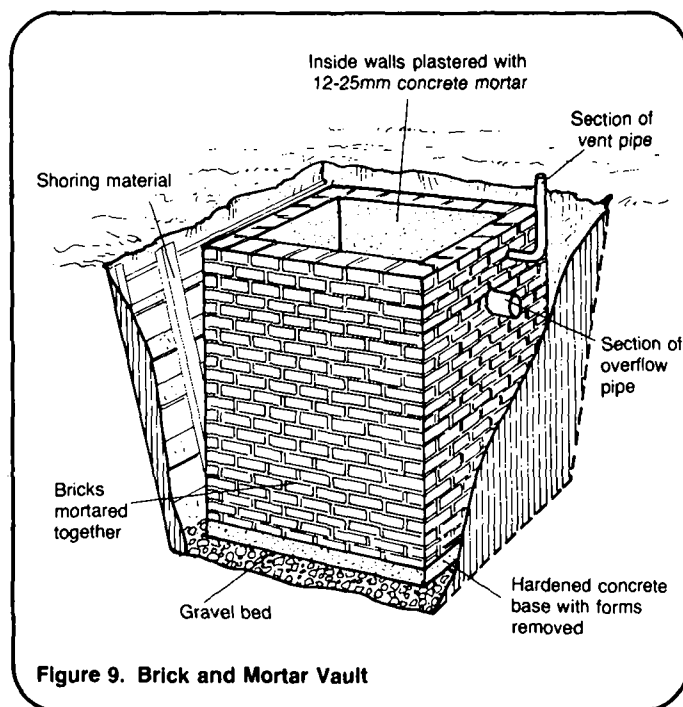
2. When the concrete floor has set, remove the cover material and the forms. Begin laying up the walls of the vault using bricks or concrete blocks and mortar. See Figure 9. A common mortar mix by volume is one part cement to three parts sand and enough water to make a workable mix.

3. When the rear wall reaches the flow line elevation, mortar a section of overflow pipe in place. Continue laying up the walls. Before the walls reach their design height, mortar a section of vent pipe in place near one corner of the rear wall. Continue laying up the walls until they reach the design height. If open bricks or blocks are used, fill in the top course with mortar.

4. Allow one to three days for the mortar to set.

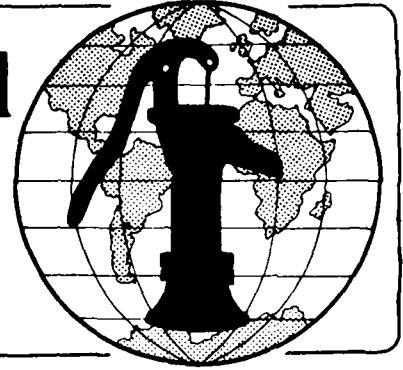
5. Mortar the "T" fitting and overflow pipe in place. Attach about 0.6m of vent pipe in place. Plaster the inside of the vault with two 10mm coats of cement mortar. This will ensure that the vault is waterproof. See Figure 9.

6. Follow steps 17-25 for "Building a Concrete Aqua Privy."



**Technical Notes** are part of a set of "Water for the World" materials produced under contract to the U.S. Agency for International Development by National Demonstration Water Project, Institute for Rural Water, and National Environmental Health Association. Artwork was done by Redwing Art Service. Technical Notes are intended to provide assistance to a broad range of people with field responsibility for village water supply and sanitation projects in the developing nations. For more detail on the purpose, organization and suggestions for use of Technical Notes, see the introductory Note in the series, titled "Using 'Water for the World' Technical Notes." Other parts of the "Water for the World" series include a comprehensive Program Manual and several Policy Perspectives. Further information on these materials may be obtained from the Development Information Center, Agency for International Development, Washington, D.C., 20523, U.S.A.

# Water for the World



## Constructing Bucket Latrines Technical Note No. SAN.1.C.5

A bucket latrine consists of a shelter and a platform which supports a slab and encloses a bucket. Constructing a bucket latrine involves assembling all necessary labor, materials, and tools; building a base and platform from concrete or brick and mortar and installing a sitting or squatting slab and a fly-proof door.

With careful maintenance, a properly constructed bucket latrine can last 10-20 years. This technical note describes each step in constructing a bucket latrine. Read the entire technical note before beginning construction.

### Materials Needed

The project designer must provide three papers before construction can begin:

1. Location map similar to Figure 1.
2. Design drawings similar to Figure 2.
3. Construction materials list similar to Table 1 showing all necessary labor, supplies and tools.

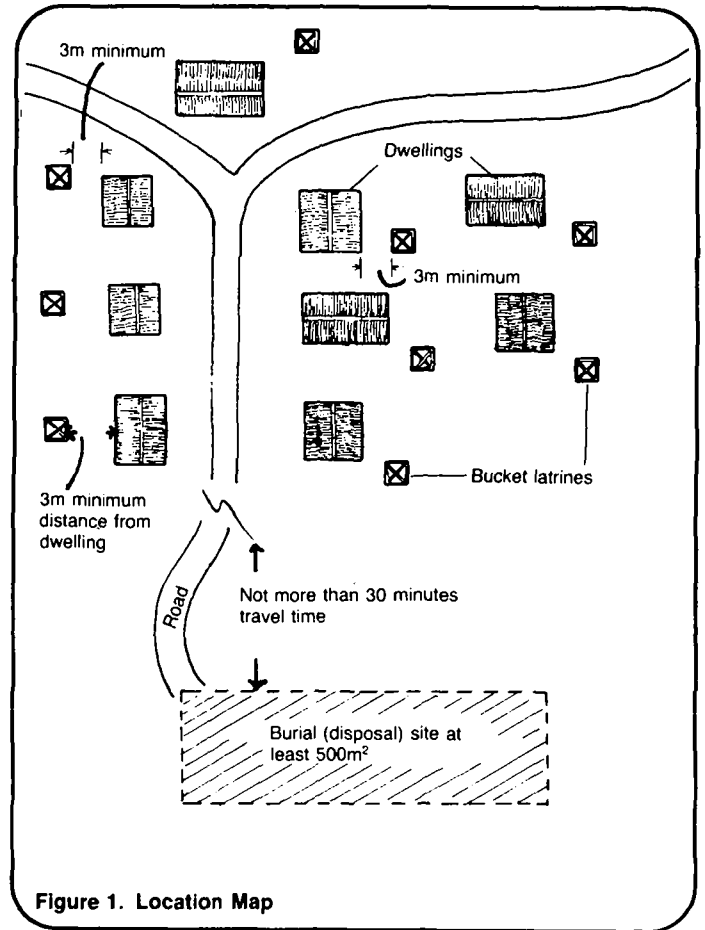


Figure 1. Location Map

For a concrete bucket latrine:

1. Assemble all laborers, materials, tools, and drawings needed to begin construction. Study all drawings carefully.

2. Prepare the site shown on the location map by removing vegetation and rocks and raking the ground smooth. Build forms for the base.

### Construction Steps

Depending on local conditions, availability of materials, and skills of workers, some construction steps will require only a few hours, while others may take a day or more. Read the construction steps and make a rough estimate of the time required for each step. You will then have an idea of when specific workers, materials, and tools must be available during the construction process. Draw up a work plan similar to Table 2 showing construction steps.

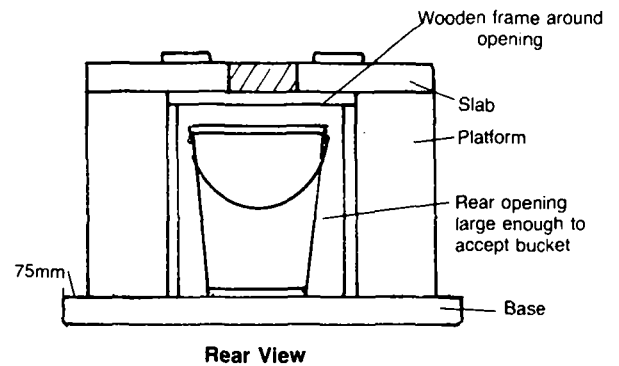
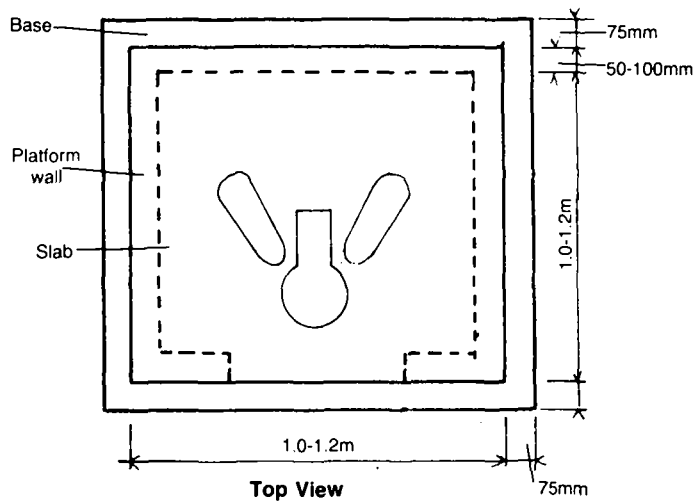
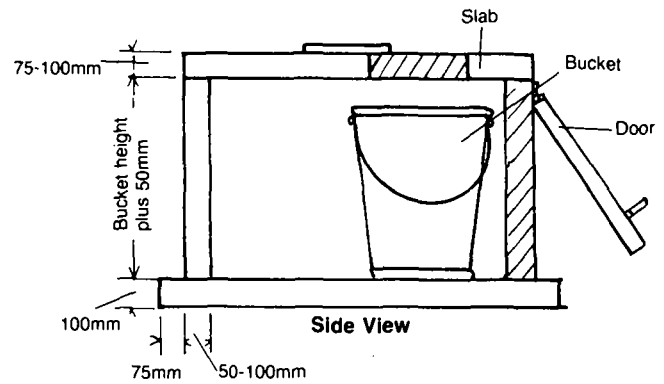
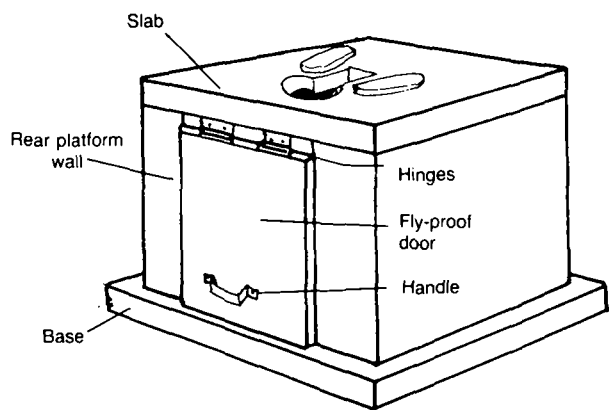


Figure 2. Bucket Latrine

3. Mix concrete to the correct proportions. A common mix by volume is one part cement to two parts sand to three parts gravel and enough water to make a fairly stiff mix. Mix until the sand and gravel are evenly coated with cement and water.

4. Pour in concrete until the base form is about half full, lay in reinforcing material such as steel rods, wire mesh, or bamboo strips, and pour in concrete until the form is full. Smooth the surface with a trowel as shown in Figure 3.

5. Cover the fresh concrete with wet straw, burlap bags, or equivalent and keep moist for three to seven days.

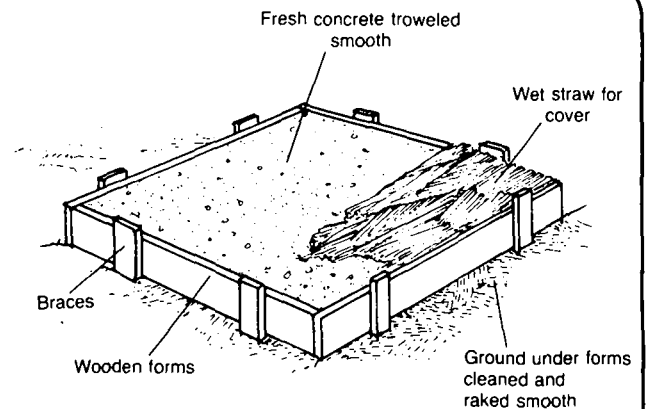


Figure 3. Concrete Base

6. Remove the cover material and forms from the base. Build forms for the platform walls. Make an opening in the rear wall for access to the bucket. Secure the reinforcing material in the forms. Brace the forms as shown in Figure 4 to be certain that they hold together when the concrete is poured.

7. Pour the concrete into the forms. It must completely fill the forms. Use a steel rod or stout stick to work concrete between the reinforcing material and the forms. Smooth the tops of the platform walls with a trowel.

8. Cover the fresh concrete with wet straw, burlap bags, or equivalent and keep moist for three to seven days.

9. Remove the cover and forms from the walls. The form inside the rear wall opening can be left in place and serve as the frame for the fly-proof door. Seal the bottom edges of the walls, inside and outside, with cement mortar made with one part cement to three parts sand and enough water to make a workable mix. See Figure 5.

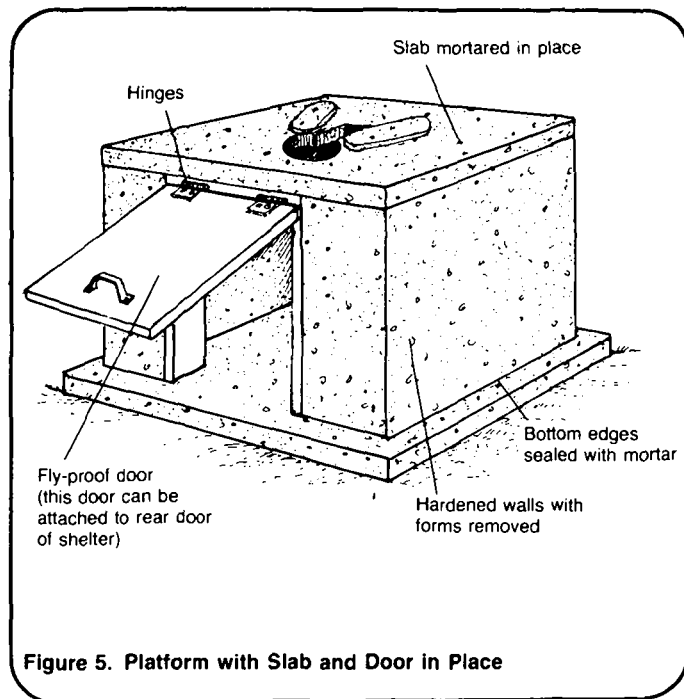


Figure 5. Platform with Slab and Door in Place

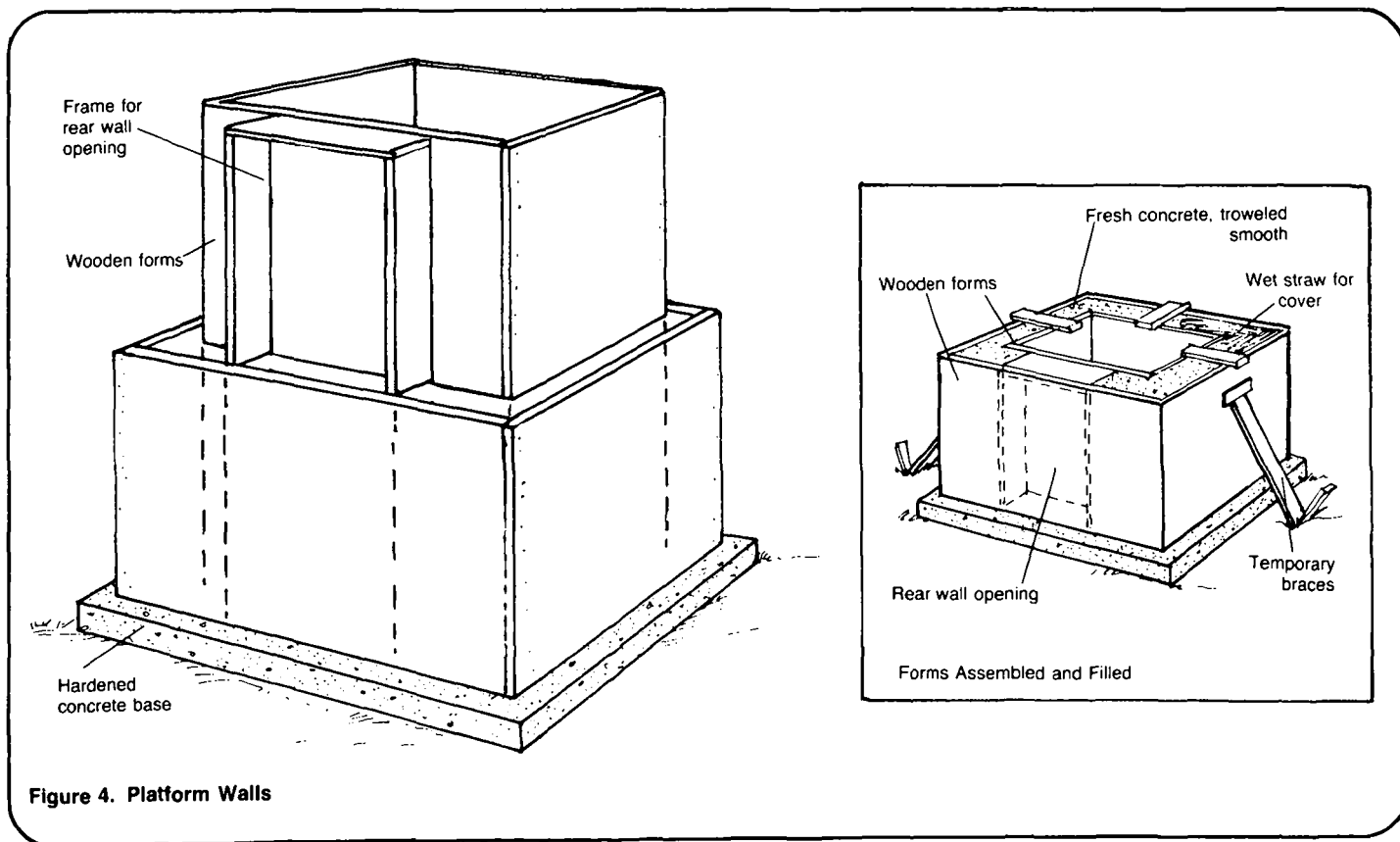


Figure 4. Platform Walls

10. Make forms and cast the slab as described in "Constructing Slabs for Privies," SAN.1.C.1. Mortar the slab in place.

11. Build a fly-proof door from wood or metal and attach it over the rear wall opening with a pair of hinges. The door must fit tightly around all edges, and it should have a handle.

12. Build steps leading up to the latrine. Use bamboo, wood, bricks, or other local material. Be certain each step is no higher than 200mm.

13. Build a shelter as shown in Figure 6. See "Constructing Privy Shelters," SAN.1.C.3.

14. Set a lid over the squatting hole, place a bucket under the slab, and close the fly-proof door.

For a brick and mortar bucket latrine:

1. Assemble all laborers, materials, tools, and drawings needed to begin construction. Study all drawings carefully.

2. Prepare the site shown on the location map by removing vegetation and rocks and raking the ground smooth.

3. Build the base from bricks and mortar. A common mortar mix is one part cement to three parts sand and enough water to make a workable mix.

4. Plaster the top of the base with a 12-25mm thick layer of cement mortar. Smooth with a trowel, cover with wet straw, burlap bags or equivalent, and keep moist for one to three days. See Figure 7.

5. Remove the cover material and begin laying up the platform walls. Build and install a frame of wood or bamboo for the rear wall opening.

6. When the platform walls reach their design height, fill in any openings or holes in the top course of bricks with cement mortar. Allow one to three days for the walls to set. See Figure 8.

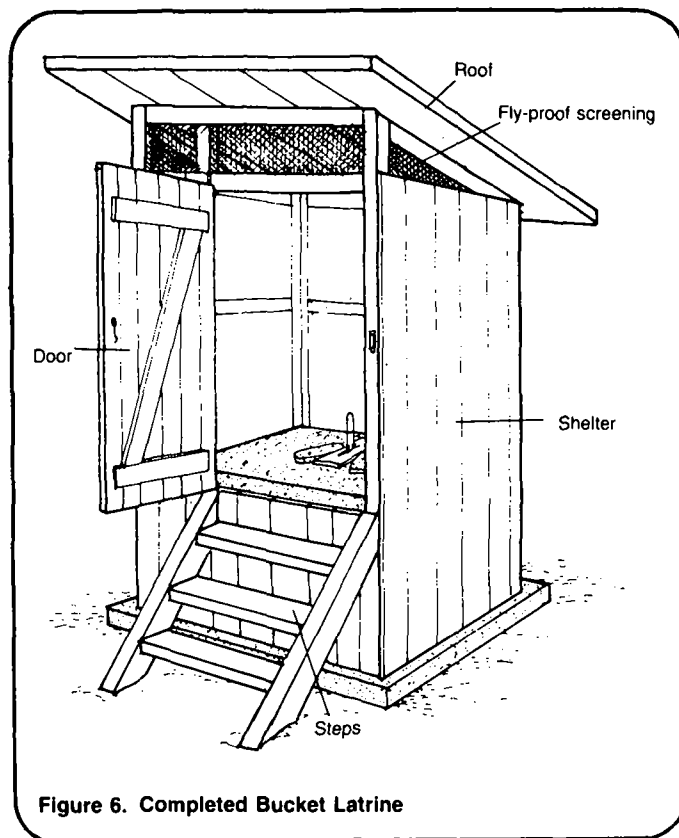


Figure 6. Completed Bucket Latrine

7. Coat the insides of the walls with 12-25mm of cement plaster. Seal the bottom edges of the walls, inside and outside, with cement plaster.

8. Follow steps 10-14 for a concrete bucket latrine.

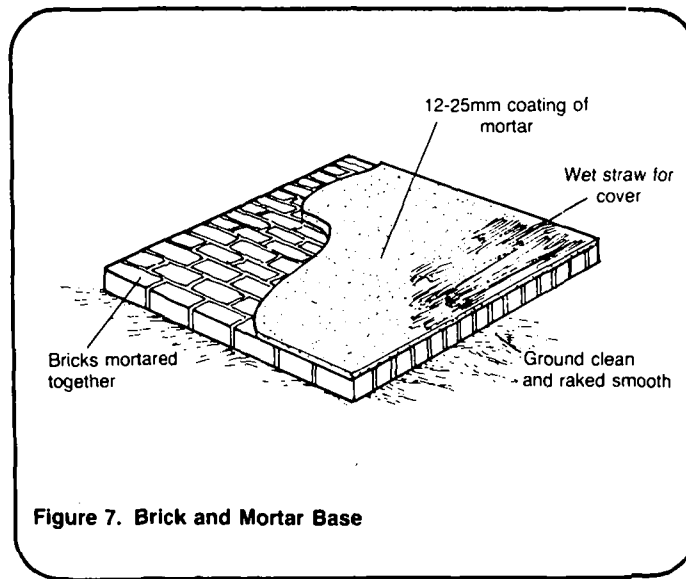


Figure 7. Brick and Mortar Base



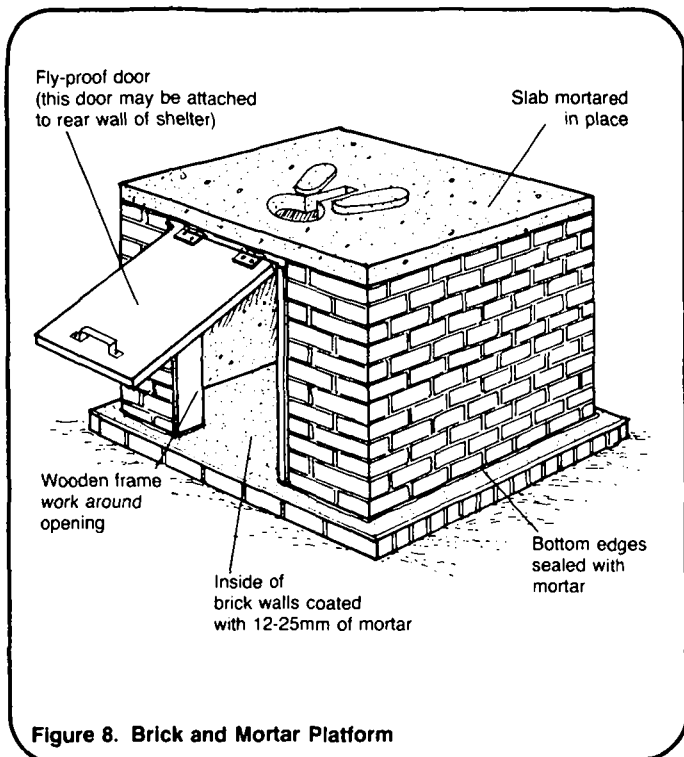


Figure 8. Brick and Mortar Platform

Table 1. Sample Construction Materials List

Item	Description	Quantity	Estimated Cost
Labor	Foreman	1	_____
	Laborer (skilled with concrete)	1	_____
	Laborer (unskilled)	1	_____
Supplies	Wood (for forms and fly-proof door)	_____	_____
	Nails	_____	_____
	Cement (Portland)	_____	_____
	Sand (clean, sized fine to 6mm)	_____	_____
	Gravel (clean, sized 6-25mm)	_____	_____
	Water (clear)	_____	_____
	Reinforcing material	_____	_____
	Squatting slab	_____	_____
	Tin sheet (for fly-proof door)	_____	_____
	Hinges (for fly-proof door)	_____	_____
	Handle (for fly-proof door)	_____	_____
	Materials for shelter (see SAN.1.D.3)	_____	_____
Buckets	_____	_____	
Other	_____	_____	
Tools	Measuring tape	1	_____
	Hammer	1	_____
	Saw	1	_____
	Shovel	1	_____
	Trowel	1	_____
	Container for mixing concrete	1	_____
	Other	_____	_____

Total Estimated Cost = \_\_\_\_\_

**Table 2. Sample Work Plan**

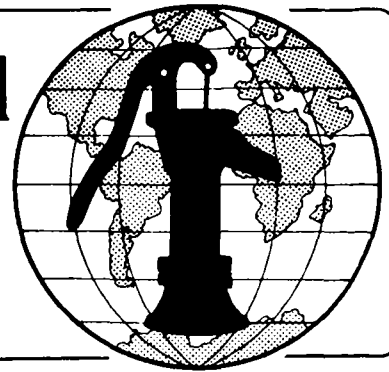
Time Estimate	Day	Task	Personnel	Materials/Tools
1 hour	1	Prepare site	Foreman; worker	Location map, measuring tape, design drawings, rake
1 hour	1	Build forms for base	Foreman; worker	Wood, nails, hammer, saw
1 hour	1	Mix concrete	Foreman, 2 workers (one skilled with concrete)	Wheelbarrow, 2 shovels, hoe, cement, sand, gravel, water
2 hours	1	Pour concrete into forms; smooth surface; cover	Foreman, 2 workers (one skilled with concrete)	Reinforcing material, trowel, wet straw
----	2-5	Keep moist	----	----
1 hour	6	Remove cover material and forms	Foreman; worker	2 hammers
3 hours	6	Build forms for platform walls	Foreman; 2 workers (one skilled with concrete)	Wood, nails, hammer, saw, 2 sections of vent pipe
1 hour	6	Mix concrete	Foreman; 2 workers (one skilled with concrete)	Wheelbarrow, 2 shovels, hoe, cement, sand, gravel, water
2 hours	6	Pour concrete into forms; smooth surface; cover	Foreman; 2 workers (one skilled with concrete)	Reinforcing material, trowel, wet straw
----	7-10	Keep moist	----	----
1 hour	11	Remove cover material and forms	Foreman; worker	2 hammers
2 hours	11	Seal bottom edges of walls with mortar	Foreman; 2 workers (one skilled with concrete)	Wheelbarrow, 2 shovels, trowel, cement, sand, water
2 hours	11	Mortar slab in place	Foreman; 2 workers (one skilled with concrete)	Wheelbarrow, 2 shovels, trowel, cement, sand, water, 2 squatting slabs
1 hour	11	Build and install fly-proof door	Foreman; worker	Wood, tin sheet, hinges, handle
3 hours	11	Build steps	Foreman; 2 workers	Wood, hammer, saw, nails
----	12-13	Build privy shelter	Foreman; 2 workers	See "Constructing Privy Shelters," SAN.1.C.3 for details

## Notes

## Notes

**Technical Notes** are part of a set of "Water for the World" materials produced under contract to the U.S. Agency for International Development by National Demonstration Water Project, Institute for Rural Water, and National Environmental Health Association. Artwork was done by Redwing Art Service. Technical Notes are intended to provide assistance to a broad range of people with field responsibility for village water supply and sanitation projects in the developing nations. For more detail on the purpose, organization and suggestions for use of Technical Notes, see the introductory Note in the series, titled "Using 'Water for the World' Technical Notes." Other parts of the "Water for the World" series include a comprehensive Program Manual and several Policy Perspectives. Further information on these materials may be obtained from the Development Information Center, Agency for International Development, Washington, D.C., 20523, U.S.A.

# Water for the World



## Constructing Compost Toilets Technical Note No. SAN. 1.C.6

A compost toilet consists of a pair of waterproof vaults that receive excreta, ashes, sawdust, straw, and grass. Each vault is equipped with a slab for defecating, a rear opening for removing compost, and a hole for a vent pipe. Constructing a compost toilet involves assembling all necessary labor, materials, and tools; building a base and double vault from concrete or brick and mortar; and installing vent pipes, covers for the rear openings, and a pair of slabs.

With careful maintenance, a properly constructed compost toilet can last 10-20 years or more. This technical note describes each step in constructing a compost toilet. Read the entire technical note before beginning construction.

### Useful Definition

**COMPOST** - A dark, fairly dry, crumbly, odorless material that is produced by sealing excreta, ashes, woodchips, straw, and vegetable wastes for 6-12 months in the vault of a compost toilet. Compost can be used to fertilize crops.

### Materials Needed

The project designer must provide three papers before construction can begin:

1. A location map similar to Figure 1.
2. Design drawings similar to Figure 2.
3. A detailed materials list similar to Table 1, showing all necessary labor, supplies, and tools.

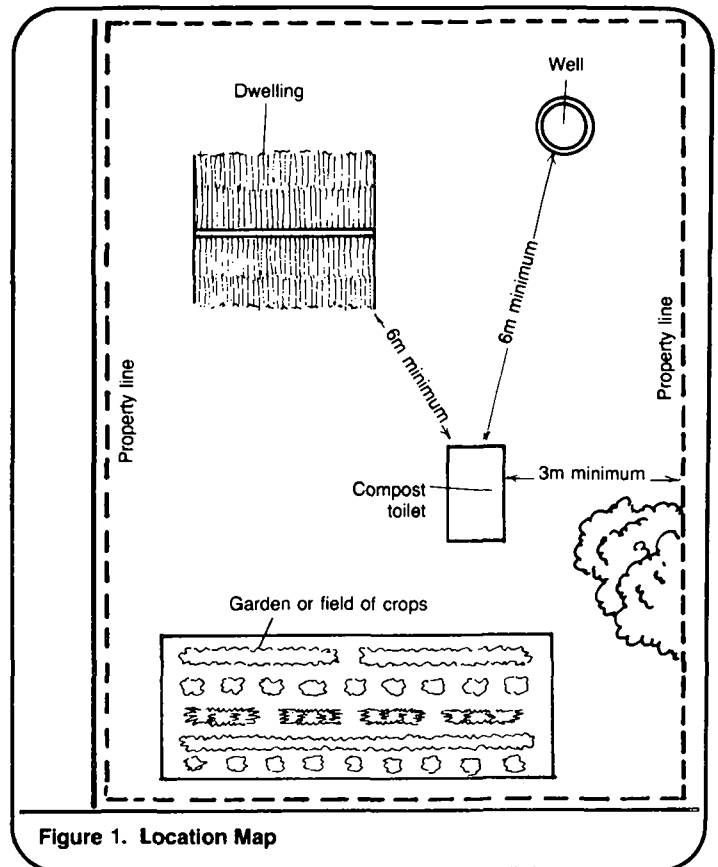


Figure 1. Location Map

### Construction Steps

Depending on local conditions, availability of materials, and skills of workers, some construction steps will require only a few hours, while others may take a day or more. Read the construction steps and make a rough estimate of the time required for each step. Draw up a work plan similar to the sample shown in Table 2. You will then have an idea of when specific laborers, materials, and tools must be available during the construction process.

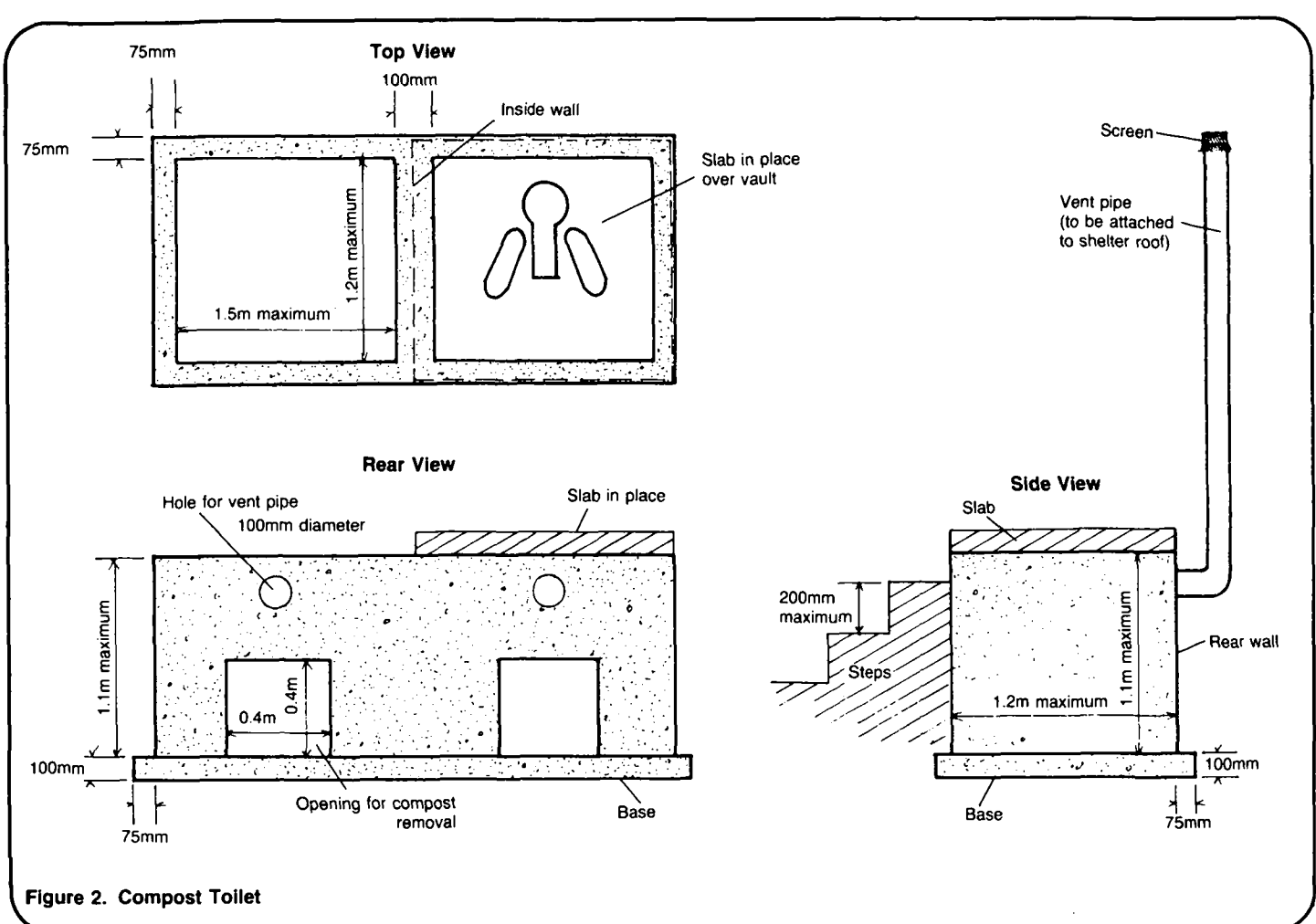


Figure 2. Compost Toilet

Table 1. Sample Materials List

Item	Description	Quantity	Estimated Cost
Labor	Foreman	1	—
	Laborer (skilled with concrete)	1	—
	Laborer (unskilled)	1	—
Supplies	Wood (for forms)	—	—
	Nails (for forms)	—	—
	Cement (Portland)	—	—
	Sand (clean, sized fine to 6mm)	—	—
	Gravel (clean, sized 6-25mm)	—	—
	Water (clear)	—	—
	Reinforcing material	—	—
	Squatting slabs	—	—
	Vent pipes (with screens)	—	—
	Tin sheets (to cover rear wall openings)	—	—
Other	—	—	
Tools	Measuring tape	1	—
	Hammer	1	—
	Saw	1	—
	Shovels	2	—
	Trowel	1	—
	Container for mixing concrete	2	—
	Carpenter's level or equivalent (optional)	1	—
	Carpenter's square or equivalent (optional)	1	—
	Tar or equivalent (for sealing covers over rear openings)	—	—
	Other	—	—

Total Estimated Cost = —

For a concrete compost toilet:

1. Assemble all laborers, materials, tools, and drawings needed to begin construction. Study all drawings carefully.

2. Prepare the site shown on the location map by removing vegetation and rocks and raking the ground smooth. Build forms for the base. See Figure 3.

3. Mix the concrete to the correct proportions. A common mix by volume is one part cement to two parts sand to three parts gravel and enough water to make a fairly stiff mix. Mix until sand and gravel are evenly coated with cement and water.

**Table 2. Sample Work Plan for Building a Concrete Compost Toilet**

Time Estimate	Day	Task	Personnel	Tools and Materials
1 hour	1	Prepare site	Foreman; worker	Location map, measuring tape, design drawings, rake
1 hour	1	Build forms for base	Foreman; worker	Wood, nails, hammer, saw
1 hour	1	Mix concrete	Foreman; 2 workers (one skilled with concrete)	Wheelbarrow, 2 shovels, hoe, cement, sand, gravel, water
2 hours	1	Pour concrete into forms; smooth surface; cover	Foreman; 2 workers (one skilled with concrete)	Reinforcing material, trowel, wet straw
----	2-5	Keep moist	----	----
1 hour	6	Remove cover material and forms	Foreman; worker	2 hammers
3 hours	6	Build forms for walls	Foreman; 2 workers (one skilled with concrete)	Wood, nails, hammer, saw, 2 sections of vent pipe
1 hour	6	Mix concrete	Foreman; 2 workers (one skilled with concrete)	Wheelbarrow, 2 shovels, hoe, cement, sand, gravel, water
2 hours	6	Pour concrete into forms; smooth surface; cover	Foreman; 2 workers (one skilled with concrete)	Reinforcing material, trowel, wet straw
----	7-10	Keep moist	----	----
1 hour	11	Remove cover material and forms	Foreman; worker	2 hammers
2 hours	11	Seal bottom edges of walls with mortar	Foreman; 2 workers (one skilled with concrete)	Wheelbarrow, 2 shovels, trowel, cement, sand, water
2 hours	11	Mortar slabs in place	Foreman; 2 workers (one skilled with concrete)	Wheelbarrow, 2 shovels, trowel, cement, sand, water, 2 squatting slabs
1 hour	11	Cover openings in rear wall	Foreman; worker	Tin sheets, tar
3 hours	11	Build steps	Foreman; 2 workers	Wood, hammer, saw, nails
----	12-13	Build privy shelter	Foreman; 2 workers	See "Constructing Privy Shelters," SAN.1.C.3. for details
2 hours	14	Install vent pipes	Foreman; 2 workers	100mm diameter galvanized metal pipe, metal bands, fly-proof screen
½ hour	14	Cover one squatting slab hole	Foreman; worker	Tin sheet, heavy rock

4. Pour in concrete until the forms are about half full, lay in reinforcing material (steel rods, wire mesh, bamboo strips, or equivalent), and pour in concrete until the forms are full. Smooth the surface with a trowel.

5. Cover the fresh concrete with wet straw, burlap bags, or equivalent and keep moist for three to seven days. See Figure 3.

6. Remove the cover material and forms from the base. Build forms for the vault walls. Build an opening in the rear wall of each vault for compost removal. Set a section of vent pipe into the rear forms for installation of the vents. Secure reinforcing material in place inside the forms. Brace the forms to be certain that they hold together when the concrete is poured. See Figure 4.

7. Pour concrete into the wall forms. The concrete must completely fill the forms. Use a steel rod or stout stick to work concrete between the reinforcing materials and the forms. Smooth the tops of the walls with a trowel. See Figure 5a.

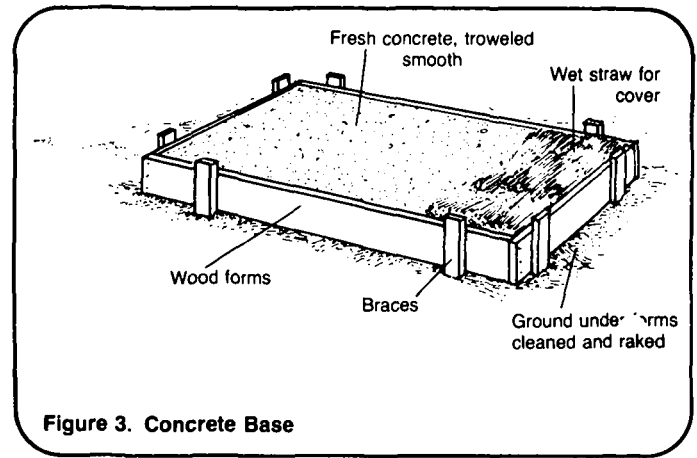


Figure 3. Concrete Base

8. Cover the fresh concrete with wet straw, burlap bags, or equivalent and keep moist for three to seven days.

9. Remove the cover material and forms from the walls. Seal the bottom edges of the walls, inside and outside, with cement mortar made with one part cement to three parts sand and enough water to make a workable mix.

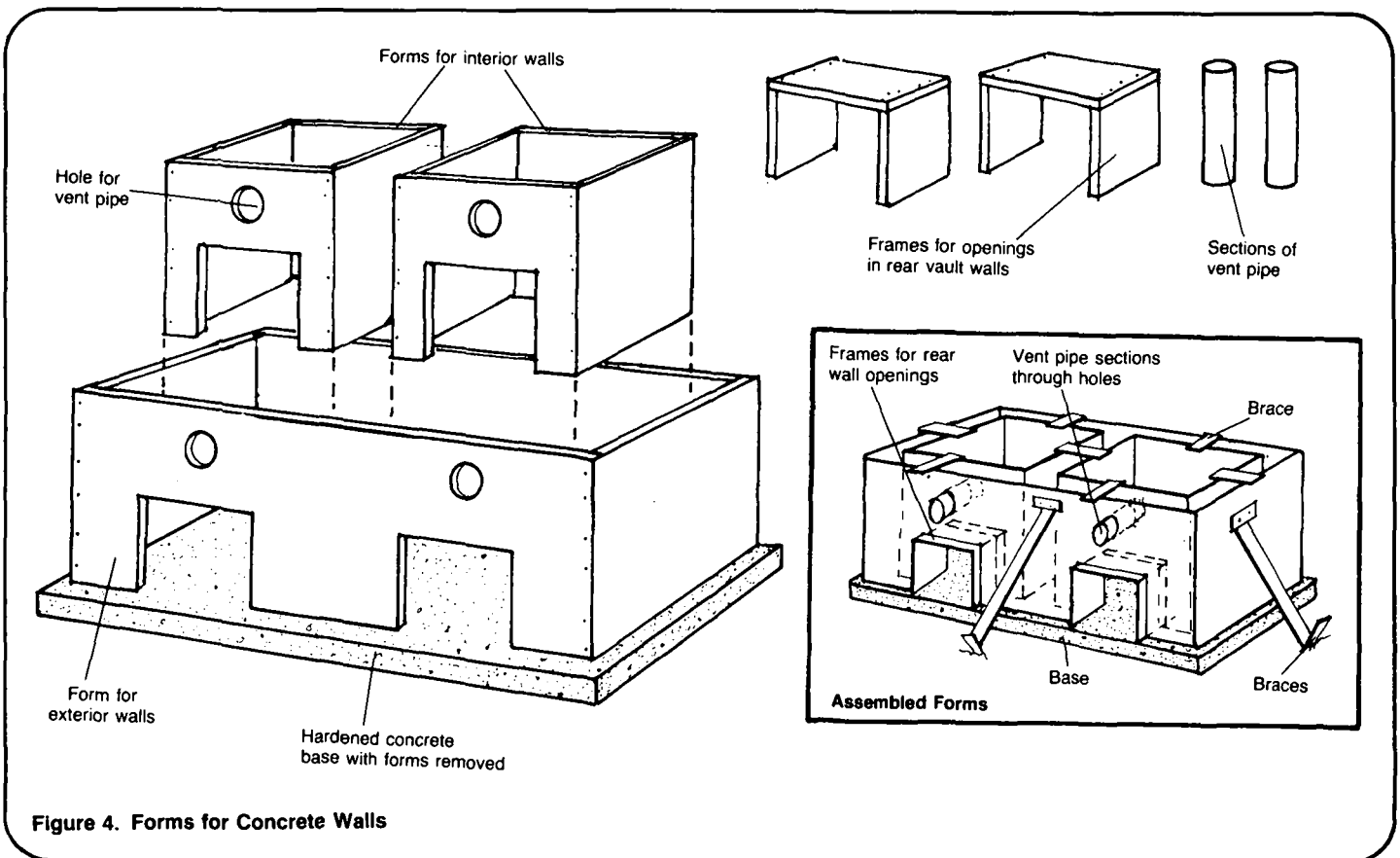
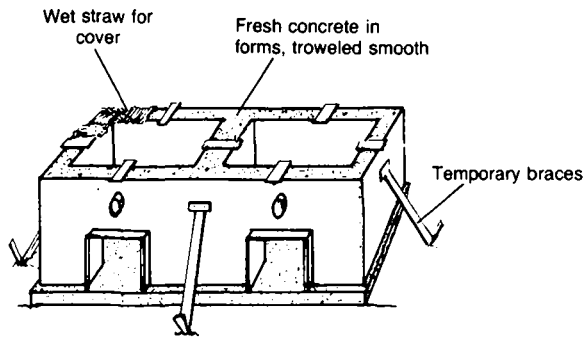
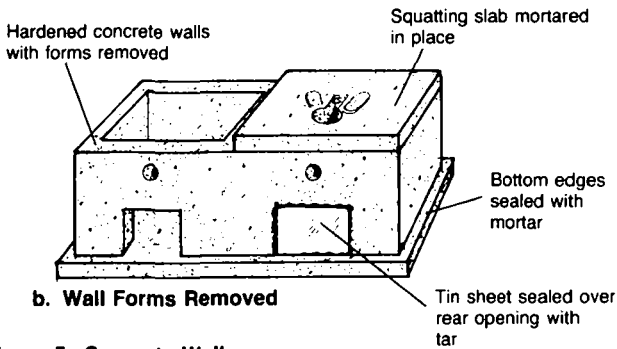


Figure 4. Forms for Concrete Walls





a. Concrete Poured into Forms



b. Wall Forms Removed

Figure 5. Concrete Walls

10. Cover the rear openings and seal with tar or equivalent. Be sure that the cover is several inches larger than the opening and that the opening is flush on all sides. This will help ensure the tar seal is strong enough to hold the weight of the accumulating compost. Do not use cement to seal the covers because eventually they will have to be removed. The covers may also need to be braced.

11. Mortar the squatting or sitting slabs in place. See Figure 5b.

12. Build steps leading up to the toilet. Use bamboo, wood, bricks, or other local material. Be certain each step is no higher than 200mm.

13. Build a shelter, see "Constructing Privy Shelters," SAN.1.C.3.

14. Install the vent pipes and secure them to the rear wall or roof of the shelter. See Figure 6.

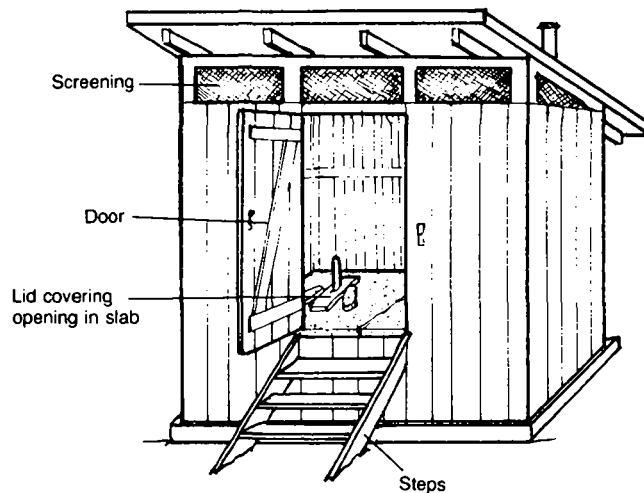
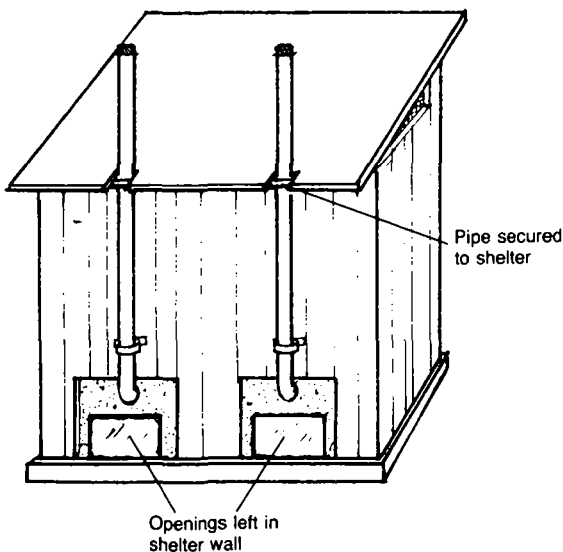


Figure 6. Completed Compost Toilet

15. Build a heavy lid to cover one squatting slab hole to prevent its use until the proper time. The lid can be concrete, or it can be wood or metal with a heavy rock on top. Set the lid in place.

For a brick and mortar compost toilet:

1. Assemble all laborers, materials, tools, and drawings needed to begin construction. Study all drawings carefully.

2. Prepare the site shown on the location map by removing vegetation and rocks and raking the ground smooth.

3. Build the base from bricks and mortar. A common mortar mix is one part cement to three parts sand and enough water to make a workable mix.

4. Plaster the top of the base with a 12-25mm thick layer of cement mortar. Smooth with a trowel, cover with wet straw, burlap bags or equivalent, and keep moist for one to three days. See Figure 7.

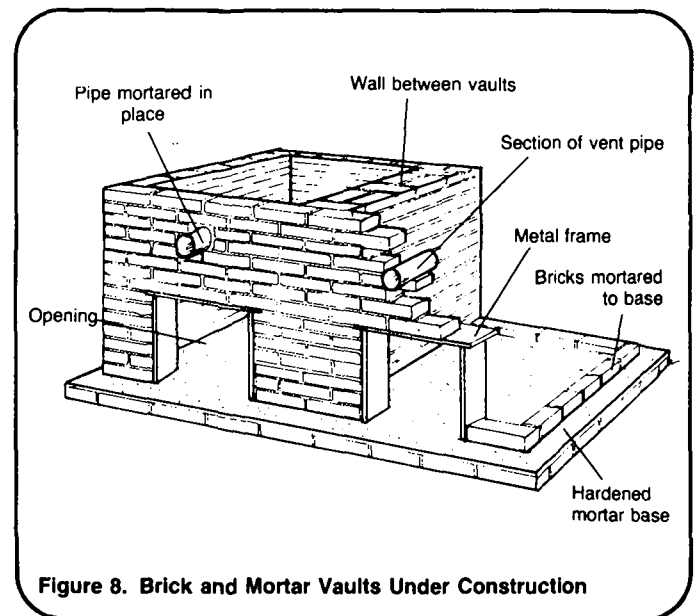
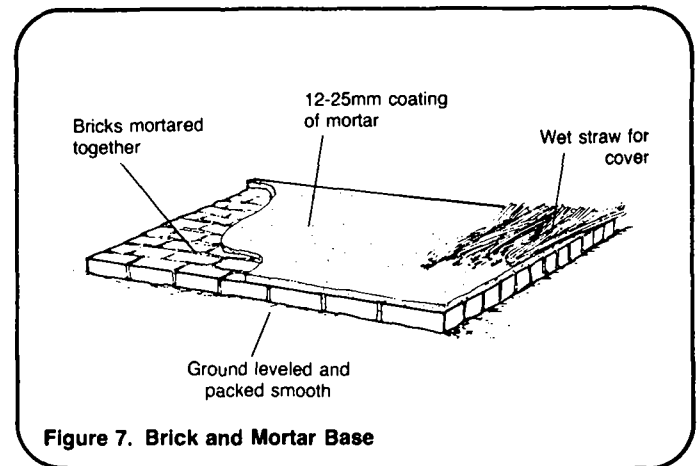
5. Remove the cover material and begin laying up the walls, including the wall between the vaults. Build and install frames for the rear wall openings. Rust-proof metal is the best frame material, but wood, bamboo, or other local material can be used. See Figure 8.

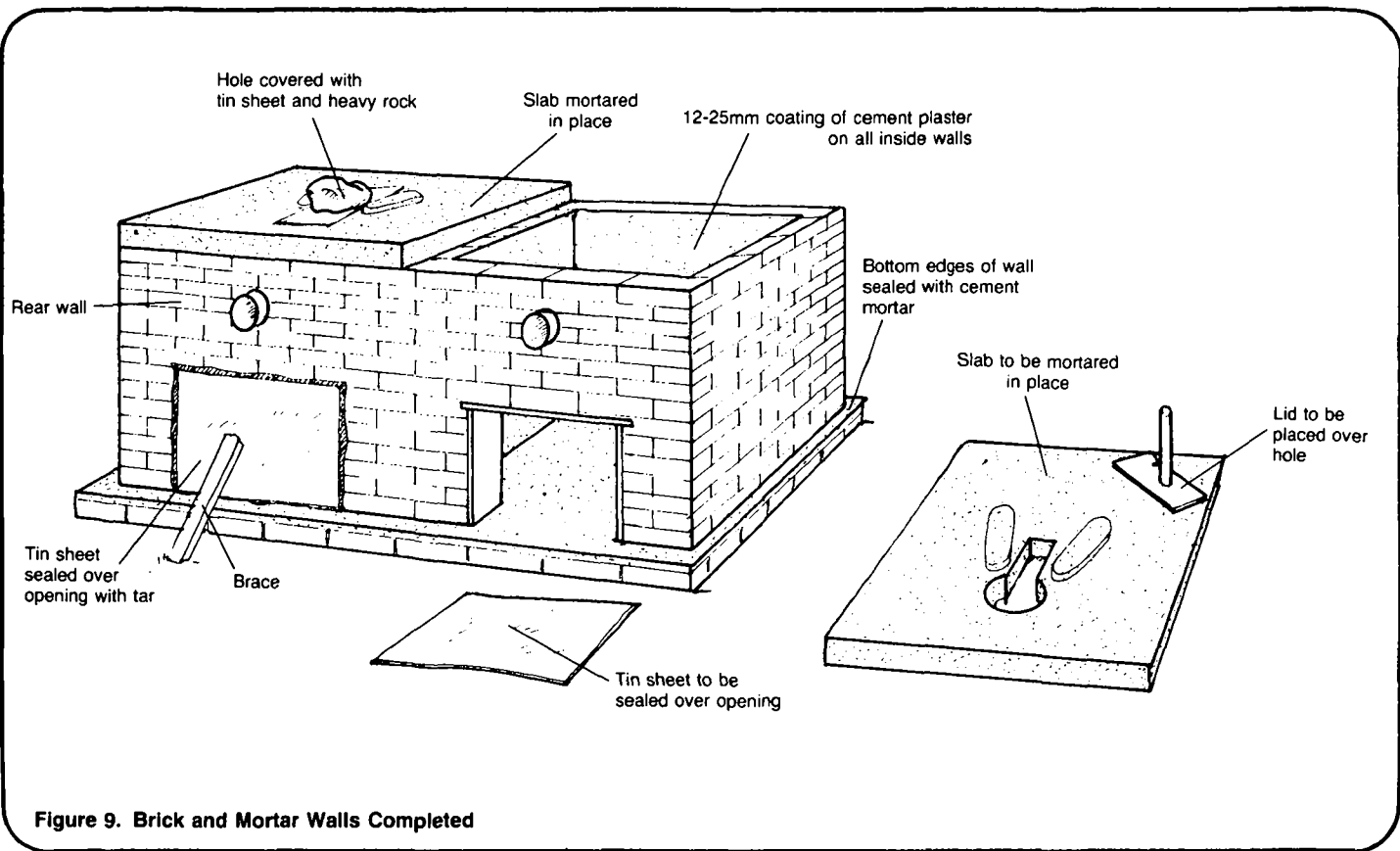
6. When the walls are 200-300mm short of their designed height, mortar sections of the vent pipe in place, lay bricks around the sections, and continue laying up the walls to their designed height. See Figure 8.

7. Fill in any holes or openings in the top course of bricks with cement mortar. Allow one to three days for the walls to set.

8. Coat the insides of the walls with 12-25mm of cement plaster. Seal the bottom edges of the walls, inside and outside, with cement plaster. See Figure 9.

9. Follow steps 11-15 for a concrete compost toilet. See Figure 6.



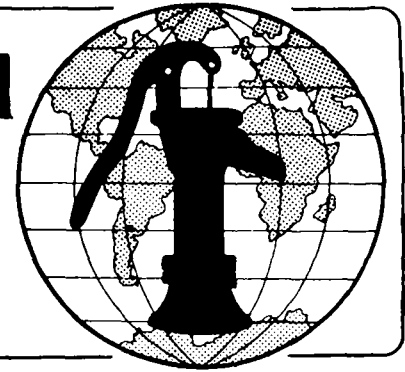


**Figure 9. Brick and Mortar Walls Completed**

## Notes

**Technical Notes** are part of a set of "Water for the World" materials produced under contract to the U.S. Agency for International Development by National Demonstration Water Project, Institute for Rural Water, and National Environmental Health Association. Artwork was done by Redwing Art Service. Technical Notes are intended to provide assistance to a broad range of people with field responsibility for village water supply and sanitation projects in the developing nations. For more detail on the purpose, organization and suggestions for use of Technical Notes, see the introductory Note in the series, titled "Using 'Water for the World' Technical Notes." Other parts of the "Water for the World" series include a comprehensive Program Manual and several Policy Perspectives. Further information on these materials may be obtained from the Development Information Center, Agency for International Development, Washington, D.C., 20523, U.S.A.

# Water for the World



## Constructing, Operating and Maintaining Sumps, Soakage Pits, and Soakage Trenches

Technical Note No. SAN. 1.C.7.

Sumps, soakage pits, and soakage trenches receive washwater or effluent from an aqua privy and allow it to soak safely into the ground. Constructing these disposal systems involves digging a sump, pit, or trench; lining it with bricks or stones or filling it with gravel or rocks; and, in the case of a soakage pit or trench, laying a pipe from the dwelling or aqua privy to the pit or trench. These systems are operated by pouring washwater into a sump, a sink or drain in the dwelling, or an aqua privy. They must be inspected periodically and any problems corrected.

Properly constructed sumps can last 1 to 5 years, and soakage pits and soakage trenches 5 to 15 years. This technical note describes each step in constructing, operating, and maintaining simple washwater disposal systems. Read the entire technical note before beginning construction.

### Useful Definitions

**EFFLUENT** - Settled sewage.

**WASHWATER** - Water that has been used for bathing, washing clothes, dishes or kitchen utensils.

### Materials Needed

The project designer must provide three items before construction can begin:

1. Location map, similar to Figure 1, showing the correct location of the washwater disposal system.

2. Technical drawings, similar to one or more of Figures 2, 3, 4, and 5, showing the correct dimensions of the system.

3. Materials list, similar to Table 1, showing all labor supplies, and tools needed to construct the system. In addition, you will need all labor, supplies and tools in the materials list.

### Caution!

1. When digging a pit more than 1.5m deep, shore up the sides to prevent a cave-in that could be fatal to a worker in the pit.

2. Construct the washwater disposal system at the exact site and to the dimensions specified by the project designer.

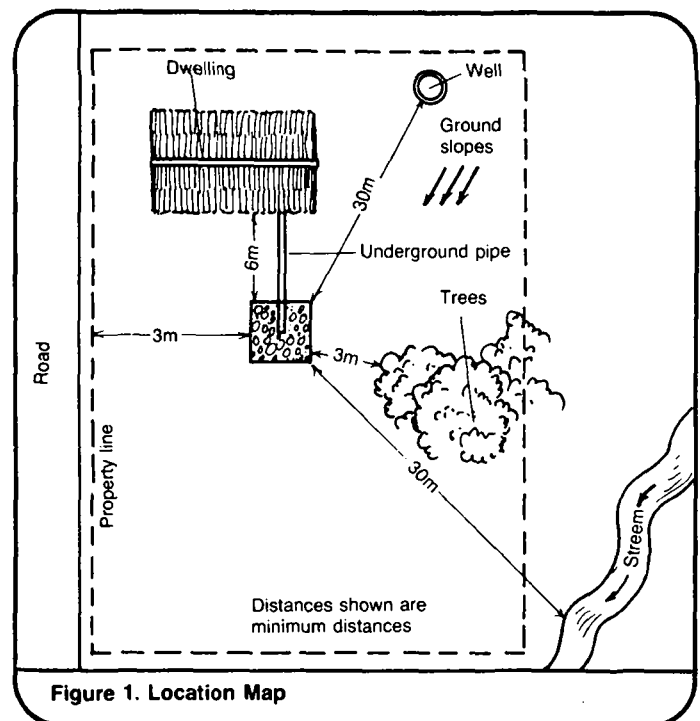


Figure 1. Location Map

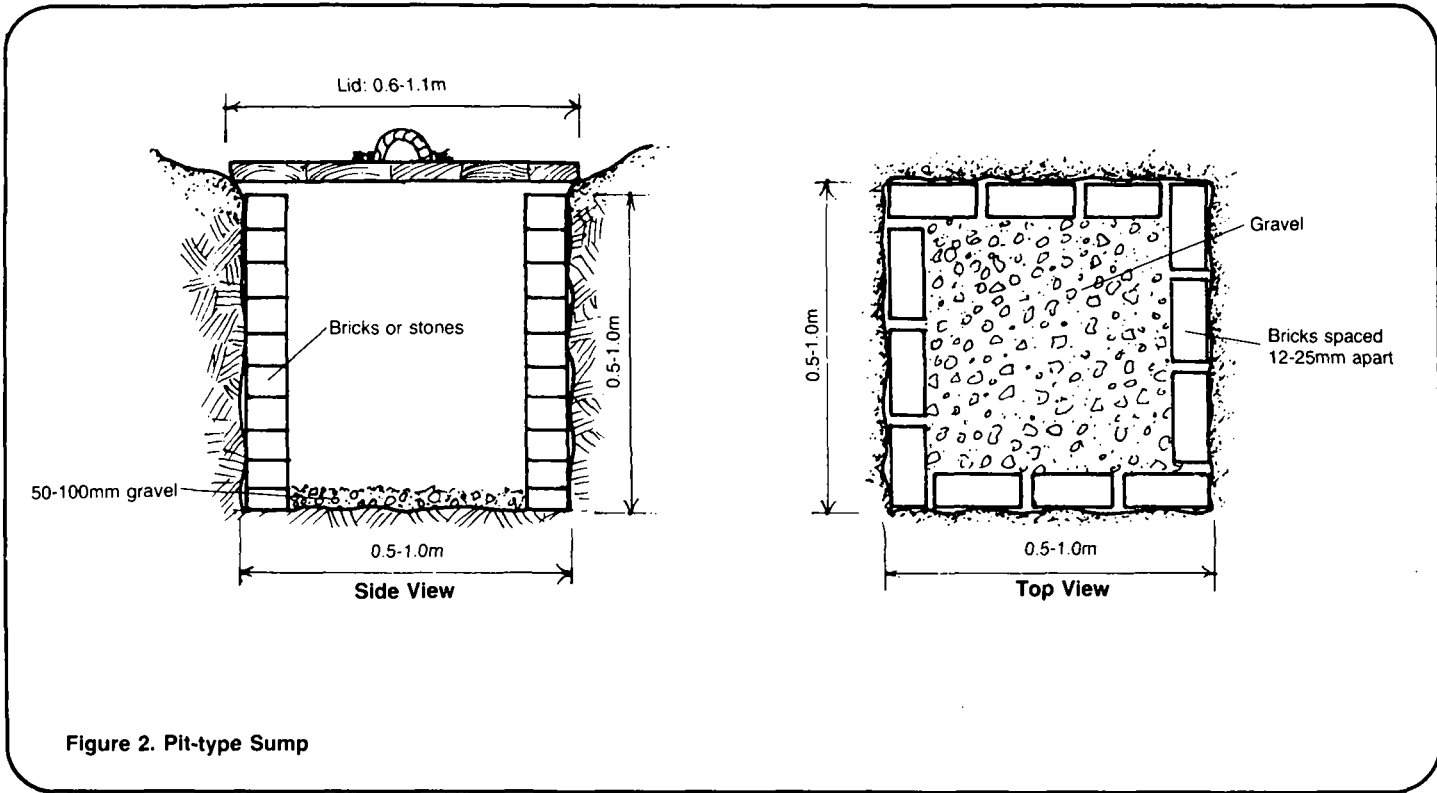


Figure 2. Pit-type Sump

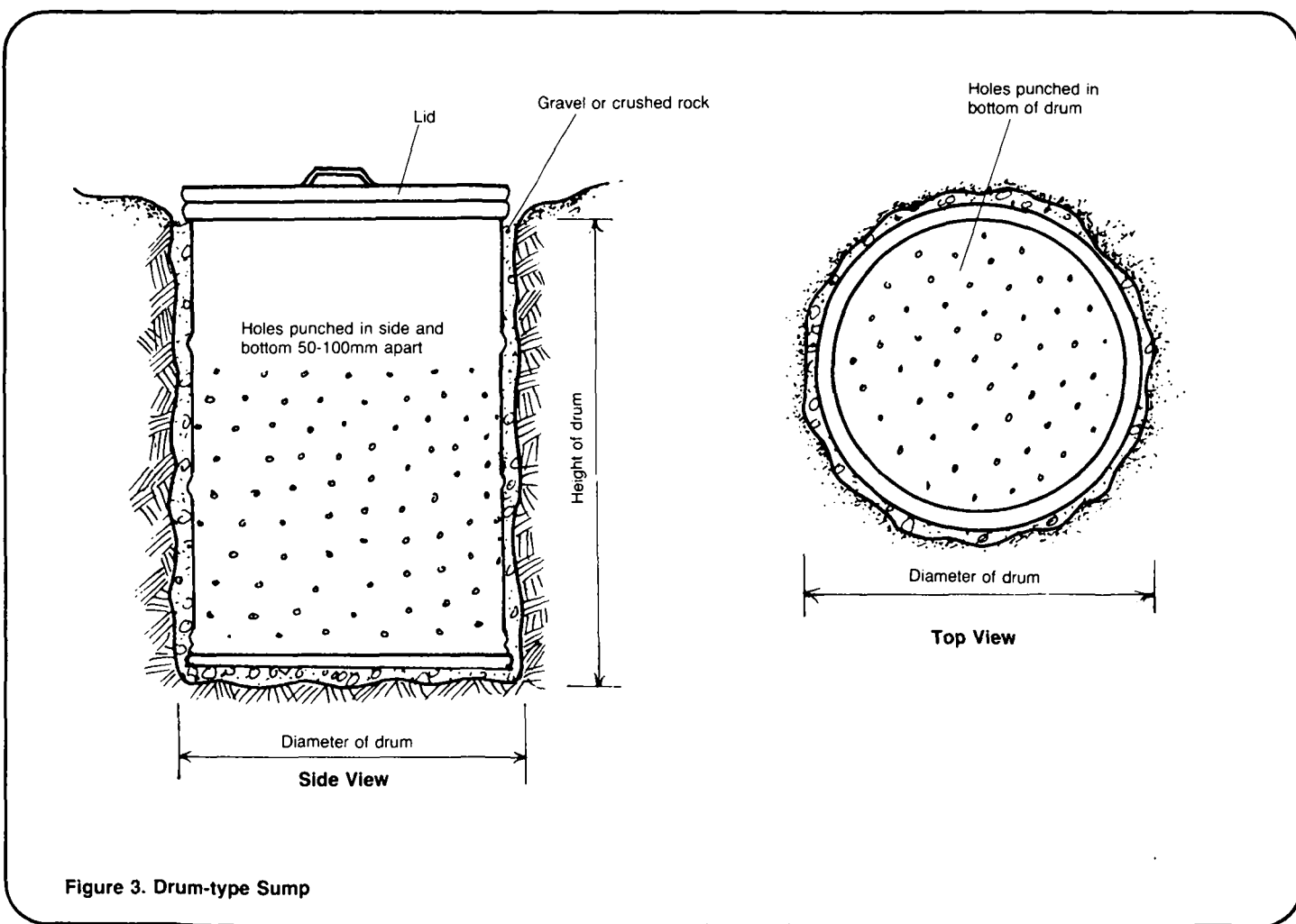


Figure 3. Drum-type Sump

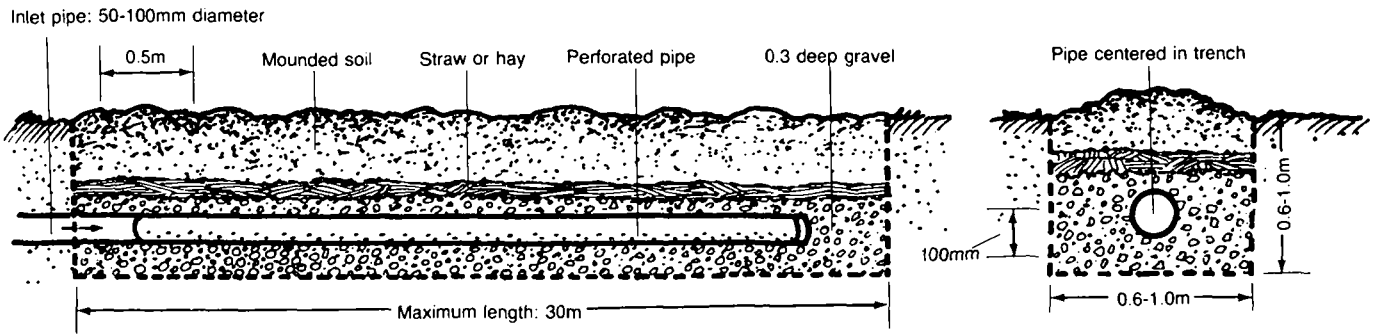


Figure 4. Soakage Trench

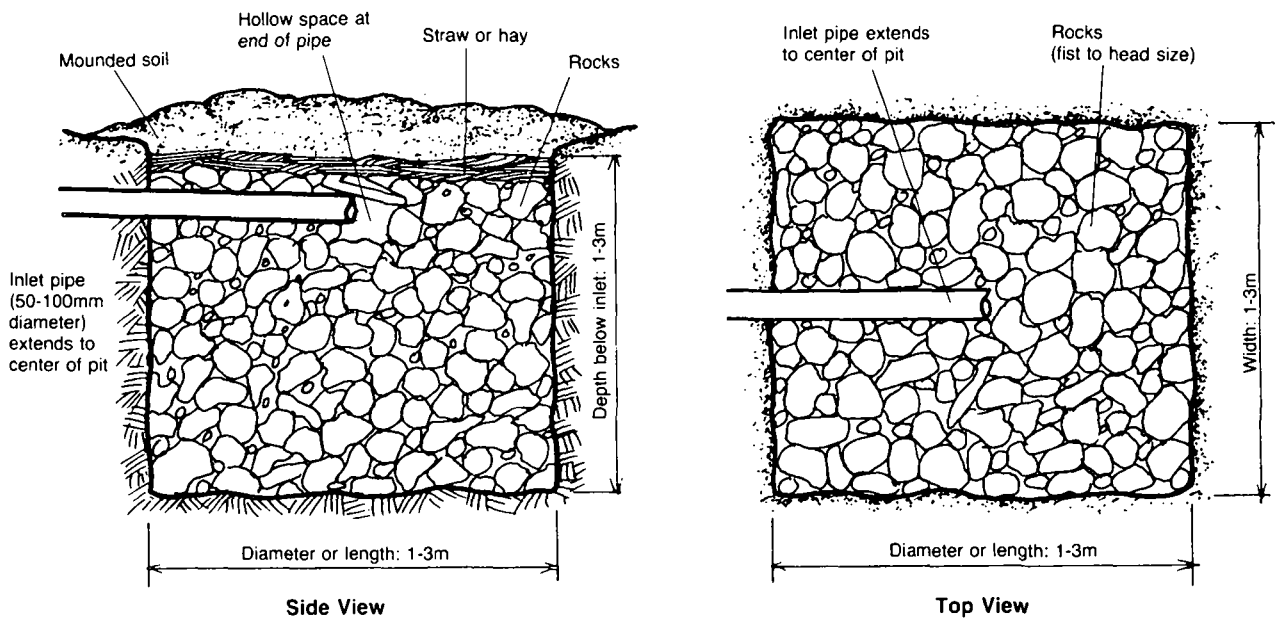


Figure 5. Soakage Pit

## Construction Steps

Depending on local conditions, availability of materials, skills of workers, and so on, some construction steps will take only a few hours, while others may take a day or more. Table 2 shows a sample work plan for building a privy shelter including time estimates for each step. Draw up a similar work plan with rough time estimates for each step based on local conditions. You will then have an idea of when specific workers, supplies, and tools must be available during the construction process.

For a pit-type sump:

1. Assemble all laborers, supplies, tools, and drawings needed to begin construction. Study all diagrams carefully.

2. Use the location map and a measuring tape to lay out the dimensions of the sump on the ground.

3. Dig the hole to the depth specified by the project designer. Make the bottom of the hole fairly level.

4. Lightly rake the sides of the hole with a rake, shovel, or branches. This will allow washwater to soak in quicker.

5. Line the sides of the hole with concrete blocks, bricks, or stones as shown in Figure 6. Leave spaces of 25-50mm between the bricks.

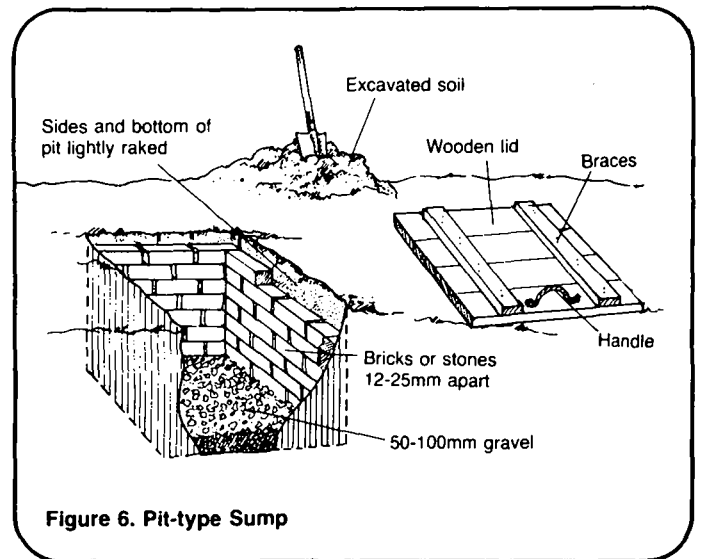


Table 1. Sample Materials List for Washwater Disposal System

Item	Description	Quantity	Estimated Cost
Labor	Foreman	1	_____
	Laborers	2	_____
Supplies	Gravel or pebbles (enough to fill trench to a depth of 0.3m)	_____ m <sup>3</sup>	_____
	Straw (enough to cover entire trench)	_____	_____
	Galvanized metal pipe, 100mm diameter, extends from dwelling to trench	_____ m	_____
	Open-jointed pipe (length of trench)	_____ m	_____
Tools	Measuring tape	1	_____
	Shovels	2	_____
	Wheelbarrow	1	_____
	Other	_____	_____

Total Estimated Cost = \_\_\_\_\_



**Table 2. Sample Work Plan for Soakage Trench**

Time Estimate	Day	Task	Personnel	Tools/Materials
2 hours	1	Lay out system on ground	Foreman (present during all construction) One laborer	Measuring tape
2 hours	1	Excavate trench for pipeline	Two laborers	Shovels
2 hours	1	Lay pipeline	Two laborers	100mm diameter pipe; mortar
1 hour	1	Cover pipe with soil; test flow	Two laborers	Shovels
8 hours	2	Excavate soakage trench	Two or more laborers	Shovels
½ hour	3	Rake bottom and sides of trench	Two laborers	Rakes
2 hours	3	Spread gravel 150mm deep	Two laborers	Gravel, shovels, wheelbarrow
2 hours	3	Extend pipeline 0.5m; lay perforated distribution pipe	Two laborers	100mm diameter distribution pipe; mortar
2 hours	3	Spread gravel 50mm over top of pipe	Two laborers	Gravel; shovels
½ hour	3	Spread straw over gravel	Two laborers	Straw; rakes
1½ hours	3	Cover with soil, mound, lightly tamp	Two laborers	Shovels
2 hours	17	Plant grass over system	Two laborers	Grass seed; rakes

6. Lightly rake the bottom of the hole. Do not stand in the hole after this step or the bottom may become compacted and prevent washwater from soaking in readily.

7. Spread 50-100mm of gravel or small pebbles on the bottom of the hole.

8. Build a lid with wood or metal and cover the hole. The lid should be strong enough to prevent a person from falling through and it should keep out rain. A large rock may be placed on the lid to stop children from removing it. You may also surround the sump with a low mounded ring of soil to prevent surface water from flowing in.

For a drum-type sump:

1. Assemble all laborers, supplies, tools, and drawings needed to begin construction. Study all diagrams carefully.

2. Use the location map and a measuring tape to lay out the site for the sump.

3. Use a hammer and spike or large nail to punch holes in the bottom and the lower half of the sides of a 200-liter steel drum as shown in Figure 7. The inside edges of the holes may be jagged and sharp. Be careful to avoid cuts.

4. Dig a hole at the site just large enough to hold the drum.

5. Lightly rake the sides and bottom of the hole with a rake, shovel, or branches to allow washwater to soak in quicker. Do not stand in the hole after this step because the bottom may become compacted.

6. Lower the drum into the hole.

7. Fill in the space between the drum and the hole with gravel, pebbles, or small rocks, as shown in Figure 7.

8. Cover the drum with a lid. The lid should be strong enough to prevent a person from falling through and it should be waterproof to keep out rain. A large rock may be placed on the lid to stop children from removing it. You

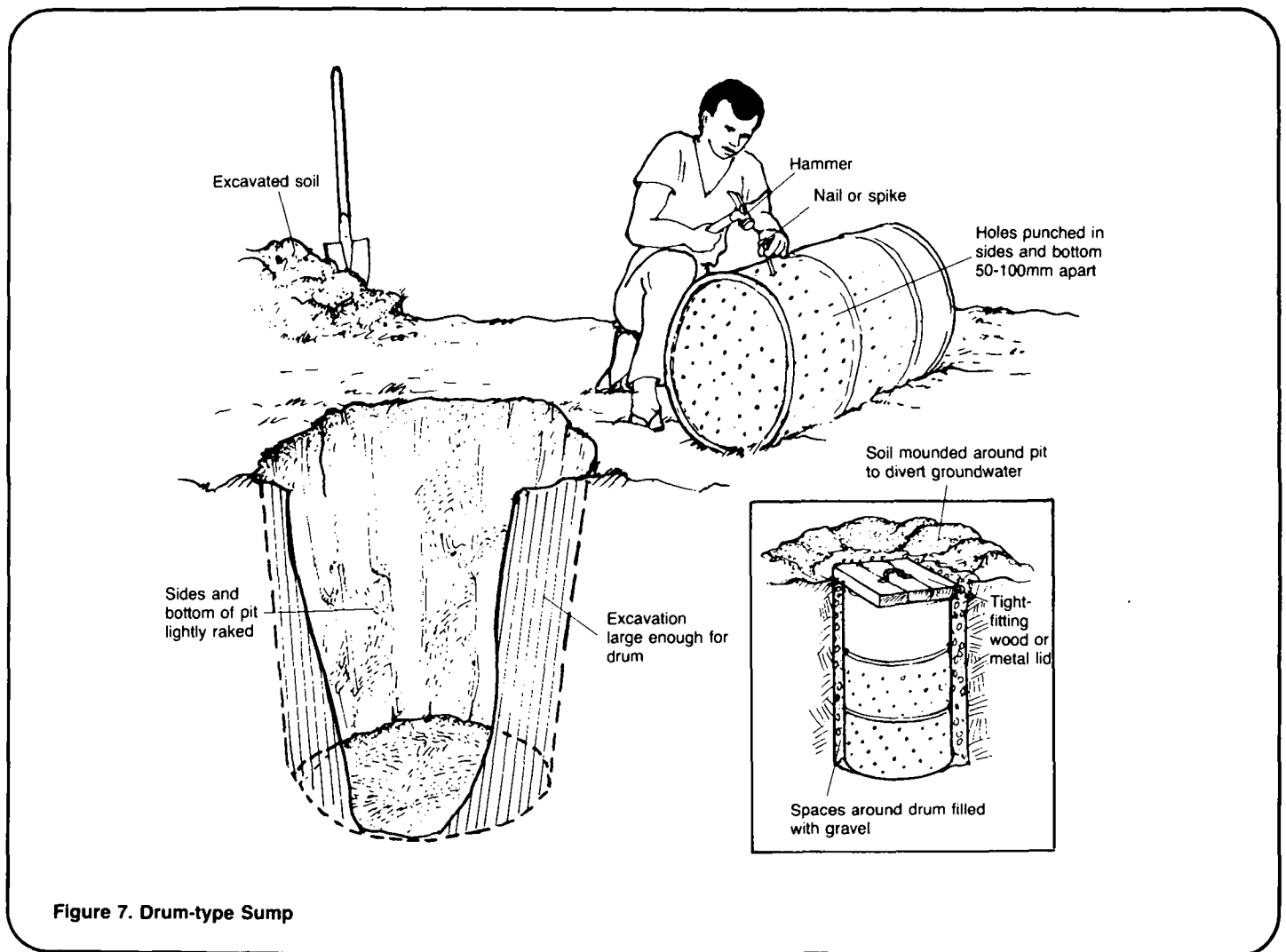


Figure 7. Drum-type Sump

may also surround the sump with a low mound of soil to prevent surface water from flowing in.

For a soakage pit:

1. Assemble all laborers, supplies, tools, and diagrams needed to begin construction. Study all diagrams carefully.

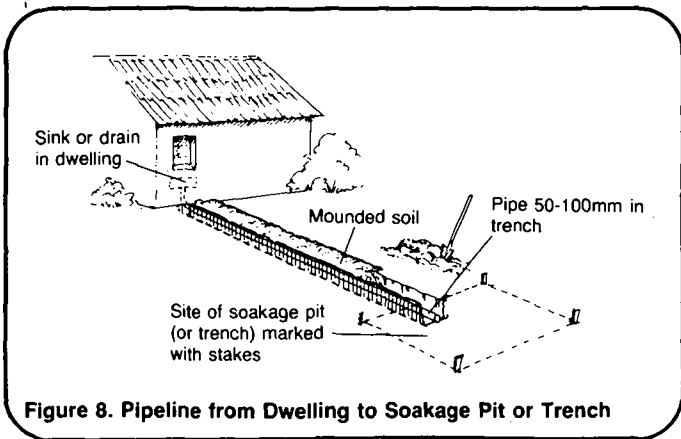
2. Use the location map and a measuring tape to lay out on the ground the dimensions of the pit and the trench for the pipeline. The trench extends from the dwelling or aqua privy to the pit in as straight a line as possible.

3. Dig the trench for the pipeline as shown in Figure 8. The bottom of the trench should slope evenly downward, about 1 unit downward for every 50-100 units in distance, from the dwelling or aqua privy to the pit site. The trench need be no wider than 0.3m and no deeper than 0.3m

4. Lay 50-100mm diameter pipe in the trench and connect it to the sink or drain in the dwelling or the overflow pipe of the aqua privy. Seal all pipe connections with mortar or other material. The pipe should extend to the edge of the pit site.

(NOTE: If this pipe carries effluent from an aqua privy, it must be made of non-corrosive material such as vitrified clay or plastic. If the pipe carries only washwater, it may be made of galvanized metal.)

5. Carefully cover the pipe with soil to protect it from damage, mound to allow for settling, and gently tamp. Pour water in the sink, drain, or aqua privy to be certain that it flows through the pipe. If it does not, the pipe will have to be uncovered, and the problem found and corrected.



6. Excavate the pit to the length, width or diameter, and depth specified by the project designer. The depth is measured downward from the end of the pipe, not from the surface of the ground. If the pit is deeper than 1.5m the sides must be shored up as shown in Figure 9 with boards, poles, bamboo, or other local material to prevent a cave-in. The bottom of the pit should be fairly level. Lightly rake the sides and bottom of the pit.

7. Begin filling the pit with rocks. They should range from fist-size to head-size and they should be fairly clean, because any loose soil will clog the spaces between the rocks.

8. When the rocks reach nearly the level of the inlet pipe, extend the pipe to a point near the center of the pit. Make a small hollow space in the rocks to allow a free flow of washwater or effluent. Lay a flat rock over the end of the pipe as shown in Figure 10.

9. Put in more rocks or stones, filling the pit to at least 100mm above the top of the pipe.

10. Cover the rocks with a layer of straw, hay, or grass to prevent dirt from sifting down between the rocks.

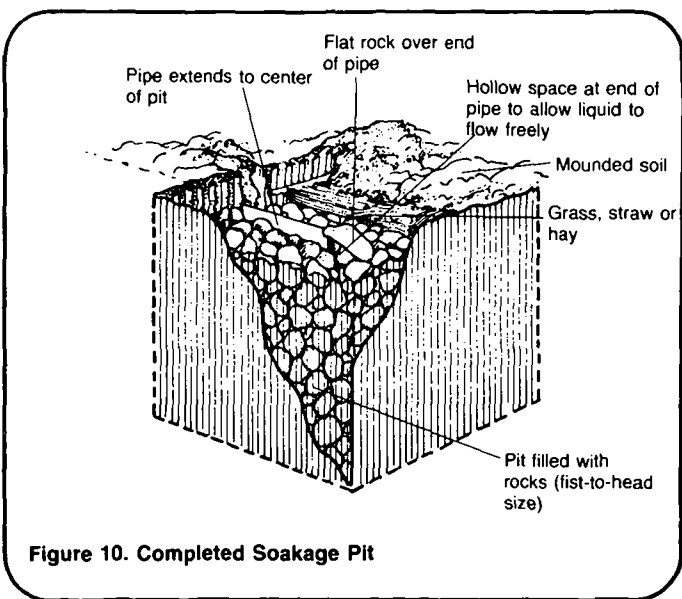
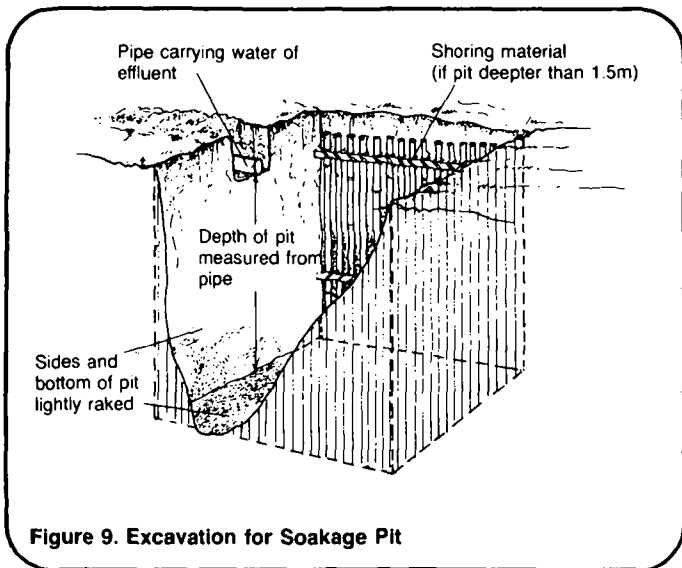
11. Cover the entire pit area with soil, mound to allow for settling, and gently tamp.

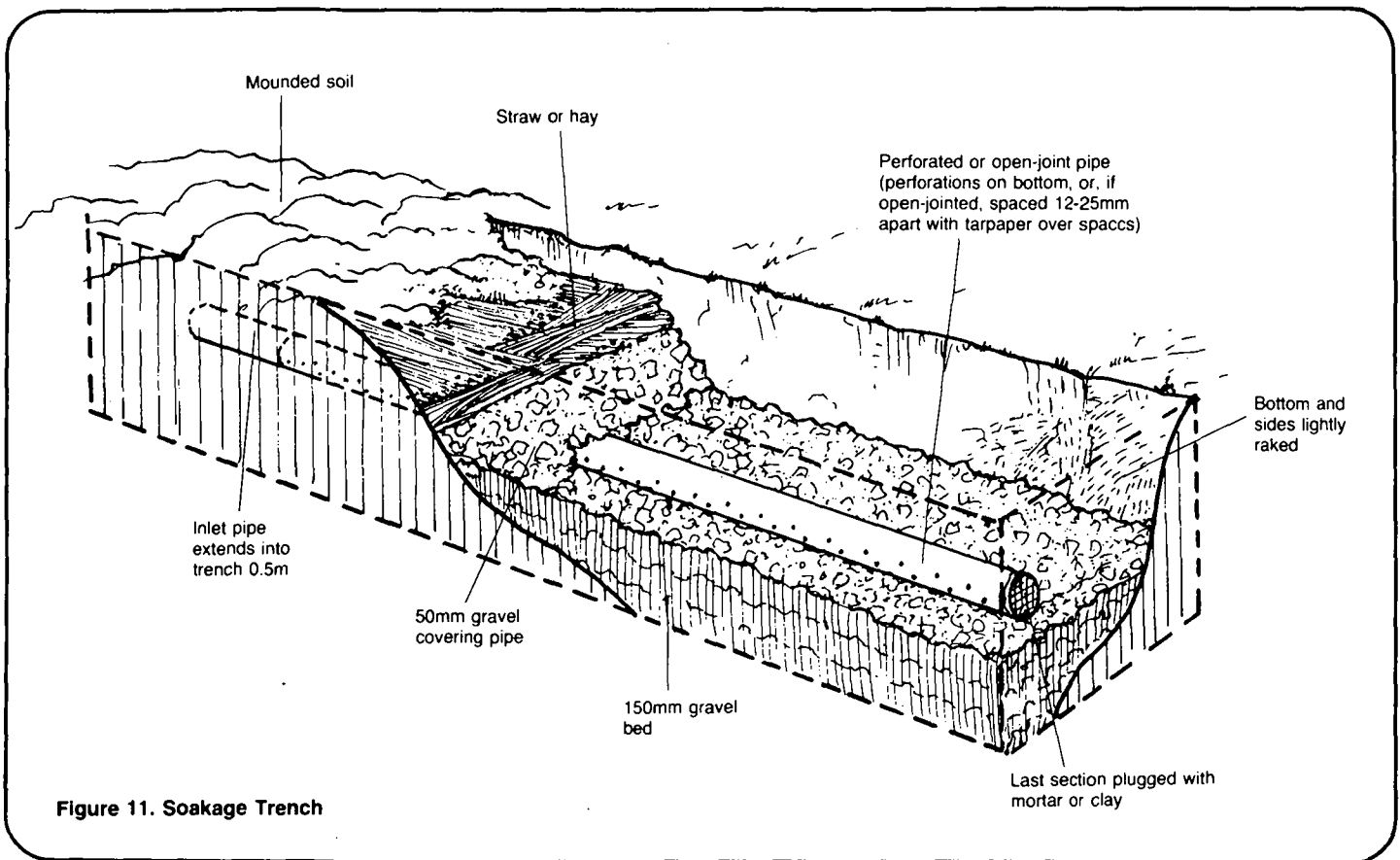
12. When the mound has settled, perhaps after a week or two, plant grass over the pit. This will help prevent erosion caused by wind, rain, or surface water.

For a soakage trench:

1. Follow steps 1 through 5 for a soakage pit, substituting "soakage trench" for "pit."

2. Dig the soakage trench to the width, depth, and length specified by the project designer. The trench should slope downward gradually and evenly away from the inlet pipe, about 1 unit down for every 100-200 units in distance.





**Figure 11. Soakage Trench**

3. Lightly rake the sides and bottom of the trench to allow washwater to soak in quicker. Do not walk in the trench after this step because the bottom may become compacted.

4. Fill the trench with gravel or pebbles up to the bottom of the inlet pipe. This should be 100-150mm of gravel.

5. Extend the inlet pipe about 0.5m into the soakage trench.

6. Lay in perforated or open-joint distribution pipe or concrete blocks. See Figures 11 and 12. If open-joint pipe or blocks are used, leave about 25mm between each pipe section or block. If blocks are used, their openings must face toward the length of the trench. If perforated pipe is used, the perforations must face downward. If non-perforated plastic pipe is available, it can be used as perforated pipe by drilling 12mm holes 150mm apart in two parallel rows along the bottom of the pipe, or as open-joint pipe by sawing it into 450mm sections.

7. Plug the end of the last section of pipe with mortar or other material. If open-joint or concrete blocks are used, cover the space between each pipe section or block with tar paper or other material to prevent gravel from sifting in.

8. Fill the trench with gravel or pebbles to a depth of 50mm above the top of the distribution pipe or concrete blocks.

9. Cover the gravel with hay, straw, or grass to prevent soil from sifting in and clogging the flow of washwater or effluent.

10. Cover the entire system with soil, mound to allow for settling, and lightly tamp.

11. When the mound has settled, perhaps after a week or two, plant grass over it. This will help prevent erosion caused by wind, rain, or surface water.

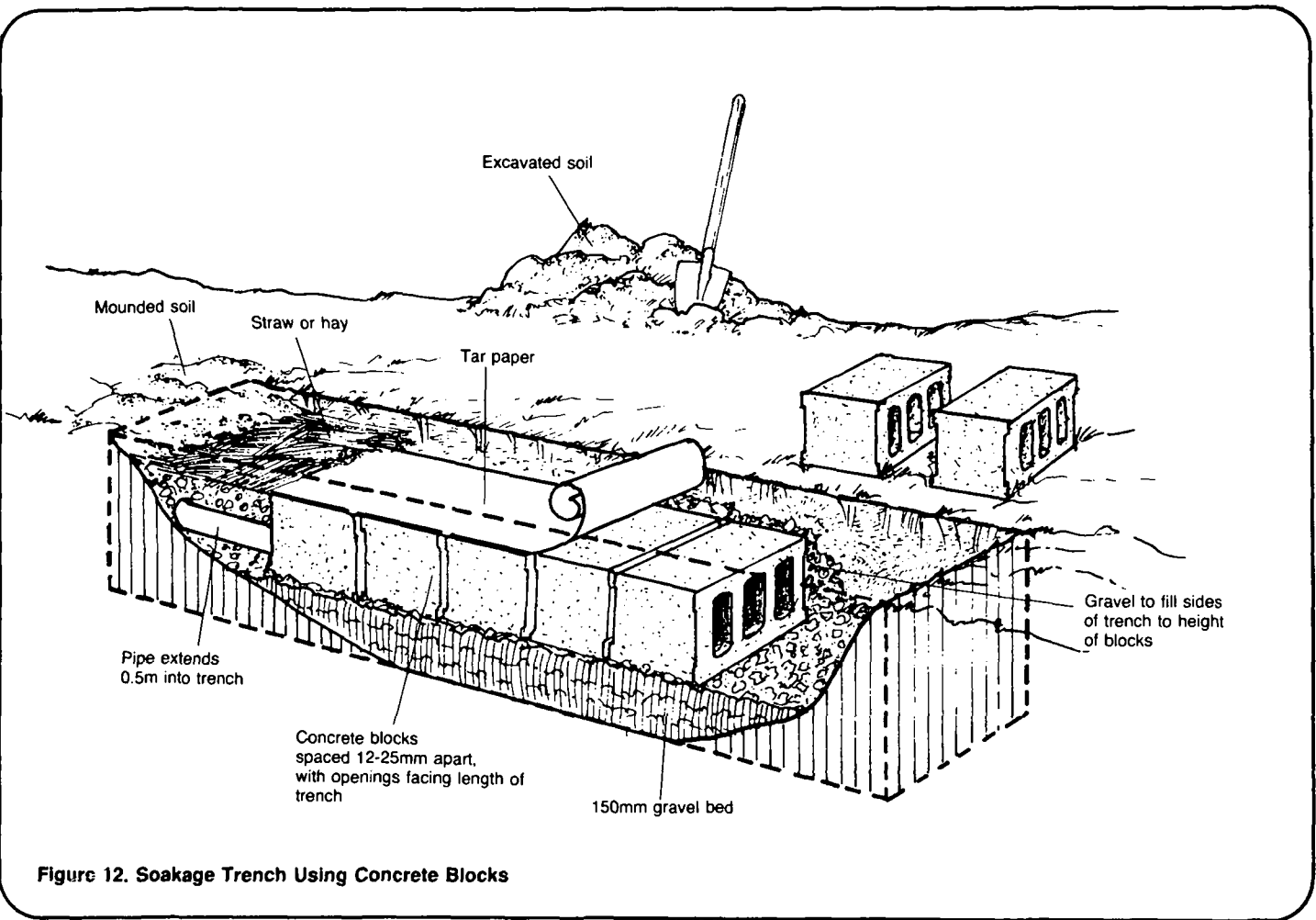


Figure 12. Soakage Trench Using Concrete Blocks

## Operating and Maintaining Washwater Disposal Systems

To operate a sump, lift the lid, pour in washwater, and replace the lid. The washwater will soak safely into the ground. To operate a soakage pit or soakage trench, pour washwater into a sink or drain in the dwelling or into an aqua privy. Washwater or effluent will flow through a pipeline to a pit or trench and be distributed by rocks or gravel, then soak safely into the ground.

Maintaining these systems involves inspecting them for erosion and system failure.

**Erosion.** If there is erosion on or near the system caused by wind, rain, or surface water, fill in the eroded areas with soil. Plant or resod grass over soakage pits and trenches. If surface water is a problem, build small dams or trenches to divert surface water.

**System Failure.** A washwater disposal system fails when the soil underneath and around it no longer absorbs the washwater or effluent, or when the washwater is absorbed slower than it flows in. When a system fails, it cannot be repaired. It must be abandoned and a new system built.

A sump is about to fail when washwater drains away so slowly that there is always about 0.2m of liquid in the sump. When a sump is abandoned, fill it with soil and mound to allow for settling.

A soakage pit or soakage trench is about to fail when unusually lush growth, wet areas, or puddles appear on or near the system or when there are continual odors. The pit or trench must be abandoned.

Although a washwater disposal system cannot be repaired, it is helpful to

review the major reasons for early failure so they may be avoided in future systems:

- Improperly located. The site was not tested adequately for soil suitability, groundwater levels, or impervious layers; the test results were incorrectly used; or the test results were ignored.

- Improperly designed. The system was designed too small, or the flow of washwater or effluent substantially increased after the system was designed.

- Improperly constructed. The system was not constructed according to design specifications. This could mean a number of things: the soakage trench slope was too steep; the distribution pipe was incorrectly installed; the open joints were filled in with gravel; the pit was not large enough; loose soil was allowed to sift in and clog the system, and so on.

When the system fails and a new system must be built, consult the project designer before beginning construction.

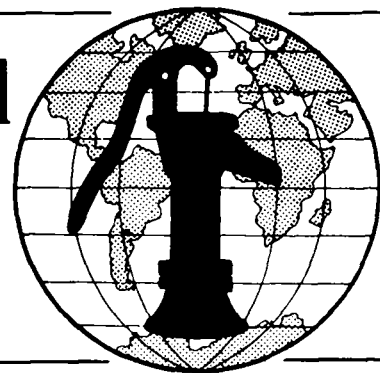
## Notes

## Notes

**Technical Notes** are part of a set of "Water for the World" materials produced under contract to the U.S. Agency for International Development by National Demonstration Water Project, Institute for Rural Water, and National Environmental Health Association. Artwork was done by Redwing Art Service. Technical Notes are intended to provide assistance to a broad range of people with field responsibility for village water supply and sanitation projects in the developing nations. For more detail on the purpose, organization and suggestions for use of Technical Notes, see the introductory Note in the series, titled "Using 'Water for the World' Technical Notes." Other parts of the "Water for the World" series include a comprehensive Program Manual and several Policy Perspectives. Further information on these materials may be obtained from the Development Information Center, Agency for International Development, Washington, D.C., 20523, U.S.A.



# Water for the World



## Operating and Maintaining Privies Technical Note No. SAN. 1.0.1

A privy consists of a pit to hold excreta, a slab with a squatting hole or a seat and pedestal, and a shelter to give the user privacy. There is little operation of a privy except for using it. Maintaining a privy involves cleaning the slab weekly, repairing the privy as needed, and eventually filling the pit with soil and moving the slab and shelter to a new pit.

Routine maintenance of a privy is important, because a poorly maintained privy can become unsightly, smelly, unsanitary, and a breeding place for flies. This technical note describes how to operate and maintain a privy.)

### Useful Definition

EXCRETA - Human body wastes.

### Materials Needed

For operating a privy: lid; anal cleansing materials; and bucket of water for a pour-flush privy.

For cleaning a privy: brush; mop or palm fronds, bucket, and soapy water; or ashes and whisk broom.

For repairing a privy: shovel; the same tools and materials needed to construct the privy shelter and slab, that is, hammer, saw, nails, boards, fly-proof screen, bamboo, wire, bricks, and mortar.

For moving a privy: shovels; cart and draft animals for moving the slab; tools for disassembling the shelter.

### Operating a Privy

Be certain the privy has a lid over the squatting hole or the seat and pedestal, anal cleansing materials, and a box or jar of ashes or dry soil. After each use of the privy, use a small can or coconut shell to sprinkle ashes or soil through the hole. This will help eliminate odors and prevent fly-breeding. See Figure 1. If it is a pour-flush toilet, water must be readily available. The easiest way to take care of this is to keep a bucket in the shelter. Users should be taught to pour enough water into the pour-flush bowl after each use to flush the contents of the bowl into the pit and to replace the water seal. The lid should be put back on after every use to keep flies and odors out of the shelter and the shelter door, if there is one, should be kept closed at all times. Re-supply the privy with anal cleansing materials and water as needed.

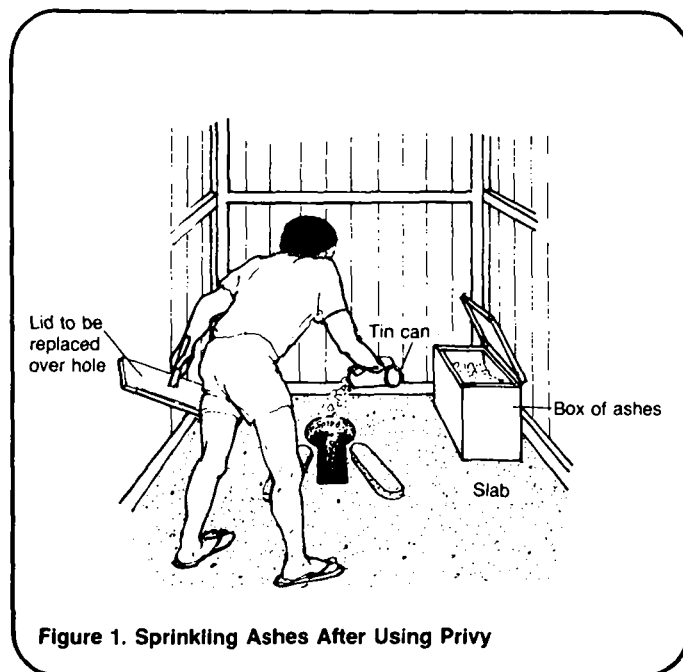


Figure 1. Sprinkling Ashes After Using Privy

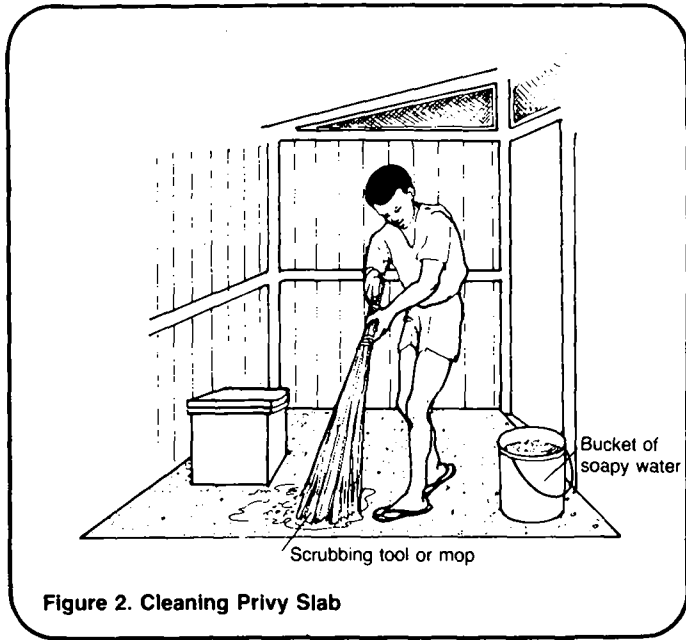


Figure 2. Cleaning Privy Slab

### Cleaning a Privy

Clean the privy slab at least once a week. Keep a brush in the shelter to clean the squatting hole or seat. Wash the slab with a mop or palm fronds and soapy water, if it is available, as shown in Figure 2. If water and a mop are unavailable or unacceptable, sprinkle ashes on the slab to absorb moisture and excreta. Then brush or sweep the dirty ashes into the hole.

### Repairing a Privy

Inspect the privy slab, the shelter, and the grounds around the privy at least once a month. Examine the slab for cracks, excessive wear, or other damage. Repair minor damage at once with the same materials used to construct the slab. If there appears to be major damage, consult the project designer or the person who supervised construction before attempting repairs.

Examine the lid. If it no longer completely covers the hole due to damage or excessive wear, repair it or replace it with a new one.

Examine the inside and outside of the shelter, including the walls, roof, door and hinges, vent pipe, fly-proof screens, and so on. Check for damage or excessive wear. Repair minor damage at once with the same materials used for construction as shown in Figure 3.

Look for signs of termites getting into the shelter where it touches the ground. If termites are found, they must be killed or they will eat any parts of the wooden shelter they can reach. If there are not many termites, large amounts of boiling water may be effective in killing them. Scrape away the tops of the tunnels they have made

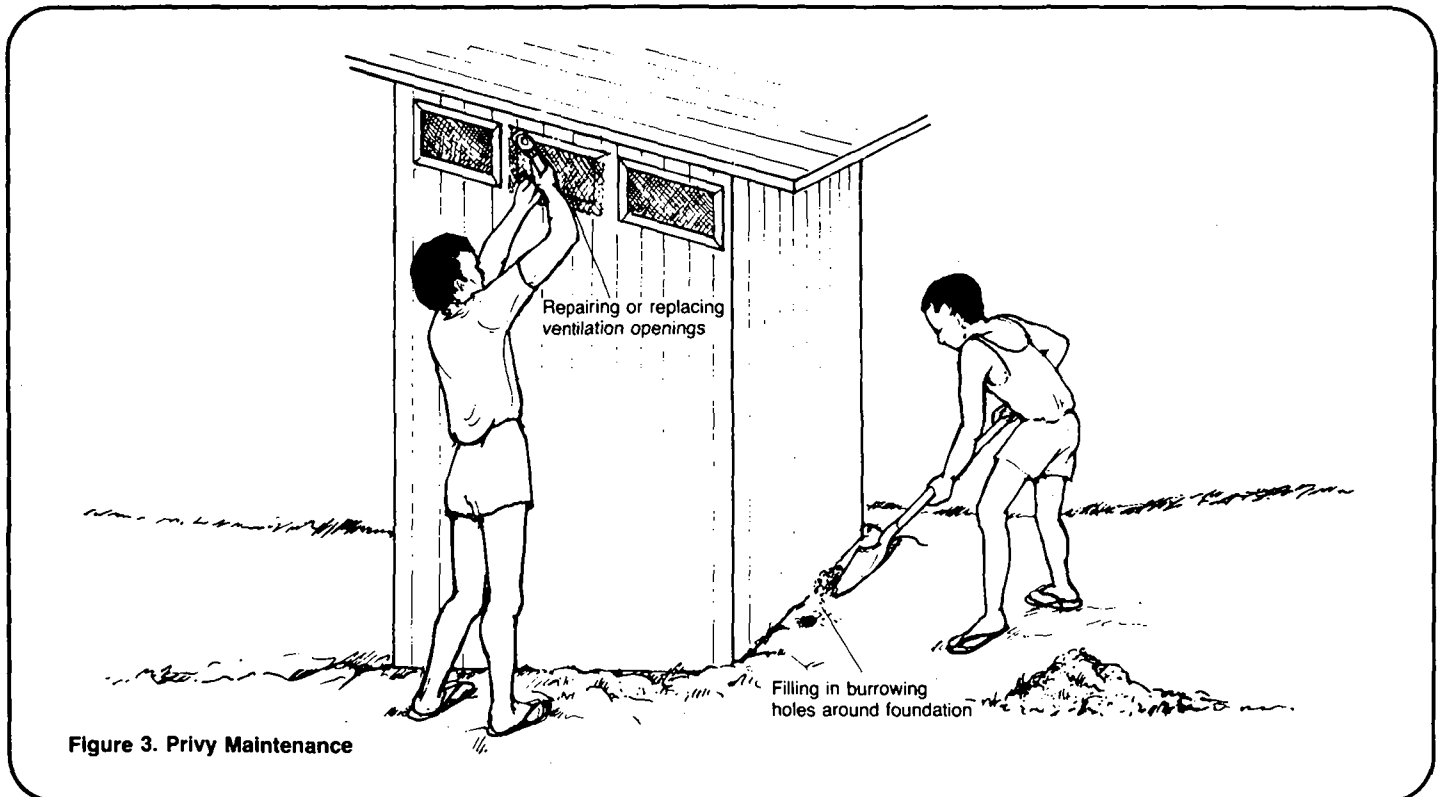


Figure 3. Privy Maintenance

in the wood and pour the water along the tunnels. If the termite infestation is large and they have burrowed deep into the wood, a chemical will be needed to kill them. Termites are very sensitive to drying, so if their tunnels are exposed to the air during a dry period, they may be killed. This method is of no use in hot, rainy weather.

Examine the ground around the privy for erosion caused by surface water or holes caused by animals digging. Fill in holes with soil. If necessary, dig shallow trenches or build small dams to divert surface water away from the privy site.

### Moving a Privy

When the contents of the pit reach 0.5-1.0m below the privy slab, begin preparations for a new pit or another excreta disposal method. The site, size, and dimensions of the new pit should be determined by the project designer (see "Designing Pits for Privies," SAN.1.D.2).

When the contents of the pit are within 0.5m of the privy slab, the pit must be abandoned. Remove the slab and the shelter. Fill in the pit with soil and mound about 0.6m to allow for settling as shown in Figure 4. After a few weeks plant vegetation over the pit site.

Depending on the condition they are in, the slab and shelter may be used for the new privy. Four to six people can load the slab on a cart and haul it to the new pit. Or, place round poles under the slab to act as rollers and drag it to the new site if it is nearby. Take the shelter down and reassemble it over the new pit and slab. If this is not possible, use salvageable parts of the old shelter to construct or repair the new shelter.

The cleaning and maintenance of a privy may be done by the privy users or by a designated worker who may care for several privies. Keep a maintenance record similar to Table 1 showing dates, locations of privies, and tasks.

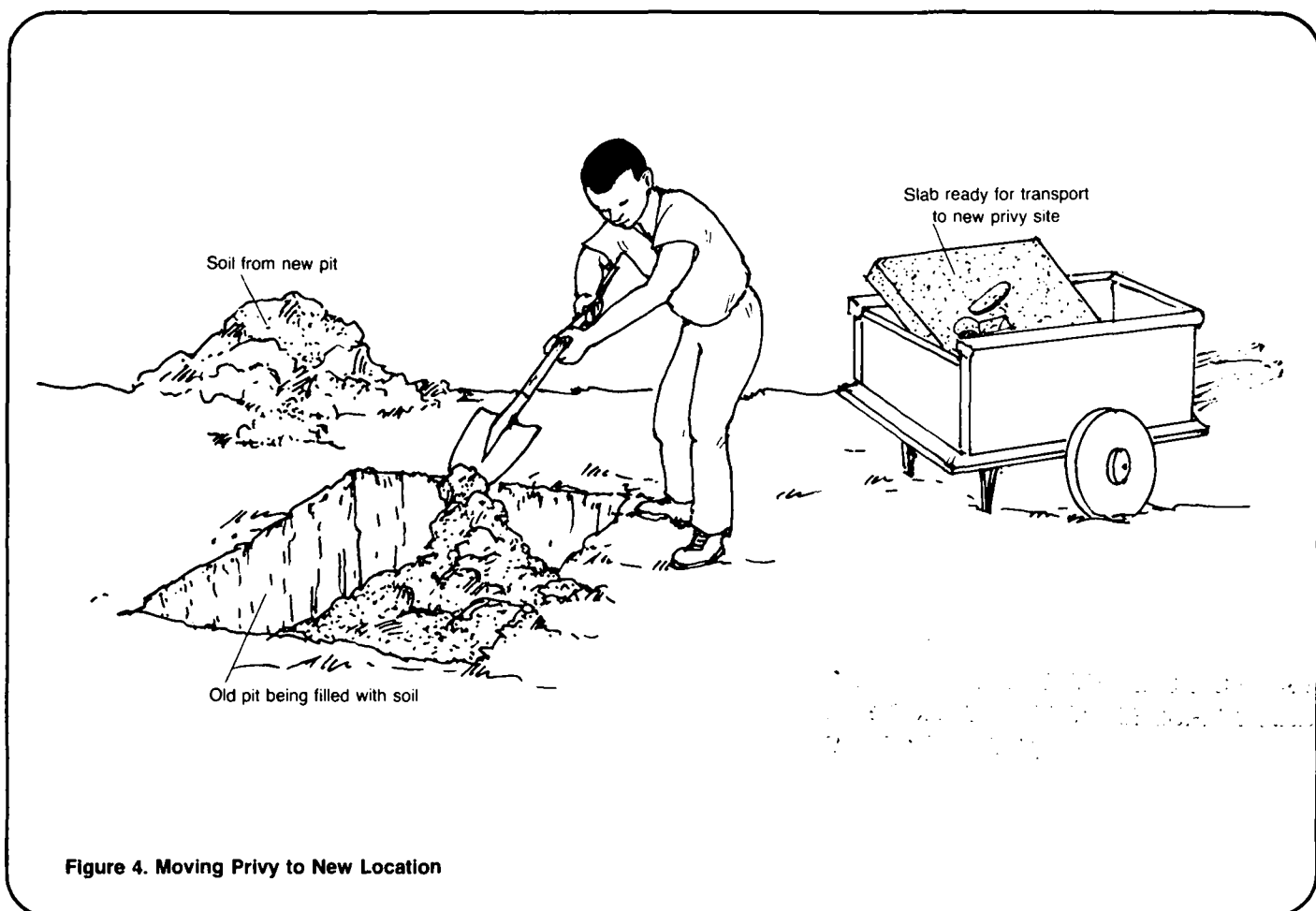


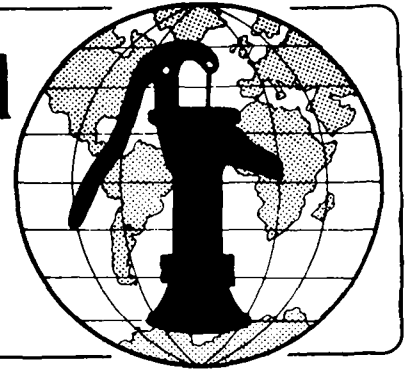
Figure 4. Moving Privy to New Location

Table 1. Sample Maintenance Record for Privies

Date	Location	Task
4 May '82	School	Cleaned three privies. Inspected. Okay.
5 May '82	Mendoza house	Cleaned privy. Inspected privy and grounds. Repaired screed.
5 May '82	N'Kruma house	Privy cleaned by family. Inspected privy. Okay.
7 May '82	Nixon house	Cleaned privy. Inspected privy and grounds. Filled in hole near privy. Repaired lid and door.
9 May '82	Al Hafar house	Cleaned privy. Inspected privy. Okay. Contents of pit about 1.0m from slab. Notified project designer.
11 May '82	School	Cleaned three privies.

**Technical Notes** are part of a set of "Water for the World" materials produced under contract to the U.S. Agency for International Development by National Demonstration Water Project, Institute for Rural Water, and National Environmental Health Association. Artwork was done by Redwing Art Service. Technical Notes are intended to provide assistance to a broad range of people with field responsibility for village water supply and sanitation projects in the developing nations. For more detail on the purpose, organization and suggestions for use of Technical Notes, see the introductory Note in the series, titled "Using 'Water for the World' Technical Notes." Other parts of the "Water for the World" series include a comprehensive Program Manual and several Policy Perspectives. Further information on these materials may be obtained from the Development Information Center, Agency for International Development, Washington, D.C., 20523, U.S.A.

# Water for the World



## Operating and Maintaining Aqua Privies Technical Note No. SAN. 1.0.4

An aqua privy is an underground watertight vault filled with water that receives excreta and washwater from a drop-pipe, allows solids to settle to the bottom, and discharges effluent to a soakage pit. Maintaining an aqua privy involves keeping the liquid level at the flow line, cleaning the slab once each week, checking the sludge depth once each year, and emptying the vault and disposing of septage as needed.

Routine maintenance of an aqua privy is important, because a poorly maintained privy will become unsightly, smelly, unsanitary, and a breeding place for insects. This technical note describes how to operate and maintain an aqua privy. Read the entire technical note before beginning operation or maintenance.

### Useful Definitions

**EFFLUENT** - Settled sewage; in an aqua privy, liquid flowing from the vault to a soakage pit.

**FLOW LINE** - The highest level to which liquid can rise in an aqua privy.

**SEPTAGE** - The combined contents of the aqua privy vault; all of the liquid and sludge.

**SLUDGE** - Solids settled from water-carried wastes.

### Materials Needed

For Operating an Aqua Privy:

(1) anal cleansing materials; (2) bucket of water or washwater.

For Cleaning the Slab:

(1) brush, broom, mop, or palm frond; (2) bucket of soapy water.

For Checking Sludge Depth:

(1) a pole 2m long; (2) a light-colored cloth or towel 0.3m x 1.0m; (3) string or twine 1m long.

For Emptying Vault and Disposing of Septage:

(1) bucket with handle; (2) two ropes 3-4m long; (3) scoop shovel; (4) several barrels, drums, or other large containers; (5) vehicle to haul containers; (6) two shovels; (7) pair of gloves for each worker; (8) pair of boots for each worker.

For Repairing the Vault:

(1) concrete mix; (2) trowel.

### Operating an Aqua Privy

Before using the privy, make sure the vault is filled to the flow line with water. The drop-pipe must extend down into the water. After each use of the privy, pour in about a liter of water or washwater. This will ensure that the liquid level in the vault remains at the flow line.

### Caution!

Do not allow the liquid level in the vault to fall below the bottom of the drop-pipe or the aqua privy will become smelly, unsanitary, and a breeding place for flies and mosquitoes. Keep adding enough water or washwater to maintain the liquid level. See Figure 1.

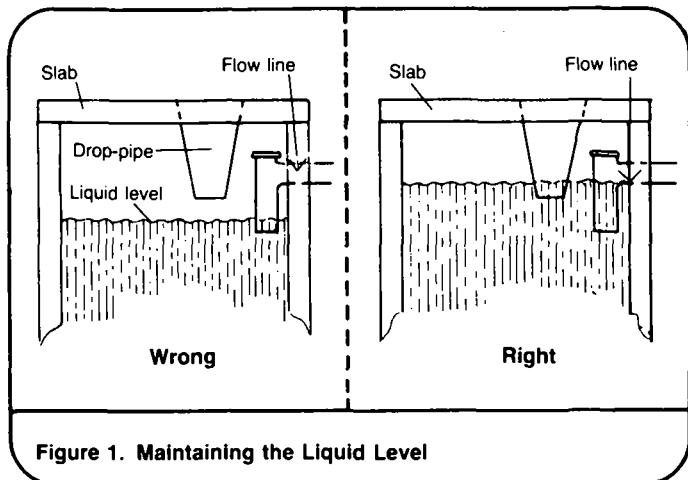


Figure 1. Maintaining the Liquid Level

Do not throw trash such as food scraps and broken dishes into the privy or the vault will fill rapidly and require frequent emptying.

### Cleaning the Slab

Clean the aqua privy slab at least once each week. Use a bucket of soapy water and a palm frond or other material to scrub the slab and the inside of the drop-pipe.

Inspect the drop-pipe every six months. Be sure that it is not rusting or rotting and that it reaches below the liquid level.

### Checking Sludge Depth

Check the sludge depth in the vault at least once each year to determine if the vault needs to be emptied.

1. Wrap a light-colored cloth around a pole 2m long and fasten it with string or twine as shown in Figure 2.

2. Lower the measuring pole down through the drop-pipe to the bottom of the vault as shown in Figure 3.

3. After a few minutes, slowly and carefully remove the pole. The depth of the sludge can be distinguished from the effluent by dark particles clinging to the cloth.

4. Estimate the depth of the sludge by looking at the cloth. If the depth of the sludge is less than one-half the liquid depth of the aqua privy vault, the vault does not need cleaning at this time. Remember that the liquid

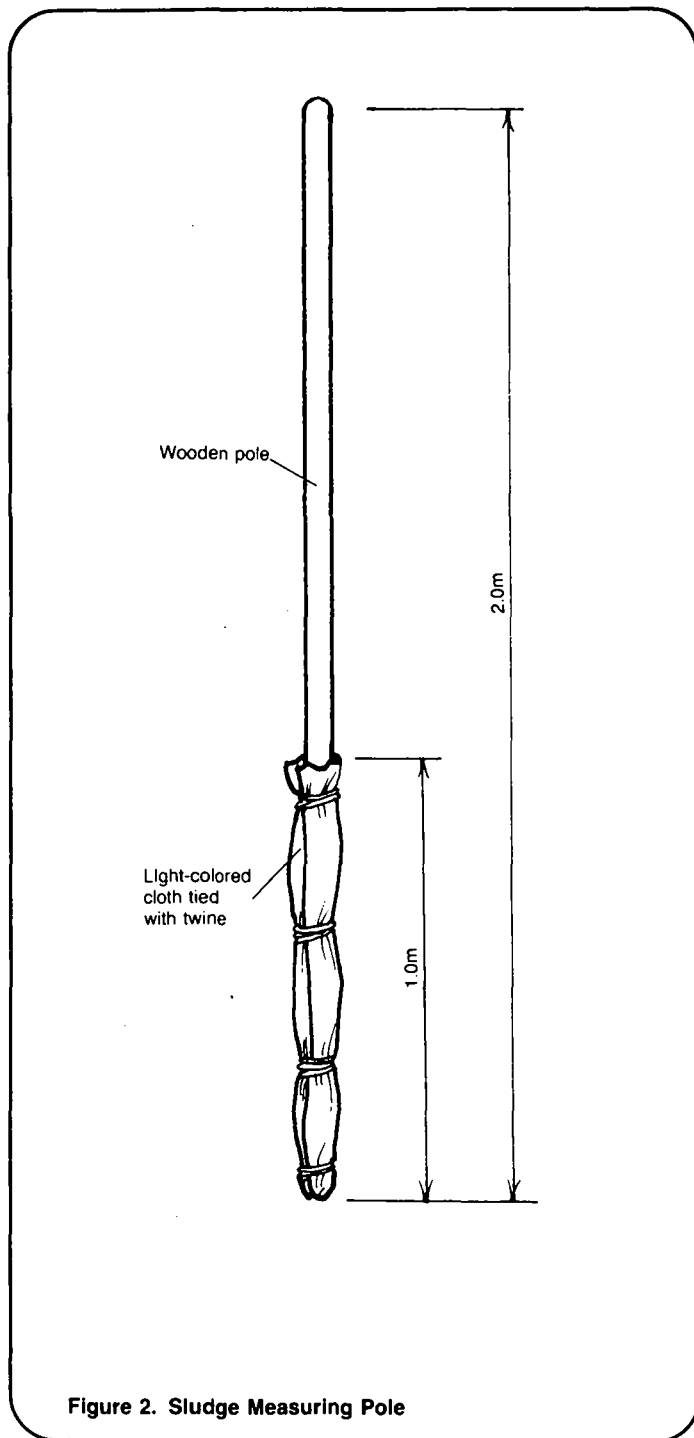


Figure 2. Sludge Measuring Pole

depth is the distance from the flow line to the floor of the vault. If the sludge depth is equal to or greater than one-half the liquid depth of the vault, the vault must be emptied.

### Emptying the Vault

If the sludge depth indicates that the vault needs to be emptied, you should do it as soon as possible. Delay may cause the overflow pipe and soakage pit to clog with solids.

1. Remove the slab from the vault. Depending on the design of the shelter, this may require moving the shelter and disconnecting a portion of the vent pipe. Workers should wear gloves and boots during this entire process.

**Caution!**

Gases will be present in the vault and there will be little or no oxygen. Anyone entering may lose consciousness or die. When the slab is removed, allow a few hours for the vault to air out to renew oxygen and allow dangerous gases to disperse.

2. Dip out the septage with a bucket tied to a rope and empty it into containers on a cart. Have a worker continually stir the septage with a shovel or pole. This will bring sludge off the bottom and leave less to be shoveled out later. See Figure 4.

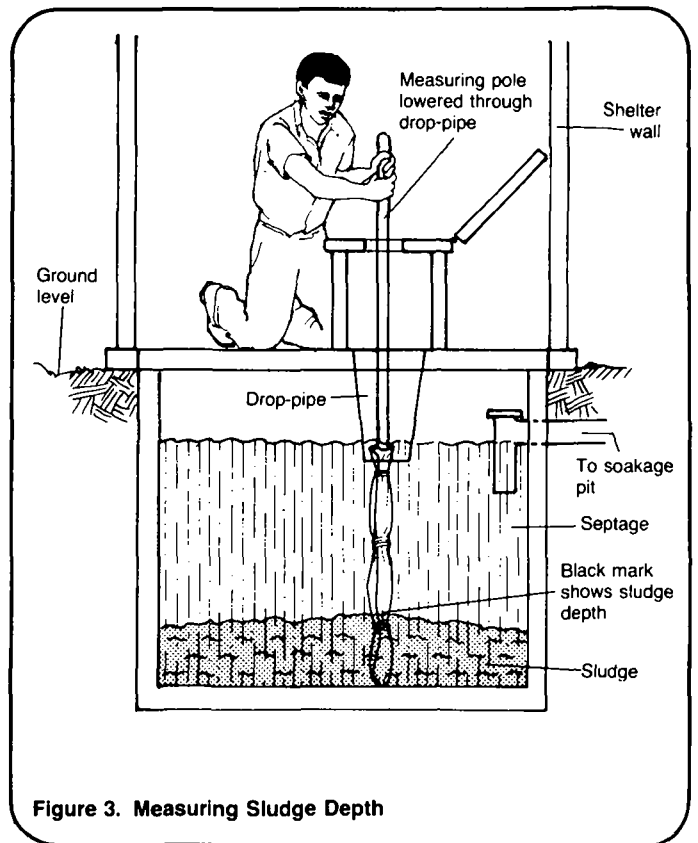


Figure 3. Measuring Sludge Depth

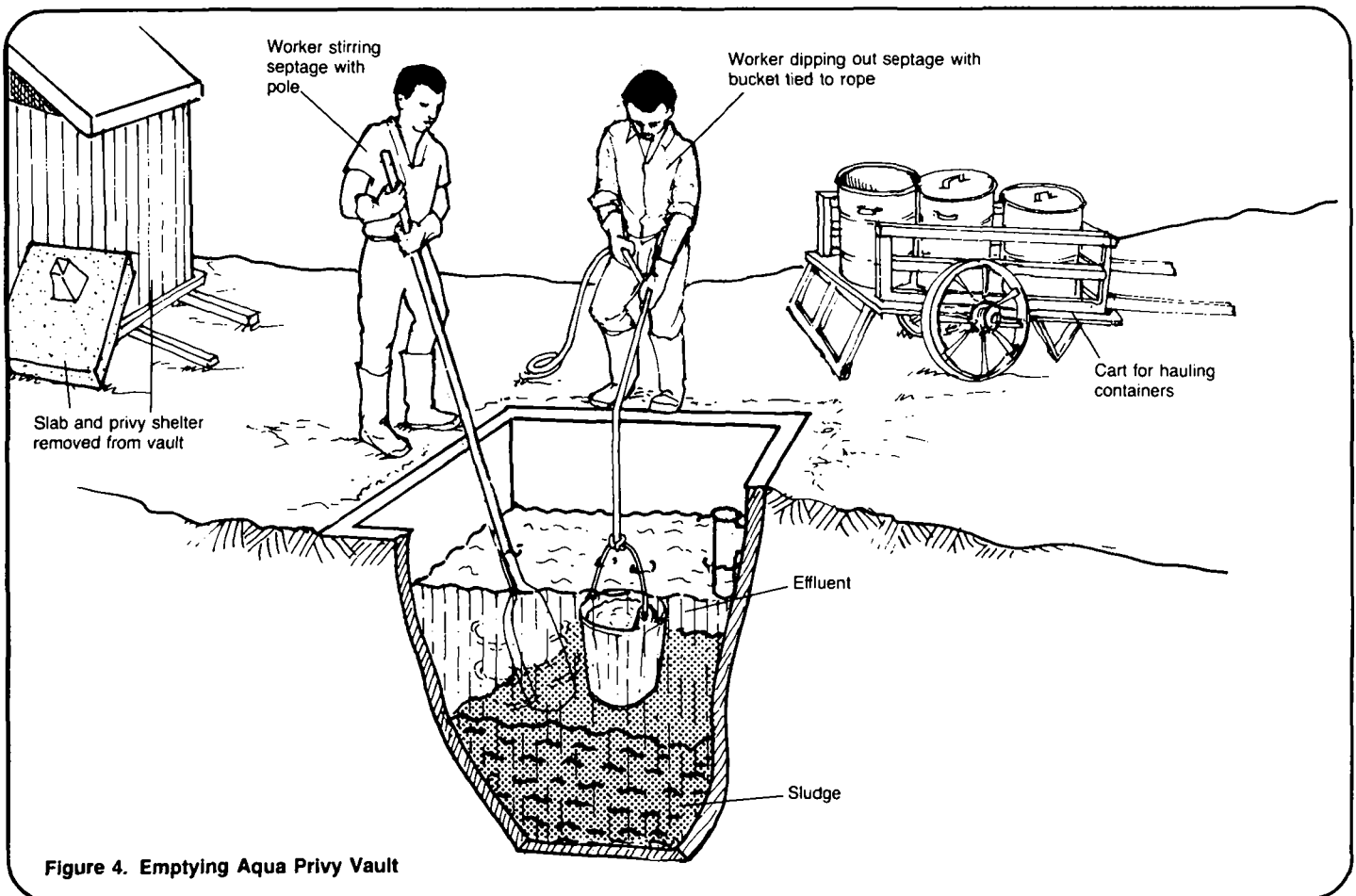


Figure 4. Emptying Aqua Privy Vault

3. When no more septage can be dipped out with the bucket, it will be necessary to enter the aqua privy vault. Wear a safety rope tied to the cart or other secure object outside the vault. Remove sludge from the bottom of the vault with a scoop shovel. Fill the bucket tied to a rope and have a worker outside the vault empty the bucket into the containers. See Figure 5.

4. When the vault is empty, check the walls and floor for cracks or other damage. Repair at once with cement mortar.

5. Refill the vault to the flow line with water.

6. Replace the slab and waterproof around the edges with tar or some other material. Replace the shelter.

### Disposing of Septage

1. Select a disposal site downhill and at least 60m from any water supply or dwelling. Preferably, the site should be outside the village in a remote or little-used area.

2. Dig a shallow pit or trench and dump in the septage. Cover it with at least 0.5m of soil. See Figures 6 and 7.

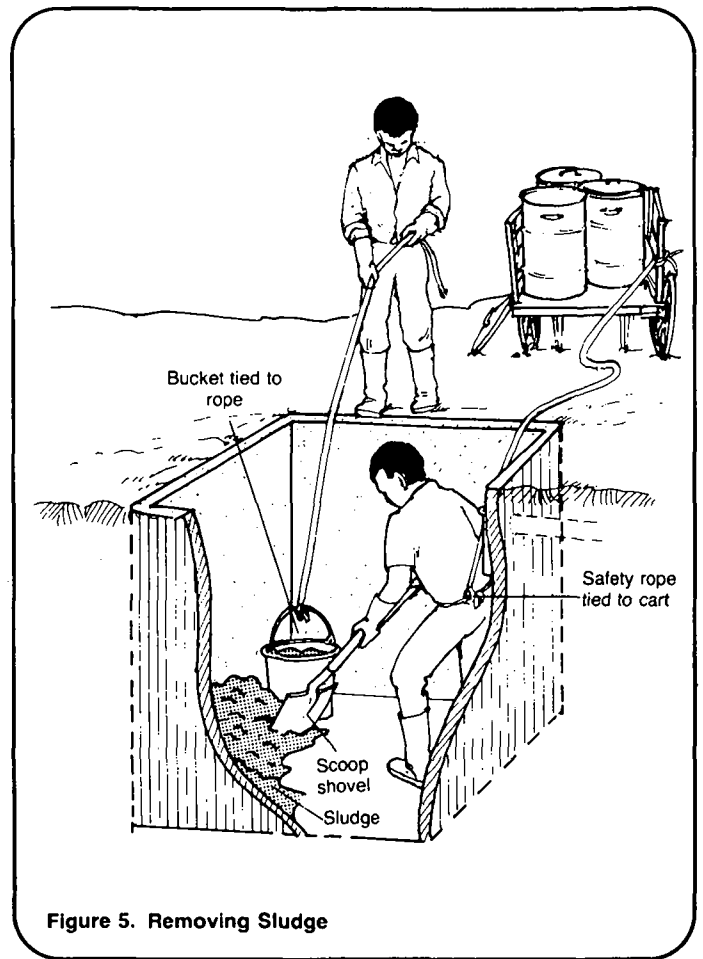


Figure 5. Removing Sludge

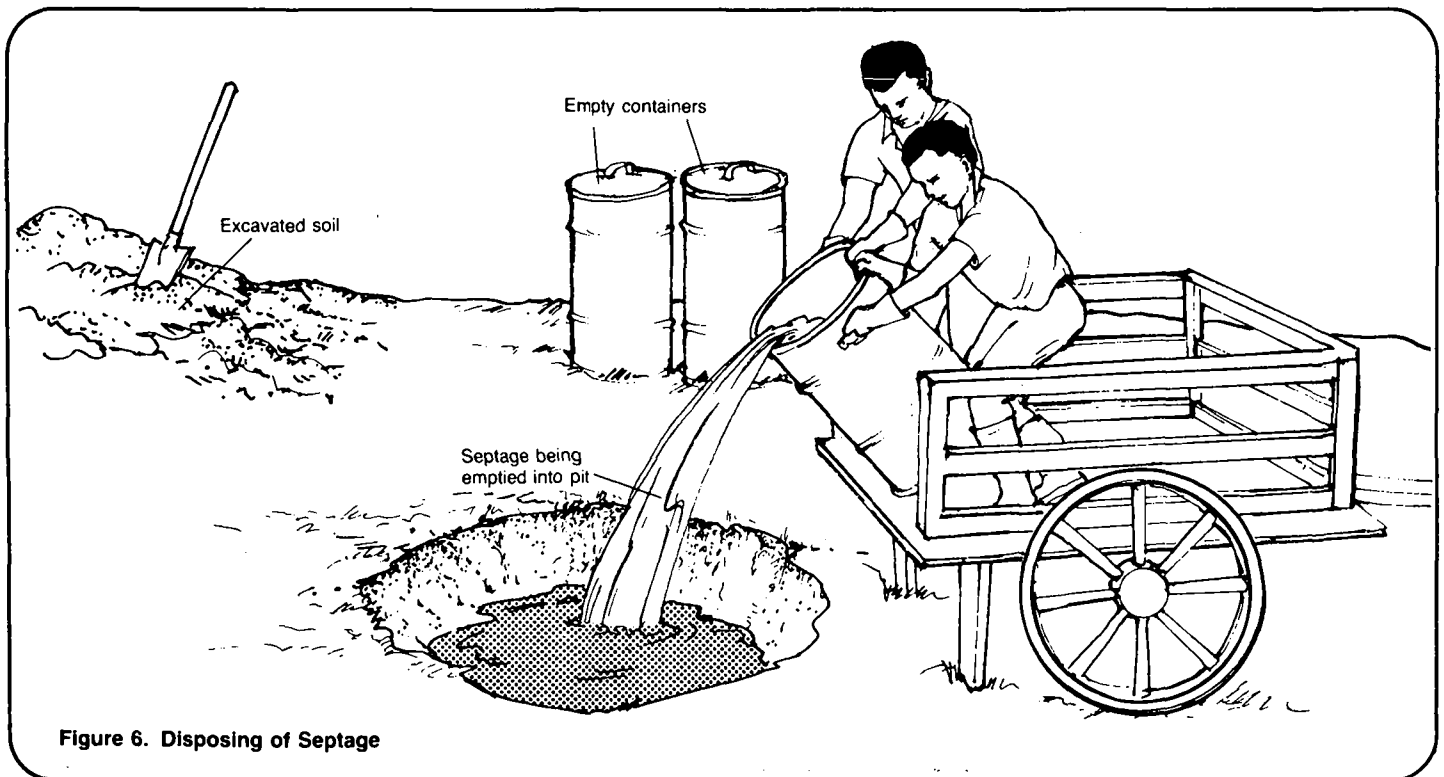


Figure 6. Disposing of Septage



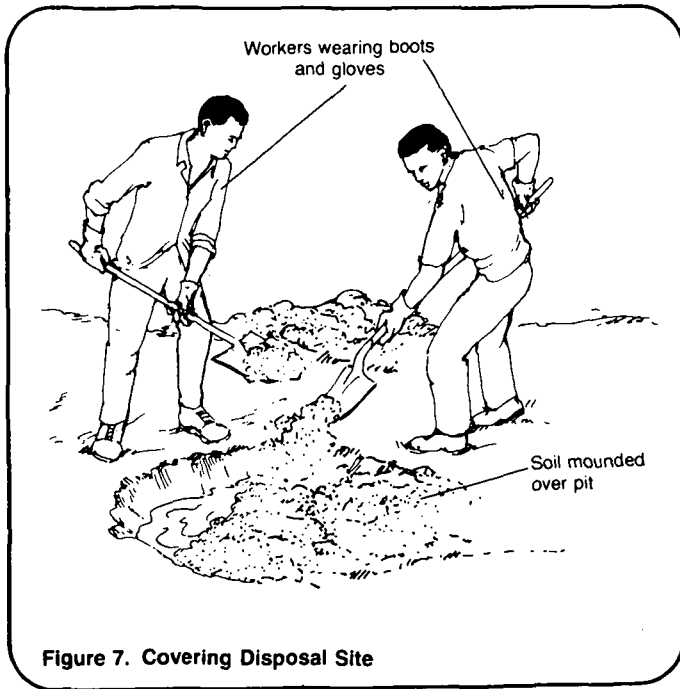


Figure 7. Covering Disposal Site

3. Wash all buckets, shovels, and containers that have come in contact with septage.

A soakage pit shows signs of failure when unusually lush growth, wet areas or puddles are seen on or near the site, or when there are continual odors. When a soakage pit fails, it must be abandoned and a new pit dug. Consult the project designer.

The cleaning and maintenance of an aqua privy may be done by the privy users or by a designated worker who cares for several privies. Have the worker keep a maintenance record similar to Table 1.

### Maintaining the Soakage Pit

This involves inspecting the pit site for erosion and system failure. If there is erosion on or near the pit site due to wind, rain or surface water, fill in the eroded areas with soil. Plant grass over the site. If surface water is a problem, build small dams or trenches to divert water.

Table 1. Sample Maintenance Record for Aqua Privy

Date	Location	Liquid Depth	Task
10/81	Perey house	1.0 m	Checked sludge depth (0.2 m).
10/81	Al. Hafar house	1.2 m	Measured sludge (0.4 m).
11/81	Statt house	1.1 m	Measured sludge (0.7 m). Emptyed septage into containers; refilled vault with water; buried septage south of village.
2/82	N'Kusma house	1.1 m	Measured sludge (0.3 m). Filled in erosion at soakage pit site.
10/82	Perey house	1.0 m	Measured sludge (0.3 m).

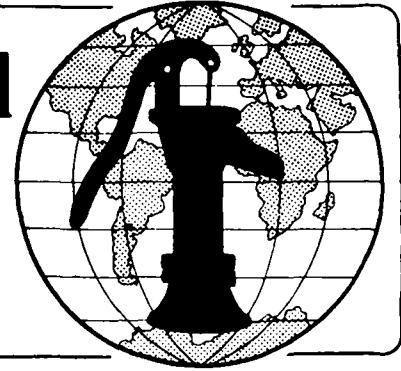
## Notes

## Notes

## Notes

**Technical Notes** are part of a set of "Water for the World" materials produced under contract to the U.S. Agency for International Development by National Demonstration Water Project, Institute for Rural Water, and National Environmental Health Association. Artwork was done by Redwing Art Service. Technical Notes are intended to provide assistance to a broad range of people with field responsibility for village water supply and sanitation projects in the developing nations. For more detail on the purpose, organization and suggestions for use of Technical Notes, see the introductory Note in the series, titled "Using 'Water for the World' Technical Notes." Other parts of the "Water for the World" series include a comprehensive Program Manual and several Policy Perspectives. Further information on these materials may be obtained from the Development Information Center, Agency for International Development, Washington, D.C., 20523, U.S.A.

# Water for the World



## Operating and Maintaining Bucket Latrines

Technical Note No. SAN. 1.O.5

A bucket latrine consists of a shelter, slab, and platform enclosing a bucket. Operating a bucket latrine involves emptying the bucket every one to three days, carting the excreta to a disposal site and usually burying it. For other types of disposal sites, see "Operating and Maintaining a Composting System," SAN.3.0.2, and "Operating and Maintaining a Biogas System," SAN.3.0.4. Maintaining a bucket latrine system requires routinely cleaning the latrine, including buckets and containers, and periodically inspecting the latrine and trenching site for damage.

Proper maintenance of a bucket latrine is necessary to prevent fly-breeding and to avoid possible health hazards due to contamination from excreta. This technical note describes how to operate and maintain a bucket latrine.

### Useful Definitions

**CONTAMINATE** - To make unclean by introducing an infectious (disease-causing) impurity such as bacteria from excreta.

**EXCRETA** - Human body wastes.

### Caution!

1. Wear boots and gloves when handling excreta to prevent possible health problems.
2. After disposing of excreta, wash hands, buckets, containers, and scrapers to prevent possible contamination from excreta.

## Materials Needed

To operate each latrine: a lid to cover the squatting hole, anal cleansing materials, box or jar of ashes or fine earth, can or coconut shell.

To dispose of excreta: map similar to Figure 1 showing latrine and disposal site locations and materials list similar to Table 1 provided by project designer, and all personnel and materials described in the materials list.

To repair latrines: the same materials used for construction such as cement, wood, bamboo, hammer and nails.

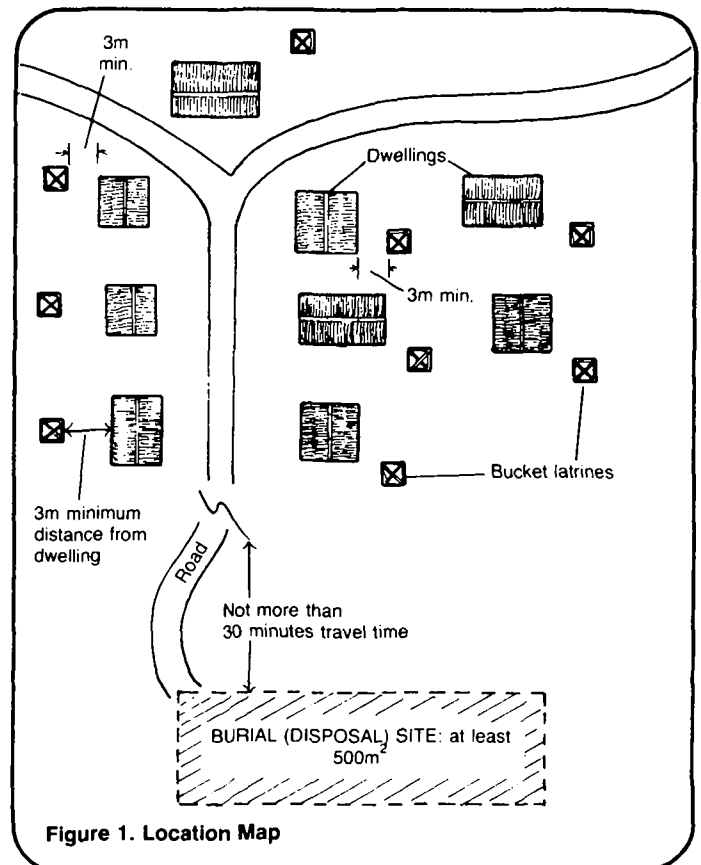


Figure 1. Location Map

## Operating and Cleaning the Latrine

1. After each use of the latrine, sprinkle ashes or fine earth onto the contents of the bucket. This will help prevent fly-breeding and foul odors.

2. Replace the lid over the hole after each use.

3. At least once each week, clean the slab and the compartment that holds the bucket with either ashes or soap and water, and a broom, brush, or mop. See Figure 2.

## Disposing of Excreta

1. Every one to three days, preferably every day, remove the used bucket from the latrine and empty it into a container equipped with a lid. Replace the bucket with a clean one. Tightly close the fly-proof door. See Figure 3.

2. When every latrine shown on the location map has been serviced, cart the containers and the dirty buckets to the disposal site.

3. The site may be a composting system, a biogas system, or a burial site. If it is a burial site or trenching ground, excavate a trench 0.5-1.0m wide, 0.5-1.0m deep, and long enough to contain the excreta. Empty the containers into the trench and cover with the excavated soil. See Figure 4.

4. Wash all buckets, containers, scrapers, and shovels. Then wash your hands.

## Inspecting the Bucket Latrine and Trenching Ground

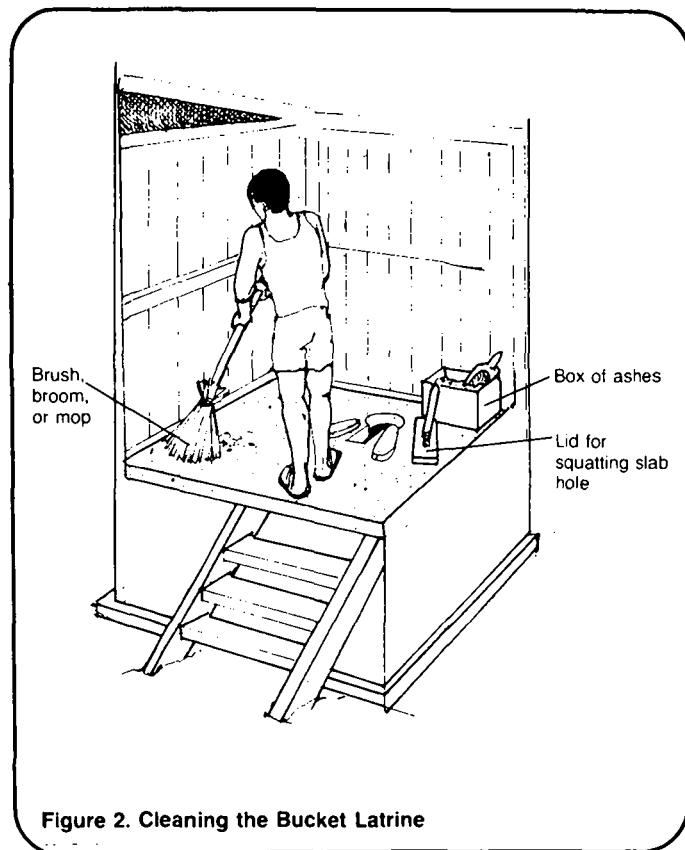
Once each month inspect the fly-proof door. It should close tightly and completely cover the rear wall opening. Repair or replace it if necessary.

Inspect the base of the latrine for cracks and repair them with concrete mortar. Inspect the privy shelter and repair or replace damaged parts. Once each month inspect the trenching ground. Fill in with soil any eroded

**Table 1. Sample Operations Materials List**

Item	Description	Quantity	Estimated Cost
Labor	Foreman	1	---
	Laborers	3	---
Supplies Tools, and Vehicles	Containers with lids (40-60 liters each)	---	---
	Scrapers with long handles	---	---
	Carts (hand-drawn)	---	---
	Shovels	---	---
	Pairs of gloves	---	---
	Pairs of boots	---	---
	Brushes for cleaning	---	---
	Containers for soap and water	---	---
Other	---	---	

Total Estimated Cost = ---

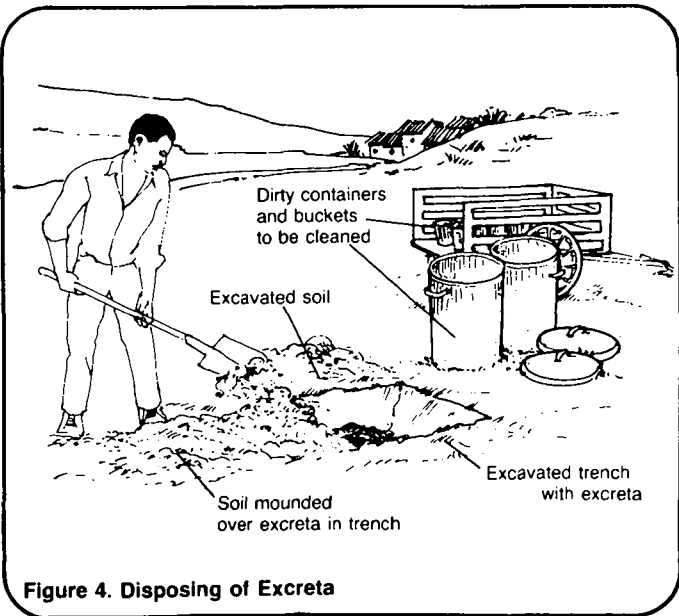
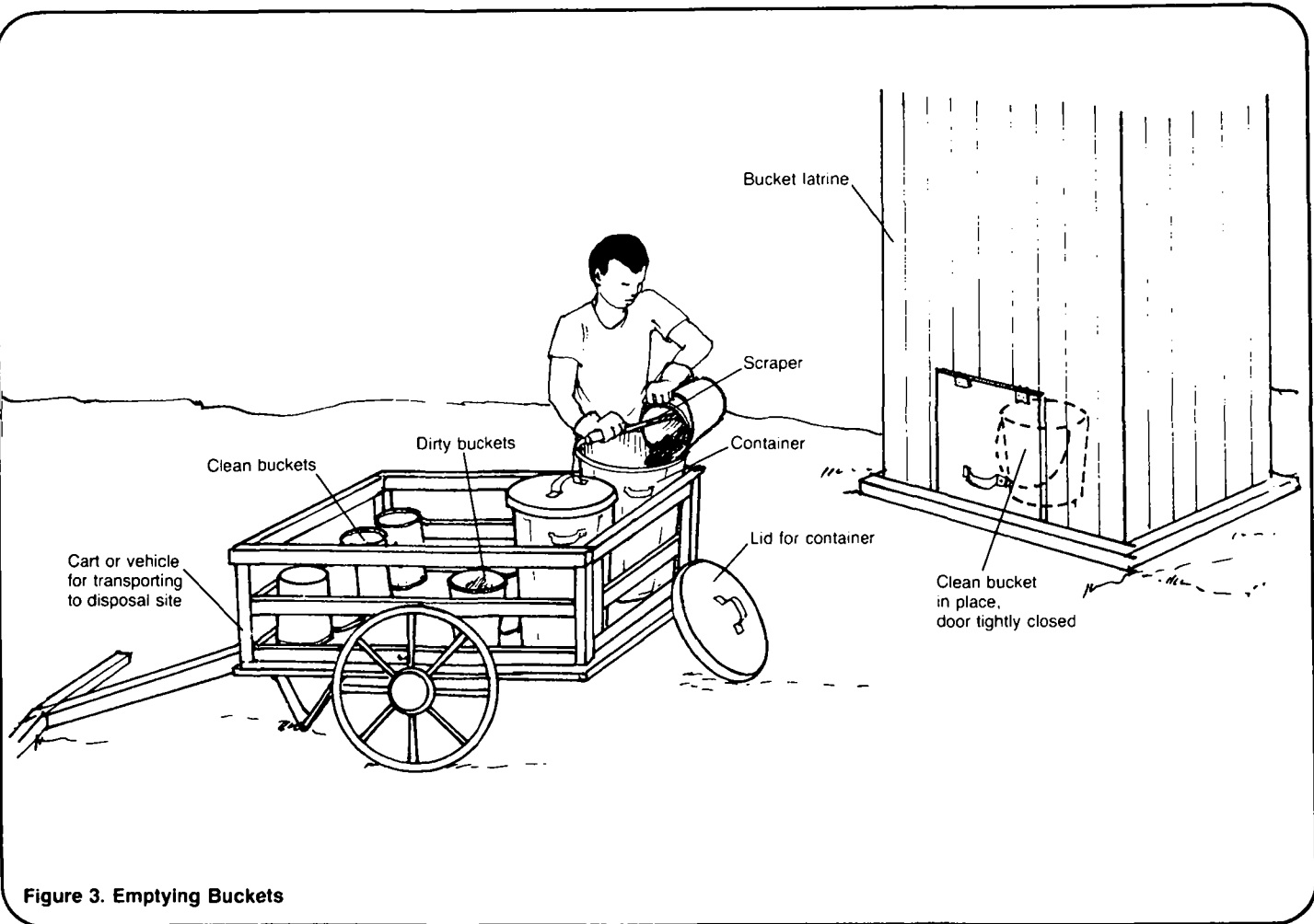


**Figure 2. Cleaning the Bucket Latrine**

areas or holes made by burrowing animals. If burrowing animals are a constant problem, set traps or erect fences to keep them away.

Surface water should not be allowed to flow over the burial site. If necessary, divert water with shallow trenches or small dams.

Keep a maintenance record similar to Table 2 showing the dates of excreta collection and other related tasks.



**Table 2. Sample Maintenance Record**

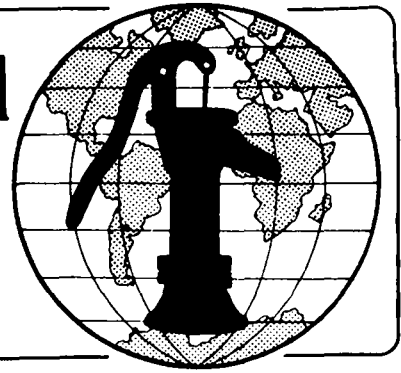
Date of excreta collection and disposal	Other Tasks
10/22/81	
10/30/81	Cleaned latrines!
11/1/81	
11/3/81	
11/5/81	
11/7/81	Cleaned latrines!
11/9/81	Inspected latrines. Okay. Inspected burial site - filled in erosion.
11/11/81	
11/13/81	Cleaned latrines!
11/15/81	

## Notes

**Technical Notes** are part of a set of "Water for the World" materials produced under contract to the U.S. Agency for International Development by National Demonstration Water Project, Institute for Rural Water, and National Environmental Health Association. Artwork was done by Redwing Art Service. Technical Notes are intended to provide assistance to a broad range of people with field responsibility for village water supply and sanitation projects in the developing nations. For more detail on the purpose, organization and suggestions for use of Technical Notes, see the introductory Note in the series, titled "Using 'Water for the World' Technical Notes." Other parts of the "Water for the World" series include a comprehensive Program Manual and several Policy Perspectives. Further information on these materials may be obtained from the Development Information Center, Agency for International Development, Washington, D.C., 20523, U.S.A.



# Water for the World



## Operating and Maintaining Compost Toilets Technical Note No. SAN. 1.0.6

A compost toilet consists of a pair of waterproof vaults that receive excreta, ashes, sawdust, straw, and grass. Each vault is equipped with a slab for defecating, a rear opening for removing compost, and a hole for a vent pipe. Operating a compost toilet involves keeping it clean and periodically changing vaults and removing compost. Maintaining a compost toilet requires monthly inspection and repair of any damage.

Correct use of the compost toilet is necessary in order to prevent severe problems with fly breeding and foul odors, and to maintain the bacterial action that produces compost.

### Materials Needed

For operating and cleaning a compost toilet: (1) lid; (2) anal cleansing material; (3) box or jar for ashes and straw; (4) can or coconut shell for sprinkling ashes; (5) brush or broom.

For changing vaults and removing compost: (1) tar or other material for sealing openings; (2) shovel; (3) hoe; (4) wheelbarrow.

For repairing toilet and shelter: the same materials used for construction--cement, sand, gravel, mixing containers, trowel, boards, bamboo, wire, hammer, saw, nails, and fly-proof screen.

### Preparing a Compost Toilet for Use

Only one vault is used at a time, so be certain the squatting hole of the vault not in use is covered with a heavy lid. Prepare the vault to be used by putting in a loose layer of leaves, weeds, straw, grass clippings or sawdust. This will soak up liquids.

### Useful Definitions

**BACTERIAL ACTION** - The process of organic matter being digested and broken down by tiny organisms.

**COMPOST** - A dark, fairly dry, crumbly, odorless material that is produced by sealing excreta, ashes, sawdust, straw, and vegetable wastes for 6-12 months in the vault of a compost toilet. Compost can be used to fertilize crops.

**EXCRETA** - Human body wastes.

Place a lid with a handle over the squatting hole. Put a box or jar of ashes or powdered soil in the shelter along with an empty can or coconut shell. Also stock the shelter with a supply of anal cleansing material. See Figure 1. The compost toilet is now ready for use.

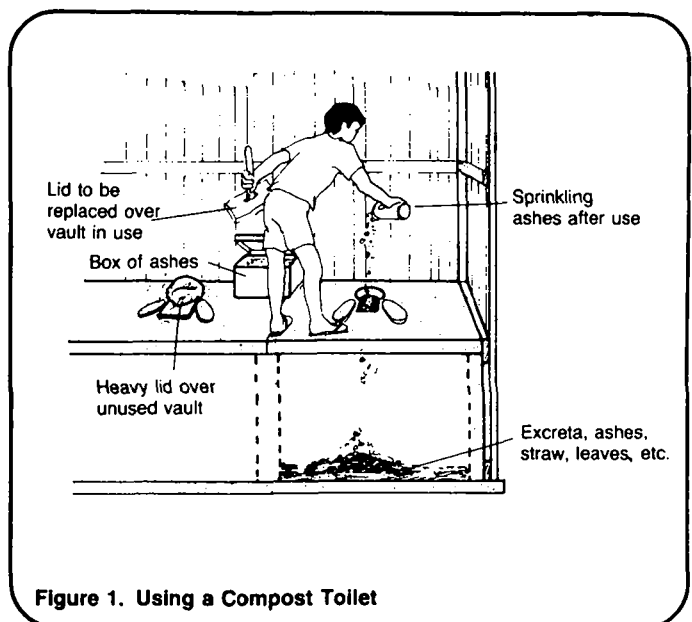


Figure 1. Using a Compost Toilet

## Using a Compost Toilet

After the toilet is used each time, use the can or coconut shell to sprinkle in ashes or fine earth. This will soak up liquid and help prevent odors and fly-breeding. Replace the lid over the squatting hole. See Figure 1.

At the end of each day, put in kitchen scraps and house and yard sweepings. Once or twice a week put in grass clippings, straw, leaves, or sawdust to cover the contents of the vault. Do not worry about over-filling the vault, because bacterial action will greatly reduce the volume of the contents.

It might be necessary to prepare a leaflet showing pictures of how to use the compost toilet. This will help people who cannot read understand and remember how to use the toilet.

Clean the toilet at least once each week by sprinkling ashes or powdered earth on the slab and around the squatting hole and sweeping them into the vault. Replenish the supply of ashes or fine earth in the box.

### Caution!

Do not use the toilet for a washroom or pour water into the vault. The contents will become a soggy, smelly mess.

Do not put material such as wood, glass, metal, or discarded clothing in the toilet. This material will not break down readily into compost. Wear gloves when handling compost.

## Changing Vaults

The vault will gradually fill with excreta and other material. When the contents reach 0.2-0.3m below the squatting slab, probably after 6-12 months of use, it is time to change vaults.

Fill the used vault with fine soil. Remove the heavy lid from the empty vault and place it over the squatting hole of the full vault. Prepare the empty vault by putting in a layer of leaves, weeds, straw, grass clippings, sawdust or similar material. This vault is now ready for use (see "Using a Compost Toilet").

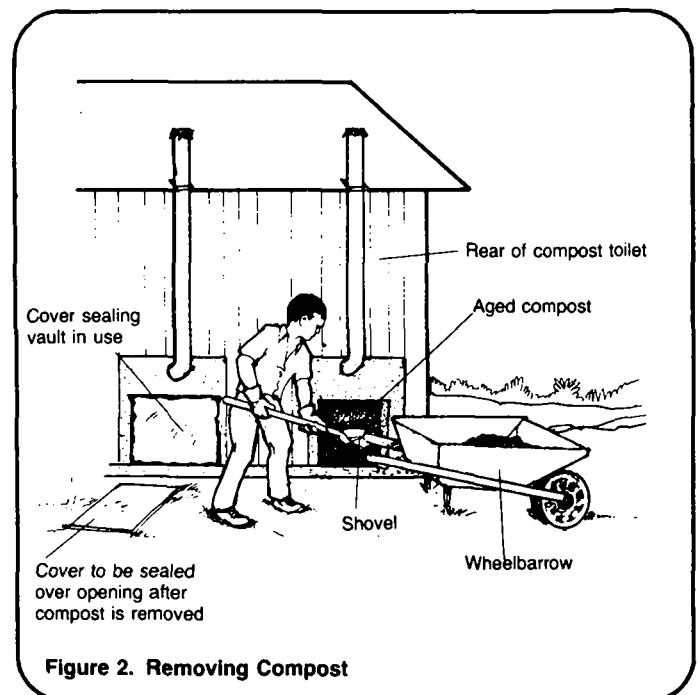
After 6-12 months of use, it will be time to seal this second vault and reopen the first one.

## Removing Compost

Once the contents of a vault have been sealed for 6-12 months, they will turn to compost.

Remove the cover from the rear wall opening of the first vault. Use a hoe or rake and shovel to remove compost from the vault and load it in a wheelbarrow or cart. See Figure 2. Leave a shallow layer of compost in the vault to prepare it for use. Reseal the cover over the rear wall opening.

Cart the compost to a garden or field of crops, shovel it on the ground, and work it into the soil. See Figure 3.



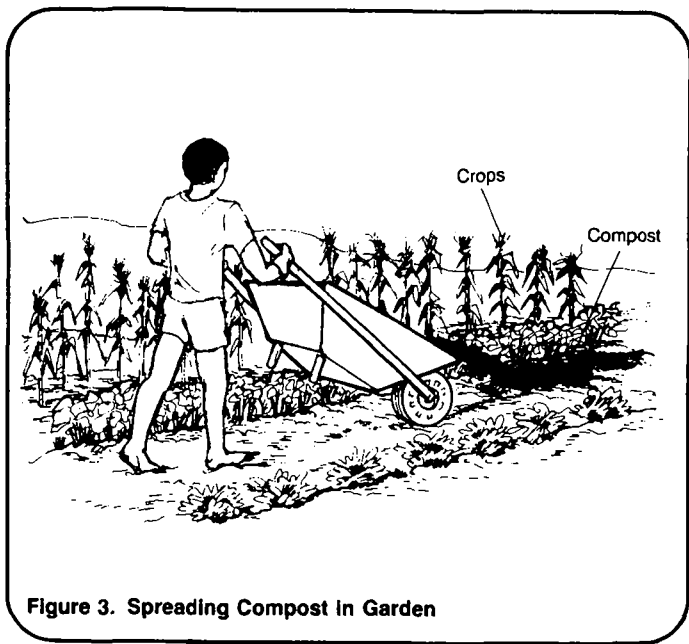


Figure 3. Spreading Compost In Garden

### Maintaining a Compost Toilet

A properly constructed and operated compost toilet will require little or no maintenance. However, you should inspect it once each month for possible damage due to weather or other causes.

Inspect the rear wall covers to be certain they are tightly sealed. If necessary, reseal them with tar or other material. Inspect the base for cracks and repair with concrete mortar. Inspect the privy shelter and vent pipes. Repair or replace damaged parts. Maintain the grounds around the compost toilet, and keep surface water from flowing near it.

Keep a maintenance record similar to the sample shown in Table 1.

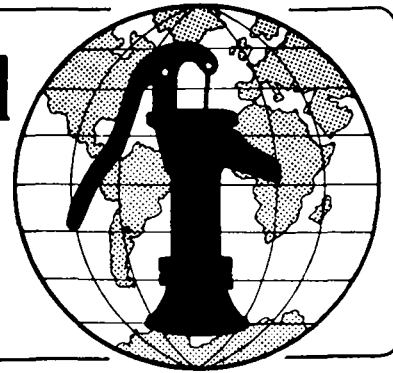
Table 1. Sample Maintenance Record

Date	Task
8/82	Inspected toilet and grounds. Okay.
9/82	Inspected toilet and grounds. Okay.
10/82	Inspected toilet and grounds. Filled in holes - eroded ground near toilet.
11/82	Inspected. Okay.
12/82	Inspected. Repaired vent pipe damaged by wind.
1/83	Inspected. Okay.
2/83	Inspected. Okay.

## Notes

**Technical Notes** are part of a set of "Water for the World" materials produced under contract to the U.S. Agency for International Development by National Demonstration Water Project, Institute for Rural Water, and National Environmental Health Association. Artwork was done by Redwing Art Service. Technical Notes are intended to provide assistance to a broad range of people with field responsibility for village water supply and sanitation projects in the developing nations. For more detail on the purpose, organization and suggestions for use of Technical Notes, see the introductory Note in the series, titled "Using 'Water for the World' Technical Notes." Other parts of the "Water for the World" series include a comprehensive Program Manual and several Policy Perspectives. Further information on these materials may be obtained from the Development Information Center, Agency for International Development, Washington, D.C., 20523, U.S.A.

# Water for the World



## Methods of Combined Washwater and Excreta Disposal

Technical Note No. SAN. 2.M.

Combining excreta and washwater disposal in a single system is an efficient and safe method of disposal that prevents the spread of disease. Combined disposal systems are slightly more expensive and more difficult to construct and maintain than simple methods of excreta disposal. Combined systems are suitable where a piped water supply is available in the home or other place of waste generation. In such locations, all waterborne wastes, including that from toilets, kitchens, baths, and laundry facilities

are piped from the house to the treatment and disposal site. Used with enough water, combined systems are as convenient as pour-flush slabs, flush toilets, or similar facilities.

The four methods of combined disposal are: (1) cesspool, (2) septic tank with subsurface disposal system, (3) septic tank with nonconventional disposal system, and (4) sewer with stabilization ponds. This technical note describes the basic features of each method.

### Useful Definitions

**ANAEROBIC POND** - Stabilization pond that receives sewage from a sewer system and discharges sewage effluent to a facultative pond.

**CONTAMINATE** - To make unclean by introducing an infectious (disease-causing) impurity, such as bacteria from excreta.

**EFFLUENT** - Settled sewage.

**EXCRETA** - Human body wastes

**FACULTATIVE POND** - Stabilization pond that receives sewage effluent from an anaerobic pond or sewer system and discharges treated sewage to a dry ditch or maturation pond.

**GROUNDWATER** - Water stored below the ground's surface.

**MATURATION POND** - Stabilization pond that receives treated sewage from a facultative pond, further treats the sewage, and discharges it to a dry ditch or waterway.

**PERCOLATION** - Movement of water downward through the pores of the soil.

**RETENTION TIME** - The time (usually one to three days) that sewage remains in a septic tank.

**SETTLED SEWAGE** - The liquid that flows out of a septic tank after the solids have separated and settled. Settled sewage is hazardous and must be disposed of in a subsurface absorption system.

**SEWAGE** - All washwater, excreta, and water used to flush excreta that flows from a building or buildings, through a sewer pipe, and into a septic tank, cesspool, or stabilization pond.

**SLUDGE** - Settled solids at the bottom of a septic tank.

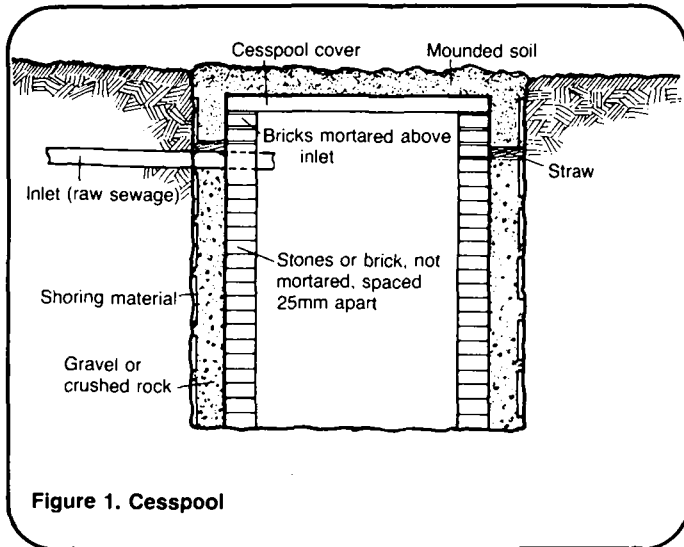
**TOILET** - A bowl filled with water often covered by a lid, and designed to receive excreta and flush it through a pipe to a cesspool, septic tank or sewer.

**TREATED SEWAGE** - The liquid that flows out of a stabilization pond (or series of ponds). Treated sewage is safer than settled sewage and may be used to irrigate crops not intended for human consumption.

**WASHWATER** - Water that has been used for bathing or washing clothes, dishes or kitchen utensils.

## Four Disposal Methods

1. Cesspool. Cesspools, shown in Figure 1, are covered pits, with open-joint or perforated walls, that receive sewage. A cesspool is the least expensive and easiest to construct combined disposal system. Its main features are the inlet and the pit. Sometimes an outlet pipe equipped with a "T" fitting and leading to a subsurface absorption field is added.



The inlet is the end section of sewer pipe which carries sewage from a building to the pit. The pipe and inlet are usually 100mm in diameter.

The pit receives sewage from the inlet. It is generally cylindrical in shape and may be from 2 to 4m deep and 2m in diameter. The pit walls are lined with unmortared stone or concrete blocks below the inlet to allow percolation of the settled sewage out of the pit into the surrounding soil. The pit is covered with a heavy wood, metal, or concrete slab to prevent persons or animals from falling into it. The slab is covered with 150 to 300mm of soil.

Cesspools should not be used where groundwater is the source of water for a village. They should be located downslope at least 60 to 150m from any water supply. In all cases, the bottom of the cesspool should be at least 1.2m above the highest rainy season groundwater level.

Cesspools will eventually fail as they become full of sludge or overflow onto the ground. This failure is caused by the soil's loss of percolation ability as, over time, it clogs up with sludge. Pumping out the cesspool will extend its life for a short time.

2. Septic Tank with Subsurface Disposal System. Septic tank systems cost about one and one half to two times as much as a cesspool and require more skilled labor and more expensive materials. Septic tank systems consist of: (1) a watertight septic tank to settle out the solids and (2) an underground system of jointed or perforated pipes that dispose of the sewage underneath the ground's surface.

The septic tank is a large, underground, waterproof tank made of concrete, brick and mortar, or prefabricated steel with a capacity of 1100 to 3800 liters or more of sewage. The tank receives sewage from the sewer inlet, holds it for a predetermined retention time, then discharges the settled sewage into a subsurface absorption system. The septic tank is large enough to accommodate sewage produced by a home or other building during a 24- to 72-hour period and to slowly discharge it for disposal. During this time, some treatment of the waste materials occurs in the septic tank as the solids settle to the bottom and bacterial action partially decomposes excreta and other organic matter. The tank has at least one manhole to allow for periodic cleaning out of the accumulated sludge. Normally, "T" fittings are placed on the inlet and outlet pipes as shown in Figure 2 to reduce physical disturbance so that the settling process of the solids is not impaired.

The subsurface disposal system (also called soil absorption field or trenches, leachfield, drainfield, seepage bed, seepage pit) consists of either a pit similar to a cesspool, or a shallow field or trench excavation 0.6-1m deep, containing open-joint or perforated pipe in a bed of gravel and covered with soil. The disposal system accepts the settled sewage from the septic tank and disperses it over the entire area of the disposal system for percolation into the soil. The area covered by the subsurface disposal

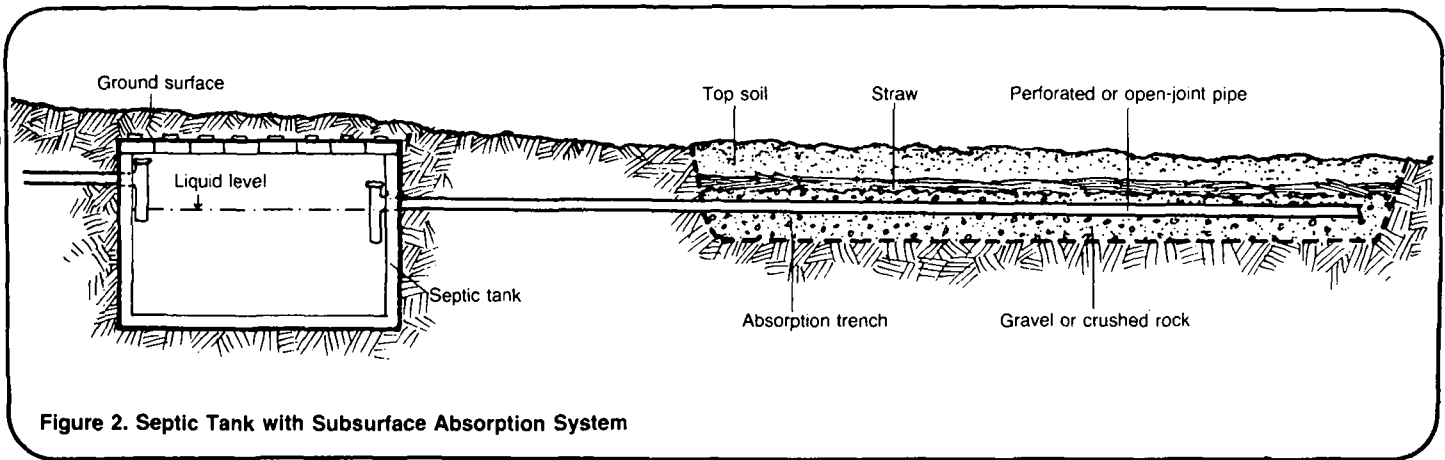


Figure 2. Septic Tank with Subsurface Absorption System

system is determined by the anticipated amount of sewage and by the type of soil.

A septic tank must be cleaned every two to six years, depending on type and amount of sewage, to prevent accumulated sludge from discharging into the disposal field, clogging the soil, and shortening the life of the field. To prevent groundwater contamination, the bottom of the absorption field must be at least 1.2m above highest groundwater levels. A properly maintained septic tank and subsurface absorption field will last 10 to 20 years, or possibly longer.

3. Septic Tank with Nonconventional Disposal System. The septic tank with nonconventional disposal system uses the same septic tank described above, but employs different disposal systems. Special systems are sometimes required

for very porous soils (sand and gravel), for impermeable soils (clay), or where groundwater or bedrock is found near the surface of the ground. The cost of nonconventional systems is high and they are unsuitable for most homes. They may be suitable for community buildings such as health clinics or schools. The three types of nonconventional disposal systems are mound systems, evapotranspiration systems, and sand filters.

Mound systems, shown in Figure 3 are used when groundwater or bedrock lies near the surface of the ground.

By placing the perforated or open-jointed pipe and the gravel bed above ground, and by mounding soil over the top, the necessary 1.2m of suitable soil is maintained between the groundwater or bedrock and the bottom of the disposal field. Some effluent is evaporated through the mound.

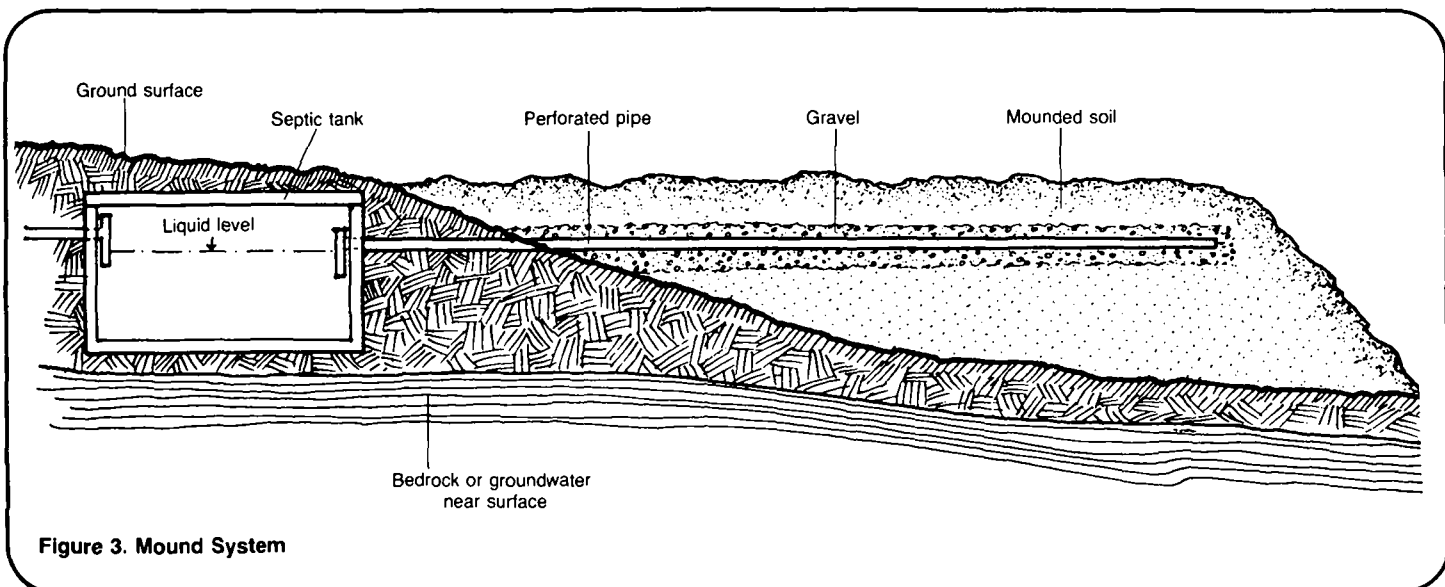


Figure 3. Mound System

Evapotranspiration systems are used when groundwater is near the surface or where the soil is clay. These systems work well in dry, hot climates, but perform poorly in rainy or cold climates.

Evapotranspiration systems rely on evaporation and plant absorption (transpiration) of water to dispose of the effluent. Grasses and other selected plants are planted over the system. This system requires surface areas of three to five times that of conventional disposal systems, but is otherwise similar to a conventional system. If it is used in areas of high groundwater, the system should be underlaid with plastic or other waterproof material to prevent contamination of groundwater supplies.

Sand filters, shown in Figure 4 are used where fractured or creviced bedrock is near the surface of the ground. Normally, the bedrock is excavated or blasted away from the filter location. A bed of filter sand (with optional underdrain) is topped by a bed of gravel with perforated pipe, and the system is backfilled with topsoil.

Sand filter systems require the transport of large quantities of specially selected sand, and also may require the use of explosives. These systems are expensive.

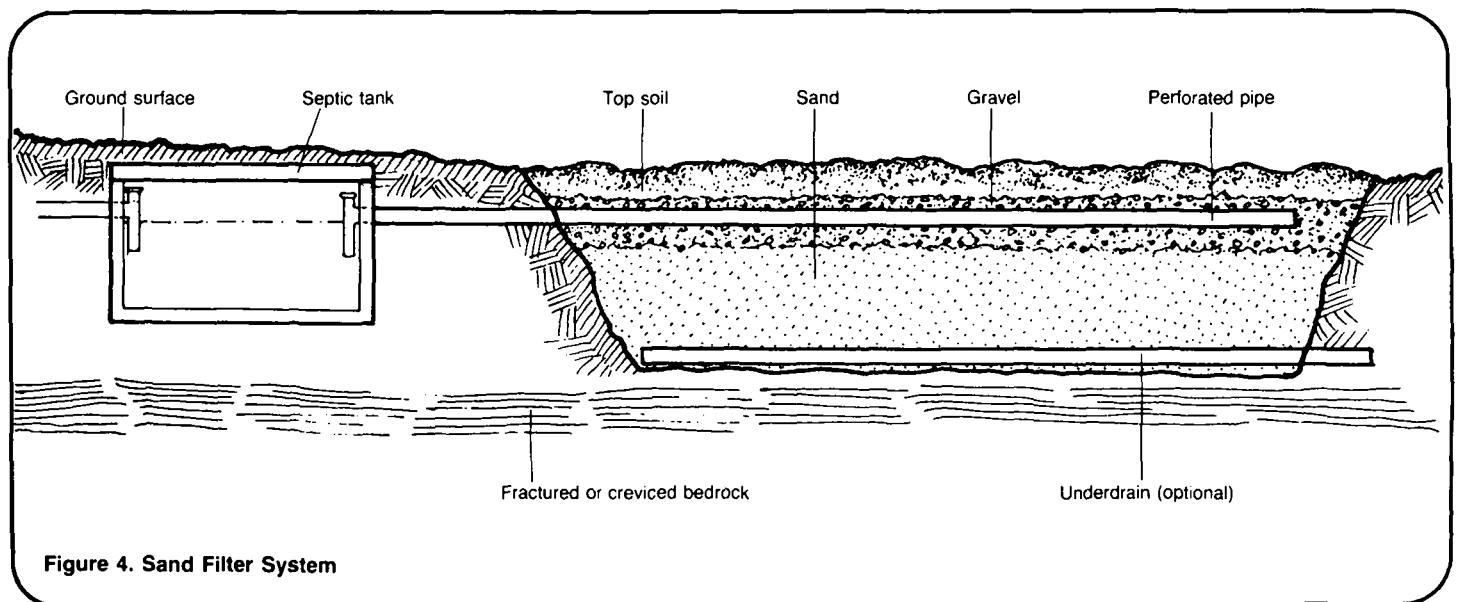
4. Sewer with Stabilization Pond. Sewers and stabilization ponds shown in Figure 5, are the most expensive sani-

tation methods discussed in this technical note. They are community systems, not meant for single homes or even small clusters of homes. Sewers (underground pipes that carry sewage) are designed to reach as many homes as possible in such a way that the collected sewage is carried by gravity downhill to the stabilization pond. The pond itself is specially designed for sewage treatment, and normally has a discharge to use for irrigation of certain crops.

This system requires professional engineering, organized financing, skilled labor, and heavy excavation equipment. Constructed and operated properly, this system can serve communities ranging in size from several hundred to several thousand persons.

Sewers are a collection network of pipes that resemble the branches on a tree with many small pipes coming together into larger ones. The entire sewer system is composed of different sized pipes, all laid at a slight downhill slope to insure gravity flow of the sewage to the stabilization pond. The pond and the sewer system, also called sewerage, must be laid out and designed by an engineer.

If the system takes raw sewage from houses, large diameter sewer pipe must be used. If the system takes settled sewage from individual aqua privies, septic tanks, or cesspools, smaller diameter, less expensive pipe may be used.





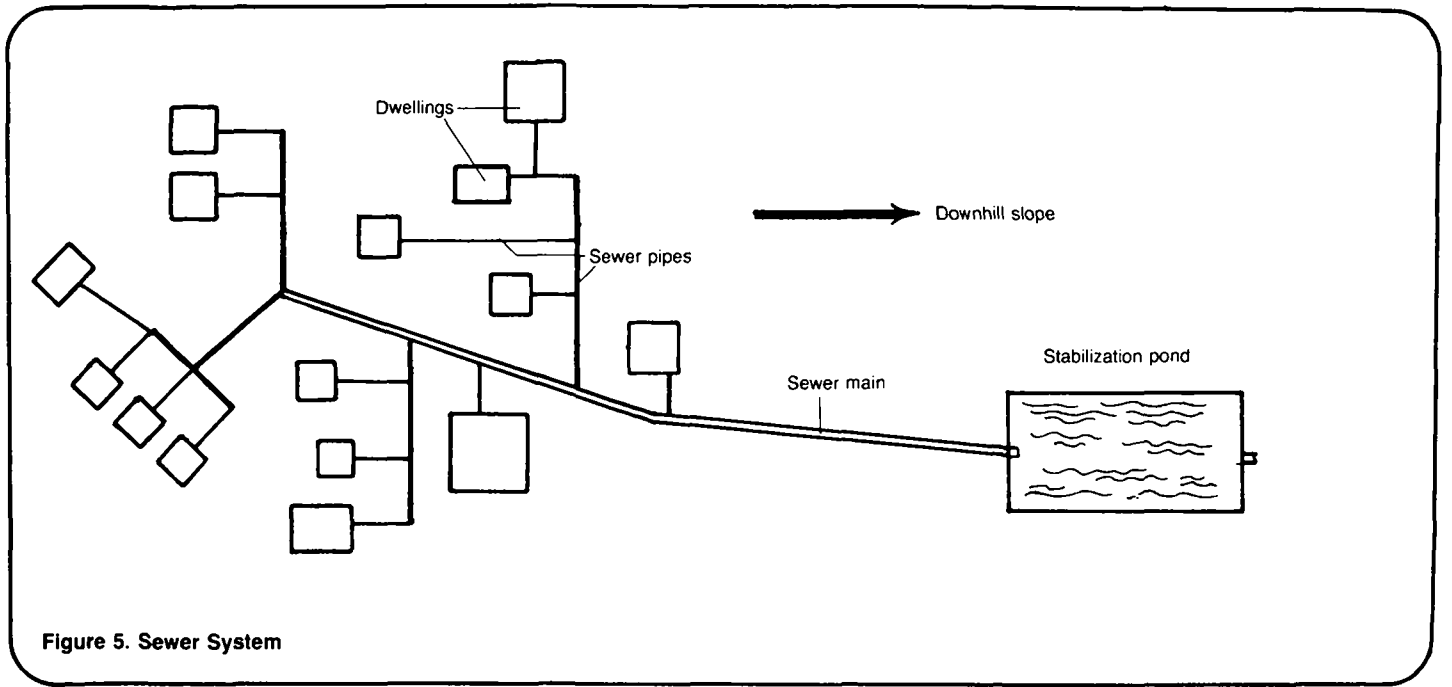


Figure 5. Sewer System

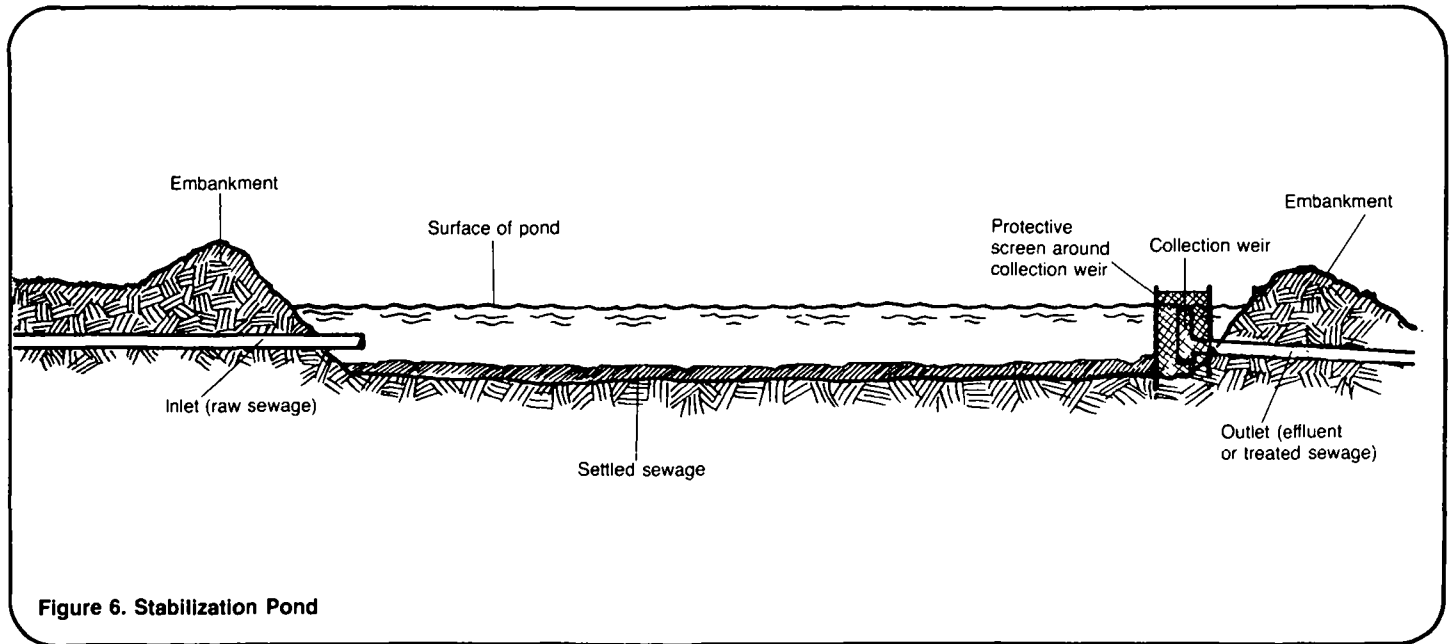


Figure 6. Stabilization Pond

Stabilization pond systems, shown in Figure 6, use a large sewer main pipe to carry the collected sewage to the inlet of the pond. The pond is normally 1m deep and its surface area is large enough to provide a predetermined time for treatment. An average-size pond is 15m wide and 30m long. The treated sewage is continually and slowly drained off to assure the proper retention time.

The stabilization pond treats the sewage biologically: bacteria multiply and consume excreta; algae multiply and consume chemical nutrients. Both bacteria and algae die and are replaced by new organisms; the dead ones settle to the bottom of the pond and accumulate as sludge. The sludge itself is biologically consumed by different bacteria and does not accumulate excessively in a properly designed pond. The treated

sewage that is discharged may be used for irrigation of crops not intended for human consumption. Human contact with treated sewage should be avoided.

Stabilization ponds may be designed in series with each pond providing a cleaner effluent than the previous one. Each pond in a series may have a slightly different design. The first pond, the anaerobic pond, may be slightly deeper, breaking down and removing most of the sludge. The second pond, the facultative pond, is the most common; its size and functions are described above. The third pond, the maturation pond, improves the final effluent. Maturation ponds have been used to grow fish for human consumption. The living fish should be placed in fresh water for two to three weeks before they are eaten.

In addition to receiving sewage from a sewer system, sewage may be brought to a stabilization pond by a bucket latrine worker or scavenger.

Stabilization ponds require skilled operation and maintenance. Aquatic weeds must be controlled to minimize the growth of mosquitoes that carry disease such as malaria and snails that spread schistosomiasis. A fence surrounding the pond must be kept in good repair and the sewers must be maintained. These ongoing costs must be budgeted in the early planning stages of this system. Improperly designed or poorly maintained ponds create offensive odors and effluent that is as hazardous to health as untreated wastewater.

**Table 1. Comparison of Methods of Combined Washwater and Excreta Disposal**

FACTORS	DISPOSAL METHODS				
	Cesspool	Septic tank with subsurface absorption system	Septic tank with nonconventional disposal	Sewer with stabilization pond	Sewer with mechanically aerated pond/lagoon
Design componets	Pit lined with concrete blocks	Septic tank and underground disposal	Septic tank and special disposal	Sewers and ponds	Sewer and aerated ponds/lagoons
Cost	Moderate	Moderately high	High	High	High
Ease of construction	Moderate	Moderately difficult	Difficult	Difficult, requires engineer	Difficult, requires engineer
Materials required	Concrete blocks, mortar, "T" pipe fittings	Concrete and/or concrete blocks, mortar, "T" pipe fittings, drain-field pipe, gravel	Concrete, and/or concrete blocks, mortar, "T" pipe fittings, drain-field pipe, gravel, plastic liner, special sand	Sewer pipe, cleanouts or manholes, valves, inlet and outlet devices	Sewer pipe, cleanouts or manholes, valves, inlet and outlet devices, aerators
Application	Individual and small cluster sites	Individual and small cluster sites	Individual and small cluster sites	Community	Community
Major maintenance required	Sludge removal	Sludge removal	Sludge removal	Weed control, bank erosion, sewer repair and cleaning	Equipment maintenance, weed control, bank erosion, sewer repair and cleaning
Maintenance personnel	Laborer	Laborer	Laborer	Laborer	Electrician/mechanic, laborer
Health issues	Minimal	Minimal	Minimal	May have odors and breed mosquitoes	May have odors and breed mosquitoes
Average life	5-10 years	10-15 years	10-15 years	15 + years	15 + years

The mechanically aerated lagoon is a variation of the stabilization pond. It is equipped with a mechanical aerator, which speeds up the treatment process and requires less area than other ponds. This arrangement is more costly in terms of equipment, required power, and maintenance, but in some communities the smaller land requirements may make a mechanically aerated lagoon feasible.

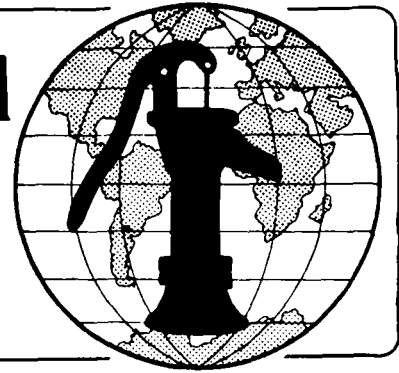
### **Comparison of Methods**

Table 1 summarizes each of the methods of combined washwater and excreta disposal and helps visualize the similarities and differences between each method. It can be used later as an aid in selecting a method (see "Planning Combined Washwater and Excreta Disposal Systems," SAN.2.P.1).

## Notes

**Technical Notes** are part of a set of "Water for the World" materials produced under contract to the U.S. Agency for International Development by National Demonstration Water Project, Institute for Rural Water, and National Environmental Health Association. Artwork was done by Redwing Art Service. Technical Notes are intended to provide assistance to a broad range of people with field responsibility for village water supply and sanitation projects in the developing nations. For more detail on the purpose, organization and suggestions for use of Technical Notes, see the introductory Note in the series, titled "Using 'Water for the World' Technical Notes." Other parts of the "Water for the World" series include a comprehensive Program Manual and several Policy Perspectives. Further information on these materials may be obtained from the Development Information Center, Agency for International Development, Washington, D.C., 20523, U.S.A.

# Water for the World



## Planning Combined Wastewater and Excreta Disposal Systems Technical Note No. SAN. 2.P.1

Combined wastewater and excreta disposal systems may be appropriate where large quantities of wastewater are generated and where resources are sufficient to establish and maintain such systems. The advantages of combined systems are a high degree of sanitary protection and the capability to handle greater water use in the future. The disadvantages are the high capital costs and the need for routine maintenance. The purpose of planning combined systems is to determine their suitability and specific nature.

Planning combined systems involves setting goals, then establishing step-by-step procedures toward those goals. There are eight major actions involved in project development for which planning is important. It is necessary to: (1) recognize the problem, (2) organize community support and set objectives, (3) collect data, (4) formulate alternatives, (5) select the most suitable method, (6) establish the system, (7) operate and maintain the system, and (8) evaluate the system.

This technical note discusses planning and implementation of these eight activities. Read the entire technical note before beginning the planning process. Worksheet A may be adapted for use in cataloging information collected as planning proceeds.

### Recognize the Problem

This is done by gathering information from regional and national governments, questioning villagers and village leaders, and observing actual conditions in the field. Decide if the present methods of excreta and wastewater disposal pose a health hazard to the people in the community. That is, determine whether the people suffer from disease caused by poor sanitation.

(See "Means of Disease Transmission," DIS. 1.M.1). In general, the community should consider combined wastewater and excreta disposal systems if the answer is "yes" to the following questions.

Yes/No	Are piped water supplies the major source of community water?
Yes/No	Does the community generate 50 liters or more of wastewater per person per day?
Yes/No	Are present methods of excreta and wastewater disposal creating health hazards?
Yes/No	Do children or adults suffer from illnesses related to water supply or sanitation?

When the problem has been identified as unsanitary, improper, or inefficient disposal of excreta or wastewater, then goals can be set to solve the problem.

### Organize Community Support and Set Objectives

The main goal is to establish an effective system of excreta and wastewater disposal. This is a major step toward improving the health of the community.

This goal cannot be met without strong community support (see "Methods of Initiating Community Participation in Water Supply and Sanitation Programs," HR.2.M). Establish close working relations with community leaders and organizers. Actively solicit their ideas and suggestions. The people in the community should be involved from the start of the project, because all stages of the project must be understood and accepted by them.

**Worksheet A. Planning a Combined Excreta and Washwater Disposal System**

1. Problems indicating a need for action are:

- (1) \_\_\_\_\_
- (2) \_\_\_\_\_
- (3) \_\_\_\_\_

2. Community support will be organized and directed by (name and position):

- (1) \_\_\_\_\_
- (2) \_\_\_\_\_
- (3) \_\_\_\_\_

2. a. Major objectives of the program are:

- (1) \_\_\_\_\_
- (2) \_\_\_\_\_
- (3) \_\_\_\_\_

3. Data which will influence decisions are:

- (1) Need: \_\_\_\_\_
- (2) Present Methods: \_\_\_\_\_
- (3) Community Acceptance: \_\_\_\_\_
- (4) Resources: \_\_\_\_\_
- (5) Geography: \_\_\_\_\_

4. Alternatives to be considered are:

- (1) \_\_\_\_\_
- (2) \_\_\_\_\_
- (3) \_\_\_\_\_

5. The method(s) selected is (are):

- (1) \_\_\_\_\_
- (2) \_\_\_\_\_
- (3) \_\_\_\_\_

6. The system will be established by:

- (1) Ensuring public acceptance by building demonstration models or by: \_\_\_\_\_
- (2) Submitting plans to (government or lending agency): \_\_\_\_\_
- (3) Obtaining financing from (government, lending agency, or other): \_\_\_\_\_
- (4) Planning the construction within \_\_\_\_\_ weeks.
- (5) Constructing the system within \_\_\_\_\_ months.

7. The operation and maintenance of the system will be supervised by (name and position):

- (1) \_\_\_\_\_
- (2) \_\_\_\_\_
- (3) \_\_\_\_\_

8. The system will be evaluated during (month and year) \_\_\_\_\_, by (name and position):

- (1) \_\_\_\_\_
- (2) \_\_\_\_\_
- (3) \_\_\_\_\_

Another part of the main goal is setting secondary goals such as a time span for establishing the system (for example, three months or one year). Secondary goals should be set with the participation and agreement of community leaders. Be realistic when setting objectives. Consider local customs and resources such as money, material, and talent. Do not set goals that may be impossible for the community to reach. Set goals that are definite and can be measured, so people will know when they have reached them. For example: build three septic tanks with subsurface absorption systems within six months; or, provide effective excreta and washwater disposal systems to half the families in the village in one year.

Your goals must: (1) clearly state what the project will accomplish, (2) state the methods that will be used, and (3) specify when these accomplishments will be made. At the end of the specified length of time, it should be possible to determine whether your objectives have been met.

When the objectives have been set, proceed with the next step in planning; data collection.

## Collect Data

To plan the system you must have correct data. The data can be divided roughly into five categories: (A) environmental conditions in the village, (B) present methods of excreta and washwater disposal, (C) attitude of the people, (D) resources, and (E) geography. Collecting data will be an ongoing process; some of it will be used now, some later.

Keep a written record of all data collected. Some data will be specific (for example, number of persons living in a dwelling, or a family's source of drinking water). Other data will be more general (for example: villagers' attitudes toward new methods of excreta disposal). Use the following checklist to help organize data collection.

### A. Environmental Conditions in the Village

- 1. Determine the incidence of disease associated with poor sanitation (see "Means of Disease Transmission," DIS.1.M.1) by personal observation, questioning villagers and village leaders, and checking health records if available. Local health clinics may have this information.
- 2. Observe and record evidence of excreta or washwater on the surface of the ground.
- 3. Determine whether excreta or washwater is being disposed of in or near sources of drinking water. Do this by questioning villagers and by personal observation.
- 4. Determine whether there are bothersome numbers of flies or mosquitos.
- 5. Determine whether there are foul odors.

### B. Present Methods of Excreta and Washwater Disposal

- 1. List the present methods of excreta and washwater disposal.
- 2. Determine how many of each method are in use.
- 3. Determine how many people use each facility.
- 4. Determine whether the present method can be upgraded or converted to those methods listed in "Methods of Combined Washwater and Excreta Disposal," SAN.2.M.

### C. Attitude of the People

- 1. Question the villagers and village leaders about their attitudes toward excreta and washwater disposal in general.
- 2. Question villagers and village leaders about their preferences concerning specific excreta and washwater disposal methods.
- 3. Identify local customs and taboos.

## D. Resources

- 1. List sources of money (government grants, taxes, general fund, and so on) and amounts available.
- 2. List types and quantities of available tools and equipment.
- 3. List types and quantities of available materials.
- 4. List the names and special skills of available skilled workers.
- 5. List the names of available unskilled workers.

## E. Geography

- 1. Record the type (well, spring, stream, piped), number, and location of all drinking water supplies.
- 2. Test and record soil conditions for suitability for excreta and wash-water disposal (see "Determining Soil Suitability," SAN.2.P.3).
- 3. Determine and record groundwater levels for the wettest season.
- 4. Record the number of villagers and the physical size of the village.
- 5. Record the number of family lots, the size of each lot, and the number of people per lot.

## Formulate Alternatives

Use the collected data and the information in "Methods of Combined Washwater and Excreta Disposal," SAN.2.M, to formulate alternative systems of excreta and washwater disposal. Each alternative may be a single method or several methods combined. When formulating alternatives, use only those methods that are practical for your community and are basically acceptable to the community members. Reject those methods which, for any reason, are inappropriate, impractical, or unacceptable.

The remaining alternatives are possible solutions to the problem. To determine the best method for your situation, proceed to the next step: selecting a method.

## Select a Method

When selecting a method of combined washwater and excreta disposal, carefully study the features of each alternative and thoroughly analyze the collected data. The selection of a method should be based on the following considerations:

Need. Are present methods of excreta and washwater disposal inadequate? Do people in the community suffer from disease caused by poor sanitation? Are large quantities of washwater being generated?

Social acceptability. This is a most important consideration, for if the system is unacceptable to the people, it will surely fail. Will the method of disposal violate local customs, taboos, or preferences? Is the method likely to be maintained? Have the people indicated that they prefer this system, or at least are willing to try it?

Resources. Is the desired method practical considering available money, material, and workers? Is the regional or national government likely to provide monetary or other assistance?

Geography. Are soil conditions and groundwater levels acceptable for the desired method?

Plot size. Is the plot large enough to support an on-site system (at least 0.1 hectares)?

Washwater. Is the quantity of washwater more or less than 50 liters per person per day?

Use the comparison chart in "Methods of Combined Washwater and Excreta Disposal," SAN.2.M, and Table 1 to help select a method of combined washwater and excreta disposal. This decision table is not meant to be followed strictly; it is merely an aid in selecting a system. If you need more specific information on the features of any method, consult the "design" or "construction" technical notes dealing with that particular method.



**Table 1. Decision Table for Selecting a Combined Excreta and Washwater Disposal System**

If	And	And	And	Then
Existing excreta disposal systems are NOT creating health hazards, or washwater does NOT exceed 50 liters per person per day, or combined excreta and washwater systems are NOT affordable				Go to Simple Excreta Disposal (see SAN.1.M.1 SAN.1.M.2 SAN.1.P)
Existing excreta disposal systems are creating health hazards, or washwater exceeds 50 liters per person per day and combined excreta and washwater systems are affordable	Plot size is large enough for on-site systems (at least 0.1 hectares)	Soil suitable for on-site system	Septic tank affordable	Septic Tank with Sub-surface Absorption System
			Septic tank NOT affordable	Cesspool
		Soil NOT suitable for on-site system	Nonconventional on-site systems are affordable and necessary (i.e., building is a health clinic, restaurant, etc.)	Nonconventional On-site Systems
			Nonconventional systems NOT affordable or necessary	Go to Simple Excreta Disposal
	Plot size NOT large enough for on-site systems (less than 0.1 hectares)	Aqua privies or pour-flush latrines can be upgraded into a sewer system	Enough land for a series of ponds	Sewers with Stabilization Ponds
			NOT enough land for a series of ponds	Sewers with Mechanically Aerated Lagoons
		Aqua privies or pour-flush latrines CAN NOT be upgraded into sewer systems		Go to Simple Excreta Disposal

**How to Use the Decision Table**

1. Find the statement in the "If" column that best describes your situation. If it is the top statement, go to "Methods of Simple Excreta Disposal," SAN.1.M.1 or "Method of Washwater Disposal," SAN.1.M.2.

2. If it is the bottom statement, move to the two adjacent boxes in the first "And" column and select the statement that best fits your situation.

3. From your statement in the first "And" column, move on to the two

adjacent boxes in the second "And" column and select the statement that best fits your situation.

4. From your statement in the second "And" column, move on to the two adjacent boxes in the third "And" column and select the statement that best fits your situation.

5. From your statement in the third "And" column move on to the adjacent box in the "Then" column to find the recommended method of wash-water and excreta disposal.

## Establish the System

There are three steps in establishing the system: involving the public, submitting your plan for approval, and planning for construction.

Involving public. The first step in establishing the system is gaining public acceptance. Set up community meetings to fully explain the proposed system. It may be worthwhile to build several excreta disposal methods for demonstration. These will allow the people to examine, understand, and use the facilities. These demonstration models can serve as a final test of community acceptance before you construct large numbers of facilities.

Submitting plan for approval. The second step in establishing the system is submitting your plan to the regional or national government or a lending agency. Since they may have to approve the entire plan before you can proceed, your submission should include: (a) the proposed technical system, (b) costs, (c) sources of finance, and (d) an implementation schedule.

a. Proposed system. Submit designs, complete with drawings or photographs, of the method or methods selected. Decide how many units will be built and where they will be located. Be prepared to explain your decisions. Draw a map, perhaps a contour map, of the village and surrounding area. Include dwellings, sources of drinking water, and present and proposed locations of excreta and washwater disposal systems. Use the design drawings and maps in a presentation to the government agency or funding source. Bring village leaders, or others who speak for the community, to help explain the need for the project.

b. Costs. Determine how much money will be needed to pay construction workers. This will depend on salary levels, number of workers, and estimated time for construction. Determine how much money will be needed for materials, tools and equipment. Make every effort to use locally available materials. Estimate how much money will be needed to maintain and repair the system for a specific period of time--one year, for example.

c. Sources of finance. Funds may be available locally, nationally, and internationally. Your government can explain how to get national or international funds, which can be in the form of grants or loans. Local funds can come from taxes, user fees, or a general fund. The tax can be a special tax or an increase of an existing tax. Two user fees examples are: (1) charging villagers a monthly fee for using community latrines, or (2) charging families for all or part of the construction costs for individual systems. The general fund could be a health fund, with the purpose of improving water supplies and sanitation, into which everyone in the village pays a certain amount.

Determine the villagers' ability and willingness to pay for building the excreta and washwater disposal systems. It may be that local funds will not take the form of money, but rather of contributions of labor or materials. For example, villagers wanting septic tanks could be required to contribute all of the unskilled labor, plus the sand and gravel necessary for building the concrete tank. A government contribution or subsidy could be made contingent upon completion of the local contribution. For example, the government could supply the perforated pipe for the absorption field, but only after the villagers had constructed the septic tank.

Find out if the people are willing to pay for operating and maintaining the system once it is built. A great many systems fail because they are not properly operated and maintained and often this occurs because people are unwilling to pay these costs. If you do not take this into account, you may wind up with a system that will not work.

d. Implementation schedule. Assign specific, reasonable time spans to each stage of the project. Allow time to collect data, formulate alternatives, select a method, establish the system, and train workers to operate and maintain the system. To help visualize an entire project and establish timetables for it, draw a chart similar to Figure 1 with the month number across the top and the specific tasks on the left

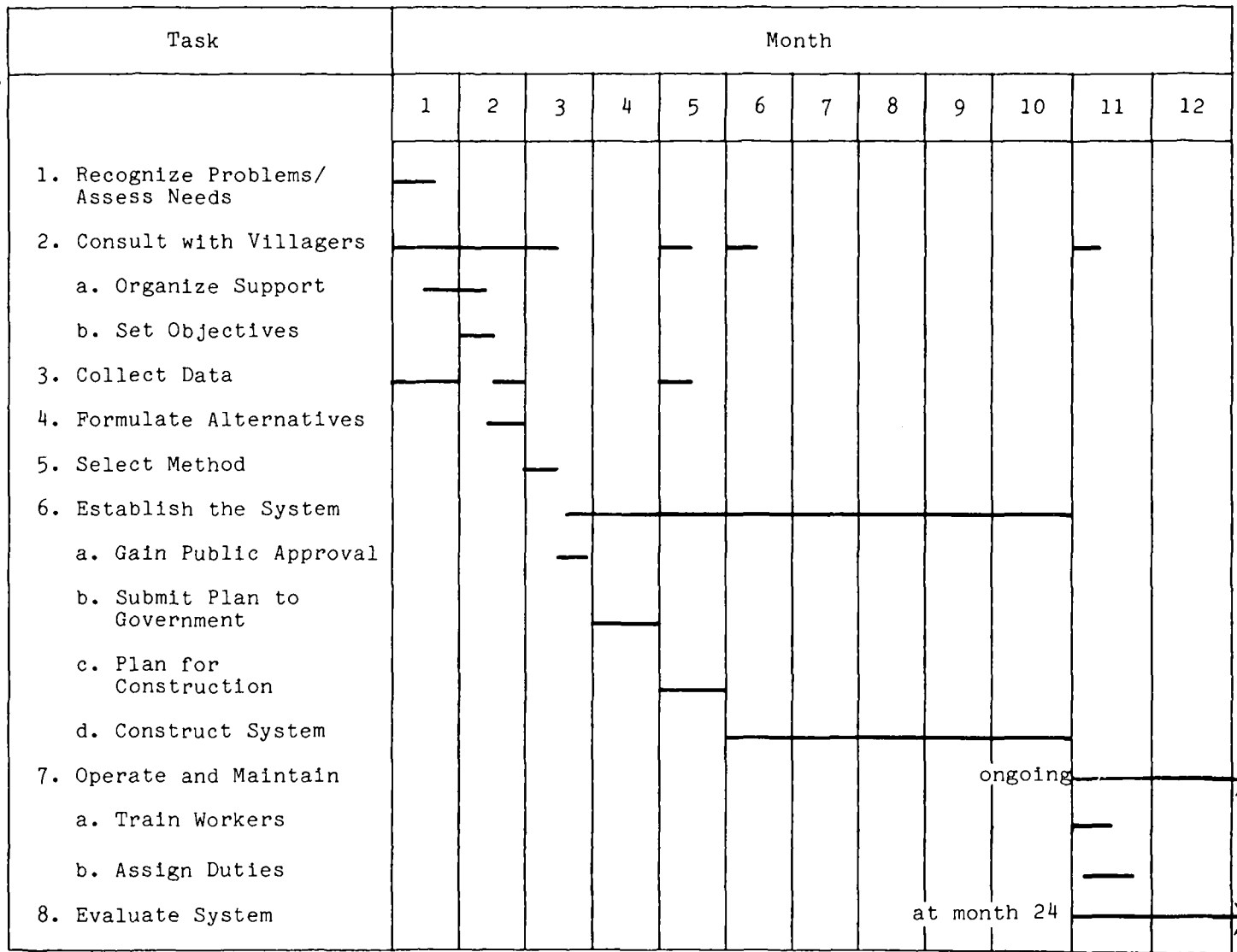


Figure 1. Sample Schedule for a Combined Excreta and Washwater Disposal Project

side. Figure 1 also includes tasks performed from the start of the project such as recognizing problems, consulting with villagers, and early collection of data.

**Planning for construction.** The third step in establishing the system is planning for construction. Determine which components of the excreta disposal system can be constructed in the community, perhaps the septic tank, and which components will have to be purchased from outside the community, perhaps the sewer pipe.

Decide who will do the work, the type and amount of training they will require, and how much they must be paid. Determine which tools, equipment, and materials are needed for construction, and be prepared to

assemble them. Organize the construction. Be prepared to assign specific duties, set up time schedules, and hire a foreman to oversee the work.

### Operate and Maintain the System

It is critical that you plan for the continued use of the facilities after they are built. This includes inspecting and, if necessary, repairing septic tanks, cesspools, stabilization ponds, sewer lines, and subsurface absorption systems. Maintenance includes periodically removing and safely disposing of sludge from septic tanks, cesspools, and stabilization ponds.

Establish a system of routine cleaning, maintenance, and repair. Workers must be trained, and money and

materials must be made available to maintain the system. If these systems are not routinely maintained, they will fail to operate.

### Evaluate the System

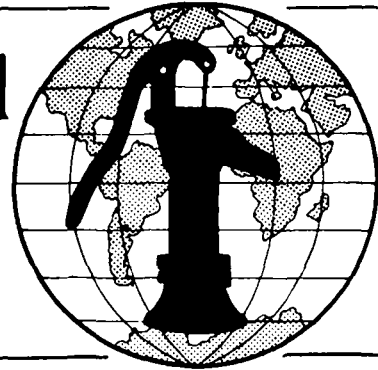
Evaluate the project one year after completion to determine whether project goals have been achieved. Determine the success of the project by: (1) questioning villagers on their use or neglect of the facilities; (2) comparing before and after health aspects (examine individuals and study health statistics, if available); and (3) comparing the conditions of the facilities with the conditions existing before the

project began. One excellent way of telling whether or not people have been using the facilities is the incidence of Ascariasis (roundworm) in children. Determine if old problems have been eliminated, and decide if any new problems have arisen. Perhaps the village now needs and can afford a more advanced system of excreta and wash-water disposal, such as septic tanks instead of cesspools.

Sanitation improvements in rural villages are usually made one step at a time. Therefore, your evaluation of this project should be the first step in planning the next sanitation improvement.

**Technical Notes** are part of a set of "Water for the World" materials produced under contract to the U.S. Agency for International Development by National Demonstration Water Project, Institute for Rural Water, and National Environmental Health Association. Artwork was done by Redwing Art Service. Technical Notes are intended to provide assistance to a broad range of people with field responsibility for village water supply and sanitation projects in the developing nations. For more detail on the purpose, organization and suggestions for use of Technical Notes, see the introductory Note in the series, titled "Using 'Water for the World' Technical Notes." Other parts of the "Water for the World" series include a comprehensive Program Manual and several Policy Perspectives. Further information on these materials may be obtained from the Development Information Center, Agency for International Development, Washington, D.C., 20523, U.S.A.

# Water for the World



## Estimating Sewage or Washwater Flows

Technical Note No. SAN. 2.P.2

Estimating how much sewage or washwater will flow from a home, communal latrine, or public building is an essential part of planning and designing sewage or washwater disposal systems. Making this estimate involves identifying the source or sources of the flow, then determining the probable daily flow by one or more of five methods. The result is a flow estimate expressed in liters per day or gallons per day.

Sewage or washwater flow from a single building or an entire community cannot, and need not, be calculated to the exact liter. There are too many variables involved. Among them are growth in the size of a community; seasonal variation in the number of people living in a community; and changes in the number of people living in each household. There are several methods that, when used carefully, provide estimates accurate enough to design on-site or community sewage or washwater disposal systems. The five methods are on-site measurement; on-site estimating; water meter estimates; community water use data; and survey estimating.

This technical note describes these five methods of estimating sewage or washwater flows. Read the entire technical note before making estimates.

## Materials Needed

Container with a known capacity  
Measuring tape or ruler

## Useful Definitions

**FLOW** - The amount of sewage or washwater that moves through a pipe in a given time, usually expressed as liters per second.

**GROUNDWATER** - Water stored below the ground's surface. Groundwater levels affect seepage into sewer pipes and may increase flow.

**SEWAGE** - All washwater, excreta, and water used to flush excreta that flows from a building or buildings, through a sewer pipe, and into a septic tank, cesspool, or stabilization pond.

**STANDPIPE** - A pressurized water outlet or faucet located outdoors.

**WASHWATER** - Water that has been used for bathing or washing clothes, dishes, or kitchen utensils.

## On-site Measurement

If water is hand-carried into the building, multiply the capacity of the container by the number of trips per day with the filled container to calculate the daily flow.

capacity of container x trips per day = daily flow

If water is piped into the building or home, measure the capacity of each sink, wash basin, and water seal latrine and multiply each capacity by the number of times each fixture is filled during the day. By "filled," we

mean to the level in the container that is normally reached for washing dishes or clothes, or for bathing. Do not measure to the brim as that is not the level normally used. Add the quantities to find the total daily flow.

capacity of wash basin x use per day  
= volume a

capacity of water seal latrine x use  
per day = volume b

capacity of sink x use per day =  
volume c

capacity of other (water closet,  
bathtub) x use per day = volume d

Volumes a + b + c + d = daily flow

(NOTE: For a more accurate measurement, calculate the daily flow for three consecutive days and divide the total by three.)

To calculate the capacity of a wash basin, tub, latrine, sink, or water closet using a container of known capacity, fill the container with water to the level of use and pour it into the fixture. Repeat until the fixture is full or until the pour-flush latrine has flushed. Multiply the number of times the container was used by the capacity of the container to find the capacity of the fixture.

number of uses x capacity of container  
= capacity of fixture.

If you do not know the capacity of the container or fixture you can calculate it with a measuring tape. First, measure the length, width, and depth of the container in millimeters. Then, multiply the length times the width times the depth to calculate the capacity in cubic millimeters. Finally, multiply the cubic millimeters by 0.00001 to find the capacity in liters.

length x width x depth x 0.00001 =  
liters

For a cylindrical container, such as a bucket, first measure the diameter at the top in millimeters and divide by two. Second, multiply that number times itself. Third, multiply the result of the second step by 3.1.

Fourth, multiply the result of the third step by the depth of the container to find the capacity in cubic millimeters. Finally, multiply cubic millimeters by 0.00001 to find capacity in liters.

$\frac{\text{diameter}}{2} \times \frac{\text{diameter}}{2} \times 3.1 \times \text{depth} \times$   
0.00001 = liters

If a shower is used, calculate the amount of washwater per shower by filling a container of known capacity with water from the shower head and timing how many minutes it takes. Divide that number of minutes into the number of minutes it takes a person to shower; multiply the result by the capacity of the container. If the length of the shower is not known, use five minutes as a reasonable estimate. It may be necessary to take into account the number of showers per day, a figure that varies from person to person and country to country.

$\frac{\text{minutes per shower}}{\text{minutes to fill container}} \times \text{capacity}$   
of container = amount used per shower.

Example. The daily flow of washwater from a family dwelling must be estimated. The dwelling has a kitchen sink, used to wash dishes and pots, and a wash basin, used to wash clothes. The size and frequency of use of each fixture is:

Sink: 8 liters, filled three times  
each day;

Wash basin: 30 liters, filled once  
each day.

The daily flow = 8 liters x 3 = 24  
liters + 30 liters x 1 = 30 liters.  
The daily flow = 54 liters per day.

### On-site Estimating

This method is similar to on-site measurement, except that the following tables are used to estimate quantities instead of measuring the capacity of each fixture and documenting the frequency of use. While this method is simpler to use than on-site measurement, it is not as accurate.

**Table 1. Water from Standpipe**

Country	Water Use Per Person Per Day (in Liters)*
Africa	15-35
Southeast Asia	30-70
Western Pacific	30-95
Eastern Mediterranean	40-85
Algeria-Morocco-Turkey	20-65
Latin America/Caribbean	70-190

\*Averages are for areas where water is handcarried from standpipes no more than 200m distant.

For example, suppose water for a six-person dwelling in Southeast Asia is hand-carried from a standpipe 30m distant. Using Table 1 the daily flow = 70 liters x 6 = 420 liters per day.

**Table 2. Sewage or Washwater Per Fixture**

Fixture	Amount Per Use (in Liters)
Pour-flush Latrine	1-3
Tank-type Flush Toilet	13-23
Wash Basin	5
Shower	95-120
Kitchen Sink	15-18
Laundry Sink (wash/rinse)	150-190

If there is doubt as to which number to use in Table 2, use the higher number. When using Table 2, first determine the number of times each fixture is used per day. For example, suppose the pour-flush latrine is used 18 times, the wash basin six, the kitchen sink three, and the laundry sink once. Then the daily flow is:

Pour-flush latrine = 3 liters x 18 = 54 liters, plus:

Wash basin = 5 liters x 6 = 30 liters, plus:

Kitchen sink = 18 liters x 3 = 54 liters, plus:

Laundry sink = 190 liters x 1 = 190 liters, equals:

The daily flow = 328 liters per day.

**Table 3. Sewage Flow by Building Type**

Building Type	Amount Per Person Per day (in Liters)
Private Home (full plumbing)	150-300
Public Buildings (toilets/sinks)	11-38
Communal Latrines	40

If there is doubt as to which number to use in Table 3, use the higher number. When using Table 3, first determine the type of building and the number of persons living in or using the building. For example, suppose a school has 40 pupils and three teachers for a total of 43 persons.

Then the daily flow = 43 x 38 liters = 1634 liters per day.

### Water Meter Estimates

If water is piped to a building equipped with a water meter, take two meter readings one week apart, subtract the first reading from the second, and divide by seven to estimate the daily flow. The meter readings should be made on days of typical usage, not holidays or other times of slack use.

$$\frac{\text{second reading} - \text{first reading}}{7} = \text{daily flow}$$

For example, suppose the first reading is 001587 and the second reading, one week later, is 003771.

$$\begin{aligned} \text{Then the daily flow} &= \frac{003771 - 001587}{7} \\ &= \frac{2184}{7} \\ &= 312 \text{ liters per day} \end{aligned}$$

If some of the water piped to the building is used for watering a garden or farm animals, this amount must be estimated and subtracted from the water meter estimate since this water will not enter the sewage disposal system. To estimate the amount used for garden or animal watering, use the on-site measurement method. If a hose is used for watering, estimate the flow by the same means described for a shower.

$$\text{meter estimate} - \text{watering estimate} = \text{daily flow.}$$

For example, suppose that the water meter estimate shows the daily flow to be 400 liters per day, but 100 liters per day is used for watering.

$$\text{The daily flow} = 400 \text{ liters} - 100 \text{ liters} = 300 \text{ liters per day.}$$

(NOTE: If a single disposal system is to serve more than one building, add the daily flow of each building to find the total daily flow. Flow from building A + flow from B + flow from C = total daily flow.)

that will not enter the sewage disposal system, such as water for crops, community fire control, and street flushing, must be subtracted from the department's or company's daily flow estimate. The flows should be totalled for 30 consecutive days and the total divided by 30 to estimate the daily flow.

$$\frac{\text{30-day community water} - \text{30-day other use}}{30} =$$

community daily flow

For example, the water company's records show that for a community of 100 buildings the total 30-day output of water is 724000 liters. A portion of this water is diverted to a community agricultural field and a water meter at the diversion point shows that the 30-day total for watering crops is 120000 liters. The only other major use of water is street flushing; once each month a 4000-liter truck is filled and used to flush the main streets.

$$\text{The 30-day flow} = 724000 \text{ liters} - 120000 \text{ liters} - 4000 \text{ liters} = 600000 \text{ liters.}$$

$$\begin{aligned} \text{The daily flow} &= \frac{600000 \text{ liters}}{30} \\ &= 20000 \text{ liters per day.} \end{aligned}$$

This is the figure to use in designing the community disposal system.

## Community Water Use Data

This method is appropriate only for planning community sewage disposal systems. It can be used if the community is served by a water department or a water distribution company. The records kept by the department or company are used to estimate the daily flow for the entire community. Water

## Survey Estimating

This method involves collecting data from every dwelling, building, and communal latrine in the community. It is time-consuming but may be the only practical way to estimate sewage flows in an area where water meters and water company data are not available or are not trustworthy.



If the community is too large to make house-to-house data collection practical, it may be necessary to survey one building in five, or one in ten. This must be a representative sampling, including both large and small dwellings, dwellings both with and without piped water, and both public buildings and private homes.

The data may be obtained by any combination of the first three methods discussed. For example, some buildings may have water meters; people in buildings without meters may provide water use estimates; residents may provide only general information; they may hand-carry water to the dwelling and be able to report how much they carry.

After each dwelling, building, and communal latrine in the community has been surveyed, tabulate the results for each and add them together to find the total daily flow of sewage for the community.

Example. Suppose there are five dwellings and one public building in the community, and the following data is obtained:

Building 1 is a public building with piped water and a water meter, and the flow estimate from meter readings is 1000 liters per day. This number will be written on Line 1 of Worksheet A.

Building 2 is a residence with piped water and no meter but the head of the household provided a daily flow estimate of 450 liters. (Worksheet A, Line 2.)

Building 3 is a residence with piped water and no meter. The residents could not provide a daily flow estimate, but they did estimate the number of times each fixture in the house was used each day: pour-flush latrine, 18 times; wash basin, 12 times; shower, 3 times; kitchen sink, 3 times; and laundry sink, once per day. These numbers are written in on the proper lines (between Lines 2 and 3). Calculations are made on a separate sheet of paper using Table 2. The total flow is

calculated to be 718 liters per day. (Worksheet A, Line 3.)

Building 4 is a residence with piped water, no meter, and the residents provided no information. There are two persons living in the house. Write this number on the proper line (between Lines 3 and 4) and use Table 3 to estimate the daily flow: 600 liters. (Worksheet A, Line 4.)

Building 5 is a residence and water is hand-carried from a standpipe 30 meters away. The water carrier provided an estimate of 10 trips per day with a 20-liter container. The daily flow is 200 liters. (Worksheet A, Line 5.)

Building 6 is a residence and water is hand-carried from a standpipe 20 meters away. The water carrier provided no information. There are three persons living in the dwelling. Using Table 1, Western Pacific, the estimate flow is 285 liters per day. (Worksheet A, Line 6.)

The total daily flow for the community is the sum of Lines 1, 2, 3, 4, 5, and 6. The total is 3253 liters per day.

## Other Factors in Making Estimates

Data from Nearby Communities. Other communities in the area may have already installed on-site or community sewage disposal systems similar to the types under consideration. Study their successes and failures and apply the data, if applicable, to your situation.

Groundwater Seepage into Sewer. While this is not a subject for the survey, it will affect the total community sewage estimates when used to determine the size of stabilization ponds. Groundwater seepage into a well-constructed sewer system probably will be 84-210 liters per centimeter of pipe diameter per kilometer of pipe length per day. If the sewer pipes are in normally dry soil, use the lesser estimate.

**Worksheet A. Sewage Flow Survey Form**

	Building Number					
	1	2	3	4	5	6
<b>Building Type</b>						
Residence	<input type="checkbox"/>	<input checked="" type="checkbox"/>	<input checked="" type="checkbox"/>	<input checked="" type="checkbox"/>	<input checked="" type="checkbox"/>	<input checked="" type="checkbox"/>
Public building	<input checked="" type="checkbox"/>	<input type="checkbox"/>	<input type="checkbox"/>	<input type="checkbox"/>	<input type="checkbox"/>	<input type="checkbox"/>
Communal latrine	<input type="checkbox"/>	<input type="checkbox"/>	<input type="checkbox"/>	<input type="checkbox"/>	<input type="checkbox"/>	<input type="checkbox"/>
<b>Source of Water</b>						
Piped	<input checked="" type="checkbox"/>	<input checked="" type="checkbox"/>	<input checked="" type="checkbox"/>	<input checked="" type="checkbox"/>	<input type="checkbox"/>	<input type="checkbox"/>
Hand-carried	<input type="checkbox"/>	<input type="checkbox"/>	<input type="checkbox"/>	<input type="checkbox"/>	<input checked="" type="checkbox"/>	<input checked="" type="checkbox"/>
	If water is piped:					
<b>Water Meter</b>						
No	<input type="checkbox"/>	<input checked="" type="checkbox"/>	<input checked="" type="checkbox"/>	<input checked="" type="checkbox"/>	<input type="checkbox"/>	<input type="checkbox"/>
Yes	<input checked="" type="checkbox"/>	<input type="checkbox"/>	<input type="checkbox"/>	<input type="checkbox"/>	<input type="checkbox"/>	<input type="checkbox"/>
If yes, estimated flow from meter reading is:	<u>1,000 liters</u> _____    _____    _____    _____    _____    (Line 1)					
	If water is piped (no water meter):					
Resident's estimate of daily water use for dwelling or building. Estimate is:	<input type="checkbox"/> <input checked="" type="checkbox"/> <input type="checkbox"/> <input type="checkbox"/> <input type="checkbox"/> <input type="checkbox"/>					
	<u>450 liters</u> _____    _____    _____    _____    _____    (Line 2)					
Resident's estimate of number of times each fixture used per day. Estimate is:						
Pour-flush latrine	<input type="checkbox"/>	<input type="checkbox"/>	<input checked="" type="checkbox"/>	<input type="checkbox"/>	<input type="checkbox"/>	<input type="checkbox"/>
Tank-flush latrine	_____	_____	<u>18</u>	_____	_____	_____
Wash basin	_____	_____	<u>12</u>	_____	_____	_____
Shower	_____	_____	<u>3</u>	_____	_____	_____
Kitchen sink	_____	_____	<u>3</u>	_____	_____	_____
Laundry sink	_____	_____	<u>1</u>	_____	_____	_____
	Use Table 2 to estimate the total flow from a building with fixture-use information:					

Worksheet A. Sewage Flow Survey Form (continued)

	Building Number					
	1	2	3	4	5	6
Estimated total flow from building is:	_____	_____	<u>718 liters</u>	_____	_____	_____ (Line 3)
Resident provided no information:	<input type="checkbox"/>	<input type="checkbox"/>	<input type="checkbox"/>	<input checked="" type="checkbox"/>	<input type="checkbox"/>	<input type="checkbox"/>
Estimated number of persons is:	_____	_____	_____	<u>2</u>	_____	_____
Estimated daily flow from building is:	_____	_____	<u>600 liters</u>	_____	_____	_____ (Line 4)
Approximate distance carried is:	_____	_____	_____	_____	<u>30m</u>	<u>20m</u>
Water carrier's estimate of daily water use for building served is:	<input type="checkbox"/>	<input type="checkbox"/>	<input type="checkbox"/>	<input type="checkbox"/>	<input checked="" type="checkbox"/>	<input type="checkbox"/>
Daily flow to building is:	_____	_____	_____	_____	<u>200 liters</u>	_____ (Line 5)
Water carrier did not provide estimate:	<input type="checkbox"/>	<input type="checkbox"/>	<input type="checkbox"/>	<input type="checkbox"/>	<input type="checkbox"/>	<input checked="" type="checkbox"/>
Estimated number of persons in building is:	_____	_____	_____	_____	_____	<u>3</u>
Estimated daily flow from building is:	_____	_____	_____	_____	_____	<u>285 liters</u> (Line 6)
Total flow from each building (Line 1, 2, 3, 4, 5, or 6) is:	<u>1000</u>	<u>450</u>	<u>718</u>	<u>600</u>	<u>200</u>	<u>285</u> =
Total daily flow for community:	<u>3253</u> liters					

Worksheet A is a sample of a sewage flow survey form that can be modified and used to record information from a community survey.

liters x centimeters diameter x kilometers length = daily seepage.

Then the seepage =  $84 \times 10 \times 10 = 8400$  liters per day.

This seepage must be added to the estimated daily flow for the community.

The estimated daily flow for the community must be increased by 8400 liters per day.

For example, suppose 10 kilometers of 10 centimeter diameter sewer pipe is laid in normally dry soil:

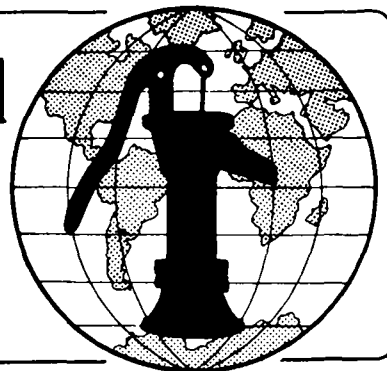
Table 4 indicates which of the five methods of estimating sewage and wash-water flows is likely to be used for various types of disposal systems.

**Table 4. Best Method of Estimating Flow for Different Types of Systems**

Disposal System	Method				
	On-site Measurement	On-site Estimating	Water Meter Estimates	Community Water Use Data	Survey Estimating
Soakage Pits and Trenches	X	X			
Septic Tanks	X	X	X		
Absorption Systems	X	X	X		
Cesspools	X	X	X		
Sewer Systems	X	X	X	X	X
Stabilization Ponds	X	X	X	X	X
Nonconventional Systems	X	X	X		

**Technical Notes** are part of a set of "Water for the World" materials produced under contract to the U.S. Agency for International Development by National Demonstration Water Project, Institute for Rural Water, and National Environmental Health Association. Artwork was done by Redwing Art Service. Technical Notes are intended to provide assistance to a broad range of people with field responsibility for village water supply and sanitation projects in the developing nations. For more detail on the purpose, organization and suggestions for use of Technical Notes, see the introductory Note in the series, titled "Using 'Water for the World' Technical Notes." Other parts of the "Water for the World" series include a comprehensive Program Manual and several Policy Perspectives. Further information on these materials may be obtained from the Development Information Center, Agency for International Development, Washington, D.C., 20523, U.S.A.

# Water for the World



## Determining Soil Suitability

Technical Note No. SAN. 2.P.3

Determining soil suitability for disposal of excreta, washwater, sewage, or sewage effluent is important because some soils cannot safely be used for disposal systems. Systems in unacceptable soils can cause serious health hazards, including contaminated drinking water. Determining soil suitability involves: (1) evaluating soil types, (2) locating groundwater and bedrock levels, (3) determining soil permeability, and (4) determining the allowable rate of sewage effluent application.

### Useful Definitions

**CONTAMINATE** - To make unclean by introducing an infectious disease-causing impurity, such as bacteria from excreta.

**EFFLUENT** - Settled sewage.

**EXCRETA** - Human body wastes.

**GROUNDWATER LEVEL** - The level to which subsurface water rises during any given time of year.

**IMPERVIOUS** - Not allowing liquid to pass through.

**PERCOLATION RATE** - The speed at which water flows through the soil, usually measured in minutes per 25mm.

**PERMEABLE** - Allowing liquid to soak in.

**SEWAGE** - All washwater, excreta, and water used to flush excreta that flows from a building or buildings through a sewer pipe and into a septic tank, cesspool, or stabilization pond.

**WASHWATER** - Water that has been used for bathing or washing clothes, dishes, or kitchen utensils.

**WASTE LIQUID** - Sewage effluent, sewage, washwater, or liquid from excreta.

### Materials Needed

Shovel

Watch or other timepiece

Measuring tape or ruler

Lath, slat, or straight stick about 1m long

Board or piece of lumber about 0.6m long

Pencil

Auger with extension handles (optional; although not essential, this is an extremely useful tool for digging test holes)

### Evaluating Soil Types

An important question concerning soil is how fast it will allow waste liquid to percolate or flow into it. If the waste liquid percolates too fast, the soil will not have a chance to treat it by removing disease-causing substances or agents, and the waste liquid may seep into and contaminate the groundwater. If the waste liquid does not percolate fast enough, it may overflow to the ground surface, causing serious health hazards.

Different types of soils percolate waste liquid at different rates. Some types of soil are acceptable for disposal systems; others are not.

Identifying Soil Types. The six basic types of soil are: (1) sand, (2) sandy loam, (3) loam, (4) silt loam, (5) clay loam, and (6) clay. They can be identified by sight and feel. When testing soil by feel, test it when both dry and moist.

(1) Sand. Individual grains easily seen and felt. A handful of sand squeezed when dry will not hold its shape; squeezed when moist, it will barely hold its shape, crumbling when touched.

(2) Sandy Loam. Contains a large percentage of sand so that sand grains can be seen and felt. Squeezed when dry, a handful of sandy loam will not hold its shape; squeezed when moist, it holds its shape and forms a cast that will not break when handled carefully.

(3) Loam. Has a fairly smooth, yet slightly gritty feel; clods crumble easily. Squeezed when dry, loam forms a cast that can be handled carefully without breaking; squeezed when moist, the cast can be handled freely without breaking.

(4) Silt Loam. Feels soft and floury; clods are easily crumbled. Squeezed when dry or wet, silt loam forms a cast that can be handled freely without breaking. A small ball of moist soil pressed between thumb and finger will not form a ribbon.

(5) Clay Loam. Fine-textured; clods are hard. Moist clay loam is plastic and, when squeezed, forms a cast that can withstand considerable handling without breaking. A small ball of moist clay loam pressed between thumb and finger forms a thin ribbon that barely sustains its own weight.

(6) Clay. Fine-textured; clods are very hard. Wet clay is plastic and usually sticky. A small ball of moist clay pressed between thumb and finger forms a long ribbon.

When the soil at the proposed site has been identified by sight and feel, use Table 1 to determine whether it is suitable for a disposal system.

### Locating Groundwater and Bedrock Levels

Most disposal systems require a minimum of 1m of pervious soil below the bottom of the system and above the highest groundwater level, bedrock, or impervious layers. The most direct method of locating groundwater levels, bedrock, and impervious layers is to dig a test hole. The hole must be 1m deeper than the bottom of the proposed system.

**Table 1. Soil Suitability**

Soil Type	Suitability
Sand	No
Sandy Loam	Yes
Loam	Yes
Silt Loam	Yes
Clay Loam	Yes/No*
Clay	No

\*Yes, if test is for system other than pit or improved privy and if percolation rate is less than 60 minutes per 25mm; no, if test is for pit or improved privy or if percolation rate is more than 60 minutes per 25mm.

An auger with extension handles is an ideal tool for digging test holes. If an auger is not available and the hole must be dug with a shovel, be very careful if the hole is deeper than 1.5m. The sides must be shored up to prevent cave-in and possible serious injury.

**Bedrock.** Bedrock or impervious layers are easily identified in a test hole as it becomes extremely difficult to dig and the soil consists mostly of rocks, shale, or tightly packed, consolidated material.

If bedrock or impervious layers are reached before the test hole reaches the proper depth, the proposed system cannot be constructed as designed. There are three choices: (1) select another site; (2) redesign the proposed system, if possible, to make it shallower but still with its bottom 1m above bedrock or impervious layers; or (3) select and design an alternate system that can be used at this site (see "Simple Methods of Excreta Disposal," SAN.1.M.1, "Simple Methods of Washwater Disposal," SAN.1.M.2, or "Methods of Combined Washwater and Excreta Disposal," SAN.2.M).

Groundwater. The same hole used to test for bedrock can be used to find groundwater levels. Groundwater is easily identified in a test hole. After a few hours, the hole will fill with water to the groundwater level or moist soil will be found at the groundwater level. Since the highest yearly groundwater level must be found, and since groundwater levels fluctuate throughout the year, test for groundwater during the wettest season.

If the highest groundwater level is encountered before the test hole reaches the proper depth, the proposed system cannot be constructed as designed. There remain the three choices noted earlier.

If soil type, bedrock layer, and groundwater level are all acceptable, and the proposed system is a pit or improved privy, the system can be constructed on the site with no further testing. If the proposed system is a soakage pit or trench, cesspool, or absorption field, a percolation test must be conducted at the site to determine, as accurately as possible, the permeability of the soil. The permeability will directly affect the size of the system.

### **Determining Soil Permeability**

Soil permeability refers to the rate at which liquid percolates into the soil. Percolation of water into soil can be measured by digging a hole, pouring in water, and timing the rate at which the water drains out of the hole. This is called a percolation test. The test is fairly simple to conduct, but it must be done carefully in order to yield accurate results.

#### Conducting a Percolation Test.

1. Two percolation tests must be conducted at the proposed site. If the system is an absorption field or soakage trench, the tests should be conducted about one-third of the distance in from each end of the system, as shown in Figure 1. The test holes for a field or trench are dug to the depth of the

system. For example, if the proposed trench is 1m deep, the test hole should also be 1m deep. If the proposed system is a cesspool or soakage pit, the tests are conducted in the center of the system at the proposed site of the cesspool or the soakage pit. The first test should be carried out at half the depth of the cesspool or pit, and the second test at the full depth. For example, if the proposed pit is 2.4m deep, the first percolation test is conducted at a depth of 1.2m, and the second at 2.4m. Generally, the results of the two tests will be about the same. If they differ, use the slower of the two percolation rates to design the system.

2. Dig or bore a hole about 300mm in diameter, or <sup>3</sup>300mm square, to the proper depth. Do not use the same hole used for locating groundwater and bedrock. That hole is too deep and, if filled in to the proper depth, will yield inaccurate test results. Make the walls of the hole vertical. Scrape the walls to remove any patches of compacted soil. Place about 50mm of clean gravel in the bottom of the hole.

3. Fill the hole with water and let it soak overnight. This will allow ample time for soil swelling and saturation, and provide more accurate test results.

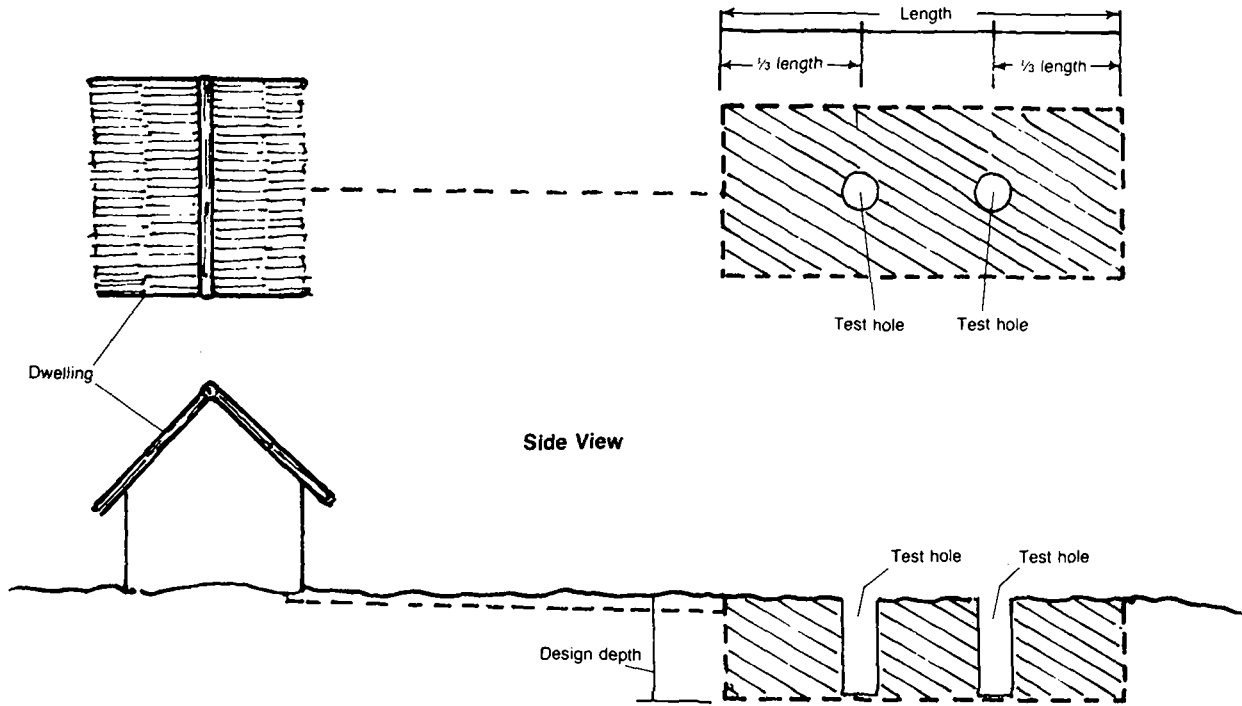
4. Place a board or piece of lumber across the center of the hole and anchor it firmly in place, perhaps by placing a rock on each end. The board must not be moved until the test is complete. Mark a point near the center of the board to be used as a guide for the remainder of the test.

5. Most or all of the water poured in the day before will have drained away. Pour in enough water so that the depth is 200mm.

6. Place a pointed slat or similar measuring stick next to the reference mark on the board and slide it down until it just touches the water surface. Ripples on the water can be observed when the slat touches. Note the exact time and draw a horizontal

FOR ABSORPTION TRENCH OR FIELD

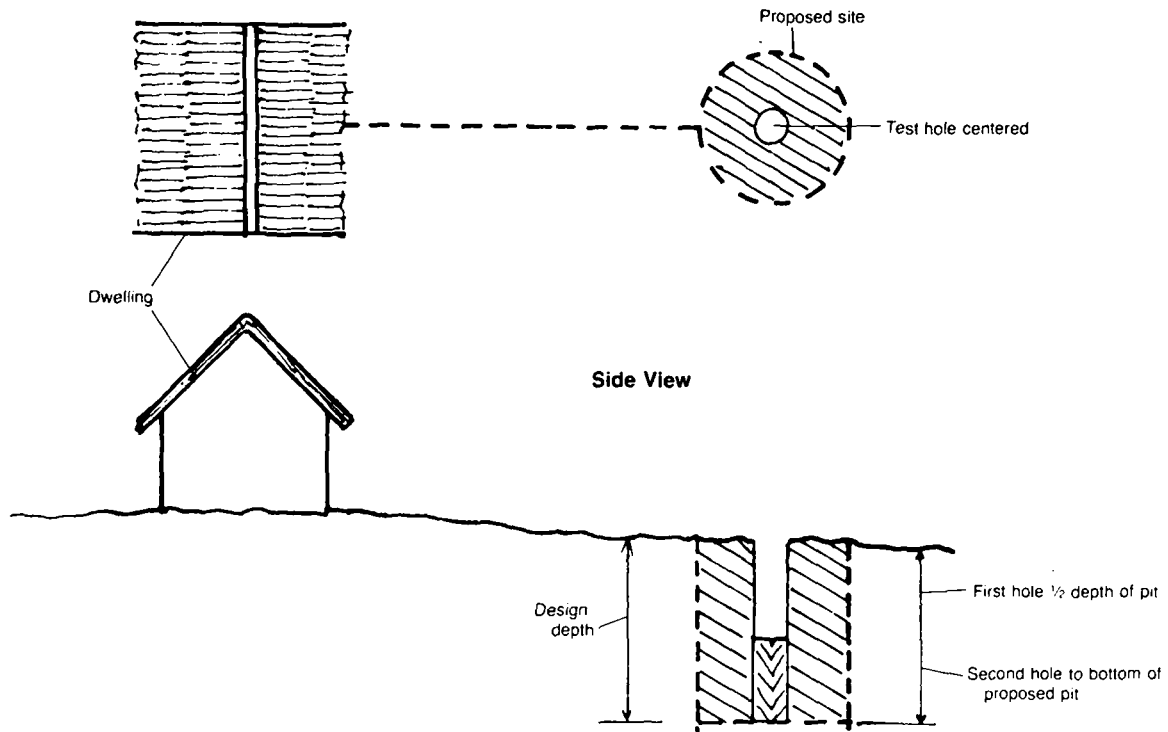
Top View



Side View

FOR SOAKAGE PIT OR CESSPOOL

Top View



Side View

Figure 1. Location and Depth of Percolation Tests



line on the slat, using the edge of the board for a guide, as shown in Figure 2.

7. Repeat step 6 at 10-minute intervals. If the water level drops rapidly, repeat at one-minute intervals. Do not allow the water to be lower than 100mm. If it does, pour in more water to the 200mm depth and continue the test.

8. Note the spacing between the pencil marks on the slat. When at least three spaces become approximately equal, as shown in Figure 3, the test is completed. This may take as little as one-half hour or as long as several hours.

9. Using the measuring tape or ruler, measure the space between the equal pencil markings and compute how long it took the water level to drop 25mm. This step is necessary because percolation rates are described in terms of "minutes per 25mm." This can be approximated closely with the ruler and a series of equally spaced markings on the slat, as shown in Figure 3, or it can be calculated. Worksheet A shows how to tabulate information and calculate soil suitability.

To find how long it takes for the water level to drop 25mm, divide 25mm by the distance between two equal markings and multiply by the time interval for those two markings.

For example, suppose the markings are made at 10-minute intervals and the distance between the equal markings is 9mm. Then:

$$\frac{25\text{mm}}{9\text{mm}} \times 10 \text{ minutes} = \text{about } 27 \text{ minutes}$$

The percolation rate is 27 minutes per 25mm.

If the percolation rate for 25mm is between 10 and 60 minutes, the soil is acceptable. The percolation rate can be used to determine the size of the system as described in the next section. If the percolation rate is less than 10 minutes or more than 60

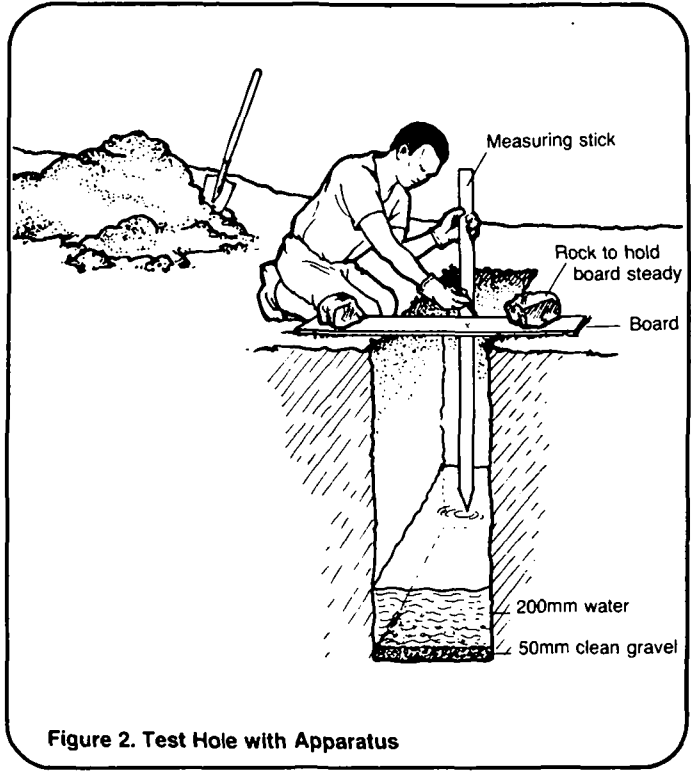


Figure 2. Test Hole with Apparatus

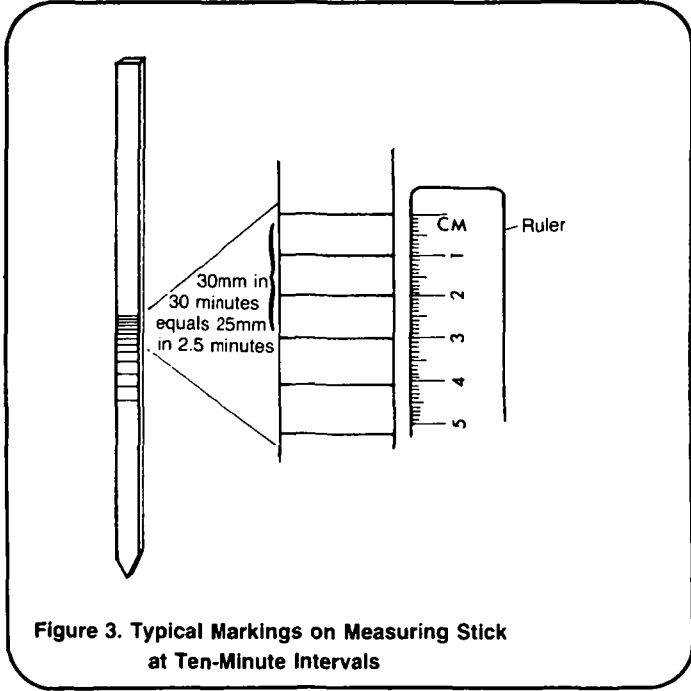


Figure 3. Typical Markings on Measuring Stick at Ten-Minute Intervals

the proposed system cannot be constructed as designed. There remain two choices: select another site for testing; or select and design an alternate system that can be used at this site.

## Worksheet A. Determining Soil Suitability

Type of Disposal System (check one):

- pit or improved privy     soakage trench     absorption trench (or field)  
 cesspool     soakage pit     other \_\_\_\_\_

Depth of system: 1m

### 1. Evaluating Soil Types.

Soil type found at site:

- sand     sandy loam     loam     silt loam     clay loam     clay

Suitability:     Yes     No     Maybe

### 2. Locating Groundwater, Bedrock or Impervious Layers.

Depth of test hole = depth of system + 1m  
= 1m + 1m  
= 2m

Was groundwater encountered?     Yes     No

If Yes, at what depth? \_\_\_\_\_

Do soil colorations indicate higher groundwater levels?     Yes     No

If Yes, at what depth? \_\_\_\_\_

### 3. Determining Soil Permeability (Percolation Test).

Depth of percolation test hole: 1m

Time interval for test marks: 10 minutes

Space between equal marks: 9mm

Percolation rate =  $\frac{25\text{mm}}{\text{space}}$  x minutes

=  $\frac{25\text{mm}}{9\text{mm}}$  x 10 minutes

= 27 minutes

### 4. Determining Allowable Rate of Sewage Effluent Application from Table 2.

Rate of application: 37-41 1pd/m<sup>2</sup>

## Determining the Allowable Rate of Sewage Effluent Application

To determine the allowable rate of application, use the results of the percolation test and Table 2. In the first column of Table 2, find the percolation rate as indicated by the field test. The second column shows the allowable rate of application for each percolation rate. The allowable rate of sewage effluent or washwater application is given in liters per day per square meter (lpd/m<sup>2</sup>). This information, along with "Estimating Sewage or Washwater Flows," SAN.2.P.2, will be used to determine the size of the soakage pit or trench, cesspool, or absorption field.

**Table 2. Allowable Rate of Effluent/Washwater Application**

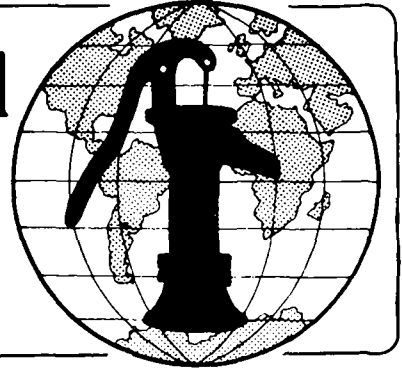
Percolation Rate (minutes per 25mm)	Allowable Rate of Application (lpd/m <sup>2</sup> )
less than 10 - - - - -	soil not suitable
10 - - - - -	65
12 - - - - -	57
15 - - - - -	53
20 - - - - -	45
25 - - - - -	41
30 - - - - -	37
35 - - - - -	33
40 - - - - -	33
50 - - - - -	29
60 - - - - -	24
more than 60 - - - - -	soil not suitable

LIBRARY  
INTERNATIONAL REFERENCE CENTER  
FOR COMMUNITY WATER SUPPLY AND  
SANITATION (IRC)

## Notes

**Technical Notes** are part of a set of "Water for the World" materials produced under contract to the U.S. Agency for International Development by National Demonstration Water Project, Institute for Rural Water, and National Environmental Health Association. Artwork was done by Redwing Art Service. Technical Notes are intended to provide assistance to a broad range of people with field responsibility for village water supply and sanitation projects in the developing nations. For more detail on the purpose, organization and suggestions for use of Technical Notes, see the introductory Note in the series, titled "Using 'Water for the World' Technical Notes." Other parts of the "Water for the World" series include a comprehensive Program Manual and several Policy Perspectives. Further information on these materials may be obtained from the Development Information Center, Agency for International Development, Washington, D.C., 20523, U.S.A.

# Water for the World



## Designing Subsurface Absorption Systems

Technical Note No. SAN. 2.D.1

A subsurface absorption system is a trench, series of trenches, field or pit that receives effluent from a septic tank and allows it to soak safely into the ground. Designing an absorption system involves selecting a location, deciding on the type and size of the system, and determining the labor, materials, and tools needed to construct it. The products of the design process are: (1) a location map, (2) technical drawings of the system, and (3) detailed materials list. These products should be given to the construction supervisor before construction begins.

This technical note describes how to design a subsurface absorption system and produce the three end-products. Read the entire technical note before starting the design process.

### Useful Definitions

**ALLOWABLE RATE OF SEWAGE APPLICATION** - The amount of effluent that the soil in a particular area will absorb in one day, expressed in liters per square meter per day (lpd/m<sup>2</sup>).

**EFFLUENT** - Settled sewage.

**GROUNDWATER LEVEL** - The level to which subsurface water rises during any given time of year.

**PERVIOUS** - Allowing liquid to pass through.

### Materials Needed

Measuring tape - To obtain accurate field information for a location map.

Ruler - To draw a location map.

### Location

A subsurface absorption system must be downhill and at least:

30m from the nearest water supply;  
6m from the nearest building;  
3m from any property line;  
3m from bushes or trees.

Do not put the system in an area where surface water will stand on it or flow over it. Locate the system so that there is a straight line from the building served, through the septic tank, to the absorption system.

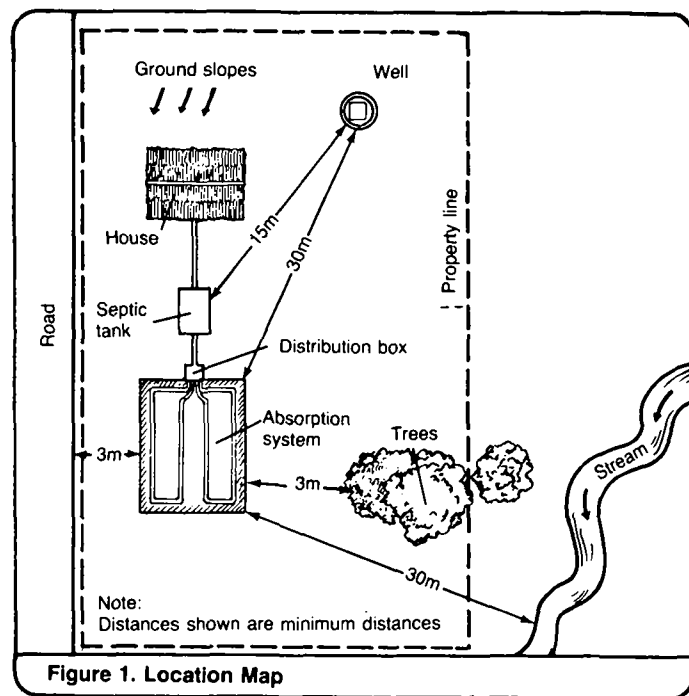
After a proposed site has been selected, it must be tested for soil suitability (see "Determining Soil Suitability," SAN.2.P.3). The test is conducted in two steps:

**Step 1.** Determine if the highest groundwater level and level of impervious layers are suitable for the system. The bottom of an absorption system must be at least 1m above these levels. If these conditions are not acceptable, select another site. If no acceptable site can be found, and the proposed system is a pit, it may be possible to substitute a trench, series of trenches, or absorption field, since these systems are shallower than a pit. If not, design either a non-conventional system (see "Designing Non-conventional Excreta and Washwater Disposal Systems," SAN.2.D.8) or a sewer system (see "Designing Sewer Systems," SAN.2.D.4 and "Designing Stabilization Ponds," SAN.2.D.5).

If the groundwater and impervious layers are acceptable for the system, proceed to the second step.

**Step 2.** Determine the allowable rate of sewage application by conducting a soil percolation test (see "Determining Soil Suitability," SAN.2.P.3). The test should be conducted at the same depth of a proposed trench, series of trenches, or field, and at both one-half the depth and the full depth of a proposed pit. If the results of the percolation tests are unacceptable for the proposed systems, select another site and repeat Step 1. If no acceptable site can be found, design either a non-conventional system or a sewer system.

When an acceptable site for an absorption system has been found, draw a location map similar to Figure 1 showing distances from the system to the septic tank, buildings, water supplies, property lines, vegetation, and any other structures or prominent geographical features. Give this map to the construction supervisor before construction begins.



### Determining the Type and Size of the System

The type of subsurface absorption system selected is affected by groundwater level, size of lot, contour of the terrain, availability of materials, and personal preference.

For example, if the groundwater level is low, a pit may be the choice. If the lot is long and narrow, a single trench may be best. If the lot is flat and level, a field may be the most reasonable option. If the terrain is uneven, an open-end system of trenches may be the wisest selection. Table 1 will help in selecting a system:

When the type of system has been selected, determine its size. The size depends on the configuration of the system, such as a long trench or square field, and the area of absorbent earth needed. The required area depends on the allowable rate of sewage application, already determined by the soil suitability test, and the estimated daily flow of sewage

**Table 1. Comparison of Absorption Systems**

System	Advantages	Disadvantages
Pit	Only a small area is needed; can be used if drainpipe is not available.	Can be used only in areas of low groundwater levels; may be difficult to excavate.
Trench	Can be used in areas of high groundwater levels and on uneven and sloped terrain.	May require large or elongated areas and large quantities of drainpipe.
Field	Can be used in areas of high groundwater levels; only a small area is needed.	Terrain must be fairly level.

effluent. The daily flow can be estimated by several methods (see "Estimating Sewage or Washwater Flows," SAN.2.P.2). Use the same daily flow estimate to design the absorption system that was used to design the adjoining septic tank or cesspool.

The estimated daily flow, expressed in liters per day, is divided by the allowable rate of sewage application, expressed in liters per square meter per day, to find the required area of absorbent earth, expressed in square meters. See Worksheet A, Lines 1, 2, and 3. Worksheet A is a sample showing how to calculate the size of an absorption system. You should develop a similar worksheet for your own use.

$$\frac{\text{estimated daily flow (liters per day)}}{\text{allowable rate of sewage application (liters per square meters per day)}} = \text{required area (square meters)}$$

For example, suppose that from "Determining Soil Suitability," SAN.2.P.3, the allowable rate of sewage application is 61.1 liters per square meter per day and from "Estimating Sewage or Washwater Flows," SAN.2.P.2, the estimated daily flow of sewage effluent is 1700 liters per day.

Then the required area of absorbent earth is:

$$\frac{1700 \text{ l/d}}{61.1 \text{ l/m}^2/\text{d}} = 27.8\text{m}^2$$

The area of absorbent earth required determines the size of the system. This area equals the bottom area of a trench, or trenches; the bottom area of a field; or the bottom area plus the area of the vertical earth walls below the inlet of a pit.

### Determining Trench Size

The width of a trench must be 300 to 600mm. The length must be no more than 46m because a trench any longer loses its effectiveness. The size of the

trench is determined by the area of the bottom. This area must be no less than the required area of absorbent earth. See Worksheet A, Lines 4 and 5.

For example, suppose the required area of absorbent earth is 27.8m<sup>2</sup> and the desired trench width is 600mm. To find the necessary trench length, divide the area by the width.

$$\frac{27.8\text{m}^2}{0.6\text{m}} = 46\text{m}$$

The trench must be 46m long.

Suppose, for the same example, there is not enough room for a single trench 46m long. Design two or more trenches whose combined lengths equal 46m. For example you could use two trenches each 23m long. See Worksheet A, Lines 6 and 7.

The final dimensions should be written on the technical drawings similar to Figures 2 and 3 and given to the construction supervisor.

### Determining Field Size

Absorption fields are usually square or rectangular. The size of the field is determined by the area of the bottom. This area must be no less than the required area of absorbent earth. See Worksheet A, Lines 8 and 9.

For example, if the required area of absorbent earth is 27.8m<sup>2</sup>, then a square field would be 5.3m on each side:

$$5.3\text{m} \times 5.3\text{m} = 27.8\text{m}^2$$

A rectangular field could be 3.1m wide and 9.1m long:

$$3.1\text{m} \times 9.1\text{m} = 27.8\text{m}^2$$

The final dimensions should be written on a technical drawing similar to Figure 4 and given to the construction supervisor.

## Worksheet A. Calculating the Size of an Absorption System

System Type (check one):  trench       field       pit

Line 1. Allowable rate of sewage application: 61.1 1pd/m<sup>2</sup>

Line 2. Estimated daily flow: 1700 1pd

Line 3. Required area of absorbent earth =  $\frac{\text{Line 2}}{\text{Line 1}} = \underline{27.8}$  m<sup>2</sup>

If System is a Trench:

Line 4. Proposed trench width: 0.6 m

Line 5. Necessary trench length =  $\frac{\text{Line 3}}{\text{Line 4}} = \underline{46}$  m

If more than one trench is required (or desired):

Line 6. Number of trenches: 2

Line 7. Necessary length of each trench =  $\frac{\text{Line 5}}{\text{Line 6}} = \underline{23}$  m

If System is a Field:

Line 8. Proposed field width: 5.3 m

Line 9. Necessary length =  $\frac{\text{Line 3}}{\text{Line 8}} = \underline{5.3}$  m

If System is a Pit:

Pit Type (check one):  square       rectangular       circular

If pit is square:

Line 10. Proposed length of each side: 2.4 m

Line 11. Bottom area = Line 10 times Line 10 = 5.7 m<sup>2</sup>

Line 12. Total wall area = Line 3 minus Line 11 = 22.1 m<sup>2</sup>

Line 13. Necessary depth below inlet =  $\frac{\text{Line 12}}{4 \times \text{Line 10}} = \underline{2.3}$  m

If pit is rectangular:

Line 14. Proposed length of pit: 2.6 m

Line 15. Proposed width of pit: 2.2 m

Line 16. Bottom area = Line 14 x Line 15 = 5.7 m<sup>2</sup>

Line 17. Total wall area = Line 3 minus Line 16 = 22.1 m<sup>2</sup>

Line 18. Necessary depth below inlet =  $\frac{\text{Line 17}}{2 \times \text{Line 14} + 2 \times \text{Line 15}} = \underline{2.3}$  m

If pit is circular:

Line 19. Proposed diameter: 2.8 m

Line 20. Radius of pit =  $\frac{\text{Line 19}}{2} = \underline{1.4}$  m

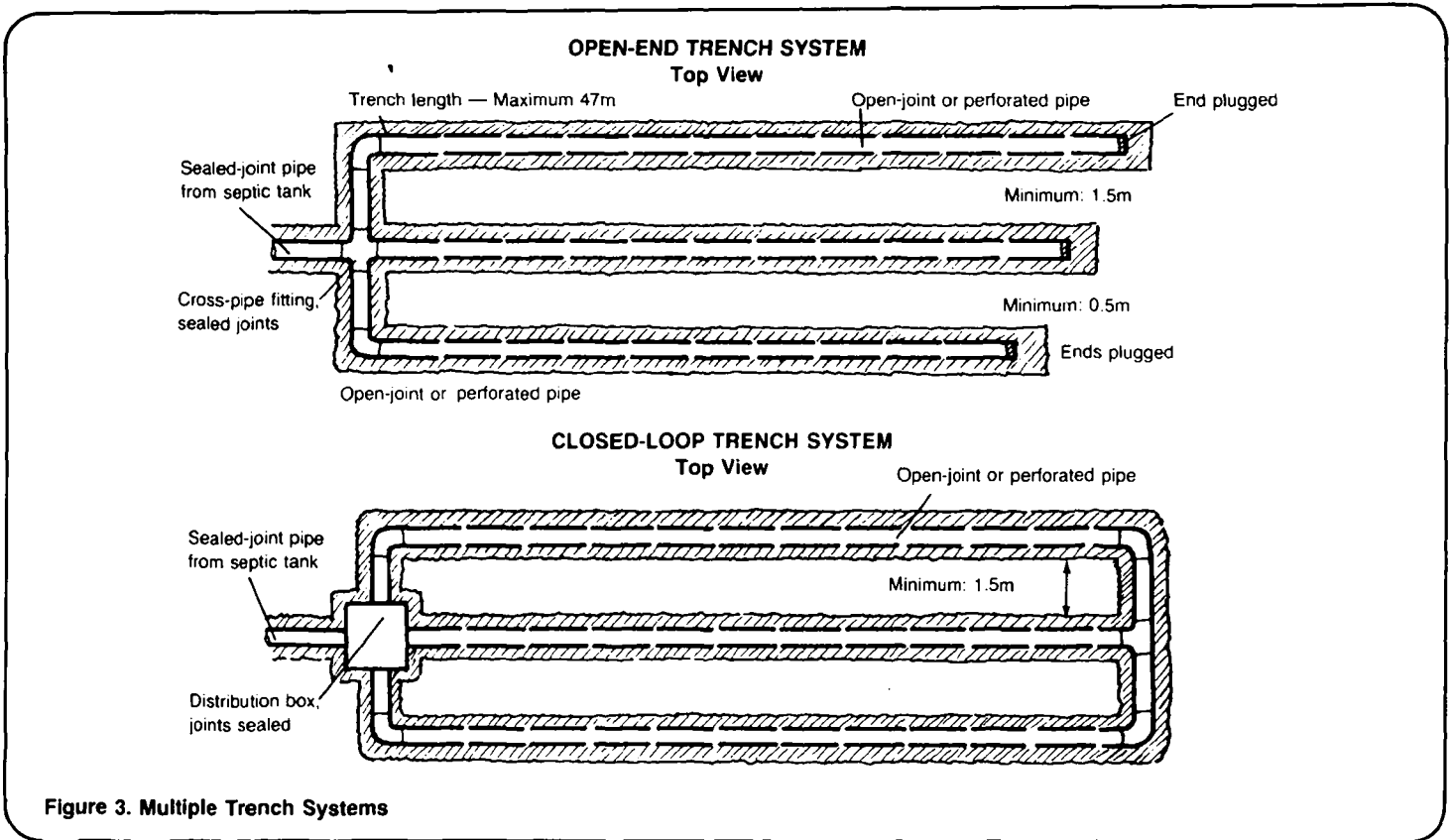
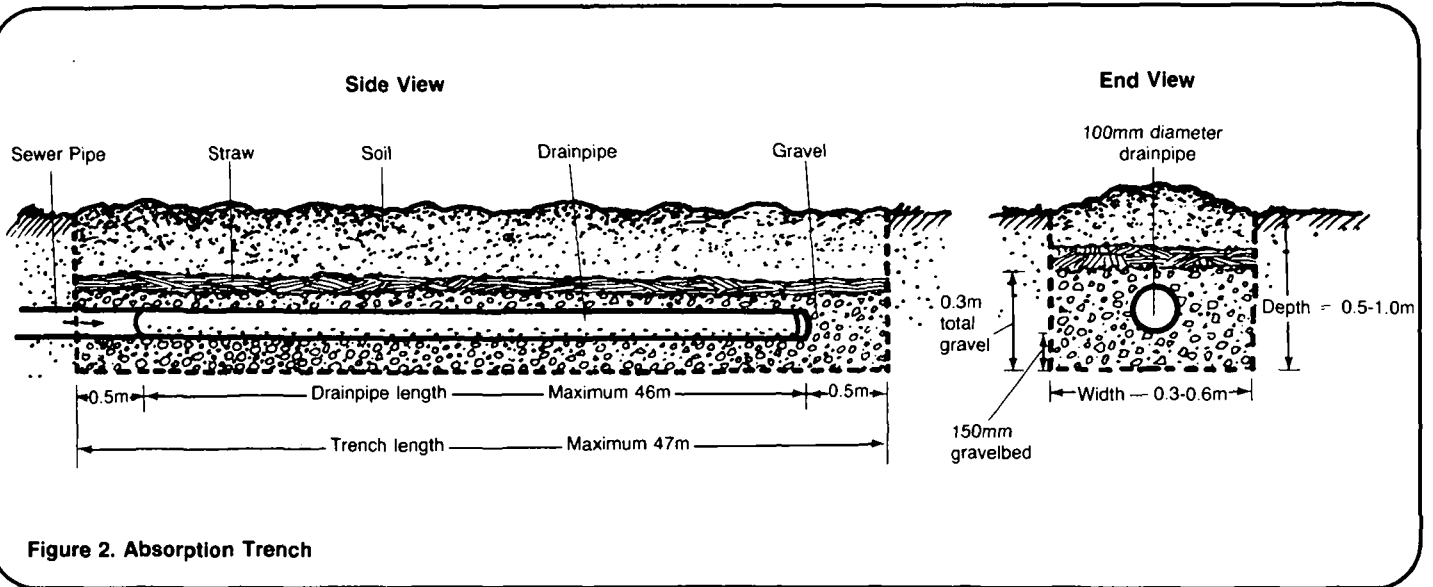
Line 21. Circumference =  $2 \times 3.1 \times \text{Line 20} = \underline{8.7}$  m

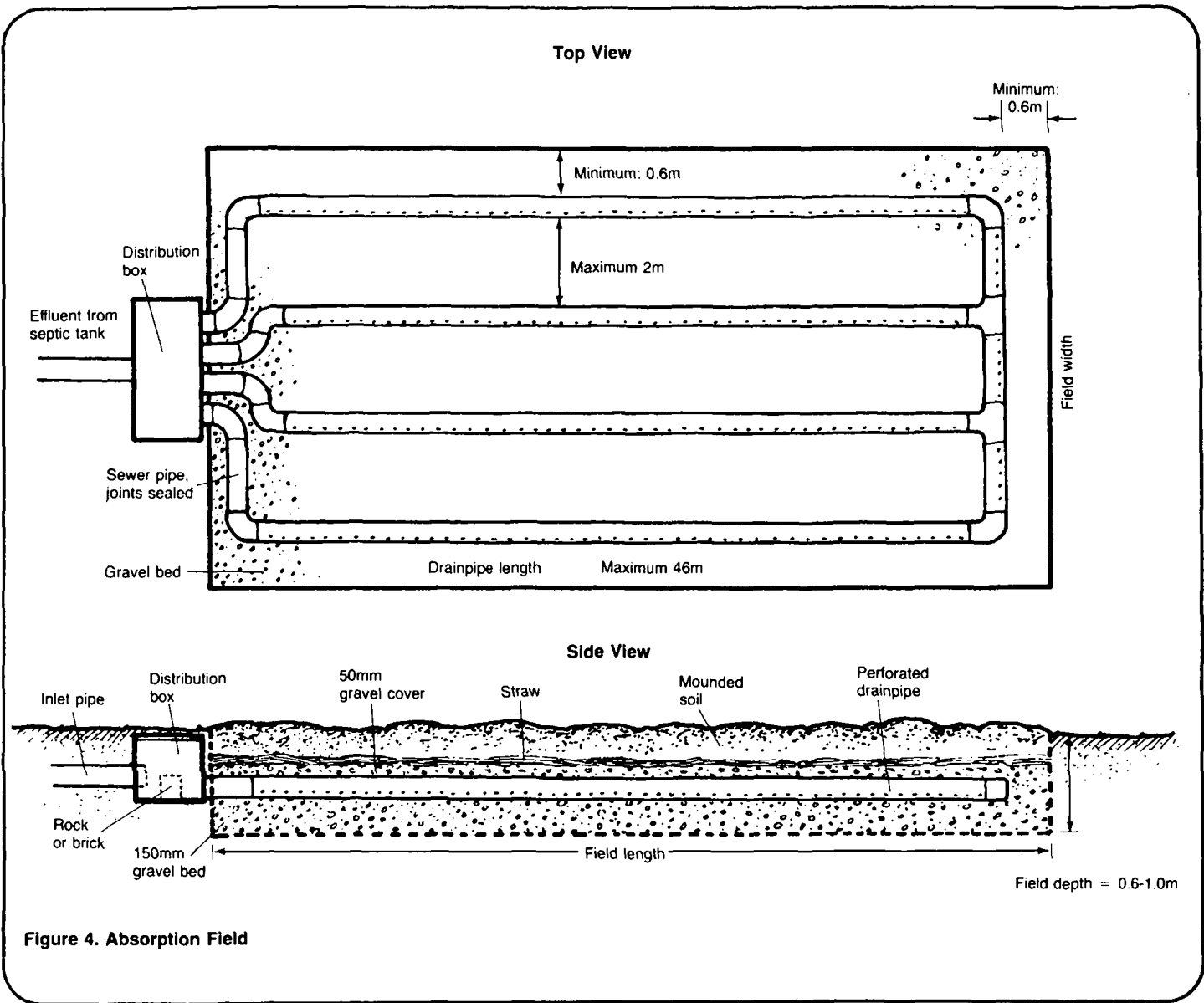
Line 22. Bottom area =  $3.1 \times \text{Line 20} \times \text{Line 20} = \underline{6.1}$  m<sup>2</sup>

Line 23. Area of circular wall = Line 3 minus Line 22 = 21.7 m<sup>2</sup>

Line 24. Necessary depth below inlet =  $\frac{\text{Line 23}}{\text{Line 21}} = \underline{2.5}$  m







**Figure 4. Absorption Field**

### Determining the Pit Size

A pit may be square, rectangular or round. The area of the pit below the inlet must be no less than the required area of absorbent earth. If the pit is square or rectangular, determine the area by adding the areas of the four earth walls below the inlet and the area of the bottom. If the pit is round, determine the area by adding the area of the circular earth wall below the inlet and the area of the bottom.

When calculating the area of a circular pit, the following information will be helpful:

- d = diameter
- r = radius
- c = circumference
- $r = \frac{d}{2}$
- $c = 2 \times 3.1 \times r$
- $3.1 \times r^2 =$  area of bottom
- $c \text{ times depth below inlet} =$  area of circular wall

For example, if the required area of absorbent earth is  $27.8\text{m}^2$ , then the area of the pit below the inlet must be at least this much. It can be more.

A square pit could be 2.4m on each side and 2.3m deep below the inlet. See Worksheet A, Lines 10, 11, 12 and 13. Thus:

$$\text{area of four sides} = 2.4\text{m} \times 2.3\text{m} \times 4 = 22.1\text{m}^2$$

$$\text{area of bottom} = 2.4\text{m} \times 2.4\text{m} = 5.7\text{m}^2$$

$$\text{total area} = \text{sides} + \text{bottom} = 27.8\text{m}^2$$

A rectangular pit could be 2.6m long by 2.2m wide and 2.3m deep below the inlet. See Worksheet A, Lines 14, 15, 16, 17, and 18. Thus:

$$\text{area of two sides} = 2.6\text{m} \times 2.3\text{m} \times 2 = 12.0\text{m}^2$$

$$\text{area of two ends} = 2.2\text{m} \times 2.3\text{m} \times 2 = 10.1\text{m}^2$$

$$\text{area of bottom} = 2.2\text{m} \times 2.6\text{m} = 5.7\text{m}^2$$

$$\text{total area} = \text{sides} + \text{ends} + \text{bottom} = 27.8\text{m}^2$$

A circular pit could be 2.8m in diameter and 2.5m deep below the inlet. See Worksheet A, Lines 19, 20, 21, 22, 23, and 24. Thus:

$$\text{area of bottom} = 3.1 \times r^2 = 3.1 \times 1.4\text{m} \times 1.4\text{m} = 6.1\text{m}^2$$

$$\text{area of wall} = 2 \times 3.1 \times r \times \text{depth below inlet} = 2 \times 3.1 \times 1.4\text{m} \times 2.5\text{m} = 21.7\text{m}^2$$

$$\text{total area} = \text{bottom} + \text{circular wall} = 27.8\text{m}^2$$

The final dimensions should be written on a technical drawing similar to Figure 5 and given to the construction supervisor. In addition to showing dimensions, the technical drawing of a trench, series of trenches, field or pit will contain other design information.

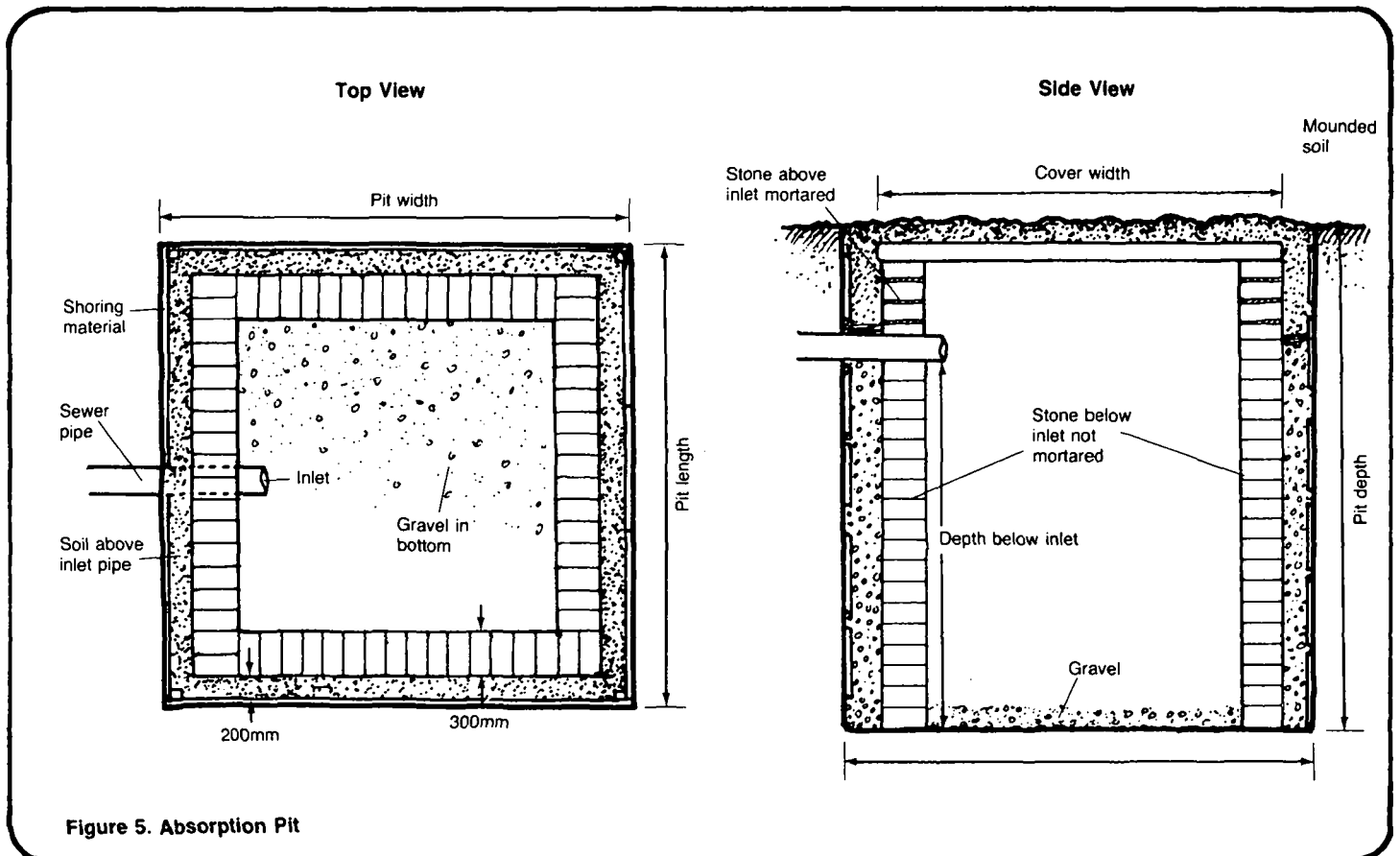


Figure 5. Absorption Pit

## Design Information for a Trench or Series of Trenches

A trench must be 0.3 to 0.6m wide, and no more than 1.0m deep. It must not be longer than 46m. If there are two or more trenches, they must be at least 1.5m apart. Each trench should have a grade no steeper than one in 200. This means the trench drops one unit in elevation for every 200 units of length.

About 150mm of clean gravel or crushed rock must be laid in the bottom of the entire length of the trench or trenches. Drainpipe is laid on the gravel in the center of the trench. The pipe should be 100mm in diameter. It may be made of clay, concrete, perforated tile, plain or perforated plastic, or bell-and-spigot glazed tile. Pipe sections are usually 0.3 to 1.0m long. If the pipe is not perforated, pipe sections must be laid end to end but not mortared, so the effluent can seep between the sections into the gravel. Building or tar paper must be laid over the open joints to prevent gravel from filling in the open space.

The drainpipe must be covered with about 50mm of clean gravel or crushed rock. The gravel or crushed rock must be covered with a pervious material such as untreated paper, straw, hay, or grass. This material will prevent cover dirt from sifting down into the gravel and clogging it. The entire trench must be filled and mounded with dirt. The dirt must not be tamped.

Prepare a technical drawing similar to Figure 2, showing the end and side views of the trench with the correct dimensions written in. Give this drawing to the construction supervisor prior to beginning work.

If two or more trenches are being used, they may be joined at the ends (closed-loop), or not joined (open-end). If they are open-ended trenches, the end of the last pipe section must be plugged with concrete or other material that will not decay. The trench lines should be parallel and the pipelines must be no closer together than 1.5m. Figure 3 shows some typical configurations for series of trenches.

Prepare a technical drawing similar to Figure 3 showing the length of each trench and the distances between pipelines. This is in addition to the technical drawings similar to Figure 2. Give this drawing to the construction supervisor before construction begins.

If two or more trenches are being used, there must also be a distribution box or equivalent. The box receives effluent from the septic tank and distributes in evenly to all trenches. It must be watertight and have a cover. If there are only two or three trenches, a sewer tile "cross" or "T" may be substituted for a distribution box.

A distribution box is usually concrete, but it may be brick and mortar, metal, or wood. The box must have minimum inside dimensions of 450mm by 450mm. The depth of the box, as well as the depth of the absorption trenches, will depend on the depth of the outlet pipe from the septic tank and the slope of the ground, but should not be much more than 1m.

The bottom of the box must be level. The sewer pipe from the septic tank must enter the box 100 to 150mm above the floor. The pipes going out to the trenches must be level with the floor, and they must all be the same elevation to ensure an even distribution of effluent. A brick or stone is usually placed in the center of the box to prevent effluent from flowing straight across the floor and out one pipe only. All pipe joints in and out of the distribution box must be mortared.

If you are designing a distribution box, prepare a technical drawing similar to Figure 6, showing the width, length, and depth of the box, the distance from inlet pipe to floor, and the thickness of the walls if they are concrete. Give this drawing to the construction supervisor before construction begins.

## Design Information for an Absorption Field

An absorption field is usually square or rectangular. It must be nearly level, with a depth of 0.6m to

1.0m. About 150mm of clean gravel or crushed rock must be spread over the entire bottom of the field.

Drainpipes are laid on the gravel similar to a closed-loop series of trenches. The pipes must be parallel, no more than 2m apart, and no closer than 0.6m from the sides of ends of the field. The drainpipe may be perforated or open-joint.

Building or tar paper must be laid over the open joints to prevent gravel from filling in the open spaces. Clean gravel or crushed rock is spread over the pipe to a depth of 50mm. The gravel must be covered with untreated paper, straw, hay, or grass. The entire field is covered with dirt and mounded, but not tamped. The distribution box is designed in the same way as the one for a series of trenches.

Prepare a technical drawing similar to Figure 4 showing top and side views of the field with the correct dimensions written in. Also, prepare a technical drawing similar to Figure 6, showing the width, length, and depth of the distribution box, the distance from the inlet pipe to the floor, and the thickness of the walls if they are concrete. Give both these drawings to the construction supervisor before construction begins.

### Design Information for a Pit

An absorption pit may be square, rectangular or circular.

The constructed side walls should be about 300mm thick and made of field stones, cinder blocks, precast perforated wall sections, or bricks. The side walls should be mortared above the inlet for strength. They must not be mortared below the inlet so the effluent can soak through.

Leave a space of about 200mm between the earth walls of the pit and the constructed side walls. This space must be filled with clean gravel or crushed rock. The inlet pipe must be extended 100 to 150mm inside the constructed side wall to prevent sewage effluent from running down the wall.

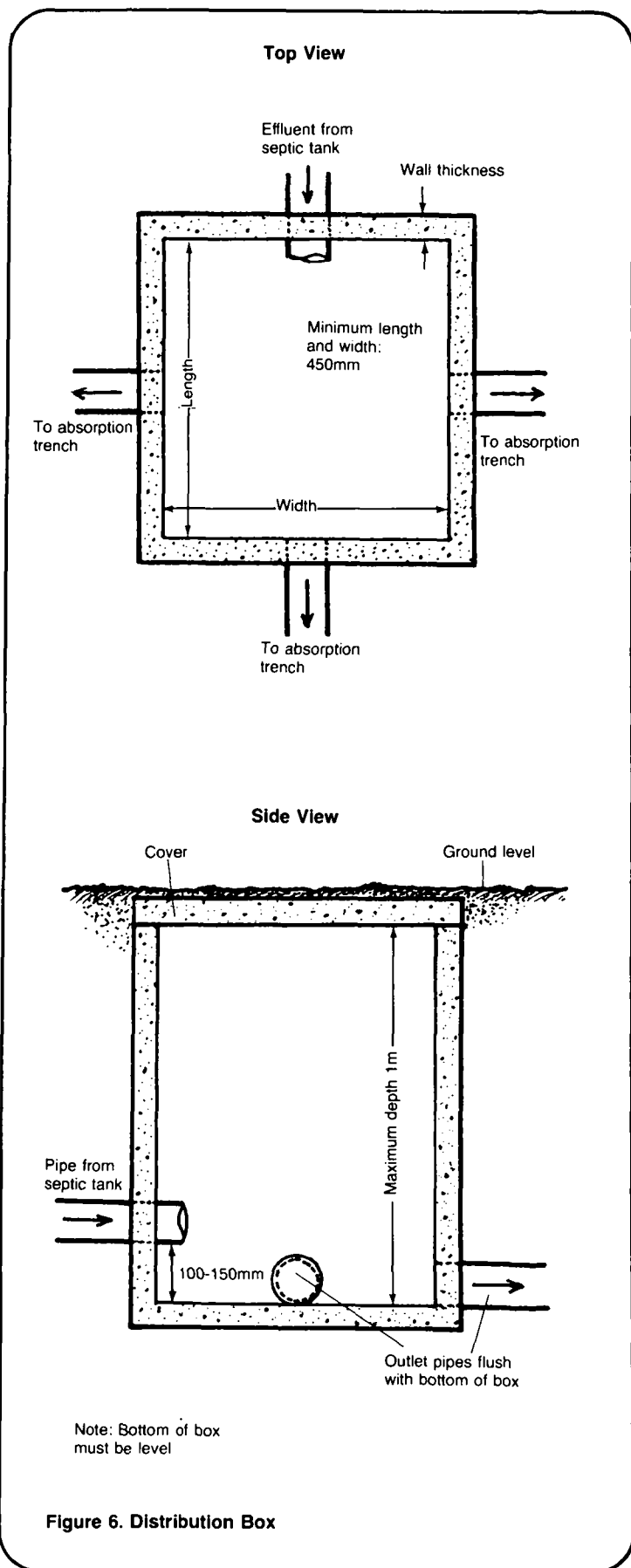


Figure 6. Distribution Box

Design a well-fitting, strong, watertight cover for the pit. It may be in one piece or in sections. It must prevent a person from falling into the pit, prevent the entry of water or animals, and support the weight of the earth that will cover it.

Prepare a technical drawing similar to Figure 5 showing top and side views of the pit with the correct dimensions written in, including the length, width, and depth below ground level, the depth below the inlet, the thickness of the side walls and the space between the earth walls and the side walls. Give this drawing to the construction supervisor before construction begins.

### Design Information for Sewer Pipe from Septic Tank to Absorption System

The trench for a sewer pipe should be as straight as possible. It can be as shallow as 300mm deep, as narrow as 300mm wide, and should have an even and continuous downward slope toward the absorption system of about one in 100. Sewer pipe is usually 100mm in diameter and is made of clay, concrete, or plastic.

Prepare a drawing similar to Figure 7 and write in the correct trench width, depth, and slope; the pipeline length from the septic tank (see "Designing Septic Tanks," SAN.2.D.3) to the distribution box, if any; and from the box to the absorption system. Give this drawing to the construction supervisor before construction begins.

### Materials List

In addition to the location map and the technical drawings, provide a materials list for the construction supervisor similar to the sample shown in Table 2. The list must include labor requirements, types and quantities of materials and tools, and the estimated funds needed to construct the system. This technical note provides the means of calculating most quantities. Those remaining will have to be determined by the project designer or the construction supervisor.

Labor. All absorption systems require unskilled manual laborers to dig a trench, field, or pit. One worker must be familiar with cement mortar, or similar material, used to mortar pipe joints. If the system has

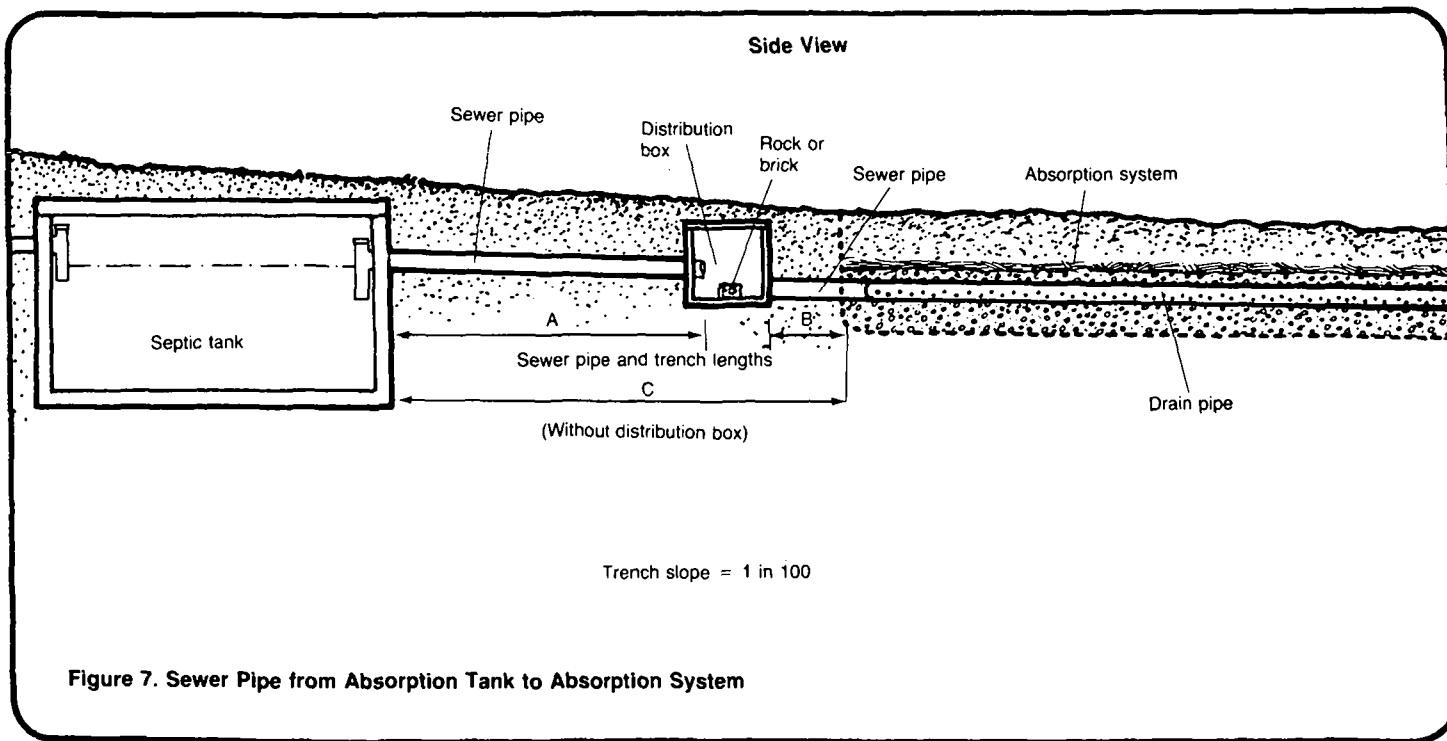


Figure 7. Sewer Pipe from Absorption Tank to Absorption System

**Table 2. Sample Materials List for Absorption System**

Item	Description	Quantity	Estimated Cost
Labor	Foreman Laborers (one experienced with concrete or mortar, if applicable)	1 2 (at least)	_____ _____
Supplies	Wooden stakes for marking out system Sewer pipe; 100mm diameter, clay, concrete, or plastic  Drainpipe; 100mm diameter, perforated or open-joint sewer pipe (open-joint sections 0.5m long) Gravel or crushed rock; clean, size from 12 to 50mm  Tar, mortar, or oakum (for sealing pipe joints) Tar paper or building paper (for covering open joints) Untreated paper, straw, hay, or grass (for covering gravel) If pit: Wood, poles, bamboo, or other material for shoring sides If distribution box: Cement: portland Sand: clean, fine to 6mm Gravel: clean, 6 to 38mm Water: clear, enough to make stiff mix Wooden boards (for building forms) Nails (for building forms) Other	_____ _____ _____m, enough to reach from septic tank to absorption system  _____ _____m, enough to construct trench, trenches or field  _____ _____m <sup>3</sup> , enough to fill trenches or field or wall space in pit  _____  _____ _____m <sup>2</sup> , enough to cover all joints  _____  _____  _____ _____m <sup>3</sup> _____m <sup>3</sup>  _____ _____m <sup>3</sup>  _____ _____liters  _____  _____  _____  _____	_____ _____ _____ _____ _____ _____ _____ _____ _____ _____ _____ _____ _____ _____ _____ _____ _____ _____ _____
Tools	Rake or hoe Measuring tape Shovels  Wheelbarrow Carpenter's level or equivalent If pit or distribution box: Hammer Saw If concrete distribution box: Container (for mixing) Trowel Other	1 1 2 (at least one per worker) 1 1  1 1  1 1 1 1 _____	_____ _____ _____ _____ _____ _____ _____ _____ _____ _____ _____ _____ _____ _____ _____

Total Estimated Cost= \_\_\_\_\_

a distribution box made from concrete, or if the system is a pit with a concrete cover, one worker must be experienced with mixing and pouring concrete, positioning reinforcing material, and building forms. If the system is a pit, one worker must be experienced with mixing mortar and laying bricks.

Sewer pipe. This is needed for all absorption systems. The pipe is usually 100mm in diameter and made from noncorrosive material such as vitrified clay, concrete, or special plastic. The quantity of pipe depends on the layout of the system and is equal to the distance from the septic tank to the absorption system.

Drainpipe. This is needed for trench and field absorption systems. It can be perforated or open-joint pipe and it must be noncorrosive such as vitrified clay, concrete or plastic. If non-perforated plastic pipe is available, it can be used as (a) perforated pipe by drilling 12mm holes 150mm apart in two parallel rows along the bottom of the pipe, or (b) as open-joint pipe by sawing it into 450mm sections. The amount of pipe needed depends on the length and number of trenches or the size of the field.

For a trench, the amount of drainpipe needed equals the length of the trench. For example, if the trench is 30m long, then 30m of drainpipe is needed.

For a series of trenches, the amount of pipe needed equals the sum of the lengths of all trenches. For example, if there are three trenches whose lengths are 25m, 30m, and 35m, then the amount of drainpipe needed is 25m + 30m + 35m = 90m.

For a field, the amount of pipe needed depends on the length and the number of drainpipes within the field. Since the length and number of pipes depend on: the size of the field, the distance between the lines, and the distance between the outside lines and the sides of the field, it is difficult to calculate the amount of drainpipe

needed. The best way to determine the amount is to consult the technical drawing similar to Figure 5 and add the lengths of the pipelines shown there.

Mortar. This is needed for all systems. It is used to seal all sewer pipe joints and some drainpipe joints, to plug the end of drainpipes in open-end trench systems, and to mortar side walls above the inlet in pit systems. The amount will vary depending on the type of mortar, type and size of system, and so on. For cement mortar (one part portland cement to three parts clean sand and enough clear water to make a workable mix), 0.028 cubic meters may be enough to mortar all necessary pipe joints. A similar amount may be enough to mortar the side walls above the inlet in a pit system.

Concrete. This is needed if the design calls for a concrete distribution box or a concrete cover for a pit. A common concrete mix is one part cement to two parts sand to three parts gravel and enough water to make a fairly stiff mix. See "Designing Septic Tanks," SAN.2.D.3, for details on estimating quantities of concrete mix and reinforcing materials.

Gravel or crushed rock. This is needed for all systems. It may range in size from 12 to 50mm. The amount will depend on the type and size of the system and can be estimated as follows:

for a trench system: length of trench times width of trench times depth of gravel (0.3m)

$$\text{___(m)} \times \text{___(m)} \times 0.3\text{m} = \text{___(m}^3\text{)}$$

for a series of trenches: calculate the amount for each trench and add them together:

$$\text{___(trench 1)} + \text{___(trench 2)} + \text{___(trench 3)} + \text{etc.} = \text{___(m}^3\text{)}$$

for a field: length of field times width of field times depth of gravel (0.3m):

$$\text{___(m)} \times \text{___(m)} \times 0.3\text{m} = \text{___(m}^3\text{)}$$



for a pit: total wall area (from Worksheet A, Line 12, 17, or 23) times space between side wall and earth wall (0.2m):

$$\text{---} (\text{m}^2) \times 0.2\text{m} = (\text{m}^3)$$

Example 1 - a trench 0.6m wide and 40m long:

$$\text{gravel} = 0.6\text{m} \times 40\text{m} \times 0.3\text{m} = 7.2\text{m}^3.$$

Example 2 - three trenches identical to the trench in Example 1:

$$\text{gravel} = 7.2\text{m}^3 + 7.2\text{m}^3 + 7.2\text{m}^3 = 21.6\text{m}^3.$$

Example 3 - a field 12m long by 8m wide:

$$\text{gravel} = 12\text{m} \times 8\text{m} \times 0.3\text{m} = 28.8\text{m}^3.$$

Example 4 - a pit with a wall area of 22m<sup>2</sup>:

$$\text{gravel} = 22\text{m}^2 \times 0.2\text{m} = 4.4\text{m}^3.$$

Other Materials. The quantities of some materials are best estimated according to local conditions, type of material, availability, and local construction methods. Some of these materials are building or tar paper to cover pipe joints; boards, poles, bamboo or other material used to shore up sides of pit; wood and nails used to build concrete forms for distribution box; wire mesh or steel rods used to reinforce concrete; and tar, mortar, or oakum used to seal pipe joints.

Tools. The tools needed will vary according to the type of system and local construction practices. All

systems require one or more shovels or other digging implements to excavate the trench, field, or pit. Other tools that may be useful include a wheelbarrow to cart gravel; hammer, saw, and nails to build shoring for pit walls and to build forms for concrete distribution box; shovel, container, and trowel for mixing, pouring, and smoothing concrete; and carpenter's level and stringline, or equivalent, to check slope of trench. Make your best estimate based on local conditions.

Cost. The cost of the system depends on such things as which materials are already available and which must be purchased; how much labor will be volunteered and how much must be paid; and prices and wage rates. Make your best estimate based on local conditions.

When all calculations, determinations, and estimates have been made, prepare a materials list similar to Table 2 and give it to the construction supervisor.

In summary, give the construction supervisor: (1) a location map similar to Figure 1, showing the absorption system in relation to all nearby man-made structures and geological features; (2) technical drawings similar to Figure 7 (for all systems), Figure 2 (for a trench system), Figures 2 and 3 (for a series of trenches), Figure 4 (for a field system), Figure 5 (for a pit system), and Figure 6 (if there is to be a distribution box); and (3) a materials list similar to Table 2 showing labor, materials, tools, and money needed to construct the system.

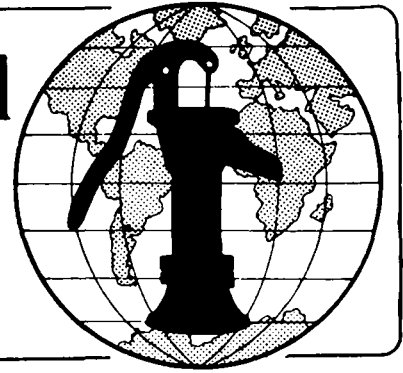
## Notes

## Notes

## Notes

**Technical Notes** are part of a set of "Water for the World" materials produced under contract to the U.S. Agency for International Development by National Demonstration Water Project, Institute for Rural Water, and National Environmental Health Association. Artwork was done by Redwing Art Service. Technical Notes are intended to provide assistance to a broad range of people with field responsibility for village water supply and sanitation projects in the developing nations. For more detail on the purpose, organization and suggestions for use of Technical Notes, see the introductory Note in the series, titled "Using 'Water for the World' Technical Notes." Other parts of the "Water for the World" series include a comprehensive Program Manual and several Policy Perspectives. Further information on these materials may be obtained from the Development Information Center, Agency for International Development, Washington, D.C., 20523, U.S.A.

# Water for the World



## Designing Cesspools

Technical Note No. SAN. 2.D.2

A cesspool is a covered pit with open-joint walls that receives piped sewage. The solids settle to the bottom and the effluent passes through the walls into the surrounding soil. Designing a cesspool involves selecting a location; calculating the size of the cesspool; and determining the labor, materials, and tools needed for construction. The products of the design process are: (1) a location map, (2) a plan view of the cesspool, and (3) a detailed materials list.

This technical note describes how to design a cesspool and arrive at these three end-products. Read the entire technical note before beginning the design process.

### Useful Definitions

**ALLOWABLE RATE OF APPLICATION** - The amount of effluent that the soil in a particular area will absorb in one day expressed in liters per square meter per day ( $1m^2/day$ ).

**EFFLUENT** - Settled sewage.

**GROUNDWATER LEVEL** - The level to which subsurface water rises during any given time of year.

**IMPERVIOUS** - Not allowing liquid to pass through.

**SEWAGE** - All washwater, excreta, and water used to flush excreta that flows from a building or buildings through a sewer pipe and into a septic tank, cesspool, or stabilization pond.

### Materials Needed

Measuring tape - To obtain accurate field information for a location map.

Ruler - To draw a location map.

### Location

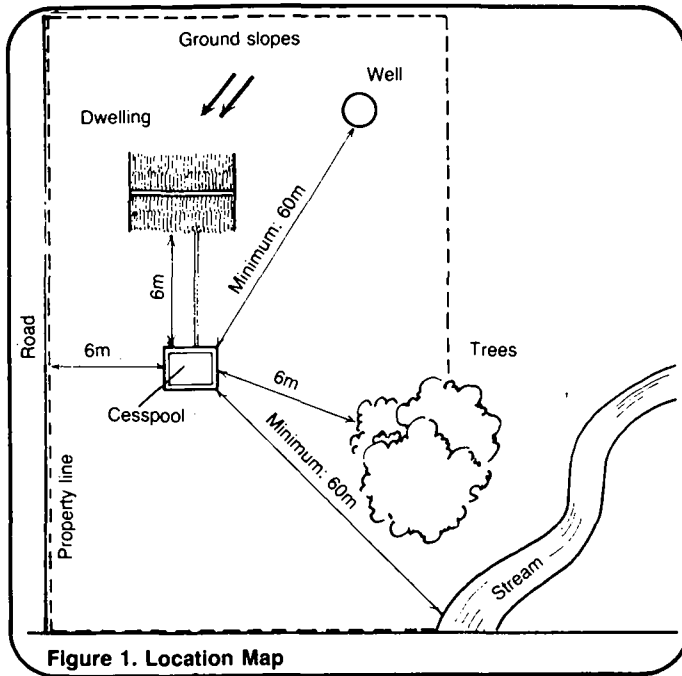
A cesspool should be downhill and at least:

- 60m from the nearest water supply,
- 6m from the nearest dwelling,
- 6m from any property line,
- 6m from bushes or trees.

Do not locate the cesspool in an area where surface water will stand on it or flow over it. After a proposed site has been selected, it must be tested for soil suitability as described in "Determining Soil Suitability," SAN.2.P.3. The test is conducted in two steps and can be generally described as follows.

Step 1. Determine if the highest groundwater level and level of impervious layer are suitable for the cesspool. The bottom of the cesspool must be at least 1.0m above these levels. If these conditions are not acceptable, select another site. If no acceptable site can be found, it will be necessary to design a non-conventional system, (see "Designing Non-Conventional Washwater and Excreta Disposal Systems," SAN.2.D.8), or a sewer system (see "Designing Sewer Systems," SAN.2.D.4, and "Designing Stabilization Ponds," SAN.2.D.5). If the groundwater and impervious layers are acceptable for the cesspool, proceed to the second step.

Step 2. Determine the allowable rate of sewage application by conducting soil percolation tests as described in "Determining Soil Suitability," SAN.2.P.3. The tests should be conducted both at approximately one-half the depth and the total depth of the proposed pit. If the results of the test are unacceptable for the proposed system, select another site and repeat Step #1. If no acceptable site can be found, it will be necessary to design a non-conventional system or a sewer system.



When an acceptable site for a cesspool has been found, draw a location map similar to Figure 1, showing distances from the site to water supplies, dwellings, property lines and trees. Give the map to the construction supervisor before construction begins.

### Calculating the Size

A cesspool may be square, rectangular, or circular. Its size is based on the area of absorbent soil needed. The required area depends on the allowable rate of application (see "Determining Soil Suitability," SAN.2.P.3) and the estimated daily flow of effluent (see "Estimating Sewage or Washwater Flows" SAN.2.P.2). A factor of two is inserted for safety. Thus, the required area equals two times the estimated daily flow expressed in liters per day divided by the allowable rate of application expressed in liters per square meter per day:

$$\text{area} = 2 \times \frac{\text{estimated daily flow}}{\text{allowable rate of application}}$$

$$\text{area} = 2 \times \frac{\text{liters per day}}{\text{liters per square meter per day} = \text{square meters}}$$

For example, suppose that the estimated daily flow is 850 liters per day and the allowable rate of application is 61.1 liters per square meter per day. Then the required area equals:

$$2 \times \frac{850 \text{ liters/day}}{61.1 \text{ liters/m}^2/\text{day}} = 27.8\text{m}^2$$

(Worksheet A, Lines 1-3).

The required area of absorbent soil is 27.8m<sup>2</sup>. For a cesspool, this must be the area of the sidewalls below the inlet. The bottom area is not included, because the bottom of a cesspool will rapidly clog with settled solids and become nearly impervious. If the pit is square or rectangular, find the total area by adding the areas of the four earth walls below the inlet. For a circular pit, determine the area by calculating the area of the circular wall below the inlet. When calculating the area of a circular pit, use the following equation: circumference = 3.1 times diameter.

Some examples of cesspool sizes, assuming that the area of absorbent soil is 27.8m<sup>2</sup>:

A square cesspool could be 3.0m on each side and 2.32m deep below the inlet. The area of each side is 3.0m x 2.32m = 6.96m<sup>2</sup>. The effective area of the cesspool is the sum of all four sides, or 4 x 6.96m<sup>2</sup> = 27.8m<sup>2</sup> (see Worksheet A, Lines 4-6).

A rectangular cesspool could be 2.23m wide by 2.4m long by 3.0m deep below the inlet. The area of the two ends equals 2 x 2.23m x 3.0m = 13.4m<sup>2</sup>. The area of two sides equals 2 x 2.4m x 3.0m = 14.4m<sup>2</sup>. The effective area of the cesspool is the sum of the areas of the ends and the sides or 13.4m<sup>2</sup> + 14.4m<sup>2</sup> = 27.8m<sup>2</sup> (Worksheet A, Lines 7-10).

A circular cesspool could be 3.0m in diameter and 3.0m deep below the inlet. The circumference is 3.0m x 3.1 = 9.3m. The effective area of the cesspool equals the area of the circular wall, which is the circumference times the depth below the inlet or 9.3m x 3.0m = 27.9m<sup>2</sup> (Worksheet A, Lines 11-13). It is permissible for the effective area of the cesspool to be greater than the required area of absorbent soil.

### Worksheet A. Calculations for Cesspool

1. Allowable rate of application (from "Determining Soil Suitability," SAN.2.P.3) 61.1 liters/m<sup>2</sup>/day
2. Estimated daily flow of effluent (from "Estimating Sewage or Washwater Flows," SAN.2.P.2) 850 liters/day
3. Required area of absorbent soil =  $\frac{\text{Line 2}}{\text{Line 1}} = \underline{27.8 \text{ m}^2}$

Type of cesspool (check one):  square  rectangular  circular

#### Square Cesspool

4. Proposed length of each side = 3.0 m
5. Circumference of pit = 4 x Line 4 = 4 x 3.0 m = 12.0 m
6. Depth below inlet =  $\frac{\text{Line 3}}{\text{Line 5}} = \frac{(27.8 \text{ m}^2)}{(12.0 \text{ m})} = \underline{2.32 \text{ m}}$

#### Rectangular Cesspool

7. Proposed length = 2.4 m
8. Proposed width = 2.23 m
9. Circumference of pit = (2 x Line 7) + (2 x Line 8) =  
(2 x 2.4 m) + (2 x 2.23 m) = 9.26 m
10. Depth below inlet =  $\frac{\text{Line 3}}{\text{Line 9}} = \frac{(27.8 \text{ m}^2)}{(9.26 \text{ m})} = \underline{3.0 \text{ m}}$

#### Circular Cesspool

11. Proposed diameter = 3.0 m
12. Circumference of pit = 3.1 x Line 11 = 3.1 x 3.0 m = 9.3 m
13. Depth below inlet =  $\frac{\text{Line 3}}{\text{Line 12}} = \frac{(27.8 \text{ m}^2)}{(9.3 \text{ m})} = \underline{3.0 \text{ m}}$
14. Approximate quantity of sidewall materials = 0.3m x Line 3 =  
0.3m x 27.8 m<sup>2</sup> = 8.34 m<sup>3</sup>
15. Approximate quantity of filler material = 0.2m x Line 3 =  
0.2m x 27.8 m<sup>2</sup> = 5.56 m<sup>3</sup>

When the size and configuration of the cesspool have been determined, prepare a plan view similar to Figure 2 showing the correct length, width (or diameter), and depth below the inlet. Give the drawing to the construction supervisor before construction begins.

#### Selecting Materials

All materials should be locally available and should meet the design criteria described for them.

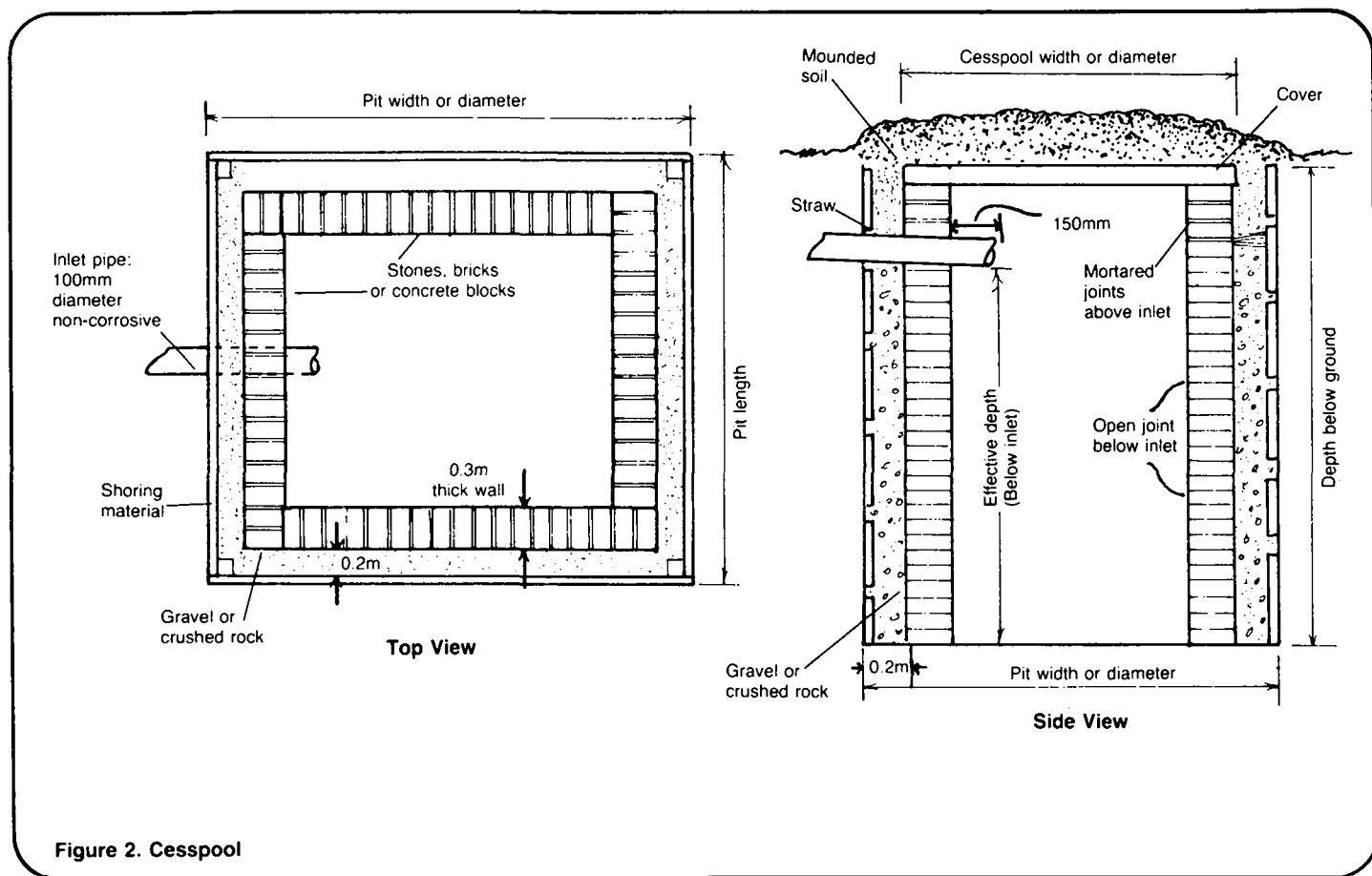


Figure 2. Cesspool

**Sidewalls.** These can be made of bricks, concrete blocks, select field stones, or similar material. The walls should be about 0.3m thick and are laid up about 0.2m from the earth walls of the pit. They are open-jointed below the inlet and mortared together above the inlet for strength. The quantity of sidewall material depends on the size of the cesspool and the type of material used. The quantity is approximately equal to the required area of absorbent soil times 0.3m, the thickness of the walls. For example, if the required area is  $27.8\text{m}^2$ , the approximate quantity is  $27.8\text{m}^2 \times 0.3\text{m} = 8.34\text{m}^3$  (see Worksheet A, Line 14).

**Filler.** The space between the sidewalls and the earth walls must be filled with gravel, pebbles, or crushed rock. The quantity needed is approximately equal to the required area of absorbent soil times 0.2m, the space between the sidewalls of the cesspool and the earth walls of the pit. For example, if the required area is  $27.8\text{m}^2$ , the approximate quantity of filler material is  $27.8\text{m}^2 \times 0.2\text{m} = 5.56\text{m}^3$  (Worksheet A, Line 15).

**Sewer pipe.** This pipe carries sewage from the dwelling to the cesspool. It is generally 100mm in diameter, and it must be made of non-corrosive material such as vitrified clay, concrete, or special plastic. The length of the pipe is approximately equal to the distance from the dwelling to the cesspool.

**Cover.** The cover can be made of metal or concrete and can be in one piece or in sections. It must be strong enough to support the weight of the approximately 0.3m of soil that will cover it and to prevent a person from falling into the cesspool. It must be waterproof. If the cover is made of concrete, see "Designing Septic Tanks," SAN.2.D.3, for information.

**Shoring.** For pits deeper than 1.5m, the sides must be shored with bamboo, boards, logs, poles, or similar material to prevent a cave-in that could be fatal to a worker in the pit.

### Selecting Tools

Use locally available tools such as picks and shovels to excavate the pit.



A wheelbarrow will be useful to haul materials to the site and haul excavated soil away. A hammer, saw and nails may be needed to construct shoring. Containers will be needed to mix mortar for sidewalls above the inlet.

### Selecting Labor

At least two, and preferably more, able-bodied workers will be needed to excavate the pit. At least one worker should have some experience with mixing and applying mortar. When all

necessary materials, tools and labor have been determined, draw up a materials list similar to Table 1 and give it to the construction supervisor before construction begins.

In summary, give the construction supervisor a location map similar to Figure 1, a plan view of the cesspool similar to Figure 2, and a materials list similar to Table 1.

**Table 1. Sample Materials List**

Item	Description	Quantity	Estimated Cost
Labor	Foreman	1	_____
	Laborers	3	_____
Supplies	Bricks for sidewalls	_____	_____
	Gravel for filler	_____	_____
	Concrete for cover	_____	_____
	Mortar or tar for water-proofing	_____	_____
	Inlet pipe (100mm, non-corrosive)	_____	_____
	Straw	_____	_____
	Shoring material	_____	_____
	Nails	_____	_____
Tools	Other	_____	_____
	Measuring tape	1	_____
	Shovels	4	_____
	Picks	1	_____
	Wheelbarrow	1	_____
	Containers for mixing concrete	2	_____
	Hammer	1	_____
	Saw	1	_____
Other	_____	_____	

Estimated Cost = \_\_\_\_\_

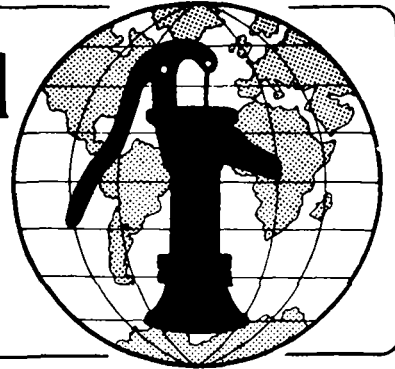
## Notes

## Notes

## Notes

**Technical Notes** are part of a set of "Water for the World" materials produced under contract to the U.S. Agency for International Development by National Demonstration Water Project, Institute for Rural Water, and National Environmental Health Association. Artwork was done by Redwing Art Service. Technical Notes are intended to provide assistance to a broad range of people with field responsibility for village water supply and sanitation projects in the developing nations. For more detail on the purpose, organization and suggestions for use of Technical Notes, see the introductory Note in the series, titled "Using 'Water for the World' Technical Notes." Other parts of the "Water for the World" series include a comprehensive Program Manual and several Policy Perspectives. Further information on these materials may be obtained from the Development Information Center, Agency for International Development, Washington, D.C., 20523, U.S.A.

# Water for the World



## Designing Septic Tanks Technical Note No. SAN. 2.D.3

Designing a septic tank involves selecting a location for the tank, calculating the tank's capacity and dimensions, and determining the necessary labor, materials, and tools. The products of the design process are (1) a location map, (2) a plan and elevation view of the tank, and (3) a detailed materials list. These items should be given to the construction foreman before construction begins.

This technical note describes how to design a septic tank and arrive at these three end-products. Read the entire technical note before beginning design procedures.

### Materials Needed

Measuring tape - To obtain accurate field information for a location map

Ruler - To draw a location map

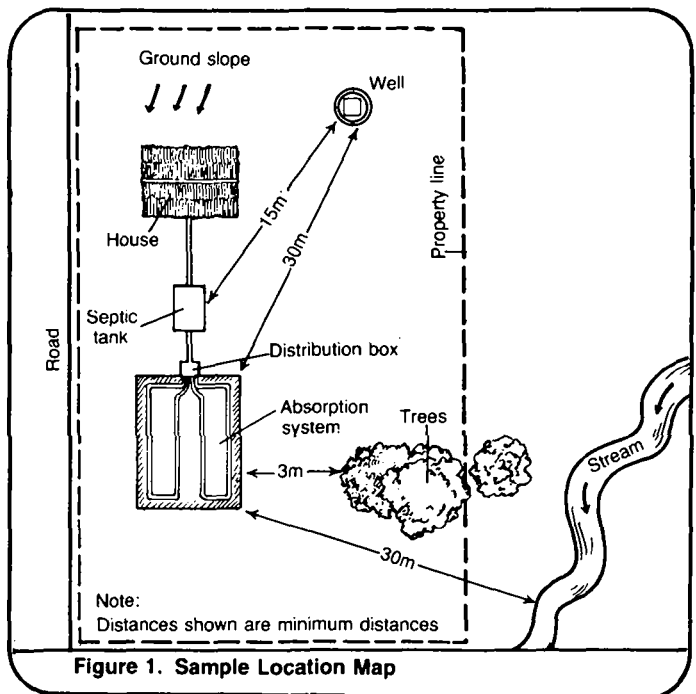
### Location

Locate the septic tank downhill and at least:

- 15m from the nearest water supply, including the neighbors',
- 3m from the nearest building,
- 3m from the property line.

Do not put the septic tank in an area where rainwater or other surface water will flow over or stand on it, or where vehicles will drive over it. When looking for a location for the septic tank, draw a map of the lot showing actual distances from the septic tank to water supplies, dwellings, property lines, vegetation, any other manmade or prominent geographical features, and the proposed (or actual) site of the subsurface absorption system (see "Designing Subsurface Absorption Systems," SAN.2.D.1).

Figure 1 is a sample location map. The actual location map will be needed by the construction foreman prior to and during construction, and will enable him to locate the system properly.



### General Design Information

Study Figure 2 while following these steps.

1. All sewage from the building to be served should enter the septic tank. This includes both excreta and wash-water, but it does not include rain-water, surface water, or subsurface drainage.

2. The septic tank walls may be made of poured reinforced concrete, brick, concrete blocks, or stone masonry. The walls must be watertight. A 25mm thick inside coating of cement plaster, usually applied in two 12mm coats, is needed to make laid-up walls watertight.

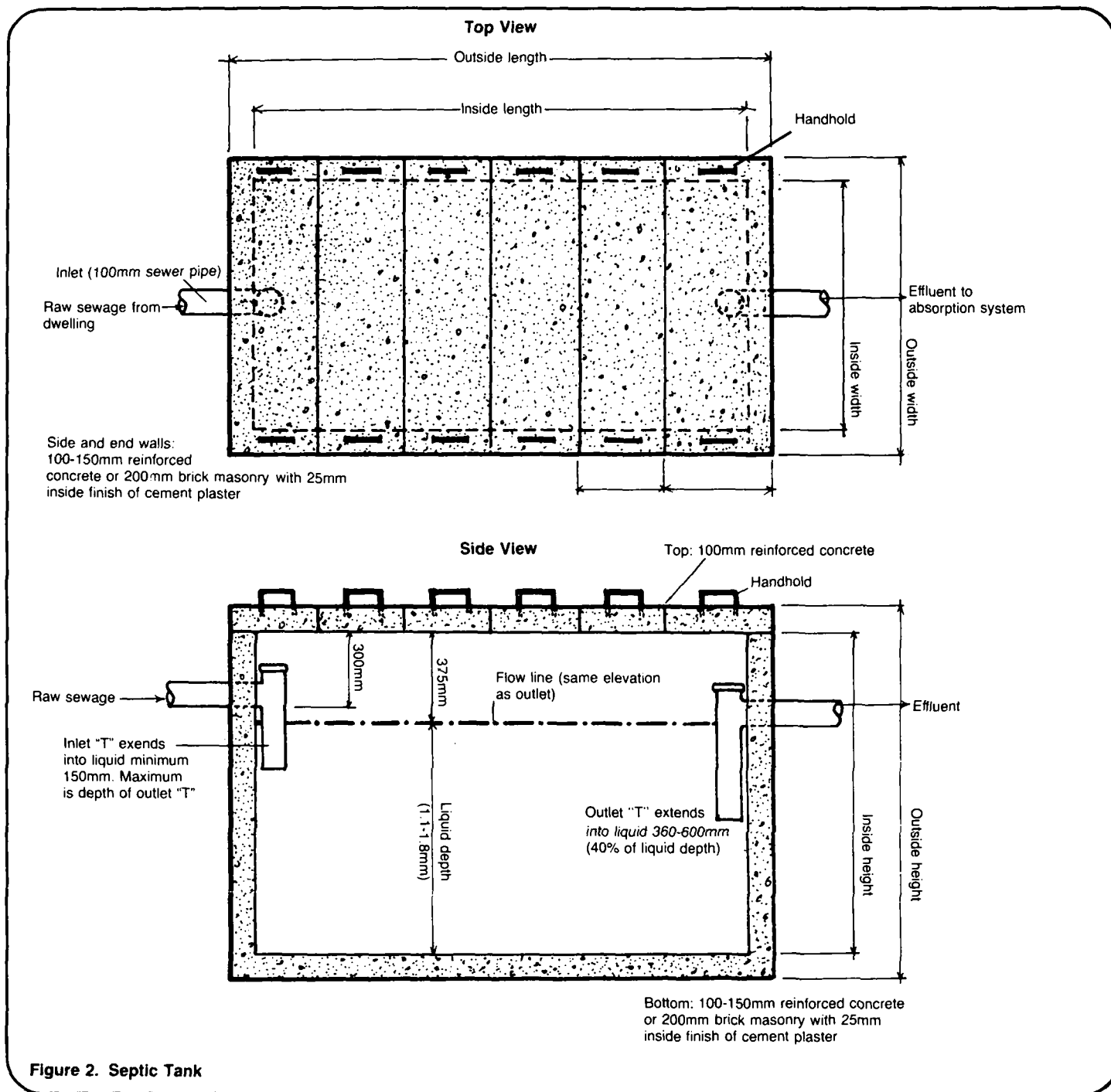


Figure 2. Septic Tank

3. The floor of the septic tank should be made of reinforced concrete 100-150mm thick and should rest on a bed of gravel or sand 75mm thick.

4. The tank must have a strong, watertight top, usually made of reinforced concrete. The top should be designed in 300mm wide sections, with each section as long as the septic tank is wide and equipped with a handhold near each end. One or two sections over the outlet end can be removed to inspect the tank. All or most of the sections can be removed to clean the tank.

5. Predesigned, prefabricated tanks may be available. They are made of fiberglass, precast reinforced concrete, or steel. The most important consideration with these tanks is selecting the proper capacity (see next page, "Steps in Design").

6. The recommended liquid depth in the tank is 1.2m, however, it may be as shallow as 1.1m or as deep as 1.8m.

7. The length of the tank is two to three times its width (see Table 1).

8. The bottom of the inlet pipe (the pipe entering the septic tank, not the "T" fitting) is 300mm below the top of the tank. The bottom of the outlet pipe (the pipe leaving the septic tank, not the "T" fitting) is 75mm below the bottom of the inlet pipe, or 375mm below the top of the tank (see Figure 2).

9. The inlet and outlet pipes are fitted with open "T" sewer pipe fittings.

10. The sewer pipe from the source of sewage to the septic tank and from the septic tank to the subsurface absorption field is made of vitrified clay, concrete, special plastic, or other noncorrosive material, and is usually 100mm in diameter.

11. After the tank has been constructed and installed, the space between the septic tank's outside walls and the earth sides of the hole should be carefully filled and the septic tank should be covered with dirt to grade level or above.

**Table 1. Suggested Septic Tank Dimensions**

Volume liters	Length, inside meters	Width, inside meters	Liquid Depth meters
1100	1.5	0.7	1.1
1500	1.8	0.9	0.9
1900	1.8	0.9	1.2
2800	2.3	1.1	1.2
3800	2.7	1.2	1.2
4700	3.4	1.2	1.2
5700	3.2	1.5	1.2
7600	4.3	1.5	1.2
9500	4.4	1.8	1.2
11000	5.2	1.8	1.2
13000	4.9	1.8	1.5
15000	4.9	2.2	1.5
19000	5.9	2.2	1.5
23000	6.2	2.4	1.5
26000	7.3	2.4	1.5
30000	7.0	2.4	1.8
38000	8.5	2.4	1.8

## Steps in Design

Refer to Worksheet A in following these steps. This is only a sample that has been filled out; you will need to prepare one for your use.

1. Determine how much sewage will enter the septic tank during each 24-hour period (see "Estimating Sewage or Washwater Flows," SAN.2.P.2).

2. Determine the desired retention time. It should be a minimum of one day and a maximum of three days. When determining retention time, consider the following:

(a) A longer retention time requires a larger tank, and thus a higher initial cost. However, a larger tank needs to be cleaned less often than a smaller one. Larger tanks also treat the sewage more, which increases the life of the subsurface absorption system.

(b) A shorter retention time requires a smaller tank, and thus reduces the initial cost.

3. Determine the capacity of the tank. Do this by multiplying the daily flow by the retention time (in days). For example:

Suppose that the estimated daily flow of sewage is 1500 liters, and the desired retention time is 2.5 days. The tank capacity is 1500 liters a day times 2.5 days: the tank capacity equals 3800 liters.

4. Is the type of building the system is being designed for a family dwelling or public building? If it is a family dwelling, go to step 5. If it is a public building, go to step 4a.

4a. Septic tanks for certain types of public buildings, such as schools, stores, and factories, must be large enough to receive sewage when all or most of the sewage flow takes place within a few hours. For such buildings, first determine the normal size of the septic tank (steps 1, 2, and 3). In this example, the flow is 3800 liters a day.

### Worksheet A. Steps in Design

1. Sewage flow for 24 hours (from SAN.2.P.3): 1500 liters/day
2. Retention time: 2.5 days
3. Tank capacity (step 1 x step 2): 1500 x 2.5 = 3800 liters
4. Type of building served:
 

Home. Go to step 5
 Public. Go to step 4a

  - 4a. Normal tank capacity (step 3): 3800 liters
  - 4b. Number of hours building in use: 8 hours
  - 4c. Size adjustment factor:  $\frac{24 \text{ hours}}{4b} = \underline{3}$
  - 4d. Adjusted size: 4c x 4a = 11400 liters
5. Inside tank dimensions from Table 1 (using capacity from step 3 or step 4d):
 

Length: 2.7 m                      Width: 1.2 m

Height: 1.2 (liquid depth) + 0.375m (1.25 feet) = 1.575 m
6. Thickness (from Table 2):
 

Top: 100 mm                      Bottom: 100 mm                      Walls: 100 mm
7. Outside dimensions (from steps 5 and 6):
 

Outside length = inside length + 2 end walls  
 = 2.7 m + 100 mm + 100 mm  
 = 2.9 m

Outside width = inside width + 2 walls  
 = 1.2 m + 100 mm + 100 mm  
 = 1.4 m

Outside height = inside height + top + bottom  
 = 1.575 m + 100 mm + 100 mm  
 = 1.775 m

4b. Determine the number of hours when all or most of the sewage flow takes place, for example, 8 hours.

4c. Divide 24 hours by the number of hours from 4b to find the size adjustment factor. Thus  $\frac{24}{8} = 3$ .

4d. Multiply the size adjustment factor (4c) by the normal size of the tank (4a) to find the required capacity, which is the adjusted size of the tank.

5. Use Table 1 to find the inside tank dimensions. Table 1 shows the liquid depth. The inside height is the liquid depth plus 375mm.

6. Use Table 2 to find the thickness of the top, bottom, and walls.

7. Using the information from Tables 1 and 2, calculate the outside dimensions of the septic tank.

**Table 2. Septic Tank Reinforced Concrete Slab Thicknesses**

Slab	Tank Capacity			
	3800 liters or less	3800-7600 liters	7600-23000 liters	23000-38000 liters
top	100mm	100mm	150mm	150mm
bottom	100mm	100mm	150mm	150mm
walls	100mm*	150mm	150mm	200mm

\*For walls of tanks of 3800 liters or less you may substitute 200mm brick or stone masonry with a 25mm cement plaster inside finish (applied in two 12mm layers).

8. Using the calculations from steps 1 through 7 and the information in Figure 2, prepare a plan view (top, side, and end views) of the septic tank. Figure 3 shows a blank plan



view. Fill in all dimensions ("mm" indicates where a dimension must be filled in), and give the completed plan view to the construction foreman to use in constructing the septic tank.

### Materials List

In addition to the location map and the plan view, give the construction foreman a materials list. Table 3 shows a sample materials list; you should prepare a completed one for the construction foreman. The list must include number of laborers, types and quantities of materials, and tools necessary to construct the septic tank. This technical note provides some quantities and the means for calculating others. The remaining quantities will have to be determined in the field by the project designer or the construction foreman.

**Labor.** Labor requirements will depend in part on whether the tank is reinforced concrete, stone masonry, or prefabricated.

- All tanks: a foreman and at least two workers; additional workers would be helpful, especially in excavating the hole.

- Reinforced concrete tank: at least one worker with some knowledge of or experience with reinforced concrete (mixing and pouring, positioning reinforcing material, and building forms).

- Stone masonry: at least one worker with experience with stone masonry (mixing mortar and laying bricks).

**Concrete.** When calculating the amounts of cement, sand, gravel, and water needed for concrete, keep the following two points in mind:

- A common mix by volume is one part cement, two parts sand, three parts gravel, and two-thirds of a part water. In percentages of the total amount, this mix is 15 percent cement; 30 percent sand; 45 percent gravel; and 10 percent water.

- The mixed concrete is about two-thirds the original volume of all the parts.

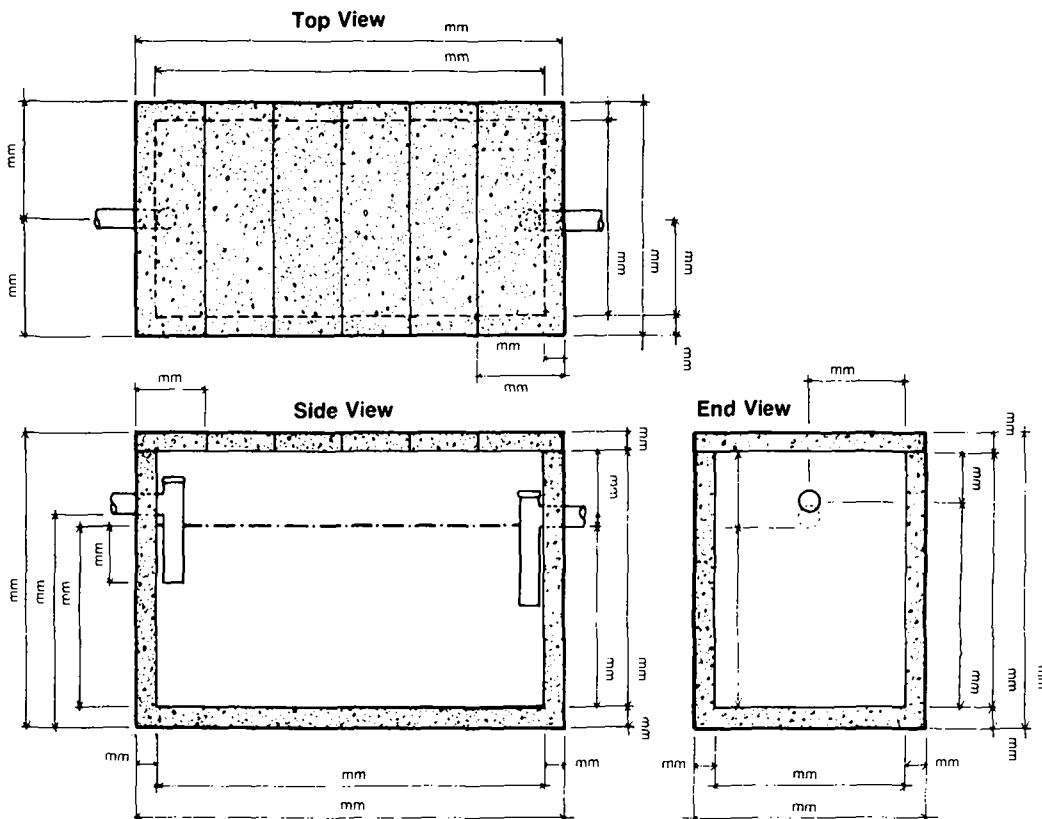


Figure 3. Technical Drawing of Septic Tank

**Table 3. Sample Materials List**

Item	Description	Quantity	Estimated Cost
Labor	Foreman	1	_____
	Laborers (NOTE: Either the foreman or one of the laborers must have some experience with concrete work.)	2 (at least)	_____
Supplies	Portland cement	0.5m <sup>3</sup>	_____
	Sand; clean, fine to 6mm	0.9m <sup>3</sup>	_____
	Gravel; clean, 6-38mm	1.4m <sup>3</sup>	_____
	Water (enough to make a fairly stiff mixture; quantity is a rough estimate)	300 liters	_____
	Wire mesh (reinforcing material)	21m <sup>2</sup>	_____
	Sewer pipe 100mm diameter vitrified clay	_____ m: enough to reach from dwelling to septic tank and from tank to field, plus several sections to be used as extensions to "T" fittings	_____
	"T" sewer pipe fittings (for inlet and outlet)	2	_____
	Gravel for bedding material	_____ m: enough to spread under tank to a depth of 75mm	_____
	Wooden boards (for building forms)	_____	_____
	Timber, bamboo, or wood (for shoring up sides of hole)	_____	_____
	Tar or equivalent (for waterproofing top of tank)	_____	_____
	Nails (for building forms)	_____	_____
Handholds (horseshoes or other bent pieces of metal)	10 (2 for each section of top)	_____	
Tar, mortar, or oakum (for sealing pipe joints)	_____	_____	
Other	_____	_____	
Tools	Measuring Tape	1	_____
	Shovels	2 (at least; one per worker)	_____
	Bucket	1	_____
	Container for mixing concrete (or hand mixer)	1	_____
	Hoe	1	_____
	Trowel	1	_____
	Saw	1	_____
	Hammer	1	_____
	Plumb line (rock and string)	1	_____
	Carpenter's level or equivalent (extremely useful, through not essential)	1	_____
	Carpenter's square or equivalent (extremely useful, through not essential)	1	_____
	Other	_____	_____

Total Estimated Cost \_\_\_\_\_

DO NOT USE THE QUANTITIES IN THIS SAMPLE - CALCULATE YOUR OWN

## Worksheet B. Calculating Quantities Needed for Concrete

1. Volume of mixed concrete (dimensions from Worksheet A):
  - a. top = outside length x outside width x thickness  
 = 2.9 m x 1.4 m x 0.1 m = 0.4 m<sup>3</sup>
  - b. bottom = outside length x outside width x thickness  
 = 2.9 m x 1.4 m x 0.1 m = 0.4 m<sup>3</sup>
  - c. two sides = inside length x inside height x thickness x 2  
 = 3.7 m x 1.575 m x 0.1 m x 2 = 0.9 m<sup>3</sup>
  - d. two ends = inside width x inside height x thickness x 2  
 = 1.2 m x 1.575 m x 0.1 m x 2 = 0.4 m<sup>3</sup>
  - e. total mixed volume = steps 1 + 2 + 3 + 4 = 2.1 m<sup>3</sup>
2. Unmixed volume = step e x 1.5 = 2.1 m<sup>3</sup> x 1.5 = 3.15 m<sup>3</sup>
3. Volume of each material:
 

cement: 0.15 x step b = <u>0.5</u> m <sup>3</sup>	gravel: 0.45 x step b = <u>1.4</u> m <sup>3</sup>
sand: 0.30 x step b = <u>0.9</u> m <sup>3</sup>	water: 0.10 x step b = <u>0.3</u> m <sup>3</sup>

(NOTES: Quantities of each material may be rounded off to the nearest 1/10th cubic meter.

Volumes of water may be converted to liquid measure as follows:  
cubic meters times 1000 equals liters

The volume of water depends in part on the wetness of the sand, and need not be measured so much as added by "feel"; that is, enough water is needed to make a fairly stiff mix.

Cement is generally ordered "by the sack." Since the standard volume of a sack varies from region to region, determine the volume per sack from the supplier of cement, then divided the volume of cement required by the volume per sack to determine how many sacks to order. If the number is a fraction, round up to the next whole number.  
volume required + volume per sack = number of sacks)

To calculate the quantities of cement, sand, gravel, and water, follow these steps:

1. Determine the required volume of mixed concrete within the wooden forms for the top, bottom, two sides, and two ends of the tank.

2. Divide the total volume by two-thirds (or multiply by 1.5) to find the unmixed volume.

3. Multiply the pre-mixed volume by each of the percentages (or decimal equivalent: .15, .30, .45, .10) to determine the approximate quantity of cement, sand, gravel, and water required. The quantities are only approximate because the finished volume depends on the wetness of sand, the size of gravel, and so on.

For example, suppose the septic tank has a capacity of 3800 liters. First, calculate the dimensions of the tank as in Worksheet A. Then proceed with steps (1), (2), (3) above using a form like Worksheet B for the calculations. This worksheet is only a sample that has been filled out; you will need to prepare one for your use.

1. The volume of the top is the outside length times the outside width times the thickness. The outside dimensions are used because the top must span the inside dimensions plus the thicknesses of the walls.

The volume of the bottom is the same as the volume for the top.

The volume of the two side walls is the inside length times the inside height times the thickness times two.

The volume of the end walls is the inside width times the inside height times the thickness times two.

The total mixed volume is the sum of all these volumes, in this example  $2.1m^3$ .

2. Multiply the mixed volume by 1.5 to determine the unmixed volume. In this example, the unmixed volume is  $3.15m^3$ .

3. Multiply the unmixed volume by each percentage to find the quantity of each material. In this example, the quantities are:

cement  $0.5m^3$   
 sand  $0.9m^3$   
 gravel  $1.4m^3$   
 water  $0.3m^3$  (300 liters)

Reinforcing material. If the reinforcing material is chain-link fencing or wire mesh, the quantity will be approximately equal to the combined surface area of each slab. Add the area of the top plus the area of the bottom plus the area of the two sides plus the area of the two ends. The area of the top is the outside length times the outside width; the area of the two ends is the inside width times the inside height times two (see Worksheet B).

If the reinforcing material is steel bars, sketch each slab (see Figure 4), draw in the bars using the criteria given in Figure 4, and count the bars. Remember, a separate quantity is needed for each length of bar.

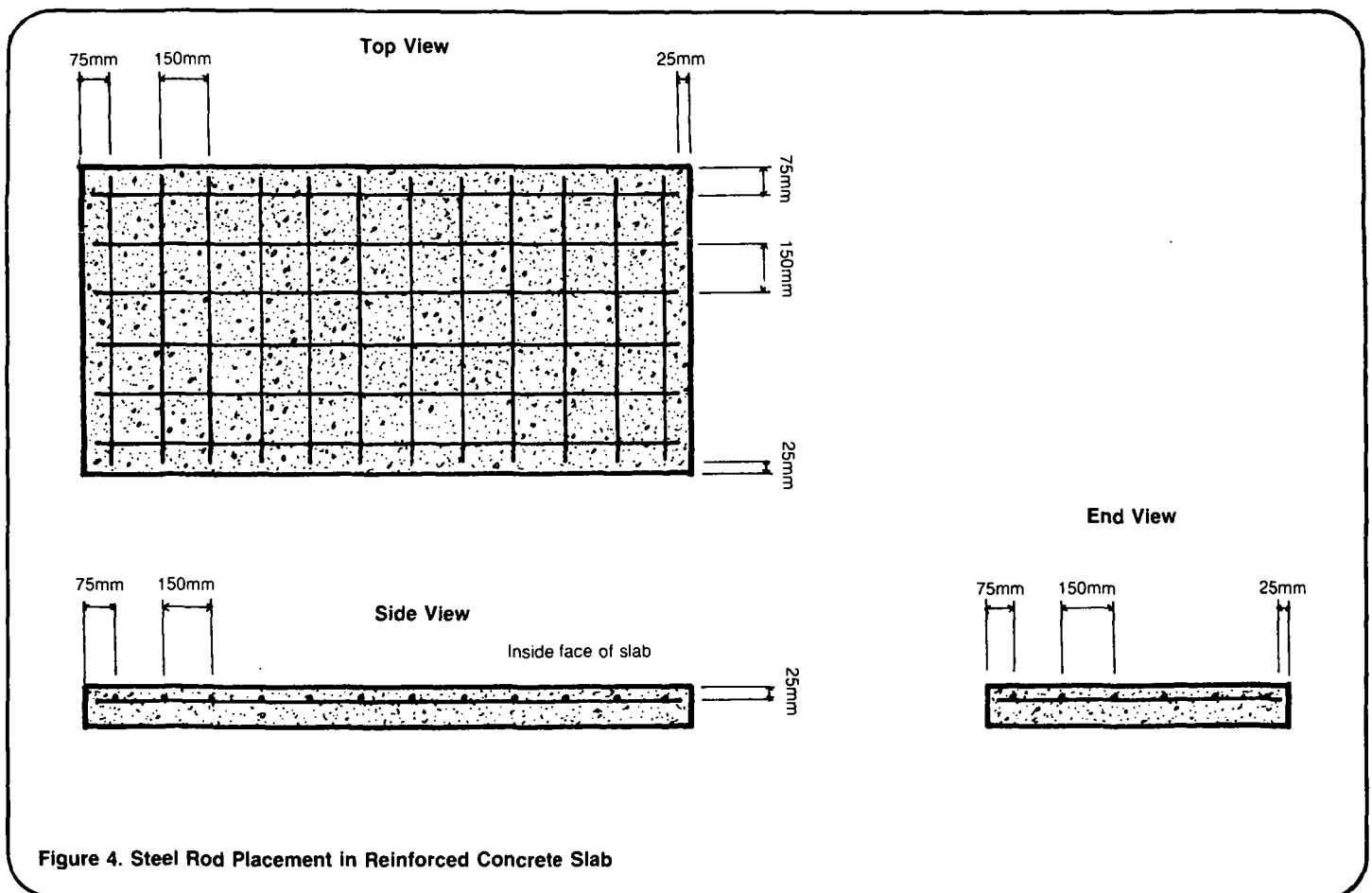


Figure 4. Steel Rod Placement in Reinforced Concrete Slab

**Sewer pipe.** The pipe must be of noncorrosive, durable material such as cast-iron soil pipe, vitrified clay, concrete, bituminized fiber, asbestos cement, or plastic. The trench line for the pipe should be as straight as possible from the dwelling to the septic tank and from the tank to the absorption field. Avoid bends. Plan the pipe line so that it falls evenly and smoothly from the dwelling to the tank with a slope of from 1 in 50 to 1 in 100, and from the tank to the field with a slope of 1 in 100. Figure 5 shows the slope of these pipes. The total length of pipe needed will be the distance along the trench line from the dwelling to the tank and from the tank to the absorption field (see "Designing Subsurface Absorption Systems," SAN.2.D.1). Sewer pipe is generally 100mm in diameter.

When labor requirements, materials, (including concrete mix, reinforcing materials, and sewer pipe), and tools have been decided, prepare a materials list and give it to the construction foreman.

### Important Considerations

1. The location of the septic tank is vital. (Review section on location.) Provide the construction foreman with a map similar to Figure 1,

showing actual distances from the septic tank to dwellings, water supplies, roads, and other man-made or prominent features.

2. The entire system must be designed so that sewage moves by gravity flow from the building, through the septic tank, and to the subsurface absorption system. As Figure 5 indicates:

- (a) The septic tank inlet must be lower than the sewer line;
- (b) The septic tank outlet must be lower than the inlet, usually 75mm lower;
- (c) The distribution box, if there is one, must be lower than the septic tank outlet;
- (d) The subsurface absorption system must be lower than the distribution box.

All of these elevations must be checked both on a drawing and in the field prior to and during construction. (see "Designing Subsurface Absorption Systems," SAN.2.D.1).

Give the construction foreman a location map and plan view of the septic tank containing all necessary dimensions and a detailed materials list with quantities of all materials needed.

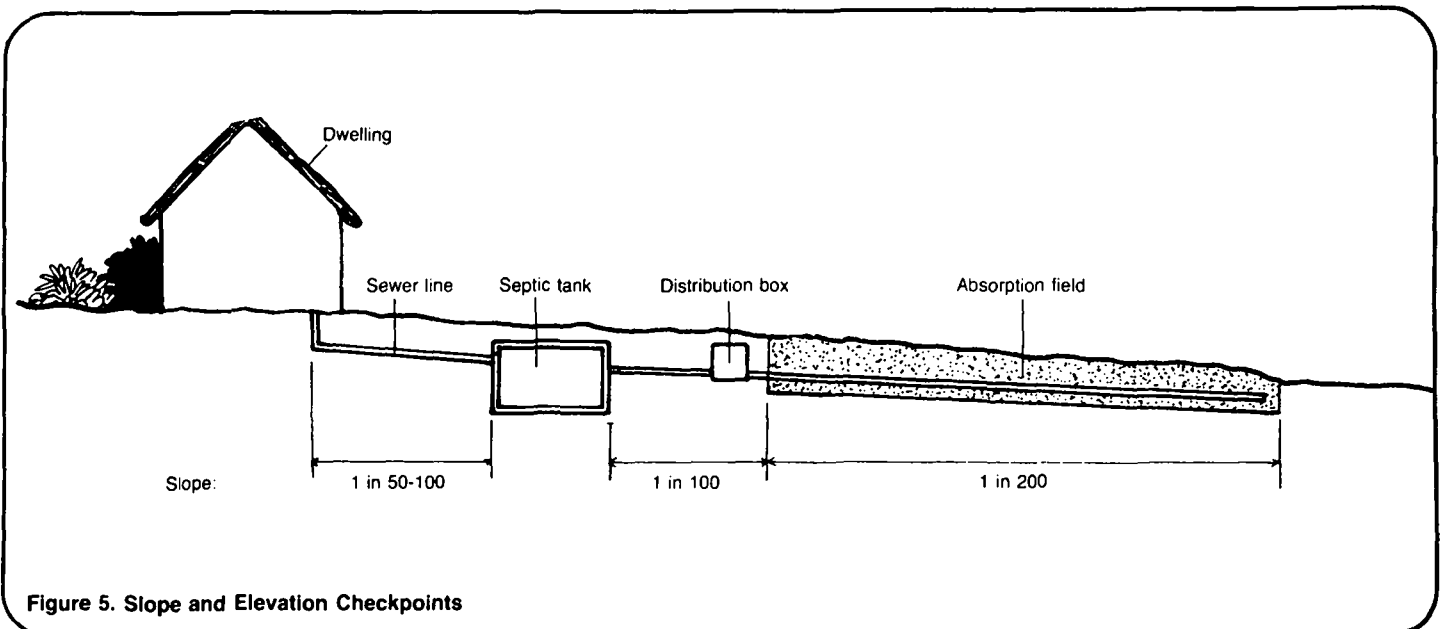


Figure 5. Slope and Elevation Checkpoints

## Notes

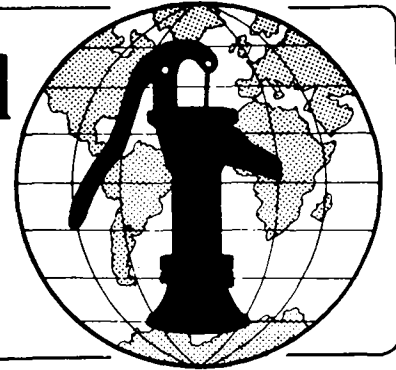
## Notes

## Notes

**Technical Notes** are part of a set of "Water for the World" materials produced under contract to the U.S. Agency for International Development by National Demonstration Water Project, Institute for Rural Water, and National Environmental Health Association. Artwork was done by Redwing Art Service. Technical Notes are intended to provide assistance to a broad range of people with field responsibility for village water supply and sanitation projects in the developing nations. For more detail on the purpose, organization and suggestions for use of Technical Notes, see the introductory Note in the series, titled "Using 'Water for the World' Technical Notes." Other parts of the "Water for the World" series include a comprehensive Program Manual and several Policy Perspectives. Further information on these materials may be obtained from the Development Information Center, Agency for International Development, Washington, D.C., 20523, U.S.A.



# Water for the World



## Designing Sewer Systems Technical Note No. SAN. 2.D.4

A sewer system is a network of underground pipes that carries sewage by gravity flow from a number of dwellings. The sewage may be a direct flow of wastewater from water-flushed sanitary facilities or the effluent of settled sewage from septic tanks or aqua privies. It flows to a stabilization pond or other central treatment facility. Designing a sewer system requires the services of an experienced engineer and surveyor. Designing involves making precise field measurements of distance and elevation; determining the position, grade, and lengths of pipelines; and determining labor, materials, and tools needed for construction. The end-products of the design process are precise maps and profile drawings, and a detailed materials list.

This technical note describes the elements involved in designing a sewer system. It does not attempt to explain everything needed to design a sewer system.

### Useful Definitions

**BASE POINT** - A point of reference from which all other points are measured.

**EFFLUENT** - Settled sewage.

**GRAVITY FLOW** - Flow of water from high ground to low by natural forces.

**INVERT** - The inside bottom of a pipe; that is, the pipe's lowest inside surface.

### Materials Needed

**Survey equipment** - To obtain precise field information.

**Drafting equipment** - To produce accurate maps and profile drawings.

**Manufacturer's list of pipe and fittings** - To refer to during the design process and to prepare cost estimates.

### Steps in Design

One method of designing a sewer system leading to a stabilization pond is to follow these five steps:

1. Obtain an accurate contour map of the area to be served. The map must show all houses and buildings, roads, streams, trees, other prominent features, and the proposed site for the stabilization pond. See "Designing Stabilization Ponds," SAN.2.D.5. If such a map is unavailable, one will have to be produced. This will require a survey of the area. The survey generally begins at a base point established near the outlet of the sewer system which is the inlet of the stabilization pond. The base point is assigned an arbitrary elevation, such as 100m and all elevations and distances are measured from it. See Figure 1.

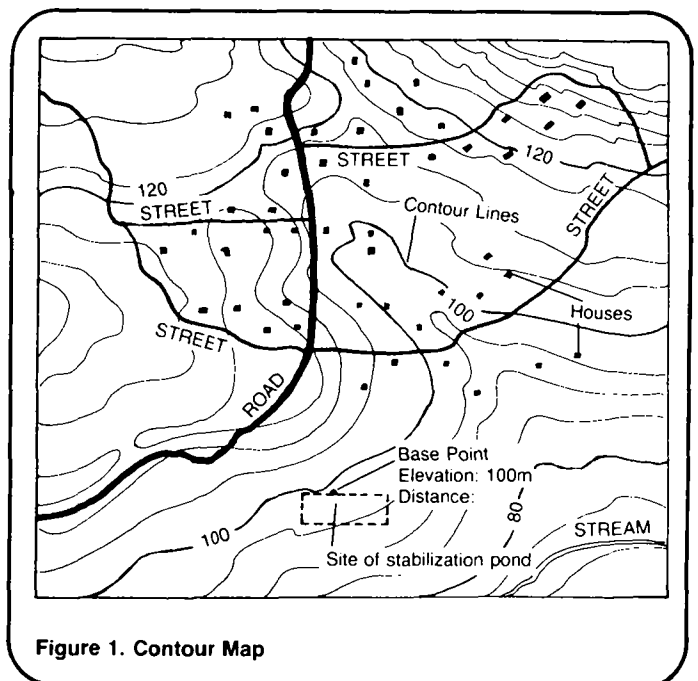


Figure 1. Contour Map

2. Pencil in the proposed sewer lines on the contour map. There are basically three types of sewer lines. The main line runs through the center of the system. All lines empty into it and it empties into the stabilization pond. Main lines generally have a pipe diameter of 200-300mm. Branch lines extend from the main line much like branches from the trunk of a tree. The sewage from one or more buildings empties into a branch line which usually has a diameter of 100mm. House laterals, usually 100mm in diameter, carry sewage from a single septic tank to a branch line. All sewer pipes are laid out in straight lines wherever possible and generally meet at right angles. The connection may be curved to ease the flow from the branch to the main.

3. Draw profile sections of the ground line for the sewer main line and branches. This may or may not require more field measurement, depending on the degree of detail on the contour map. See Figure 2.

4. Draw the sewer lines on the profile sections. House laterals slope down to branches, branches slope down to the main line, and the main line slopes down to the stabilization pond. All should have slopes of between 1 in 100 and 1 in 300. Sewer pipes are designed to have a minimum depth of about 0.6m and a maximum depth based on practical construction considerations. The invert elevations along the pipelines and at all pipe intersections are written on the section drawings, along with pipeline lengths and diameters.

5. There are stoppages and failures in sewers. Therefore, there must be access to them to allow inspection and repair. Manholes provide the entrance from the ground surface to the sewer. See Figure 3. On main lines, there must be manholes spaced 100-150m apart. Manhole construction requires skill. The cover, whether concrete or cast iron, must be carefully fitted. Branch lines require only clean-outs. When distances are less than 50m, longer branches require manholes. Figure 4 shows one way to provide a clean-out.

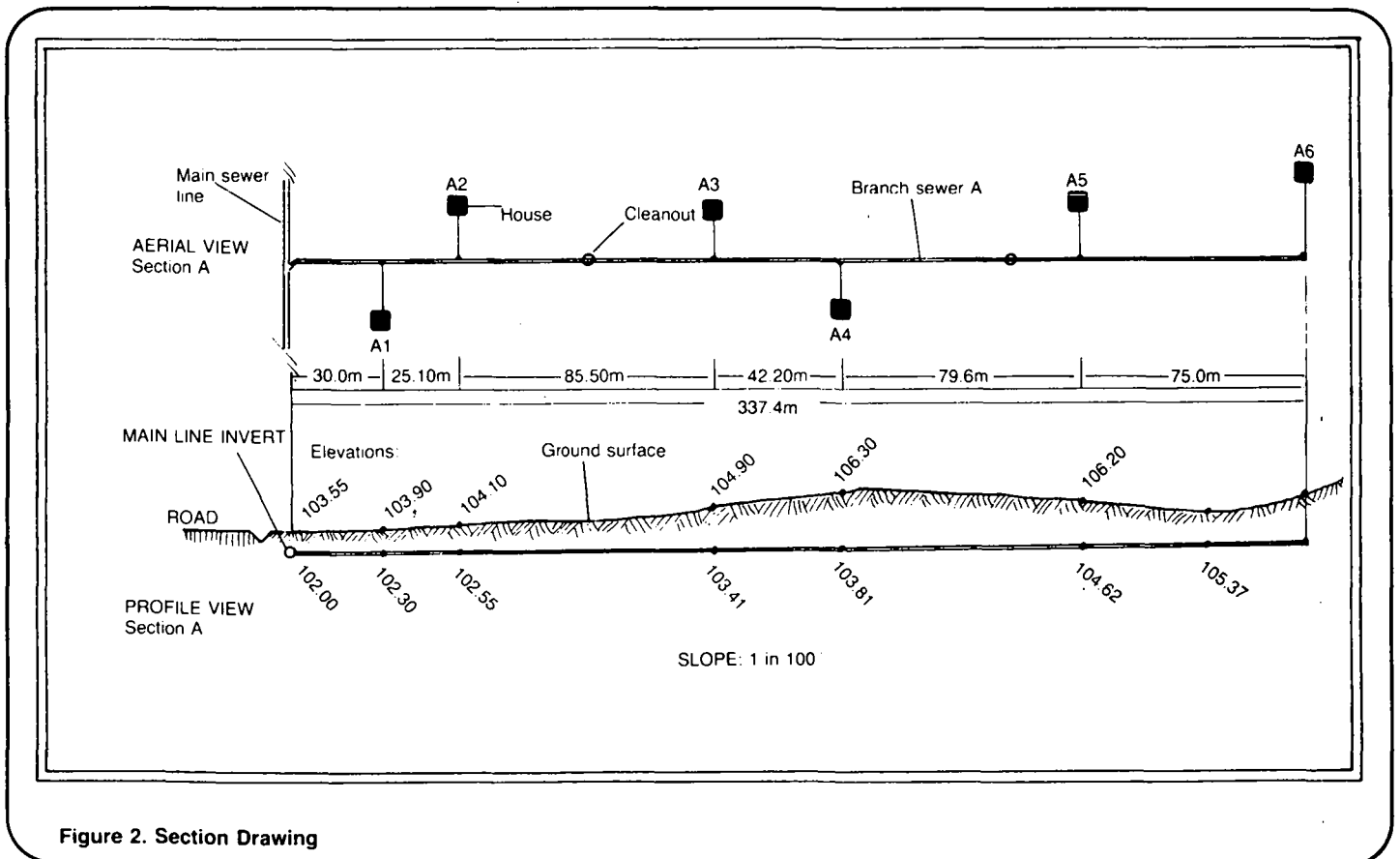


Figure 2. Section Drawing

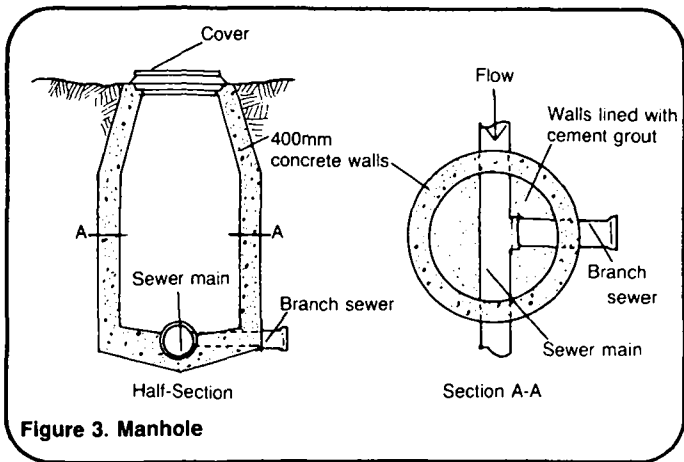


Figure 3. Manhole

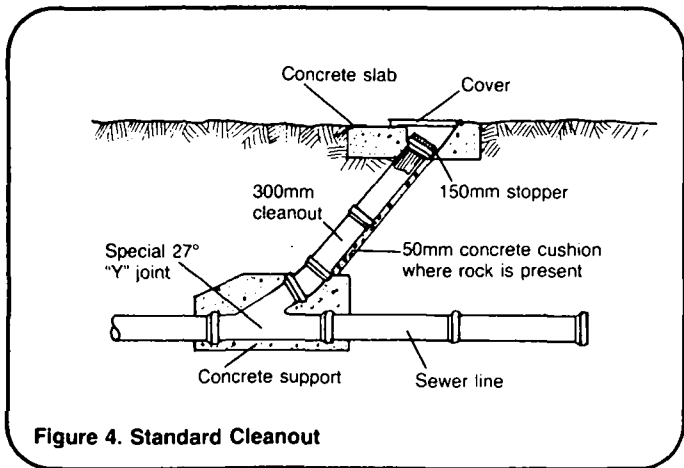


Figure 4. Standard Cleanout

6. Produce a master map of the entire sewer system showing all distances and invert elevations. Or, add the distances and elevations to the contour map so that it becomes the master map. See Figure 5.

Give these maps and drawings to the construction foreman before construction begins.

### Determining Labor, Materials, and Tools

The primary labor requirement is a construction foreman with experience in large-scale projects, preferably in sewer construction or water pipeline installation. Because field conditions and construction practices vary widely from region to region, the construction foreman should be involved in determining the requirements for labor, tools, and equipment.

A surveyor will be needed to make sure the sewer pipe is exactly placed. Because of the amount of work involved

and the time required, possibly a number of weeks or months, a fairly large and reliable work force of five to 20 or more people is needed. Most of the work, such as digging trenches, spreading gravel, and laying pipe, requires little or no skill. Some workers should be skilled in carpentry so they can build sheeting and bracing to shore the trench sides, and one or more should be experienced with cement mortar which will be needed for some or all pipe connections.

The major materials cost will be for sewer pipe and fittings. The lengths of pipe of each diameter and the number of fittings needed can be determined from the profile drawings. When ordering pipe lengths, increase the order by 5-10 percent to allow for damage during construction and for future repairs.

A partial list of other materials and tools needed appears in Table 1. A list of this type must be given to the construction foreman before construction begins.

In summary, detailed maps, section profiles, and a materials list must be given to the construction foreman.

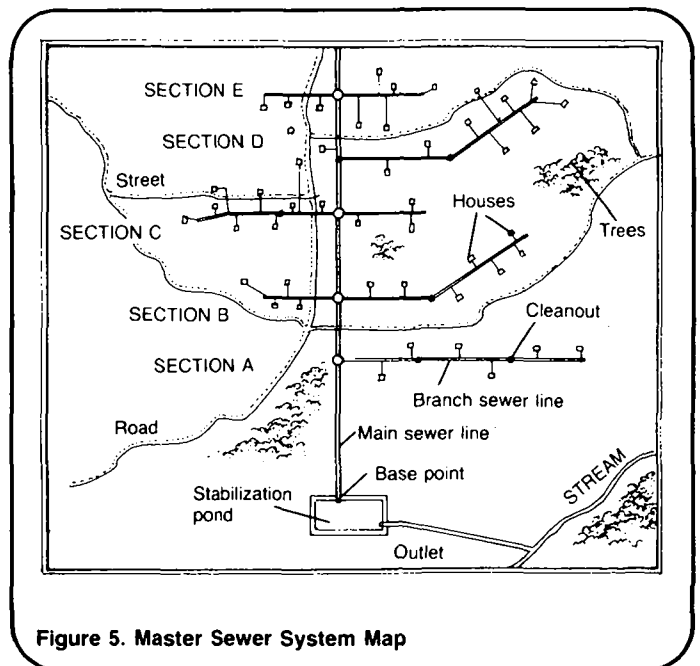


Figure 5. Master Sewer System Map

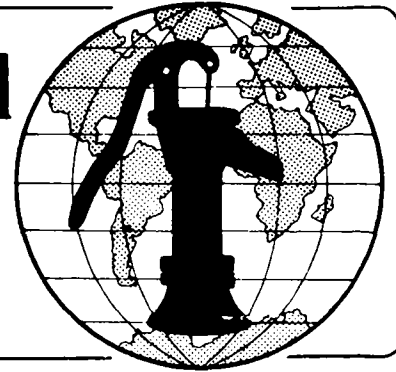
Table 1. Sample Materials List

Item	Description	Quantity	Estimated Cost
Labor	Construction foreman, experienced with large-scale projects	1	_____
	Surveyor	1	_____
	Worker, skilled with carpentry	1	_____
	Worker, skilled with concrete mortar	1	_____
	Workers, unskilled	12	_____
Supplies	Sewer pipe; 200mm diameter	_____	_____
	Sewer pipe; 100mm diameter	_____	_____
	"T" fittings; 100-200mm	_____	_____
	Other fittings	_____	_____
	Gravel	_____	_____
	Mortar mix	_____	_____
	Wooden stakes	_____	_____
	Wood for shoring	_____	_____
Nails (double-head and standard)	_____	_____	
Equipment and Tools	Surveyor's transit	1	_____
	Surveyor's level	1	_____
	Grade rods	2	_____
	Pipe sling for lowering pipe into trench	2	_____
	Heavy chains or ropes for lowering pipes	2	_____
	Shovels	12	_____
	Picks	4	_____
	Mattocks	2	_____
	Pry bars	2	_____
	Hammers	4	_____
	Saws	2	_____
	Sledgehammer	1	_____
	Trowels	2	_____
	Hoes	2	_____
Wheelbarrows	2	_____	
Barricades	6	_____	

Total Estimated Cost = \_\_\_\_\_

**Technical Notes** are part of a set of "Water for the World" materials produced under contract to the U.S. Agency for International Development by National Demonstration Water Project, Institute for Rural Water, and National Environmental Health Association. Artwork was done by Redwing Art Service. Technical Notes are intended to provide assistance to a broad range of people with field responsibility for village water supply and sanitation projects in the developing nations. For more detail on the purpose, organization and suggestions for use of Technical Notes, see the introductory Note in the series, titled "Using 'Water for the World' Technical Notes." Other parts of the "Water for the World" series include a comprehensive Program Manual and several Policy Perspectives. Further information on these materials may be obtained from the Development Information Center, Agency for International Development, Washington, D.C., 20523, U.S.A.

# Water for the World



## Designing Stabilization Ponds Technical Note No. SAN. 2.D.5

A stabilization pond is a large shallow excavation that receives sewage from a sewer system, detains the sewage so that biological processes can destroy most of the disease-causing organisms, and discharges the effluent as treated sewage. Designing a stabilization pond requires the help of an experienced engineer. It involves selecting a site; calculating pond size; and determining labor, materials, and tools needed for construction. The end-products of the design process are design drawings of the pond and its features, and a detailed materials list.

**Table 1. Sample Materials List for Stabilization Pond**

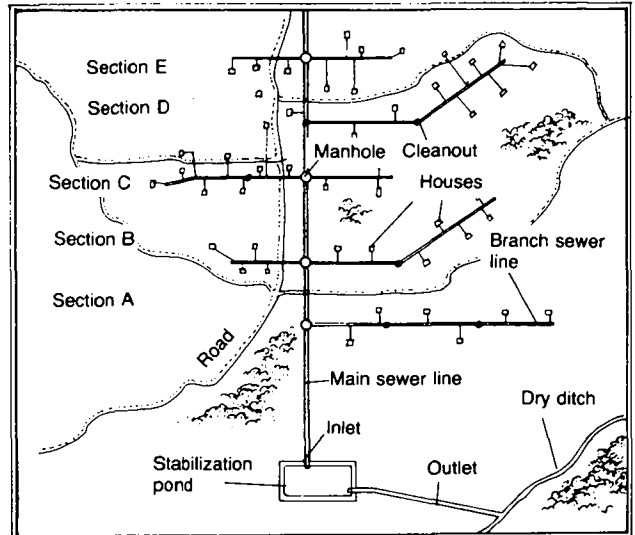
Item	Description	Quantity	Estimated Cost
Labor	Construction foreman (experienced)	_____	_____
	Laborer (skilled with concrete)	_____	_____
	Laborer (skilled with heavy equipment)	_____	_____
	Laborers (unskilled)	_____	_____
Supplies	Sewer pipe (100mm diameter)	_____ m	_____
	"T" fittings (100mm diameter)	_____	_____
	Valve	_____	_____
	Wire mesh (for outlet)	_____ m <sup>2</sup>	_____
	Cement	_____ m <sup>3</sup>	_____
	Sand (for concrete)	_____ m <sup>3</sup>	_____
	Gravel	_____ m <sup>3</sup>	_____
	Water	_____ liters	_____
	Gravel (for embankment)	_____ m <sup>3</sup>	_____
	Grass seed (for embankment)	_____	_____
	Wood (for forms)	_____	_____
Other	_____	_____	
Tools and Equipment	Surveying equipment (transit, level, etc.)	_____	_____
	Tractor with front-end loader	_____	_____
	Shovels	_____	_____
	Rakes	_____	_____
	Trowel	_____	_____
	Mixing containers	_____	_____
	Hammer	_____	_____
	Saw	_____	_____
	Nails	_____	_____
	Other	_____	_____

Total Estimated Cost = \_\_\_\_\_

This technical note describes the basic design features of a stabilization pond.

### Materials Needed

A master map of the sewer system similar to Figure 1. See "Designing Sewer Systems," SAN.2.D.4.



**Figure 1. Master Sewer Map with Site of Stabilization Pond**

### Useful Definitions

**EFFLUENT** - Settled sewage.

**GRAVITY FLOW** - Flow of water from high ground to low by natural forces.

**ORGANIC LOAD** - The amount of organic material (expressed in grams per liter) present in sewage that must be acted upon in a stabilization pond before it can be discharged as treated sewage.

**TREATED SEWAGE** - The liquid that flows out of a stabilization pond (or series of ponds). Treated sewage is safer than settled sewage and may be used to irrigate crops not intended for human consumption.

### Selecting a Site

1. **Elevation.** The site must be lower than the entire sewer system to allow for gravity flow of sewage into the pond. The outlet of the sewer system is the inlet into the pond. If

the site does not allow gravity flow, the sewage must be pumped, which requires costly equipment, energy and maintenance.

2. Soil. The soil must be able to hold a pond. It must not be sandy or made of loose soil and gravel that pass liquid. The site should be relatively easy to excavate, and there should be material at or near the site with which to build embankments.

3. Drainage. There must be good drainage away from the site to allow for the discharge of treated sewage. Often the treated sewage flows out of the pond into a dry stream bed or a waterway that is not used as a source of drinking water.

4. Size. The site must be large enough to accommodate the stabilization pond (see "Calculating Pond Size").

5. Flood protection. The site must not be in an area that is flooded during the wet season.

6. Distance. A stabilization pond should be no nearer to dwellings than 200m, and a larger distance is often desirable.

7. Wind direction. If possible, the site should be downwind from the community.

When the site has been selected, indicate it on the master sewer map, or draw a separate location map.

### Calculating Pond Size

There are several ways to calculate pond size. Each method makes certain assumptions and requires different data. The method described here requires calculating the expected daily flow of sewage into the pond and determining the average annual water temperature in the area in degrees Celsius. See "Estimating Sewage or Washwater Flows," SAN.2.P.2. With these two facts at hand, the following formula can be used to find the minimum required surface area of the stabilization pond.

$$A = \frac{O.L. \times F}{M}$$

where A = minimum pond surface area expressed in square meters,

O.L. = organic load of sewage effluent expressed in grams per liter, and estimated at 0.5grams/liter for this example,

F = estimated daily flow of sewage entering the pond expressed in liters per day,

M = maximum allowable organic load expressed in grams per m<sup>2</sup> of pond surface per day, based on temperature and calculated with the following formula:

$$M = (2T - 12) \text{ grams/m}^2/\text{day}$$

where T = average annual water temperature expressed in degrees Celsius.

The formula can be rewritten:

$$A = \frac{(0.5\text{grams/liter}) \times (\text{liters/day})}{(2 \times \text{ }^\circ\text{C}) - 12\text{grams/m}^2/\text{day}}$$

For example, if the estimated daily flow of sewage effluent is 100,000 liters per day, and the average annual water temperature is 20°C, then the minimum surface area of the stabilization pond is:

$$\begin{aligned} A &= \frac{(0.5) \times (100,000)}{(2 \times 20) - 12} \\ &= \frac{50,000}{28} \\ &= 1785\text{m}^2 \end{aligned}$$

Stabilization ponds are generally rectangular, with the length two or three times as great as the width. A few examples of configurations for the above example would be:

$$\begin{aligned} \text{length} &= 60\text{m}; \text{ width} = 30\text{m}; \\ \text{area} &= 60\text{m} \times 30\text{m} = 1800\text{m}^2 \end{aligned}$$

$$\begin{aligned} \text{length} &= 75\text{m}; \text{ width} = 25\text{m}; \\ \text{area} &= 75\text{m} \times 25\text{m} = 1875\text{m}^2 \end{aligned}$$

The design depth of stabilization ponds varies from 1-3m depending on type of sewage, amount of sewage, and climatic conditions. For the type of pond discussed here, a depth of 1.25m may be used.

## General Design Information

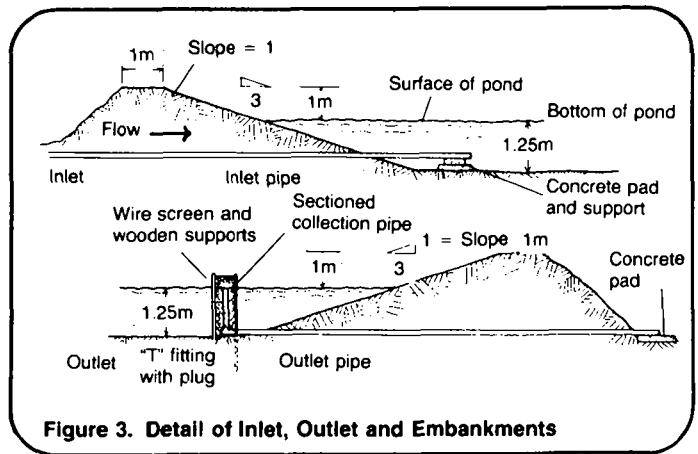
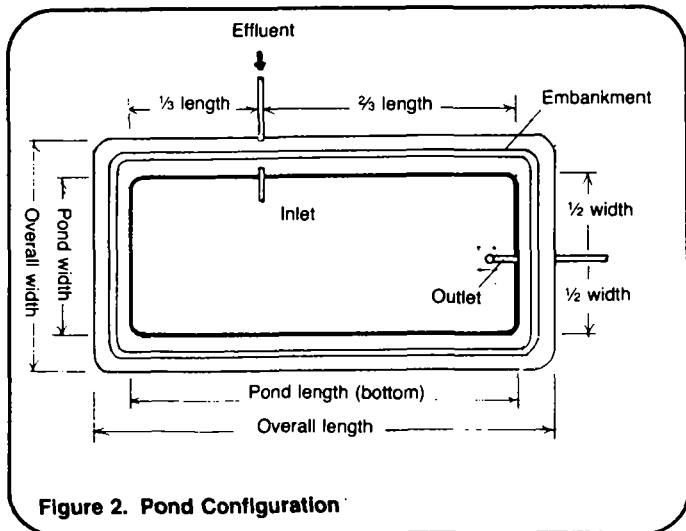
The inlet is a sewer pipe 100-300mm in diameter. It enters the pond about two thirds the pond length from the outlet end, and it rests on a base of concrete or stone. The bottom of the pipe is about 0.5m above the bottom of the pond.

The outlet is positioned in the center of one end of the pond. It is equipped with a "T" fitting, one or more sections of vertical sewer pipe, and a wire mesh screen to prevent surface debris from entering the pipe.

The embankment should be about 1.0m above the surface of the pond. Its sides should slope no steeper than 1 in 3 (one unit elevation for three units horizontal distance). The top of the embankment should be level and about 1.0m wide.

The inside corners of the pond should be rounded to prevent undue accumulation of floating material.

When the size and configuration of the pond have been determined, prepare design drawings similar to Figures 2 and 3. These should be given to the construction foreman before construction begins.



## Determining Labor, Materials, and Tools

The primary labor requirement is a construction foreman with experience in large-scale projects. Because field conditions and construction practices vary widely from region to region, the construction foreman should be involved in deciding on the requirements for labor, materials, and tools.

Because the elevation of the pond must be lower than all points on the sewer system, and the entire bottom of the pond must be fairly level, a surveyor may be needed. A fairly large and reliable work force of 5-20 laborers is required. Most workers may be unskilled. One or two should have some experience with concrete. One or more pieces of mechanized equipment, such as a tractor with a front-end loader, may be needed.

Materials needed include sewer pipe and fittings, concrete mortar mix, wire screen for the inlet and outlet, and gravel, grass seed, or sod to stabilize the embankments. Tools needed include those used for excavation, laying pipe, working with cement mortar, and spreading gravel and grass seed.

When labor, materials and tools have been decided upon, prepare a detailed materials list similar to Table 1 and give it to the construction foreman. In summary, give the construction foreman a map similar to Figure 1, design drawings similar to Figures 2 and 3, and a materials list similar to Table 1.

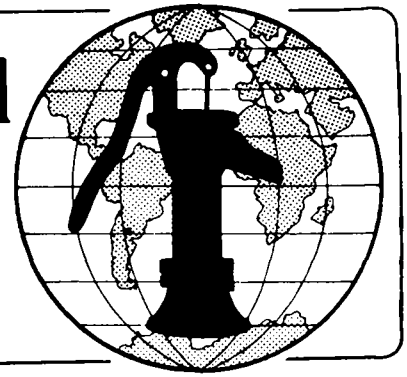
Determine whether a single pond or several ponds will be constructed. If several ponds are needed, see "Designing a System of Two or Three Stabilization Ponds," SAN.2.D.6.

## Notes

**Technical Notes** are part of a set of "Water for the World" materials produced under contract to the U.S. Agency for International Development by National Demonstration Water Project, Institute for Rural Water, and National Environmental Health Association. Artwork was done by Redwing Art Service. Technical Notes are intended to provide assistance to a broad range of people with field responsibility for village water supply and sanitation projects in the developing nations. For more detail on the purpose, organization and suggestions for use of Technical Notes, see the introductory Note in the series, titled "Using 'Water for the World' Technical Notes." Other parts of the "Water for the World" series include a comprehensive Program Manual and several Policy Perspectives. Further information on these materials may be obtained from the Development Information Center, Agency for International Development, Washington, D.C., 20523, U.S.A.



# Water for the World



## Designing a System of Two or Three Stabilization Ponds Technical Note No. SAN. 2.D.6

A system of stabilization ponds is an arrangement of two or more ponds connected by pipes that receives sewage, detains it so that biological processes can destroy most of the disease-causing organisms and discharges the effluent as treated sewage. Designing a system of stabilization ponds requires the help of an experienced engineer. Designing involves deciding if more than a single pond is necessary; determining the type and number of ponds in the system; calculating the size of each pond; deciding on the layout of the system; and determining the labor, tools, and materials needed for constructing the interpond piping. The products of the design process are: (1) an overview drawing of the system, (2) design drawings of interpond connections, and (3) a materials list supplement to the basic materials list from "Designing Stabilization Ponds," SAN.2.D.5.

This technical note describes the basic design features of a system of stabilization ponds.

### Useful Definitions

**EFFLUENT** - Settled sewage.

**INFLUENT** - Liquid flowing into a sewage treatment unit such as a stabilization pond.

**SEWAGE** - All washwater, excreta, and water used to flush excreta that flows from a building or buildings through a sewer system and into a septic tank, cesspool, or stabilization pond.

**TREATED SEWAGE** - The liquid that flows out of a stabilization pond or series of ponds; treated sewage is safer than settled sewage and may be used to irrigate crops not intended for human consumption.

### Materials Needed

The technical note "Designing Stabilization Ponds," SAN.2.D.5, and all technical information and drawings contained therein.

### General Design Information

The three types of stabilization ponds are anaerobic, facultative, and maturation. Each type varies in size and performs a distinct function.

**Anaerobic Ponds.** These ponds receive sewage with a high organic load or a high degree of solids. That is, sewage flowing into an anaerobic pond has not been presettled in a septic tank or other settling unit. Anaerobic ponds allow solids to settle, partially treat the sewage, and discharge effluent to a facultative pond. They are between 2-4m deep, and they detain the sewage for five to ten days. The main biological action is by organisms that do not require dissolved oxygen for their feeding and reproduction.

**Facultative Ponds.** These ponds receive sewage from a sewer system or anaerobic ponds, detain the effluent for 10-20 days, and discharge treated sewage to a dry ditch or a maturation pond. Facultative ponds are the most common. If a single pond is to be used, it will be of this type. Facultative ponds are discussed in detail in "Designing Stabilization Ponds," SAN.2.D.5. These ponds vary in depth from 1-1.5m. In a facultative pond, the biological action is both anaerobic and aerobic. Aerobic organisms require dissolved oxygen for their feeding and reproduction.

**Maturation Ponds.** These ponds are about 1m deep. They receive treated sewage from facultative ponds, detain it

for five to ten days to improve its quality and safety, and discharge the treated sewage to a dry ditch or to an irrigation ditch leading to crop land. Maturation ponds can be used to grow food fish and aquatic birds. The action is by aerobic organisms requiring dissolved oxygen for their life processes.

Ponds can be connected in series or in parallel. In a series arrangement, sewage or effluent is treated in one pond, then discharged to a second pond, then to a third. Each pond in a series discharges a better quality of effluent than the pond before it. In a parallel arrangement, two ponds, side by side, simultaneously receive effluent from the same source and simultaneously discharge treated sewage to the same outlet or ditch. The quality of the discharge from both ponds is similar.

The advantages of a series system are that it can receive unsettled or raw sewage, and it can improve the quality of the effluent for use to irrigate crops or raise food fish.

The advantage of a parallel system is that one pond can remain in operation while the other is drained for maintenance or repair. The retention time in one pond can be controlled by a schedule of discharges, first from one, then from another. This will involve partial drawdown, not complete emptying.

### Deciding on One Pond or a System

In most cases, a system of ponds is better than a single pond. The major constraint to a system of ponds is the increased area needed. The site must allow gravity flow, without excessive earth moving. Two parallel, half-size facultative ponds are as effective as a single full-sized pond and they allow for flexibility of operation.

A system of ponds is necessary if:

- sewage is to be more highly treated;
- food fish are to be raised;
- a pond is to be cleaned without shutting off the sewer system.

### Determining Type and Number of Ponds

The type and number of ponds depend on the quality of the influent and the desired quality of the treated sewage. Table 1 can be used as an aid in making this decision.

**Table 1. Criteria for Selecting Pond Types**

Criteria	Pond Types
If influent is sewage	Aerobic pond, followed in series by facultative pond
If influent is effluent	Facultative pond; preferably two ponds in parallel
If treated sewage used for food fish or crop irrigation	Facultative pond (preferably two), followed by maturation pond
If influent is raw sewage, and treated sewage to be used for fish or irrigation	Anaerobic, followed by one or two facultative, followed by maturation

### Calculating Pond Size

There are a number of good methods for calculating pond size, each involving certain assumptions and requiring different data. The method described in "Designing Stabilization Ponds," SAN.2.D.5, requires, among other things, determining the average annual water temperature. The method described here is based on the design depth for each type of pond, the design retention time, and the expected daily flow of sewage or sewage effluent. See "Estimating Sewage or Washwater Flows," SAN.2.P.2.

The area of the pond equals the expected daily flow times the retention time divided by the design depth.

$$\text{Area} = \frac{\text{flow} \times \text{time}}{\text{depth}}$$

For example, suppose the expected flow of sewage is 100,000 liters per day, and the pond system consists of an anaerobic pond, followed by a facultative pond, followed by a maturation pond.

First convert the flow to cubic meters.

$$\text{cubic meters} = \frac{\text{liters}}{1000}$$

$$\text{daily flow} = \frac{100000 \text{ liters}}{1000 \text{ liters/m}^3} = 100\text{m}^3$$

(Worksheet A, Lines 1-2)

### Worksheet A. Calculating Pond Sizes in a Pond System

1. Estimated daily flow (from SAN.2.P.2) = 100000 liters
2. Flow expressed in cubic meters =  $\frac{\text{Line 1}}{1000} = \frac{(100000)}{1000} = \underline{100} \text{ m}^3$

Type of pond (check one):  anaerobic  facultative  maturation

#### Anaerobic pond

3. Retention time (5-10 days) = 7.5 days
4. Depth (2-4m) = 3 m
5. Area =  $\frac{\text{Line 2} \times \text{Line 3}}{\text{Line 4}} = \frac{(100) \times (7.5)}{(3)} = \underline{250} \text{ m}^2$
6. Proposed width = 10 m
7. Length =  $\frac{\text{Line 5}}{\text{Line 6}} = \frac{(250)}{(10)} = \underline{25} \text{ m}$

#### Facultative pond

8. Retention time (10-20 days) = 15 days
9. Depth (1.0-1.5m) = 1.25 m
10. Area =  $\frac{\text{Line 2} \times \text{Line 8}}{\text{Line 9}} = \frac{(100) \times (15)}{1.25} = \underline{1200} \text{ m}^2$
11. Proposed width = 24 m
12. Length =  $\frac{\text{Line 10}}{\text{Line 11}} = \frac{(1200)}{(24)} = \underline{50} \text{ m}$

#### Maturation pond

13. Retention time (5-10 days) = 7.5 days
14. Depth = 1.0m
15. Area =  $\frac{\text{Line 2} \times \text{Line 13}}{\text{Line 14}} = \frac{(100) \times (7.5)}{(1.0)} = \underline{750} \text{ m}^2$
16. Proposed width = 20 m
17. Length =  $\frac{\text{Line 15}}{\text{Line 16}} = \frac{(750)}{(20)} = \underline{37.5} \text{ m}$

For the anaerobic pond, the average depth is 3m and the average retention time is 7.5 days. The area equals  $100\text{m}^3$  per day times 7.5 days divided by 3m:

$$\text{Area} = \frac{100\text{m}^3/\text{day} \times 7.5 \text{ days}}{3\text{m}} = 250\text{m}^2$$

(Worksheet A, Lines 3-7)

For the facultative pond, the average depth is 1.25m and the average retention time is 15 days. The area equals  $100\text{m}^3$  per day times 15 days divided by 1.25m:

$$\text{Area} = \frac{100\text{m}^3/\text{day} \times 15 \text{ days}}{1.25\text{m}} = 1200\text{m}^2$$

(Worksheet A, Lines 8-12)

For the maturation pond, the average depth is 1.0m and the average retention time is 7.5 days. The area equals  $100\text{m}^3$  per day times 7.5 days divided by 1.0m:

$$\text{Area} = \frac{100\text{m}^3/\text{day} \times 7.5 \text{ days}}{1.0\text{m}} = 750\text{m}^2$$

(Worksheet A, Lines 13-17)

Ponds are generally rectangular and the length and width of each pond in the example may vary. A few sample dimensions:

anaerobic: 10m wide by 25m long =  $250\text{m}^2$

facultative: 24m wide by 50m long =  $1200\text{m}^2$

maturation: 20m wide by 37.5m long =  $750\text{m}^2$

### Determining the Layout of the System

The layout, or arrangement, of the system depends on the type and number of ponds and the slope and area of the system's site. In general, each pond in a series system must be lower than the preceding pond. Two ponds in a parallel system are usually at the same elevation.

The layout of the system determines the configuration of connecting pipes and the placement of valves. Valves are generally placed so that one pond may be drained while the other pond or ponds remain in operation.

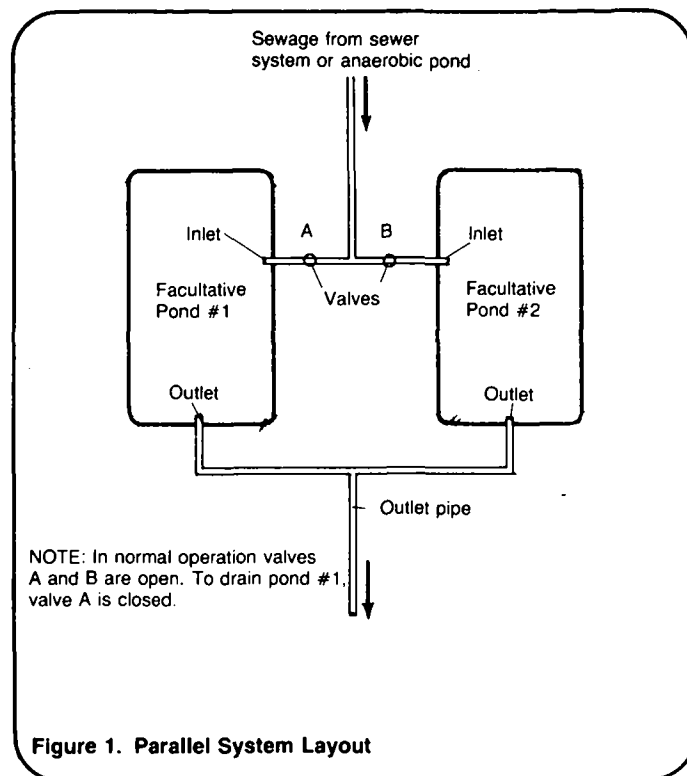


Figure 1. Parallel System Layout

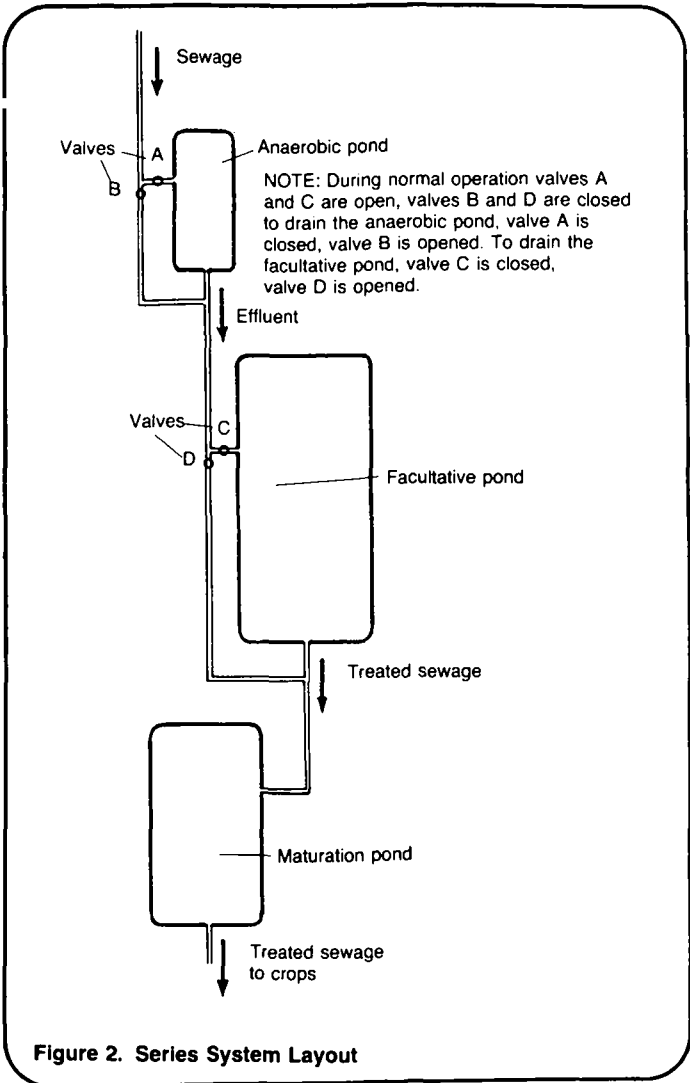
Figures 1 and 2 show two pond system layouts. When the layout has been determined, prepare a drawing similar to one of the figures showing the arrangement of ponds, and the type, width, length, and depth of each pond. Give the drawing to the construction foreman.

Figure 3 shows a typical section of interpond piping. The connecting pipe has a downward slope of at least 1 in 200 (one unit of elevation for every 200 units of distance). Prepare a drawing of each interpond connection showing the length and slope of pipes and give them to the construction foreman. Elevations must be carefully determined and construction must follow the drawings accurately.

### Determining Labor, Tools, and Materials

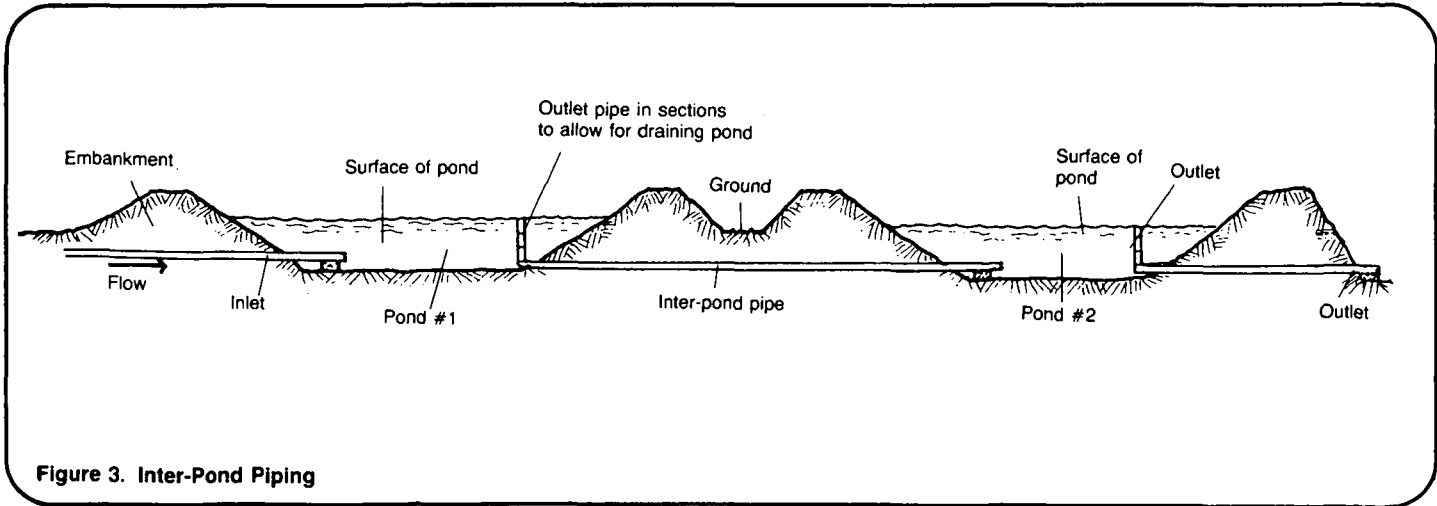
The required labor, tools, and materials for each pond are discussed in "Designing Stabilization Ponds," SAN.2.D.5. The only other consideration is interpond piping. From the layout drawing of the system, determine the total length of interpond pipes needed as well as the number of valves. Attach this information to the materials list described in SAN.2.D.5 and give it to the construction foreman.

In summary, prior to construction give the construction foreman all materials described in "Designing Stabilization Ponds," SAN.2.D.5, a drawing of the pond system layout similar to Figure 1 or 2, drawings of all interpond connections similar to Figure 3, and a materials list attachment similar to Table 2.



**Table 2. Sample Materials List Attachment for Interpond Piping**

Description	Quantity	Estimated Cost
Sewer pipe (100mm diameter)	_____m	_____
Sewer pipe (200mm diameter)	_____m	_____
Valves (100mm diameter)	_____	_____
Valves (200mm diameter)	_____	_____
<b>Total Estimated Cost</b>		_____



## Notes.

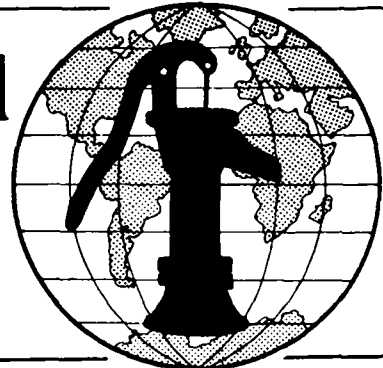
## Notes

## Notes

**Technical Notes** are part of a set of "Water for the World" materials produced under contract to the U.S. Agency for International Development by National Demonstration Water Project, Institute for Rural Water, and National Environmental Health Association. Artwork was done by Redwing Art Service. Technical Notes are intended to provide assistance to a broad range of people with field responsibility for village water supply and sanitation projects in the developing nations. For more detail on the purpose, organization and suggestions for use of Technical Notes, see the introductory Note in the series, titled "Using 'Water for the World' Technical Notes." Other parts of the "Water for the World" series include a comprehensive Program Manual and several Policy Perspectives. Further information on these materials may be obtained from the Development Information Center, Agency for International Development, Washington, D.C., 20523, U.S.A.



# Water for the World



## Designing Mechanically Aerated Lagoons Technical Note No. SAN .2.D.7

A mechanically aerated lagoon is similar to a stabilization pond except that it is equipped with one or more electrically powered aerators that treat the effluent by mixing it with air. Designing a mechanically aerated lagoon requires the services of an engineer experienced with these systems. Designing involves choosing a location; calculating lagoon size; selecting an aerator; and determining labor, materials, and tools needed for construction. The products of the design process are (1) a location map, (2) design drawings of the lagoon, and (3) a detailed materials list.

This technical note describes the elements involved in designing a mechanically aerated lagoon. Read the entire technical note before beginning the design process.

### Materials Needed

A master map of the sewer system; see "Designing Sewer Systems," SAN.2.D.4. The technical notes "Designing Stabilization Ponds," SAN.2.D.5, and "Designing a System of Stabilization Ponds," SAN.2.D.6.

### General

The prerequisites for a mechanically aerated lagoon are a constant source of electric power and funds to purchase two or more aerators.

There are a number of designs for mechanically aerated lagoons. One design requires a fairly large excavation, 2.0-4.0m deep, that is lined with flat rocks and mortar to prevent erosion caused by the aerators. The aerators float on the surface of the lagoon and treat the effluent by mixing it with oxygen. The treated sewage flows from the lagoon to a maturation pond, and then is discharged to a dry ditch or to an irrigation ditch leading to crop land.

### Useful Definitions

**BOD** - Biochemical oxygen demand; a means of measuring the organic content of effluent.

**EFFLUENT** - Settled sewage.

**HOORSEPOWER** - A unit of power used to rate motors.

### Selecting a Location

The site requirements for a mechanically aerated lagoon are the same as for a stabilization pond. See "Designing Stabilization Ponds," SAN.2.D.5, and "Designing a System of Stabilization Ponds," SAN.2.D.6. When the site has been determined, draw a location map or draw the site on the master sewer map as shown in Figure 1.

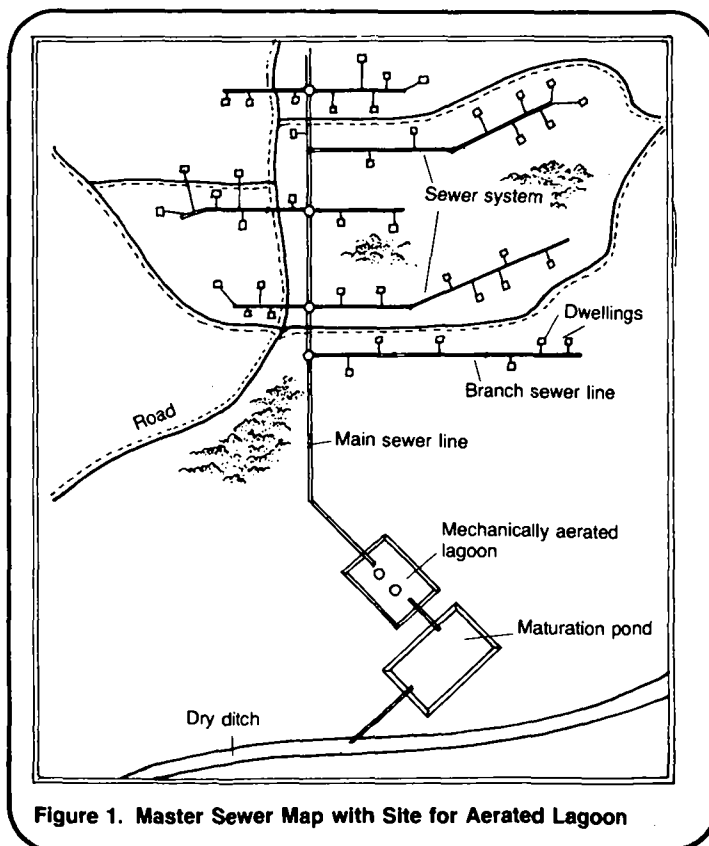


Figure 1. Master Sewer Map with Site for Aerated Lagoon

## Calculating Lagoon Size

The size of the lagoon is based on the daily flow of effluent; the BOD of the effluent as determined by laboratory analysis; the desired percentage of BOD removal, usually 80-95 percent; the climate of the area; and the type and size of the aerators. The lagoon size must be determined by an engineer.

In general, the capacity of the lagoon should be at least four times greater than the daily flow of effluent. For example, if the daily flow is 100000 liters, the minimum capacity of the lagoon equals:

$$100000 \text{ liters} \times 4 = 400000 \text{ liters}$$

To calculate the minimum area of the lagoon surface, convert liters to  $m^3$ , and divid by the design depth of the lagoon:

$$1000 \text{ liters} = m^3$$

Using the example above,

$$\frac{400000 \text{ liters}}{1000 \text{ liters}/m^3} = 400m^3$$

Suppose the design depth is 2.5m. Then the area equals:

$$\frac{400m^3}{2.5m} = 160m^2$$

One configuration for this area is 16m long and 10m wide. See Worksheet A, Lines 1 through 6.

To calculate the size of the maturation pond, see "Designing a System of Stabilization Ponds," SAN.2.D.6. When the lagoon and the pond have been designed, prepare a drawing similar to Figure 2 showing their size and configuration.

## Selecting an Aerator

There are a number of types of aerators being manufactured. One common design consists of an electric motor mounted on a float, attached to a vertical shaft and propeller, and connected to an electric line. See Figure 3. Mooring lines secured on the lagoon banks hold the aerator in position on the surface of the lagoon. When the power is switched on, the motor spins the shaft and propeller and churns up the effluent, mixing it with oxygen.

Aerator motors vary in size from 1-100 horsepower. The size and number of aerators, generally two or more, must be determined by the engineer using areators manufacturers' specification sheets.

### Worksheet A. Calculating Minimum Size of Aerated Lagoon

1. Daily flow of effluent = 100,000 liters
2. Minimum capacity of lagoon = Line 1 x 4 = 100,000 liters x 4 = 400,000 liters
3. Minimum capacity expressed in cubic meters =  $\frac{\text{Line 2}}{1000 \text{ liters}/m^3} =$   
 $\frac{(\underline{400,000} \text{ liters})}{1000 \text{ liters}/m^3} = \underline{400} m^3$
4. Minimum surface area of lagoon =  $\frac{\text{Line 2}}{\text{design depth}} = \frac{(\underline{400} m^3)}{(\underline{2.5} m)} = \underline{160} m^2$
5. Proposed width = 10 m
6. Length =  $\frac{\text{Line 4}}{\text{Line 5}} = \frac{(\underline{160} m^2)}{(\underline{10} m)} = \underline{16} m$

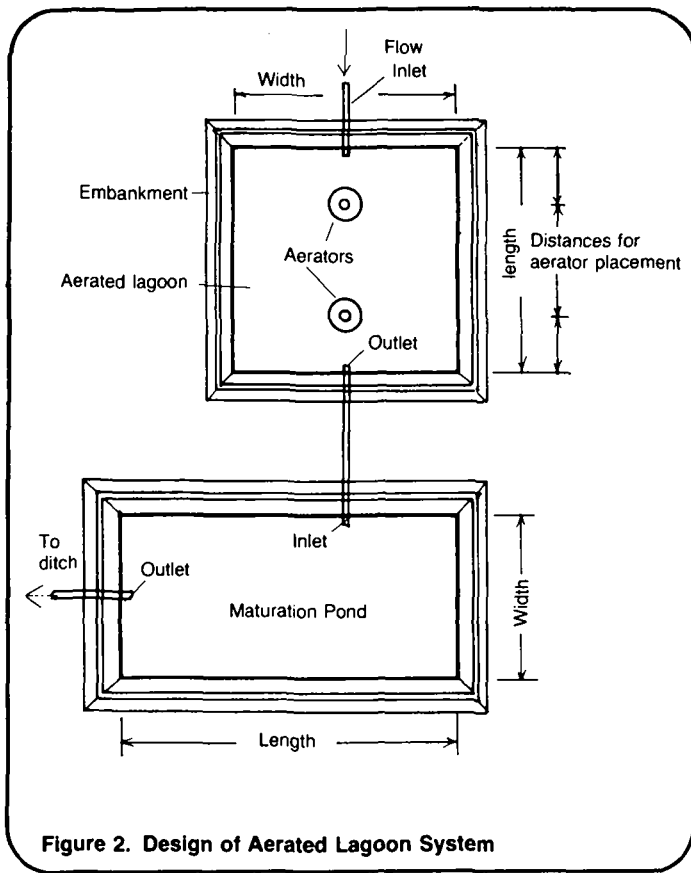


Figure 2. Design of Aerated Lagoon System

### Determining Labor, Materials, and Tools

The primary labor requirement is an engineer experienced with mechanically aerated lagoons. A fairly large and reliable work force of 5-20 people is needed. At least one worker must be a skilled electrician. One or more workers should have some experience with concrete mortar. Because of the size of the excavation, motorized excavating equipment, such as a backhoe, may be needed.

Materials needed include the aerators and all necessary wiring and spare parts; flat stones and mortar for lining the lagoons; sewer pipe and valves for inlet and outlet pipes and interpond piping; grass seed or sod for the top and outside of embankments. Tools needed include those used for assembling and installing electrically powered aerators, spreading mortar, laying pipe, and laying sod.

When all decisions on labor, supplies and tools have been made, prepare a materials list similar to Table 1 and give it to the construction foreman.

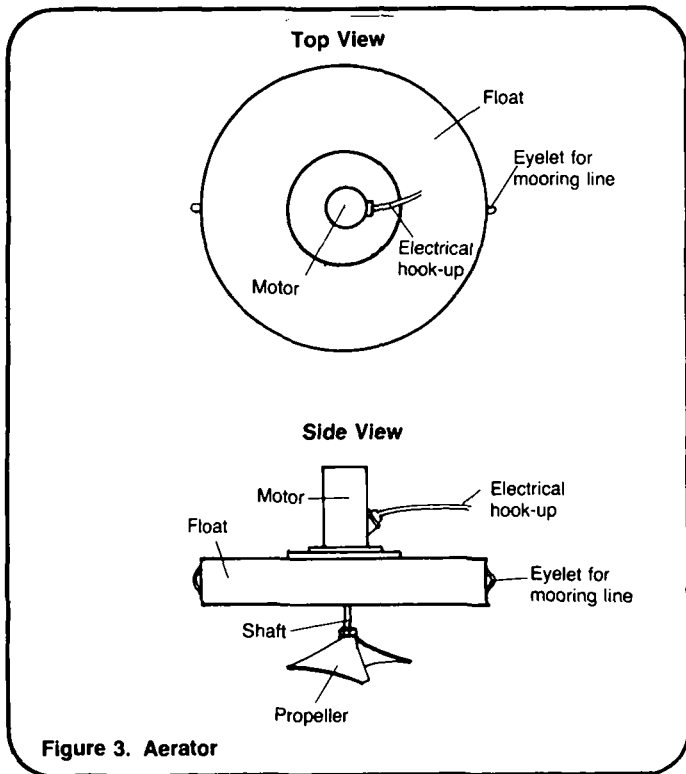


Figure 3. Aerator

Table 1. Sample Materials List for Aerated Lagoon.

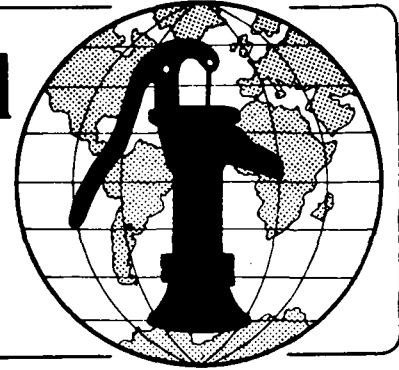
Item	Description	Quantity	Estimated Cost
Labor	Engineer experienced with aerated lagoons	1	—
	Electrician	1	—
	Worker skilled with concrete mortar	1	—
	Unskilled workers	6	—
	Backhoe operator	1	—
Supplies	Aerators, including spare parts, electric cables, and mooring lines	—	—
	Sewer pipe, 100mm diameter	—	—
	Valves, 100mm diameter	—	—
	Flat stones	—	—
	Mortar mix	—	—
	Grass seed	—	—
Tools	Backhoe	—	—
	Shovels	—	—
	Electrician's tools	—	—
	Mixing containers	—	—
	Trowels	—	—

Total Estimated Cost = —

## Notes

**Technical Notes** are part of a set of "Water for the World" materials produced under contract to the U.S. Agency for International Development by National Demonstration Water Project, Institute for Rural Water, and National Environmental Health Association. Artwork was done by Redwing Art Service. Technical Notes are intended to provide assistance to a broad range of people with field responsibility for village water supply and sanitation projects in the developing nations. For more detail on the purpose, organization and suggestions for use of Technical Notes, see the introductory Note in the series, titled "Using 'Water for the World' Technical Notes." Other parts of the "Water for the World" series include a comprehensive Program Manual and several Policy Perspectives. Further information on these materials may be obtained from the Development Information Center, Agency for International Development, Washington, D.C., 20523, U.S.A.

# Water for the World



## Designing Non-Conventional Absorption Disposal Systems Technical Note No. SAN. 2.D.8

Non-conventional absorption disposal systems have been developed for soil conditions where absorption is slow and slight, or where ground water is close to the ground surface. Effluent from a septic tank discharges to special filter beds or into mounds of soil or sand for final discharge by drainage or evapotranspiration. Such methods are for desperation cases where usual soil absorption lines cannot work. Designing non-conventional systems requires the services of an experienced engineer or soil scientist. Designing involves selecting a system; selecting a location; calculating size; and determining materials, labor, and tools needed for construction. The products of the design process are (1) a location map similar to Figure 1, (2) design drawings of the absorption system similar to Figure 2 or 3, and (3) a detailed materials list similar

to Table 1. These products should be given to the construction foreman before construction begins.

This technical note describes the elements involved in designing non-conventional absorption systems. Read the entire technical note before beginning the design process.

### Useful Definitions

**EFFLUENT** - Settled sewage.

**EVAPOTRANSPIRATION** - The loss of moisture from the soil caused by direct evaporation and by the transpiration of moisture to the atmosphere by plants.

**IMPERMEABLE** - Not allowing liquid to pass through.

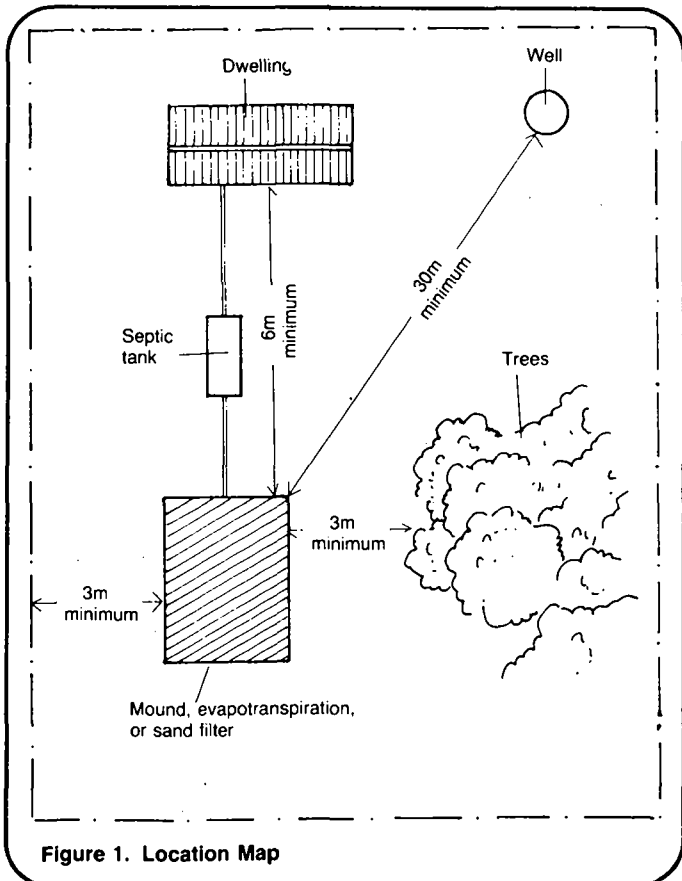


Figure 1. Location Map

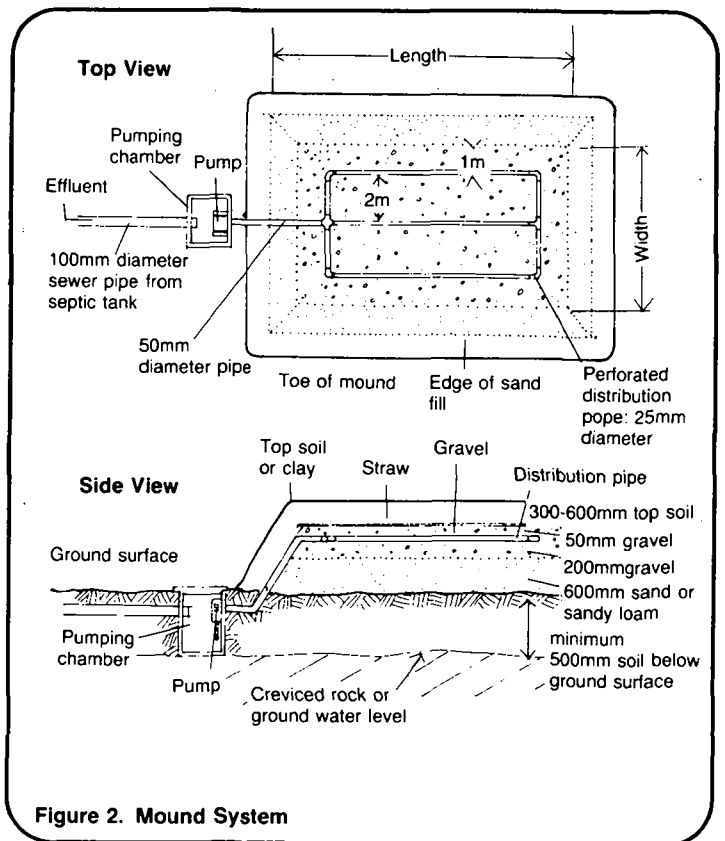


Figure 2. Mound System

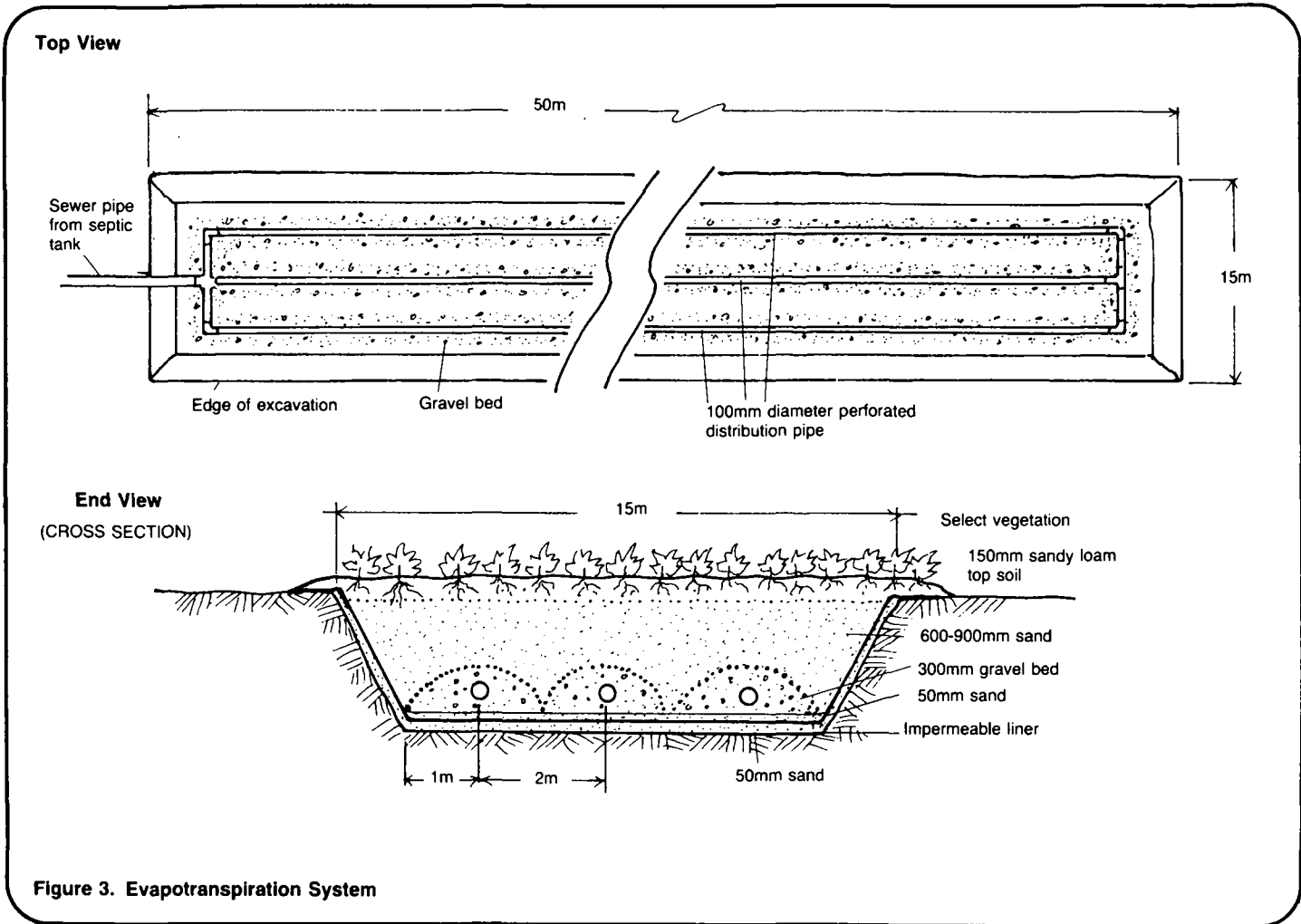


Figure 3. Evapotranspiration System

Table 1. Sample Materials List for Mound System, Evapotranspiration System, or Sand Filter

Item	Description	Quantity	Estimated Cost
Labor	Engineer or experienced construction foreman familiar with the system	1	_____
	Surveyor, to lay out the system	1	_____
	Workers	4-8	_____
Supplies	Pump (capable of 110 liters per minute)	1	_____
	Select filter sand; all must pass a 6mm screen; effective size 0.3-0.6mm; uniformity coefficient less than 3.5	_____	_____
	Gravel; 3-6mm in size	_____	_____
	Gravel; 18-36mm in size	_____	_____
	Fill sand	_____	_____
	Select vegetation	_____	_____
	Perforated pipe, 100mm diameter	_____	_____
	Perforated pipe, 25mm diameter	_____	_____
	Sewer pipe, 100mm diameter	_____	_____
	Impermeable synthetic liner	_____	_____
Mortar	_____	_____	
Tools	Shovels	4-8	_____
	Wheelbarrows	2-4	_____
	Trowel	2	_____
	Containers for mixing mortar	2	_____
	Surveying equipment	_____	_____
Total Estimated Cost =			_____

with the particular system selected. Table 2 can be used in a general way as an aid in selecting a system.

Table 2. Comparison of Non-Conventional Absorption Disposal Systems

System	Important Design Features
Mound	Pump; supply of suitable soil
Evapotranspiration	Impermeable liner; sand, gravel, and topsoil; shallow-root vegetation; arid or semi-arid climate
Sand Filter	Sand that meets design specifications; area to discharge filtered effluent; pump or dosing siphon (depending on size of the system)

### Selecting a System

The three types of non-conventional absorption disposal systems are mound, evapo-transpiration, and sand filter. The engineer must have some experience

### Selecting a Location

A non-conventional absorption system should be at least:

30m from the nearest water supply,  
 6m from the nearest building,  
 3m from any property line,  
 3m from bushes or trees.

Preferably, the system should be located so that there is a straight line from the building served, through the septic tank, to the absorption system. Thus there will be no bends or turns. If turns are necessary, mark the point permanently with a steel or concrete post. See "Designing Septic Tanks," SAN.2.D.3.

When the site has been selected, prepare a location map similar to Figure 1, showing distances from the system to the septic tank, buildings, water supplies, property lines, trees, and any other prominent features. Give the map to the construction foreman before construction begins.

### Designing a Mound System

There are a number of possible designs for a mound system. One design requires at least 500mm of soil above the groundwater level or creviced rock. The soil is covered with 600mm of sand or sandy loam, and then covered further by 200mm of gravel. Distribution pipes are laid on the gravel. The pipes are covered with another 50-100mm of gravel. The gravel is covered with straw, and the entire system is mounded with soil.

Effluent is discharged from a septic tank to a pumping chamber, and is pumped to the mound through distribution pipes. It filters down through the mound and into the natural ground. The ground may have a high groundwater level but it must be previous. Some of the effluent will leave the mound by evaporation and by action of plants and grass. No effluent should seep out from the edges of the mound.

Calculating Size. The size of the mound depends on the estimated daily flow of effluent. See "Estimating Sewage or Washwater Flows," RWS.2.P.2. The area of the sandy fill equals  $0.04m^2$  times the daily flow expressed in liters:

$$\text{area} = \frac{0.40m^2}{\text{liter}} \times (\text{number of liters}) = m^2$$

For example, if the estimated daily flow of effluent is 1500 liters, the required area of the sandy fill equals:

$$\frac{0.04m^2}{\text{liter}} \times 1500 \text{ liters} = 60m^2$$

Worksheet A. Line 2.

The sandy portion of the mound system must be at least  $60m^2$ . One configuration for this area is 10m long by 6m wide. When the mound has been designed, prepare a drawing similar to Figure 2 and give it to the construction foreman.

Determining Materials, Tools, and Labor. The system requires a pump (usually electric) designed to move at least 110 liters per minute. The pump is housed in a waterproof pumping chamber made of reinforced concrete. The exact size and configuration of the pumping chamber should be determined by the engineer at the site. The chamber must be at least large enough to house the pump and have enough room for a maintenance person to enter and service the pump. Materials for the chamber include cement, sand, gravel, water, and reinforcing material see "Designing Septic Tanks," SAN.2.D.3 for details. The pump and its fittings and parts should be selected by the engineer and obtained from the pump manufacturer. The pump requires a power source. It is extremely difficult to operate a mound system without a continuous, dependable electricity supply.

The system requires 100m diameter sewer pipe from the septic tank to the pumping chamber, 50mm diameter pipe from the chamber to the mound, and 25mm perforated distribution pipe within the mound. The distribution pipes are laid in parallel lines no more than 2m apart and no closer to the edge of the sand fill than 1.0m. The quantity of distribution pipe is best determined from the design drawings.

The approximate quantities of sandy soil and gravel in the mound can be calculated by multiplying the depth of the sand or gravel times the area of the sandy fill. In the previous example, these quantities are:

**Worksheet A. For Calculating Quantities for Mound System, Evapotranspiration System, and Sand Filter**

Type of system (check one):  mound  evapotranspiration  sand filter

1. Estimated daily flow of effluent (from SAN.2.P.2) = 1500 liters

Mound System

2. Required area =  $0.04\text{m}^2/\text{liter} \times \text{Line 1} = 0.04\text{m}^2/\text{liter} \times \underline{1500} \text{ liters} = \underline{60} \text{ m}^2$

3. Sandy soil = depth of sand times length of fill times width of fill =  $\underline{0.6} \text{ m} \times \underline{10} \text{ m} \times \underline{6} \text{ m} = \underline{36} \text{ m}^3$

4. Gravel = depth of gravel times length of fill times width of fill =  $\underline{0.3} \text{ m} \times \underline{10} \text{ m} \times \underline{6} \text{ m} = \underline{18} \text{ m}^3$

Evapotranspiration System

5. Required area =  $\frac{\text{Line 1}}{2.0 \text{ liters/m}^2} = \frac{(1500)}{2.0} = \underline{750} \text{ m}^2$

6. Size of impermeable liner = (length times width) + 2 (length times depth) + 2 (width times depth) =  $(\underline{50} \text{ m} \times \underline{15} \text{ m}) + 2 (\underline{50} \text{ m} \times \underline{1} \text{ m}) + 2 (\underline{15} \text{ m} \times \underline{1} \text{ m}) = \underline{750} \text{ m}^2 + \underline{100} \text{ m}^2 + \underline{30} \text{ m}^2 = \underline{880} \text{ m}^2$

7. Gravel = Length of distribution pipe times  $0.14\text{m}^2 = \underline{300} \text{ m} \times 0.14\text{m}^2 = \underline{42} \text{ m}^3$

8. Sand fill = (length times width times depth) minus Line 7 =  $(\underline{50} \text{ m} \times \underline{15} \text{ m} \times \underline{1} \text{ m}) - \underline{42} \text{ m}^3 = \underline{750} \text{ m}^3 - \underline{42} \text{ m}^3 = \underline{708} \text{ m}^3$

Sand Filter

9. Required area =  $\frac{\text{Line 1}}{50 \text{ liters/m}^2} = \frac{(1500)}{50} = \underline{30} \text{ m}^2$

10. Filter sand = depth times length times width =  $\underline{0.6} \text{ m} \times \underline{7.5} \text{ m} \times \underline{4.0} \text{ m} = \underline{18} \text{ m}^3$

11. Gravel (3-6mm) = depth times length times width =  $\underline{0.075} \text{ m} \times \underline{7.5} \text{ m} \times \underline{4.0} \text{ m} = \underline{2.25} \text{ m}^3$

12. Gravel (18-36mm) = depth times length times width =  $\underline{0.2} \text{ m} \times \underline{7.5} \text{ m} \times \underline{4.0} \text{ m} = \underline{6} \text{ m}^3$

sandy soil =  $0.6\text{m} \times 60\text{m}^2 = 36\text{m}^3$ ;

Worksheet A, Line 3.

gravel =  $0.3\text{m} \times 60\text{m}^2 = 18\text{m}^3$ ;

Worksheet A, Line 4.

The mound can be constructed by unskilled workers under the supervision of an experienced construction foreman. However, constructing the pumping chamber and installing the pump must be done by an experienced worker and checked by an engineer. When the necessary materials, tools, and labor have been determined, prepare a materials list similar to Table 1 and give it to the construction foreman.

**Designing an Evapotranspiration System**

There are a number of designs of an evapotranspiration system. In all of them, the settled effluent enters the distribution system and leaves by evaporation and the action of plants and grass. One design requires an excavation about 1.0m deep, at least 2.5m wide, and up to 50m long. The bottom of the excavation is covered with 50mm of sand to provide a supporting base. The bottom and sides are lined with an impermeable material, usually 0.25mm thick PVC plastic or other synthetic material that will not decompose. A



50mm layer of sand is spread over the liner. Distribution pipes are encased in gravel beds 300mm deep. The entire excavation is filled with sand and covered with about 150mm of sandy loam topsoil. Selected vegetation, usually of a type that uses a lot of water, is planted over the system.

Effluent is discharged from a septic tank to the system. It is drawn upward by capillary action and by the root system of the cover vegetation, and then dispersed by evaporation and transpiration.

Calculating Size. The size of the evapotranspiration bed depends on the estimated daily flow of effluent, on the evaporation rate in the region throughout the year, and to some extent on the type of vegetation used for cover. See "Estimating Sewage or Washwater Flows," SAN.2.P.2. Many systems can accept no more than 2.0 liters of effluent for every  $1\text{m}^2$  of surface area. To calculate the required area for this type of system, divide the estimated daily flow of effluent by 2.0 liters/ $\text{m}^2$ :

$$\text{area} = \frac{\text{liters of flow}}{2.0 \text{ liters}/\text{m}^2} = \text{m}^2$$

For example, if the estimated daily flow is 1500 liters, the area required equals:

$$\frac{1500 \text{ liters}}{2.0 \text{ liters}/\text{m}^2} = 750\text{m}^2;$$

Worksheet A, Line 5.

The evapotranspiration system must cover at least  $750\text{m}^2$ . One shape for this area is 50m long by 15m wide. When the system has been designed, prepare a drawing similar to Figure 3 and give it to the construction foreman.

Determining Materials, Tools, and Labor. The system requires an impermeable, non-degradable lining, generally PVC, plastic or other synthetic membrane. The liner must cover the bottom and all four vertical sides of the excavation. The following equation can be used to calculate the approximate size of the liner based on excavation dimensions:

$$(\text{length times width}) + 2 (\text{length times depth}) + 2 (\text{width times depth})$$

Sometimes a double liner is used, and the equation is multiplied by two. The approximate size of a single-layer liner in the previous example is:

$$(50\text{m} \times 15\text{m}) + 2 (50\text{m} \times 1\text{m}) + 2 (15\text{m} \times 1\text{m}) = 750\text{m}^2 + 100\text{m}^2 + 30\text{m}^2 = 880\text{m}^2;$$

Worksheet A, Line 6.

The system requires 100mm diameter sewer pipe from the septic tank to the evapotranspiration bed, and 100mm diameter distribution pipe within the bed. The distribution pipes are laid in parallel lines 1.5-2.0m apart, and no closer to the sides of the excavation than 1m. The quantity of distribution pipe is best determined from the design drawings.

Each distribution pipe is laid in a bed of pea-sized (8-10mm) gravel. Each bed has a cross-sectional area of about  $0.14\text{m}^2$ . To estimate the required quantity of pea-sized gravel, multiply  $0.14\text{m}^2$  times the total lengths of all beds. For example, if the combined lengths of the distribution pipe beds is 300m, the approximate quantity of gravel equals:

$$0.14\text{m}^2 \times 300\text{m} = 42\text{m}^3;$$

Worksheet A, Line 7.

The approximate quantity of sand required for the system equals the volume of the excavation minus the volume of the gravel. For example, if the system is 50m long, 15m wide, and 1m deep, and the volume of gravel is  $42\text{m}^3$ , the volume of sand equals:

$$(50\text{m} \times 15\text{m} \times 1\text{m}) - 42\text{m}^3 = 750\text{m}^3 - 42\text{m}^3 = 708\text{m}^3;$$

Worksheet A, Line 8.

The cover vegetation selected should be of a local variety and it should not have long roots which would interfere with the operation of the system. The vegetation should be approved by the engineer or soil scientist before it is planted.

An evapotranspiration system can be constructed by unskilled workers under the close supervision of an experienced construction foreman or engineer. When the necessary materials, tools, and labor have been determined, prepare a materials list similar to Table 1 and give it to the construction foreman.

## Designing a Sand Filter

There are a number of designs for a sand filter. One design requires an excavation in clay or tight soil. The bottom of the excavation slopes toward the center and an underdrain is laid within a 100mm layer of washed gravel, 18-36mm in size. Above this is a 75mm layer of gravel, 3-6mm in size. Above the gravel is a 600-900mm layer of clean, coarse filter sand. The quality and size of the filter sand is critical to the operation of the system. Riverbed sand definitely may not be used. All the sand must pass through a 6mm sieve. The effective grain size should be between 0.3-0.6mm. The effective size means that 10 percent of the sand by weight must be smaller than that size. The uniformity coefficient should be 3.5 or less. This coefficient is the ratio between the size of sieve that passes 60 percent of the sand by weight and the size of the sieve that passes 10 percent of the sand by weight. The filter sand is covered with a 100mm layer of 18-36mm gravel. Perforated distribution pipes are headed in this gravel layer. The entire system is mounded with soil.

Effluent is discharged from a septic tank to the distribution pipes. The effluent filters down through the sand, collects in the underdrain, and is discharged to a dry ditch or waterway. For low daily volumes of wastewater, gravity flow to the filter lines may work. For full use of the bed, the distribution lines should be filled two or three times per day. That requires a dosing siphon and dosing tank between the septic tank and filter bed. See Figure 4. The alternative is to use a pump similar to that required for a mound system.

Figure 4 shows a dosing siphon. It is placed in a dosing tank alongside a septic tank. The volume of the dosing tank to the discharge level is about equal to the total volume of the

distribution pipes in the sand filter. A dosing siphon provides uniform distribution in the absorption beds. As it usually discharges only two or three times per day, the beds have resting periods which are very beneficial for biological action.

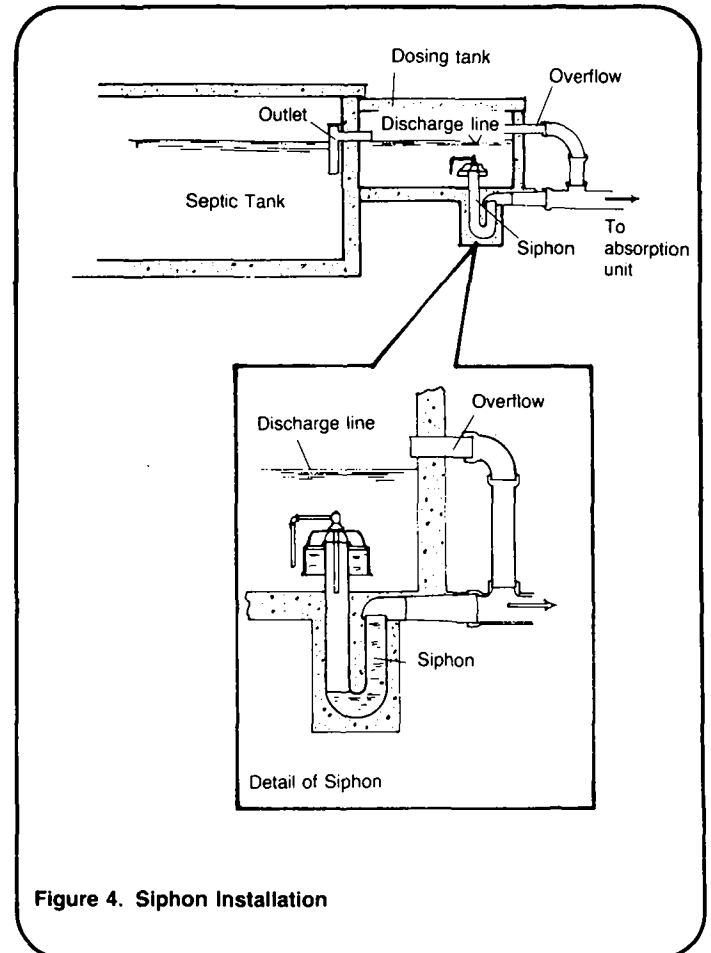


Figure 4. Siphon Installation

There are no moving parts. Discharge starts when a trapped volume of air is compressed to a point where there is a release of pressure starting the siphon. Sizing, dimensions and placement are critical. The underedge of the bell must be absolutely level, if the siphon is ever to start.

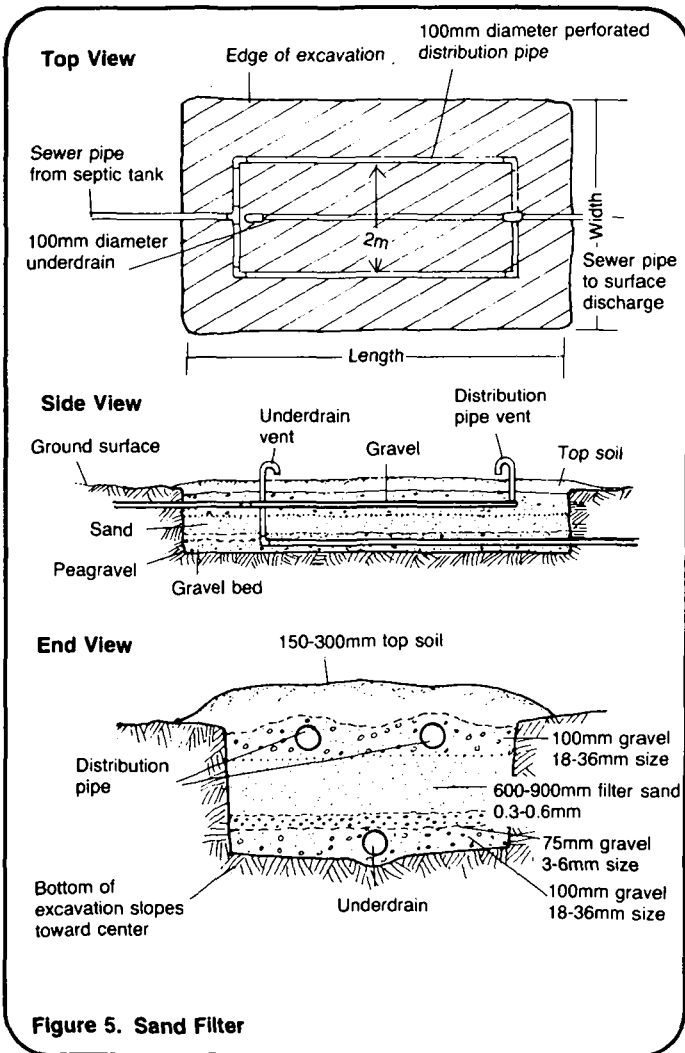
Calculating Size. The size of the sand filter system depends on the estimated daily flow of effluent and on the loading factor of 46.85 liters of effluent for every m<sup>2</sup> of surface area. See "Estimating Sewage or Washwater Flows," SAN.2.P.2.

For example, if the estimated daily flow of effluent is 1500 liters, the required area of the sand filter equals:

$$\frac{1500 \text{ liters}}{46.85 \text{ liters/m}^2} = 32.0\text{m}^2;$$

Worksheet A, Line 9.

The sand filter must cover at least 32.0m<sup>2</sup>. One configuration for this area is 8.0m long by 4.0m wide. When the system has been designed, prepare a drawing similar to Figure 5 and give it to the construction foreman.



Determining Materials, Tools, and Labor. This system requires a quantity of finely-graded, select filter sand, which passes through a 6mm screen, has an effective size of 0.3-0.6mm, and has

a uniformity coefficient of less than 3.5. The approximate quantity of sand can be calculated by multiplying the depth of the sand layer by the dimensions of the excavation. In the previous example, if the depth of the sand layer is 600mm, the quantity needed equals:

$$0.6\text{m} \times 8.0\text{m} \times 4.0\text{m} = 19.2\text{m}^3;$$

Worksheet A, Line 10.

The approximate quantities of gravel are calculated in the same manner.

For gravel 3-6mm in size:

$$0.075\text{m} \times 8.0\text{m} \times 4.0\text{m} = 2.4\text{m}^3;$$

Worksheet A, Line 11.

For gravel 18-36mm in size (two 100mm layers):

$$0.2\text{m} \times 8.0\text{m} \times 4.0\text{m} = 6.4\text{m}^3;$$

Worksheet A, Line 12.

The system requires 100mm diameter sewer pipe from the septic tank to the sand filter, 100mm diameter perforated distribution pipe and underdrain within the system, and two 100mm diameter vent pipes. The quantity of pipes is best determined from the design drawings.

A pump and pumping chamber similar to that for a mound system is required, if the area of the filter is greater than 170m<sup>2</sup>. A dosing siphon and chamber can be used.

A sand filter must be constructed under close supervision by an experienced construction foreman or engineer. The elevation and grade of the distribution pipes and underdrain are critical. They should be established by a surveyor.

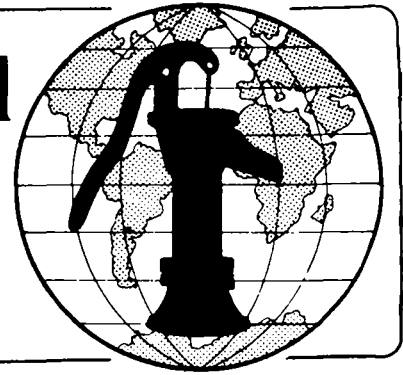
When the necessary materials, tools, and labor have been determined, prepare a materials list similar to Table 1 and give it to the construction foreman.

In summary, non-conventional system-mound, evapotranspiration, sand filter--must be designed by an engineer experienced with them.

## Notes

**Technical Notes** are part of a set of "Water for the World" materials produced under contract to the U.S. Agency for International Development by National Demonstration Water Project, Institute for Rural Water, and National Environmental Health Association. Artwork was done by Redwing Art Service. Technical Notes are intended to provide assistance to a broad range of people with field responsibility for village water supply and sanitation projects in the developing nations. For more detail on the purpose, organization and suggestions for use of Technical Notes, see the introductory Note in the series, titled "Using 'Water for the World' Technical Notes." Other parts of the "Water for the World" series include a comprehensive Program Manual and several Policy Perspectives. Further information on these materials may be obtained from the Development Information Center, Agency for International Development, Washington, D.C., 20523, U.S.A.

# Water for the World



## Constructing, Operating and Maintaining Subsurface Absorption Systems

Technical Note No. SAN. 2.C.1

A subsurface absorption system is a trench, series of trenches, field, or pit that receives effluent from a septic tank and allows the effluent to soak safely into the ground. Constructing an absorption system involves digging a trench, field, or pit at the correct location; spreading gravel and laying drainpipe, or building side walls; and connecting the system to a septic tank with sewer pipe. A properly constructed subsurface absorption system can last 10 to 20 years. The system is self-operating and requires little or no maintenance. It must be inspected periodically and any problems corrected.

This technical note describes each step in constructing an absorption system. Read the entire technical note before beginning construction.

### Useful Definitions

**DRAINPIPE** - Perforated or open-joint sewer pipe.

**EFFLUENT** - Settled sewage.

**GROUNDWATER LEVEL** - The level to which subsurface water rises during any given time of year.

**PERMEABILITY** - The ability of the soil to absorb liquid, such as sewage effluent.

**PERVIOUS** - Allowing liquid to pass through.

**SEWER PIPE** - Noncorrosive pipe, usually 100mm in diameter, made from concrete, vitrified clay, glazed tile, or plastic.

**TRENCH GRADE** - The continuous slope at the bottom of a trench.

### Materials Needed

The project designer must provide three items before construction can begin:

1. Location map, similar to Figure 1, showing the correct site where the system is to be constructed. The map will show distances from the system to the septic tank, water supplies, dwellings, property lines, vegetation, and any other structures or prominent geographical features.

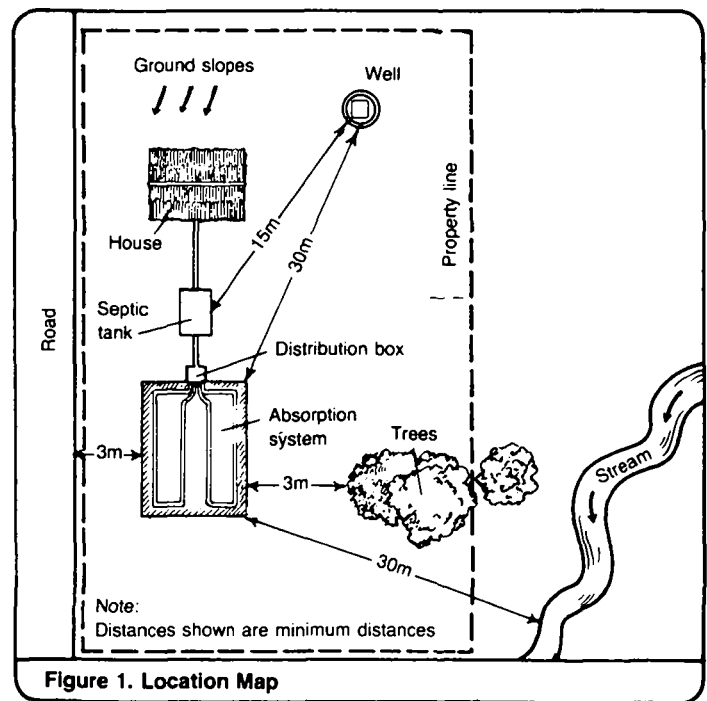


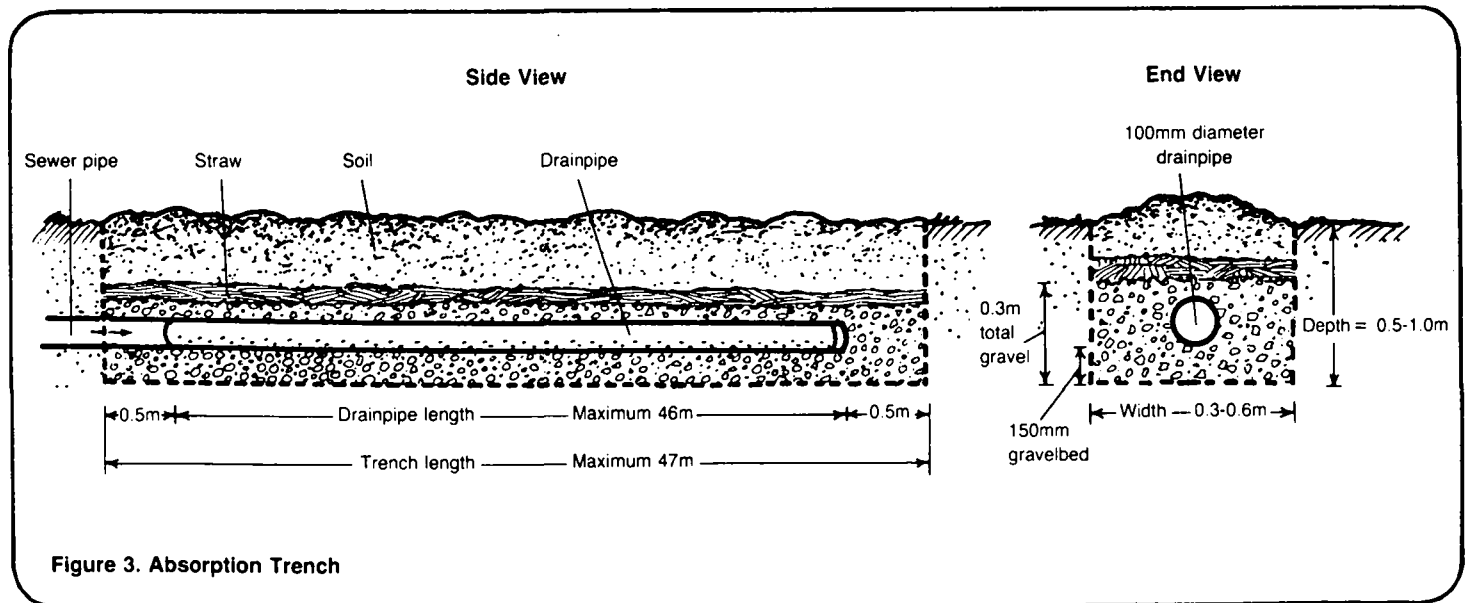
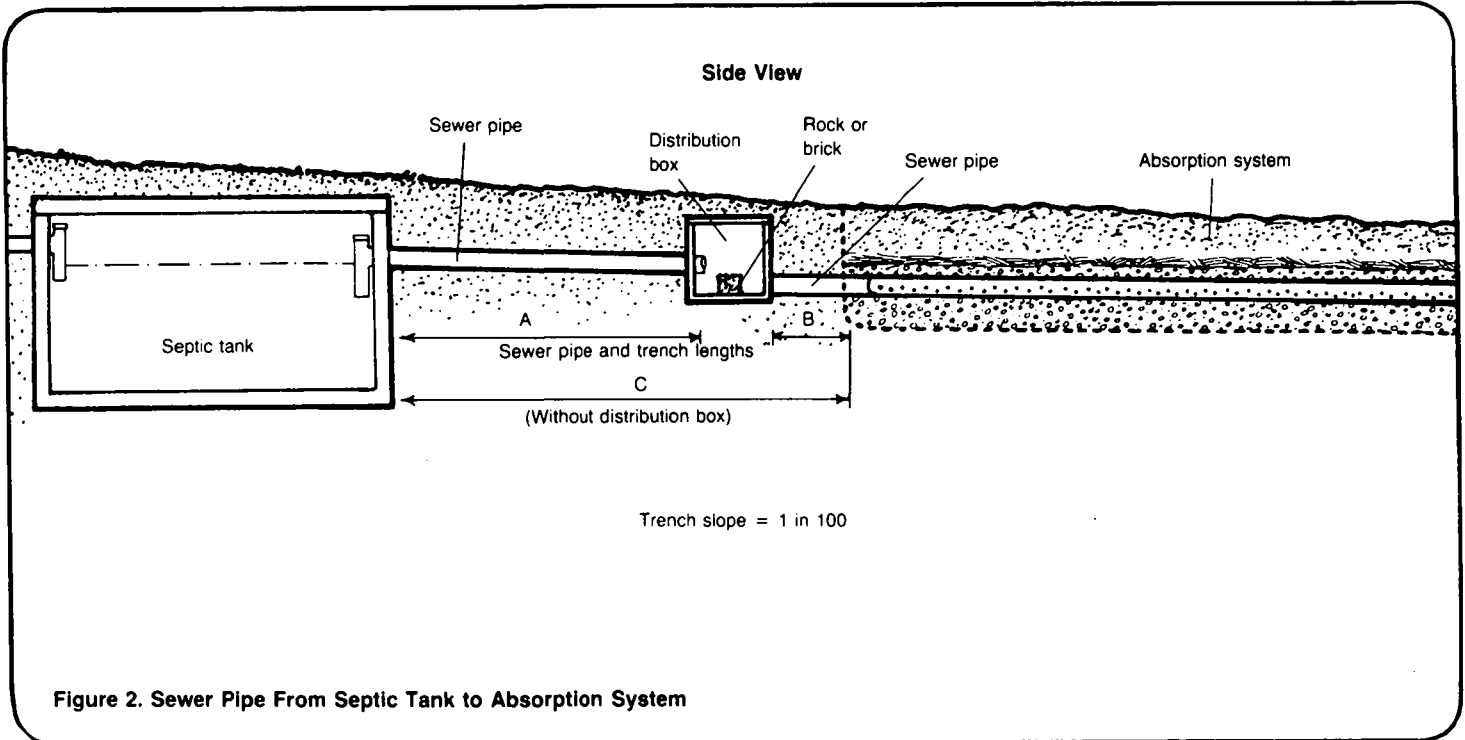
Figure 1. Location Map

2. Technical drawings, similar to Figure 2, for all systems; Figure 3, for a trench system; Figure 4, for a series of trenches; Figure 5, for a field system; Figure 6, for a distribution box; or Figure 7, for a pit

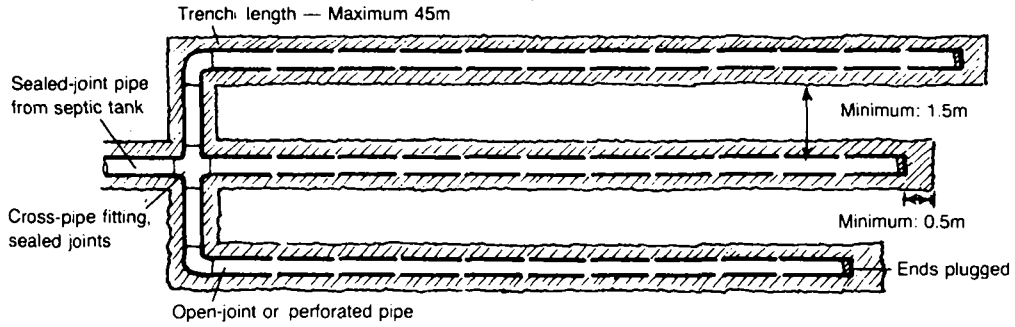
system. These drawings will show correct dimensions for excavation and construction, and correct lengths for sewer pipe and drainpipe.

3. Materials list, similar to Table 1, showing all labor, supplies, and tools needed to construct the system.

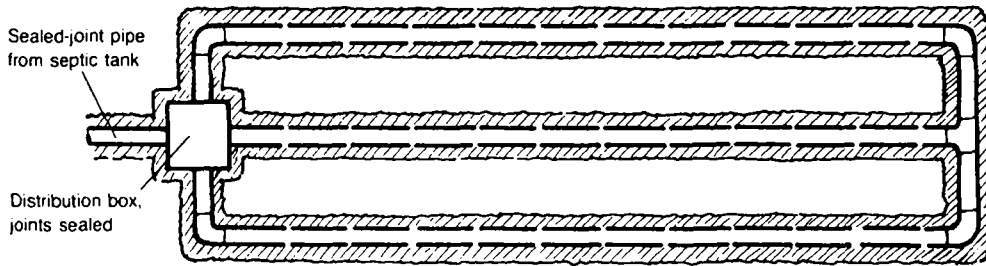
More detail on these documents may be found in "Designing Subsurface Absorption Systems," SAN.2.D.1. After the project designer has given you these documents, begin assembling necessary laborers, materials, and tools.



**OPEN-END TRENCH SYSTEM**  
Top View

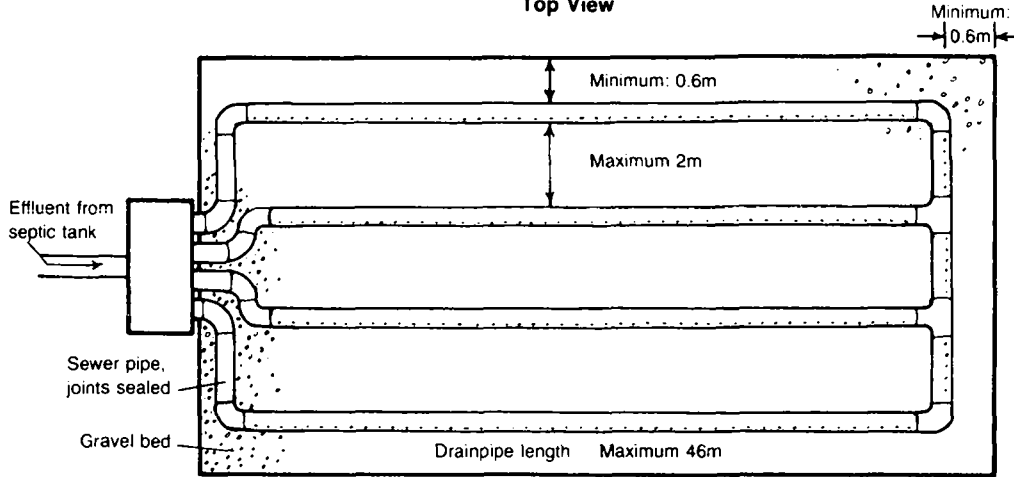


**CLOSED-LOOP TRENCH SYSTEM**  
Top View

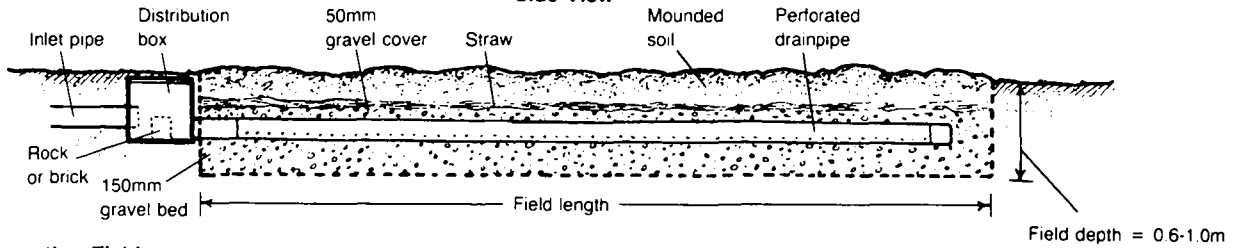


**Figure 4. Multiple Trench Systems**

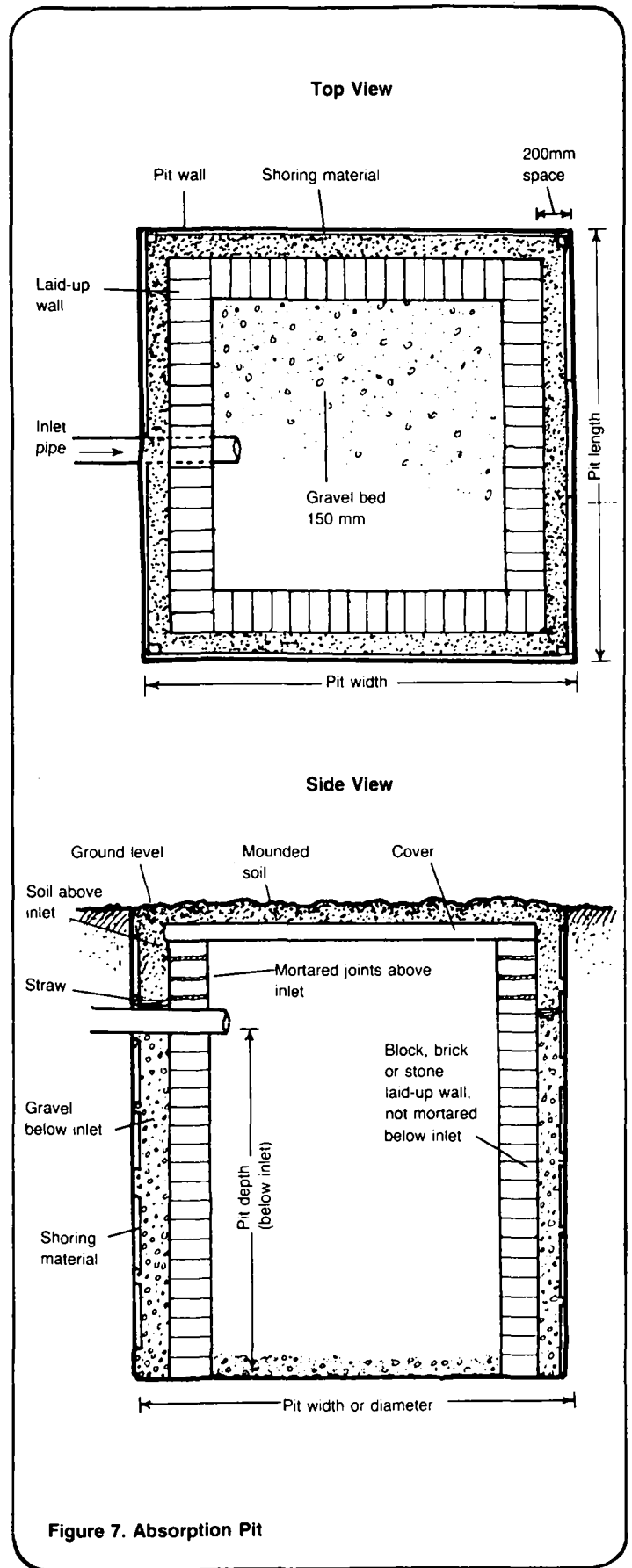
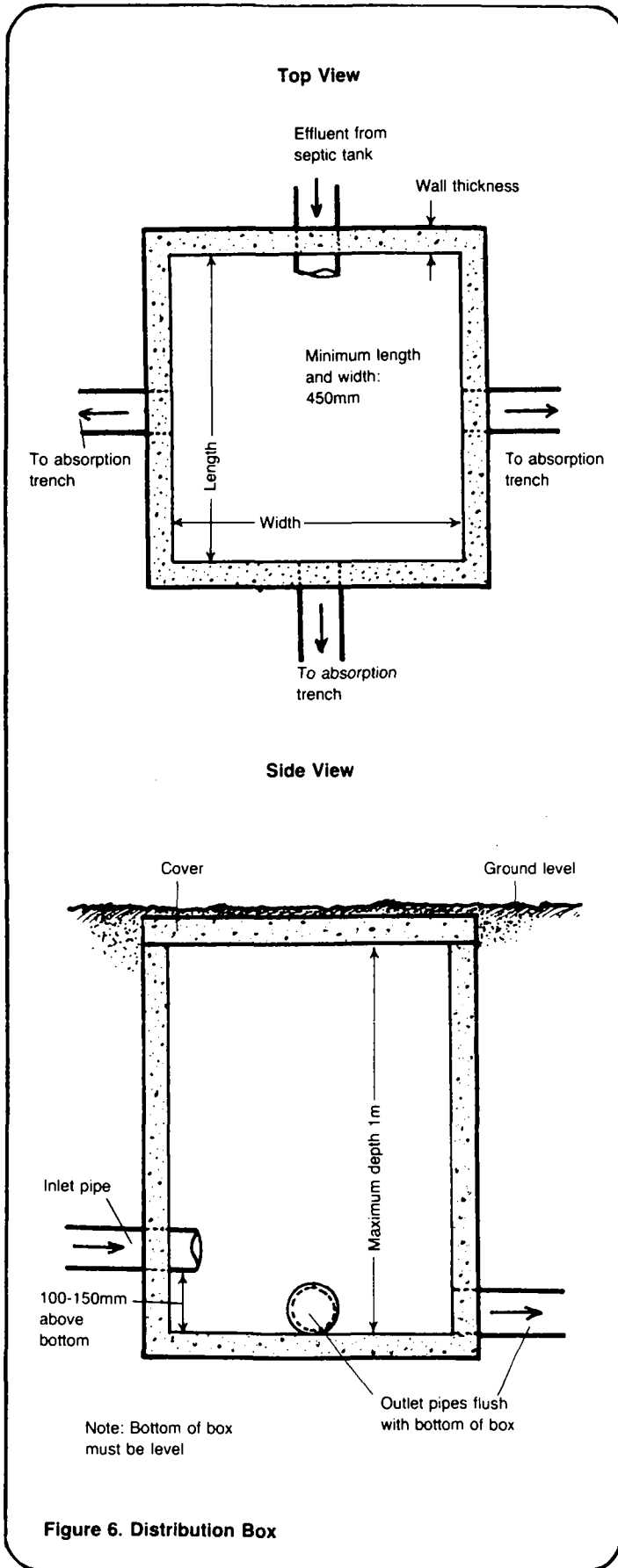
**Top View**



**Side View**



**Figure 5. Absorption Field**





**Table 1. Sample Materials List**

Item	Description	Quantity	Estimated Cost
Labor	Foreman	1	_____
	Laborers (one experienced with concrete or mortar, if applicable)	2	_____
Supplies	Wooden stakes for marking out system	_____	_____
	Sewer pipe: 100mm diameter, clay, concrete or plastic	_____ m, enough to reach from septic tank to absorption system	_____
	Drainpipe: 100mm diameter, perforated or open-joint sewer pipe (open-joint sections 0.5m long)	_____ m, enough to construct trench, trenches, or field	_____
	Gravel or crushed rock; clean size from 12 to 50mm	_____ m <sup>3</sup> , enough to fill trenches or field or wall space in pit	_____
	Tar, mortar, or oakum (for sealing pipe joints)	_____	_____
	Tar paper or building paper (for covering open joints)	_____ m <sup>2</sup> , enough to cover all joints	_____
	Untreated paper, straw, hay, or grass (for covering gravel)	_____	_____
	If pit: Wood, poles, bamboo or other material for shoring sides	_____	_____
	If distribution box: Cement: portland	_____ m <sup>3</sup>	_____
	Sand: clean, fine to 6mm	_____ m <sup>3</sup>	_____
	Gravel: clean, 6 to 38mm	_____ m <sup>3</sup>	_____
	Water: clear, enough to make stiff mix	_____ liters or gallons	_____
Wooden boards (for building forms)	_____	_____	
Nails (for building forms)	_____	_____	
Tools	Rake or hoe	1	_____
	Measuring tape	1	_____
	Shovels	2 (at least; one per worker)	_____
	Wheelbarrow	1	_____
	Carpenter's level or equivalent	1	_____
	If pit or distribution box: Hammer	1	_____
	Saw	1	_____
	If concrete distribution box: Container (for mixing)	1	_____
	Trowel	1	_____
	Other	_____	_____

Total Estimated Cost = \_\_\_\_\_

**Table 2. Sample Work Plan for Constructing an Absorption System**

Time Estimate	Day Number	Task	Personnel	Tools/Materials
3 hours	1	Lay out system on ground with stakes	Foreman and one laborer (NOTE: Foreman present during all phases of construction)	Measuring tape, stakes
2 hours	1	Dig trench from septic tank to site of distribution box	Two laborers	Two shovels
2 hours	1	Lay sewer pipe from tank to box site, mortar joints, cover with dirt	Two laborers	Shovels, sewer pipe, mortar
5 hours	2	Dig hole for distribution box	Two laborers	Shovels
6 hours	2-3	Build distribution box	One skilled laborer	Wood, hammer, nails, metal sheeting, tar, mortar, four lengths of sewer pipe
2 hours	4	Spread gravel in hole, install box	One laborer and one skilled laborer	Shovels, gravel
3 days	4-7	Dig trenches for drainpipes	Two or more laborers	Two or more shovels
4 hours	8	Spread gravel in trenches	Two or more laborers	Gravel, wheelbarrow, shovels
1½ days	8-9	Lay open-joint drainpipe	Two or more laborers	Drainpipe
2 hours	10	Cover open joints with tar paper	Two or more laborers	Tar paper
4 hours	10	Cover drainpipe with gravel	Two or more laborers	Gravel
2 hours	10	Cover gravel with straw	Two or more laborers	Straw
1 day	11	Fill in trench with dirt and mound	Two or more laborers	Shovels
1 day	21	Plant grass over system	One or two laborers	Rakes, grass seed

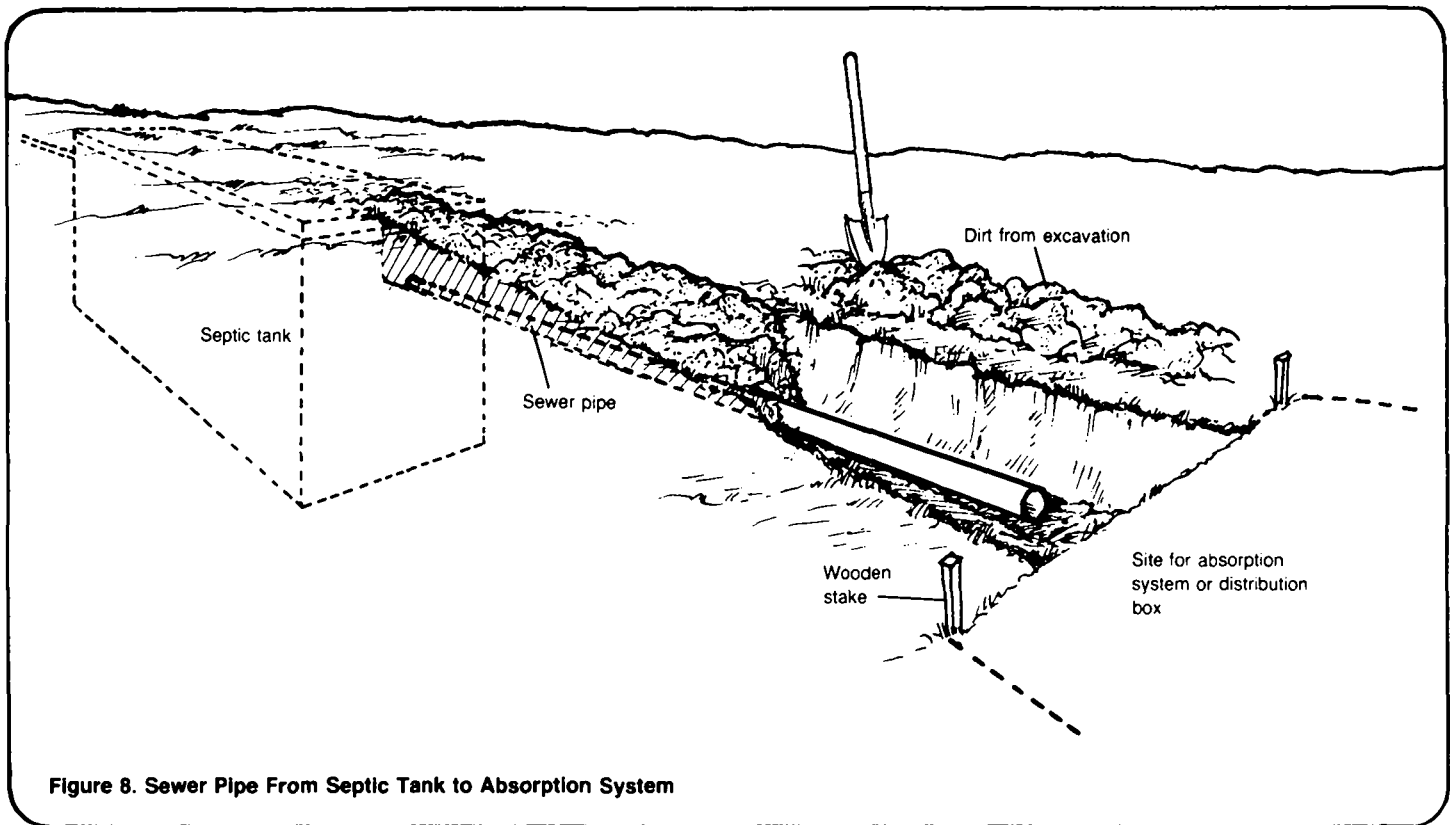
**Caution!**

1. When digging a pit deeper than 1.5m, shore up the sides to prevent a cave-in, which could be fatal to a worker in the pit.

2. All subsurface absorption systems must be constructed at the exact site and to the dimensions specified by the project designer in order to protect water supplies and to ensure proper operation of the system.

**General Construction Steps**

Depending on local conditions, availability of materials, skills of workers, and so on, some construction steps will take only a few hours, while others may take days or even weeks. Table 2 shows a sample work plan for building an absorption system including time estimates for each step. Draw up a similar work plan with rough time estimates based on local conditions.



**Figure 8. Sewer Pipe From Septic Tank to Absorption System**

You will then have an idea of when specific laborers, supplies and tools must be available during the construction process. The following are construction steps for building an absorption system.

1. Assemble all materials, tools, laborers, and drawings needed to begin construction. Study all diagrams carefully.
2. Use the location map similar to Figure 1 and a measuring tape to determine the correct location for the absorption system, including distribution box or "cross" or "T" fitting, if applicable, and mark it on the ground with wooden stakes or pointed sticks. Mark the trench line for the sewer pipe from the septic tank to the site of the absorption system. Be certain the locations of the trench line and absorption system are correct before beginning construction as shown in Figure 8.
3. Dig the trench from the septic tank to the site of the absorption

system with a downward trench grade or slope of about one in 100, which means that the trench bottom drops one unit in elevation for every 100 units in length. The trench should slope evenly and should be as straight as possible. Avoid sharp bends. The trench need not be more than 0.3m wide and 0.3m deep, sloping downward to the absorption system site. In level or uneven ground, the trench may have to be deeper to attain the correct downward slope of one in 100.

If the system is a trench, series of trenches, or field, the end of the sewer pipe must be at least 0.45m underground when it enters the site of the absorption system. This is to ensure that the absorption system is deep enough to have sufficient cover. Check the depth of the sewer pipe trench where it enters the absorption system site. If it is less than 0.45m, dig the trench bottom steep enough to reach a depth of 0.45m at the edge of the absorption system site nearest the septic tank.

4. Lay sewer pipe in the trench. Seal all pipe joints with tar, mortar, oakum, or other local caulking material. Check the slope of the pipe to be certain that liquid will flow downward from the septic tank to the absorption system.

(NOTE: This pipe may have been installed during construction of the septic tank.)

Cover the sewer pipe carefully with dirt, mound the dirt to allow for settling, and gently tamp.

### Construction Steps for a Single Trench System

1. Follow "General Construction Steps" 1 through 5.

2. Excavate the absorption trench to the length, width, and depth shown on the technical drawing provided by the project designer. The bottom of the absorption trench should be nearly level or slope gradually and evenly downward from the inlet end (septic

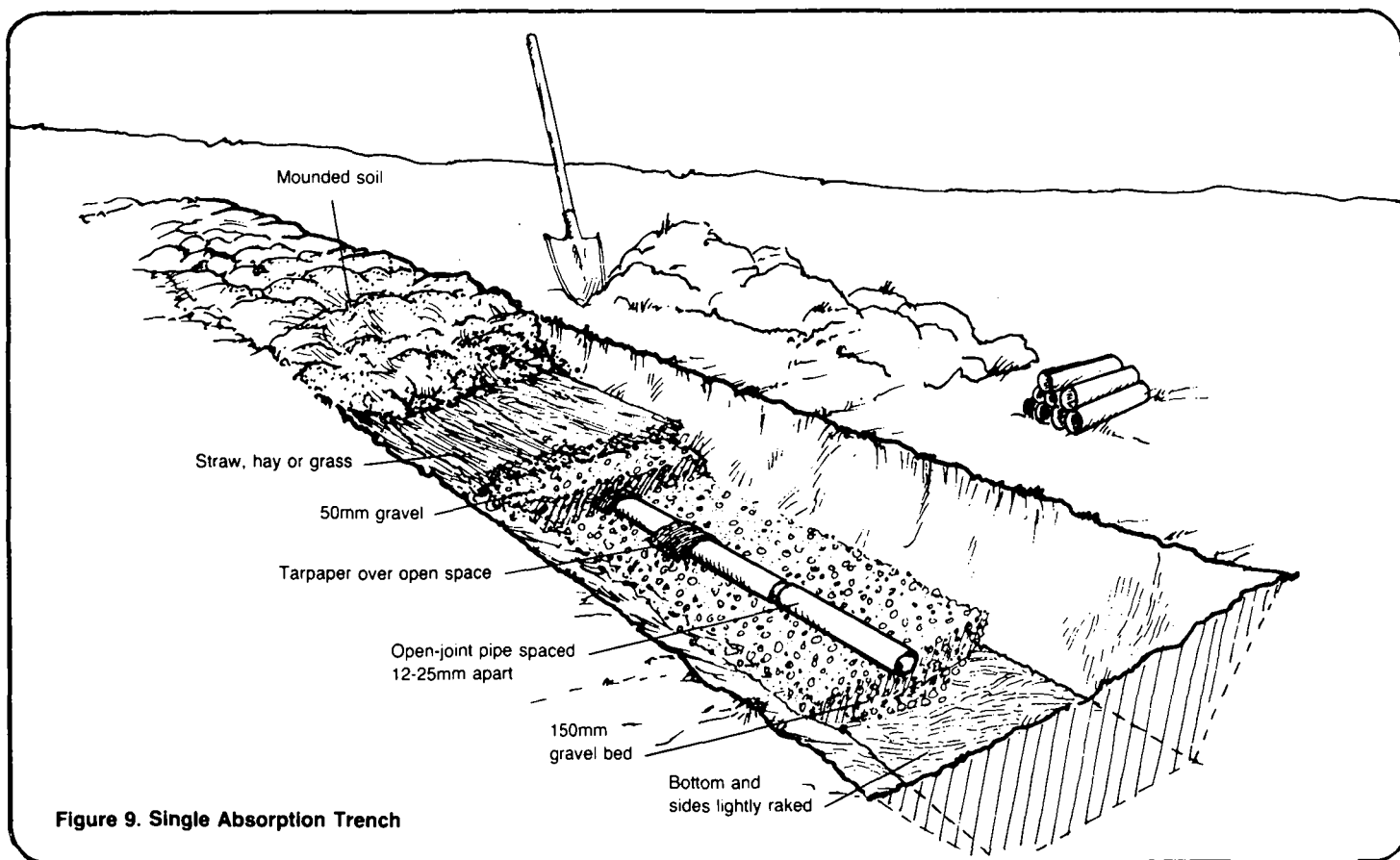
tank end) at no more than one in 200, as shown in Figure 9.

3. Lightly rake the bottom and sides of the trench with a rake or hoe. Do not walk in the trench after this step or the bottom will become compacted and lose permeability.

4. Spread 150mm of clean gravel or crushed rock along the entire length of the trench. The depth of the gravel must be uniform so the grade will remain gradual and even.

5. Lay the first section of drain-pipe in the inlet end of the absorption trench and mortar it to the end of the sewer pipe.

6. Lay the remainder of the drain-pipe in the trench. If perforated pipe is used, the perforations must face downward. If open-joint pipe is used, do not mortar the joints. Leave a space of 12 to 25mm between each pipe section. If non-perforated plastic pipe is available, either (a) drill



12mm holes 150mm apart in two parallel rows along the bottom of the pipe and use as perforated pipe, or (b) saw the pipe into 450mm sections and use as open-joint pipe. The drainpipe must be level or slope downward away from inlet end at no more than one in 200.

7. Plug the end of the last pipe section with cement, mortar, or other material that will not corrode.

8. Cover the open joint between pipe sections with building or tar paper to prevent cover gravel from sifting in and clogging the system.

## Construction Steps for a Series of Trenches

1. Follow "General Construction Steps" 1 through 5.

2. Dig the hole for the distribution box, "cross" fitting, or "T" fitting at the end of the sewer pipe, 150mm deeper than is necessary for the box or fitting alone. The bottom of the hole must be level.

3. Spread 150mm of gravel or crushed rock in the hole.

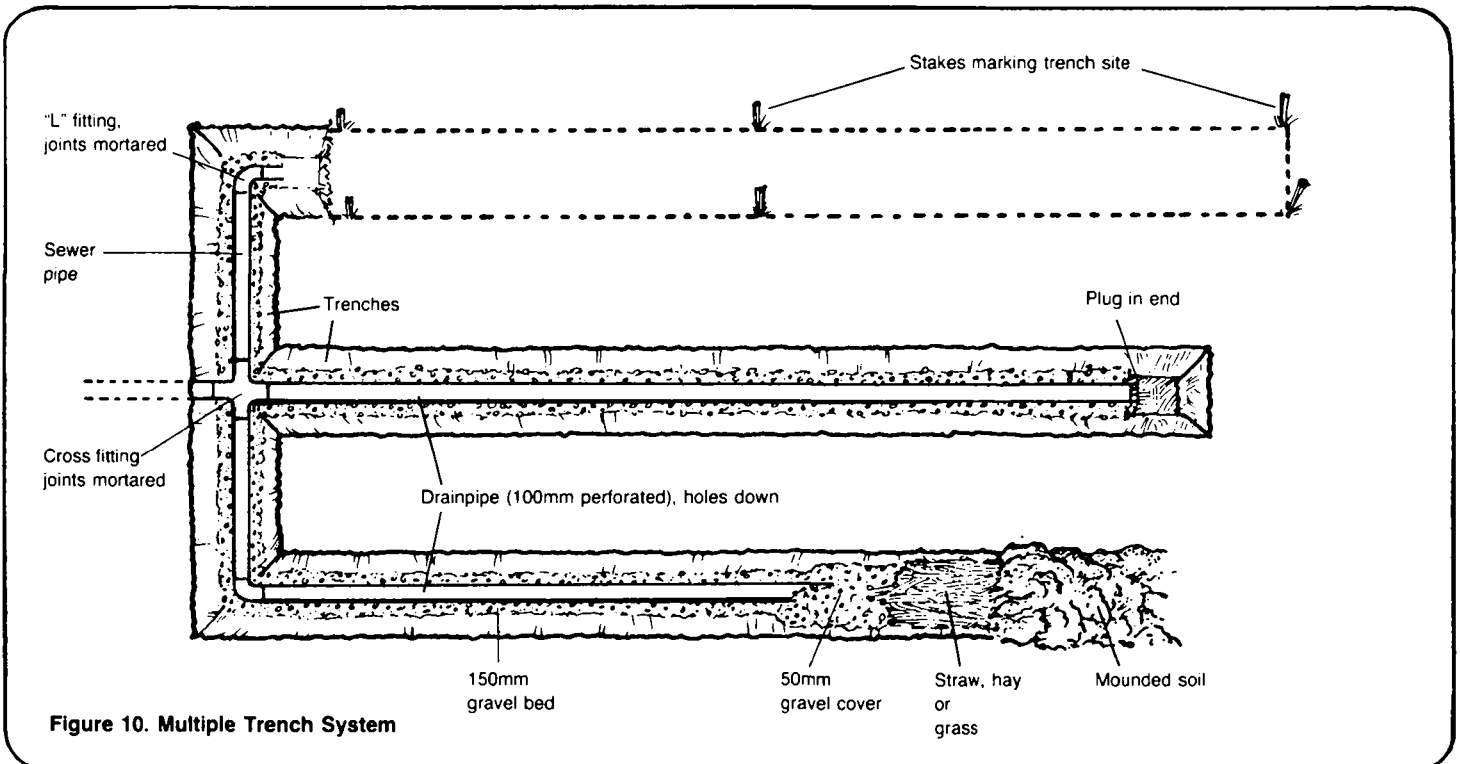


Figure 10. Multiple Trench System

9. Fill the trench with gravel or crushed rock to a depth of 50mm above the top of the drainpipe.

10. Cover the gravel or crushed rock with untreated paper, straw, hay, or grass to prevent dirt from sifting into the gravel.

11. Fill the trench with dirt and mound it to allow for settling. Do not tamp.

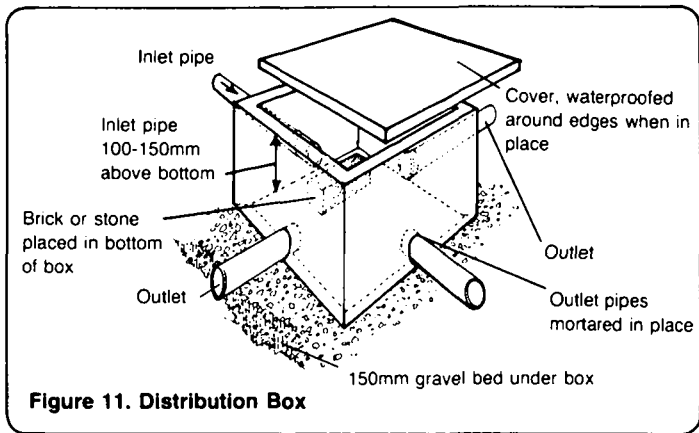
12. Plant grass over the system when the mound has settled, after a week or two. This will help prevent erosion by wind, rain, or surface water.

For a "cross" or "T" fitting:

4. Attach one end of the fitting to the sewer pipe and mortar the joint. The other ends of the fitting will be joined to the drainpipe as shown in Figure 10.

For a distribution box:

5. Build the box from wood, metal, brick, concrete block, or poured concrete to the dimensions on the technical drawing provided by the project designer. If the box is made from



brick and mortar, concrete block, or poured concrete, see "Constructing Septic Tanks," SAN.2.C.3, for details on working with these materials. A distribution box is shown in Figure 11.

5a. Make the bottom of the box level.

5b. Make the box watertight. If it is wood or metal, coat the inside with tar, or other waterproofing material. If the box is brick and mortar or concrete block, coat the inside with 12 to 25mm of cement mortar.

5c. Make the outlets to the absorption system level with the bottom of the box. The box will have two or more outlets, depending on the design. Make the inlet from the septic tank 100 to 150mm higher than the bottom of the box as shown in Figure 11.

5d. Build a watertight, secure cover for the box. The cover can be wood, metal, or concrete and should be strong enough to support the weight of an adult to prevent anyone from falling into the box.

5e. Place a brick or stone on the floor of the box after it is built to prevent effluent from flowing straight across the box to one outlet only.

5f. Extend the sewer pipe to the inlet of the distribution box and mortar the joint.

6. Lay sewer pipe from the outlets of the "cross," "T," or distribution box to the nearest end of each trench site, as shown in Figure 10. The sewer pipe must slope downward from the "cross," "T," or distribution box to

the trench site at no more than one in 100. Mortar all pipe joints including those at the outlets.

7. Secure the cover of the distribution box and waterproof around the edges with tar, oakum, or other waterproofing material. Cover the distribution box, "cross" fitting, or "T" fitting with dirt and gently tamp. Do this carefully because the distribution device must remain level.

8. Follow "Construction Steps for a Single Trench System" 2 through 6 for each trench and drain line.

For an open-end trench system:

8a. Plug the end of the last section of each drain line with cement, mortar, or other material that will not corrode.

For a closed-loop system:

8b. Attach "L" and "T" fittings, as called for in the design, to the last section of each drain line and lay drainpipes between these fittings. Mortar the joints at the fittings, but not the joints between drainpipe sections. This will prevent sewage effluent from accumulating at the corners of the system.

9. Follow "Construction Steps for a Single Trench System" 8 through 12.

### Construction Steps for a Field System

1. Follow "General Construction Steps" 1 through 5.

2. Follow "Construction Steps for a Series of Trenches" 2 through 5.

3. Lay sewer pipe from the outlets of the distribution box, "cross" fitting, or "T" fitting to the nearest side of the field site. The sewer pipe must slope downward from the distribution device to the field site at no more than one in 100. Mortar all pipe joints, including those at the outlets.

4. Secure the cover of the distribution box and waterproof around the edges with tar, oakum, or other waterproofing material. Cover the distribution box, "cross" or "T" with dirt and

gently tamp. Do this carefully because the distribution device must remain level.

5. Excavate the field to the width, length, and depth specified on the technical drawing provided by the project designer. The field must be level. Lightly rake the bottom of the field with the rake or hoe.

6. Spread 150mm of clean gravel or crushed rock over the entire field.

7. Lay the drainpipe on the gravel to the length and configuration shown on the technical drawing in Figure 12. If perforated pipe is used, the perforations must face downward. If open-joint pipe is used, do not mortar the joints. Leave a space of 12 to 25mm between each pipe section. However, do mortar the joints where the drainpipes connect with the sewer pipes and at all "T" and "L" fittings at the

corners and far side of the field. The drainpipe must be level or slope downward away from the inlet side of the field at no more than one in 200.

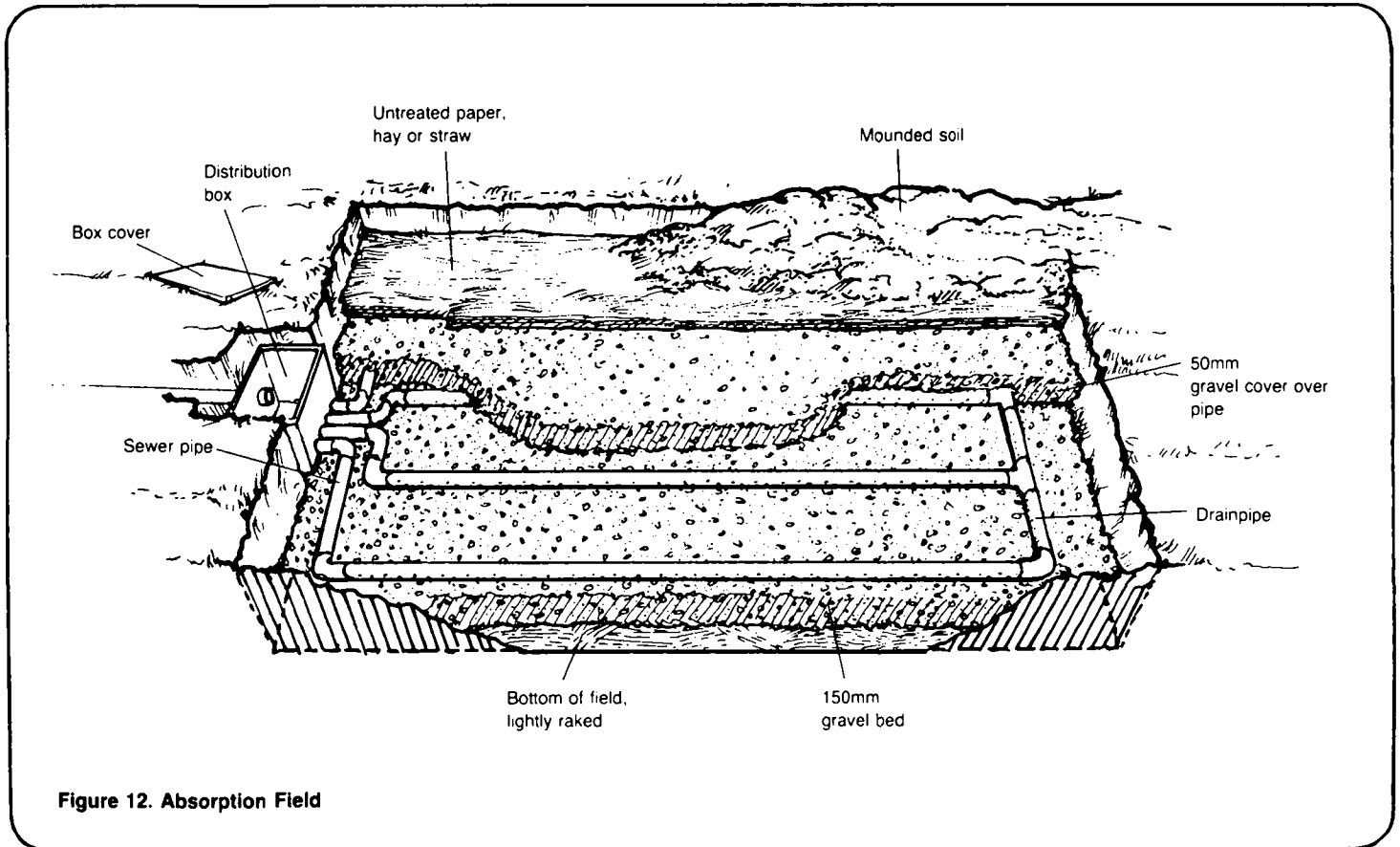
8. Cover the open joint between pipe sections with building or tar paper to prevent cover gravel from sifting in and clogging the system.

9. Fill the entire field with clean gravel or crushed rock to a depth of 50mm above the top of the drainpipe.

10. Cover the gravel or crushed rock with untreated paper, straw, hay, or grass to prevent dirt from sifting into the gravel.

11. Fill the entire field with dirt and mound slightly. Do not tamp.

12. Plant grass over the system when the mound has settled, after a week or two. This will help prevent erosion by wind, rain, or surface water.



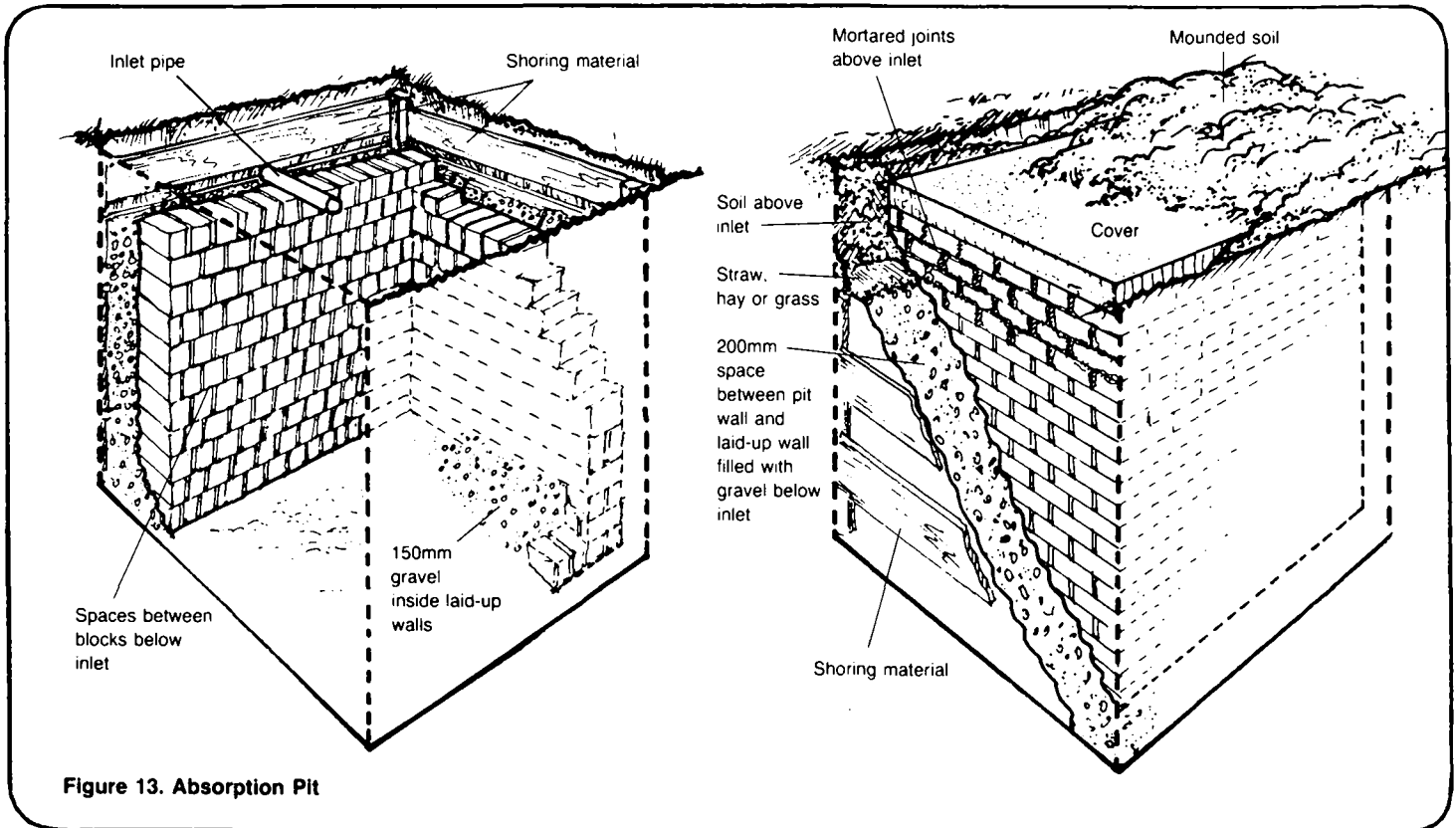


Figure 13. Absorption Pit

### Construction Steps for a Pit System

1. Follow "General Construction Steps" 1 through 5.

2. Dig the pit to the dimensions and depth specified on the technical drawing provided by the project designer. The design depth is measured downward from the inlet pipe, not from the surface of the ground. If the pit is deeper than 1.5m, shore up the sides with logs, boards, bamboo, or other local material during excavation to prevent a cave-in, which could be fatal to a worker in the pit. As a further precaution, dig the pit so the sides slope slightly outward: one unit out for every 10 units deep.

3. Lightly rake the sides of the pit with a rake or hoe to ensure permeability.

4. Lay up the side walls using bricks, concrete blocks, or selected field stones. Make the walls about 300mm thick. Leave a space of 200 to 250mm between the outside of the laid-up wall and earth wall of the pit. This space will eventually be filled

with gravel. Do not mortar the laid-up walls below the inlet. Figure 13 shows an absorption pit.

5. Extend the inlet pipe 100 to 150mm beyond the inside of the laid-up wall when the wall reaches the level of the inlet. This will allow effluent to fall into the pit without flowing down the sidewall and impairing the permeability of that portion of the wall.

6. Continue laying up the side walls to within about 0.3m below the surface of the ground. Mortar the side walls above the inlet. The mortar will give additional strength to the side walls above the inlet.

7. Fill the space between the laid-up wall and the earth sides of the pit with clean gravel or crushed rock. This material may be added as the walls are laid. When the gravel reaches the level of the inlet, cover it with untreated paper, straw, hay, or grass. Fill in the remainder of the space with dirt.

8. Lightly rake the bottom of the pit and spread 150mm of clean gravel or crushed rock over it.



9. Construct a strong, waterproof cover that fits flush with the outside edges of the laid-up walls. The cover may be wood, metal, or reinforced concrete. It must be strong enough to support the weight of an adult to prevent anyone from falling into the pit. If the cover is made of wood or metal, waterproof it with tar, oakum, or other waterproofing material. If the cover is made of concrete, build it in sections (see "Constructing Septic Tanks," SAN.2.C.3, for details of working with concrete and building a cover in sections).

10. Set the cover in place and waterproof around the edges. Cover and mound with dirt. Do not tamp.

### **Operating and Maintaining a Subsurface Absorption System**

When the absorption system is constructed and connected by sewer pipe to the septic tank, and the tank is connected by sewer pipe to the building to be served (see "Operating and Maintaining Septic Tanks," SAN.2.0.3), the system is ready to operate. Sewage will flow from the building to the septic tank, where it will remain for one to three days, allowing the solids to settle out. Effluent will flow from the tank to the absorption system and soak safely into the soil.

Maintaining the system involves inspecting it for burrowings, erosion, and system failure.

Burrowings. Small holes or excavations on or near the absorption system indicate the presence of dogs or burrowing animals. These animals should be kept away. Erect fences, if necessary.

Erosion. If there is erosion on or near the absorption system due to wind, rain, or surface water, fill and mound with dirt. Plant or resod grass over the system. If surface water is a problem, build small dams or trenches to divert it.

System Failure. An absorption system fails when the soil around it no longer absorbs sewage effluent, or when the soil absorbs effluent at a slower rate than it is received. When a system fails, it cannot be repaired. It must be abandoned and a new system built. When a system is failing, one or more of the following signs can be noted at or near the site: unusually lush growth; wet areas or puddles; continual odors.

An absorption system can fail for a number of reasons. Even though a failed system cannot be repaired, it is useful to know the major reasons for failure so they may be avoided in future systems:

- Improper location. The site was not adequately tested for soil suitability or groundwater levels; the test results were incorrectly used; or the results were ignored.

- Improper design. The system was not designed or constructed large enough, or the flow of sewage effluent substantially increased after the system was designed.

- Improper construction. The system was not constructed according to design specifications. This could mean a number of things: the trench slope was too steep; the drainpipe was incorrectly installed; the open joints were mortared or filled in with gravel; dirt was allowed to sift into the gravel.

- Improper construction of distribution device. The distribution box, "cross" fitting, or "T" fitting was not level, and the effluent flowed to only part of the system and that part became overloaded.

- Improper operation of septic tank. If the soil clogged with solids from the septic tank, it was not operating properly.

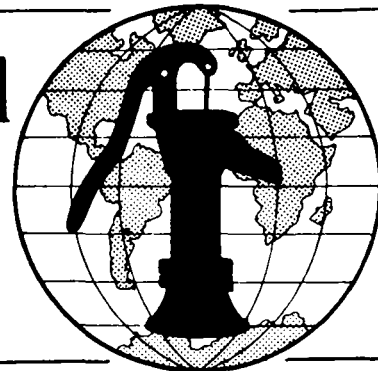
## Notes

## Notes

## Notes

**Technical Notes** are part of a set of "Water for the World" materials produced under contract to the U.S. Agency for International Development by National Demonstration Water Project, Institute for Rural Water, and National Environmental Health Association. Artwork was done by Redwing Art Service. Technical Notes are intended to provide assistance to a broad range of people with field responsibility for village water supply and sanitation projects in the developing nations. For more detail on the purpose, organization and suggestions for use of Technical Notes, see the introductory Note in the series, titled "Using 'Water for the World' Technical Notes." Other parts of the "Water for the World" series include a comprehensive Program Manual and several Policy Perspectives. Further information on these materials may be obtained from the Development Information Center, Agency for International Development, Washington, D.C., 20523, U.S.A.

# Water for the World



## Constructing, Operating, and Maintaining Cesspools Technical Note No. SAN. 2.C.2

A cesspool is a covered pit with open-joint walls that receives piped sewage. The solids settle to the bottom and the effluent passes through the walls into the surrounding soil. Constructing a cesspool involves excavating a pit at the correct location; laying up sidewalls with stones, bricks, or concrete blocks; and connecting the cesspool to a dwelling with sewer pipe. The system is self-operating and requires little or no maintenance. It must be periodically inspected for system failure.

A properly constructed cesspool can last from five to 15 years. This technical note describes how to construct a cesspool. Read the entire technical note before beginning construction.

### Useful Definitions

**CONTAMINATE** - To make unclean by introducing an infectious (disease-causing) impurity such as bacteria from sewage and effluent.

**EFFLUENT** - Settled sewage.

**SEWAGE** - All washwater, excreta, and water used to flush excreta that flows from a building or buildings through a sewer pipe and into a septic tank, cesspool, or stabilization pond.

### Materials Needed

The project designer must provide three papers before construction can begin:

1. Location map similar to Figure 1 showing the cesspool in relation to water supplies, dwellings, streams, trees, and property lines,

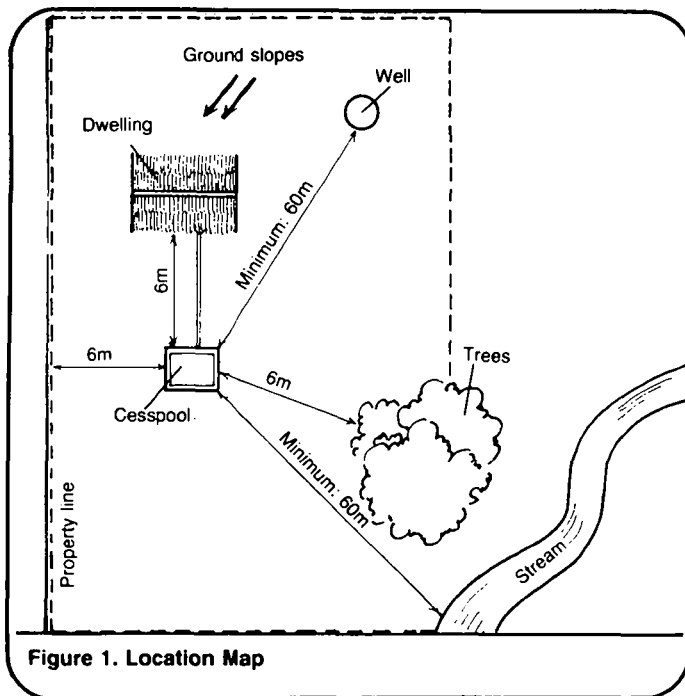


Figure 1. Location Map

2. Plan views similar to Figure 2 showing length, width, depth, and other design criteria,

3. Materials list similar to Table 1 showing all labor, materials, and tools needed to construct the cesspool.

### Constructing a Cesspool

Depending on local conditions, availability of materials, and skills of workers, some construction steps will require only a few hours while others may take a day or more. Read the construction steps and make a rough estimate of the time required for each step. You will then have an idea of when specific laborers, materials, and tools must be available during the construction process. Draw up a work plan similar to Table 2 showing construction steps.

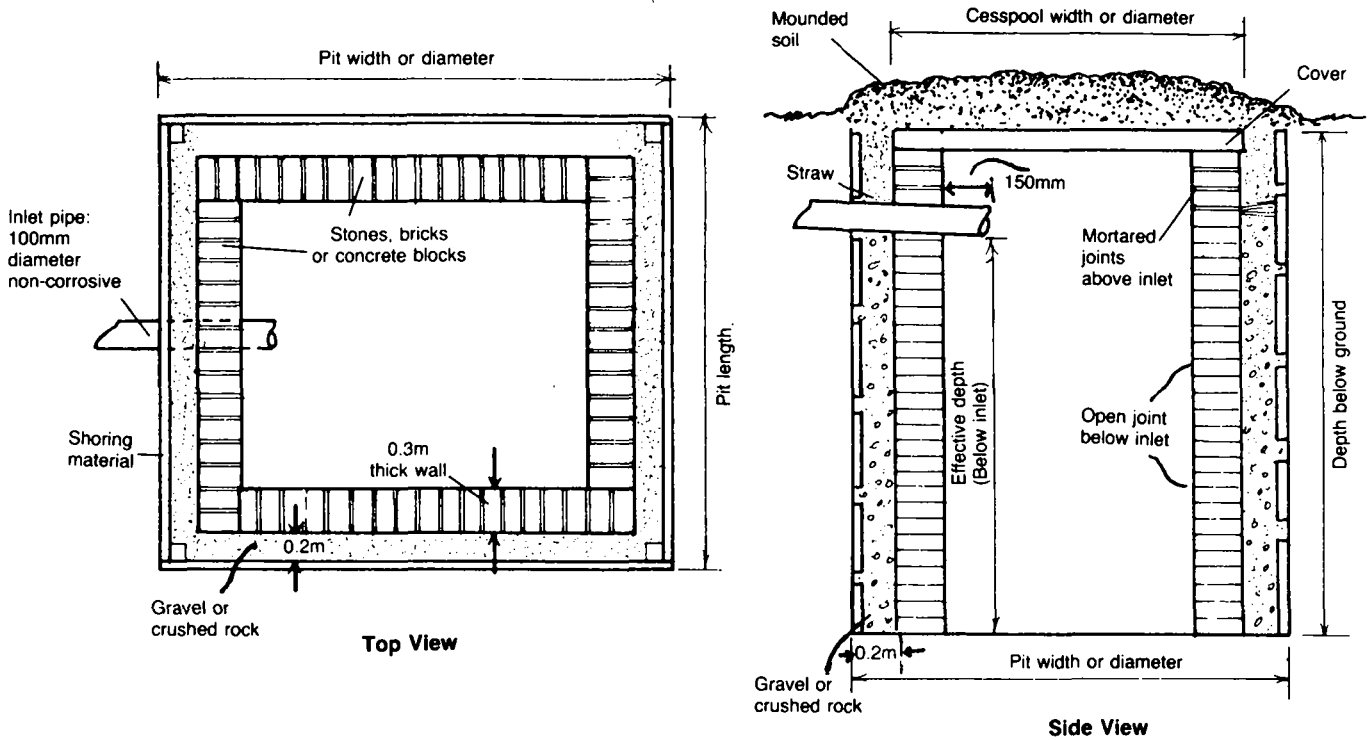


Figure 2. Cesspool

Table 1. Sample Materials List

Item	Description	Quantity	Estimated Cost
Labor	Foreman	1	_____
	Laborers	3	_____
Supplies	Bricks for sidewalls	_____	_____
	Gravel for filler	_____	_____
	Concrete for cover	_____	_____
	Mortar or tar for water-proofing	_____	_____
	Inlet pipe (100mm, non-corrosive)	_____	_____
	Straw	_____	_____
	Shoring material	_____	_____
	Nails	_____	_____
Other	_____	_____	
Tools	Measuring tape	1	_____
	Shovels	4	_____
	Picks	1	_____
	Wheelbarrow	1	_____
	Containers for mixing concrete	2	_____
	Hammer	1	_____
	Saw	1	_____
	Other	_____	_____

Estimated Cost = \_\_\_\_\_

**Table 2. Sample Work Plan**

Time Estimate	Day	Task	Personnel	Materials and Tools
1 hour	1	Mark trench and pit site	Foreman; 1 laborer	Drawings, measuring tape, stakes
3 hours	1	Excavate trench	Foreman; 3 laborers	3 shovels, 1 pick
4 hours	1	Lay sewer pipe	Foreman; 3 laborers	100mm diameter clay pipe, mortar
1 hour	2	Place barricades around pit site	Foreman; 3 laborers	Machetes, bamboo poles, vine
6 hours	2	Begin excavating pit	Foreman; 3 laborers	3 shovels; 1 pick; 1 wheelbarrow
6 hours	3	Complete excavation	Foreman; 3 laborers	3 shovels; 1 pick; 1 wheelbarrow
2 hours	3	Shore sides of pit	Foreman; 3 laborers	Machetes; bamboo, vine
4-6 hours	4	Begin laying up sidewalls and placing gravel filler	Foreman; 3 laborers	Concrete blocks, gravel
1 hour	4	Extend inlet pipe beyond interior of sidewall	Foreman; 3 laborers	100mm diameter clay pipe, mortar
2 hours	5	Complete sidewalls	Foreman; 3 laborers	Concrete blocks, mortar
1 hour	5	Complete filler	Foreman; 3 laborers	Gravel, straw, soil
2 hours	5	Build cover	Foreman; 1 laborer	Hammer, saw, nails, tin sheets
2 hours	5	Place cover, waterproof, and mound with soil; remove barricades	Foreman; 1 laborer	Tar, 2 shovels

**Caution!**

1. When excavating a pit deeper than 1.5m, shore up the sides to prevent a cave-in which could be fatal to a worker in the pit.

2. During excavation, erect barricades to keep away unauthorized persons who might fall in the pit and suffer serious injury.

3. To avoid contaminating water supplies, construct the cesspool to the exact specifications and at the precise location specified by the project designer.

1. Assemble all laborers, materials, tools, and drawings needed to begin construction. Study all drawings carefully.

2. Determine the correct location of the cesspool using the location map and a measuring tape. Clear the area of any vegetation that may hinder construction. Lay out the dimensions of the cesspool on the ground and mark its location with stakes or pointed sticks. Mark the trench line for the pipe from the dwelling to the site for the cesspool as shown in Figure 3.

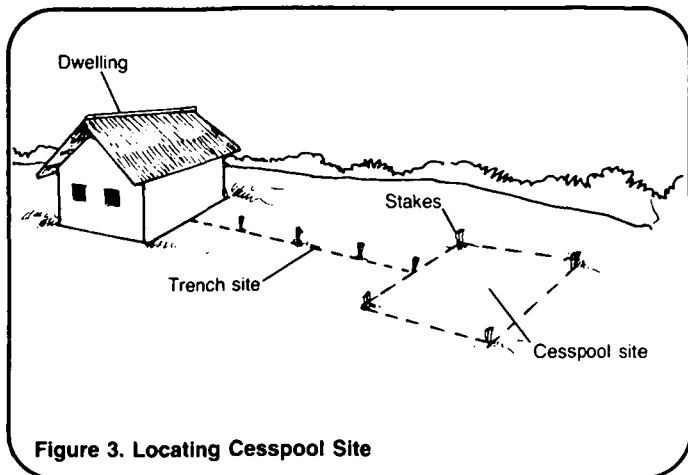


Figure 3. Locating Cesspool Site

3. Excavate the trench from the dwelling to the cesspool site with a downward grade of about 1 in 100. This means that the trench bottom drops one unit in elevation for every 100 units in length. The trench should slope evenly and be as straight as possible. It need be no more than 0.3m wide and 0.3m deep.

4. Lay 100mm diameter vitrified clay, concrete, or plastic sewer pipe in the trench from the dwelling to the cesspool site as shown in Figure 4. Seal all pipe joints with mortar or similar material.

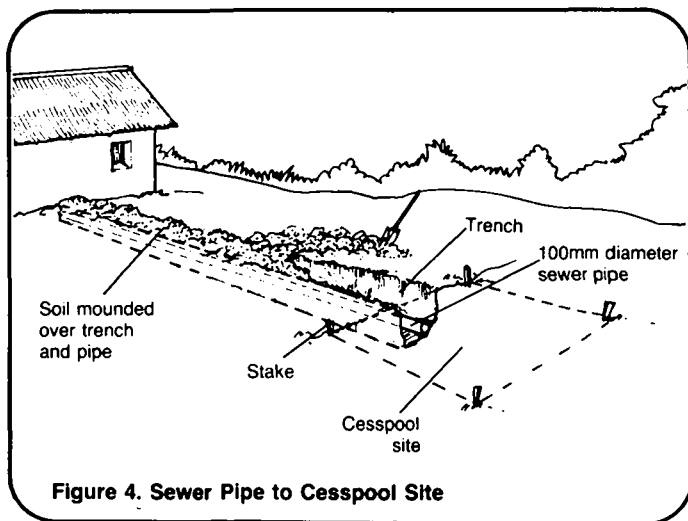


Figure 4. Sewer Pipe to Cesspool Site

5. Check the slope of the sewer pipe by pouring water into the pour-flush bowl or other receptacle in the dwelling. If water does not flow

through to the end, check for leaks or an improper slope. Make the necessary correction, then cover the pipe with soil and mound. Erect barricades around the pit site.

6. Excavate the pit to the width, length, and depth specified by the project designer. The depth is measured downward from the end of the inlet pipe, not from the surface of the ground. The walls should be vertical and fairly smooth but not compacted. As the pit is being excavated, lightly rake the sides and check to make sure they are vertical using a plumb line or a rock and string as shown in Figure 5. Shore up the walls with bamboo, boards, or poles, leaving 100-150mm space between each pole or board. See Figure 6.

If the pit is to be deeper than 2.5m, shore the walls in two sections: upper and lower. When the depth below the surface of the ground reaches about

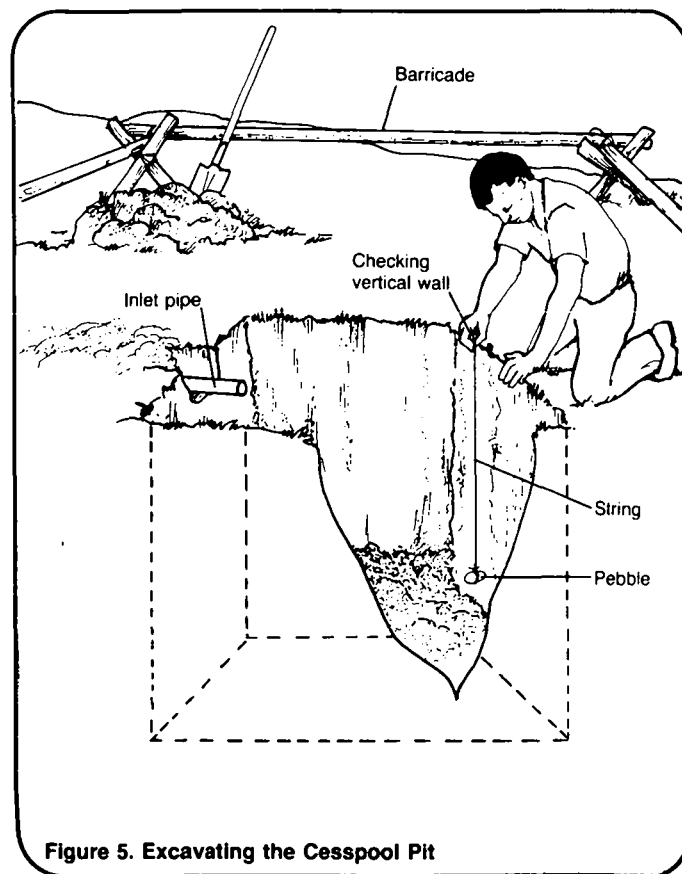
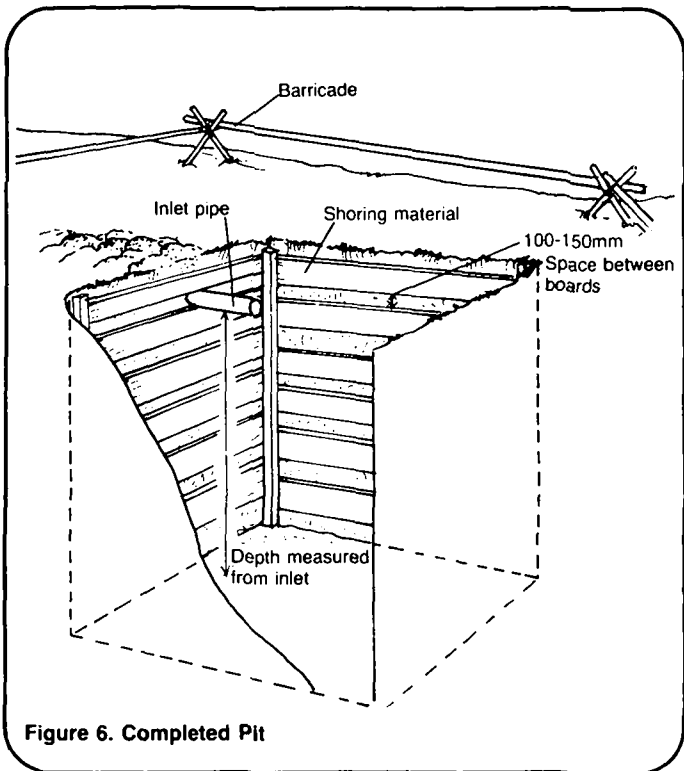


Figure 5. Excavating the Cesspool Pit

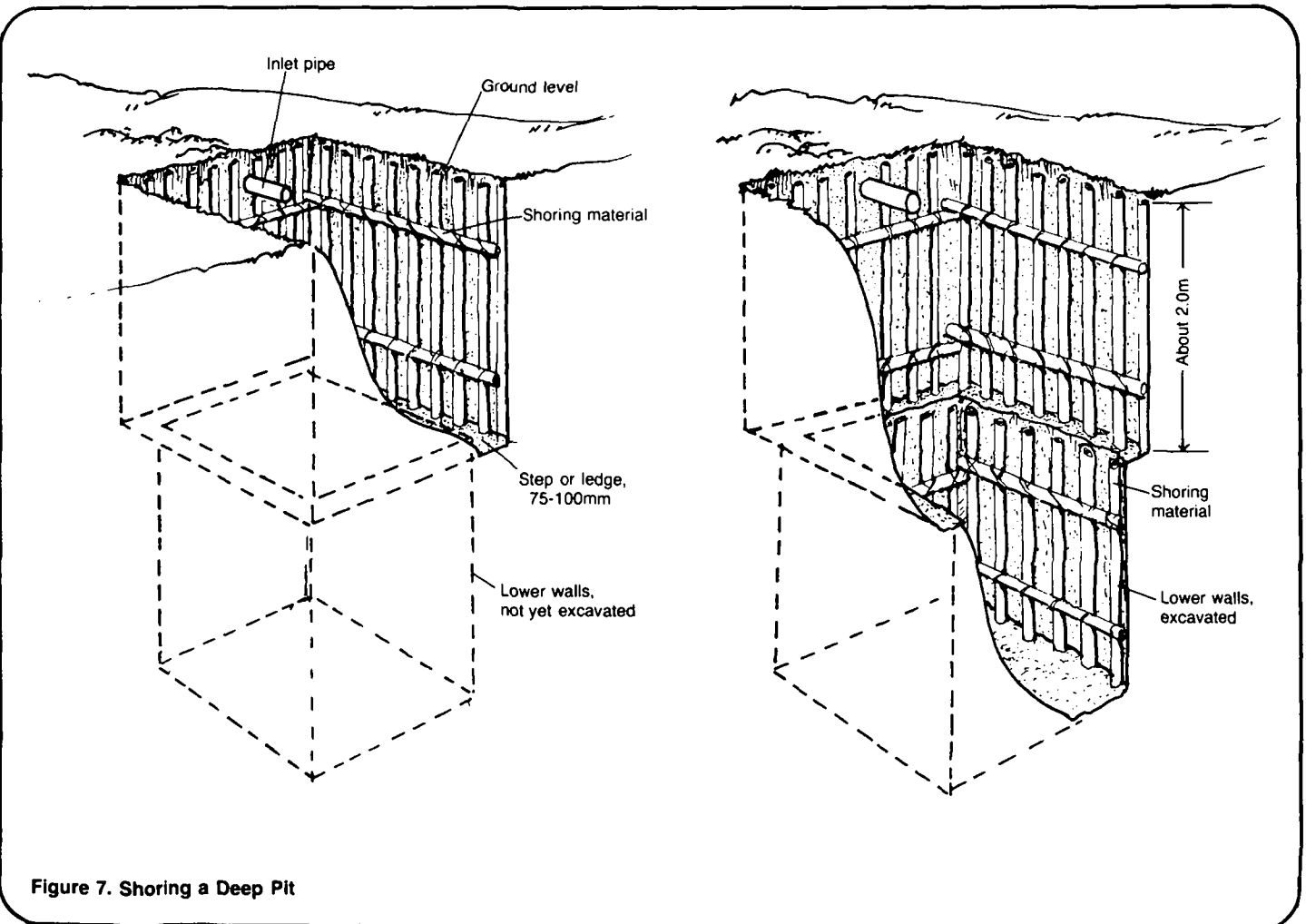




2.0m, secure shoring materials in place. Continue excavating, leaving a 75-100mm wide ledge or step around the walls to support the upper shoring. When the pit reaches the design depth, measured downward from the inlet pipe, shore up the lower walls. See Figure 7. The bottom of the pit should be fairly level.

7. Begin laying up the sidewalls using bricks, concrete blocks, or select field stones. Make the walls about 0.3m thick. Leave about 0.2m between each sidewall and the earth wall of the pit. Later, this space will be filled with gravel or crushed rock. Do not mortar the laid-up walls below the inlet. See Figure 8.

8. When the walls reach the level of the inlet, extend the inlet pipe 150mm into the pit. This will allow sewage to fall into the pit without running down the wall.



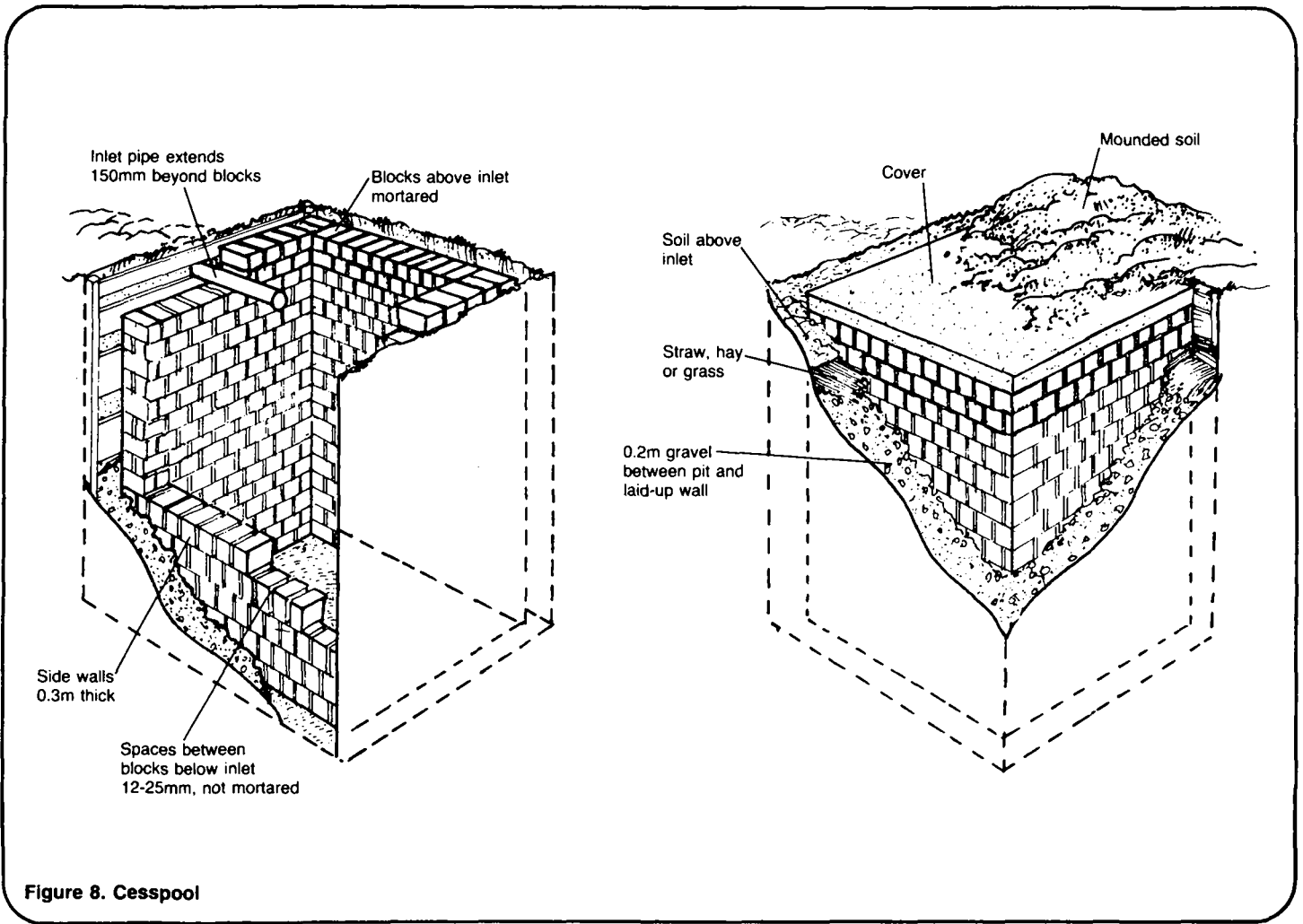


Figure 8. Cesspool

9. Continue laying up the sidewalls to within about 0.3m below the surface of the ground. Mortar the sidewalls above the inlet for strength.

10. Fill in the space between the laid-up walls and the earth walls of the pit with gravel, crushed rock, or pebbles. This material may be added as the walls are laid up. When the gravel reaches the level of the inlet pipe, cover it with straw or hay. Fill in the remainder of the space with soil. See Figure 8.

11. Construct a strong, waterproof cover that fits flush with the outside edges of the laid-up walls. The cover may be wood, metal, or reinforced concrete. It must be strong enough to support the weight of an adult to prevent anyone from falling into the pit.

If the cover is made of wood or metal, waterproof it with mortar, tar, or an equivalent material. If the cover is made of concrete, build it in sections. See "Constructing Septic Tanks," SAN.2.C.3, for details of working with concrete and building a cover in sections.

12. Set the cover in place and waterproof around the edges. Cover and mound with dirt. See Figure 8.

### Operating and Maintaining a Cesspool

A cesspool is a self-operating system. Once it is constructed and connected by sewer pipe to the fixture in the dwelling, it is ready for operation. Maintaining a cesspool involves inspecting it for burrowings, erosion, and system failure.

Burrowing. Small holes or excavations on or near the cesspool indicate the presence of burrowing animals. These animals should be kept away by erecting fences, if necessary.

Erosion. If there is erosion on or near the cesspool due to wind, rain, or surface water, fill the holes and mound with soil. Plant grass over the system to help prevent erosion. If surface water is a problem, build small dams or trenches to divert it.

System Failure. If the fixture in the dwelling backs up with sewage, it

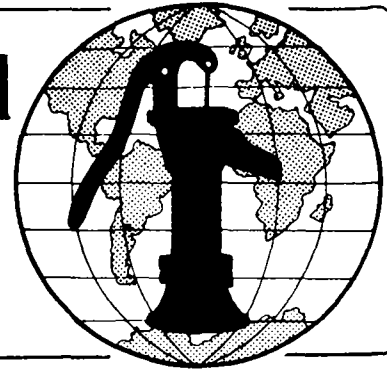
may be that the sewer line is clogged. Excavate the pipe, inspect and repair it.

The system may eventually fail. When it does, one or more of the following signs can be observed on or near the site: unusually lush growth, wet areas or puddles, and continual odors. When the system fails, it means that the surrounding soil can no longer absorb effluent. The system cannot be repaired. It must be abandoned and a new cesspool designed and constructed. Consult the project designer.

## Notes

**Technical Notes** are part of a set of "Water for the World" materials produced under contract to the U.S. Agency for International Development by National Demonstration Water Project, Institute for Rural Water, and National Environmental Health Association. Artwork was done by Redwing Art Service. Technical Notes are intended to provide assistance to a broad range of people with field responsibility for village water supply and sanitation projects in the developing nations. For more detail on the purpose, organization and suggestions for use of Technical Notes, see the introductory Note in the series, titled "Using 'Water for the World' Technical Notes." Other parts of the "Water for the World" series include a comprehensive Program Manual and several Policy Perspectives. Further information on these materials may be obtained from the Development Information Center, Agency for International Development, Washington, D.C., 20523, U.S.A.

# Water for the World



## Constructing Septic Tanks Technical Note No. SAN. 2.C.3

A septic tank is a self-operating unit for sewage treatment. The tank receives raw sewage from a building, allows solids to settle out, and discharges effluent to an underground (subsurface) absorption system for final disposal. Figure 1 is a drawing of a septic tank. Constructing a septic tank involves digging a trench and hole at the proper location, laying sewer pipe, and either building a tank from concrete or masonry or installing a prefabricated one. This technical note describes each step in constructing a septic tank.

Read the entire technical note before beginning construction.

### Useful Definitions

**EFFLUENT** - Settled sewage.

**EXCRETA** - Human body wastes.

**FLOW LINE** - The highest level to which liquid can rise in a septic tank, (usually 375mm below the top of the tank).

**LIQUID DEPTH** - The distance from the flow line to the bottom of the tank.

**SEWAGE** - All washwater, excreta, and water used to flush excreta that flows from a building, or buildings, through a sewer pipe, and into a septic tank, cesspool, or stabilization pond.

### Materials Needed

The project designer must provide three essential documents before construction can begin:

1. A location map similar to Figure 2.

The map shows where the septic tank is to be located and the actual distances from the tank to water supplies, dwellings, property lines, trees, roads, and any other prominent features.

2. A plan view of the septic tank similar to Figure 3. The diagram shows the top, side, and end views of the tank with their dimensions. The septic tank should be built according to the specifications shown in the diagram.

3. A materials list similar to Table 1 describing all labor, materials, and tools necessary to construct the tank. (NOTE: Figures 1, 2, and 3 and Table 1 are samples only and cannot be used to build the septic tank. The documents you need will be provided by the project designer.)

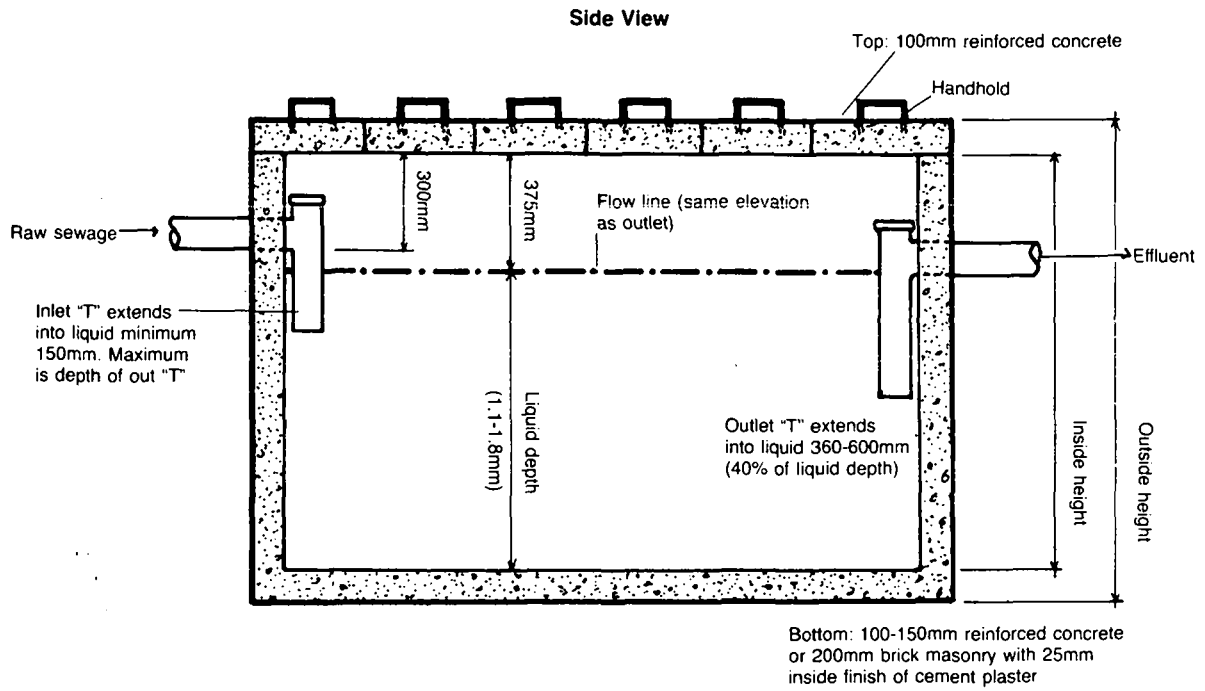
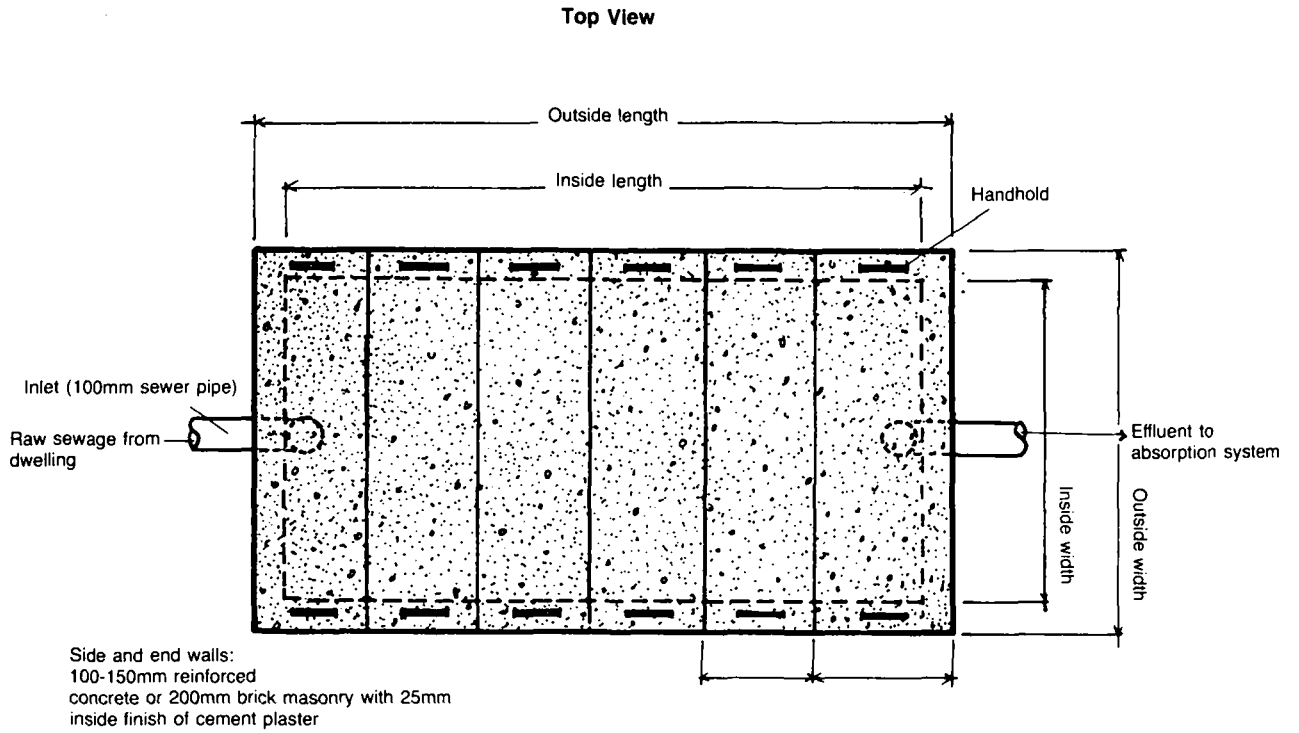
After the project designer has given you these documents and after you have read this technical note carefully, begin assembling the necessary workers, materials, and tools.

### Caution!

1. When excavating deeper than 1.5m, shore up the sides of the hole with logs, boards, bamboo, or other local material. Dig the hole so the sides slope slightly outward: 1 unit out for every 10 units deep. These precautions will help prevent cave-ins, which can be fatal to workers.

2. The top of the septic tank must be strong enough to support its own weight as well as the weight of the dirt that may cover it.

3. The septic tank top must be watertight. The tank will not operate properly if surface water or ground-water enters.



**Figure 1. Septic Tank**

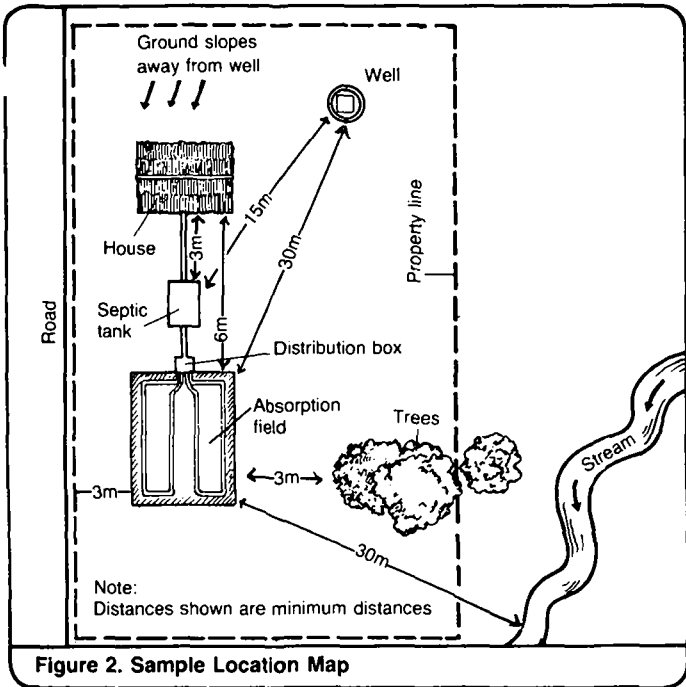


Figure 2. Sample Location Map

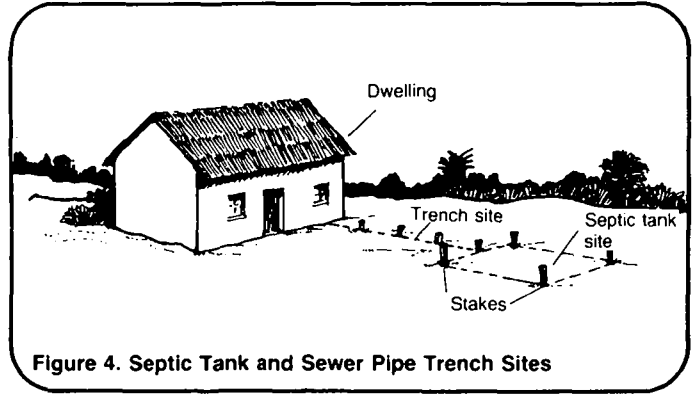


Figure 4. Septic Tank and Sewer Pipe Trench Sites

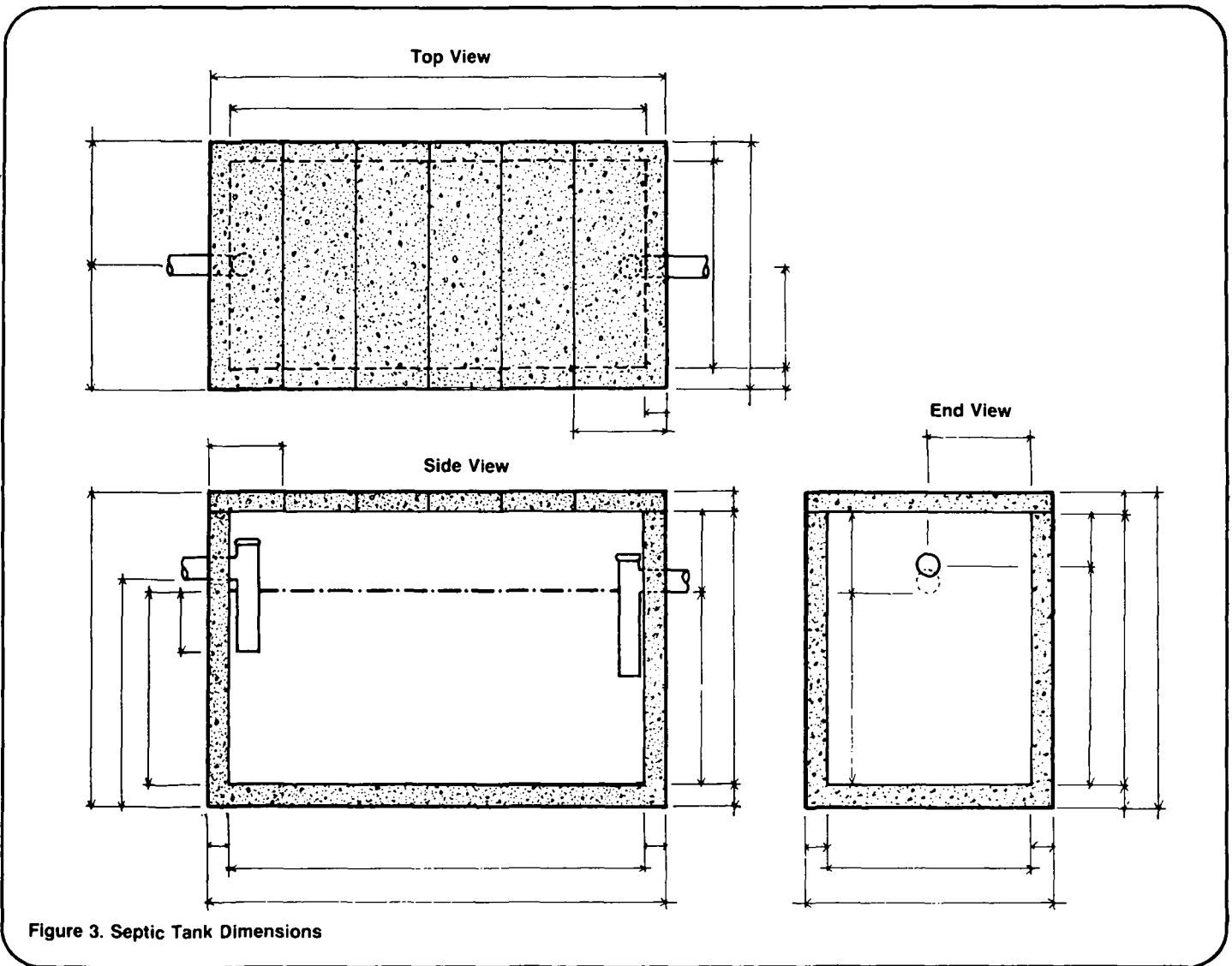


Figure 3. Septic Tank Dimensions

Table 1. Sample Materials List

Item	Description	Quantity
Labor	Foreman Laborers (NOTE: Either the foreman or one of the laborers must have some experience with concrete work.)	1 2 (at least)
Supplies	Portland cement Sand: clean, fine to 6mm Gravel: clean, 6-38mm Water (enough to make a fairly stiff mixture; quantity is a rough estimate) Wire mesh (reinforcing material) Sewer pipe 100mm diameter vitrified clay  "T" sewer pipe fittings (for inlet and outlet) Gravel for bedding material  Wooden boards (for building forms) Timber, bamboo, or wood (for shoring up sides of hole) Tar or equivalent (for waterproofing top of tank) Nails (for building forms) Handholds (horseshoes or other bent pieces of metal) Tar, mortar, or oakum (for sealing pipe joints) Other	0.5m <sup>3</sup> 0.9m <sup>3</sup> 1.4m <sup>3</sup>  300 liters 21m <sup>2</sup> _____ m: enough to reach from dwelling to septic tank and from tank to field, plus several sections to be used as extensions to "T" fittings  2 _____ m: enough to spread under tank to a depth of 75mm  _____ _____ _____ _____ 10 (2 for each section of top) _____ _____
Tools	Measuring tape Shovels Bucket Container for mixing concrete (or hand mixer) Hoe Trowel Saw Hammer Plumb line (rock and string) Carpenter's level or equivalent (extremely useful, though not essential) Carpenter's square or equivalent (extremely useful, though not essential) Other	1 2 (at least one per worker) 1 1 1 1 1 1 1 1 1 1 1 1 _____

DO NOT USE THE QUANTITIES IN THIS SAMPLE; PROJECT DESIGNER WILL PROVIDE CORRECT QUANTITIES



## Construction Steps

Some construction steps will take only a few hours, while others may require several days. The amount of time needed for each step depends on local conditions, availability of materials, skill of workers, and so on.

Table 2 shows a sample work plan for building a septic tank including time estimates for each step. Draw up a similar work plan with rough time estimates. This will give you an idea of when during the construction process specific workers, materials, and tools will be needed.

**Table 2. Sample Work Plan for Constructing a Septic Tank**

Time Estimate	Day	Task	Personnel	Tools/Materials
4 hours	1	Excavate trench	2 laborers and foreman (foreman present during all phases of construction)	2 shovels
3 hours	1	Lay sewer pipe	2 laborers	Sewer pipe, mortar
2 days	2 - 3	Excavate hole and shore up sides	2 laborers	Shovels, wood, hammer, nails
6 hours	4	Build forms, mix and pour concrete for floor	Laborer and concrete worker	Wood, cement, sand, gravel, water, mixing container, trowel, reinforcing material
6 hours	5	Build forms, mix and pour concrete for top	Laborer and concrete worker	Wood, cement, sand, gravel, water, mixing container, trowel, reinforcing material
7 days	5 - 11	Allow concrete to set		
9 hours	12	Build forms, mix and pour concrete for walls	Laborer and concrete worker	Wood, cement, sand, gravel, water, mixing container, trowel, reinforcing material; plus two "T" fittings,
7 days	12 - 18	Allow concrete to set		
6 hours	19	Extend sewer to inlet and outlet	2 laborers	Shovels, sewer pipe, mortar
3 hours	20	Place fill dirt around tank	2 laborers	Shovels
1 hour	20	Set top in place and waterproof	2 laborers	Tar or equivalent
1 hour	20	Cover with dirt (if necessary) and place marker	2 laborers	Shovels, marker

The following are general construction steps for building a septic tank.

1. Assemble all materials, tools, workers, and drawings needed to begin construction. Study all diagrams carefully.

2. Locate the site of the tank using the location map and measuring tape, and mark it on the ground with wooden stakes or pointed sticks as shown in Figure 4. Do the same for the trench line for the sewer pipe from the building to be served to the tank site. Double check the location map to make certain the staked-out locations are correct before beginning construction.

3. Excavate the trench from the building to the septic tank site with a downward slope of from 1 in 50 to 1 in 100. This means the trench drops 1 unit in elevation for every 50 to 100 units of length. Figure 5 shows the slope of the pipe trenches. The trench should slope evenly and be straight as possible. Avoid bends. The trench need not be more than 300mm wide and 300mm deep in ground sloping down to the tank site. In level or uneven ground, the trench may have to be deeper to attain the proper downward slope (1 in 50 to 100).

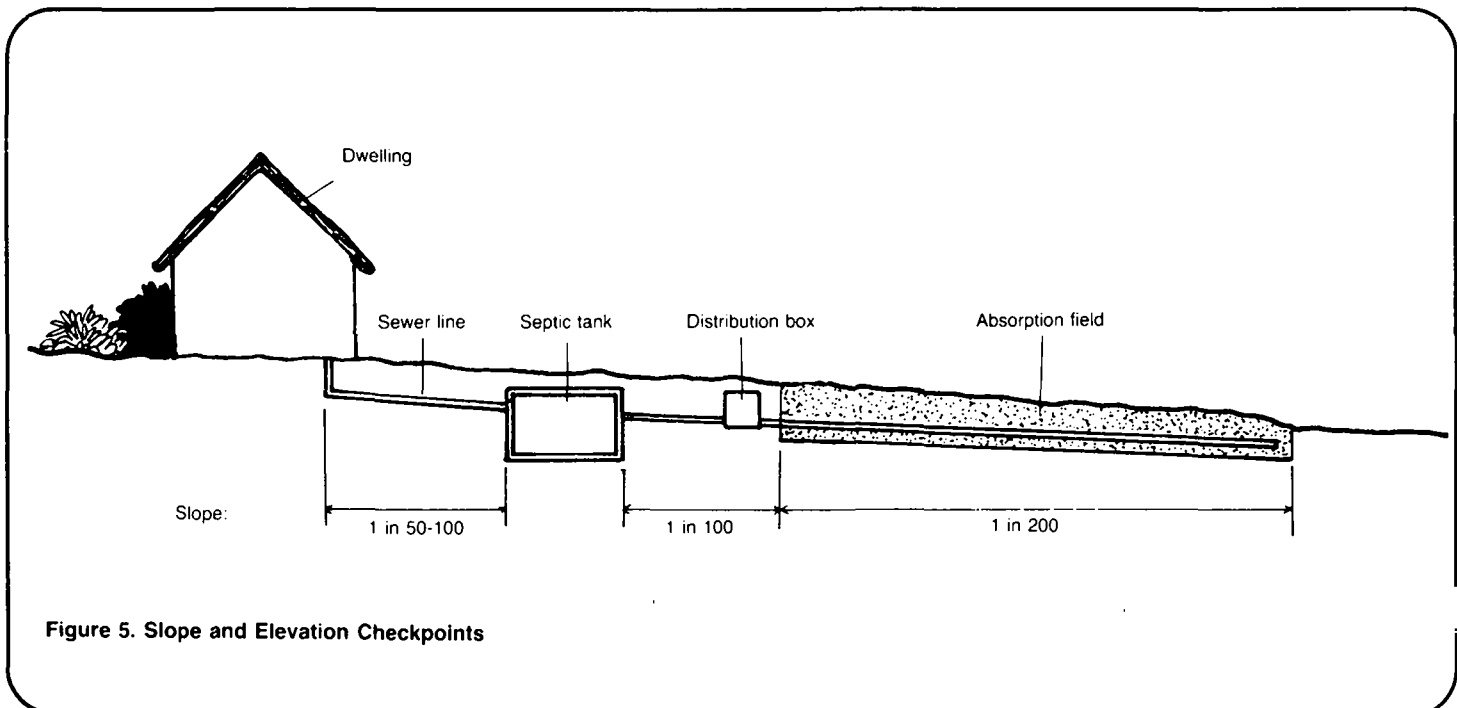
4. Lay sewer pipe in the trench. Pipe probably will be 100mm diameter

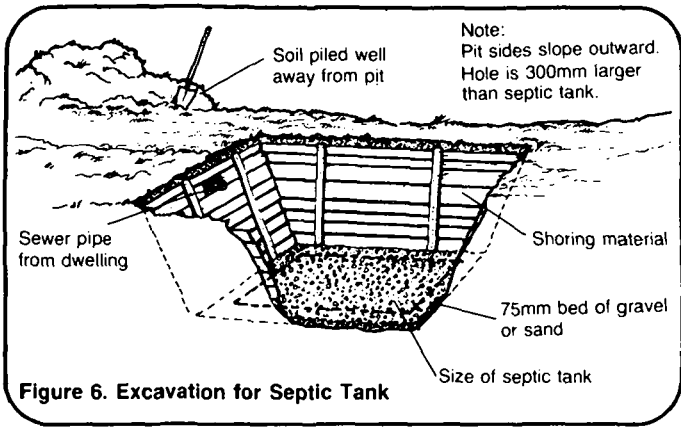
vitri-fied clay or other noncorrosive material. Seal all pipe joints with tar, mortar, oakum, or other local caulking materials. The pipe is laid at this stage to make certain that its slope is correct before continuing construction. Pour water in the pipe at the building to see if it flows through the entire pipe; if it does not, re-excavate the trench and re-lay the pipe until the slope is correct. Laying the pipe also shows the proper depth to excavate the hole for the tank. The depth is measured down from the end of the sewer pipe, not from the surface of the ground.

5. Dig the hole. Allow for outward slope of sides (at least 1 in 10) and working area around each side of at least 300mm. If the hole is to be more than 1.5m deep, begin shoring the sides as you excavate to prevent a cave-in. To determine how deep to dig the hole, measure down from the extended sewer pipe (this will be the inlet end of the septic tank as shown in Figures 1 and 6), then allow:

75mm  
plus the liquid depth,  
plus the floor thickness,  
plus 75mm for the gravel bed.

The bottom of the hole should be level.





6. Spread 75mm of sand, gravel, or crushed rock on the bottom of the excavation.

(NOTE: During construction continually check diagrams and field measurements to be certain the tank is built properly.)

For a Reinforced Concrete Tank:

1. Follow "General Construction Steps" 1 through 6.

2. Build wooden forms for the bottom of the tank. Build them in place at the bottom of the hole according to the dimensions (length, width, and thickness) on the plan view supplied by the project designer. Align forms with the sewer pipe. Check the distance down from the end of the sewer pipe to the top of the forms - this distance must be 75mm plus the liquid depth.

3. Position and secure reinforcing material within the forms. If L-shaped bars are to be used to help secure the walls to the bottom of the tank, they should be set in place at this point. The upper half of the bar should extend into the center thickness of the wall as shown in Figure 7.

(NOTE: Double check all measurements before pouring concrete.)

4. Mix concrete with the proper proportions of cement, sand, gravel, and water. A common mix by volume is one part cement to two parts sand to three parts gravel and enough water to make a fairly stiff mix.

Cement: Use Portland cement.  
Remove any hard lumps of cement before mixing.

Sand: Clean, fine to 6mm.

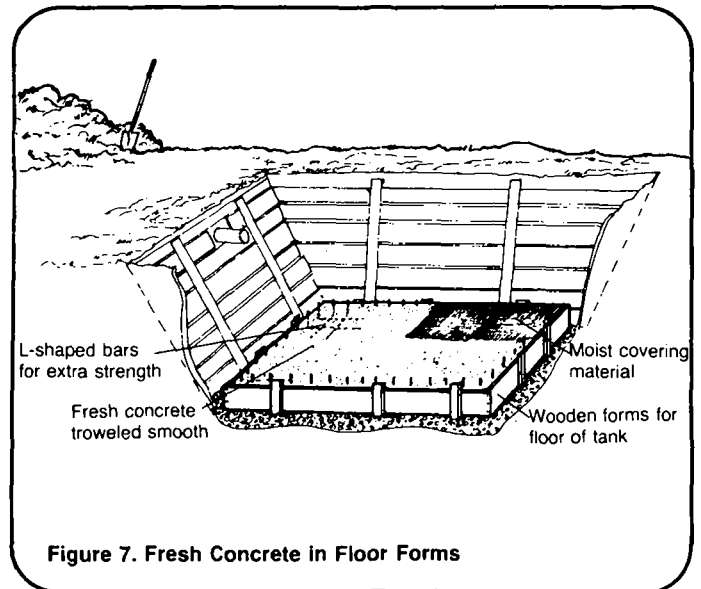
Gravel: Clean, 6-38mm.

Water: Clean and clear; drinking water, if possible.

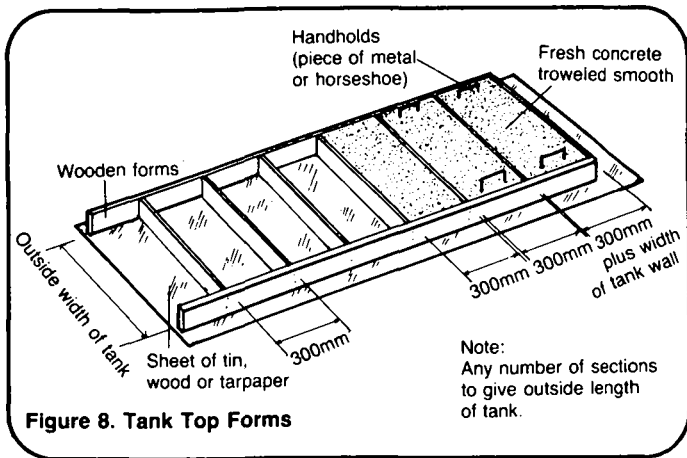
Mixing: Mix until sand and gravel are evenly coated with cement and water.

5. Pour concrete into forms.  
**IMPORTANT:** Concrete must completely fill the forms. Use a stout stick or steel rod to work concrete into the forms and between the reinforcing material. Leave no voids. Use a board or trowel to smooth concrete surface.

6. Cover freshly troweled concrete with straw, burlap bags, or other material to prevent concrete from drying out too rapidly and losing strength. Keep this cover material moist for seven days, then remove the cover material and the wooden forms. During this seven-day period, continue with steps 7 and 8.



7. Build forms for the septic tank top as shown in Figure 8. The top is made in sections, and each section except one is 300mm wide. The remaining section's width is 300mm plus the fraction of a foot necessary to account for the remainder of the total outside length of the tank.



11. Mix and pour concrete into the wall forms as described in steps 4 and 5.

12. Trowel tops of walls smooth and cover with moist material as described in step 6. Leave cover material and forms in place for seven days, then remove.

13. Mortar the joints between walls and floor to ensure that the tank will be watertight. A common mortar mix is one part cement to three parts sand and enough water to make a workable mix. See step 4 for specific amounts of cement, sand, water, and mixing. Mortar inlet and outlet pipe "T" fittings in place and mortar extensions to the fittings. The fittings and extensions will have to be held in place, possibly by wooden braces, until the mortar sets.

**EXAMPLE:** Suppose the total outside length of the tank is 1.676m. The top would consist of 5 sections, whose widths would be:

$$300\text{mm} + 300\text{mm} + 300\text{mm} + 300\text{mm} + 476\text{mm} = 1.676\text{m}$$

Each section's length is equal to the outside width of the septic tank.

8. Mix and pour concrete into the forms as described in steps 4 and 5.

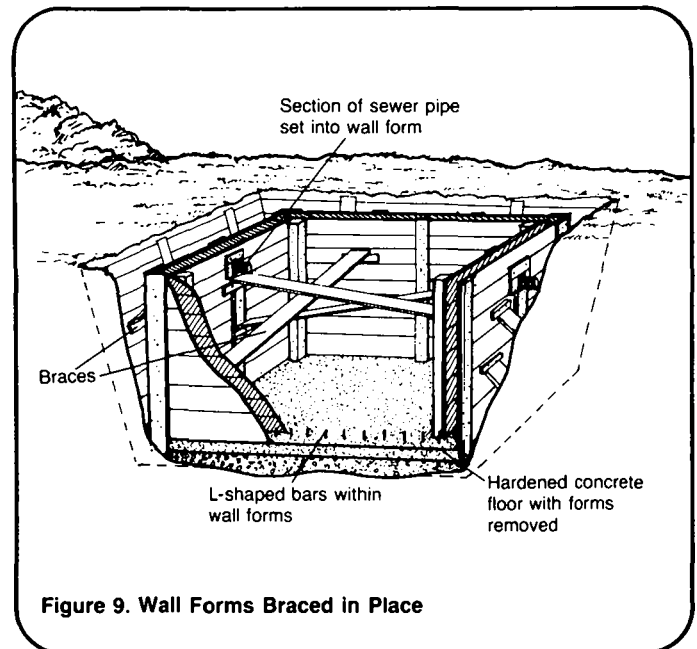
9. Set handholds into the concrete near both ends of each top section. Cover the wet concrete with straw, burlap bags, or other material as in step 6. The cover material and the forms must remain in place for seven days, then they should be removed.

10. Build wooden forms and position reinforcing material for the walls of the tank. Build these forms in place on the concrete floor of the tank. Brace the forms to prevent the risk of collapse when the concrete is poured as shown in Figure 9.

(NOTE: There are two ways of doing step 11. Decide which is most convenient before proceeding. Either (a) pour concrete into wall forms up to inlet and outlet elevations, allow to set, mortar the pipe sections in place in wall, and pour remainder of the concrete into wall forms; or (b) set one pipe section for the inlet and one for the outlet in place in the forms before pouring concrete (this may require some realignment of reinforcing material) then pour concrete for entire wall. In either case, it is most important that the inlet and outlet fittings are set at the correct elevations.)

14. Extend the sewer pipe to the inlet fitting and mortar in place.

15. Excavate at least 3m of trench from the outlet end of the septic tank toward the site of the subsurface absorption system (see "Constructing, Operating and Maintaining Subsurface Absorption Systems," SAN.2.C.1). The trench must slope downward away from the tank at a slope of about 1 in 100. Extend sewer pipe from the outlet of the septic tank into the trench. Mortar all pipe joints.



16. Add a little water to fill-dirt and carefully shovel into the space between the septic tank and the earth walls of the hole as shown in Figure 10. The water will help prevent later settling. Tamp dirt well. Be careful not to disturb or damage the sewer pipe or the inlet and outlet fittings.

17. Make a final check of the septic tank. Be certain all joints are sealed with mortar. Remove any debris, wood scraps, tools, and so on.

18. Remove cover material and wooden forms from the top sections of the tank. Carefully place sections on top of tank. Thoroughly waterproof with tar or other waterproofing material between each section and between the sections and the top of the tank walls.

If the top of the tank is level with or higher than the surface of the ground:

19. Determine whether tank should be covered with dirt.

a. Do not cover the tank if there is concern that it will not be inspected at least once a year (see "Operating and Maintaining Septic Tanks," SAN.2.0.3) because of being covered with dirt and possibly forgotten.

b. Cover the tank if there is concern that it will be opened or damaged by unauthorized persons.

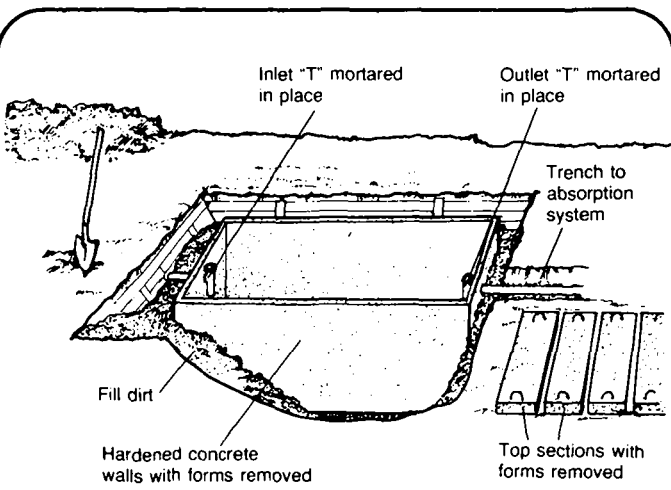


Figure 10. Wall Forms Removed, Hole Filled With Dirt

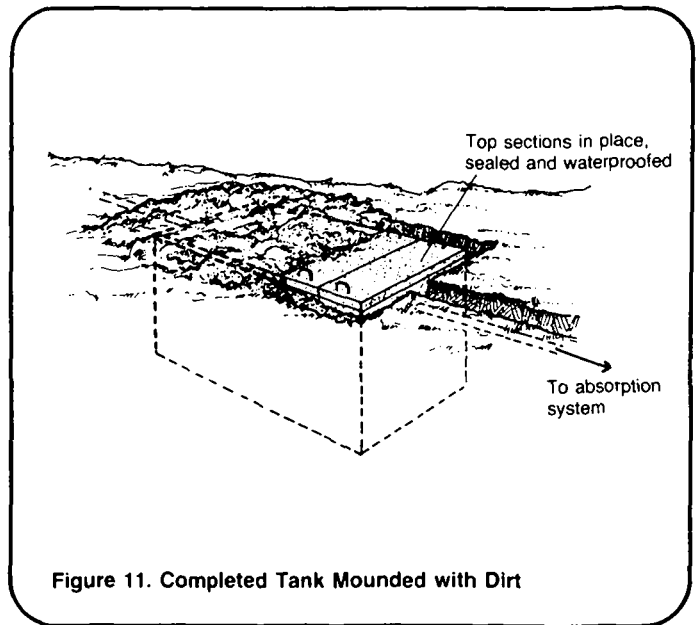


Figure 11. Completed Tank Mounded with Dirt

If the top of the tank is below the surface of the ground:

20. Cover the tank with a mound of dirt to prevent surface water from forming a pool on top of the tank as shown in Figure 11. Mark the tank site with sticks, stakes, piles of rocks, or other means to help find it at inspection time. The mound itself can be a means of identifying the tank site.

(NOTE: The septic tank is part of a system and is not ready to operate until it is connected by sewer pipe to a subsurface absorption system. See "Constructing, Operating and Maintaining Subsurface Absorption Systems," SAN.2.C.1.)

For a Laid-Up (Masonry) Tank:

1. Follow "General Construction Steps" 1 through 6.
2. Follow "Construction Steps for a Reinforced Concrete Tank" 1 through 9.
3. Remove cover material and wooden forms seven days after pouring concrete for the bottom of the tank. Using masonry stone, bricks, or concrete and cement mortar, begin to lay up the walls of the septic tank according to design specifications on the drawing provided by the project designer. Directions for mixing cement mortar are in step 4 of "Construction Steps for a Reinforced Concrete Tank."

When the walls attain the proper height:

4. Install the "T" fittings on the inlet and outlet pipes. Be certain the elevations of these fittings are correct. Mortar the joints around the fittings and mortar extensions to the fittings. These may have to be braced with wood until the mortar sets.

5. Continue laying up the walls to the top. If hollow blocks are being used, fill in the hollow spaces in the top layer.

6. Plaster the inside walls of the septic tank with a 25mm layer of cement mortar. Apply the layer in two applications of 12mm each. Let the first set for several days before applying the second.

7. Follow "Construction Steps for a Reinforced Concrete Tank" 14 through 20 after the walls have set for seven days.

For a Prefabricated Tank:

1. Follow "General Construction Steps" 1 through 6. Be certain that the bed of gravel is level. If it is not, the tank will not be level and the inlet and outlet fittings will not be at the correct elevations.

2. Check to be certain that the inlet and outlet ends of the tank are pointing in the correct direction, then carefully lower the tank into the hole.

3. Mortar inlet and outlet fittings in place and mortar extensions to fittings, if necessary, depending on the design of the prefabricated tank.

4. Partially fill the tank partly full with water. This prevents the tank from floating out of the hole before it is in operation, particularly in areas of high groundwater levels.

5. Follow "Construction Steps for a Reinforced Concrete Tank" 14 through 16.

6. Use tar or other waterproofing material to seal edges of manhole cover(s).

7. Follow "Construction Steps for a Reinforced Concrete Tank" 19 through 20.

(NOTE: The septic tank is part of a system and is not ready to operate until it is connected by sewer pipe to a subsurface absorption system.)

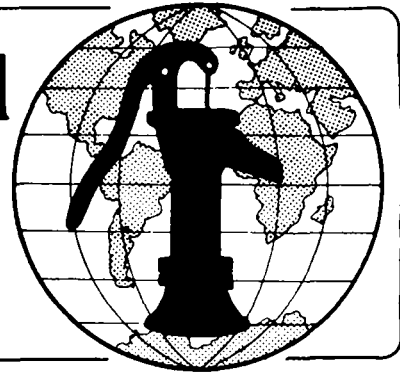
## Notes

## Notes

**Technical Notes** are part of a set of "Water for the World" materials produced under contract to the U.S. Agency for International Development by National Demonstration Water Project, Institute for Rural Water, and National Environmental Health Association. Artwork was done by Redwing Art Service. Technical Notes are intended to provide assistance to a broad range of people with field responsibility for village water supply and sanitation projects in the developing nations. For more detail on the purpose, organization and suggestions for use of Technical Notes, see the introductory Note in the series, titled "Using 'Water for the World' Technical Notes." Other parts of the "Water for the World" series include a comprehensive Program Manual and several Policy Perspectives. Further information on these materials may be obtained from the Development Information Center, Agency for International Development, Washington, D.C., 20523, U.S.A.



# Water for the World



## Constructing Sewer Systems Technical Note No. SAN. 2.C.4

A sewer system is a network of underground pipes that carries sewage by gravity flow from a number of dwellings. The sewage may be a direct flow of wastewater or the effluent after settling in septic tanks or aqua privies. It flows to a stabilization pond or other central treatment facility. Constructing a sewer system requires the services of an experienced construction foreman and surveyor. Construction involves assembling labor, materials and tools; staking pipeline and grade; excavating trenches; and laying pipe.

This technical note describes the elements involved in constructing a sewer system. It does not attempt to explain everything needed to build a sewer system.

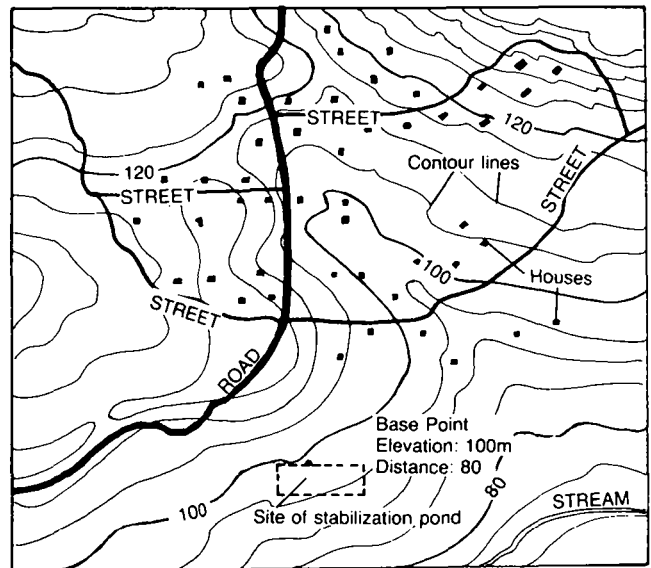


Figure 1. Contour Map

### Useful Definitions

**BASE POINT** - A point of reference from which all other points are measured.

**EFFLUENT** - Settled sewage.

**GRAVITY FLOW** - Flow of water from high ground to low by natural forces.

**INVERT** - The inside bottom of a pipe; that is, the pipe's lowest inside surface.

### Materials Needed

Before construction can begin, the project designer must provide maps and drawings similar to Figures 1-3, and a detailed materials list similar to Table 1. Also needed are all labor, materials, equipment, and tools described in the materials list.

Table 1. Sample Materials List

Item	Description	Quantity	Estimated Cost
Labor	Construction foreman, experienced with large-scale projects	1	_____
	Surveyor	1	_____
	Worker, skilled with carpentry	1	_____
	Worker, skilled with concrete mortar	1	_____
	Workers, unskilled	12	_____
Supplies	Sewer pipe; 200mm diameter	_____	_____
	Sewer pipe; 100mm diameter	_____	_____
	"T" fittings; 100-200mm	_____	_____
	Other fittings	_____	_____
	Gravel	_____	_____
	Mortar mix	_____	_____
	Wooden stakes	_____	_____
	Wood for shoring	_____	_____
Nails (double-head and standard)	_____	_____	
Equipment and Tools	Surveyor's transit	1	_____
	Surveyor's level	1	_____
	Grade rods	2	_____
	Pipe sling for lowering pipe into trench	2	_____
	Heavy chains or ropes for lowering pipes	2	_____
	Shovels	12	_____
	Picks	4	_____
	Mattocks	2	_____
	Pry bars	2	_____
	Hammers	4	_____
	Saws	2	_____
	Sledgehammer	1	_____
	Trowels	2	_____
	Hoes	2	_____
	Wheelbarrows	2	_____
Barricades	6	_____	

Total Estimated Cost = \_\_\_\_\_

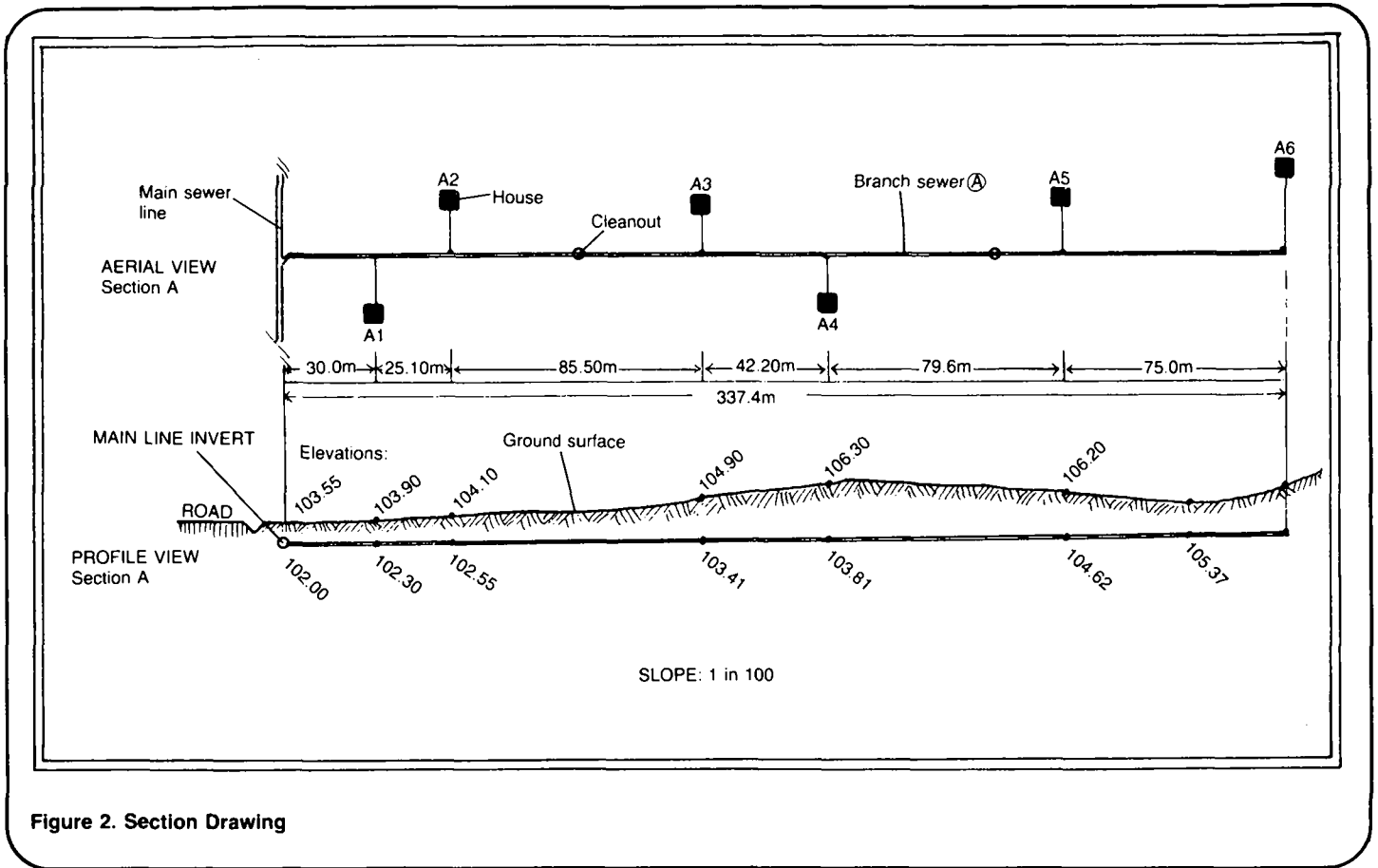


Figure 2. Section Drawing

### Steps in Construction

Construction of a sewer system begins at the lowest point. This is the point at which the system empties into the stabilization pond. Sometimes work on the pond begins first, depending on local conditions and the judgment of the construction foreman. See "Constructing Stabilization Ponds," SAN.2.C.5.

To avoid leaving survey stakes exposed and trenches open for a number of days, a sewer system is generally constructed in sections. A section of sewer line is staked out, the trench is dug, pipe is laid, and the trench is backfilled. Then the adjoining section is staked, the trench is dug, and so on.

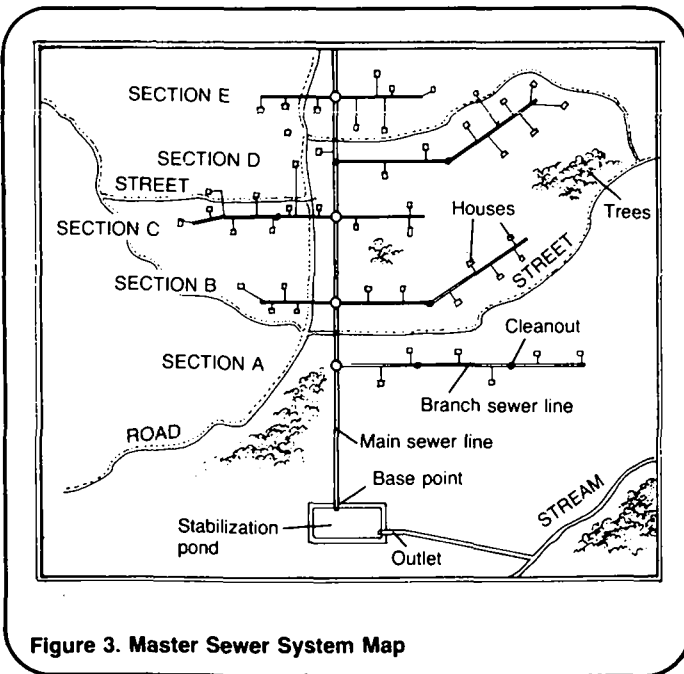


Figure 3. Master Sewer System Map

Depending on local conditions, availability of materials, and skills of workers, some construction steps will require a few hours, while others may take a day or longer. One way of organizing the work is to prepare a work schedule similar to Table 2. This gives the construction foreman an idea of when specific workers, materials, and tools are needed, and allows him to judge if the work is proceeding on schedule.

1. Assemble workers, materials, and tools. Because of the size of the project, workers are often assembled in small crews with crew leaders and each crew is assigned a specific task: one crew excavates trenches, one lays pipe, and so on. Or, individuals may be assigned specific tasks throughout the project.

Materials and tools must often be available for several weeks or more, so they are generally kept in a fenced yard with a locked gate or in some way are protected against theft and damage.

2. Stake pipe lines and grade. Begin at the outlet end of the sewer system (pond inlet) and work "upstream." Stake out only that portion of the pipeline that can be constructed in a few days. See Figure 4.

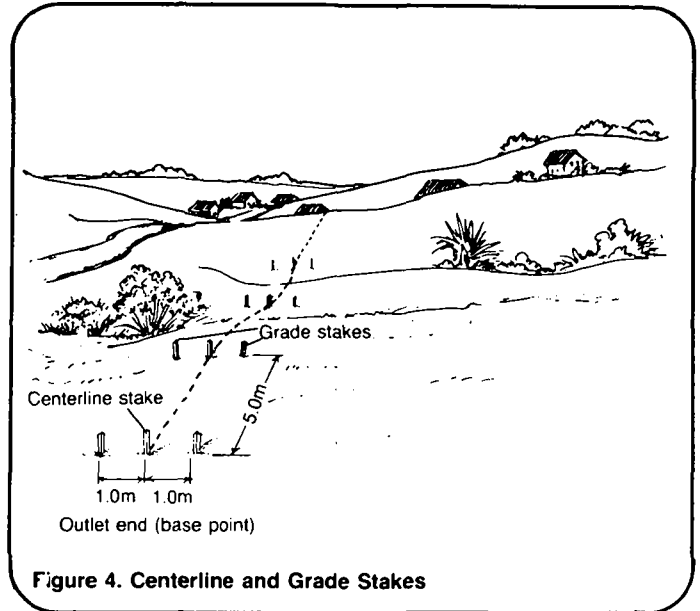


Table 2. Sample Work Schedule

Time Estimate	Day	Task	Personnel	Materials/Tools
3 hours	1	Stake 50m of pipeline (center and grade stakes)	Foreman (always present), surveyor; 2 laborers	Transit, level, stakes, hammer, steel measuring tape, grade rod
2 days	1-3	Excavate trench	Crew chief, 4 laborers	Picks, shovels
4 hours	3	Install sheeting and braces	Crew chief, 4 laborers	Boards, beams, hammers, saw, nails
2 hours	4	Check trench bottom grade	Crew chief, 4 laborers	String line, grade rod
8 hours	4	Lay pipe; seal joints	Crew chief, 4 laborers	Sections of 100mm sewer pipe, rubber gaskets, cement mortar
1 hour	5	Test for watertightness	Crew chief, 4 laborers	Water
3 hours	5	Remove sheeting/braces	Crew chief, 4 laborers	Hammers, ropes
4 hours	5	Backfill trench	Crew chief, 4 laborers	Shovels
	6	Stake next 50m of pipeline		

First, stake the centerline of the pipe, setting a stake every 5m. Set a pair of grade stakes for each centerline stake. The grade stakes in each pair should be at the same elevation, should be equidistant from the center stake, and should be at right angles to the centerline of the pipe. The grade stakes should be set far enough from the centerline stake so as not to be disturbed during excavation of the trench.

3. Excavate the trench. Begin excavating the trench, making it as narrow as possible. A 600mm wide trench is sufficient for a 100mm pipe. Check the line and elevation of the trench bottom with a grade rod and a string stretched between a pair of grade stakes as shown in Figure 5. If the bottom of the trench is rocky or soft, excavate about 100mm below the invert grade and fill with gravel.

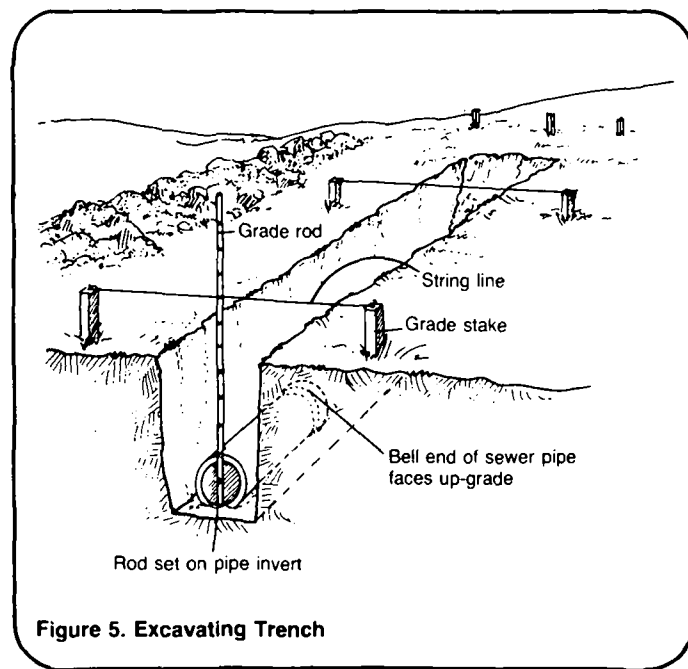


Figure 5. Excavating Trench

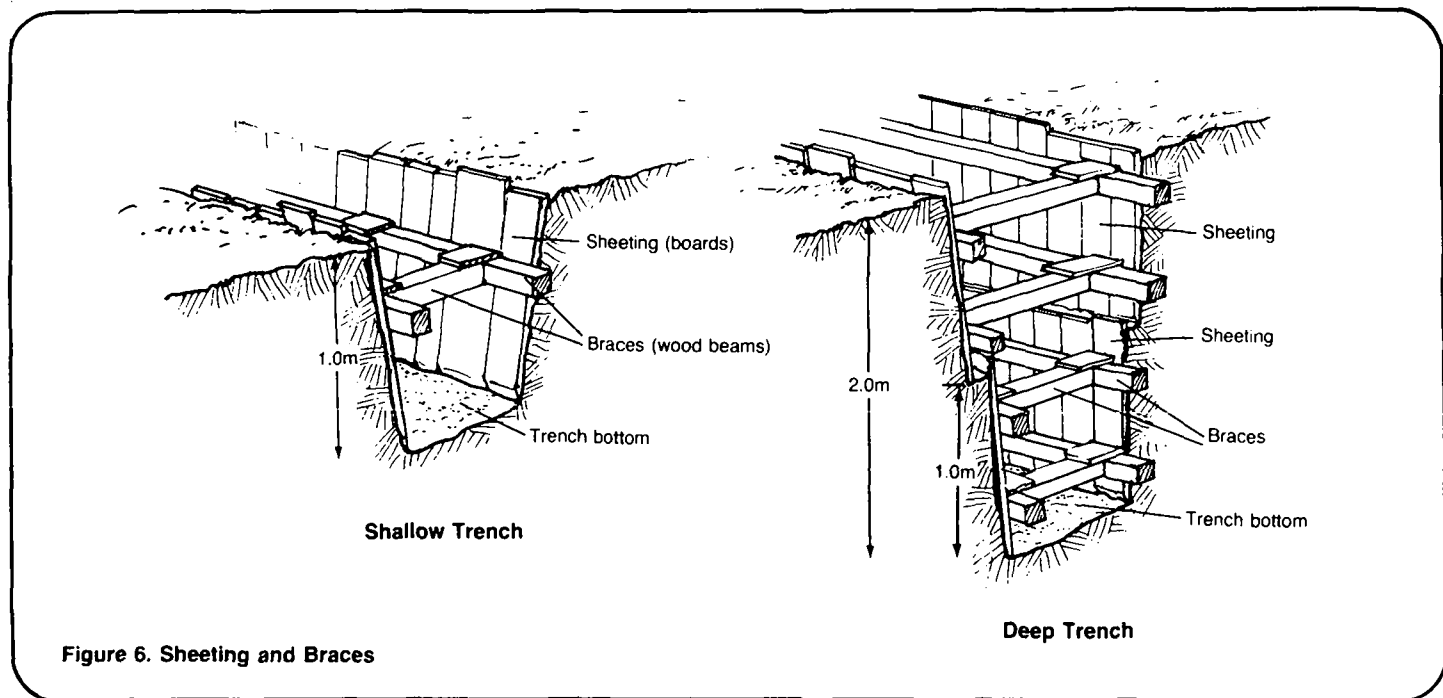


Figure 6. Sheeting and Braces

**Caution!**

Support the sides of trenches deeper than 1.0m with sheeting and braces. Install a section of sheeting and braces for each addition 1.0m of trench depth. See Figure 6. The collapse of a trench wall not only slows the progress of work, but has injured and killed workers buried in the fallen earth and rock.

4. Lay pipe. Position the first section of pipe with the bell-end upstream. Make a small excavation at the bell-end so that the entire length of pipe is supported by soil. See Figure 7. Position the second section of pipe, join it to the first section, and seal the joint with a rubber gasket and cement mortar, or with jute and tar.

Joints must be watertight. After a number of pipe sections have been installed and the joints have set up, test the system for leaks. Either plug the outlet, fill the pipe with water, and observe any water loss in the pipe, or pour a measured amount of water in one end and measure the amount that runs out the outlet end. Repair any leaks and retest the system before backfilling the trench.

At the end of each work day, plug the ends of the sewer pipe to prevent entry by rodents or snakes. See Figure 8.

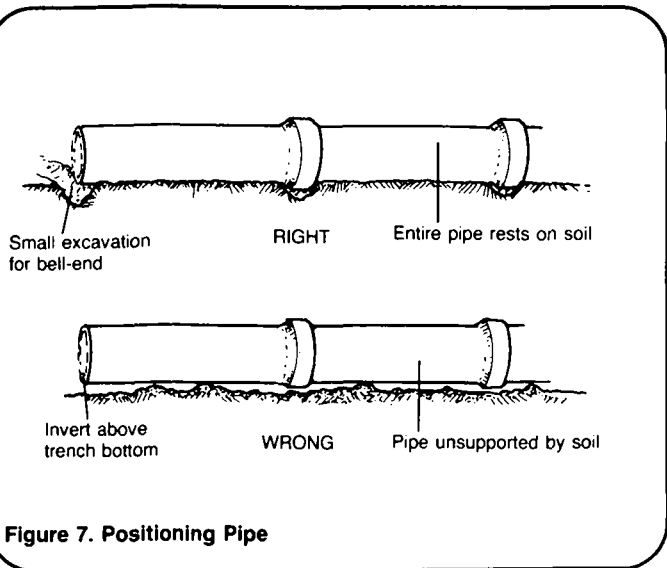


Figure 7. Positioning Pipe

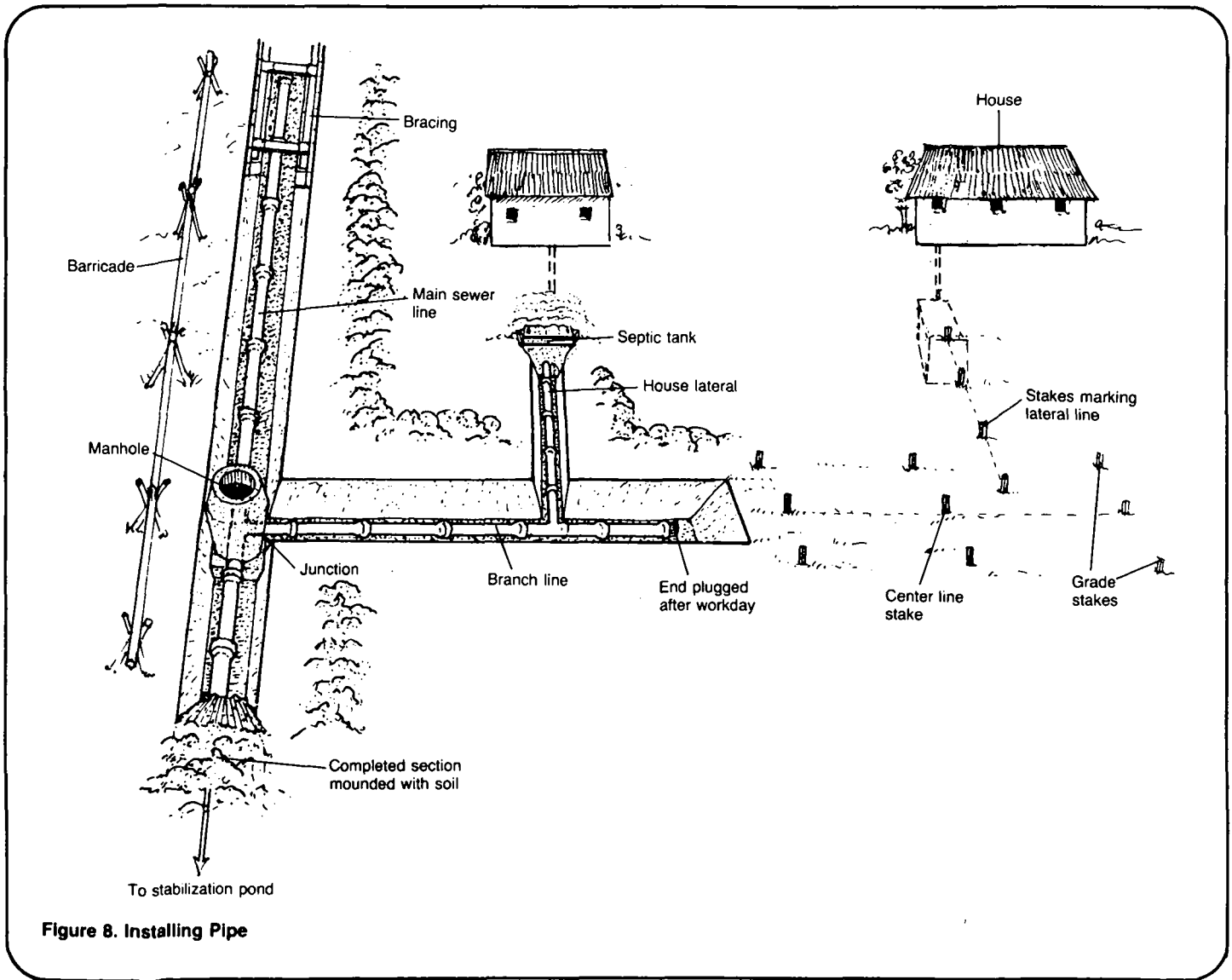
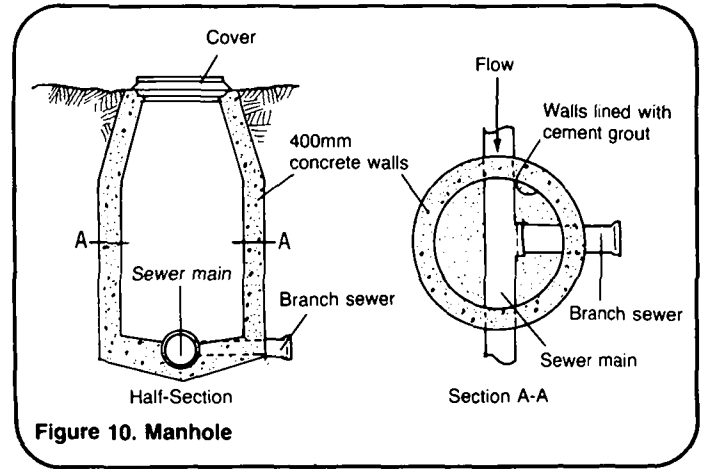
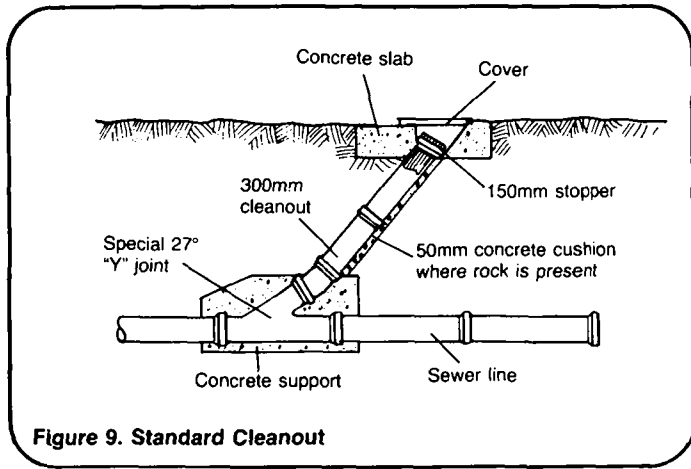


Figure 8. Installing Pipe

Install inspection ports, manholes, or clean-outs at or near the intersections of branch lines and the main sewer line. A clean-out is generally the same diameter as the sewer pipe. See Figure 9. It extends on an angle to the surface of the ground, and is plugged at the upper end, often with a threaded plug for easy removal. See Figure 10 for a manhole on a main.

Remove sheeting and braces, carefully cover the pipe with soil, and fill the trench. Carefully, but firmly, tamp the soil as the trench is filled.

The sewer pipe from a septic tank to the branch line may be laid at this time, but the septic tank must not be put into operation until the stabilization pond is constructed.



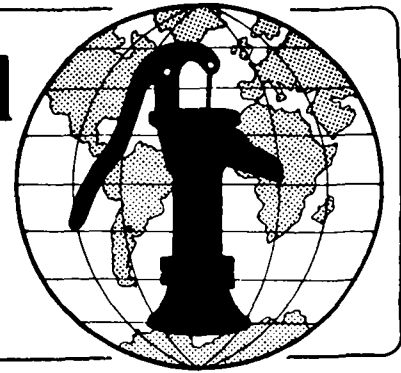
## Notes

## Notes

**Technical Notes** are part of a set of "Water for the World" materials produced under contract to the U.S. Agency for International Development by National Demonstration Water Project, Institute for Rural Water, and National Environmental Health Association. Artwork was done by Redwing Art Service. Technical Notes are intended to provide assistance to a broad range of people with field responsibility for village water supply and sanitation projects in the developing nations. For more detail on the purpose, organization and suggestions for use of Technical Notes, see the introductory Note in the series, titled "Using 'Water for the World' Technical Notes." Other parts of the "Water for the World" series include a comprehensive Program Manual and several Policy Perspectives. Further information on these materials may be obtained from the Development Information Center, Agency for International Development, Washington, D.C., 20523, U.S.A.



# Water for the World



## Constructing Stabilization Ponds Technical Note No. SAN. 2.C.5

A stabilization pond is a large shallow excavation that receives sewage from a sewer system, detains the sewage so that biological processes can destroy most of the disease-causing organisms, and discharges the effluent as treated sewage. Sometimes two or more ponds are constructed and connected by pipes. Constructing stabilization ponds requires the services of an experienced construction supervisor and surveyor. Construction involves assembling labor, materials, and tools; preparing the site; staking the pond, embankment, and pipe locations; excavating the pond; building embankments; laying pipes; and finishing embankments.

This technical note describes how to construct a stabilization pond. Read the entire technical note before beginning construction.

### Useful Definitions

**EFFLUENT** - Settled sewage.

**TREATED SEWAGE** - The liquid that flows out of a stabilization pond or series of ponds; treated sewage is safer than settled sewage and may be used to irrigate crops not intended for human consumption.

### Materials Needed

Before construction can begin, the project designer must provide:

1. Location map, or master sewer map, similar to Figure 1;
2. Design drawing of the pond, similar to Figure 2;

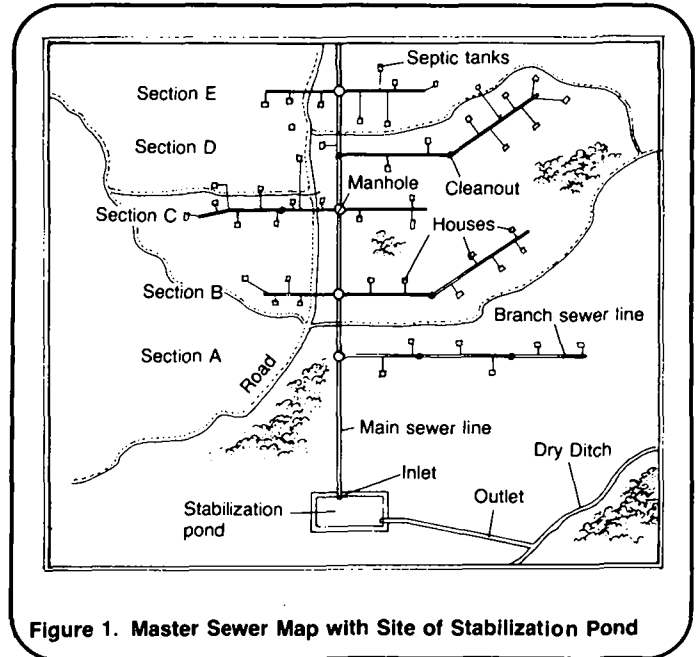


Figure 1. Master Sewer Map with Site of Stabilization Pond

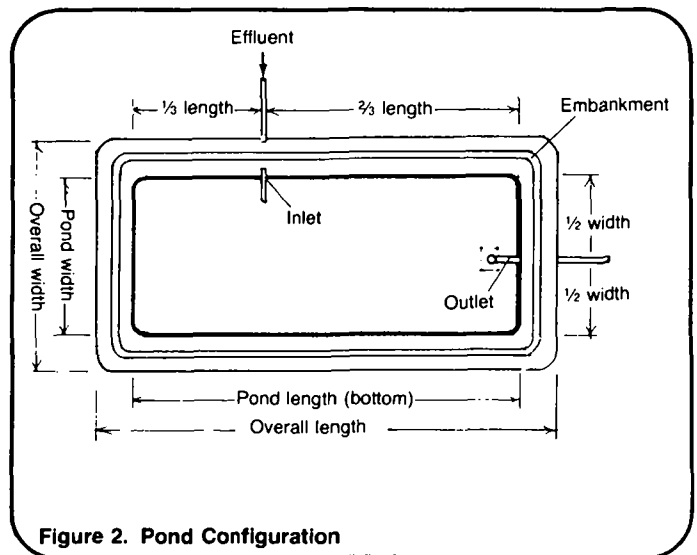
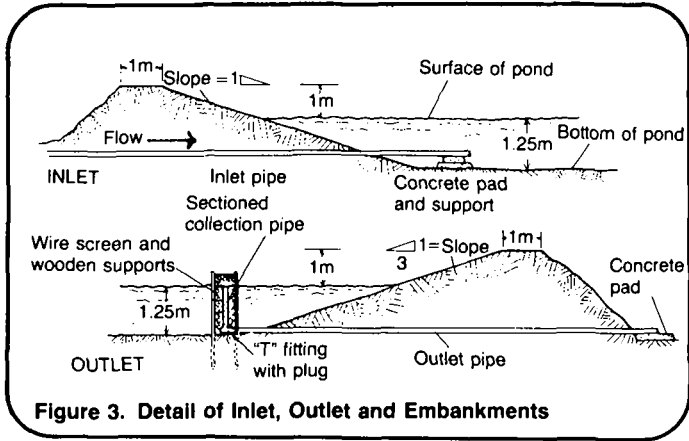


Figure 2. Pond Configuration

3. Design drawing of the inlet, outlet, and embankment, similar to Figure 3;



4. Materials list similar to Table 1.

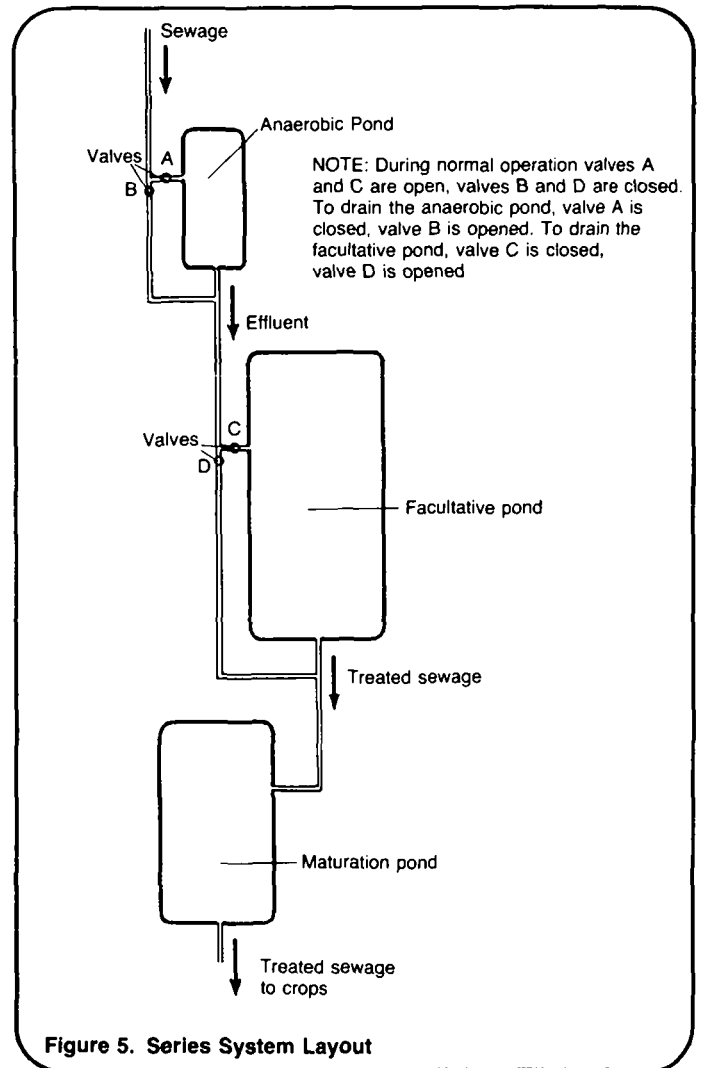
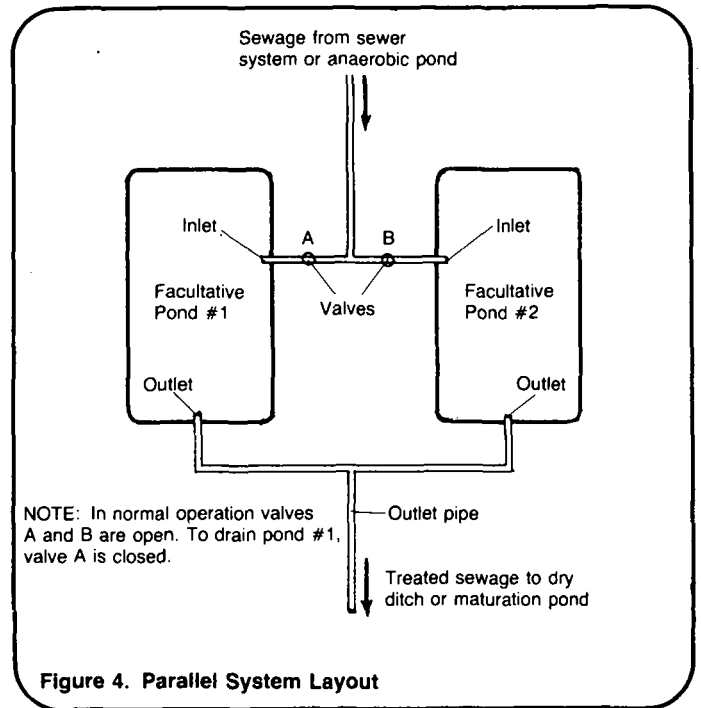
**Table 1. Sample Materials List for a Stabilization Pond**

Item	Description	Quantity	Estimated Cost
Labor	Construction foreman (experienced)	_____	_____
	Laborer (skilled with concrete)	_____	_____
	Laborer (skilled with heavy equipment)	_____	_____
	Laborers (unskilled)	_____	_____
Supplies	Sewer pipe (100mm diameter)	_____ m	_____
	"T" fittings (100mm diameter)	_____	_____
	Valve	_____	_____
	Wire mesh (for outlet)	_____ m <sup>2</sup>	_____
	Cement	_____ m <sup>3</sup>	_____
	Sand (for concrete)	_____ m <sup>3</sup>	_____
	Gravel	_____ m <sup>3</sup>	_____
	Water	_____ liters	_____
	Gravel (for embankment)	_____ m <sup>3</sup>	_____
	Grass seed (for embankment)	_____	_____
	Wood (for forms)	_____	_____
	Other	_____	_____
Tools and Equipment	Surveying equipment (transit, level, etc.)	_____	_____
	Tractor with front-end loader	_____	_____
	Shovels	_____	_____
	Rakes	_____	_____
	Trowel	_____	_____
	Mixing containers	_____	_____
	Hammer	_____	_____
	Saw	_____	_____
	Nails	_____	_____
	Other	_____	_____
	Total Estimated Cost = _____		

If more than one pond is being constructed, the project designer must also provide:

5. Design drawing of the pond system layout, similar to Figure 4 or 5;

6. Design drawings of all interpond piping, similar to Figure 6.



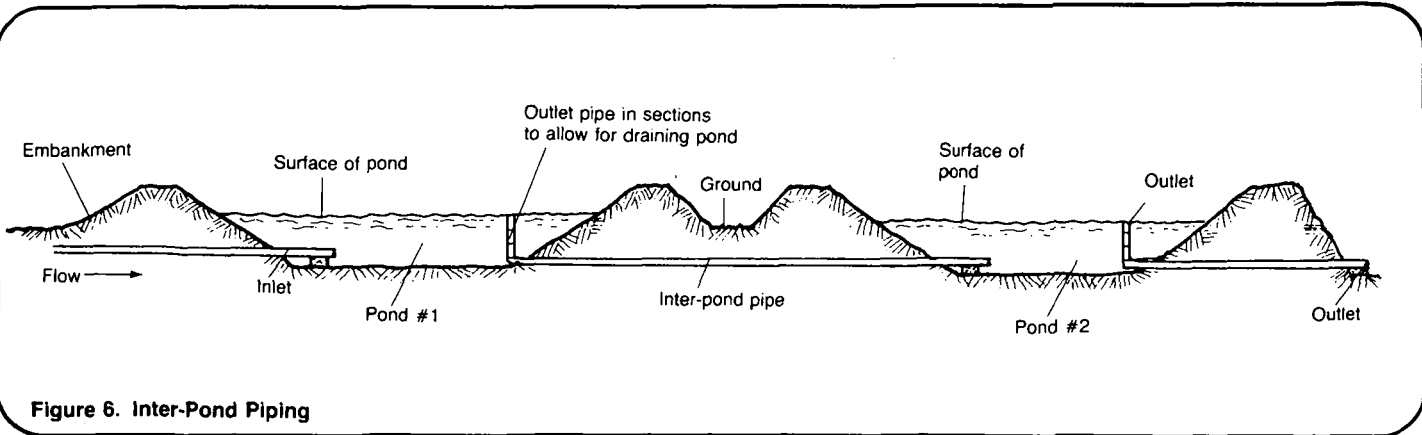


Figure 6. Inter-Pond Piping

7. Materials list attachment similar to Table 2.

You will also need:

8. All labor, materials, and tools described in the materials list and materials list attachment.

### Construction Steps

Depending on local conditions, availability of materials, skills of workers, and so on, some construction steps will require only a few hours, while others may take a day or more. Read the construction steps and make a rough estimate of the time required for each step based on local conditions. You will then have an idea of when during the construction process specific workers, materials, and tools must be available. Draw up a work schedule similar to Table 3 showing construction steps.

**Table 2. Sample Materials List Attachment for Interpond Piping**

Description	Quantity	Estimated Cost
Sewer pipe (100mm diameter)	_____m	_____
Sewer pipe (200mm diameter)	_____m	_____
Valves (100mm diameter)	_____	_____
Valves (200mm diameter)	_____	_____

Total Estimated Cost = \_\_\_\_\_

**Table 3. Sample Work Schedule for Constructing a Stabilization Pond**

Time Estimate	Day	Task	Personnel	Materials/Tools
2 hours	1	Mark site	Foreman (always present), 2 workers	Maps, drawings, measuring tape
1½ days	1-2	Clean site of trees, brush, and debris	6 workers	Axes, machetes, cart
1 day	3	Scrape top soil and pile for finishing embankment	6 workers; 1 loader operator	Front-end loader, shovels
1 day	4	Stake site of pond embankment, pipes	1 surveyor, 3 workers	Transit, level, level rod, steel measuring tape, stakes
7 days	5-11	Excavate pond and build embankments	1 loader operator, 12 workers	Front-end loader, shovels, picks, cart
4 hours	12	Dig pipe trenches	6 workers	Shovels, picks
2 hours	12	Build pipe base and slab	4 workers	Shovels, large flat stones
6 hours	13	Lay pipe	6 workers, 1 worker skilled with mortar	200mm diameter sewer pipe, mortar, "C" fitting
3 hours	13	Build vertical outlet and screen	6 workers, 1 worker skilled with mortar	Sleeved pipe sections, posts, reosote, wire screen
1 day	14	Fill in gaps in embankment	6 workers, 1 operator	Front-end loader, shovels
4 days	15-18	Finish embankment	1 loader operator, 12 workers	Loader, shovels, rocks, topsoil, grass seed

## Preparing the Site

1. Locate the site and temporarily mark it on the ground.
2. Assemble all labor, materials, and tools needed to begin construction.
3. Clear the pond and embankment site of all trees, bushes, stumps, brushwood, large rocks, and any other material not suitable for building the embankment. Haul this material to a landfill or other disposal site.
4. Remove any trees upwind from the site for a distance of 100-200m. This will create an unobstructed windpath, which will improve the efficiency of the pond after it is put into operation.
5. Remove topsoil or sod from the site and place it to one side. This will be used later to finish the embankment.

## Staking Pond Site and Pipe Locations

1. Set reference stakes 5-10m apart indicating the boundaries of the bottom of the pond. Find the elevation of each stake using a surveyor's level and rod from the base point used in constructing the sewer. See "Constructing Sewer Systems," SAN.2.C.4.
2. Measuring the distance and elevation from the reference stakes, set slope stakes indicating the points at which to begin building the embankment and excavating the pond. See Figure 7.
3. Set stakes to indicate pipe locations. This will eliminate re-excavating portions of the embankment.

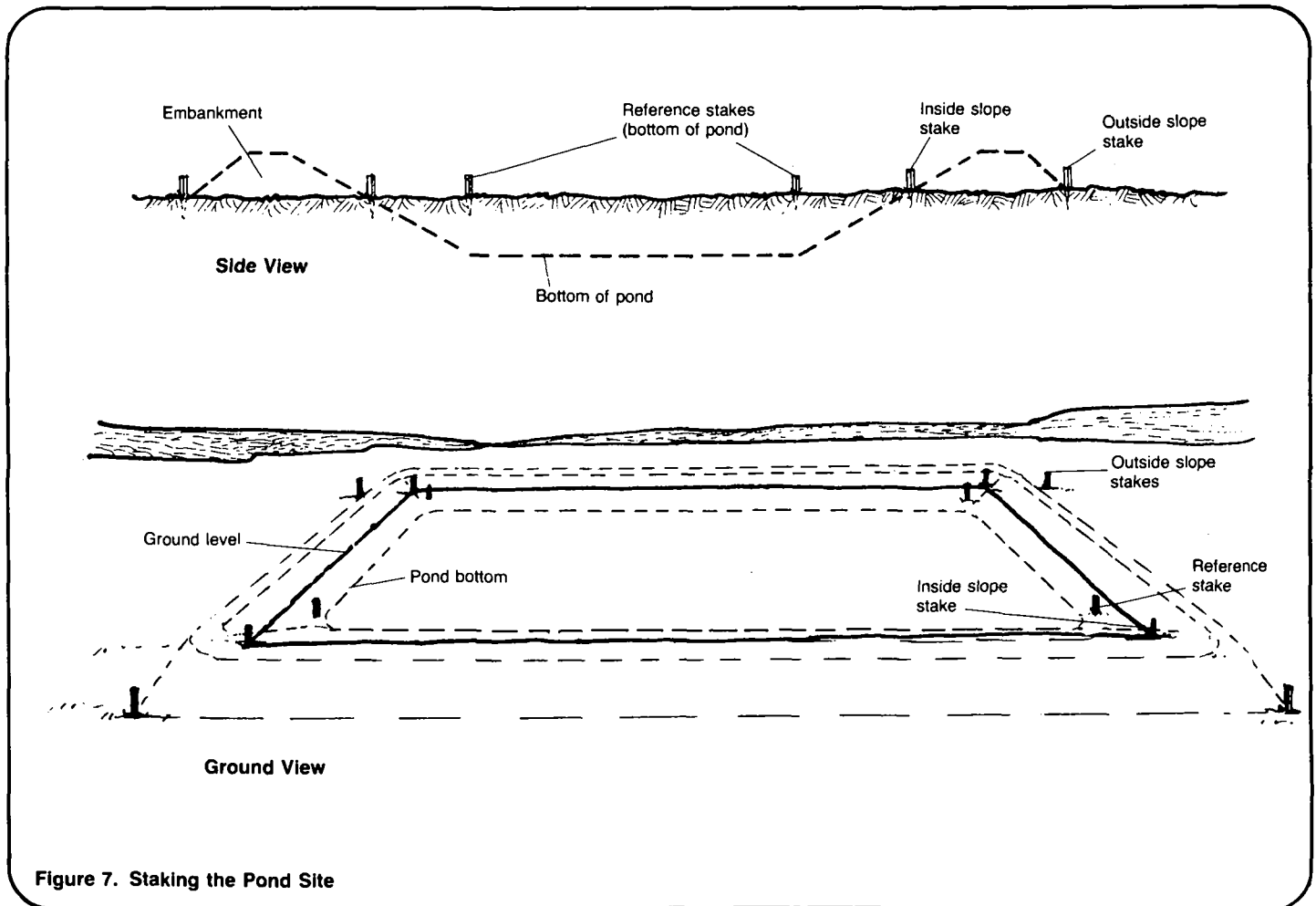


Figure 7. Staking the Pond Site

## Excavating the Pond

1. Begin excavating at the inside slope stakes. Dig at the slope specified by the project designer until the bottom elevation is reached. Check this elevation with a surveyor's level and rod. See Figure 8.

2. Continue excavating along the bottom elevation of the pond. Use excavated soil to build up the embankments (see "Building Embankments").

3. Make the bottom of the pond as level and as uniformly compacted as possible. If there are soft spots or tree roots, dig them out, fill with moist soil, and compact.

4. Make the corners of the pond rounded.

5. Leave some excavated soil on the pond bottom if small dikes are to be built for the start of pond operation. See "Operating and Maintaining Stabilization Ponds," SAN.2.0.5.

## Building Embankments

1. Begin building embankments as the pond is excavated. Embankments must be well tamped, with sides sloped according to design specifications.

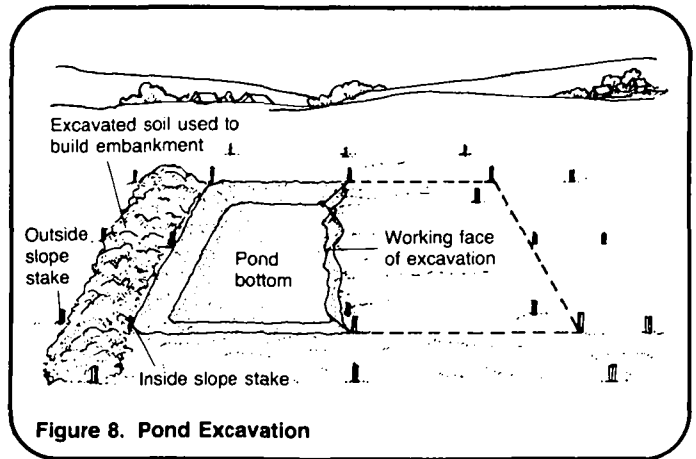


Figure 8. Pond Excavation

2. Leave gaps in the embankment at pipe locations as shown in Figure 9. It may also be convenient to leave one or more wide gaps for removal of excavated soil.

3. The top of the embankment must be level, well-tamped, and at least 1.0m wide. The horizontal distance from the top of the embankment to the bottom of the pond must equal the design depth of the pond plus 1.0m.

## Laying Pipes

1. Excavate trenches for pipes at the design depth and locations. The bottoms of the trenches should be well-tamped.

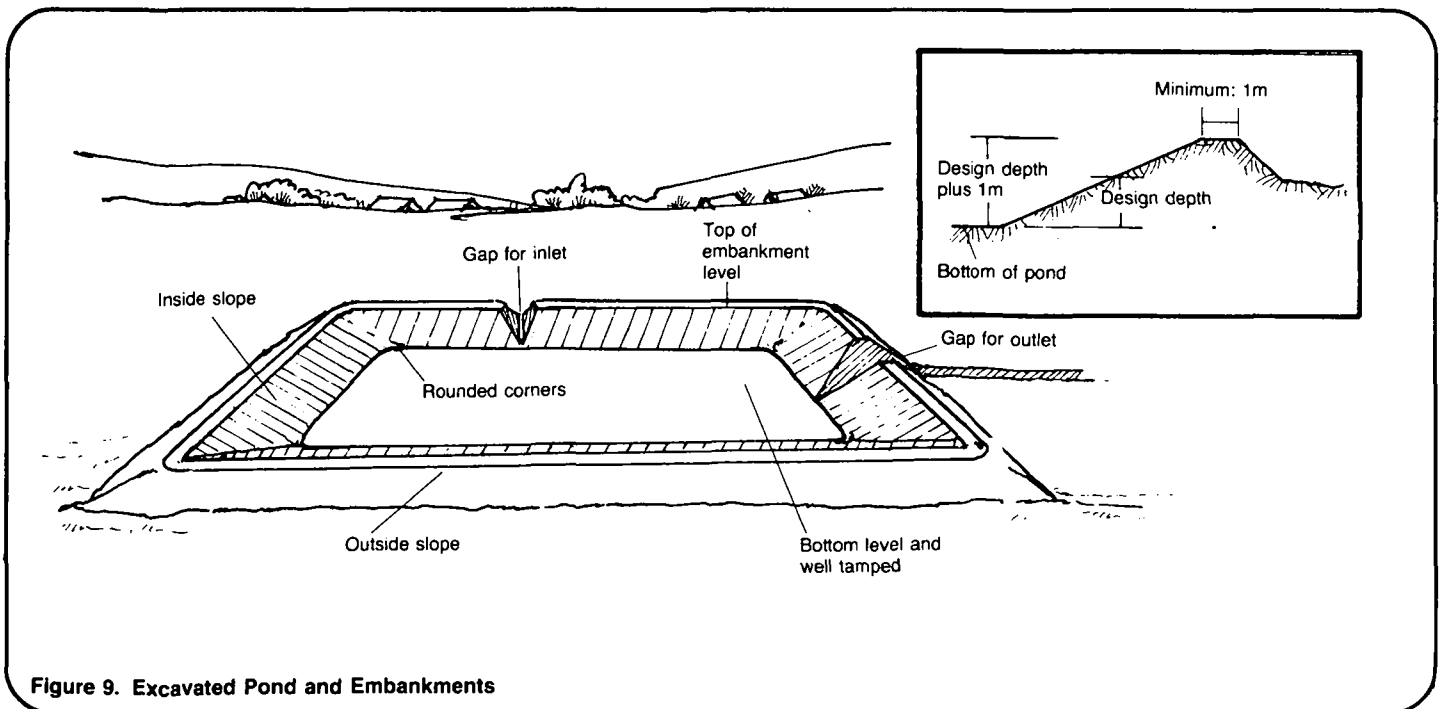


Figure 9. Excavated Pond and Embankments

2. Build bases about 0.5m high for the inlet pipes from concrete or stone. The purpose of the bases is to raise the inlet pipe above the bottom of the pond. See Figure 3.

3. Build slabs for the outlet pipes from concrete or stone. The purpose of the slab is to support the outlet pipe and to prevent erosion due to the discharge of treated sewage. Build support slabs under all valve locations.

4. Lay sewer pipe and mortar together sections. Install valves.

5. Build the vertical outlet from sleeved sections of pipe. The height of the vertical outlet determines the depth of the pond. It must be equal to the design depth calculated by the project designer. The sleeved sections will allow the pond to be drained when necessary. See Figure 3.

6. Build a protective screen around the vertical outlet with creosote-treated wood posts and rust-proof wire screen. The screen should extend at least 0.3m above and 0.3m below the vertical outlet. It will prevent floating debris from entering the outlet pipe after the pond is put into operation.

7. Carefully fill in pipe trenches with moist soil and tamp.

### Finishing Embankments

1. Fill in any gaps in the embankment that were used for laying pipe or removing excavated soil. Thoroughly tamp the top and slopes and make them uniform with the existing embankment. See Figure 10.

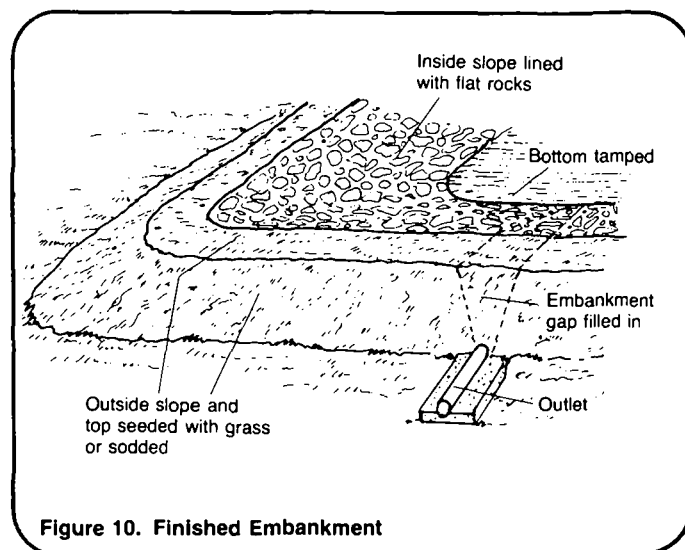


Figure 10. Finished Embankment

2. Line the entire inner face of the embankment slope with rocks and flat stones. This will prevent erosion due to wave action during pond operation. Rocks and stones should be smoothly graded to conform to the design slope of the embankment. Avoid using gravel and pebbles because this material tends to move downslope.

3. If topsoil or sod was initially removed from the site, use it now to cover the outside slope and top of the embankment. If no sod is available, plant grass seed. This will help prevent erosion of the embankment from wind and rain. See Figure 10.

4. Excess soil excavated from the pond can be used to build small dams to divert surface water away from the pond. If not, it should be graded level or hauled away from the pond site.

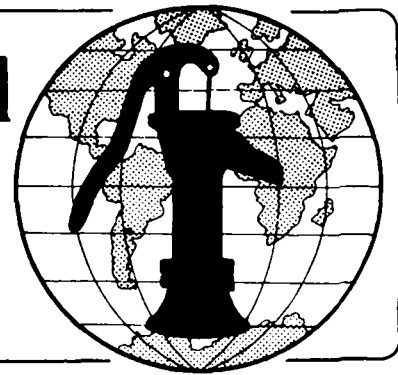
## Notes

## Notes

**Technical Notes** are part of a set of "Water for the World" materials produced under contract to the U.S. Agency for International Development by National Demonstration Water Project, Institute for Rural Water, and National Environmental Health Association. Artwork was done by Redwing Art Service. Technical Notes are intended to provide assistance to a broad range of people with field responsibility for village water supply and sanitation projects in the developing nations. For more detail on the purpose, organization and suggestions for use of Technical Notes, see the introductory Note in the series, titled "Using 'Water for the World' Technical Notes." Other parts of the "Water for the World" series include a comprehensive Program Manual and several Policy Perspectives. Further information on these materials may be obtained from the Development Information Center, Agency for International Development, Washington, D.C., 20523, U.S.A.



# Water for the World



## Constructing Mechanically Aerated Lagoons Technical Note No. SAN. 2.C.7

A mechanically aerated lagoon is similar to a stabilization pond except that it is equipped with one or more electrically powered aerators that treat effluent by mixing it with air. Constructing a mechanically aerated lagoon requires the services of an engineer or construction foreman experienced with these systems. Construction involves assembling materials, tools, and labor; preparing the site; staking the lagoon, embankment, and pipe locations; excavating the lagoon; building embankments; laying pipes; lining the lagoon; finishing embankments; and installing aerators.

This technical note describes how to construct a mechanically aerated lagoon. Most of the steps are identical to those described in "Constructing Stabilization Ponds," SAN.2.C.5. Read the entire technical note before beginning construction.

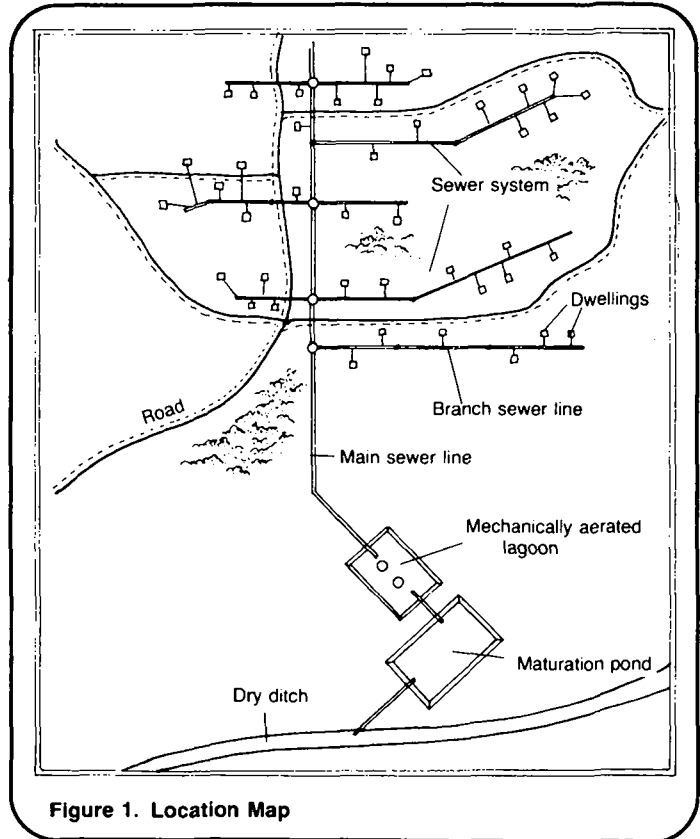


Figure 1. Location Map

### Useful Definition

**EFFLUENT** - Settled sewage.

### Materials Needed

Before construction can begin, the project designer must provide:

- 1) Location map, or master sewer map, similar to Figure 1.
- 2) Design drawings, similar to Figure 2 and 3.
- 3) Materials list, similar to Table 1 the sample.
- 4) Aerator Manufacturer's instruction and specification sheet.

You will also need the technical note "Constructing Stabilization Ponds," SAN.2.C.5.

Table 1. Sample Materials List for Aerated Lagoon

Item	Description	Quantity	Estimated Cost
Labor	Engineer experienced with aerated lagoons	1	---
	Electrician	1	---
	Worker skilled with concrete mortar	1	---
	Unskilled workers	6	---
Supplies	Backhoe operator	1	---
	Aerators, (including spare parts, electric cables, and nooring lines, etc.)	---	---
	Sewer pipe, 100mm diameter	---	---
	Valves, 100mm diameter	---	---
	Flat stones	---	---
	Mortar mix	---	---
Tools	Grass seed	---	---
	Backhoe	---	---
	Shovels	---	---
	Electrician's tools	---	---
	Mixing containers Trowels	---	---

Total Estimated Cost : ---

### Construction Steps

Depending on local conditions, availability of materials, skills of workers, and so on, some construction

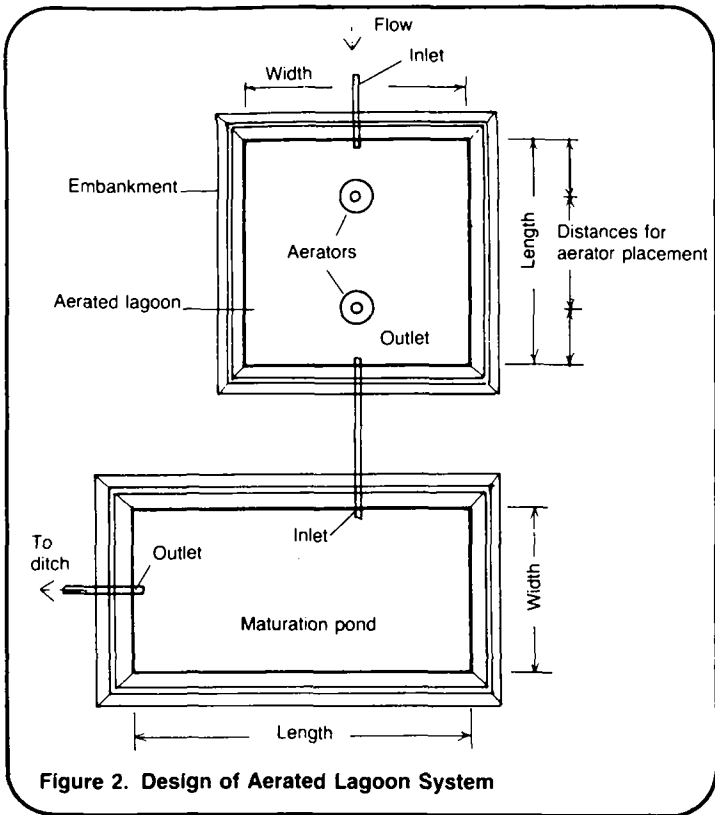


Figure 2. Design of Aerated Lagoon System

steps will take only a few hours, while others may require a day or more. Read the construction steps and make a rough estimate of the time required for each step based on local conditions. You

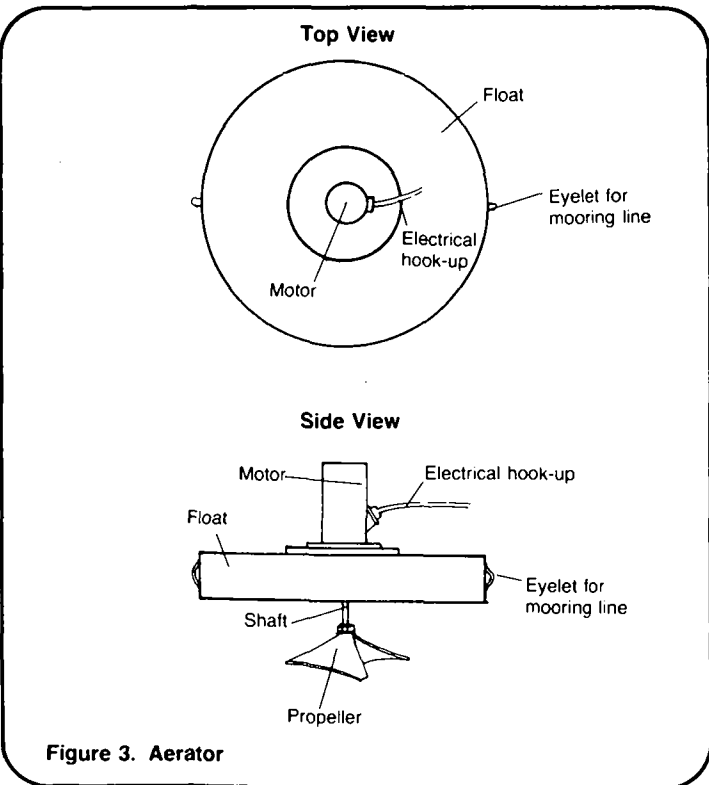


Figure 3. Aerator

will then have an idea of when specific workmen, materials, and tools must be available during the construction process. Draw up a work schedule to Table 2, showing construction steps.

### Preparing the Site

See "Constructing Stabilization Ponds," SAN.2.C.5.

### Staking Lagoon, Embankment, and Pipe Locations

See "Constructing Stabilization Ponds," SAN.2.C.5.

### Excavating the Lagoon

See "Constructing Stabilization Ponds," SAN.2.C.5.

### Building Embankments

See "Constructing Stabilization Ponds," SAN.2.C.5.

### Laying Pipes

See "Constructing Stabilization Ponds," SAN.2.C.5.

### Lining the Lagoon

The bottom of the lagoon and the inside of the embankment must be lined to prevent erosion caused by the aerators and to prevent bottom soil from being stirred into the effluent. See Figure 4.

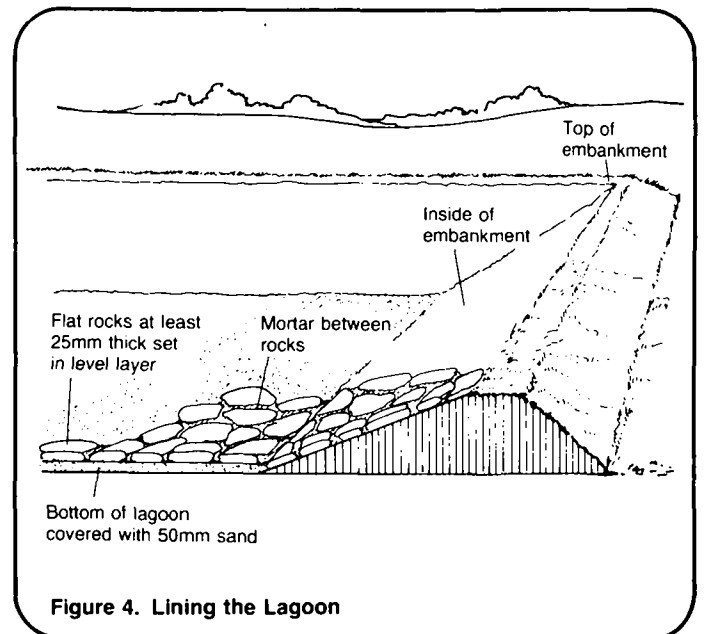


Figure 4. Lining the Lagoon

**Table 2. Sample Work Schedule for Constructing an Aerated Lagoon.**

Time Estimate	Day	Task	Personnel	Materials/Tools
1/2 day	1	Mark lagoon site	Engineer or experienced foreman (always present), 2 workers	Maps, drawings, measuring tape
1 1/2 days	1-2	Clean site of trees, brush, and debris	6 workers	Axes, machetes, cart
1 day	3	Scrape topsoil and pile for finishing embankment	6 workers, 1 loader operator	Front-end loader, shovels
1 day	4	Stake site of lagoon, embankment, pipes	1 surveyor, 3 workers	Transit, level, level rod, steel measuring tape, stakes
4 days	5-8	Excavate lagoon and build embankments	1 loader operator, 6 workers	Front-end loader, shovels, picks, carts
1 day	9	Dig pipe trenches and lay pipe	6 workers, 1 worker skilled with mortar	Picks, shovels, 100mm diameter sewer pipe, pipe valves, mortar
4 days	10-13	Line the lagoon	6 workers, 1 worker skilled with mortar	Sand, flat stones, chipping hammers, safety goggles, mortar
2 days	14-15	Finish embankment	1 loader operator, 6 workers	Loader, shovels, topsoil, sod
1/2 day	16	Set securing posts	4 workers	Posts, shovels
1 1/2 days	16-17	Lay electric cable	1 electrician, 4 workers	Electric cable, electricians tools, shovels

1. If the stones used for lining are not of uniform thickness, spread a 50mm layer of sand on the lagoon bottom. This will make it easier to work the stones into an even layer.

2. Stones used must be at least 25mm thick. Fit them as close together as possible. Use a stonemason's chipping hammer to improve the fit between the stones and wear protective goggles.

3. Pour concrete mortar between the stones and smooth with a trowel. The mortar should be 1 part cement, 2-3 parts sand, and enough water to make a very wet, pourable mix.

### Finishing Embankment

See "Constructing Stabilization Ponds," SAN.2.C.5.

### Installing Aerators

Floating aerators are connected to electric cables and held in place by mooring lines attached to securing posts on the embankment. See Figure 5.

1. String electric cable from the power source to the lagoon site. Cables should be suspended overhead or buried underground, and they should be

protected from damage caused by embankment maintenance.

2. Using the design drawings, locate the points for the securing posts on the embankment. The posts may be made of wood or steel and should be at least 1.0m long. Drive or set them firmly into the embankment.

3. The aerators cannot be positioned until the lagoon is filled to its design depth with effluent. See "Operating and Maintaining Mechanically Aerated Lagoons," SAN.2.0.7.

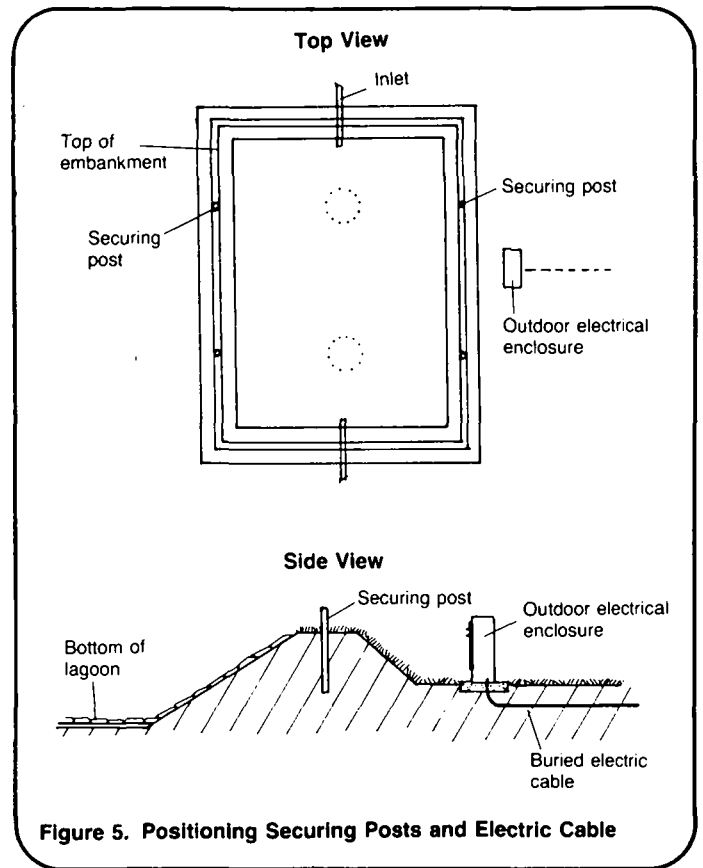
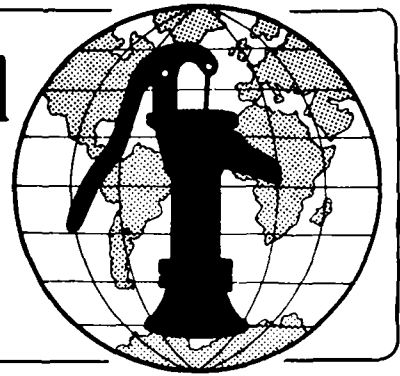


Figure 5. Positioning Securing Posts and Electric Cable

**Technical Notes** are part of a set of "Water for the World" materials produced under contract to the U.S. Agency for International Development by National Demonstration Water Project, Institute for Rural Water, and National Environmental Health Association. Artwork was done by Redwing Art Service. Technical Notes are intended to provide assistance to a broad range of people with field responsibility for village water supply and sanitation projects in the developing nations. For more detail on the purpose, organization and suggestions for use of Technical Notes, see the introductory Note in the series, titled "Using 'Water for the World' Technical Notes." Other parts of the "Water for the World" series include a comprehensive Program Manual and several Policy Perspectives. Further information on these materials may be obtained from the Development Information Center, Agency for International Development, Washington, D.C., 20523, U.S.A.

# Water for the World



**Constructing, Operating, and Maintaining  
Non-Conventional Absorption Systems**  
Technical Note No. SAN. 2.C.8

Non-conventional absorption systems have been developed for soil conditions where absorption is low or slight, or where ground water is close to the ground surface. Effluent from a septic tank discharges to special filter beds or into mounds of soil or sand for final discharge by drainage or evapotranspiration. Such methods are for despiration cases where usual soil absorption lines cannot work. Constructing non-conventional systems requires the services of an engineer or construction foreman experienced with the type of system being built.

Constructing involves assembling labor, materials, and tools; staking the site; excavating or preparing the site; building a mound or refilling the excavation with special soil or sand; laying distribution pipes; and completing the system. These systems are self-operating and require little maintenance. They must be inspected periodically, and any problems must be corrected.

This technical note describes the elements involved in constructing and maintaining non-conventional systems. Read the entire technical note before beginning construction.

## Materials Needed

Before construction can begin, the project designer must provide:

1. A location map similar to Figure 1.
2. Design drawings similar to Figures 2, 3, or 4.
3. A materials list similar to Table 1.

## Useful Definitions

**EFFLUENT** - Settled sewage.

**EVAPOTRANSPIRATION** - The loss of moisture from the soil caused by direct evaporation and by the transpiration of moisture to the air by plants.

**IMPERMEABLE** - Not allowing liquid to pass through.

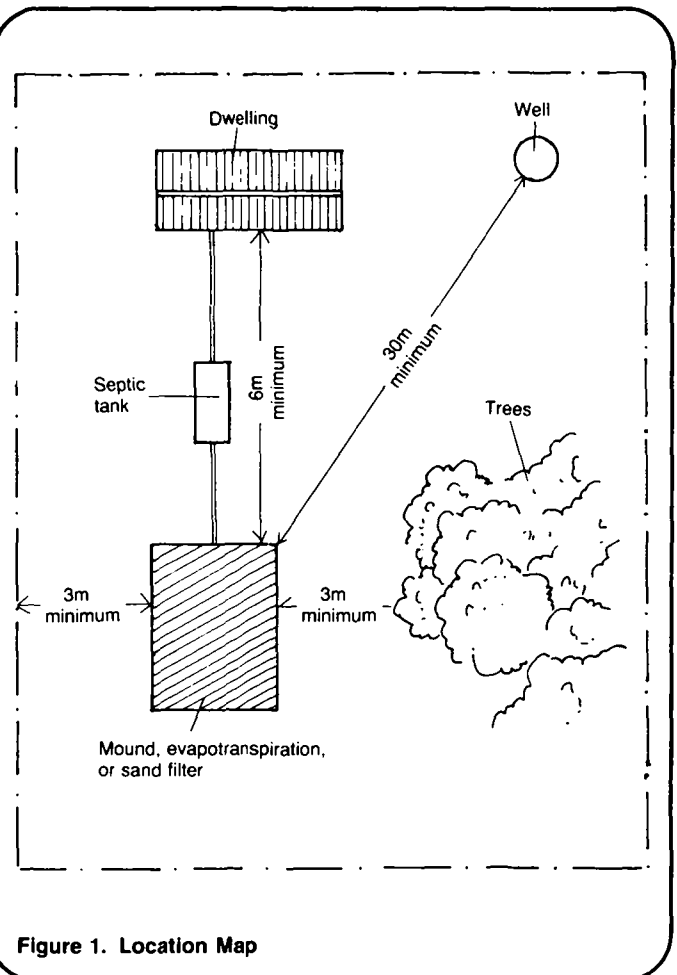


Figure 1. Location Map

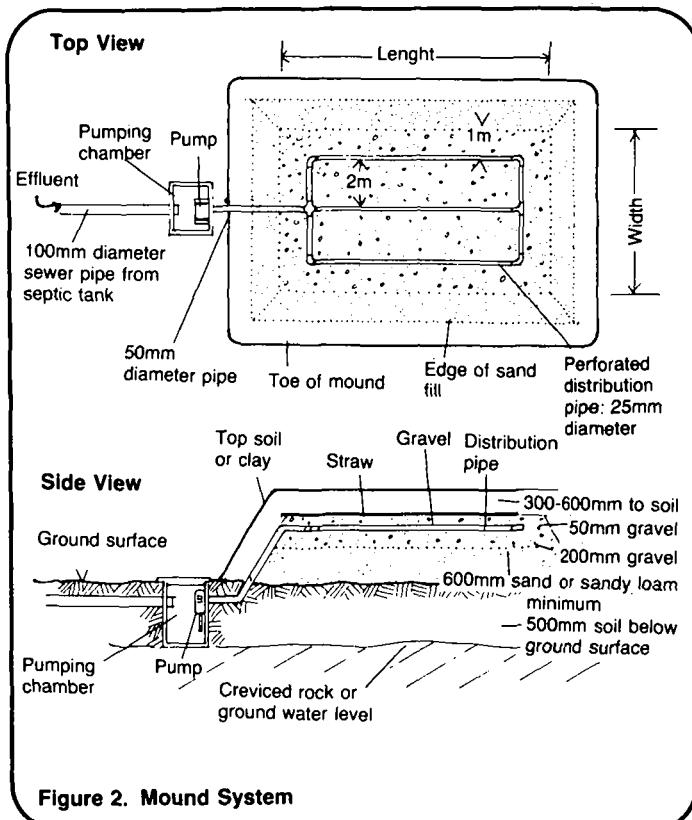


Figure 2. Mound System

Table 1. Sample Materials List for Mound Systems, Evapotranspiration System or Sand Filter

Item	Description	Quantity	Estimated Cost
Labor	Engineer or experienced construction Foreman familiar with the system	1	---
	Surveyor, to lay out the system	1	---
	Workers	4-8	---
Supplies	Pump (capable of 110 liters per minute)	1	---
	Select filter sand; all must pass a 6mm screen; effective size 0.3-0.6mm; uniformity coefficient less than 3.5	m <sup>3</sup>	---
	Gravel; 3-6mm in size	m <sup>3</sup>	---
	Gravel; 18-36mm in size	m <sup>3</sup>	---
	Fill sand	m <sup>3</sup>	---
	Select vegetation	---	---
	Perforated pipe, 100mm diameter	m	---
	Perforated pipe, 25mm diameter	m	---
	Sewer pipe, 100mm diameter	m	---
	Impermeable synthetic liner	m <sup>2</sup>	---
Tools	Shovels	4-8	---
	Wheelbarrows	2-4	---
	Trowel	2	---
	Containers for mixing mortar	2	---
	Surveying equipment	---	---

Total Estimated Cost = \_\_\_\_\_

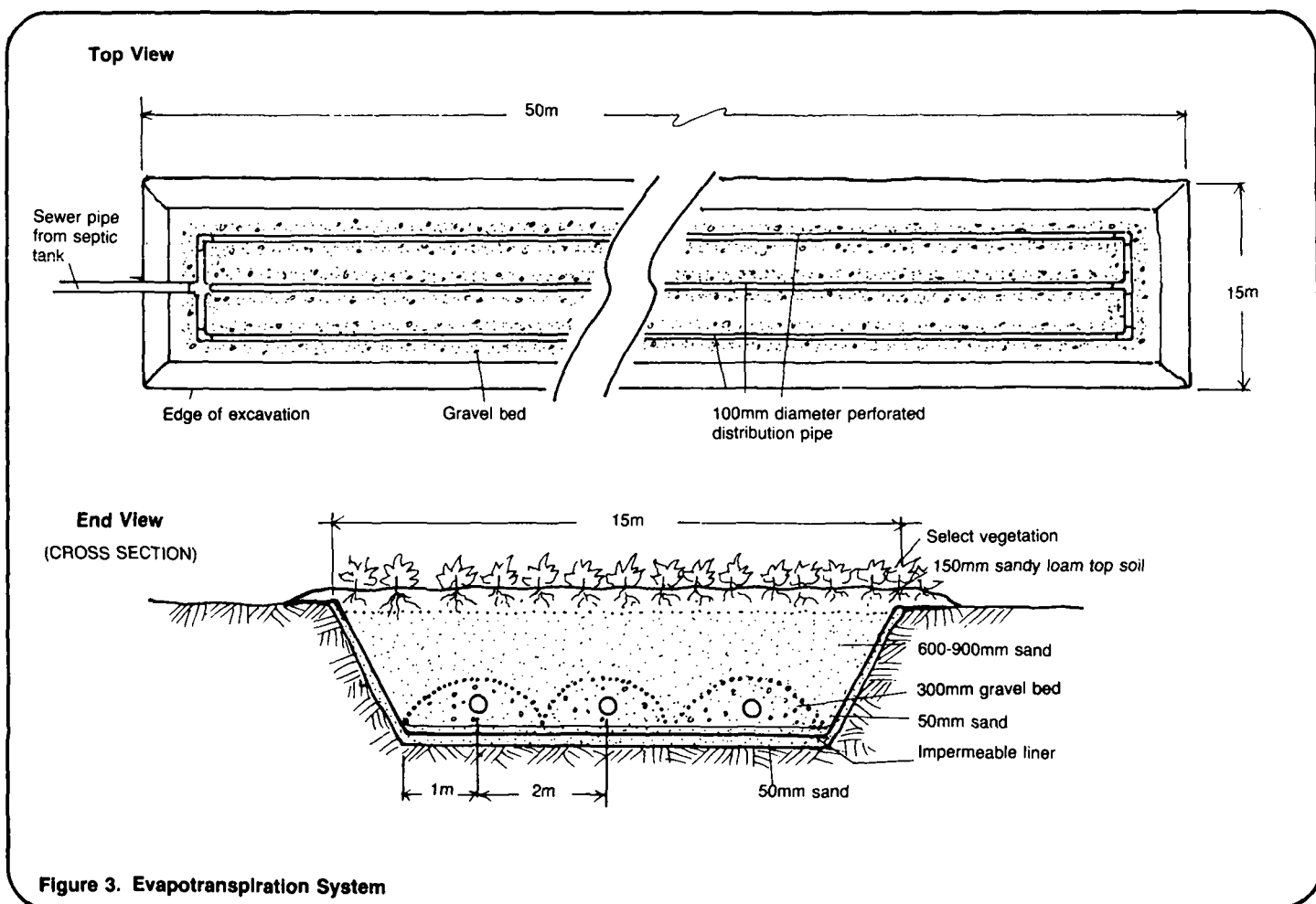


Figure 3. Evapotranspiration System

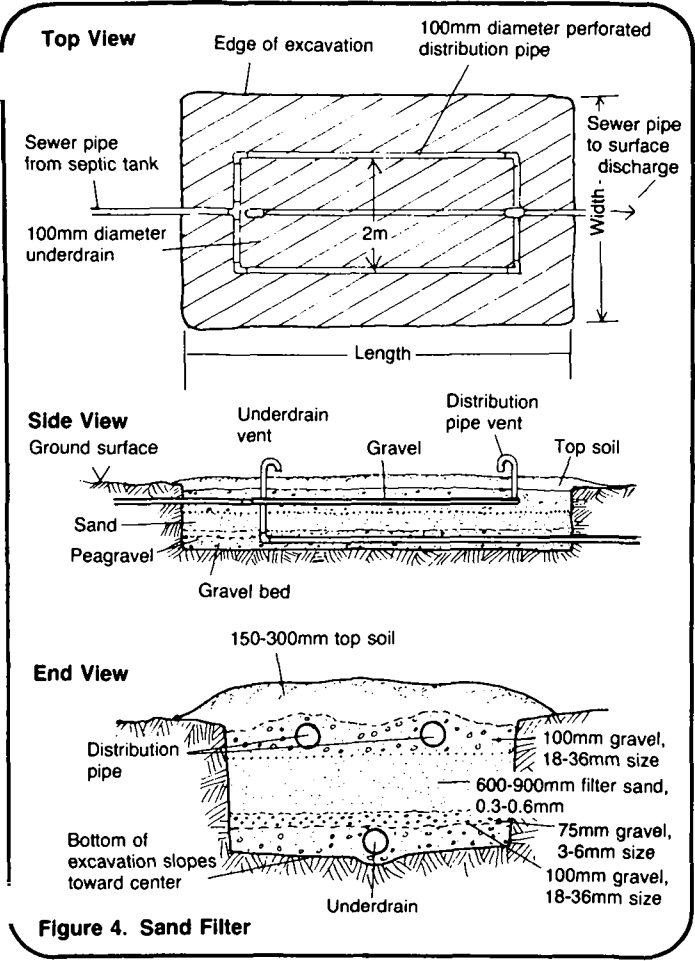


Figure 4. Sand Filter

Depending on local conditions, availability of materials, skills of workers and equipment, some construction steps will take only a few hours, while others may require a day or more. Read the construction steps and make a rough estimate of the time needed for each step based on local conditions. You will then have an idea of when during the construction process specific workers, materials, and tools must be available. Draw up a work plan similar to Table 2 showing construction steps.

### Constructing a Mound System

1. Staking the Site. Using wooden stakes, mark the boundaries of the mound, the site of the pumping chamber, and the trenchline from the septic tank to the system.
2. Preparing the Site. Clear all vegetation from the site. Plow the ground surface within the boundaries of the mound to ensure better drainage of effluent. Throughout construction, avoid compacting material within the mound.

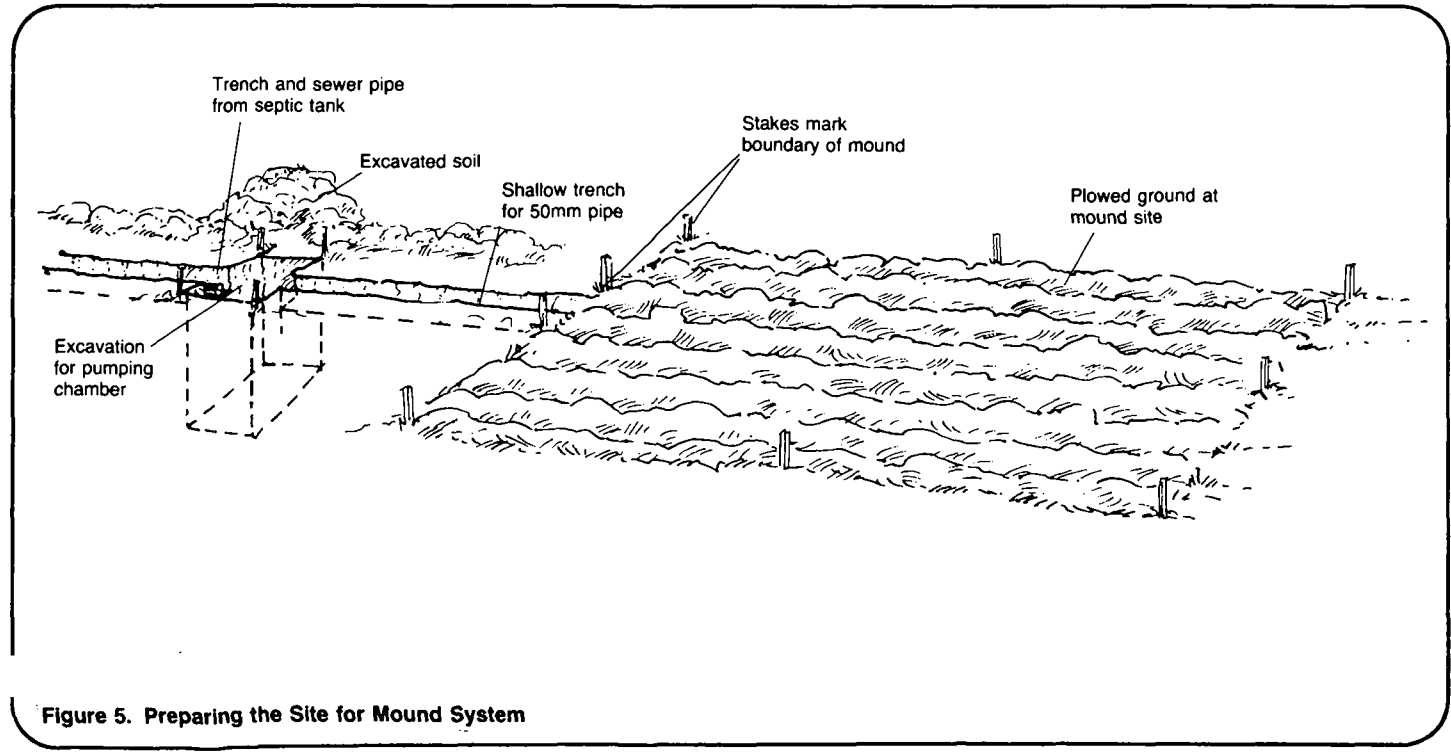


Figure 5. Preparing the Site for Mound System

**Table 2. Sample Work Plan for Constructing a Mound System**

Time Estimate	Day	Task	Personnel	Materials/Tools
2 hours	1	Stake out system on ground	Engineer or construction foreman experienced with mound system (always present); 2 workers	Location map; design drawings; surveying equipment; stakes
4 hours	1	Clear vegetation and plow ground	4 workers	Shovel, rakes, 2 hoes
4 hours	2	Excavate hole for pumping chamber and dig trench for sewer pipe	4 workers	4 shovels
4 hours	2	Lay sewer pipe	4 workers	10mm diameter plastic pipe; mortar
1 day	3	Build pumping chamber	1 worker skilled with concrete; 2 workers	Concrete mix; reinforcing material; trowel; wooden forms; wet straw
2 days	4-5	Begin building mound	4 workers	Shovels; wheelbarrows; sandy loam; gravel
1 day	6	Lay distribution pipe	4 workers	25mm diameter perforated plastic pipe; mortar; surveying equipment; gravel; straw
1 day	7	Install pump	1 worker experienced with pump installation	Pump and fittings; proper tools
3 hours	8	Connect pump to mound	2 workers	50mm diameter plastic pipe
6 hours	8	Complete mound	4 workers	Shovels; wheelbarrows; topsoil; grass seed



Excavate the hole for the pumping chamber and excavate the trenches from the septic tank to the chamber and the chamber to the mound site. Build a pumping chamber from reinforced concrete. It can be alongside the tank with a common wall between. The size and design of the chamber are determined by the engineer and depend, in part, on the pump which the chamber will house. For details on reinforced concrete, see "Constructing Septic Tanks," SAN.2.C.3. Lay sewer pipe from the septic tank to the pumping chamber, cover with soil, and carefully tamp. See Figure 5.

3. Building the Mound. Begin building the mound with sandy loam or other fill material approved by the engineer. Do not tamp. The minimum height of this layer is 600mm and the top must be level. Cover the sandy loam with a 200mm layer of clean gravel. See Figure 6.

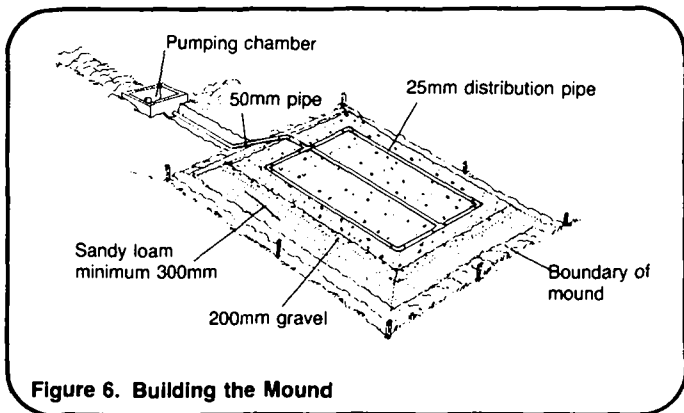


Figure 6. Building the Mound

4. Laying Distribution Pipe. Position 25mm diameter, perforated distribution pipes on the gravel with the perforations facing downward. The pipes should be level. Lay 50mm diameter pipe from the pumping chamber up the slope of the sandy loam. Connect it to the distribution pipe. Cover the distribution pipes with a 50mm layer of gravel and spread hay or straw over the gravel.

5. Completing the System. Install the pump in the pumping chamber and connect the 50mm diameter pipe leading to the mound. Connect the pump to its power source. Seal the pumping chamber and cover the pipe. Cover the entire mound with at least 300mm of topsoil or clay. Plant grass seed or lay sod on the mound. See Figure 7.

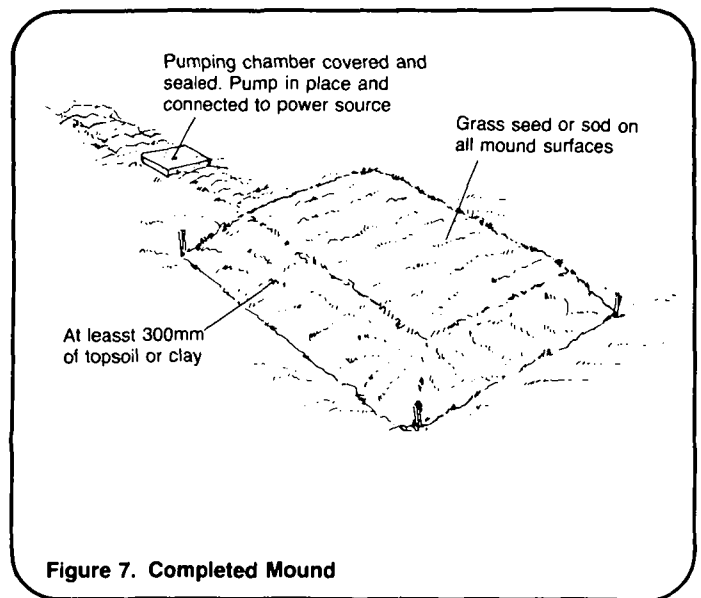


Figure 7. Completed Mound

### Constructing an Evapotranspiration System

1. Staking the Site. Using wooden stakes, mark the boundaries of the excavation and the trenchline from the septic tank to the site.

2. Excavating the System. Dig the trenchline from the septic tank to the site and excavate the site to the design depth. Lay 100mm diameter sewer pipe from the septic tank to the site. Cover with soil and carefully tamp.

3. Lining the System. Spread a 50mm layer of sand on the bottom of the excavation to protect the liner. Carefully position the impermeable liner preferably of PVC plastic, across the bottom and up the four side walls as shown in Figure 8. Cover the liner with a 50mm layer of sand.

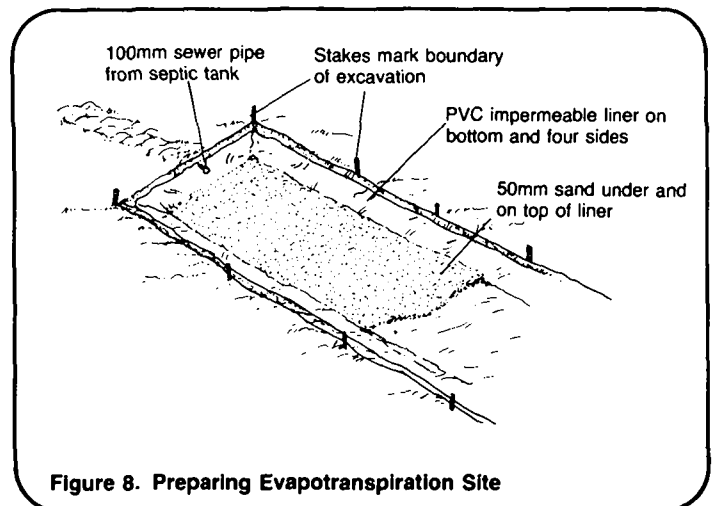


Figure 8. Preparing Evapotranspiration Site

4. Laying Distribution Pipe. Spread gravel beds for the distribution pipes. The beds are 150mm high and about 300mm wide. Position 100mm diameter perforated distribution pipes on the gravel beds with the perforations facing downward. See Figure 9. Cover the distribution pipes with a 50mm layer of gravel and spread hay or straw over the gravel.

5. Completing the System. Fill the excavation with 600-900mm of sand. Cover the sand with about 150mm of top-soil and mound the soil for surface drainage. Plant selected vegetation over the system. See Figure 10.

### Constructing a Sand Filter

1. Staking the Site. Using wooden stakes, mark the boundaries of the excavation and the trenchline from the septic tank to the site.

2. Excavating the System. Dig the trenchline from the septic tank to the site and excavate the site to the design depth. Make the bottom of the excavation slope toward the center. Dig the trenchline for the discharge pipe. Lay 100mm diameter sewer pipe from the septic tank to the site and from the site to the point of discharge. Cover with soil and carefully tamp. See Figure 11.

3. Laying the Underdrain. Spread a 100mm layer of gravel, 18-36mm in size, on the bottom of the excavation. Position the 100mm diameter perforated underdrain on the gravel with the perforations facing downward. The underdrain should slope slightly downward to the discharge pipe. Cover the underdrain with a layer of gravel, 18-36mm in size. This layer must be level on top and 100mm thick at the edges. Cover the layer with 75mm of gravel, 3-6mm in size.

4. Placing the Filter Sand. Partially fill the excavation with 600-900mm of selected filter sand. See Figure 12. This sand must be approved by the engineer before it is put in the system. Flood the system with clean water to settle the sand.

5. Laying Distribution Pipe. Cover the sand with a 100mm layer of gravel, 18-36mm in size. Position 100mm diameter perforated distribution pipes

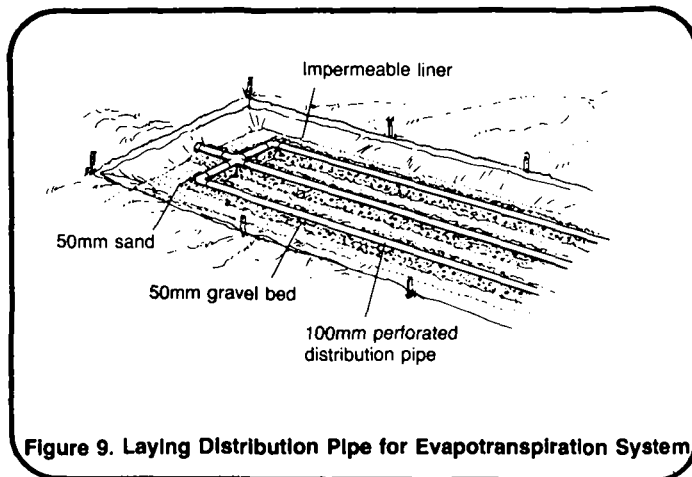


Figure 9. Laying Distribution Pipe for Evapotranspiration System

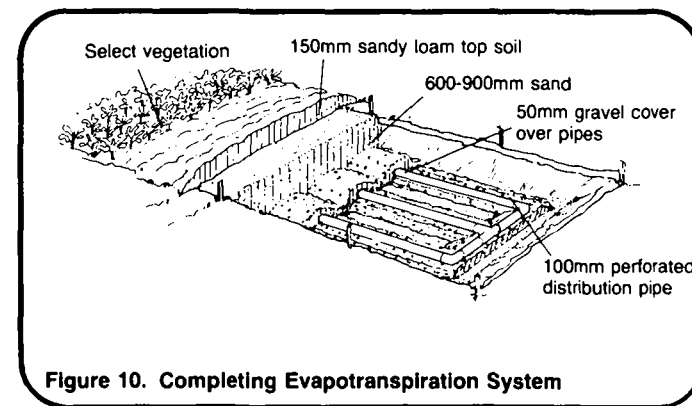


Figure 10. Completing Evapotranspiration System

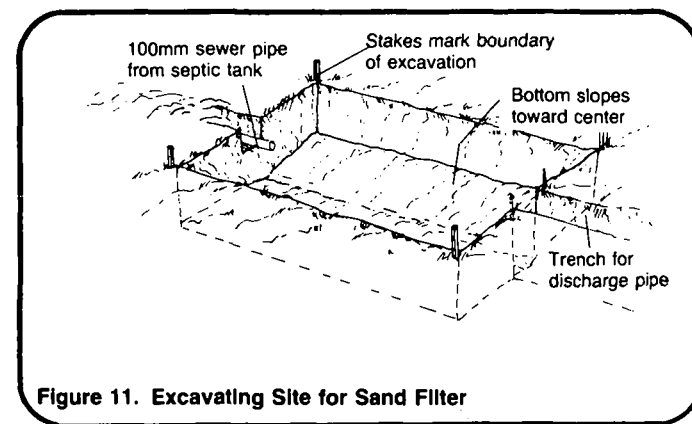


Figure 11. Excavating Site for Sand Filter

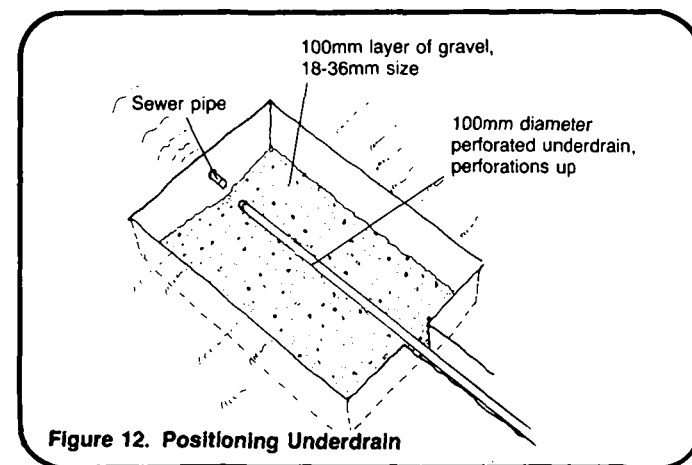


Figure 12. Positioning Underdrain

on the gravel with the perforations facing downward. Cover the distribution pipes with a 50mm layer of gravel and spread hay or straw over the gravel.

6. Completing the System. Fill the excavation with 150-300mm of topsoil and mound the soil for surface drainage. See Figure 13. Plant grass seed over the system.

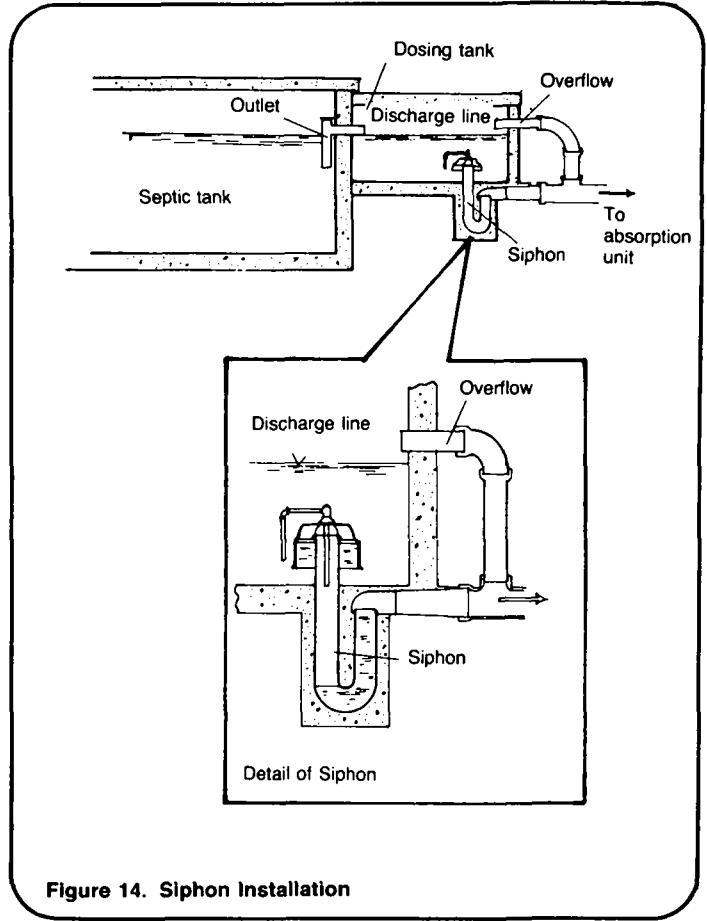
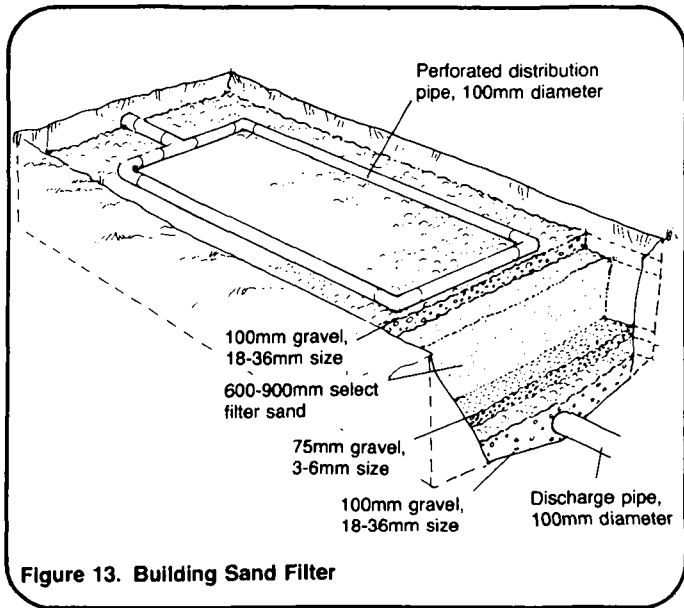


Figure 14. Siphon Installation

7. Install the Dosing Siphon. The dosing siphon, shown in Figure 14, should be placed exactly in accordance with the manufacturer's directions. It operates on the compression of air volume under the bell.

### Operating and Maintaining Mound Systems, Evapotranspiration Systems, and Sand Filters

These systems are self-operating. Effluent flows by gravity from the septic tank to the evapotranspiration system. It may do so to a sand filter, but with a great loss of efficiency. Mounds and sand filters work best if their pipes are filled two or three times per day.

In a mound system, the effluent enters the pumping chamber and must be pumped up to the distribution pipes as the mound will usually be higher than the tank. It flows through the distribution pipes, seeps down through the mound and drains safely into the natural ground.

In an evapotranspiration system, effluent flows through the distribution pipes into the gravel beds to await evapotranspiration. The effluent is gradually drawn upward by capillary action into the sandy fill. This is the same process that draws oil or fuel up into the wick of a lantern. Effluent evaporates from the surface of the ground or is transpired by the cover plants into the atmosphere.

In a sand filter, effluent flows through the distribution pipes, filters down through the sand to the underdrain, and flows safely out the discharge pipe to a dry ditch or waterway. The point of discharge should be downstream from drinking water supplies. To fill the pipes fully two or three times per day, a dosing siphon, Figure 14, or pump is needed feeding from a collecting chamber after the septic tank. Filling the pipes makes full use of the filter.

Maintaining these systems involves inspecting for burrowings, erosion, and system failure.

Burrowings. Small holes or excavations on or near the system indicated the presence of dogs or other burrowing animals. These animals should be kept away. Set traps or erect fences if necessary.

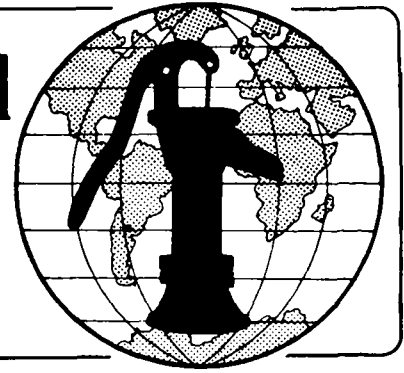
Erosion. If wind, rain, or surface water causes erosion on or near the system, fill and mound with soil. Plant grass or other vegetation. If surface water is a problem, build small diversion dams and ditches to direct water away from the system.

System Failure. A system fails when it no longer absorbs effluent or when it absorbs effluent at a slower rate than it is received. Signs of failure are puddles, wet spots, and continual odors. In some cases, stop pages can be located and cleaned out.

When a system fails, it usually cannot be repaired. If the whole bed is clogged, the system will have to be rebuilt or replaced. Piping, liners and even gravel can be recovered for re-use.

**Technical Notes** are part of a set of "Water for the World" materials produced under contract to the U.S. Agency for International Development by National Demonstration Water Project, Institute for Rural Water, and National Environmental Health Association. Artwork was done by Redwing Art Service. Technical Notes are intended to provide assistance to a broad range of people with field responsibility for village water supply and sanitation projects in the developing nations. For more detail on the purpose, organization and suggestions for use of Technical Notes, see the introductory Note in the series, titled "Using 'Water for the World' Technical Notes." Other parts of the "Water for the World" series include a comprehensive Program Manual and several Policy Perspectives. Further information on these materials may be obtained from the Development Information Center, Agency for International Development, Washington, D.C., 20523, U.S.A.

# Water for the World



## Operating and Maintaining Septic Tanks

Technical Note No. SAN. 2.0.3

A septic tank is a self-operating unit for sewage treatment. The tank receives raw sewage from a building, allows solids to settle out, and discharges effluent to an underground (subsurface) absorption system for final disposal. Maintaining a septic tank involves periodically measuring scum and sludge depth and cleaning the tank. It is important to maintain the septic tank on a routine basis in order to ensure continued operation, prevent tank failure, and extend the life of the subsurface absorption system (see "Constructing, Operating and Maintaining Subsurface Absorption Systems," SAN.2.C.1). A properly constructed and maintained septic tank can last for 20 years or more.

This technical note describes how to (1) measure scum and sludge depths to determine if the tank needs to be cleaned, (2) clean the tank, and (3) check for signs of tank failure.

Read the entire technical note before beginning maintenance activities.

### Useful Definitions

**GROUNDWATER LEVEL** - The level to which subsurface water rises during any given time of year.

**SCUM** - Oily, greasy, and sometimes crusty material that floats on or near the liquid surface in a septic tank.

**SEPTAGE** - The combined contents of the septic tank; that is, all of the scum, sludge, and effluent.

**SLUDGE** - Settled solids at the bottom of the septic tank.

## Inspecting the Septic Tank

Inspect the septic tank at least once a year to determine if it needs cleaning. The tank needs to be cleaned if either (a) the depth of the sludge is equal to or greater than one-third the liquid depth, or (b) the bottom of the scum layer is within 75mm of the bottom of the outlet pipe's "T" fitting. If the tank is allowed to become too full of scum or sludge, it will begin discharging solids to the subsurface absorption system. When this happens, the system will rapidly become clogged and a new system will have to be built.

## Locating and Opening the Tank

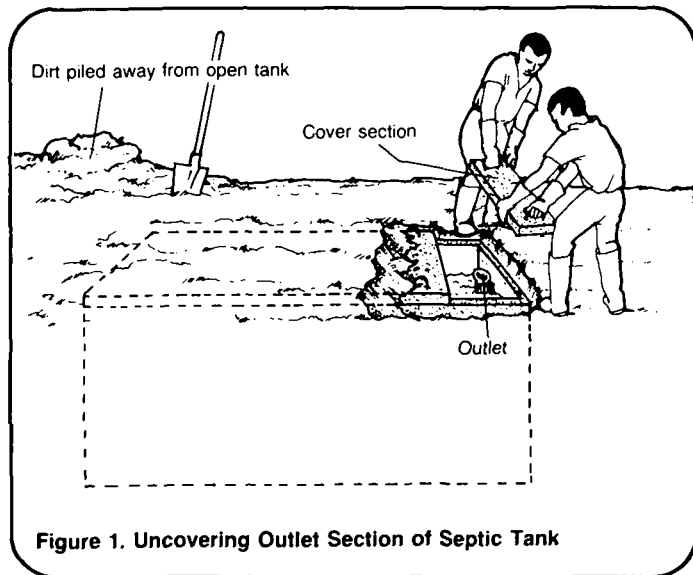
If the top of the tank is level with or above ground level, finding it should not be a problem.

If the top of the tank is covered with dirt, locate the tank site by one or more of the following methods: (1) locate the metal stake, wooden post, or other identifying marker placed there when the tank was built, (2) locate the mound of dirt over the tank, (3) make field measurements using a measuring tape and the location map used to site the tank for construction, (4) make a rough guess based on memory or the knowledge of persons using the septic tank system.

When the site has been identified, dig small test holes until the tank is found. The top of the tank should be no more than about 0.3m below the surface of the ground. Find the outlet end of the tank (this is the end farthest from the building and nearest the absorption field).

If the tank top is made in sections, uncover the end section, which is the one over the outlet end of the tank. Remove dirt and pile it far enough away from the tank so that when the section is removed, dirt will not fall into the tank. If the tank top is one piece equipped with manholes, uncover the manhole over the outlet end.

Remove the end top section or manhole and set it aside as shown in Figure 1.



## Determining If the Tank Needs to be Cleaned

There are two ways to find out if the tank needs cleaning: measure the depth of the sludge and measure the depth of the scum.

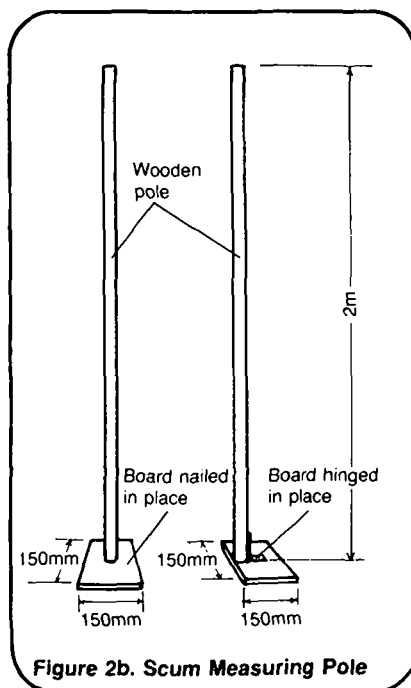
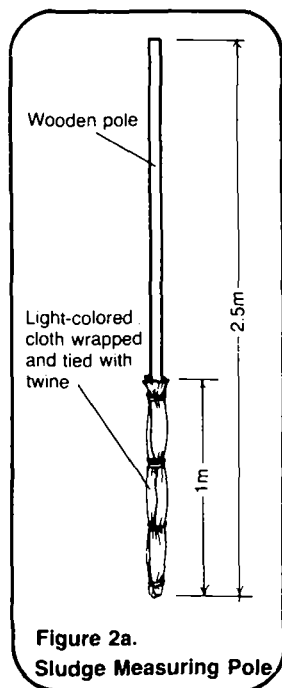
To measure the depth of the sludge:

1. Wrap a light-colored cloth around one end of a 2.5m pole and fasten it with string or twine as shown in Figure 2a.

2. To avoid the scum, lower the measuring pole through the "T" fitting to the bottom of the tank as shown in Figure 3.

3. After a few minutes, slowly and carefully remove the pole. The depth of the sludge can be distinguished from the effluent by dark particles clinging to the cloth.

4. With a measuring tape, measure the depth of sludge on the pole. If the depth of the sludge is equal to or greater than one-third the liquid depth of the tank, the tank needs to be cleaned. If the depth of the sludge is less than one-third the liquid depth, go ahead and measure the scum depth.



<b>SLUDGE DEPTH CHART</b>	
Clean the septic tank if:	
the <u>liquid</u> depth is	and the <u>sludge</u> depth is equal to or greater than
0.9m	0.30m
1.1m	0.37m
1.2m	0.40m
1.5m	0.50m
1.8m	0.60m
divided by 3 equals	
NOTES: 1. Liquid depth is the distance from the design flow line to the bottom of the tank (see Figure 4). 2. If the liquid depth of the tank does not appear on this chart, write it in the space provided in the liquid depth column, divide by 3, and write the answer in the space provided in the sludge depth column.	

To measure the depth of the scum:

1. Fasten a 150mm square board to one end of a 2m pole with nails or a hinge. The hinge makes it much easier to push the board and pole down through the scum as shown in Figure 2b. (NOTE: If the 2.5m pole is used for this purpose, remove the cloth and twine.)

2. Push the board and pole down through the scum layer.

3. Raise the pole slowly as shown in Figure 4, until you can feel the bottom of the scum layer. It will offer more resistance than the liquid.

4. Mark the pole with a pencil to show the depth of the scum.

5. Using the same procedure, locate the bottom of the outlet pipe's "T" fitting and mark the pole.

6. The distance between the two marks is the same as the distance from the bottom of the scum to the bottom of the "T". Measure the distance with the measuring tape. If it is 75mm or less, the tank must be cleaned. If the distance is more than 75mm the tank need not be cleaned at this time.

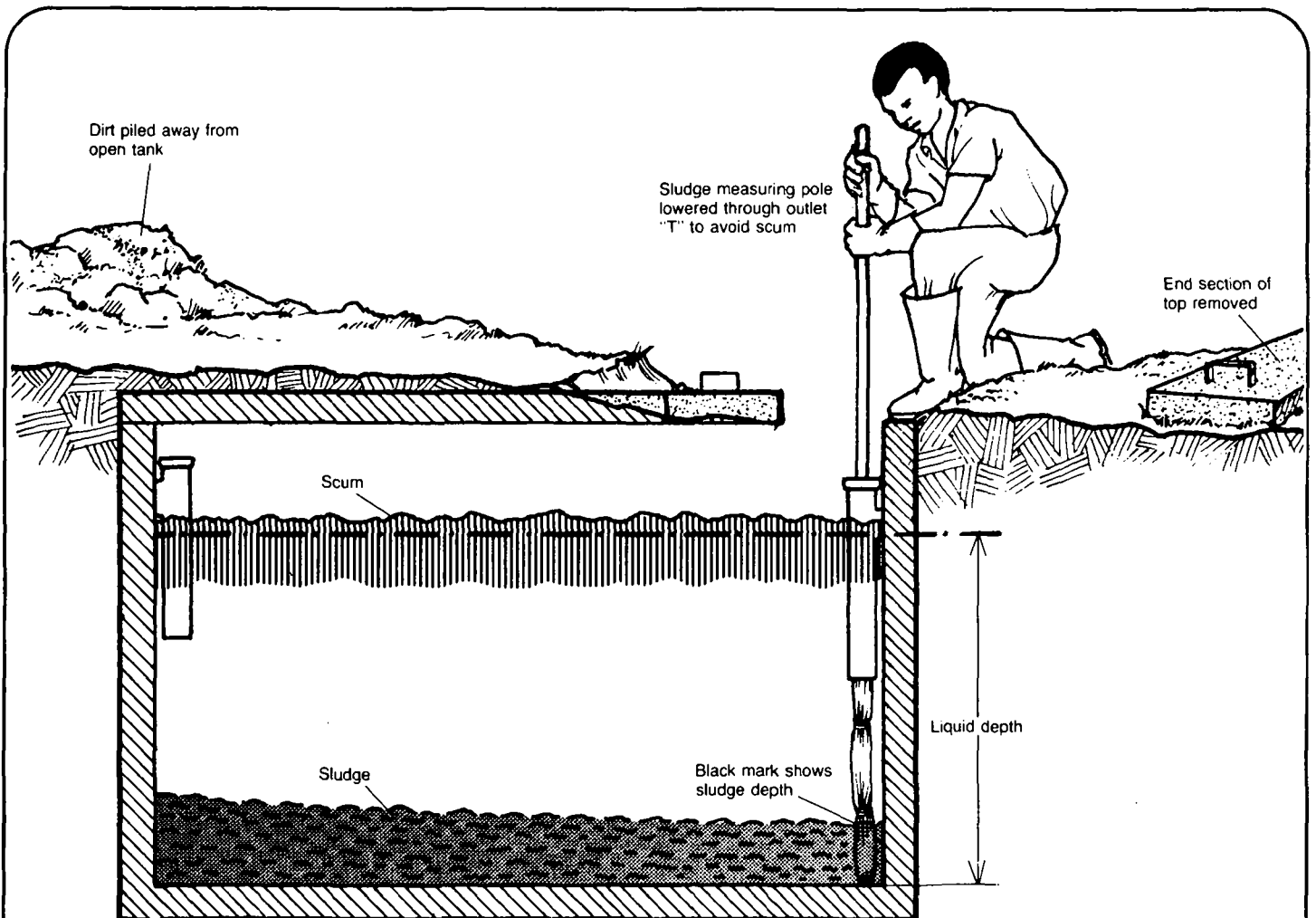


Figure 3. Measuring Sludge Depth

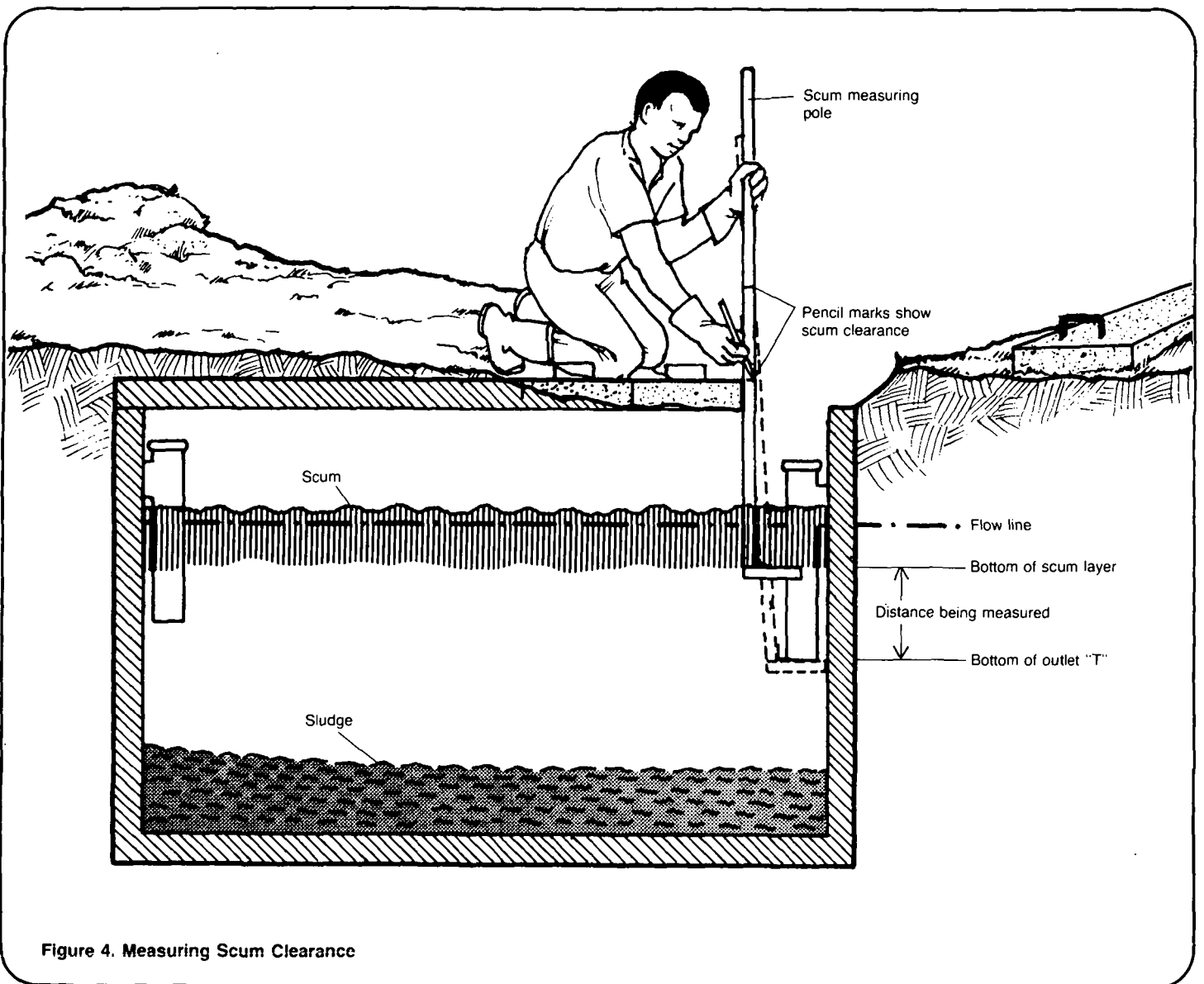


Figure 4. Measuring Scum Clearance

## Resealing the Tank

If the tank does not require cleaning, replace the top section or manhole and thoroughly waterproof around the edges with tar or other waterproofing material. Replace the dirt, if applicable, and mound. Set a metal stake, wooden post, or other object to identify the outlet end of the tank so it can be easily located when it is time for the next tank inspection.

## Cleaning the Septic Tank

If the sludge or scum depths indicate the tank needs cleaning, begin the cleaning process immediately. Delay risks damaging the subsurface absorption field. The tank can be cleaned mechanically or by hand.

To clean the tank mechanically:

These steps will depend in part on the type of equipment being used. Generally, the sewage pump, hoses, and container are all mounted on a truck.



1. Park the truck near, but not over, the septic tank.
2. Start the sewage pump and let it run for a few minutes.
3. Lower the hose into the tank and begin pumping out the septage. If the scum layer is especially heavy and crusty, have a worker break it up with a shovel while the septage is being pumped.
4. When the tank is empty, retrieve the hose and shut off the pump. (NOTE: Small amounts of septage may be left in the tank to act as a starter when the tank is put back into operation.)
5. Replace the top section or manhole cover and waterproof.
6. Drive the truck to the septage disposal site.

To clean the tank by hand:

1. Remove dirt from at least half and preferably all of the top of the tank if it is underground. Pile the dirt far enough away so that when the sections are removed, dirt will not fall in.
2. Remove at least half and preferably all of the top sections.
3. Have all workers put on gloves and boots.
4. Begin dipping out the septage with a bucket tied to a rope and emptying the septage into the containers as shown in Figure 5. Have a worker break up the scum layer and continually stir the septage with a shovel or pole. This will bring sludge off the bottom and leave less to be shoveled out later.

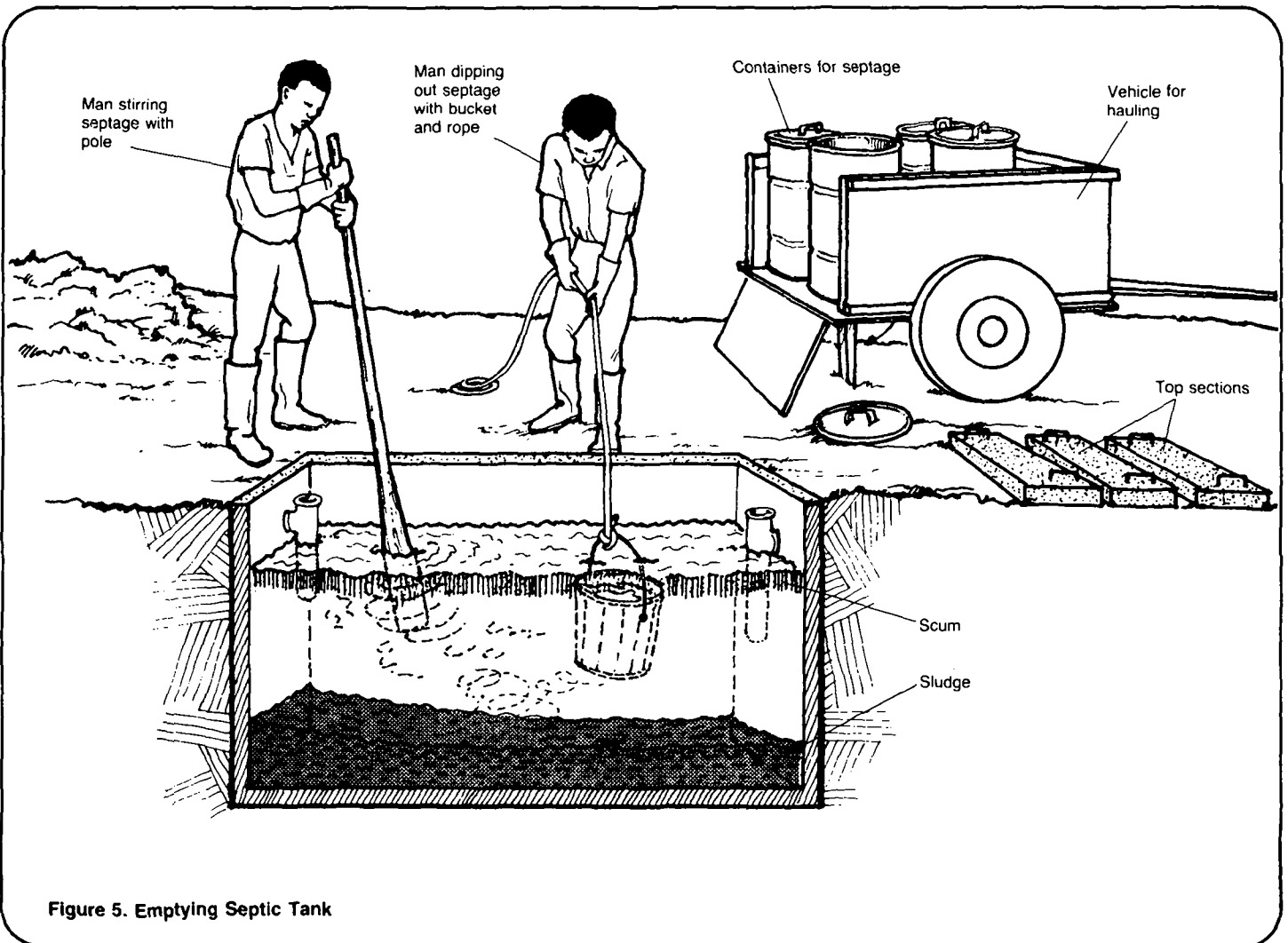


Figure 5. Emptying Septic Tank

5. When no more septage can be dipped out with the bucket, it is necessary to enter the tank. Wear a safety rope held by an assistant standing outside the tank or tied to a section of the top that has been removed. Using a scoop shovel, remove sludge from the bottom of the tank as shown in Figure 6. It may be convenient to empty sludge into a bucket tied to a rope, and have a worker raise the bucket out to the tank and empty it into a container.

6. Do not wash the walls or floor of the septic tank. The small amount of septage left will act as a starter when the tank is put back into use.

7. Thoroughly examine the inside of the tank for any damage. Look for cracks in the walls and floor. Examine the inlet and outlet fittings for damage. Minor damage can be corrected by patching or waterproofing with

cement mortar (see "Constructing Septic Tanks," SAN.2.C.3). If there appears to be major structural damage, the project designer or the worker who supervised construction should be consulted before repairs are attempted and before the tank is put back into use.

8. If the tank is not damaged, or after it has been repaired, replace the top sections and waterproof.

9. Haul the septage to the disposal site.

(NOTES: If more than one day is required to empty the tank, replace the top sections before stopping work at the end of the day. DO NOT leave the tank open overnight. An open tank is a dangerous hazard.

Septage is hazardous material. Thoroughly wash hands with soap after inspecting or cleaning a septic tank or disposing of septage, and especially before eating.)

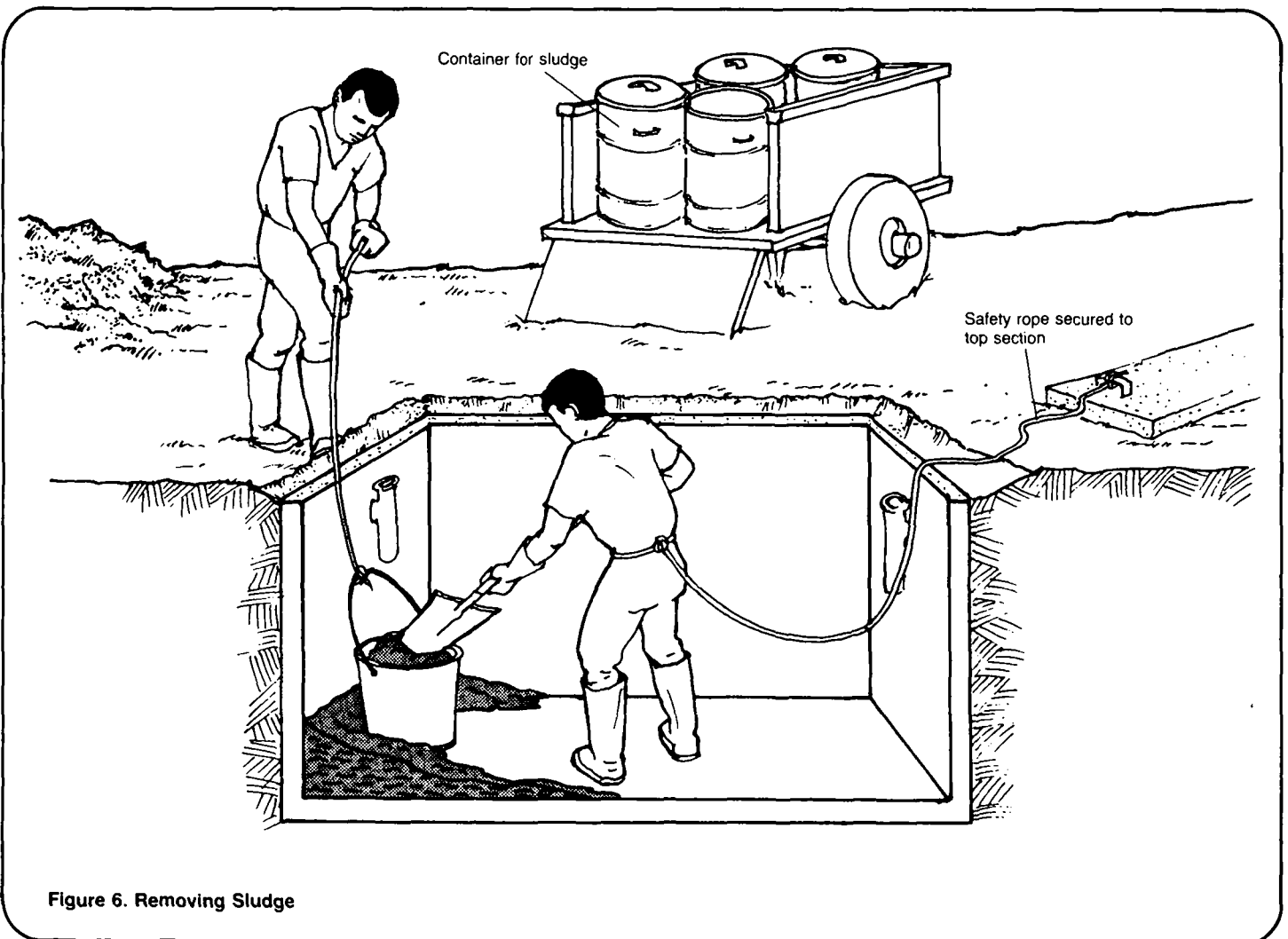


Figure 6. Removing Sludge

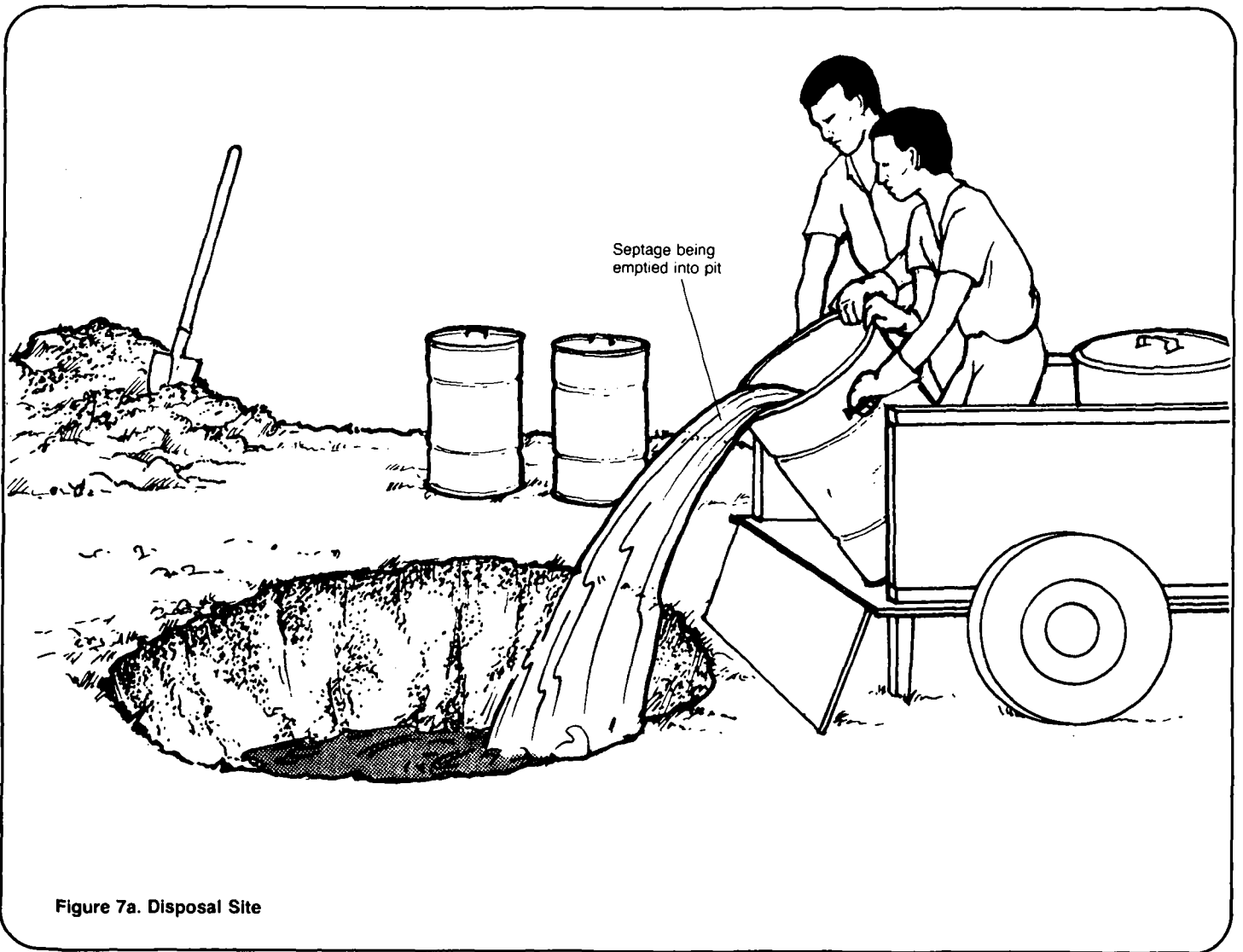


Figure 7a. Disposal Site

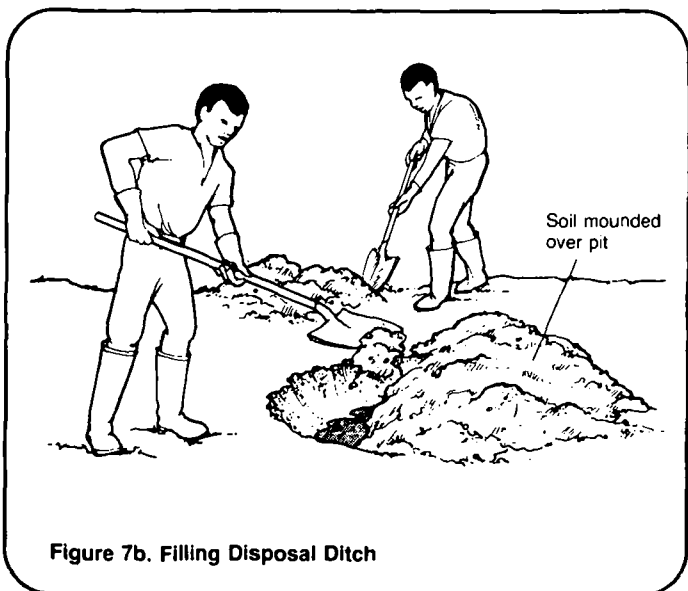


Figure 7b. Filling Disposal Ditch

### Disposing of Septage

Select a disposal site downhill and at least 60m from any water supply or dwelling. The site should be outside the village, in a remote or little-used area.

Dig a shallow pit or trench and dump in the septage as shown in Figure 7a. After the liquid has soaked into the ground, cover the pit with 0.5-0.6m of dirt as shown in Figure 7b.

Septage is hazardous and should be handled carefully. Be careful to avoid spillage when traveling from the septic tank to the disposal site.

## Caution!

1. Never leave an open septic tank unattended. When a tank is opened during cleaning, it becomes a dangerous hazard, especially for children. Unauthorized persons should be kept away from the tank.

2. Remove at least half of the top sections of the septic tank, when it becomes necessary to enter it for cleaning. If the tank top is one piece remove the entire top. This will allow the tank to air out. When entering the tank, wear a safety rope held by one or two assistants standing outside the tank or tied to a section of the top that has been removed.

3. Handle the septage (scum, sludge, and effluent) carefully; it is as hazardous to your health as raw sewage.

4. Do not use chemicals to clean or disinfect the septic tank; harmful fumes may be released.

5. Do not permit the earth around the septic tank to sink or cave-in.

6. Keep dogs and burrowing animals away from the septic tank site.

## Materials Needed

### For Inspecting Tank:

(1) drawing of the tank showing the actual liquid depth; (2) shovel; (3) poles: one 2.5m long, other 2m long; (4) light-colored cloth or towel, about 0.3m x 1m; (5) string or twine, about 1m; (6) board, about 150m square and 25mm thick; (7) hinge (optional); (8) nails; (9) hammer; (10) measuring tape or ruler; (11) pencil or piece of charcoal.

### For Cleaning Tank by Hand:

(1) shovel; (2) scoop shovel; (3) two sturdy ropes, each 5 to 6.5m long and suitable for lifting a worker from the tank; (4) bucket with handle, 11 to 15 liters; (5) several barrels, drums, or other containers larger than the bucket; (6) vehicle to haul containers; (7) pair of gloves for each worker; (8) pair of boots for each worker; (9) flashlight or lantern (optional) for inspecting emptied tank.

### For Cleaning Tank Mechanically:

(1) shovel; (2) sewage pump with hoses long enough to reach from bottom of tank to the containers; (3) containers to hold septage, usually mounted on a truck; (4) vehicle to haul containers, usually a truck.

### For Repairing Tank:

(1) cement; (2) sand; (3) container for mixing concrete mortar; (4) trowel; (5) several lengths of sewer pipe, 100mm in diameter; (6) shovel.

Other: (1) tar or other waterproofing material; (2) maintenance record book.

(NOTE: Some or all of these materials may be left over from construction of the tank.)

## Cleaning Up

When all inspecting, cleaning, and disposing activities are completed, wash tools, equipment, containers, and clothing and store them in a proper place.

Mark your activities on a maintenance record similar to that shown in Table 1. This one is filled in to show examples of how yours will look when you have completed each maintenance activity.

## Inspecting Tank Site

Inspect the site of the septic tank and the subsurface absorption system (see "Constructing, Operating and Maintaining Subsurface Absorption Systems," SAN.2.C.1) every month or so. If any problems are evident, find the causes and correct them at once. Use Table 2 as an aid. Note all problems and repairs on a maintenance record similar to that shown in Table 1.

## Emptying Septic Tanks

It is possible for an empty septic tank to float up out of the hole, causing serious damage. This can happen when the seasonal groundwater level is higher than the bottom of the tank. If this is likely to be a problem in your area, do not empty the tank until a drier season, when the groundwater level is lower.

**Table 1. Sample Maintenance Record**

Inspect Septic Tank Sludge and Scum Levels At Least Once per Year

Inspect Site of Tank and Absorption System Every Few Months

Date	Location	Liquid Depth	Task
4 May '81	Mendoza house	1.2 m	Uncovered tank. Measured sludge (0.2m) and scum space (150 mm). No cleaning necessary. Resealed and re-covered tank. Set post.
5 May '81	al Hofan house		Inspected tank site and leach field. No problems.
5 May '81	N'Kuma house		Inspected tank site. Found erosion around tank. Filled in with dirt. Inspected leach field - no problems.
1 June '81	School	1.5 m	No problem with tank site and field. Opened tank and measured sludge (0.6m). Must clean. Resealed tank. Contacted Jean and Hassan to help me tomorrow.
2 June '81	School		Jean, Hassan and I emptied tank (9 hours). Inspected inside of tank. No problems. Resealed tank. Hauled septage to vacant field - buried in trench.
8 August '81			Inspected tank site and leach field. No problems.
8 August '81			Inspected tank site and leach field. No problems.
8 August '81		1.2 m	Inspected tank site and leach field. No problems. Opened tank and measured sludge (0.3m). Measured scum space (50 mm). N'Kuma and I emptied. I inspected tank. No problems. Resealed tank. Hauled septage to field south of town, dug shallow pit and buried septage.

**Table 2. Problem/Solution Chart**

Problem	Possible Cause	Solution
Lush growth, wet spots, or continual odors near site, or frequent cave-ins at or around site	Tank needs cleaning or repair	Clean tank; inspect for damage (cracked sewer pipe; leaks in walls or floor)
	Outlet clogged	Clean outlet
	Absorption system not operating properly	Inspect system (see SAN.2.C.1)
	Improperly designed tank	Correct design flaw or build new tank
	Tank too small	Reduce sewage flow or build new tank
Erosion at tank site	Surface water flowing over site	Fill and mound with dirt, or build small dams or trenches to divert water
Small holes or excavations near tank site	Dogs or burrowing animals	Keep animals away (erect a fence, set traps, etc.)

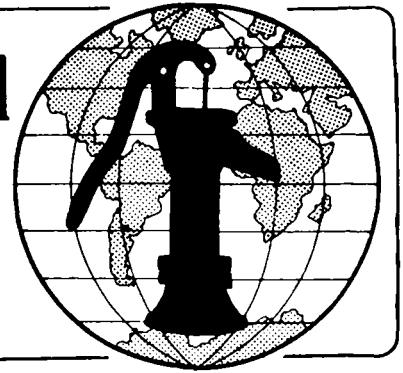
## Notes

## Notes

**Technical Notes** are part of a set of "Water for the World" materials produced under contract to the U.S. Agency for International Development by National Demonstration Water Project, Institute for Rural Water, and National Environmental Health Association. Artwork was done by Redwing Art Service. Technical Notes are intended to provide assistance to a broad range of people with field responsibility for village water supply and sanitation projects in the developing nations. For more detail on the purpose, organization and suggestions for use of Technical Notes, see the introductory Note in the series, titled "Using 'Water for the World' Technical Notes." Other parts of the "Water for the World" series include a comprehensive Program Manual and several Policy Perspectives. Further information on these materials may be obtained from the Development Information Center, Agency for International Development, Washington, D.C., 20523, U.S.A.



# Water for the World



## Operating and Maintaining Sewer Systems Technical Note No. SAN. 2.O.4

A sewer system is a self-operating network of underground pipes that carries sewage by gravity flow from a number of dwellings. The sewage may be a direct flow of wastewater or the effluent after settling in septic tanks or aqua privies. It flows to a stabilization pond or other central treatment facility. Maintaining a sewer system requires the services of an experienced operator. Maintenance involves routinely inspecting the system for blockage or damage and making repairs.

This technical note describes the elements involved in maintaining a sewer system. It does not attempt to explain everything you need to know to operate and maintain a sewer system.

### Useful Definitions

**BRANCH LINE** - A sewer line that carries sewage from one or more house laterals and empties it into the main sewer.

**EFFLUENT** - Settled sewage.

**GRAVITY FLOW** - Flow of water from high ground to low by natural forces.

**HOUSE LATERAL** - A sewer line that carries sewage from a house or septic tank to a branch sewer.

**MAIN LINE** - A sewer line that carries sewage from one or more branch sewers and empties it into a stabilization pond or other treatment unit.

### Materials Needed

For all maintenance and repair of sewers:

(1) a master sewer system map similar to Figure 1 showing the entire sewer network; (2) detailed section maps similar to Figure 2 and profile drawings of all portions of the sewer system.

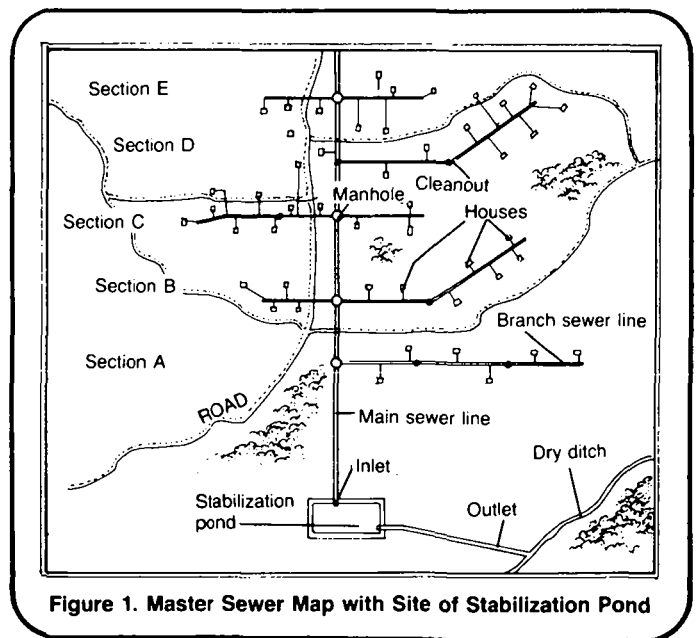


Figure 1. Master Sewer Map with Site of Stabilization Pond

For sewer pipe clean-out and removal of blockage:

(1) 100-300m of flexible steel tape, cable, or jointed sewer rods; (2) an assortment of cleaning and root-cutting attachments; (3) portable, hand-operated winch; (4) 100-300m of

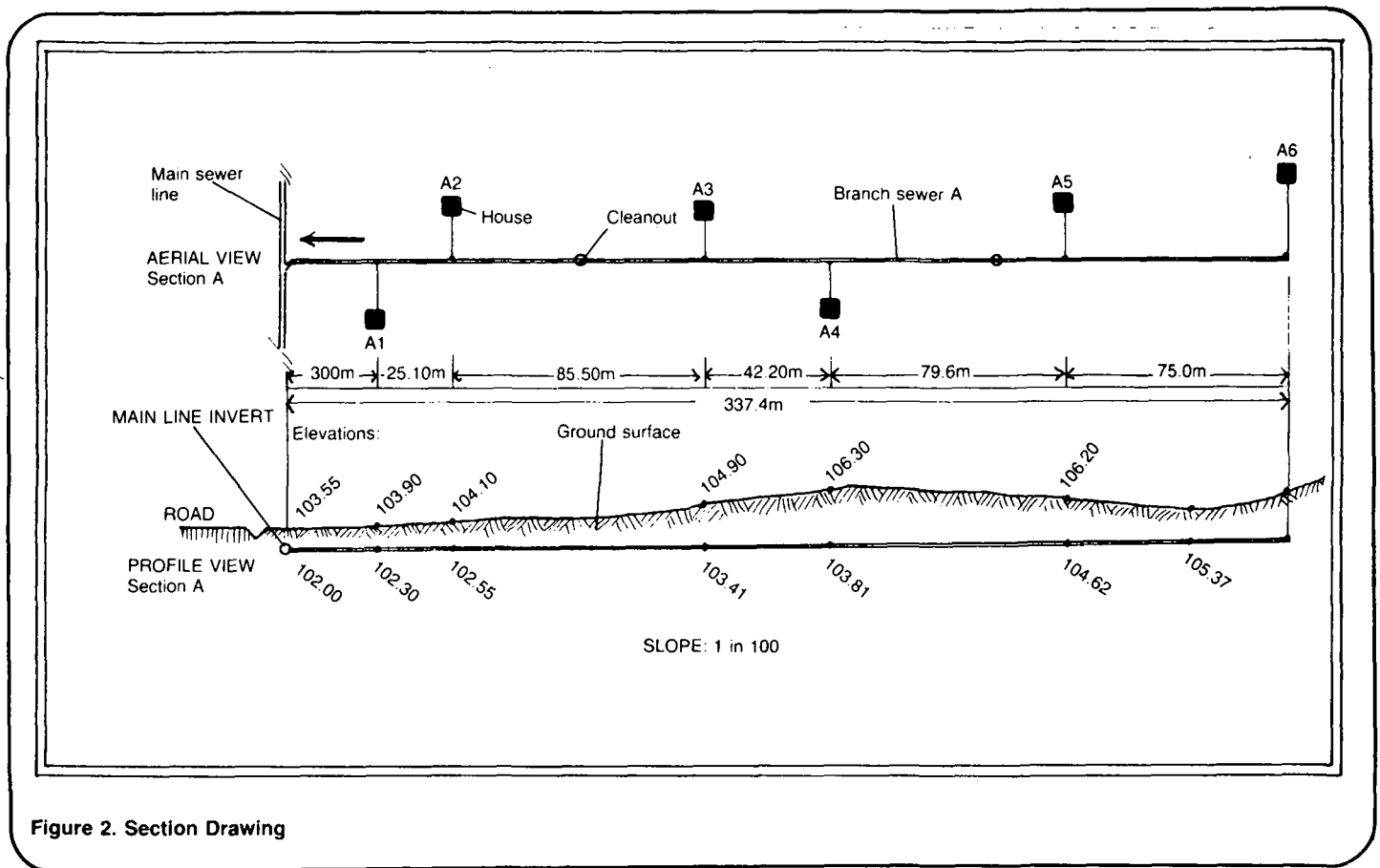


Figure 2. Section Drawing

fire hose if standpipes are available, or if fire protection consists of a portable pump connected to either a water source, a mobile water tank, or barrels.

For sewer pipe repair:

(1) The same materials and tools needed for constructing the system, including sections of sewer pipe, fittings, joint sealer, picks, shovels, sheeting, and braces; (2) protective clothing such as gloves and rubber boots.

### Inspecting the System

In the home. Residents should (and probably will, with very little encouragement) report sewage back-up or slow drains within their homes. If only one house has a problem, the cause is probably either trouble with the septic tank (see "Operating and Maintaining Septic Tanks," SAN.2.0.3), a clogged drain in the house, or blockage in the house lateral. If several adjacent homes have problems, the cause is probably blockage in the branch line or the main line.

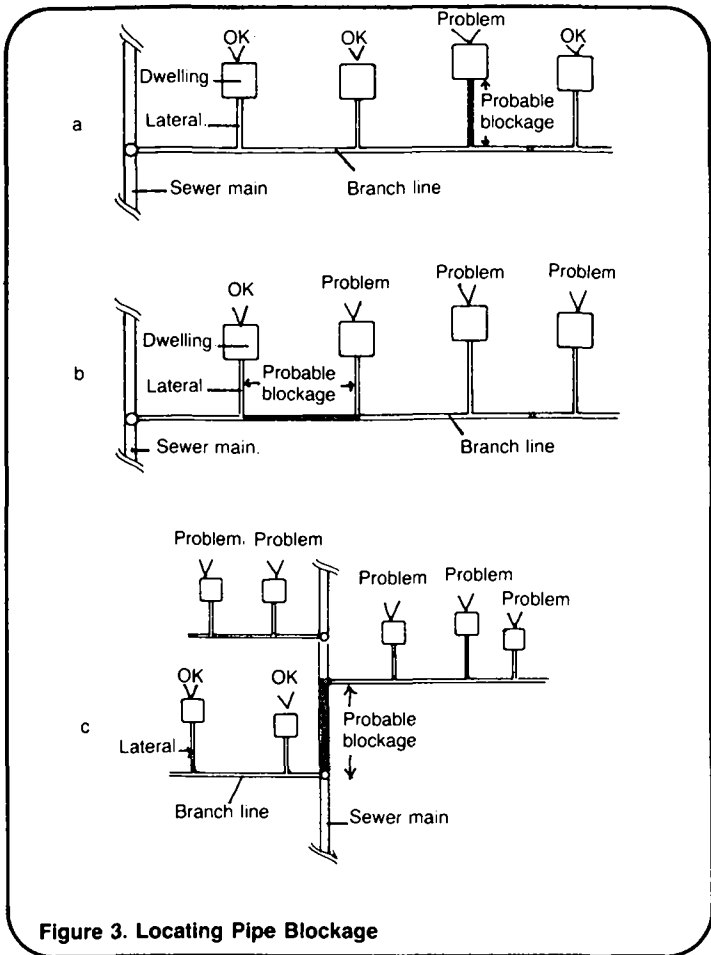
In the field. Make a walking inspection tour of the entire system at least once every few months. Look for ground surface flooding and odors. The cause is probably a break in the sewer line.

When trouble with the system is discovered, take steps to correct it at once.

### Removing Blockage

First determine the approximate location of the blockage. If only one home has a problem, the blockage is probably between the house and the branch line. If several homes have problems, the blockage is probably in the branch line "downstream" from the problem homes. If homes on several branch lines have problems, the blockage is either in several branch lines or in the main line downstream from the branch lines. See Figure 3.

Enter the system through a clean-out port or manhole upstream from the blockage. If neither is available, dig down to the sewer line and make a temporary break in the pipe. Work a



flexible steel tape, steel cable or jointed sewer rods with cutting attachments into the sewer pipe. See Figure 4. Once the blockage has been penetrated or cut, the material will usually flow freely downstream through the system. If it does not, the area of the blockage will have to be excavated as described in the following section.

### Repairing the Sewer

If there is a known break in the sewer line, or if your inspection tour indicates that there is a break, or if a blockage of the line cannot be removed by clean-out equipment, a portion of the sewer line will have to be excavated.

1. Barricade the area to be excavated and instruct all residents upstream to stop using the system until repairs are completed.
2. Excavate the area in question, making the trench as narrow as conveniently possible.

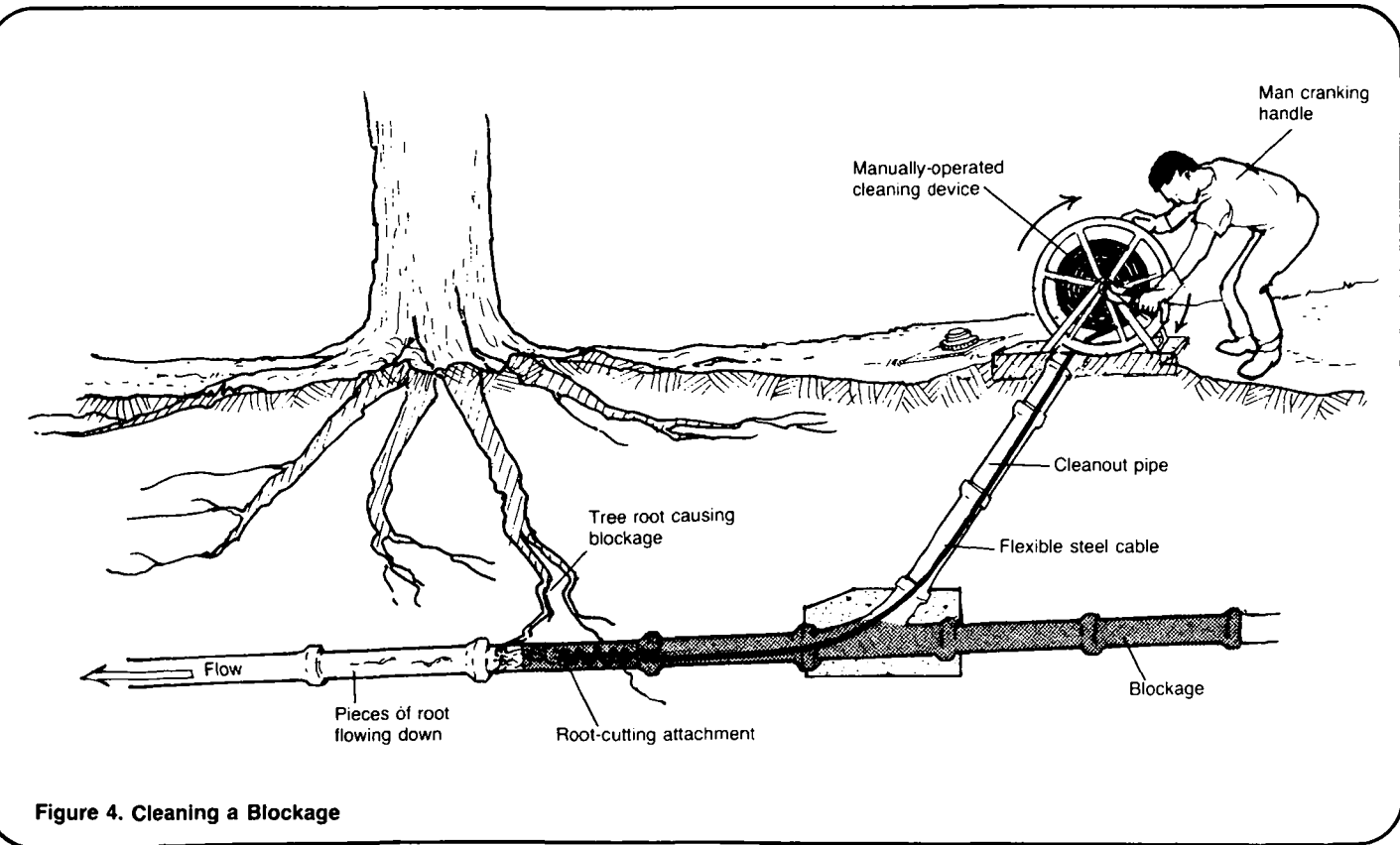


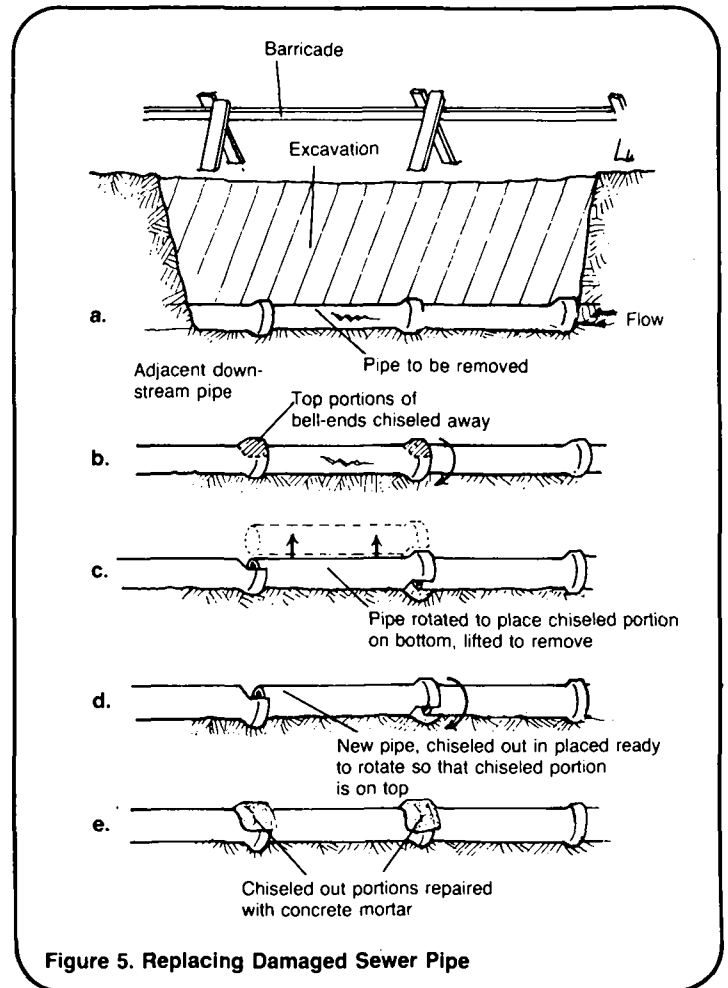
Figure 4. Cleaning a Blockage

3. Shore the sides of the trench with sheeting and braces.

4. Remove the damaged or clogged sewer pipe in the following manner: first chisel out sections of the bell-ends of the pipe to be removed and of the adjacent downstream pipe; second, rotate the pipe to be removed so that the chiseled out section of bell-end is on the bottom; third, lift out the damaged or clogged pipe. See Figure 5.

5. Clean out the clogged pipe and replace it, or set a new pipe in place in the following manner: first, chisel out a section on the bell-end of the new pipe; lower it in place; rotate the new pipe so that the chiseled out portion of the bell is on top; repair the chiseled out bell-ends of the new pipe and the adjacent downstream pipe with cement mortar; and thoroughly seal the joints.

6. Remove sheeting and braces and backfill the trench with soil, carefully but firmly tamping as the trench is filled.



### Caution!

Sewer gas will be present when the system is opened. Allow a few hours for it to air out. Be certain workers in the trench wear safety ropes held by workers outside the trench.

Sewage will be in the pipes. Workers must wear protective boots and gloves and thoroughly wash themselves when the work is complete. Disease-causing organisms may be in fresh, raw sewage.

### Preventive Measures

The following steps can prevent blockage of or damage to sewer pipes:

1. Instruct users not to put cloth, bones, or other material that may clog pipes into the sewer system. Pay particular attention to homes with recurrent problems.

2. If standpipes, fire hoses, and clean-out ports are available, period-

ically flush out the system with water. A portable pump and water tank can be used.

3. Remove trees and large shrubs within 5m of sewer lines to prevent root entry into the system.

4. Closely supervise construction or excavation near the sewer system to avoid damage to pipes.

5. Open and inspect manholes and clean them out every six months. Air out the manholes before entering. Workers entering the manholes should wear safety ropes.

Keep a record similar to Table 1 showing all work done to the sewer system.

Table 1. Sample Maintenance Record

Date	Task
11/7/82	Inspection tour of sections A-E. Okay.
11/8/82	Inspection tour of sections F-J. Okay.
12/1/82	Checked house complaint - slow drain. Inspected septic tank; needs cleaning. Owner will do.
1/9/83	Inspection tour of entire system (sections A-J) Okay.
1/15/83	Checked complaints - 3 neighboring houses section C - 2 slow drains, 1 blocked up. Opened clean-out port C-2;
	used steel cable with rust cutter; flushed with water. Houses Okay.

## Notes

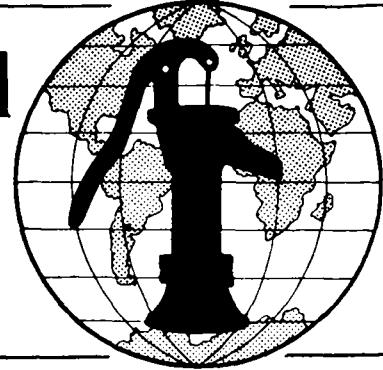
## Notes

## Notes

**Technical Notes** are part of a set of "Water for the World" materials produced under contract to the U.S. Agency for International Development by National Demonstration Water Project, Institute for Rural Water, and National Environmental Health Association. Artwork was done by Redwing Art Service. Technical Notes are intended to provide assistance to a broad range of people with field responsibility for village water supply and sanitation projects in the developing nations. For more detail on the purpose, organization and suggestions for use of Technical Notes, see the introductory Note in the series, titled "Using 'Water for the World' Technical Notes." Other parts of the "Water for the World" series include a comprehensive Program Manual and several Policy Perspectives. Further information on these materials may be obtained from the Development Information Center, Agency for International Development, Washington, D.C., 20523, U.S.A.



# Water for the World



## Operating and Maintaining Stabilization Ponds Technical Note No. SAN. 2.0.5

A stabilization pond is a large shallow excavation that receives sewage from a sewer system, detains the sewage so that biological process can destroy most of the disease-causing organisms, and discharges the effluent as treated sewage. Operating a stabilization pond requires the services of a trained person. Operation and maintenance involves starting up the pond, managing pond surface conditions, maintaining the embankment and the pond site, and possibly, after 10-20 years, draining the pond and removing sludge.

Correct operation and maintenance is important because a neglected stabilization pond will produce foul odors, become a breeding place for flies and mosquitoes, and require costly repairs. This technical note describes how to operate and maintain a stabilization pond.

### Materials Needed

To manage pond surface: small boat and long-handled rakes and, if available, standpipe and water hose or portable pump and water source.

To maintain embankment and pond site: shovels, axes, machetes, grass and weed cutting tools, cart, supply of rocks, wood posts, wire screen, hammer, nails, screen cutter, sections of sewer pipe, mortar. Other: tool shed, warning signs, fencing material, gloves and rubber boots.

### Caution!

Always wear boots and gloves when working around a stabilization pond.

A well-operated and properly maintained stabilization pond usually will not have an odor. It may appear to children and adults as a place to swim or wade. This must be prohibited. Precautions must be taken to keep away unauthorized persons. Post warning signs, or erect fences or barricades.

### Useful Definitions

**ALGAE** - Tiny, green plants usually found floating in surface water; they act on sewage in a stabilization pond and produce oxygen.

**ANAEROBIC POND** - Stabilization pond that receives sewage from a sewer system and discharges sewage effluent to a facultative pond.

**EFFLUENT** - Settled sewage.

**FACULTATIVE POND** - Stabilization pond that receives sewage effluent from an anaerobic pond or sewer system and discharges treated sewage to a dry ditch or maturation pond.

**MATURATION POND** - Stabilization pond that receives treated sewage from a facultative pond, further treats the sewage, and discharges it to a dry ditch or waterway; maturation ponds are sometimes stocked with fish.

**SCUM** - Floating impurities found on top of liquid or bodies of water; especially common in anaerobic ponds.

**SEWAGE** - All washwater, excreta, and water used to flush excreta that flows from a building or buildings through a sewer pipe and into a septic tank, cesspool, or stabilization pond.

**SLUDGE** - Settled solids.

**TREATED SEWAGE** - The liquid that flows out of a stabilization pond or series of ponds. Treated sewage is safer than settled sewage and may be used to irrigate crops not intended for human consumption.

## Starting Up a Pond

If the designed detention time of the pond is more than 10 days, or if only a portion of the total number of dwellings is connected to the sewer system, it may be desirable to temporarily divide the pond in parts. This will allow the bottom of the pond to seal more rapidly and help prevent the growth of weeds.

Build one or two temporary dikes across the width of the pond, dividing it in half or into thirds. Dikes are made from soil and are no higher than about 0.5m. See Figure 1.

filled in a few days and the sewage will spill over the temporary dike and begin sealing the bottom of the second section. After one or more weeks, depending on the size of the pond and the volume of daily flow, the pond will fill with effluent to its design depth.

If more than one pond has been constructed:

1. Close the inlet of the first pond and divert sewage to the second pond, filling it by sections. See Figure 1.

2. Allow the effluent in the pond being filled to "mature" for 10-20

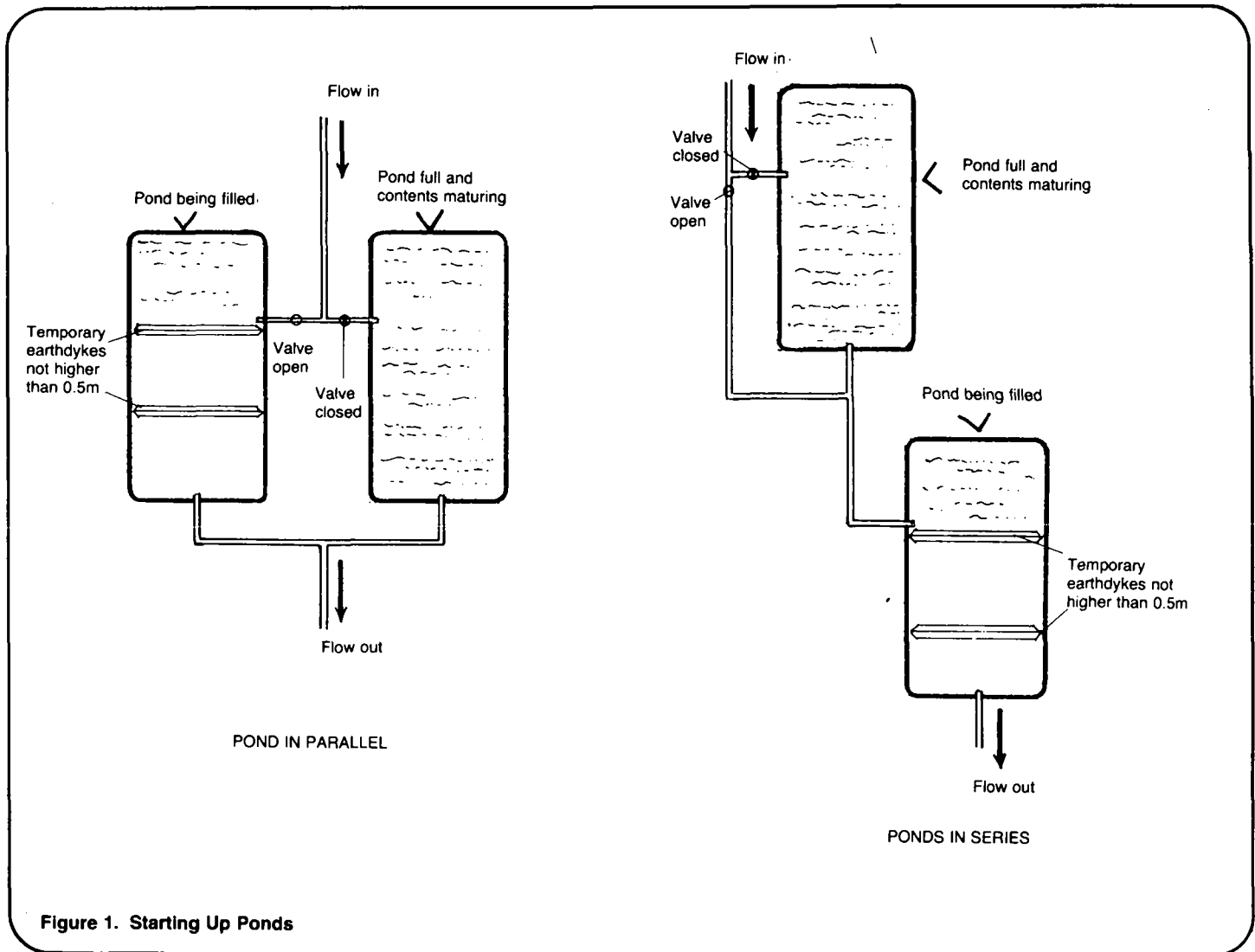


Figure 1. Starting Up Ponds

Allow sewage to enter the pond. Settled solids will soak into and gradually seal the bottom of the first section. The first section will be

days. It will gradually turn a greenish color.

3. Divert the flow of effluent back to the first pond allowing the now treated sewage to be discharged at the

outlet. If the ponds are connected in series, the treated sewage will pass from the first pond to the second, and be discharged from the outlet of the second pond.

If the ponds are connected in parallel:

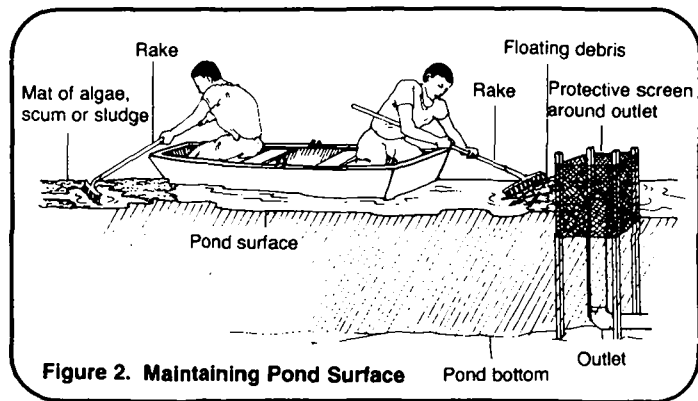
4. Allow the content of the pond being filled to mature for 10-20 days, until it turns a greenish color.

5. Allow sewage to enter both parallel ponds and be discharged by both as treated sewage.

### Managing Pond Surface Conditions

Changes in weather, volume of daily flow, water temperature, and winds can cause undesirable conditions on the pond surface, especially algae growth, scum layers, and sludge mats.

Algae may grow and form floating mats that will block out sunlight and interfere with the efficiency of the pond. Dead algae mats can decay and produce foul odors. Mats should be broken up and dispersed with a jet of water from a water hose or with rakes. If necessary, take a boat onto the surface of the pond to reach the mats. See Figure 2.



Scum layers frequently form on the surface of anaerobic ponds. These will cause foul odors and will encourage insect breeding. Break up scum layers with a water hose or long-handled rakes.

Sludge may rise to the surface of a pond during periods of warm water temperature. These, too, will cause odor problems and should be broken up with a water hose or rakes.

Another surface problem is wind-blown debris, such as leaves. This material can interfere with the pond outlet, and it should be removed from the surface and disposed of outside of the pond.

Table 1 summarizes this information.

Condition	Resulting Problem	Solution
Algae growth	Odors; less efficient pond performance	Break up mats
Scum layer	Odors; insects breeding	Break up mats
Sludge that rises	Severe odors	Break up mats
Floating debris	Interference with outlet	Remove debris

One other surface condition that should be regularly checked is pond color. Each type of pond has a characteristic color, and changes in the color generally signal a problem that should be checked immediately. Table 2 lists the colors of ponds operating in a balanced condition.

Pond Type	Characteristic Color
Anaerobic	Grayish black
Facultative	Green or brownish green
Maturation	Green

Changes in color usually mean a change in the sewage entering the pond. This can be caused by an increased concentration of excreta, rainwater or subsurface water entering the sewer system, or by materials such as oil, chemicals, and animal blood coming in with the sewage. Whatever the cause, it must be found and stopped at once. This may mean making inquiries in the village and inspecting the sewer system as described in "Operating and Maintaining Sewer Systems," SAN.2.0.4. If a government laboratory is available, samples of pond water taken at and below the surface may be examined to find the cause of the pond changes.

## Maintaining Embankment and Pond Site

Make an inspection tour of the embankment and pond site every week or two. Besides surface conditions of the pond already discussed, there are a number of other items that must be checked. See Figure 3. If a problem is found, correct it at once. Table 3 can be used as an aid for regular pond maintenance.

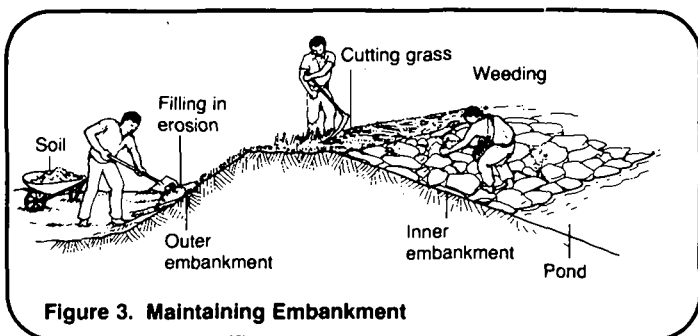


Figure 3. Maintaining Embankment

Table 3. Maintenance Check List

Area Inspected	Condition or Problem	Course of Action
Area surrounding pond site	New trees or bushes	Cut down and remove
Area surrounding pond site	Surface water run-off	Divert away from pond with small dams or trenches
Outside slope and top of embankment	Wind or rain erosion	Fill with soil; plant grass
Outside slope and top of embankment	Long grass or weeds	Mow grass; cut weeds; remove cuttings
Inside slope of embankment	Erosion due to weather or wave action	Replace stones
Shoreline of pond	Weeds	Cut and remove
Outlet of pond	Debris around screen	Remove debris
Surface of pond	Mosquitoes	Consult Health Ministry about spraying with fine grade fuel oil or introducing surface-feeding minnows

## Removing Sludge

During the first years of pond operation, sludge will accumulate on the bottom of the pond. Biological processes will then begin to digest the sludge at about the same rate that it is deposited, generally making further sludge accumulations negligible. However, the sludge depth should be checked once each year. If it is greater than one-third the design pond depth, it will interfere with the natural operation of the pond and may block the inlet pipe. In either case, the pond must be drained and the

sludge removed. How often this occurs depends on local conditions and the type of pond, and is summarized in Table 4.

Table 4. Probable Frequency of Sludge Removal

Pond Type	Frequency of Sludge Removal
Anaerobic	2-12 years
Facultative	8-20 years
Maturation	Probably never

If the community sewer system is connected to only one pond, either another pond, even if temporary, must be built or a temporary alternative means of community sanitation must be used. Effluent from a sewer system must not be allowed to flow into a stream, lake, or dry ditch.

**Checking Sludge Depth.** Once each year, measure the sludge depth near the inlet of the pond. Use a boat and a long wooden pole with about 1m of light-colored cloth wrapped around and tied to the lower end. See Figure 4.

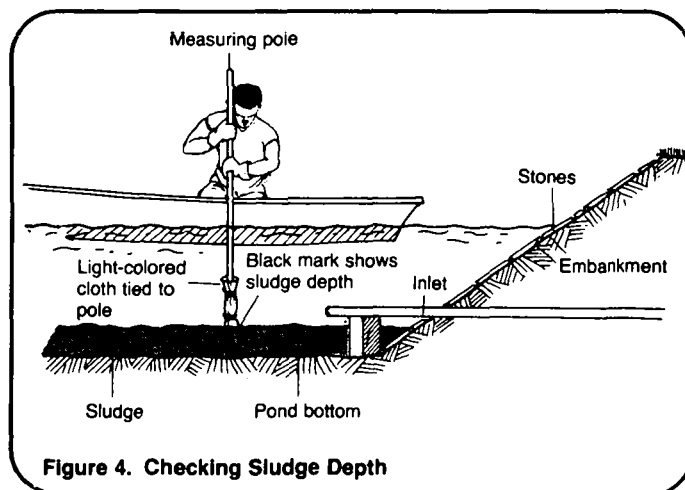


Figure 4. Checking Sludge Depth

Lower the pole to the bottom of the pond and after a minute slowly raise it. Sludge particles will cling to the cloth, and the sludge depth can be measured. If the depth is less than one-third the design depth of the pond, no action need be taken. If the sludge

depth is equal to or greater than one-third the design depth, the pond must be drained and the sludge removed. Do this during the dry season.

Draining the Pond. If the ponds are connected in series, divert the flow of effluent from the pond to be drained to the next lower pond in the series. If the ponds are connected in parallel, divert all sewage from the pond to be drained to the other pond.

To drain the pond, remove the sleeved pipe sections of the vertical outlet one section at a time. This will allow you to lower the surface of the pond in stages until the sludge level is reached.

Removing Sludge. Allow the sludge to dry in the sun. This may take several weeks depending on local conditions. When the sludge is fairly dry, it can be handled with a front-end loader, animal-drawn scoops, or shovels. Load the sludge on trucks or carts and haul it away. See Figure 5. A thin layer of sludge can be left on the bottom of the pond to help begin the biological processes when the pond is put back into operation.

Disposing of Sludge. Dispose of dry sludge in a landfill or other burial site, or use it to fertilize crops, preferably crops not intended for human

consumption. If used for fertilizer, it should be plowed into the ground. Never use sludge to fertilize vegetables which are to be eaten raw, such as lettuce, tomatoes or celery.

Refilling the Pond. While the pond is empty, check the inlet and outlet pipes and protective screen for any damage. Repair at once. Replace the sleeved pipe sections of the vertical outlet.

If the ponds are connected in series, divert the flow of effluent back to the inlet of the empty pond and away from the lower pond in the series. If the ponds are connected in parallel, the second pond probably needs to be emptied and cleaned. Divert the flow of effluent to the empty pond, and allow the second pond to drain. When the second pond has been drained and the sludge removed, divert the effluent so that it flows equally into both ponds.

### Other Considerations

Tools for operating and maintaining a stabilization pond should be kept in a locked shed near the pond site. Clean all tools and keep them in good repair. Maintain a record similar to Table 5 showing all maintenance activities.

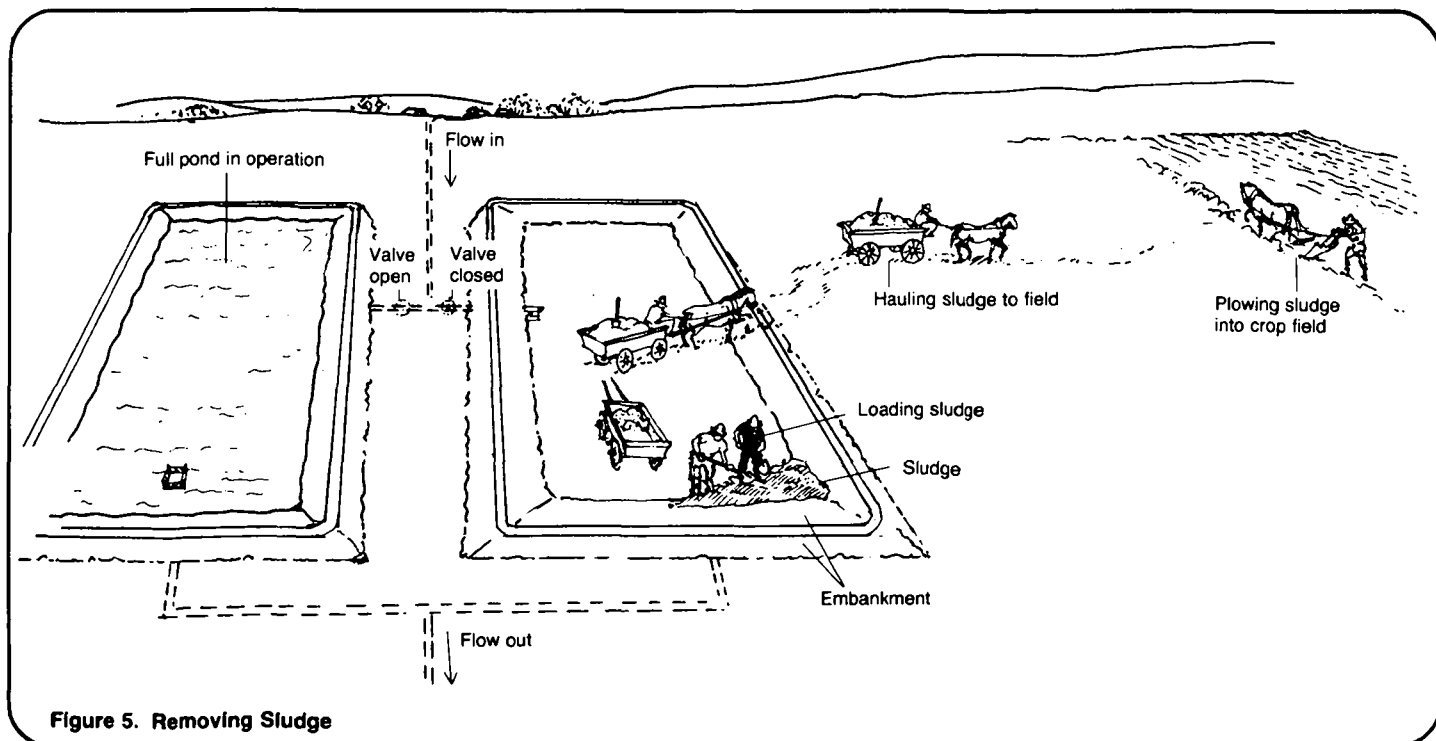


Table 5. Sample Maintenance Record for Stabilization Pond

Date	Task
1 Jan. 82	Cut grass and weeds on embankment, pulled up weeds along shoreline; removed cuttings.
5 Jan. 82	TOOK boat onto pond. Removed leaves from screen around outlet.
1 Feb. 82	Cut grass and weeds on embankment. Removed cuttings.
15 Mar. 82	Cut grass and weeds on embankment. Removed cuttings.
30 Mar. 82	TOOK boat onto pond. Broke up Algae mats.
10 Apr. 82	Took boat onto pond. Checked sludge depth. 150 mm. Okay.
28 Apr. 82	Cut grass and weeds on embankment, pulled up weeds along shoreline, removed cuttings.

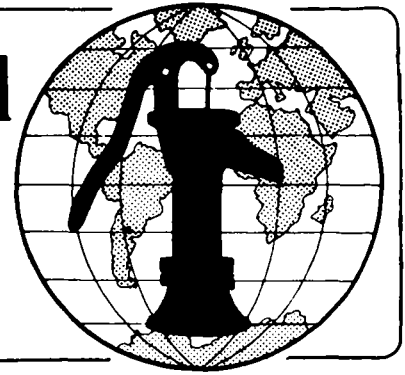
## Notes

## Notes

**Technical Notes** are part of a set of "Water for the World" materials produced under contract to the U.S. Agency for International Development by National Demonstration Water Project, Institute for Rural Water, and National Environmental Health Association. Artwork was done by Redwing Art Service. Technical Notes are intended to provide assistance to a broad range of people with field responsibility for village water supply and sanitation projects in the developing nations. For more detail on the purpose, organization and suggestions for use of Technical Notes, see the introductory Note in the series, titled "Using 'Water for the World' Technical Notes." Other parts of the "Water for the World" series include a comprehensive Program Manual and several Policy Perspectives. Further information on these materials may be obtained from the Development Information Center, Agency for International Development, Washington, D.C., 20523, U.S.A.



# Water for the World



## Operating and Maintaining Mechanically Aerated Lagoons Technical Note No. SAN. 2.0.7

A mechanically aerated lagoon is a large, lined excavation that receives sewage, mixes it with oxygen so that biological processes can destroy most of the disease-causing organisms, and discharges the sewage as treated sewage. Operating and maintaining a mechanically aerated lagoon requires the services of an electrician and a foreman experienced with these systems. Operation and maintenance involves starting up the lagoon, inspecting and repairing aerators, maintaining the embankment and the lagoon site, and possibly, after 10-20 years, draining the ponds and removing sludge.

Correct operation and maintenance is important because a neglected lagoon will produce foul odors, become a breeding place for flies and mosquitoes, and require costly repairs. This technical note describes how to operate and maintain a mechanically aerated lagoon.

### Useful Definitions

**EFFLUENT** - Settled sewage.

**SLUDGE** - Settled solids at the bottom of a lagoon.

**TREATED SEWAGE** - The liquid that flows out of a stabilization pond (or series of ponds). Treated sewage is safer than settled sewage and may be used to irrigate crops not intended for human consumption.

### Caution!

Always wear boots and gloves when working around a mechanically aerated lagoon.

### Materials Needed

To inspect and repair aerators: spare parts for aerators and electrical system; electrician's tools; small boat.

To maintain embankment and pond site: shovels, axes, grass and weed cutting tools, cart, flat rocks, mortar.

Other: maintenance shed, warning signs, fencing materials, gloves and rubber boots.

### Starting Up a Lagoon

1. Allow effluent to fill the lagoon to its design depth.

2. Position the aerators in the following manner:

a) Secure a mooring line to the post on the embankment and to the aerator;

b) Use a boat to maneuver the aerator in place on the surface of the lagoon;

c) Attach the other mooring line to the aerator, take the line across the lagoon, and secure it to the post in the embankment. The mooring lines should be fairly taut, or else they may become fouled in the aerator's propeller during operation. See Figure 1.

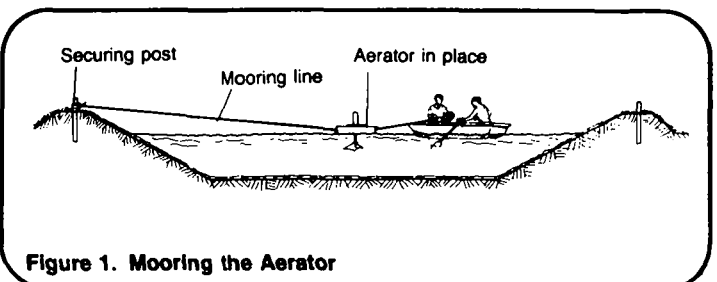


Figure 1. Mooring the Aerator

3. String electric cable from the aerator to the power source on shore. This must be done by an experienced electrician.

4. Switch on the aerators. Depending on their design, some aerators operate continuously, while others are set on timers and operate a few hours each day.

5. Allow treated sewage to be discharged from the lagoon.

### Inspecting and Repairing Aerators

Aerators should be inspected periodically according to manufacturer's instructions. If repairs must be made, remove the aerator from the lagoon. Some lagoon systems keep a replacement aerator in the maintenance shed to be used while repairs are made.

### Maintaining the Embankment and the Lagoon Site

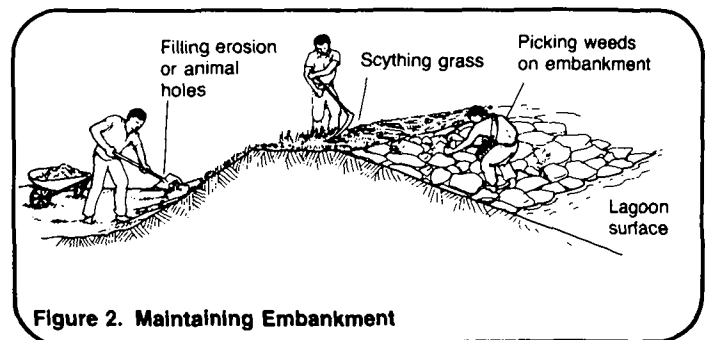
Make an inspection tour of the embankment and lagoon site every few weeks. If a problem is found, correct it at once. See Figure 2. Table 1 can be used as an aid in regular lagoon maintenance.

### Removing Sludge

Because of the efficiency of a well-operated mechanically aerated lagoon, sludge build-up may never be a problem. However, sludge depth should be checked once each year. If the sludge depth rises to one-third the design depth of the lagoon, or to within 50-100mm of the inlet pipe, the lagoon must be drained and the sludge removed. The design depth and the elevation of the inlet pipe should be available from the engineer who designed the project. If the lagoon must be drained, and if the community sewer system is now connected to one lagoon only, either a stabilization pond, even if temporary must be built, or a temporary alternative means of community sanitation must be used. Effluent from a sewer system must not be allowed to flow into a stream, lake, or dry ditch.

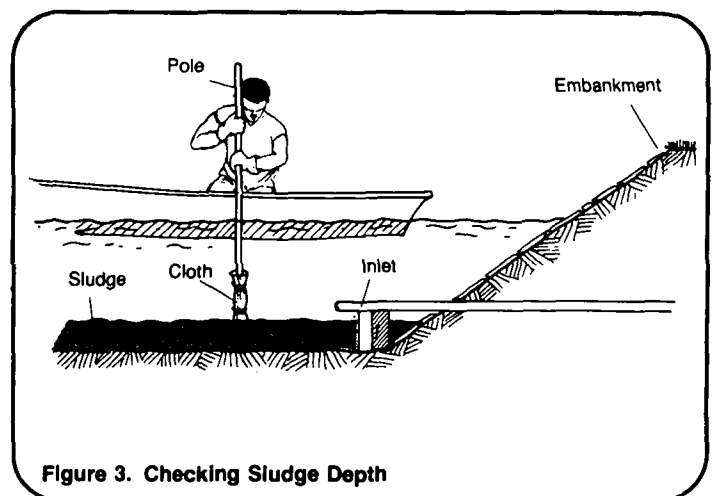
**Table 1. Maintenance Checklist**

Area Inspected	Condition or Problem	Course of Action
Area surrounding lagoon site	New trees or bushes	Cut down and remove
Area surrounding lagoon site	Surface water run-off	Divert water away from lagoon with small dams or trenches
Outside slope and top of embankment	Wind or rain erosion	Fill with soil; plant grass
Outside slope and top of embankment	Long grass or weeds	Mow grass; cut weeds; remove cuttings
Inside slope of embankment	Erosion due to weather or wave action	Replace stones and mortar
Shoreline of lagoon	Weeds	Cut and remove
Corners of lagoon surface	Accumulation of floating debris	Remove debris



**Figure 2. Maintaining Embankment**

Checking Sludge Depth. Switch off the aerators. Use a boat and a long wooden pole with a light-colored cloth wrapped around it and tied to one end. Lower the pole to the bottom of the lagoon and after a minute slowly raise it. See Figure 3. Sludge particles will cling to the cloth and the sludge depth can be measured. If the sludge depth is too high, the lagoon must be drained.



**Figure 3. Checking Sludge Depth**

Draining the Lagoon. Remove the aerators, mooring lines, and electric cables from the lagoon. Allow the effluent to drain into the stabilization pond by removing the sleeved pipe sections of the vertical outlet one section at a time. This allows you to lower the surface of the lagoon in stages, until the sludge level is reached.

Removing Sludge. Allow the sludge to dry in the sun. This may take several weeks, depending on local conditions. When the sludge is fairly dry, it can be handled with a rubber-tired front-end loader, animal-drawn scoops, or shovels. Load the sludge on trucks or carts and haul it away.

Disposing of Sludge. Dispose of sludge in a landfill or other burial site, or use it to fertilize crops, preferably crops not intended for human consumption. If used for fertilizer, it should be plowed into the ground. Never use sludge to fertilize vegetables which are intended to be eaten raw, such as lettuce.

Re-filling the Lagoon. While the lagoon is empty, check the inlet and outlet pipes for any damage. Repair at once. Replace the sleeved pipe sections of the vertical outlet.

Allow the lagoon to fill with effluent to its design depth. Reposition the aerators, mooring lines, and electric cables, and switch on the aerators.

**Other Considerations**

Tools for operating and maintaining an aerated lagoon should be kept in a locked shed near the lagoon site. Clean all tools and keep them in good repair. Maintain a record similar to Table 2 showing all maintenance activities.

**Caution!**

A well-operated and maintained mechanically aerated lagoon will have few odors, and it may appear to children and adults to be a place to swim or wade. Precautions must be taken to keep away unauthorized persons. Post warning signs or erect fences or barricades.

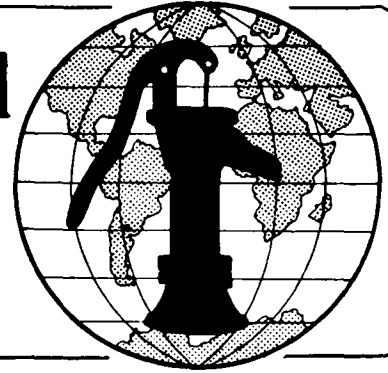
**Table 2. Sample Maintenance Record for a Mechanically Aerated Lagoon**

Date	Task
1 Jan. '82	Cut grass and weeds on embankment; pulled weeds along shoreline; removed cuttings.
15 Feb. '82	Cut grass and weeds on embankment; pulled weeds along shoreline; removed cuttings.
4 Mar. '82	Removed floating debris; took boat onto lagoon; checked mooring lines. Okay.
30 Mar. '82	Cut grass and weeds on embankment; pulled up weeds along shoreline; removed cuttings.
1 Apr. '82	Repaired rocks and mounded on inside embankment slope.

## Notes

**Technical Notes** are part of a set of "Water for the World" materials produced under contract to the U.S. Agency for International Development by National Demonstration Water Project, Institute for Rural Water, and National Environmental Health Association. Artwork was done by Redwing Art Service. Technical Notes are intended to provide assistance to a broad range of people with field responsibility for village water supply and sanitation projects in the developing nations. For more detail on the purpose, organization and suggestions for use of Technical Notes, see the introductory Note in the series, titled "Using 'Water for the World' Technical Notes." Other parts of the "Water for the World" series include a comprehensive Program Manual and several Policy Perspectives. Further information on these materials may be obtained from the Development Information Center, Agency for International Development, Washington, D.C., 20523, U.S.A.

# Water for the World



## Methods of Solid Waste Management Technical Note No. SAN. 3.M

The primary methods of managing solid waste are to collect it near the source and either reuse it, bury it, or find some other means of disposal. These methods reduce the chance of contaminating water supplies and of spreading disease since they prevent rats, flies, and mosquitoes from breeding in solid waste (see "Means of Disease Transmission," DIS.1.M.1). They also remove the physical hazards, odors, and unsightliness of solid waste.

The methods of solid waste management described in this technical note are landfill, composting, and biogas systems. A solid waste collection system must go along with all three management methods. All these methods can be built and operated using locally available materials.

**SPECIAL NOTE:** As a part of their culture, members of the community may already recover and reuse solid waste. Rubbish may be reused for building materials, refashioned into tools or utensils, or burned as fuel for cooking. Garbage may be fed to pigs, chickens, or other domestic animals. Ashes from cooking fires may be used in the operation of pit privies. See "Operating and Maintaining Privies," SAN.1.0.1. These practices, where they pose no health hazard, should be continued and encouraged.

## Collection

Collection means gathering solid waste from its source--house, yard or marketplace--and transporting it for reuse or disposal to a compost pile, biogas plant or landfill. All systems of solid waste management require a method of collection. The method depends on the system of waste management and should be compatible with it.

## Useful Definitions

**BIOLOGICAL** - Relating to living organisms.

**COMPOST** - A dark, fairly dry, crumbly, odorless material that can be used to improve soil for crops; it can be produced by stacking garbage, animal manure, and straw in piles or windrows.

**CONTAMINATE** - To make unclean by introducing an infectious (disease-causing) impurity such as leachate or bacteria from animal manure.

**GARBAGE** - Food and crop wastes from growing, harvesting, storing, preparing, cooking or serving of food; these materials rot quite quickly.

**GROUNDWATER LEVEL** - The level to which subsurface water rises during any given time of year.

**LEACHATE** - A liquid formed when rain, surface water, or ground water passes through a landfill and accumulates dissolved and suspended matter and organic wastes; leachate can contaminate water supplies.

**RUBBISH** - All materials other than garbage that is thrown away, including broken dishes, utensils, and furniture; useless scraps of wood, metal, or glass; sweepings from house, yard, or street; and anything else that is discarded.

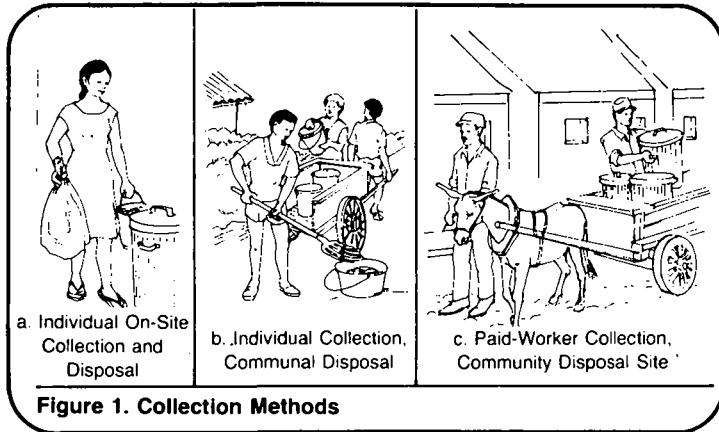
**SOLID WASTE** - Garbage, rubbish, animal manure, dead animals, and ashes.

Three basic types of collection are:

1. Household members collect their own solid waste in shovels, buckets, baskets, or other containers and carry it to an on-lot landfill, compost pile, or biogas plant.

2. Members of a number of households gather their own solid waste and carry or cart it to a communal landfill or composting area.

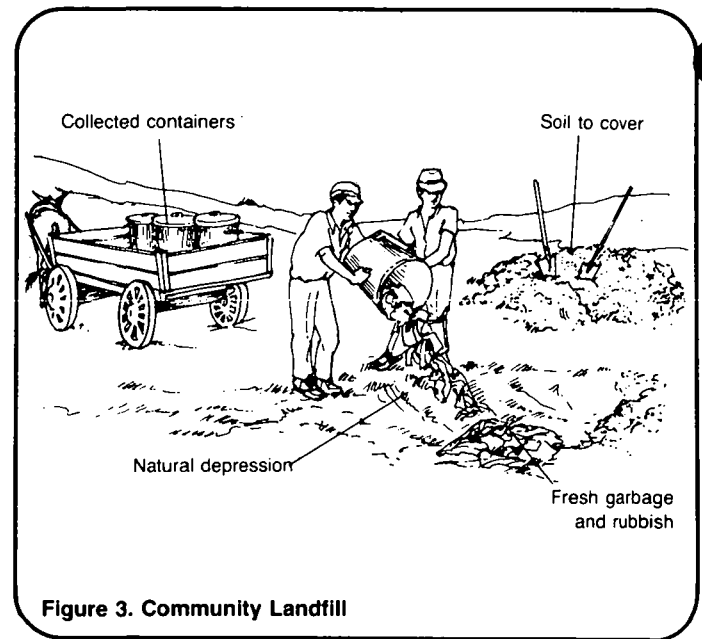
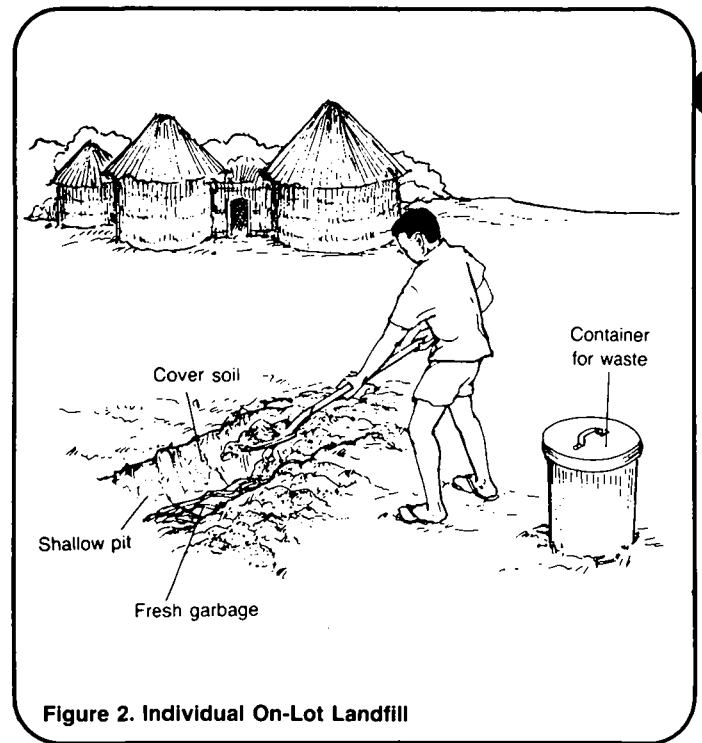
3. Household members, marketplace vendors, factory workers, and shopkeepers dispose of solid waste in barrels, baskets, or other containers and paid workers collect the containers and cart them to a community site, usually a landfill. See Figure 1.



Two factors important to all types of collection are care and cleanliness. Care must be taken when handling solid wastes to prevent cuts from sharp-edged scraps and to prevent injuries from lifting heavy objects and containers. Cleanliness is important to prevent the spread of disease. Workers and household members must wash their hands after handling solid wastes, especially before preparing or eating food.

### Landfill

A landfill is a burial site for solid waste. It can serve a single household or an entire community, and it usually begins as a trench, shallow pit, or natural depression in the ground. Solid waste is transported to the site, dumped in the trench, pit, or depression, compacted and covered daily with soil. The soil keeps away rats, flies, and mosquitoes, prevents children from playing in the waste, and eliminates odors and unsightliness. See Figures 2 and 3.

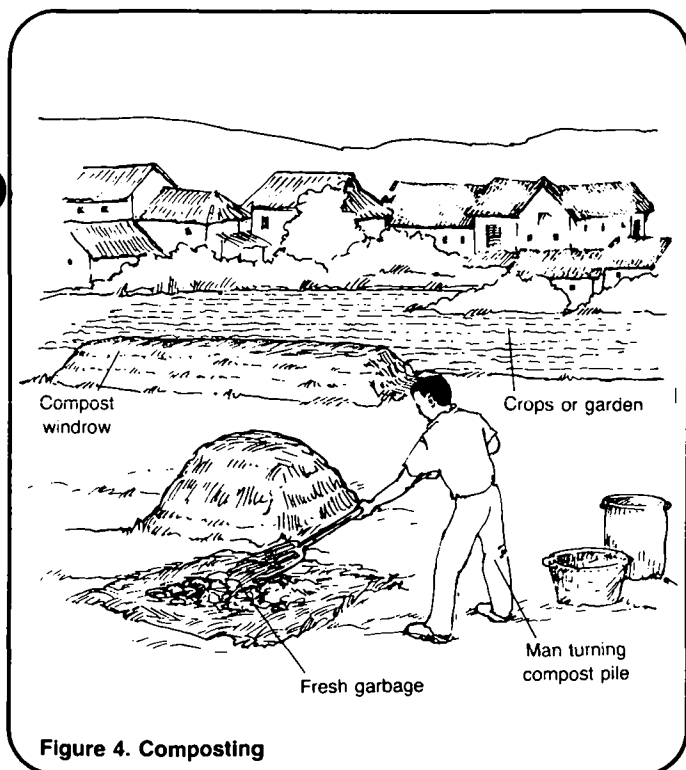


The bottom of a landfill must be no closer than 1.0m above the highest groundwater level to prevent contamination from leachate. Landfills for large communities may require mechanized equipment to transport, compact, and cover solid waste.

## Composting

These systems can serve individual households or groups of households. The two major requirements are a supply of animal manure and garbage and a use for composted material.

Animal manure, garbage, straw, dead leaves, and grass clippings are placed in a pile or windrow (an elongated pile). Rubbish must not be placed in the pile. The pile is usually covered with a mixture of manure and soil to prevent rainwater from soaking in, to retain moisture, heat, and odors, and to keep out flies. Depending on the contents, the pile is turned twice a week to provide oxygen for the composting process. The turning kills fly eggs before they can hatch. See Figure 4.

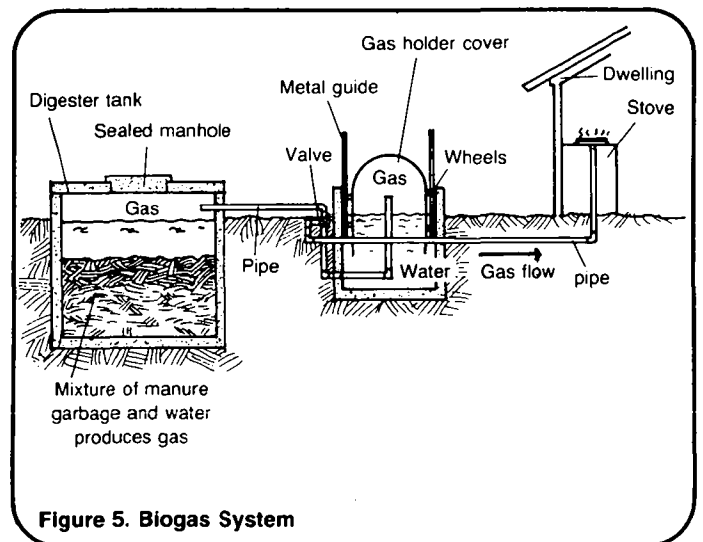


The material in the pile becomes food for aerobic biological processes which produce compost after a number of weeks depending on the contents and the climate. The finished compost is then spread in gardens or fields and worked into the soil to fertilize crops.

## Biogas System

The main components of a biogas system are one or more digester tanks and a gas holder. In some designs, the tank and holder are a single unit.

The system is operated when animal manure, bedding straw or hay, garbage and water are sealed in the digester and become subject to biological processes which produce, among other things, methane gas. The gas flows through pipes regulated by valves from the digester to the gas holder and then to the kitchen in a household, where it is burned as fuel for cooking. When the contents of the digester have completed their transformation, the remaining material is removed and used to fertilize crops. See Figure 5.



The digester tank and the bottom and walls of the gas holder are usually made from reinforced concrete. The cover of the gas holder is made from sheet iron and, because of its strict design specifications, is either purchased as a prefabricated unit or made in the community by skilled craftsmen. Gas pipes and valves must be purchased.

These systems may be especially appropriate in communities which presently burn animal manure for fuel because of the system's more efficient utilization of manure.

## Comparison of Methods

Table 1 summarizes three methods of solid waste management. Collection is not included in the table because it is required for all three methods and must be compatible with the method used. The

methods are listed across the top of the chart and the factors to be compared are listed down the left-hand side. The table can be used as an aid in selecting a method. See "Planning Solid Waste Management Systems," SAN.3.P.

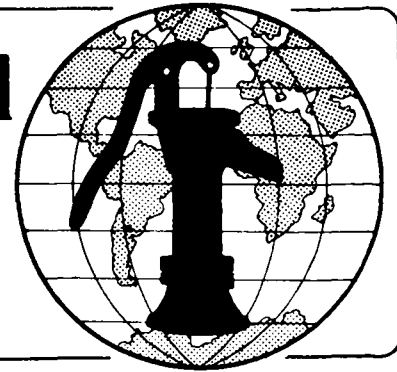
**Table 1. Comparison of Solid Waste Management Methods**

Factor	SOLID WASTE MANAGEMENT METHOD		
	Landfill	Compost	Biogas
Type of waste managed	All	Garbage; animal manure	Garbage; animal manure
Requirements	Acceptable site; cover soil	Supply of garbage and manure; use for compost	Reinforced concrete construction; special metal cover, gas pipes, valves; supply of animal manure; use for methane gas and fertilizer
Operation	Solid waste is placed in depression, trench, or pit and covered with soil	Manure, garbage, and straw are stacked in piles or windrows and periodically turned; compost is spread on crop land	Manure, garbage and water sealed in tank; gas flow regulated; gas burned in household; digested contents of tank removed and spread on crop land
Cost	Inexpensive	Inexpensive	Moderate to expensive
Advantages	Disposes of all solid waste; helps prevent breeding of rats and flies; improves low-lying land by filling	Provides excellent soil conditioner; helps prevent breeding of flies	Provides gas for fuel; provides fertilizer; helps prevent breeding of flies
Disadvantages	May produce leachate, which may contaminate ground water	Does not provide rubbish disposal	Does not provide rubbish disposal; initial cost may be high

**Technical Notes** are part of a set of "Water for the World" materials produced under contract to the U.S. Agency for International Development by National Demonstration Water Project, Institute for Rural Water, and National Environmental Health Association. Artwork was done by Redwing Art Service. Technical Notes are intended to provide assistance to a broad range of people with field responsibility for village water supply and sanitation projects in the developing nations. For more detail on the purpose, organization and suggestions for use of Technical Notes, see the introductory Note in the series, titled "Using 'Water for the World' Technical Notes." Other parts of the "Water for the World" series include a comprehensive Program Manual and several Policy Perspectives. Further information on these materials may be obtained from the Development Information Center, Agency for International Development, Washington, D.C., 20523, U.S.A.



# Water for the World



## Planning Solid Waste Management Systems Technical Note No. SAN. 3.P

Solid waste management systems may be needed where quantities of garbage, rubbish, or animal manure are found near a dwelling, school, marketplace, slaughterhouse, refinery, or other public building. Managing solid wastes is important because wastes are a breeding place for rats, flies, and mosquitoes which can transmit disease to humans. See "Means of Disease Transmission," DIS.1.M.1. In addition, unmanaged solid wastes can be physically hazardous, odorous, and unsightly. The purpose of planning a solid waste management system is to determine its suitability and specific nature.

Planning solid waste management systems involves setting goals, then establishing step-by-step procedures toward those goals. There are eight major actions involved in project development for which planning is important. It is necessary to: (1) recognize the problem, (2) organize community support and set objectives, (3) collect data, (4) formulate alternatives, (5) select the most suitable method, (6) establish the system, (7) operate and maintain the system, and (8) evaluate the system.

This technical note discusses planning and implementation of these eight activities. Read the entire technical note before beginning the planning process. Worksheet A may be adapted for use in cataloging information collected as planning proceeds.

### 1. Recognize the Problem

This is done by gathering information from national and regional governments, questioning villagers and village leaders, and observing actual conditions in the field. Decide if

solid wastes pose a health hazard to people in the community. In general, the community should consider planning solid waste management systems if the answer is "yes" to any of the following questions.

Yes/No	Is there garbage, including agricultural wastes, near the dwelling?
Yes/No	Is there animal manure near the dwelling?
Yes/No	Is there garbage in or near the marketplace?
Yes/No	Is there garbage or rubbish near a public building, school, clinic, sugar cane refinery, slaughterhouse, or shops?
Yes/No	Are there bothersome numbers of flies, rats, mosquitoes or cockroaches?

When the problem has been identified and there is improper or non-existent management of solid wastes, then objectives can be set to solve the problem.

### 2. Organize Community Support and Set Objectives

The main objective is to establish an effective system of solid waste management. This is a major step toward improving the health of the people in the community and establishes a pattern of greater cleanliness for the community.

The most important step is organizing community support. See "Community Participation in Implementing Water Supply and Sanitation Programs," HR.2.I. Establish close working relations with

community leaders and organizers. Actively solicit their ideas and suggestions. The people in the community should be actively involved from the start of the project, because they must understand and accept all stages of the project.

Another step is setting secondary objectives, such as a time span for establishing the system, for example, three months or one year. Secondary objectives should be set with the participation and agreement of the community leaders. Be realistic when setting objectives. Consider local customs and resources such as money, material, and talent. Do not set objectives that may be impossible for the community to reach. Set objectives that are definite and can be measured, so the people will know when they have reached them. For example: establish on-site composting systems for ten families within three months; or, provide an effective solid waste management system for the community's marketplace within one year.

Your objectives must: (1) clearly state what the project will accomplish, (2) state the methods that will be used, and (3) specify when these accomplishments will be made. At the end of the specified length of time, it should be possible to determine whether your objectives have been met.

When the objectives have been set, proceed with the next step in planning: data collection.

### 3. Collect Data

To plan the system you must have correct information and data. The data can be divided roughly into six categories: (A) environmental conditions in the village, (B) nature of the solid waste, (C) present methods of solid waste management, (D) attitude of the people, (E) resources, and (F) geography. Collecting data will be an ongoing process; some of it will be used now, some later.

Make written records of all data collected. Some data will be specific (for example: quantity of garbage generated daily by the community marketplace). Other data will be more

general (for example: villagers' attitudes toward new methods of solid waste management). Use the following checklist to help organize data collection.

#### A. Environmental Conditions in the Village

- 1. Determine the incidence of disease associated with poor sanitation (see "Means of Disease Transmission," DIS.1.M.1) by personal observation, questioning villagers and village leaders, and checking health records which may be available from local health clinics.
- 2. Observe and record evidence of garbage or rubbish in or near the village.
- 3. Determine whether solid waste is being disposed of in or near sources of drinking water. Do this by questioning villagers and by personal observation.
- 4. Determine whether there are bothersome numbers of rats, flies, mosquitoes or cockroaches.
- 5. Determine whether there are foul odors.

#### B. Nature of Solid Waste

- 1. Observe and record the sources of solid waste generation such as dwellings and marketplaces.
- 2. Observe and record the type of waste from each source such as animal manure, garbage, and rubbish.
- 3. Observe and record approximate daily or weekly quantities of each type of waste generated from each source.

#### C. Present Methods of Solid Waste Management

- 1. Record evidence of salvage and reuse of solid waste.

**Worksheet A. Planning a Solid Waste Management Project**

1. Problems indicating a need for action are:

- (1) \_\_\_\_\_
- (2) \_\_\_\_\_
- (3) \_\_\_\_\_

2. Community support will be organized and directed by (name and position):

- (1) \_\_\_\_\_
- (2) \_\_\_\_\_
- (3) \_\_\_\_\_

2a. Major objectives of the program are:

- (1) \_\_\_\_\_
- (2) \_\_\_\_\_
- (3) \_\_\_\_\_

3. Data which will influence decisions are:

- (1) Need: \_\_\_\_\_
- (2) Present Methods: \_\_\_\_\_
- (3) Community Acceptance: \_\_\_\_\_
- (4) Resources: \_\_\_\_\_
- (5) Geography: \_\_\_\_\_

4. Alternatives to be considered are:

- (1) \_\_\_\_\_
- (2) \_\_\_\_\_
- (3) \_\_\_\_\_

5. The method(s) selected is (are):

- (1) \_\_\_\_\_
- (2) \_\_\_\_\_
- (3) \_\_\_\_\_

6. The system will be established by:

- (1) Ensuring public acceptance by building demonstration models or by: \_\_\_\_\_
- (2) Submitting plans to (government or lending agency): \_\_\_\_\_
- (3) Obtaining financing from (government, lending agency, or other): \_\_\_\_\_
- (4) Planning the construction within \_\_\_\_\_ weeks.
- (5) Constructing the system within \_\_\_\_\_ months.

7. The operation and maintenance of the system will be supervised by (name and position):

- (1) \_\_\_\_\_
- (2) \_\_\_\_\_
- (3) \_\_\_\_\_

8. The system will be evaluated during (month and year) \_\_\_\_\_, by (name and position):

- (1) \_\_\_\_\_
- (2) \_\_\_\_\_
- (3) \_\_\_\_\_

2. Record evidence of compost systems.

3. Record evidence of garbage used as animal feed.

4. Record evidence of salvage and reuse of bottles, cans, lumber and metal.

5. Determine and record how solid waste is presently transported from source of generation to area of reuse or disposal.

#### D. Attitude of the People

1. Question villagers and village leaders about their attitudes toward solid waste management in general.

2. Question villagers and village leaders about their preferences concerning specific methods of solid waste management.

3. Identify local customs and taboos.

#### E. Resources

1. List sources of money, such as government grants, taxes, general funds, and so on, and amounts available.

2. List types and quantities of available materials, tools, equipment, and vehicles.

3. List the names and special skills of available skilled workers.

4. List the names of available unskilled workers.

#### F. Geography

1. Record the type, number and location of all drinking water supplies, such as wells, springs, streams, and piped systems.

2. Determine and record ground water levels for the wettest season.

3. Obtain or produce a map of the village and surrounding area, including all roads, lots, dwellings, buildings, agricultural fields, unused land, streams, and ponds.

4. Determine the direction of prevailing winds.

#### 4. Formulate Alternatives

Use the collected data and the information in "Methods of Solid Waste Management," SAN.3.M, to formulate alternative systems that will solve the problem of solid waste management. Each system may be a single method or a combination of several methods. When formulating alternatives, use only those methods which may be appropriate or practical for your particular community and which are basically acceptable to the members of the community. Reject those methods which for any reason are inappropriate, impractical, or unacceptable.

The remaining alternatives are possible solutions to the problem. To determine the best method for your situation, proceed to the next step: selecting a method.

#### 5. Select a Method

When selecting a method of solid waste management, study the features of each alternative carefully and analyze the collected data thoroughly. The decision on which method to select should be based on the following considerations:

Need. Are present methods of solid waste management inadequate? Do people in the community suffer from diseases caused by poor sanitation? Are large quantities of solid waste being generated? Are the roads, paths and yards unsightly? Are there flies, mosquitoes, cockroaches or rats breeding?

Social acceptability. This is a most important consideration, for if the system is unacceptable to the people, it will surely fail. Will the method of solid waste management violate local customs, taboos, or preferences? Is the method likely to be continually operated and maintained? Have the people indicated that they prefer this system, or at least are willing to try it?

Resources. Can the desired method be put into operation considering available money, materials, vehicles, and workers?

Possibility for re-use. Is there a use for animal feed, compost, or biogas?

Use the comparison chart in "Methods of Solid Waste Management," SAN.3.M, and Table 1 to help in your selection of a method of solid waste management. The decision table is not meant to be followed strictly; it is merely an aid in selecting a system. If you need more specific information on the features of any method, consult the technical notes dealing with that particular method.

## 6. Establish the System

There are three steps in establishing the system: involving the public, submitting your plan for approval, and planning for construction and operation.

Involving the Public. The first step in establishing the system is gaining public acceptance. Set up community meetings to fully explain the proposed system. This is especially important for those systems, such as collection of garbage from a marketplace, which requires continued community cooperation and participation in order to succeed. It may be worthwhile to operate small-scale or individual solid waste management

methods for demonstration. These demonstration models can serve to educate members of the community and serve as a final test of community acceptance before larger scale operations are attempted.

Submitting Plan for Approval. The second step in establishing the system is submitting your plan to the regional or national government or lending agency. Since you may need approval of the entire plan before you can proceed, your submission should include: (a) the proposed technical system, (b) costs, (c) sources of finance, and (d) an implementation schedule.

a. Proposed system. Submit design drawings of the method or methods selected. Decide how many methods will be operated and where they will be located. Show them on a detailed map of the village and surrounding area. Bring village leaders, or others who speak for the community, to help explain the need for the project.

b. Costs. Determine how much money will be needed to pay for workers, materials, equipment, and vehicles. Make every effort to use locally available resources. Estimate how much money will be required to operate the system for one year.

c. Sources of finance. Funds may be available locally, nationally, or internationally. Your government can explain how to get national or international funds which may be in the form of grants or loans. Local funds can come from taxes, user fees, or a general fund. Local funds may take the form of a cooperative effort rather than money. For example, instead of paying a worker to haul rubbish and garbage to a disposal site, members of the village could haul their own solid waste to the designated site and cover it with soil.

d. Implementaiton schedule. Assign specific and reasonable time spans to each stage of the project. Allow time to collect data, formulate alternatives, select a method, establish the system, and train workers to operate and maintain the system. To help visualize an entire project and establish timetables for it, draw a chart similar to Figure 1, which indicates the month number across the top

**Table 1. Decision Table for Selecting a Method of Solid Waste Management**

If	And	And	Then
Solid waste consists of garbage and is a problem	Hogs are kept		Feed to hogs
	No hogs are kept	A use for compost	Compost
		No use for compost	Landfill
Solid waste consists of animal manure and is a problem	A use for compost		Compost
	No use for compost	A use for biogas and availability of needed materials and equipment	Biogas
		No use or equipment	Landfill
Solid waste consists of rubbish and is a problem	Able to reuse		Salvage
	Not able to reuse		Landfill

and the specific tasks on the left side. Figure 1 includes tasks performed from the start of the project--recognizing problems, consulting with villagers, and early collection of data.

Planning for Construction and Operation. The third step in establishing the system is planning for construction and operation. Only biogas systems require difficult construction. Landfills and composting require preparing sites.

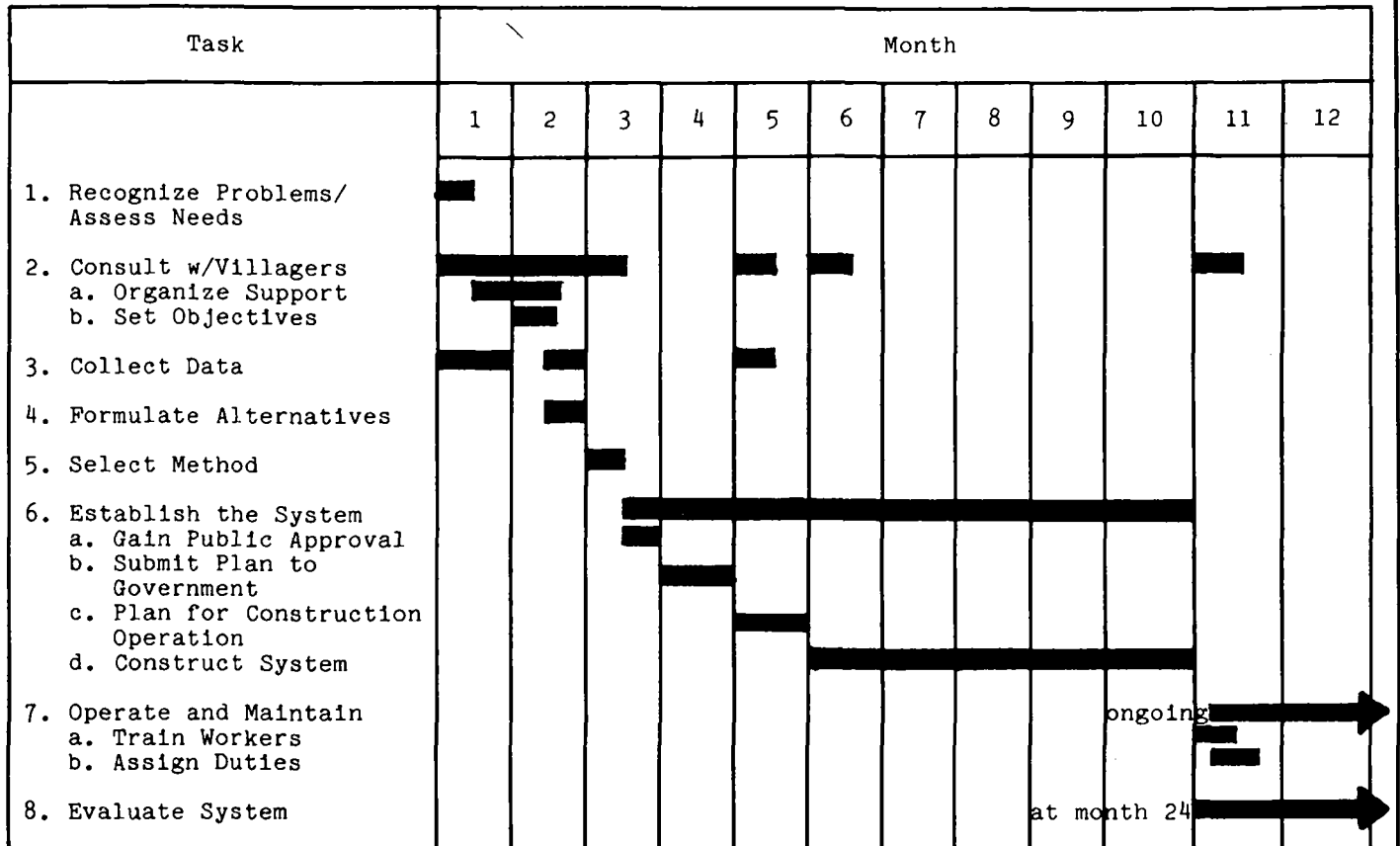
Determine which components of the system can be constructed in the community, perhaps the biogas digester, and which components will have to be purchased from outside the community, perhaps the pipes and valves. Determine who will perform the construction, how much they will be paid, and which tools, equipment, and materials they will need. Organize the construction. That is, be prepared to assign specific duties, set up time schedules, and hire a foreman to oversee the work.

### How To Use the Decision Table

1. Find the statement in the "If" column that best describes your situation. More than one statement may apply.
2. Follow the arrows to the adjacent boxes in the first "And" column and select the statement that best fits your situation.
3. Follow the arrows to the adjacent boxes in the second "And" column and select the statement that best fits your situation.
4. Follow the arrow to the adjacent box in the "Then" column to find the recommended method of solid waste management.

Determine if the system will be operated by individual owners, for example, on-lot compost or biogas systems, by the community as a whole, for example, a community landfill, or

## Scheduling a Solid Waste Management Project



**Figure 1. Sample Time Chart**

by paid workers, for example, collection and disposal of solid wastes from a marketplace or factory. Determine which tools, equipment, and vehicles are necessary for operation and be prepared to assemble them. Organize the operation by assigning specific duties, setting up time schedules, and, if necessary, hiring a foreman to oversee the work. For a public collection system, a route and frequency plan must be devised. It can be modified as experience dictates.

### 7. Operate and Maintain the System

Plan for the continued use of the systems after they are initially put into operation. This includes using compost, maintaining soil cover at landfills, and inspecting and repairing biogas systems.

Establish a system of routine inspections of the solid waste management systems, and of cleaning and repairing tools, equipment, and vehicles. If these systems are not

continually maintained, they will fail to operate.

### 8. Evaluate the System

Evaluate the project one year after completion to determine whether project objectives have been achieved. Determine the success of the project by: (1) questioning villagers about their use or neglect of the systems; (2) comparing before and after health aspects; (3) comparing conditions in the community with conditions existing before the project began. Determine if the old problems have been eliminated, and decide if any new problems have arisen. Perhaps the community now needs and can afford a more advanced system of solid waste management such as collection and disposal of solid wastes by paid workers rather than community volunteers.

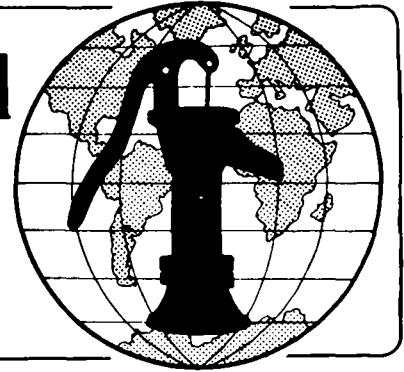
Sanitary improvements in rural villages are usually made one step at a time. Therefore, your evaluation of this project should be the first step in planning the next sanitation improvement.

## Notes

**Technical Notes** are part of a set of "Water for the World" materials produced under contract to the U.S. Agency for International Development by National Demonstration Water Project, Institute for Rural Water, and National Environmental Health Association. Artwork was done by Redwing Art Service. Technical Notes are intended to provide assistance to a broad range of people with field responsibility for village water supply and sanitation projects in the developing nations. For more detail on the purpose, organization and suggestions for use of Technical Notes, see the introductory Note in the series, titled "Using 'Water for the World' Technical Notes." Other parts of the "Water for the World" series include a comprehensive Program Manual and several Policy Perspectives. Further information on these materials may be obtained from the Development Information Center, Agency for International Development, Washington, D.C., 20523, U.S.A.



# Water for the World



## Designing a Landfill Technical Note No. SAN. 3.D.1

A landfill is a means of disposing of solid waste by burying it. Designing a landfill involves calculating the amount of waste to be disposed of, determining the type of landfill, selecting a site, selecting a method of landfilling, calculating the required area of the landfill, and determining personnel and equipment required for operation. The products of the design process are: (1) a location map, (2) design drawings of the landfill, and (3) a detailed materials list. These products will be given to the construction supervisor prior to operation.

This technical note describes how to design a landfill and arrive at the essential end-products. Read the entire technical note before beginning the design process.

### Calculating Waste Generation

The amount of waste to be disposed of will indicate the type of landfill to be designed and its size. The waste amount for at least five years should be calculated and the landfill designed for that length of time. The amount of waste in cubic meters equals the daily generation of waste in liters times 365 days per year, times five or more years, times a compaction factor of 0.5, divided by 1000 liters per cubic meter. The 0.5 compaction factor is an estimate of the natural shrinkage or reduction in volume that occurs to solid waste in a landfill over a period of months. This can be doubled by manual compaction or tripled by compaction with vehicles or sleds.

For example, suppose a household disposes of approximately 5 liters of solid waste per day. Then the amount of waste disposed of in five years equals  $(5 \text{ liters}) \times (365 \text{ days/year}) \times (5 \text{ years}) \times (0.5) = 4.56\text{m}^3$   
 $\frac{\quad}{1000 \text{ liters/m}^3}$

### Materials Needed

Measuring tape - To obtain accurate field information for a location map.

Ruler - To draw a location map.

### Useful Definitions

**CONTAMINATE** - To make unclean by introducing an infectious (disease-causing) substance such as leachate or bacteria from animal manure.

**GARBAGE** - Food and crop wastes from growing, harvesting, storing, preparing, cooking, or serving of food; these materials rot quite quickly.

**GROUNDWATER LEVEL** - The level to which subsurface water rises during any given time of year.

**LEACHATE** - A liquid formed when rain, surface water, or ground water passes through a landfill and accumulates dissolved and suspended matter and organic wastes; leachate can contaminate water supplies.

**RUBBISH** - All materials other than garbage that is thrown away, including broken dishes, utensils, and furniture; useless scraps of wood, metal, or glass, sweepings from house, yard, or street; and anything else that is discarded.

**SOLID WASTE** - Garbage, rubbish, animal manure, dead animals, and ashes.

A landfill serving that one family must be designed to contain  $4.56\text{m}^3$ . See Worksheet A, Lines 1-4.

## Worksheet A. Calculating Amount of Solid Waste and Size of Landfill

### Household Solid Waste

1. Daily amount of solid waste per household = 5 liters
2. Lifetime of landfill = 5 years
3. Compaction factor = 0.5
4. Total amount of waste =  $\frac{\text{Line 1} \times 365 \text{ days/year} \times \text{Line 2} \times \text{Line 3}}{1000 \text{ liters/cubic meter}}$   

$$\frac{(5 \text{ liters/day}) \times (365 \text{ days/year}) \times (5 \text{ years}) \times 0.5}{1000 \text{ liters/m}^3} = 4.56 \text{ m}^3$$

### Community Solid Waste

5. Daily amount of solid waste from marketplace (or total number of households) = 400 liters
6. Lifetime of landfill = 5 years
7. Compaction factor = 0.5
8. Total amount of waste =  $\frac{\text{Line 5} \times 365 \text{ days/year} \times \text{Line 6} \times \text{Line 7}}{1000 \text{ liters/cubic meter}}$   

$$\frac{(400 \text{ liters/day}) \times (365 \text{ days/year}) \times (5 \text{ years}) \times 0.5}{1000 \text{ liters/m}^3} = 365 \text{ m}^3$$

### Size of Trench

9. Depth of trench = 0.6 m
10. Area of trench =  $\frac{\text{Line 4}}{\text{Line 9}} = \frac{(4.56 \text{ m}^3)}{(0.6 \text{ m})} = 7.6 \text{ m}^2$
11. Width of trench = 1.0 m
12. Length of trench =  $\frac{\text{Line 10}}{\text{Line 11}} = \frac{(7.6 \text{ m}^2)}{(1.0 \text{ m})} = 7.6 \text{ m}$

### Size of Area Landfill or Mound Landfill

13. Depth of depression or height of mound = 2.0 m
14. Area of landfill =  $\frac{\text{Line 8}}{\text{Line 13}} = \frac{(365 \text{ m}^3)}{(2.0 \text{ m})} = 182.5 \text{ m}^2$
15. Width of landfill = 10.0 m
16. Length of landfill =  $\frac{\text{Line 14}}{\text{Line 15}} = \frac{(182.5 \text{ m}^2)}{(10.0 \text{ m})} = 18.25 \text{ m}$

Another example: suppose a community marketplace must dispose of approximately 400 liters of garbage each day. Then the amount disposed of in five years equals (400 liters) x (365 days/year) x (5 years) =  $\frac{730000 \text{ liters}}{1000 \text{ liters/m}^3} = 730 \text{ m}^3$

A landfill serving the marketplace must be designed to contain at least 365m<sup>3</sup>. See Worksheet A, Lines 5-8. This figure will be reduced by manual or mechanical compaction before the waste is covered with soil.

## Determining Type of Landfill

The three basic types of landfills are: (1) on-lot landfills for household use, (2) community landfills used and operated by a number of households, and (3) community landfills operated by paid workers. The type of landfill selected is a matter of judgment rather than computation. The selection depends on the amount of solid waste generated, the available area on the lot, and the economics of the community. In general, Table 1 can be used to determine the type of landfill.

**Table 1. Landfill Factors**

Landfill Type	Determining Factors
On-lot; household use	Small amounts of waste; suitable on-lot site
Community; operated by householders	Larger amounts of waste or no suitable on-lot site
Community; operated by paid workers	Large amounts of waste and money to pay workers

## Selecting a Site

The site for a landfill must meet the following requirements:

**Distance.** A landfill must be far enough from wells and streams to protect water supplies from contamination, far enough from dwellings to prevent causing a nuisance, and close enough to the source of the waste to avoid excessive hauling.

An on-lot landfill should be:

at least 30m, preferably downhill, from wells and streams, 20-200m from the household.

A community landfill should be:

at least 200m, preferably downhill, from wells and streams, at least 200m from the nearest dwelling, no more than 30 minutes travel from the source of waste (2-15 kilometers, depending on the method of transportation; see "Designing a Solid Waste Collection System," SAN.3.D.3).

**Geography.** A landfill should not be located on valuable land such as crop land. It should not be located on creviced rock because of the danger of groundwater contamination, or on marshy or wet ground because of the probable production of foul odors. Try to locate the landfill downwind from dwellings. It should be near a road for easy access.

**Ground Water.** The bottom of the landfill must be at least 1.0m above the highest groundwater levels. Information on groundwater levels may be available from local residents, water well owners, or water well drillers. If not, a test hole 1.0m deeper than the bottom of the proposed landfill must be dug during the wettest season. If no ground water is observed in the hole, the site is suitable.

**Cover soil.** The landfill must be located on or near ground which is easily excavated in order to provide adequate cover material. Loamy soils, sandy loams, and permeable clay mixtures are good. Heavy, non-permeable clays are hard to work and crack when dry surfaces are exposed.

**Area.** The site must be large enough to accommodate the landfill. The area required depends on the amount of waste and the method of landfilling. See the section on "Calculating the Size."

**Ownership.** If a community landfill located on privately-owned land is being designed, written permission to use the land must be obtained from the owner. The agreement should specify the number of years of use, limits on future use and responsibility for maintenance.

If any of these requirements are not met, another site must be found. This may require hauling wastes greater distances. When a suitable site has been located, draw a map similar to Figure 1 showing the site in relation to dwellings, water wells, streams, roads, and so on, and indicating ground slope and prevailing wind direction. Give the map to the construction supervisor.

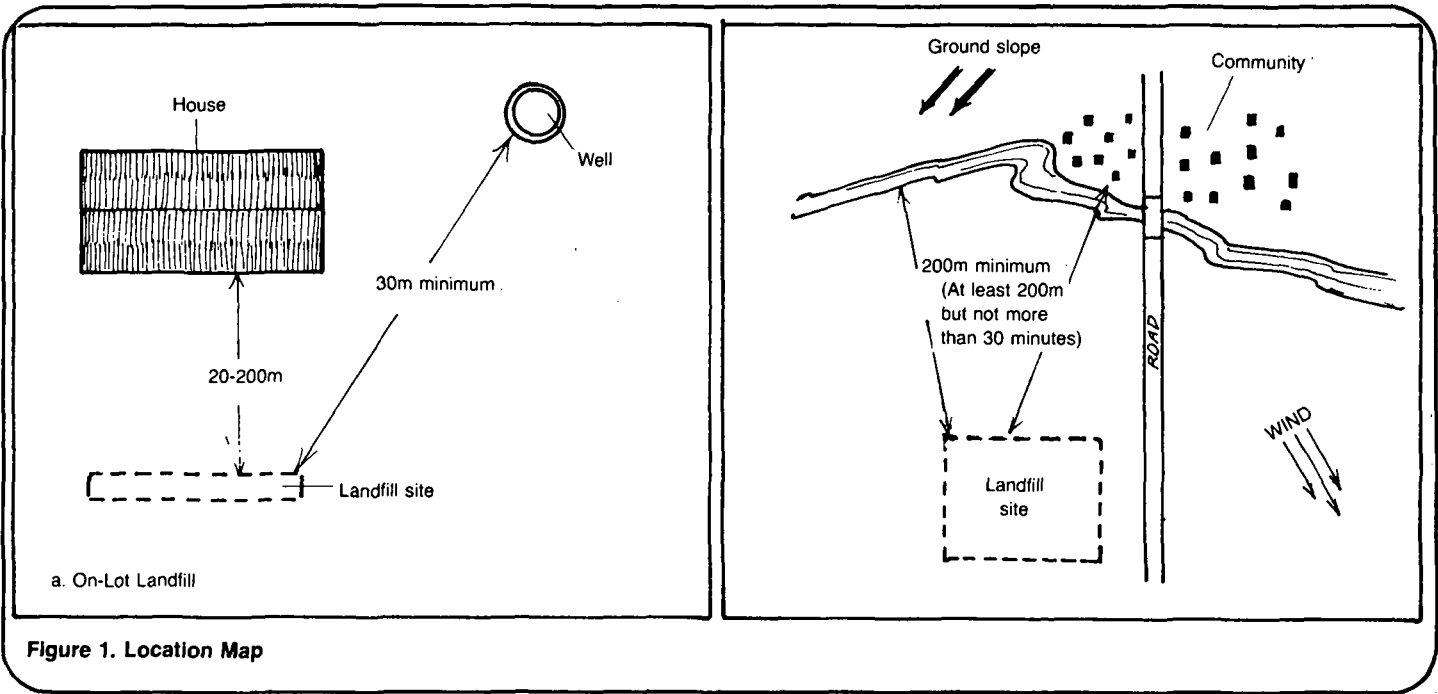


Figure 1. Location Map

### Selecting the Method of Landfilling

The three basic methods of landfilling are: (1) trench method, (2) area method, and (3) mound method.

The trench method involves excavating a trench, placing solid waste in the excavation, compacting it, and covering the waste with the excavated soil. Generally, only a portion of the trench is dug and filled with waste each day or week. The size of the trench will vary depending on the amount of waste to be disposed of and the equipment used for excavation. Trenches are generally 0.5-2.5m wide, 0.5-1.5m deep, and up to 100m long. The trench method is used where the ground is fairly flat or gently sloped and the soil on the site is easily excavated. See Figure 2.

soil. Cover soil can be hauled from off-site or scraped from the bottom of the depression before waste material is placed in it. Although there are no design limitations to this type of landfill, waste is placed in strips or layers no higher than 1.0m. Each strip or layer may be composed of smaller sections called cells. See Figure 3.

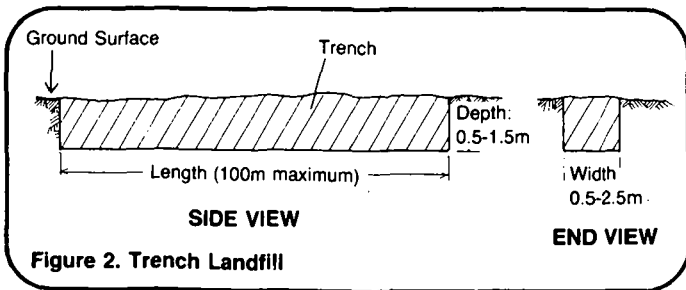


Figure 2. Trench Landfill

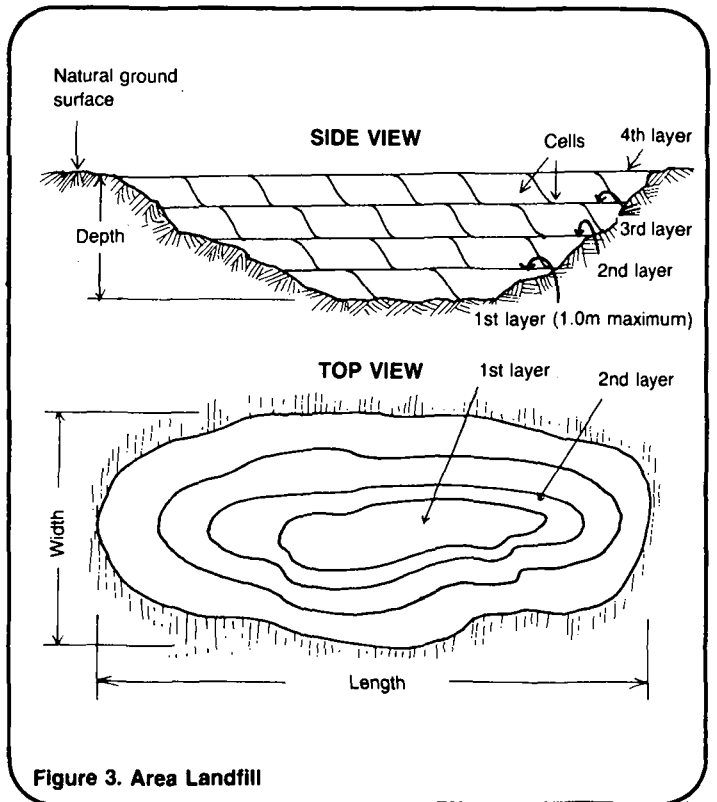


Figure 3. Area Landfill

The area method involves raising a natural depression or low area by placing solid waste in the depression, compacting it, and covering it with

The mound method involves placing solid waste in strips or layers no higher than 1.0m on top of relatively flat, hard ground and covering it with soil hauled from off-site. This method is generally used in areas difficult to excavate. There is no design limitation on landfill size. See Figure 4.

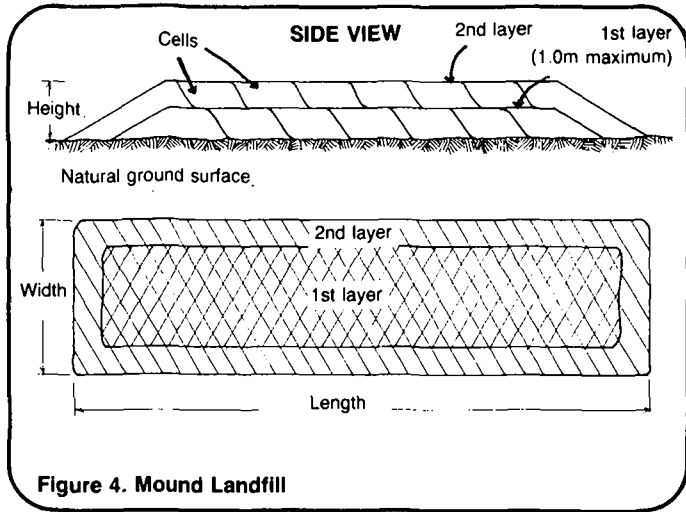


Figure 4. Mound Landfill

Table 2 indicates which landfilling method may be most suitable for certain site conditions.

Landfill Method	Site Conditions
Trench	Fairly flat or gently sloped; easily excavated
Area	Natural depression or low area; cover soil on-site or within suitable hauling distance
Mound	Relatively flat, high ground water and difficult to excavate; cover soil within suitable hauling distance

### Calculating the Size

The area required for a landfill equals the amount of solid waste to be disposed of over a certain period of time, perhaps five years, divided by the depth or height of the completed fill.

For example, suppose the five year accumulation of solid waste for a household, taking into account the minimum 0.5 compaction factor, is calculated to be  $4.56\text{m}^3$ , and that a trench method is selected with a trench depth of 0.6m. Then the area required equals  $4.56\text{m}^3$  divided by  $0.6\text{m} = \frac{4.56\text{m}^3}{0.6\text{m}} = 7.6\text{m}^2$ . The length of the trench equals the area divided by the width. If the width is 1.0m, the length equals  $\frac{7.6\text{m}^2}{1.0\text{m}} = 7.6\text{m}$ . Therefore,

the household could dispose of its solid waste for five years in a trench 1.0m wide, 0.6m deep, and 7.6m long. See Worksheet A, Lines 9-12. Compaction will increase the useful life of the trench by one-third to one-half.

Another example: suppose a community marketplace or a number of households must dispose of  $365\text{m}^3$  of solid waste over the next five years, and the method of disposal is filling a natural depression 2.0m deep or building a mound 2.0m high. The area required equals  $365\text{m}^3$  divided by 2.0m, or  $\frac{365\text{m}^3}{2.0\text{m}} = 182.5\text{m}^2$ . The finished landfill will cover at least  $182.5\text{m}^2$ . There are a number of configurations that meet this requirement: a rectangular landfill 10.0m wide and 18.25m long, or a square landfill 13.5m on each side. See Worksheet A, Lines 13-16. Again, compaction will reduce the size of landfill needed.

When the type, method, and size of the landfill have been determined, make drawings similar to one or more of Figures 2, 3, and 4 showing the shape and dimensions of the landfill. Give the drawings to the construction supervisor.

### Determining Equipment and Personnel

The equipment and personnel needed to operate a landfill depend on the size of the operation, the ease with which cover soil can be excavated, and the work habits of the community. There is no specific means to calculate these factors. An on-lot landfill may require only a shovel and someone to dig. A community landfill, whether operated by household members or paid workers, may require a number of

shovels, or animal-drawn plows or scoops, or even mechanized equipment with skilled operators. Some provision should be made for manual or mechanical compaction. In all cases, locally available equipment should be used. The type and quantity of equipment will depend on local conditions.

For a community landfill operated by paid workers, a foreman and workers must be hired, and a system of regular payment must be established. The methods used for hiring and paying workers should conform to practice in the community.

When the necessary equipment and personnel have been determined, draw up a materials list similar to Table 3 and give it to the construction supervisor.

In summary, give the construction supervisor a location map similar to Figure 1, one or more drawings similar to Figures 2, 3, and 4, and a detailed materials list similar to Table 3.

**Table 3. Sample Materials List**

Item	Description	Quantity	Estimated Cost
Labor	Foreman (for 5 years)	1	---
	Workers (for 5 years)	4	---
Equipment	Tape measure	---	---
	Animal-drawn plow or scoop	---	---
	Animal-drawn cart to transport cover soil	---	---
	Animals	---	---
	Shovels	---	---
	Rakes	---	---
	First-aid kit	---	---
	Boots	--- pairs	---
	Gloves	--- pairs	---
	Vehicle with tires, sled or paddles for compaction	---	---

Total Estimated Cost = ---

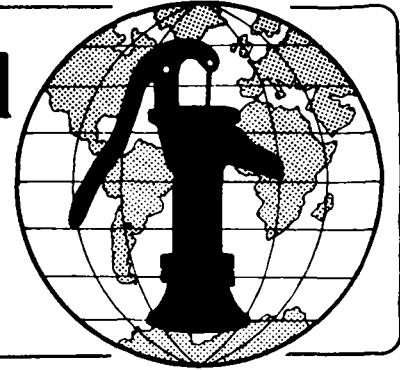
## Notes

## Notes

**Technical Notes** are part of a set of "Water for the World" materials produced under contract to the U.S. Agency for International Development by National Demonstration Water Project, Institute for Rural Water, and National Environmental Health Association. Artwork was done by Redwing Art Service. Technical Notes are intended to provide assistance to a broad range of people with field responsibility for village water supply and sanitation projects in the developing nations. For more detail on the purpose, organization and suggestions for use of Technical Notes, see the introductory Note in the series, titled "Using 'Water for the World' Technical Notes." Other parts of the "Water for the World" series include a comprehensive Program Manual and several Policy Perspectives. Further information on these materials may be obtained from the Development Information Center, Agency for International Development, Washington, D.C., 20523, U.S.A.



# Water for the World



## Designing a Composting System Technical Note No. SAN. 3.D.2

A composting system is a means of turning garbage, animal manure, other organic wastes, and, in some cases, excreta, into compost. Designing a composting system involves determining the method of composting, selecting a location, deciding on the configuration of the system, and determining the labor and tools needed to operate the system. The products of the design process are: (1) a location map, (2) design drawings of the compost pile, and (3) a detailed materials list. These products will be given to the construction supervisor prior to operation of the system.

This technical note describes how to design a composting system and arrive at the essential end-products. Read the entire technical note before beginning the design process.

### Useful Definitions

**COMPOST** - A dark, fairly dry, crumbly, odorless material that can be used to improve soil for crops; it is produced from organic wastes.

**EXCRETA** - Human body wastes.

**GARBAGE** - Food and crop wastes from growing, harvesting, storing, preparing, cooking, or serving of food; these materials rot quite quickly.

**ORGANIC** - Derived from living organisms.

### Materials Needed

Measuring tape - To obtain field information for a location map.

Ruler - To draw a location map.

### General

Composting is the natural process by which organic material is fed on and broken down by soil bacteria and fungi to form compost. This process requires a balance between two types of organic materials. The first type includes dry vegetable matter such as street sweepings, straw, cane stalks, pea vines, potato tops, banana stems, dead leaves, wood chips and paper. The second type includes excreta, animal manure, fresh food scraps, and septic tanks or aqua privy sludge. The correct proportion of each type depends on a variety of factors and is best judged by mixing the materials in the field. Inorganic materials such as metal, glass, plastic, rocks, gravel, and sand and some organic material such as tree branches and large pieces of wood will not readily decompose and must be separated out.

When compost is added to the soil, it increases the soil's porosity, increases moisture retention, lightens heavy soils such as clay, improves the texture of light sandy soils, facilitates the growth of plant root systems, and adds trace elements required by plants. Compost contains about one percent each of nitrogen, phosphorous, and potassium. Composting is an aerobic process that requires oxygen from the air for good and rapid action.

### Determining the Method of Composting

There are three basic methods of composting: (1) household, (2) community, and (3) paid-worker.

**Household.** This is suitable for small amounts of waste and on-lot use of compost. Organic waste material from a single farm or household is processed into compost, and the compost is worked into crop land or the garden by members of the household.

**Community.** This is suitable for larger amounts of waste and community use of compost. Organic waste from a number of households, farms or an entire village is processed by a composting system operated by members of the community. The compost is used by several households or farms. To function properly, this method requires unfailing cooperation among members of the community and a fixed work procedure that is strictly followed.

3. If it is a community composting system, the site should be no more than one kilometer from the community.

4. The site should be on relatively level ground with enough drainage to prevent pools of water from forming.

5. It should be downwind from dwellings in case the pile becomes anaerobic.

6. There should be water available at the site.

### Estimating the Size of the Site

The size of the composting system, whether for a household or community, depends on the nature and amount of the organic wastes being composted, on the rate and season at which they are produced, and on the climate of the region. These factors vary greatly from place to place, and the true size of the site can only be found by operating the system. However, a rough estimate can be made in the beginning by allowing 10m<sup>2</sup> for every person served by the system.

For example, a household with five members should allow:

$$5 \times 10\text{m}^2 = 50\text{m}^2$$

A village of 1000 persons should allow:

$$1000 \times 10\text{m}^2 = 10000\text{m}^2$$

When the site has been selected, draw a location map similar to Figure 1 showing the size of the site and the distance to dwellings and crop land. Give the map to the construction supervisor.

### Determining the Configuration of the System

The two basic configurations of composting systems are stacks and windrows. For either method, leave ample space for turning the piles to aerate them. Some provision must be made for disposing of materials that cannot be composted. The best option is to bury them at the compost site.

**Table 1. Factors Influencing Composting Methods**

Method	Factor
Household	Small amounts of organic waste; on-lot use of compost
Community	Larger amounts of waste; community use of compost; community cooperation
Paid-worker	Larger amounts of waste; community use of compost; money to pay workers

**Paid-worker.** This is suitable for larger amounts of waste and community use of compost. Workers are paid to operate a large composting system, and the compost is either sold or given to community members. This method requires money to pay workers.

Table 1 summarizes the factors that influence the selection of a method of composting.

All methods of composting require a system for collecting the organic material and transporting it to the composting site. The system of collecting should be compatible with the method of composting. See "Designing a Solid Waste Collection System," SAN.3.D.3. If excreta from bucket latrines is to be composted, see "Designing Bucket Latrines," SAN.1.D.5.

### Selecting a Location

The site for the composting system should meet the following conditions:

1. It must be large enough for the system. See "Estimating the Size of the Site."

2. It should be near the crops or garden on which the compost will be used.

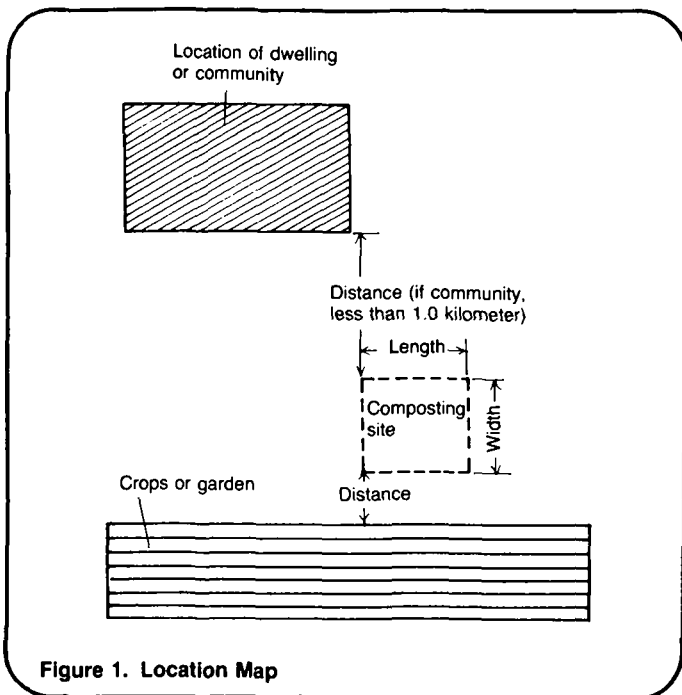


Figure 1. Location Map

Stacks are 1.8-2.4m<sup>2</sup> at the base, 1.2-1.5m high, and rounded at the top. See Figure 2. One or more stacks may be used depending on the amount of material to be composted. For large systems, stacks are laid out in units of four stacks each with a roadway between each unit as shown in Figure 3. Stacks are appropriate for both household and community composting systems. They should be used if excreta or sludge is part of the composted material.

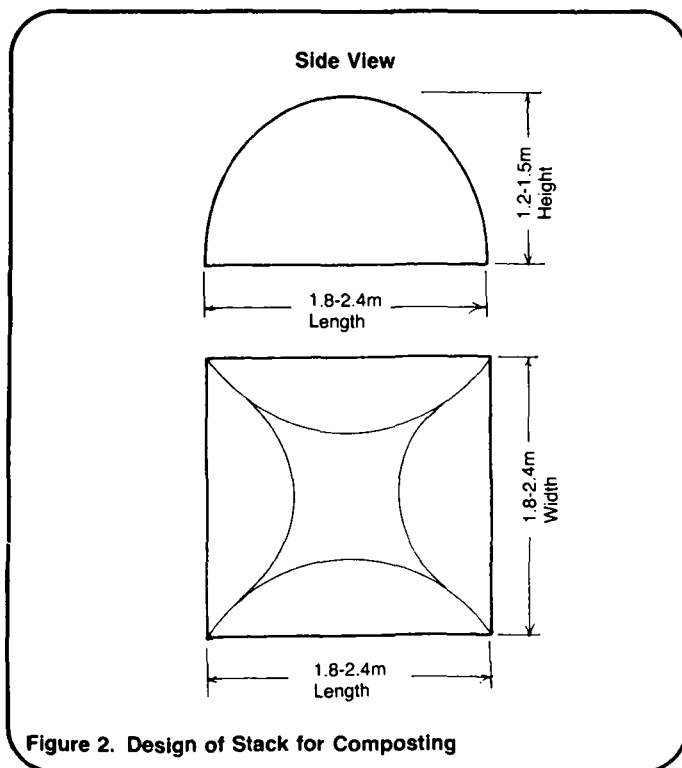


Figure 2. Design of Stack for Composting

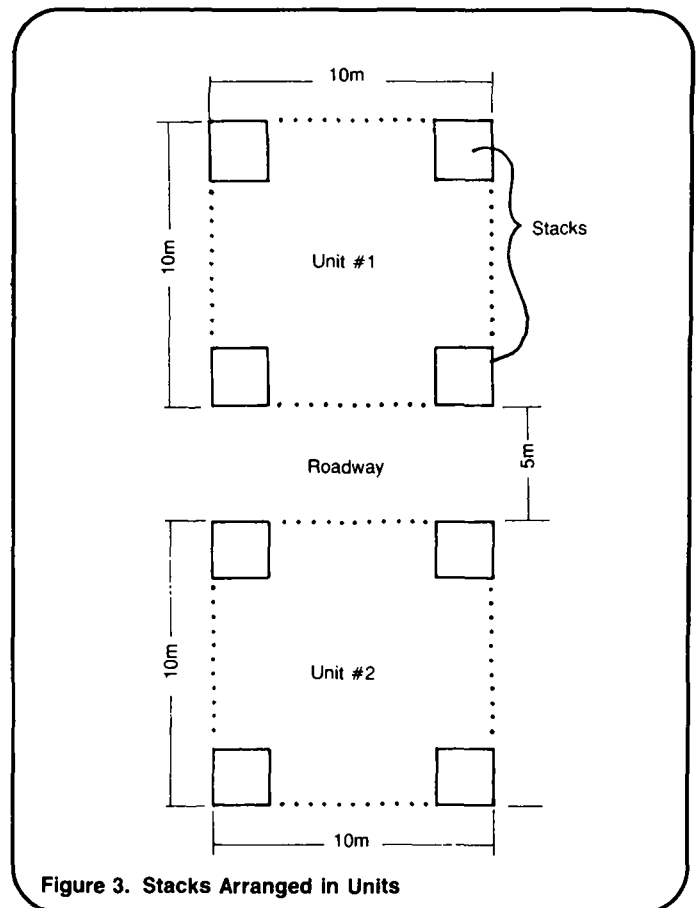


Figure 3. Stacks Arranged in Units

Windrows are 2.5-3.0m wide at the base, 1.5-2.0m high, and rounded at the top. They may be of any convenient length. See Figure 4. One or more windrows may be used. In large systems, they are laid in parallel lines 5-6m apart. See Figure 5. Windrows are appropriate for community composting systems, particularly if mechanized equipment is used to stack or turn the material. They should not be used if excreta is part of the composted material.

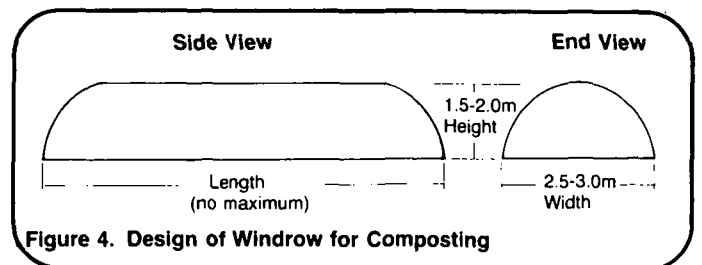


Figure 4. Design of Windrow for Composting

Table 2 compares the features of stacks and windrows.

When the configuration of the system has been determined, prepare design drawings similar to Figures 2, 3, 4, or 5 and give them to the construction supervisor.

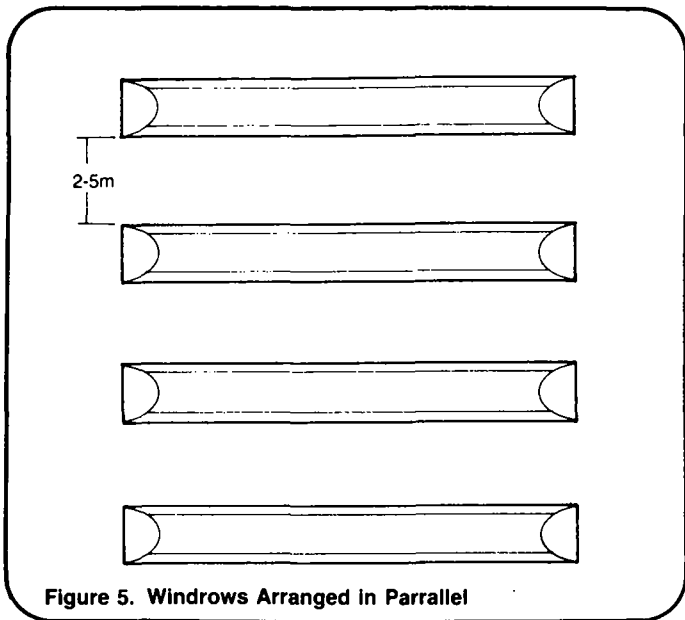


Figure 5. Windrows Arranged in Parallel

windrows, turn the material every third day, and transport the finished compost to garden or crop land. The number of laborers depends on the amount of material being processed and is best determined by field experience. For large, non-mechanized systems, it has been estimated that one laborer can handle 3.5m<sup>3</sup> of material per day.

Tools needed to pile and turn the material include pitchforks with long tines, long-handled rakes, shovels, coarse brooms, and, if excreta is being composted, broad-bladed hoes. Other tools include a 2m long wood or iron pole for testing temperature and moisture; carts or other vehicles for transporting compost to crop land; and boots and gloves for workers. Coarse wire screens are useful to separate non-compostable materials from the compost.

When labor and tools have been determined, prepare a materials list similar to Table 3 and give it to the construction supervisor.

Table 2. Comparison of Stacks and Windrows

Feature	Stack	Windrow
Height	1.2-1.5m	1.5-2.0m
Width	1.8-2.4m	2.5-3.0m
Length	1.8-2.4m	Any
Application	Household or community	Community
Other	Appropriate if excreta is composted	Appropriate if mechanized equipment is used

Table 3. Sample Materials List

Item	Description	Quantity	Estimated Cost
Labor	Supervisor	1	---
	Laborers	3	---
Tools	Pitchforks	---	---
	Rakes	---	---
	Shovels	---	---
	Brooms	---	---
	Hoes	---	---
	Wood pole: 2m long	---	---
	Carts	---	---
	Boots	---	---
	Gloves	---	---
	Coarse wire screens	---	---
	Shredding tools, clippers, knives, machetes	---	---

Total Estimated Cost = \_\_\_\_\_

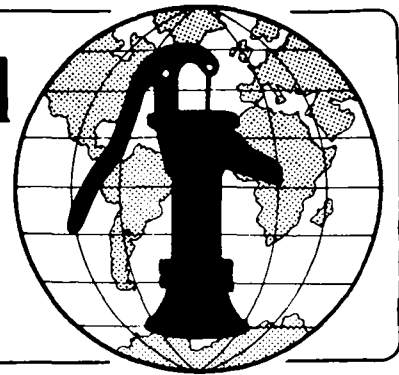
### Determining Labor and Tools

A supervisor is needed to oversee the system. Laborers are needed to pile organic material into stacks or

In summary, give the construction supervisor a location map similar to Figure 1, design drawings similar to Figures 2, 3, 4, or 5, and a materials list similar to Table 3.

**Technical Notes** are part of a set of "Water for the World" materials produced under contract to the U.S. Agency for International Development by National Demonstration Water Project, Institute for Rural Water, and National Environmental Health Association. Artwork was done by Redwing Art Service. Technical Notes are intended to provide assistance to a broad range of people with field responsibility for village water supply and sanitation projects in the developing nations. For more detail on the purpose, organization and suggestions for use of Technical Notes, see the introductory Note in the series, titled "Using 'Water for the World' Technical Notes." Other parts of the "Water for the World" series include a comprehensive Program Manual and several Policy Perspectives. Further information on these materials may be obtained from the Development Information Center, Agency for International Development, Washington, D.C., 20523, U.S.A.

# Water for the World



## Designing a Solid Waste Collection System

Technical Note No. SAN. 3.D.3

A solid waste collection system is a means of removing solid waste from houses, yards, marketplaces, factories, or public buildings and transporting it to a landfill, composting area, or biogas plant. Designing a collection system involves selecting a method of collection, determining necessary materials, selecting personnel, and establishing a schedule of operation. The products of the design process are a detailed materials list and a scheduling chart. These products will be given to the construction supervisor prior to operation.

This technical note describes how to design a solid waste collection system and arrive at the essential end-products. Read the entire technical note before beginning the design process.

### Useful Definitions

**GARBAGE** - Food and crop wastes from growing, harvesting, storing, preparing, cooking, or serving of food; these materials rot quite quickly.

**RUBBISH** - All material other than garbage that is thrown away, including broken dishes, utensils, and furniture; useless scraps of wood, metal, or glass; sweepings from house, yard, or street; and anything else that is discarded.

**SOLID WASTE** - Garbage, rubbish, animal manure, dead animals, and ashes.

### Selecting a Method of Collection

The three basic methods of collection and transport are: (1) household, (2) community, and (3) paid-worker. The collection method selected should be compatible with the method of waste disposal or reuse. See "Methods of Solid Waste Management," SAN.3.M.

**Household.** This is suitable for small amounts of waste and an on-lot landfill, compost stack, or biogas plant if there is a lot of animal manure. Householders sweep out house, porch, and yard; put garbage in a container; shovel animal manure into a cart; and rake up waste from the harvest. They hand-carry or cart the waste to an on-lot site for disposal or reuse.

**Community.** This is suitable for larger amounts of waste and community disposal or reuse. Members of the community clean up houses, yards, stables, marketplaces, or public buildings and put wastes in either privately-owned or public containers. They load the containers on a vehicle and transport them to a community landfill or composting area. To function properly, this method requires unflinching cooperation among members of the community.

**Paid-worker.** This is suitable for larger amounts of waste and community disposal or reuse. Members of the community put solid waste in public containers located near a road, marketplace or public area, and paid workers transport the waste to a community disposal site. Or, there may be door-to-door collection from homes and shops. This method requires cooperation among community members and money to pay workers.

Table 1 summarizes the factors that influence the selection of a collection method.

### Determining Necessary Materials

The types of materials needed can be roughly divided into three categories: (1) cleaning equipment, (2) containers, and (3) vehicles. All materials should be locally available.

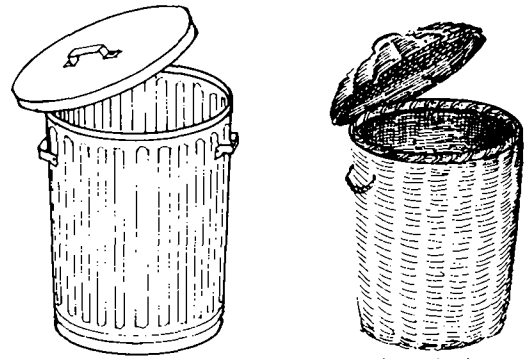
**Cleaning equipment.** The type of equipment depends on the area to be

cleaned, the nature of the waste, and personal preference. Brooms and dust-pans can be used to clean out houses, porches, sidewalks, or streets. Shovels can be used to remove animal manure from the yard. Rakes, pitch-forks, and shovels can be used to pick up harvest wastes or rubbish from factories or plants. For household and community systems, individuals must provide their own equipment. For paid-worker systems, the equipment should be provided by the community. See Figure 1.

**Table 1. Factors Influencing Collection Methods**

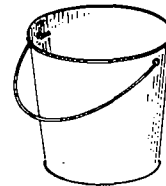
Collection Method	Influencing Factors
Household	Small amounts of waste; on-lot site for disposal or reuse
Community	Larger amounts of waste; community site for disposal or reuse; community cooperation
Paid-worker	Larger amounts of waste; community site for disposal or reuse; community cooperation; money to pay workers

**Containers.** The purpose of a container is to temporarily hold solid waste before disposal. The type of container and its size may vary depending on availability and local preference. Acceptable containers include buckets, baskets, boxes, cans, barrels, and drums. They all should have lids to keep out flies and keep in odors. Containers used for community and paid-worker collection systems should hold 50-200 liters and must be sturdy enough to stand up to rough handling. The number of containers needed depends on the amount of waste and the frequency of collection. There should be more than enough containers to hold all the waste generated between collection days. See Figure 2.

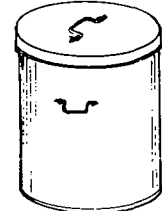


200-liter metal container

Large basket



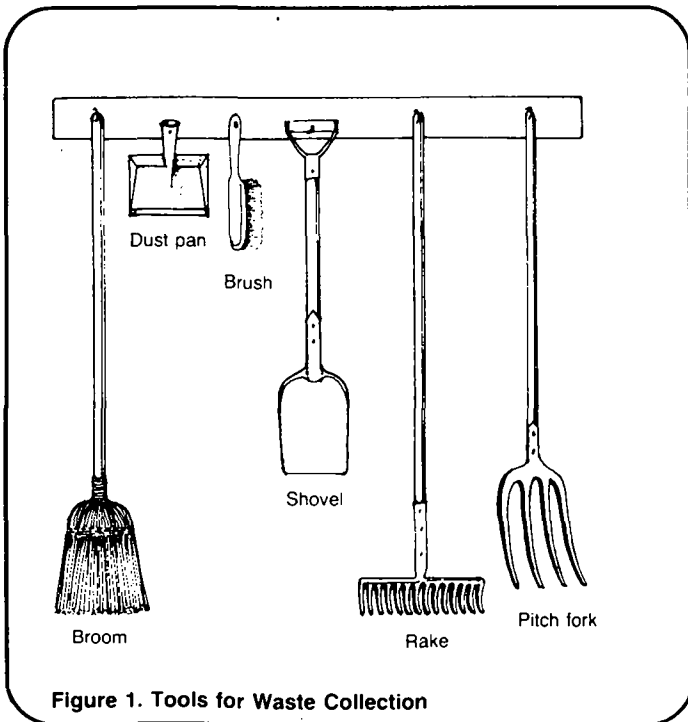
Bucket



Tin can

**Figure 2. Containers for Waste Collection**

**Vehicles.** For all community and paid-worker systems, and for some household systems, vehicles are needed to transport solid waste, in containers or not, to the site for disposal or reuse. Vehicles should be locally constructed and may be hand-drawn, animal-drawn, bicycle-powered, or motorized. If containers are transported, the loading height of the vehicle should be no more than 1.0m for ease of handling. Vehicle repair and replacement parts must be readily available, especially for paid-worker



**Figure 1. Tools for Waste Collection**

collection systems. See Figure 3. Design a storage shed for the vehicles. It should be weatherproof and have a door with a lock. Locate it near the disposal site.

### Selecting Personnel

Every collection system must have someone in charge and someone to do the work.

For a household collection system, one member of the family should be responsible for seeing that waste is collected regularly. This person may also carry the waste to the disposal site.

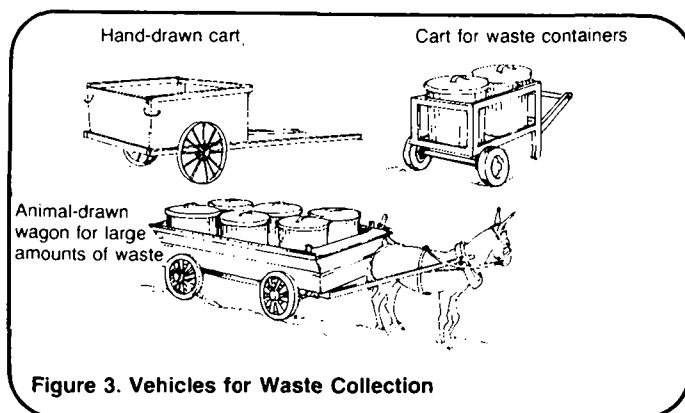
For a community collection system, each marketplace vender or someone from each household voluntarily performs the work. However, a volunteer overseer respected by the community will have to organize the collection system. In addition, his or her continued presence will ensure a more efficient operation. The overseer could, for example, walk through the marketplace on collection day encouraging vendors to clean out their stalls and place garbage in containers.

For a paid-worker collection system, a paid supervisor must be hired. The supervisor must be a responsible person with the ability to give orders. He may or may not be charged with hiring workers. Workers should be able-bodied and capable of following orders. Their numbers will depend on the size of the collection system, but they should be able to complete their daily work within a reasonable length of time, for example six to ten hours.

When the method of collection has been selected and all necessary equipment and personnel have been determined, make out a materials list similar to Table 2 and give it to the construction supervisor.

### Establishing a Schedule of Operation

Establishing an operation schedule involves determining the frequency of collection, selecting locations for containers, and, for paid-worker systems, determining a collection route. In all systems, the persons collecting wastes may also be the ones disposing of it in a landfill or



**Table 2. Sample Materials List**

Item	Description	Quantity	Estimated Cost
Labor	Supervisor (for one year)	1	—
	Workers (for one year)	4	—
Supplies	Equipment: shovels	—	—
	brooms	—	—
	dust pans	—	—
	Containers: 200-liter metal drums with lids	—	—
	Vehicles: animal-drawn carts	—	—
	Other: gloves	—	—
boots	—	—	
first-aid kit	—	—	
Total Estimated Cost =			—

placing it in a compost stack or biogas system. See "Designing a Landfill," SAN.3.D.1, "Designing a Composting System," SAN.3.D.2, and "Designing a Biogas System," SAN.3.D.4.

Frequency of Collection. Solid waste should be collected often enough so that the amount collected is easily handled. This may mean collecting daily or two or three times a week. In no case should collection be less frequent than once each week, because it takes just over a week for fly eggs to hatch and mature. Usually two collections per week are enough although a central market will require daily collection.

Some examples of collection frequency:

- Members of a household throw garbage into a garbage can after each meal. Every two or three days, one member of the family carries the can to the disposal site or compost stack.

- The community established a "Clean Day" to be observed once each week: every Saturday or Monday, for example. On this day, household members and shopkeepers clean out their living and working areas and cart the waste to a community disposal site.

- Community members place their solid waste in public containers. Each day or two, paid workers either empty the containers into a vehicle or load them on a vehicle, and transport the waste to a community disposal site.

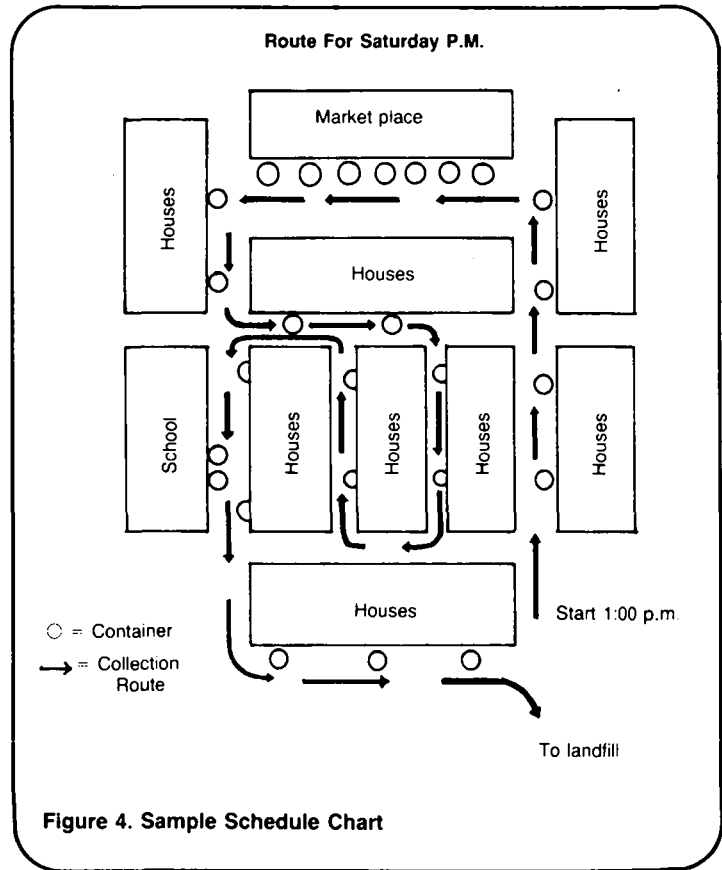
Location of Containers. Containers should be placed in easily accessible areas or collection points. If containers are transported from a collection point to a disposal site, they must either be replaced with empty ones or returned to the collection point.

It may be that a container is filled in one location and collected from another. For example, a container may be placed near a market stall and filled with garbage during the morning, then carried to the side of the road for collection by a paid worker in the afternoon.

Route. A collection route must be established for a paid-worker system in order to save time and effort and ensure efficiency of the system. An established collection route encourages a routine of cleanliness in the community. Plan the route so that it is as short and simple as possible and ends as near as practical to the disposal site.

When the schedule of operation has been established, draw up a scheduling chart similar to Figure 4, showing the route, collection points, collection days, and approximate time of collection, morning or afternoon. Give the chart to the construction supervisor.

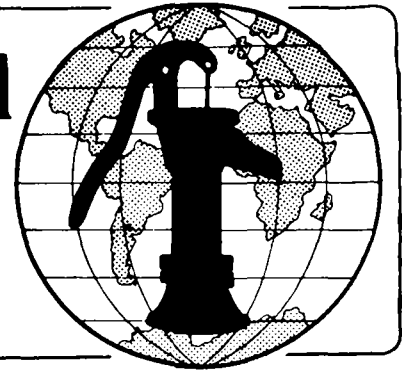
In summary, give the construction supervisor a materials list and a scheduling chart similar to Figure 4 prior to operation of the collection system.



**Technical Notes** are part of a set of "Water for the World" materials produced under contract to the U.S. Agency for International Development by National Demonstration Water Project, Institute for Rural Water, and National Environmental Health Association. Artwork was done by Redwing Art Service. Technical Notes are intended to provide assistance to a broad range of people with field responsibility for village water supply and sanitation projects in the developing nations. For more detail on the purpose, organization and suggestions for use of Technical Notes, see the introductory Note in the series, titled "Using 'Water for the World' Technical Notes." Other parts of the "Water for the World" series include a comprehensive Program Manual and several Policy Perspectives. Further information on these materials may be obtained from the Development Information Center, Agency for International Development, Washington, D.C., 20523, U.S.A.



# Water for the World



## Designing a Biogas System Technical Note No. SAN. 3.D.4

A biogas system is a means of digesting animal manure anaerobically to produce methane gas which is burned to provide heat or light. The system consists of one or more digester tanks, a gas holder, an arrangement of gas pipes, and one or more fixtures to burn the gas. Designing a biogas system requires the services of a project designer experienced with these systems. Designing involves selecting a location; calculating the size of the digesters and the gas holder; and determining the labor, materials, and tools needed for construction. The products of the design process are: (1) a location map, (2) design drawings of the system, and (3) a detailed materials list. These products will be given to the construction foreman prior to construction.

This technical note describes how to design a biogas system. Read the entire technical note before beginning the design process.

### Useful Definition

**METHANE** - A gas produced when organic material such as manure decomposes in an airless environment; methane burns with a violet flame without smoke; it is explosive.

### Materials Needed

Measuring tape - To obtain accurate field information for a location map.

Ruler - To produce a location map.

### General

A biogas system requires a constant and large supply of manure. A system serving one family needs the daily manure production of either 10-15 pigs, two or three horses, or two cows.

All components of a biogas system must be gas-tight. Gas leaks are dangerous because certain mixtures of methane gas and air are explosive. Therefore, the design, construction, and operation of these systems should be undertaken only by experienced or carefully trained personnel. There are a number of types of biogas systems. One design requires at least two digesters to ensure continuous gas production. While one digester is producing gas, the other can be emptied of digested material and reloaded with fresh manure and water.

Some components of the system may be built but some must be purchased. The digesters and the floor and walls of the gas holder are generally made from reinforced concrete and usually are built on the site. However, the gas holder is typically circular and requires special construction skills to build. Components which must be purchased include the metal cover for the gas holder, guide wheels, guide posts, gas pipes, valves, petcocks, and fixtures used to burn the gas. These items make a biogas system relatively costly.

The gas holder and digesters are designed to be installed partially underground. This is done for ease of loading and maintenance, while allowing

a portion of the system to be exposed to sunlight. In temperate climates, this kind of installation helps keep the temperature in the digester more uniform.

### Selecting a Location

The system should be located:

- alongside the stable, pig sty, or other manure source to avoid excessive handling of manure,
- near the dwelling to minimize the amount of gas piping,
- in an unshaded area to make use of the maximum available heat from the sun.

When a location has been selected, draw a location map similar to Figure 1 and give it to the construction foreman.

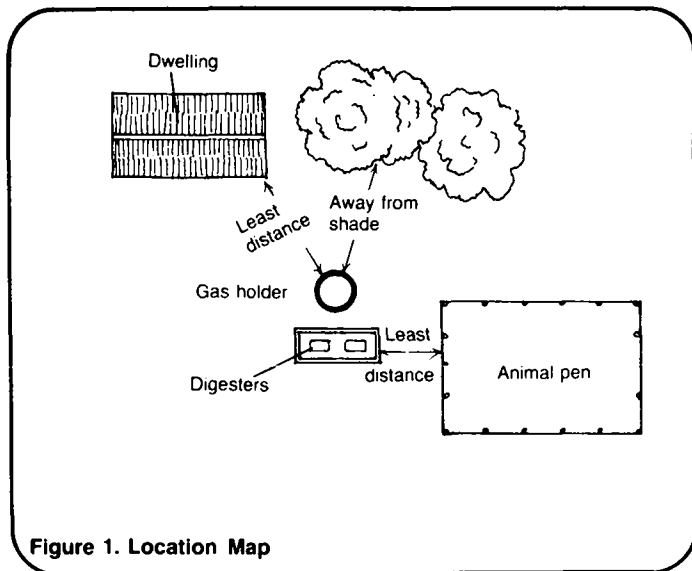


Figure 1. Location Map

### Calculating Size

The size of the system depends on the desired volume of daily gas production. The volume of the gas holder should equal one day's gas production, with a minimum size of  $2\text{m}^3$ .

Table 1 provides approximate quantities of gas required for some domestic activities.

Table 1. Approximate Gas Requirements

Activity	Volume of Gas
Cooking for a family of 5 or 6 persons	$2\text{m}^3$ per day
Heating water in a 100-liter tank	$3\text{m}^3$ per day
Lighting one lamp	$0.1\text{--}0.15\text{m}^3$ per hour
Operating a two-horsepower stationary engine	$0.9\text{m}^3$ per hour

To estimate the volume of the gas holder, add together the gas needed for each expected activity. For example, if the family expects to burn methane to cook, light one lamp for two hours each night, and operate a two-horsepower engine for two hours each day, the size of the gas holder should be:

$$2\text{m}^3 + (2 \times 0.1\text{m}^3) + (2 \times 0.9\text{m}^3) = 2\text{m}^3 + 0.2\text{m}^3 + 1.8\text{m}^3 = 4.0\text{m}^3$$

The floating cover of the gas holder should have a volume equal to at least  $4.0\text{m}^3$ . The volume of a circular cover equals 3.1 times the radius squared times the height. One configuration which would contain the required volume would be 1.6m in diameter and 2.02m in height:

$$\text{radius} = \frac{\text{diameter}}{2} \text{ so radius} = \frac{1.6\text{m}}{2} = 0.8\text{m}$$

$$3.1 \times 0.8\text{m} \times 0.8\text{m} \times 2.02\text{m} = 4.0\text{m}^3$$

Worksheet A, Lines 1-5

The actual height of the cover equals the calculated height plus 150mm to allow for placement of the weep-holes, which will provide an escape for an excessive amount of gas.

### Worksheet A. Calculating Dimensions of a Biogas System

1. Expected daily volume of gas = 4.0 m<sup>3</sup>
2. Minimum volume of gas holder = Line 1 = 4.0 m<sup>3</sup>
3. Proposed diameter of floating cover = 1.6 m
4. Proposed radius of cover =  $\frac{\text{Line 3}}{2} = \left(\frac{1.6 \text{ m}}{2}\right) = \underline{0.8} \text{ m}$
5. Calculated height of cover =  $\frac{\text{Line 2}}{3.1 \times \text{Line 4} \times \text{Line 4}} =$   
 $\frac{(4.0 \text{ m}^3)}{3.1 \times (0.8 \text{ m}) \times (0.8 \text{ m})} = \frac{(4.0 \text{ m}^3)}{(1.98 \text{ m}^2)} = \underline{2.02} \text{ m}$
6. Design height of cover = Line 5 + 0.15m = 2.02 m + 0.15m = 0.17 m
7. Inside height of gas holder = Line 6 + 0.25m = 2.7 m + 0.25m = 2.42 m
8. Inside diameter of gas holder = Line 3 + 0.15m = 1.6 m + 0.15m = 1.75 m
9. Volume of each digester volume should not exceed 8.0m<sup>3</sup> = 2 x Line 1 =  
2 x 4.0 m<sup>3</sup> = 8.0 m<sup>3</sup>
10. Proposed length of digester = 2.0 m
11. Proposed width of digester = 2.0 m
12. Height of digester =  $\frac{\text{Line 9}}{\text{Line 10} \times \text{Line 11}} = \frac{(8.0 \text{ m}^3)}{(2.0 \text{ m}) \times (2.0 \text{ m})} =$   
 $\frac{(8.0 \text{ m}^3)}{(4.0 \text{ m}^2)} = \underline{2.0} \text{ m}$

In the example given, the actual, or design height is:

$$2.02\text{m} + 0.15\text{m} = 2.17\text{m}$$

Worksheet A, Line 6

The inside height of the gas holder equals the design height of the floating cover plus 250mm. The inside height for this example is:

$$2.17\text{m} + 0.25\text{m} = 2.42\text{m}$$

Worksheet A, Line 7

The inside diameter of the gas holder equals the diameter of the cover plus 150mm. The inside diameter for this example is:

$$1.6\text{m} + 0.15\text{m} = 1.75\text{m}$$

Worksheet A, Line 8

When the dimensions of the gas holder have been calculated, prepare a design drawing similar to Figure 2 and give it to the construction foreman.

The volume of each digester should equal twice the volume of the gas holder, with a maximum size of 8.0m<sup>3</sup>.

In the example given, the volume of the gas holder is 4.0m<sup>3</sup>. Twice this volume equals: 2 x 4.0m<sup>3</sup> = 8.0m<sup>3</sup>. This does not exceed the maximum. Each digester should have a volume of 8.0m<sup>3</sup>. One configuration that has this volume is 2.0m wide by 2.0m long by 2.0m high:

$$2.0\text{m} \times 2.0\text{m} \times 2.0\text{m} = 8.0\text{m}^3$$

Worksheet A, Lines 9-12

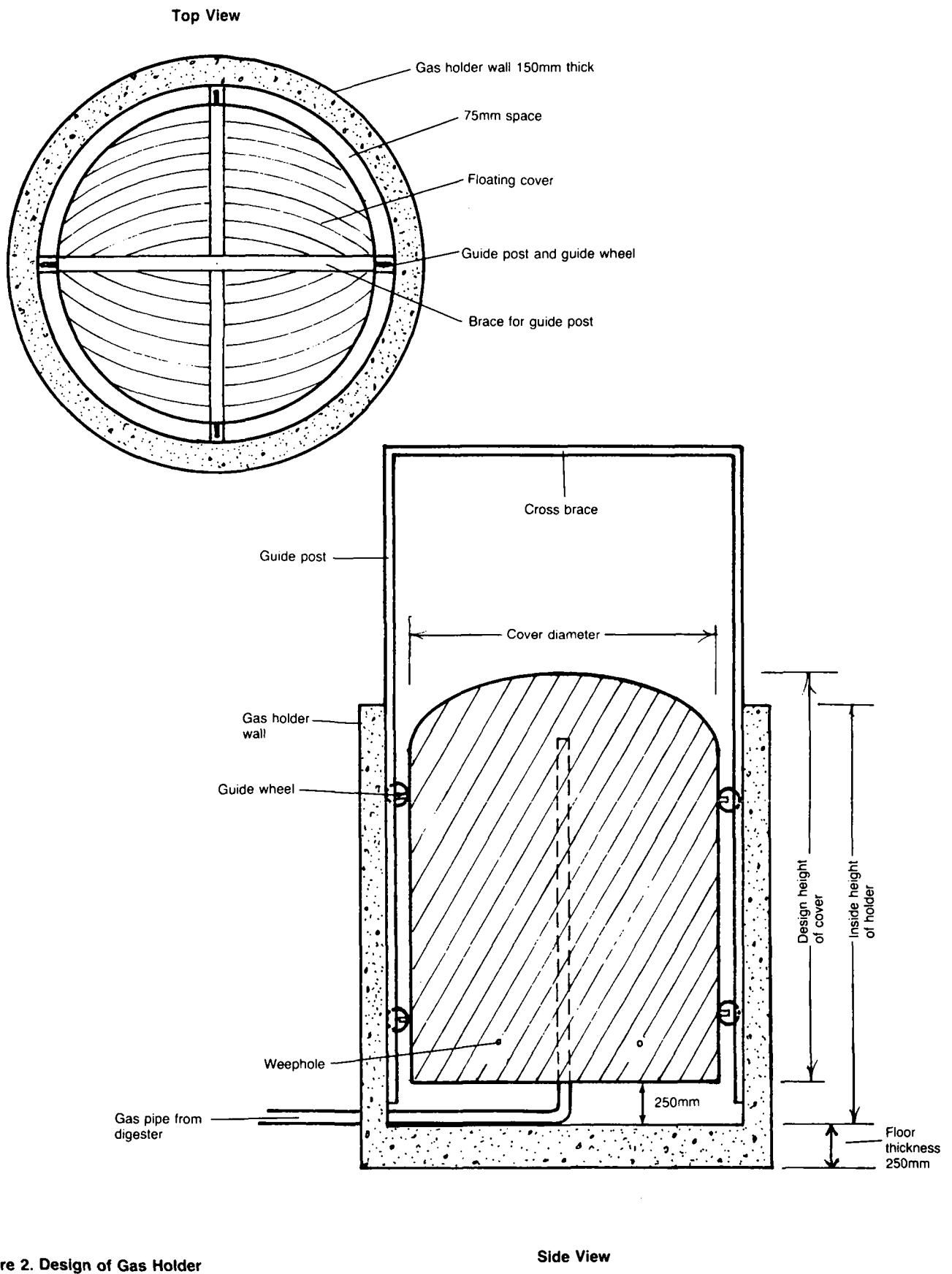
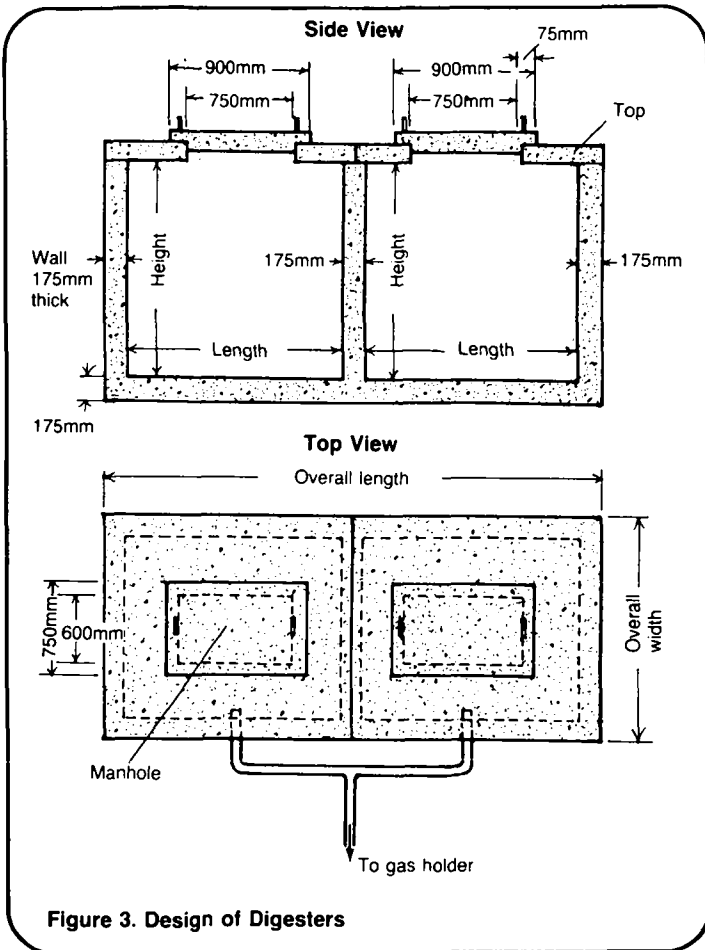


Figure 2. Design of Gas Holder

When the dimensions of the digesters have been determined, prepare a design drawing similar to Figure 3 and give it to the construction foreman.

The digesters and the gas holder, not including the cover, are made from reinforced concrete. The thickness of the concrete is summarized in Table 2. Add this information to Figures 2 and 3.



**Table 2. Concrete Thicknesses**

Feature	Thickness
Digester:	
walls	175mm
floor	175mm
top	150mm
Gas Holder:	
walls	150mm
floor	250mm

The floating cover for the gas holder is made from sheet iron 2-3mm thick, reinforced with angle iron or cross-braces. Because of its strict design specifications, it must be purchased unless an exceptionally skilled sheet metal worker can be found.

Gas pipes are 12-25mm in diameter and are made from copper or galvanized iron. Valves and petcocks are placed at key control points along the gas lines. To determine the amount of pipe needed, and the number of valves, petcocks, and pipe-fittings, prepare a drawing similar to Figure 4 showing the layout of the system.

Fixtures are needed to burn the methane gas. These are generally purchased.

Materials for reinforced concrete include cement, sand, gravel, water, reinforcing material, and materials to build forms. For complete details see "Designing Septic Tanks," SAN.2.D.3.

Tools needed include picks and shovels for excavation; hammer and saw for building forms; trowel for working concrete; wrenches, hacksaw, and threading tool for installing gas pipes, and a device for checking leaks.

When all determination for labor, materials, and tools have been made, prepare a materials list similar to Table 3 and give it to the construction foreman.

### Determining Labor, Materials, and Tools

The primary labor requirement is a construction foreman familiar with these systems. An experienced pipe-fitter is needed to install the gas pipes. At least one worker should have some experience with reinforced concrete. Unskilled labor can be used for making excavations, mixing concrete, and hauling materials.

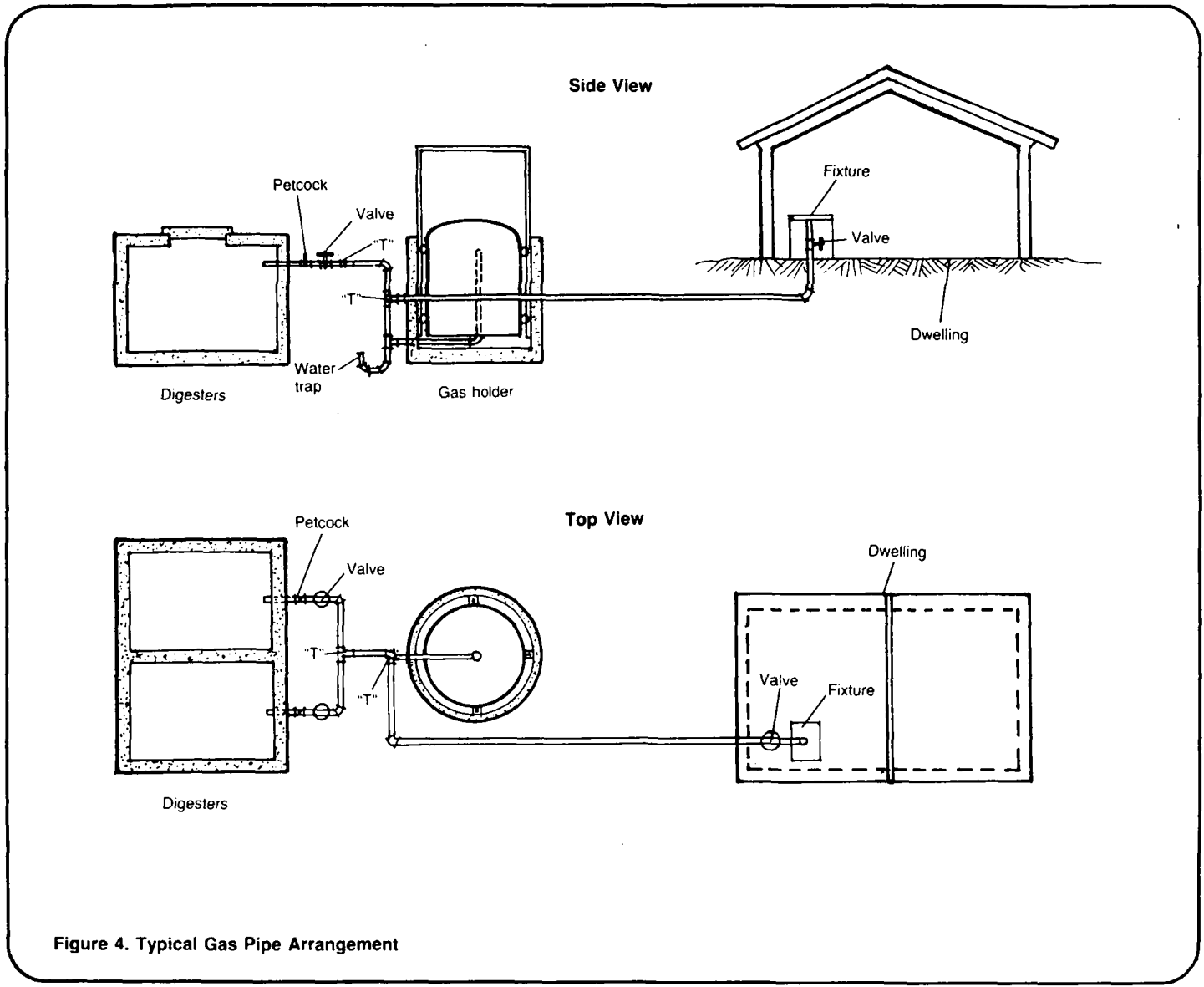


Figure 4. Typical Gas Pipe Arrangement

In summary, give the construction foreman a location map similar to Figure 1, design drawings similar to

Figures 2 and 3, a system layout similar to Figure 4, and a materials list similar to Table 3.

**Table 3. Sample Materials List**

Item	Description	Quantity	Estimated Cost
Labor	Construction foreman experienced with biogas	1	_____
	Worker experienced with pipe fitting	1	_____
	Worker experienced with reinforced concrete	1	_____
	Unskilled workers	4	_____
Supplies	Prefabricated floating cover: 3mm thick sheet iron; 1.60m diameter; 2.17m high	_____	_____
	Guide posts; galvanized iron	_____	_____
	Guide wheels	_____	_____
	Gas pipe: 18mm diameter	_____	_____
	Valves	_____	_____
	Petcocks	_____	_____
	"T" fittings	_____	_____
	"L" fittings	_____	_____
	Fixtures	_____	_____
	Concrete mix	_____	_____
	Reinforcing material	_____	_____
	Material for forms	_____	_____
Sealer for digester manholes	_____	_____	
Other	_____	_____	
Tools	Shovels	_____	_____
	Picks	_____	_____
	Hammers	_____	_____
	Saw	_____	_____
	Trowels	_____	_____
	Wheelbarrow	_____	_____
	Containers: for mixing concrete	_____	_____
	Pipe wrench	_____	_____
	Threader	_____	_____
	Hacksaw	_____	_____
	Other	_____	_____

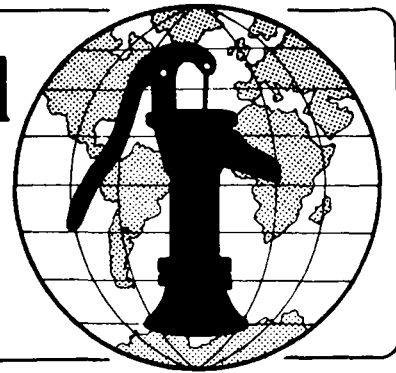
Total Estimated Cost = \_\_\_\_\_

## Notes

**Technical Notes** are part of a set of "Water for the World" materials produced under contract to the U.S. Agency for International Development by National Demonstration Water Project, Institute for Rural Water, and National Environmental Health Association. Artwork was done by Redwing Art Service. Technical Notes are intended to provide assistance to a broad range of people with field responsibility for village water supply and sanitation projects in the developing nations. For more detail on the purpose, organization and suggestions for use of Technical Notes, see the introductory Note in the series, titled "Using 'Water for the World' Technical Notes." Other parts of the "Water for the World" series include a comprehensive Program Manual and several Policy Perspectives. Further information on these materials may be obtained from the Development Information Center, Agency for International Development, Washington, D.C., 20523, U.S.A.



# Water for the World



## Constructing a Biogas System

Technical Note No. SAN. 3.C.4

A biogas system is a means of digesting animal manure anaerobically to produce methane gas which is burned to provide heat or light. The system consists of one or more digesters, a gas holder, an arrangement of gas pipes, and one or more fixtures to burn the gas. Constructing a biogas system requires the services of a foreman experienced with these systems.

Constructing involves assembling necessary labor, materials, and tools; making excavations; building the gas holder and digesters from reinforced concrete; installing the gas holder cover; installing gas pipes; and checking the pipes for leaks.

This technical note describes how to construct a biogas system. Read the entire technical note before beginning construction.

### Useful Definition

**METHANE** - A gas produced when organic material such as manure decomposes in an airless environment; methane burns with a violet flame without smoke; it is explosive.

### Materials Needed

Before construction can begin, the project designer must provide:

- 1) Location map similar to Figure 1,
- 2) Design drawings similar to Figures 2 and 3,
- 3) Layout of the gas pipe arrangement similar to Figure 4,
- 4) Materials list similar to Table 1.

You will also need:

- 5) All labor, materials and tools described in the materials list.

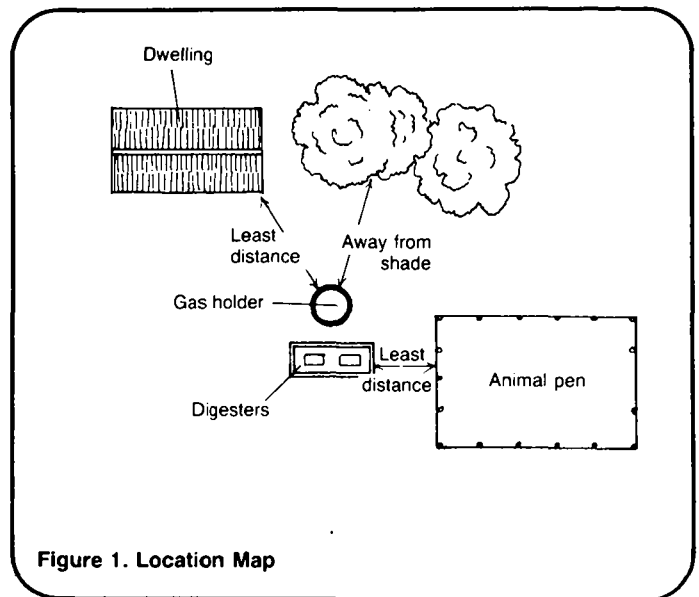


Figure 1. Location Map

### General

Depending on local conditions, availability of materials, and skills of workers, some construction steps will require only a day, while others may require several days. Read the construction steps and make a rough estimate of the time needed for each step based on local conditions. You will then have an idea of when specific workers, materials, and tools must be available during construction. Draw up a work plan similar to Table 2 showing construction steps.

### Constructing Digesters

1. Assemble all laborers, materials, tools, and drawings needed to begin construction. Study all drawings carefully.

2. Using the location map and a measuring tape, locate the sites for the digesters and the gas holder and mark them with wooden stakes. See Figure 5.

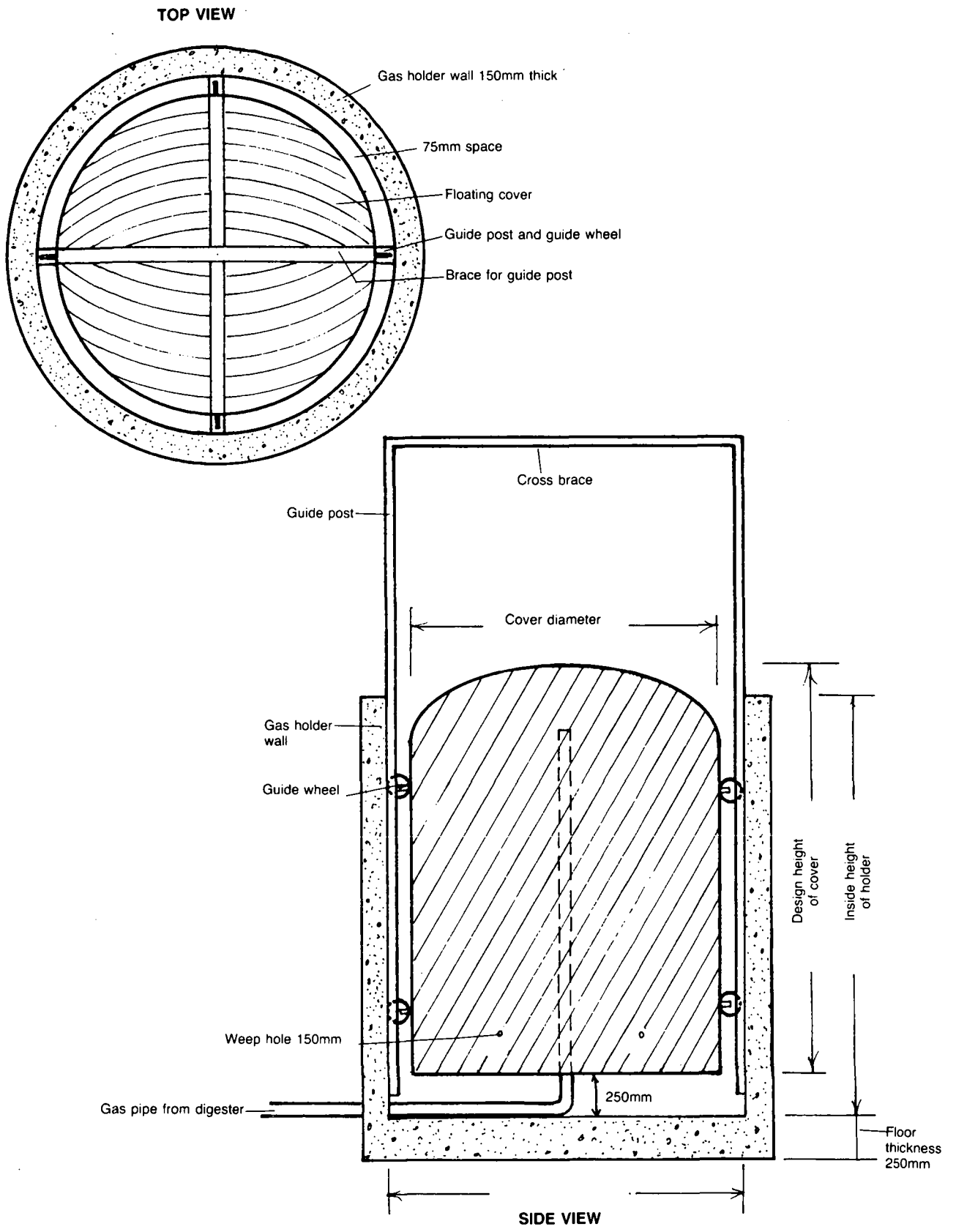
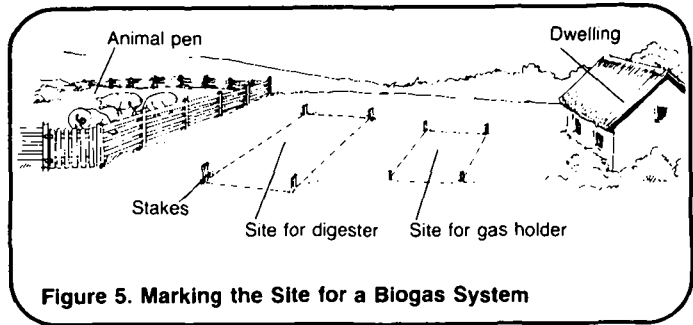
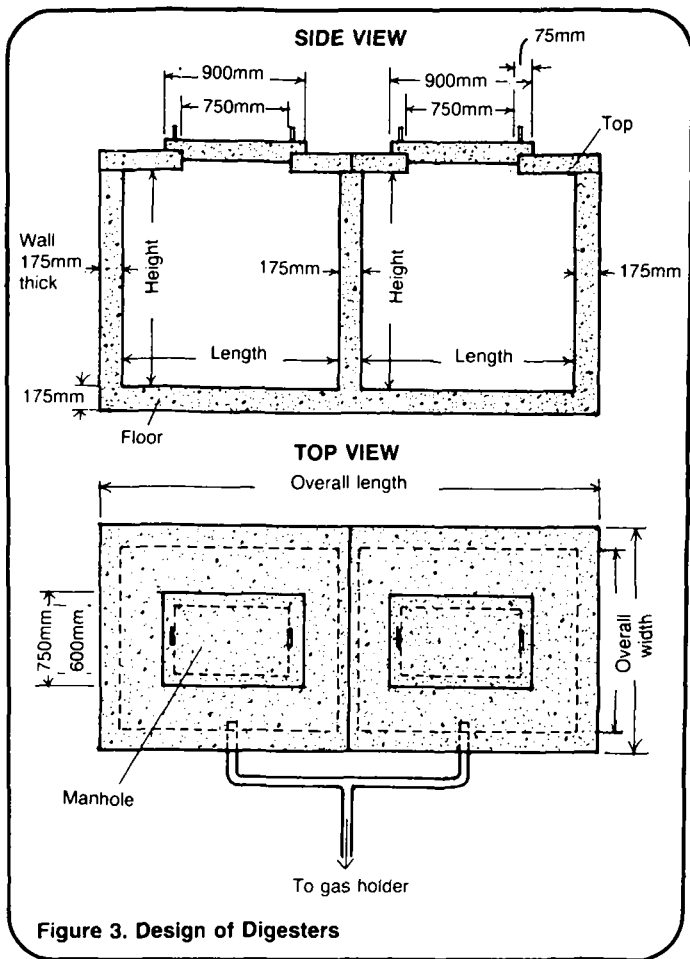


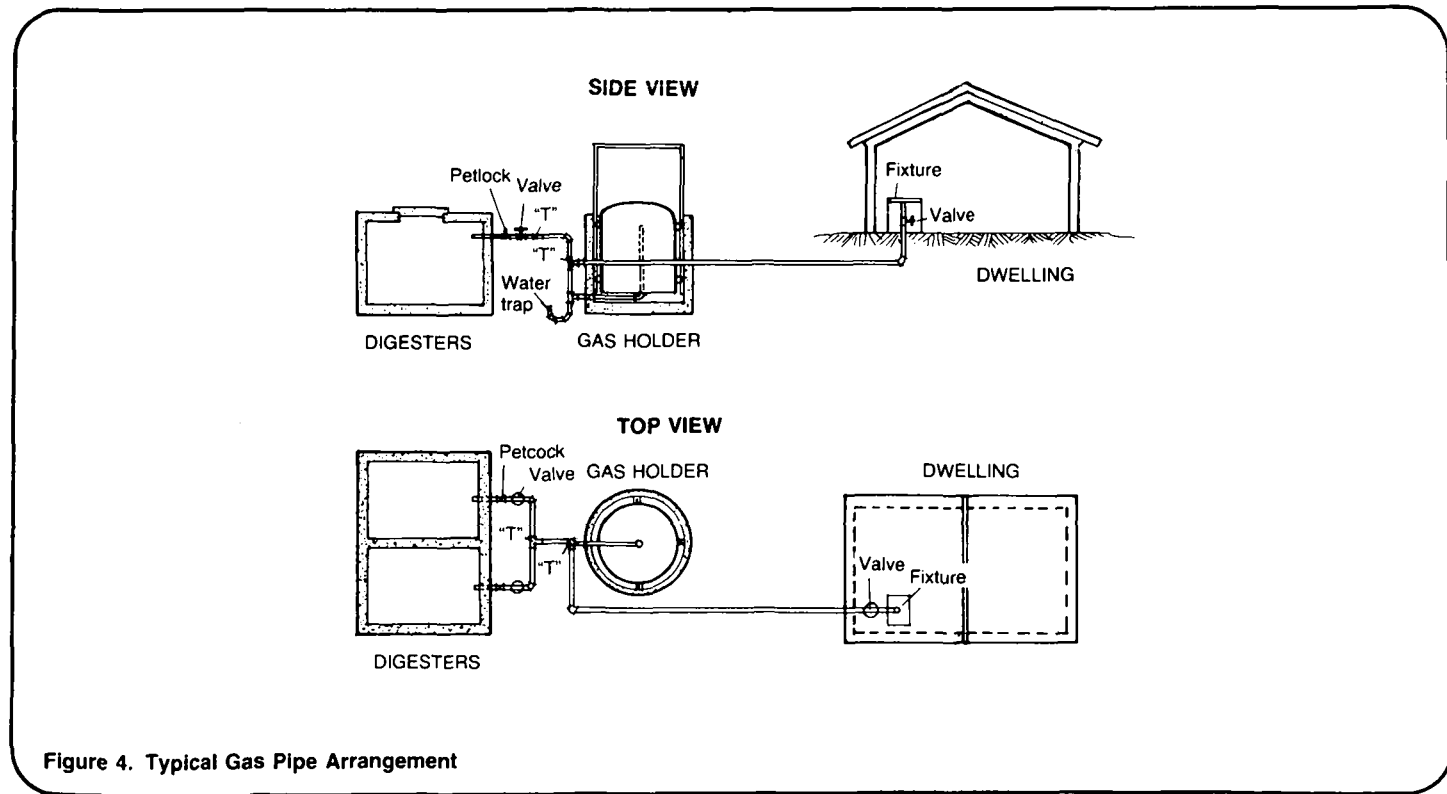
Figure 2. Design of Gas Holder



3. Dig the hole for the digesters 1.0-1.5m deep. Allow a working area of about 0.3m around all sides. Make the bottom of the hole level, tamp well, and spread a 50mm layer of gravel. See Figure 6.

4. Build the forms for the floor.

5. Mix concrete to the correct proportions. A common mix by volume is one part cement to two parts sand to three parts gravel and enough water to make a fairly stiff mix. Mix until sand and gravel are evenly coated with cement and water. For more details on concrete see "Constructing Septic Tanks," SAN.2.C.3.



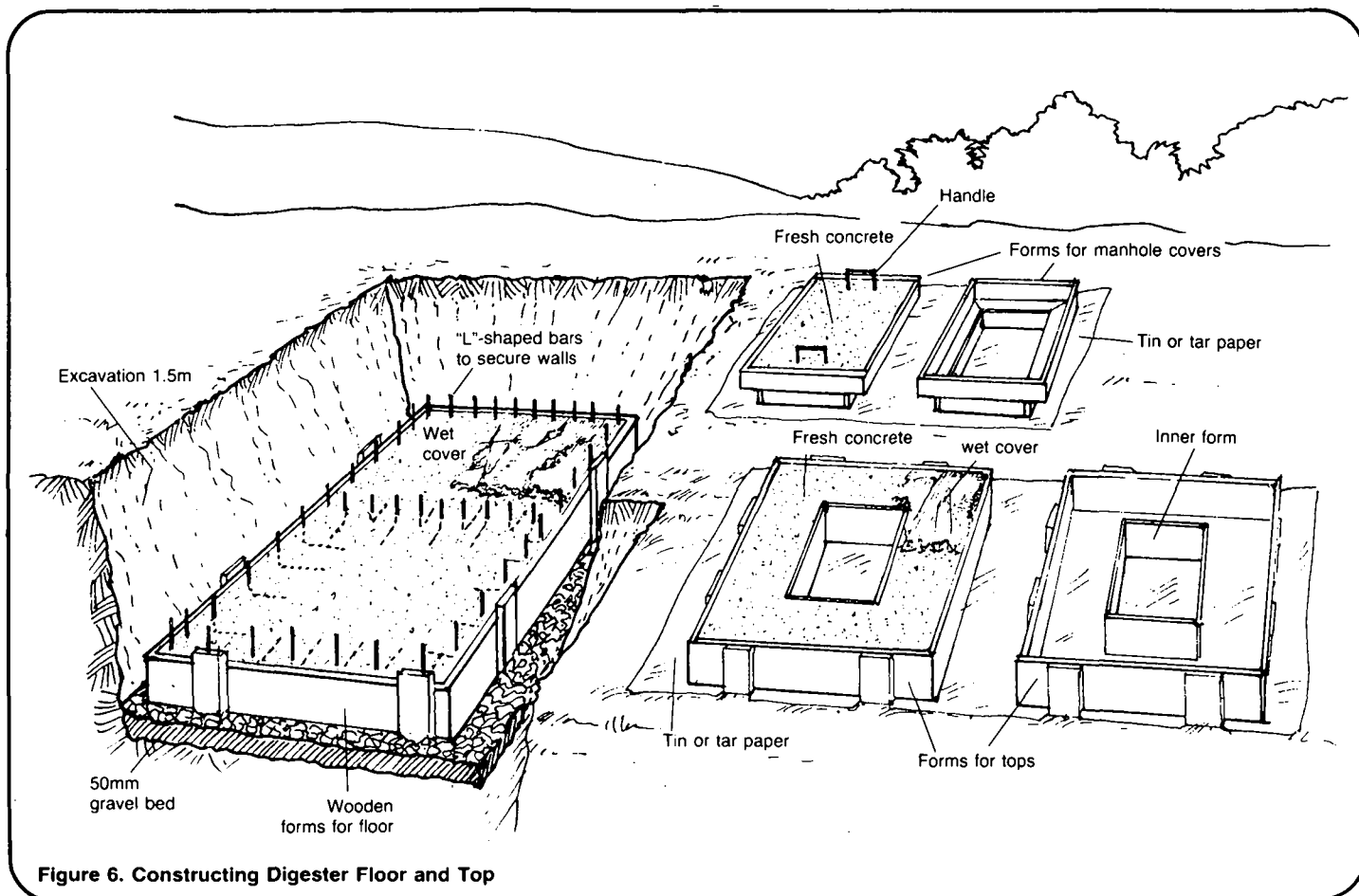


Figure 6. Constructing Digester Floor and Top

6. Pour in concrete to about 50mm from the top of the forms. Lay in reinforcing material such as steel rods, wire mesh, or bamboo strips. If L-shaped bars are available, position them in the concrete so that the vertical portion of the "L" will extend up into the center thickness of the walls. See Figure 6.

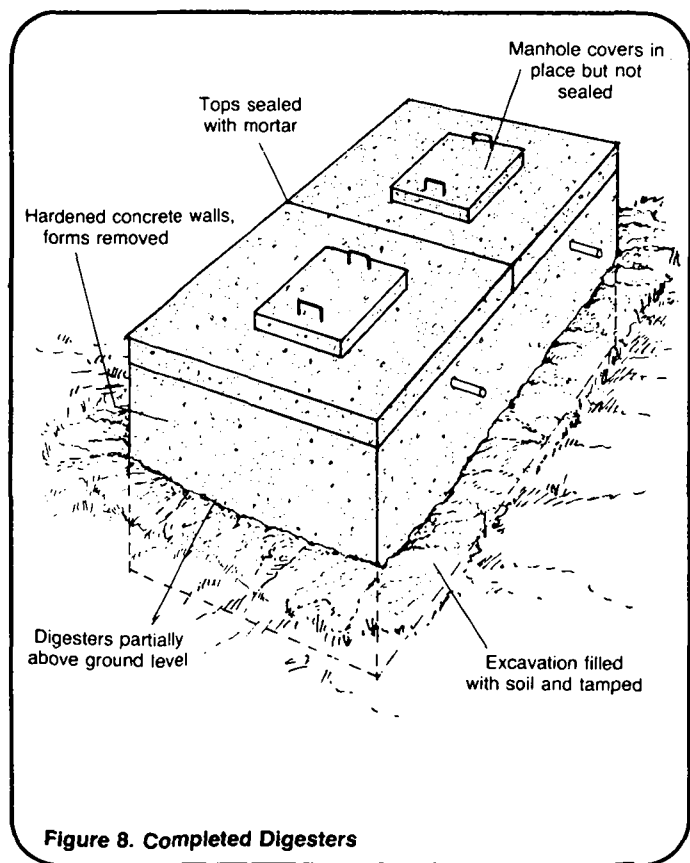
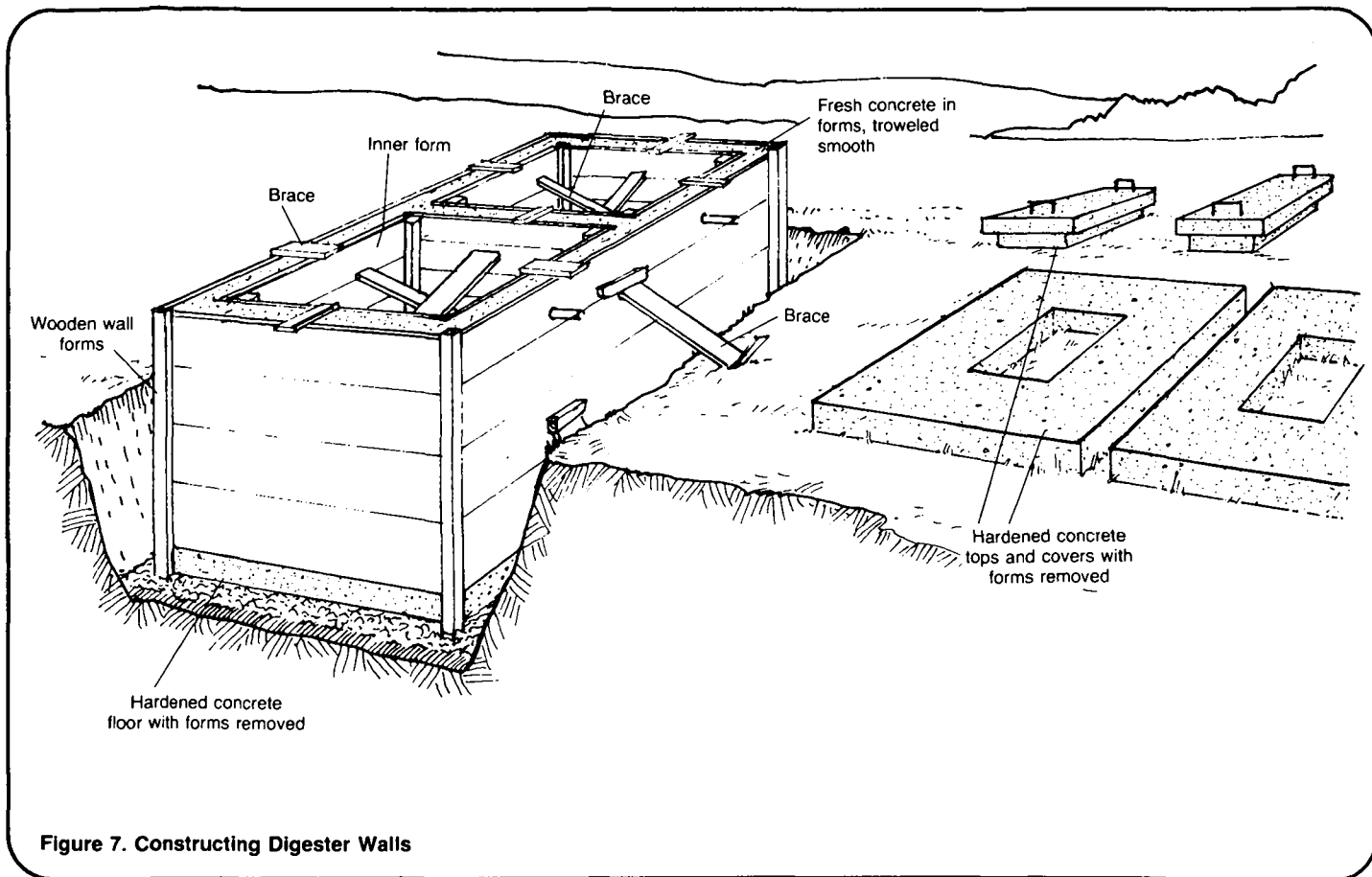
7. Fill the forms with concrete, trowel the surface smooth, and cover with wet straw or burlap bags. Keep moist for five to seven days.

8. While the concrete floor is setting up, build the forms for the top and manhole covers. Pour in concrete until the forms are about half full, lay in reinforcing material, then fill the forms with concrete. Set handholds made of horseshoes or bent steel rods into the concrete, trowel smooth, and cover with wet straw or burlap. Keep moist for five to seven days. See Figure 6.

9. When the concrete floor has set up, remove the cover material and the forms. Build the wall forms in place. Set a section of gas pipe near the top of one wall in each digester. Position reinforcing material in the wall forms. Brace the wall forms to prevent possible collapse when the concrete is poured. See Figure 7.

10. Mix and pour concrete into the wall forms. Be certain that concrete fills all voids in the forms. Use a steel rod or stout stick to work concrete between reinforcing material and the forms. Trowel the tops of the walls smooth and cover with wet straw or burlap. Keep moist for five to seven days. See Figure 7.

11. When the concrete walls have set up, remove cover material and forms from the walls, tops, and manhole covers. Mortar the tops in place with concrete mortar. Seal the bottom edges of the walls, inside and out, with



concrete mortar. Set the manhole covers in place, but do not seal until the system is ready for operation. See Figure 8.

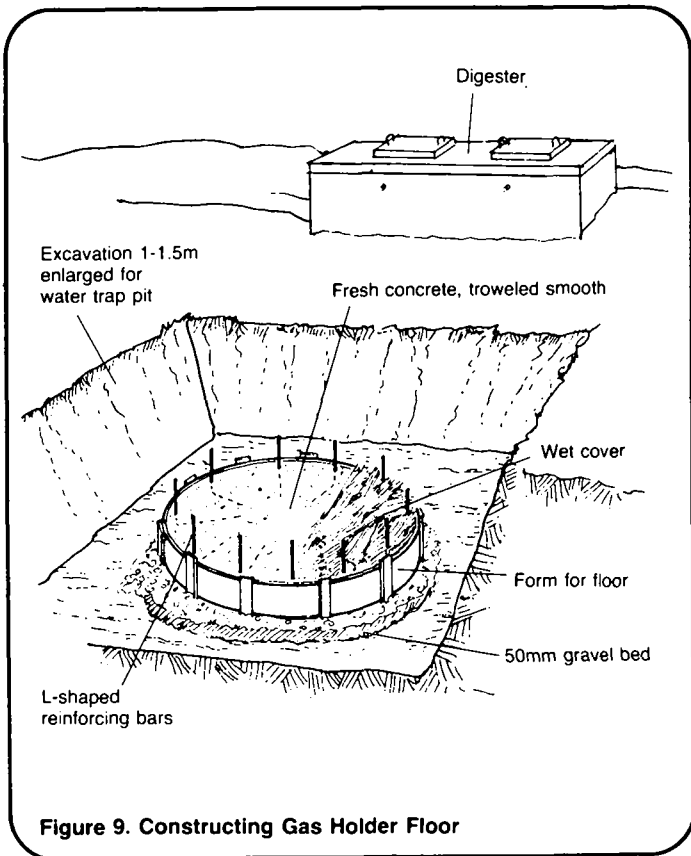
12. Fill in the excavation around the digesters with soil and tamp firmly.

### Constructing the Gas Holder

1. Dig the hole for the gas holder 1.0-1.5m deep. Allow a working area of about 0.3m around all sides and allow about 1.0m<sup>2</sup> for the water trap pit. Make the bottom of the hole level. Tamp the bottom of the hole, but not the bottom of the pit. Spread 50mm of gravel in the hole. See Figure 9.

2. Build the forms for the floor.

3. Mix and pour concrete to about 50mm from the top of the forms. Lay in reinforcing material. If L-shaped bars are available, position them in the concrete so that the vertical portion of the "L" will extend up into the center thickness of the walls.

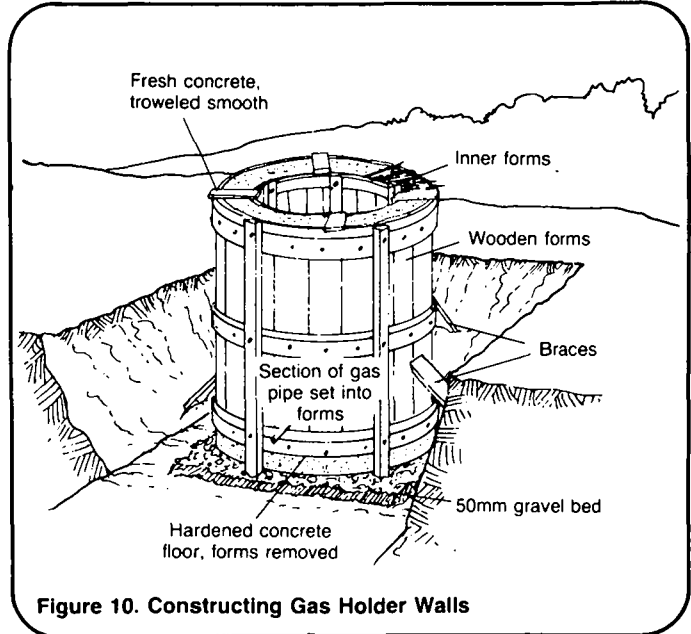


4. Fill the forms with concrete, trowel the surface smooth, and cover with wet straw or burlap bags. Keep moist for five to seven days. See Figure 9.

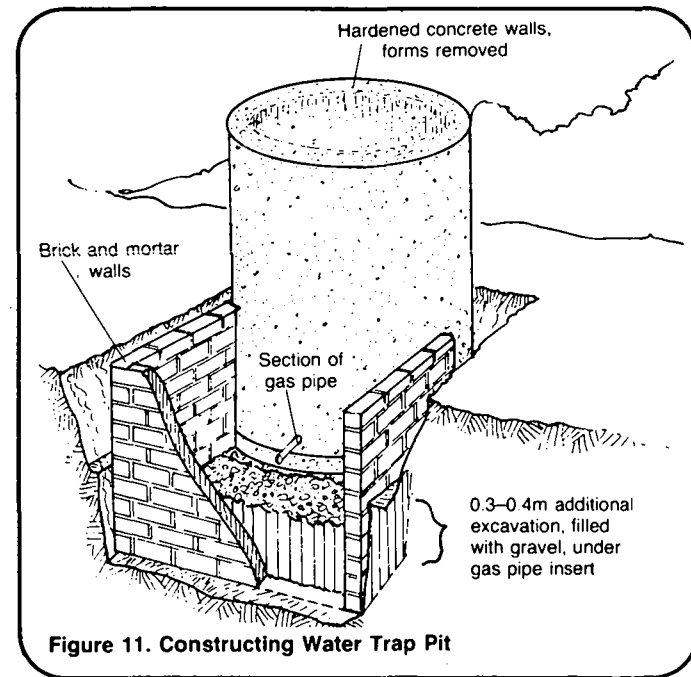
5. When the concrete floor has set up, remove cover material and forms. Build the wall forms in place. Set a section of gas pipe in the form near the bottom of the wall facing the digesters. Position reinforcing material in the wall forms. Brace the forms to prevent possible collapse when the concrete is poured. See Figure 10.

6. Mix and pour concrete into the wall forms. Be certain that concrete fills all voids in the forms. Use a steel rod or stout stick to work concrete between reinforcing material and the forms. Trowel the tops of the walls smooth and cover with wet straw or burlap. Keep moist for five to seven days.

7. When the concrete walls have set up, remove cover material and forms. Seal the bottom edges, inside and out, with concrete mortar.



8. Excavate the bottom of the pit another 0.3-0.4m. Build walls for the pit from reinforced concrete or brick and mortar. The walls reach only as high as ground level. Rake the bottom of the pit and spread it with 0.3m of gravel. See Figure 11.



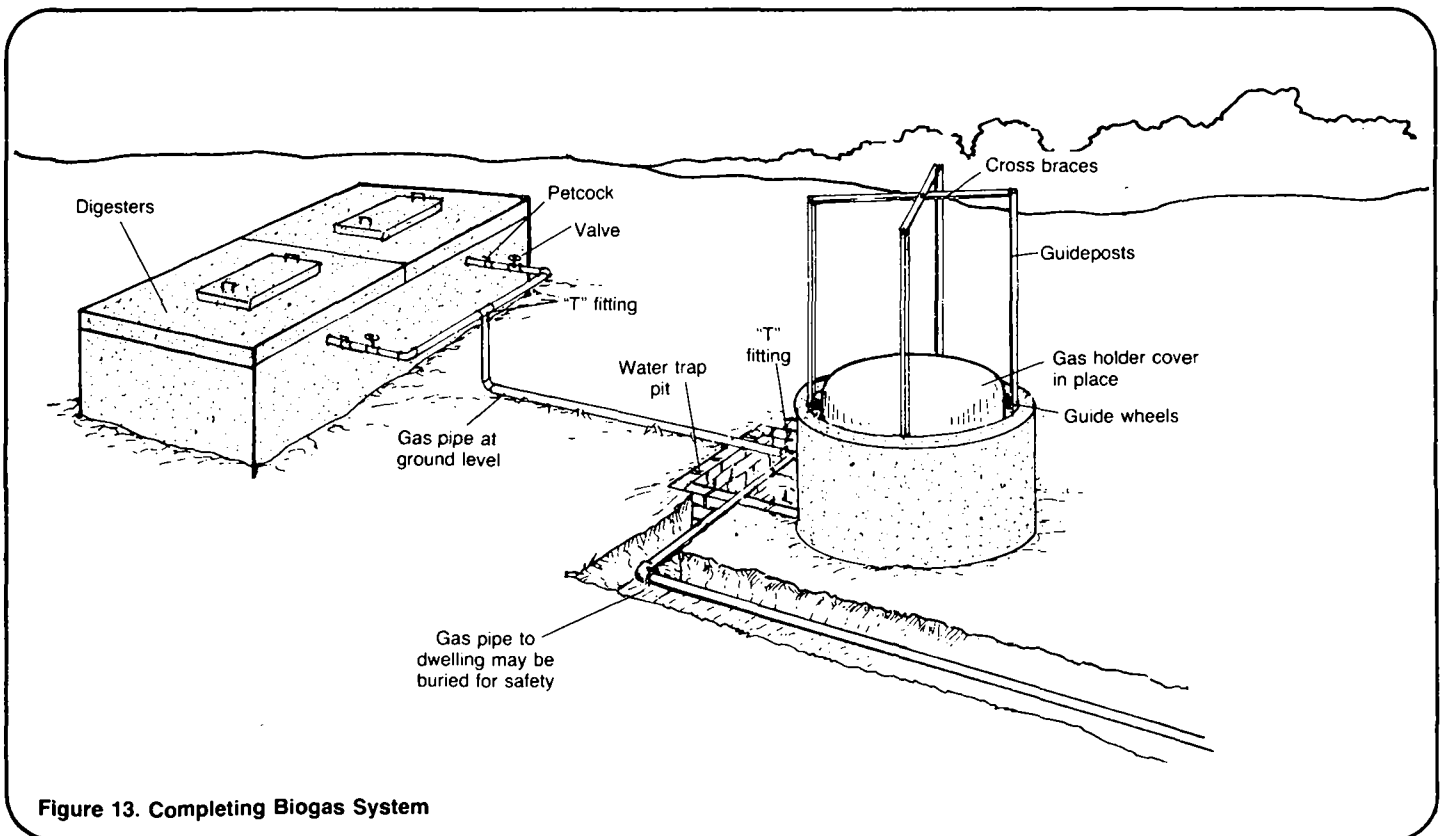
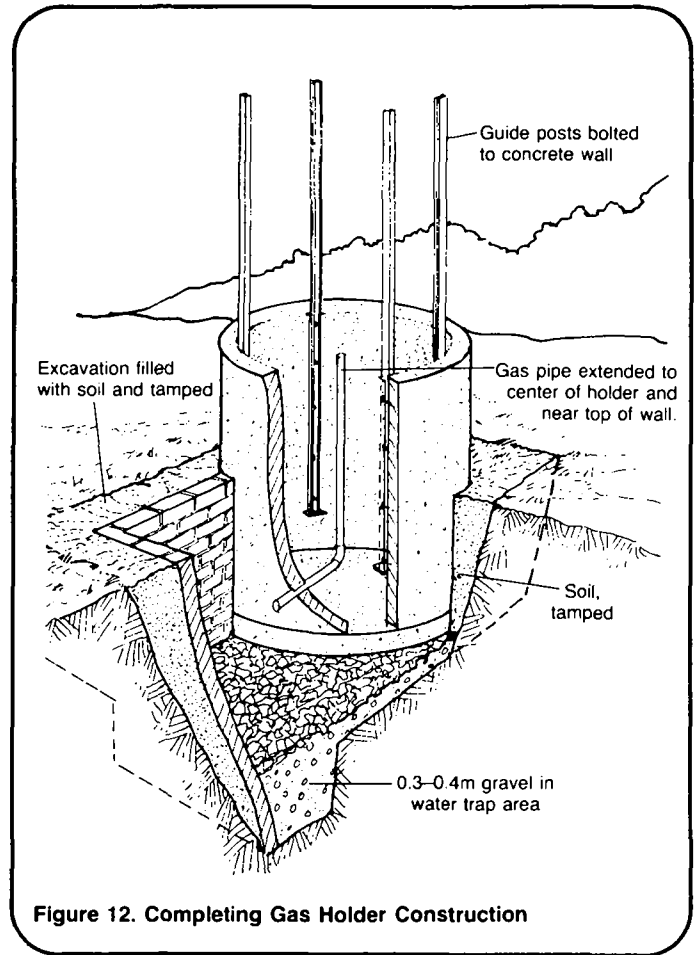
9. When the walls for the pit have set up, fill in the excavation around the pit and gas holder with soil and tamp firmly.

## Installing the Gas Cover

1. Drill holes and set bolts in the concrete wall for the guide posts. Depending on the design, there will be three or four posts. Attach the posts. They should have stops on the lower end. See Figure 12.

2. Extend the gas pipe to the center of the floor and then vertically upward until it is nearly level with the top of the gas holder walls. See Figure 12. All pipe installations must be performed by an experienced pipe fitter.

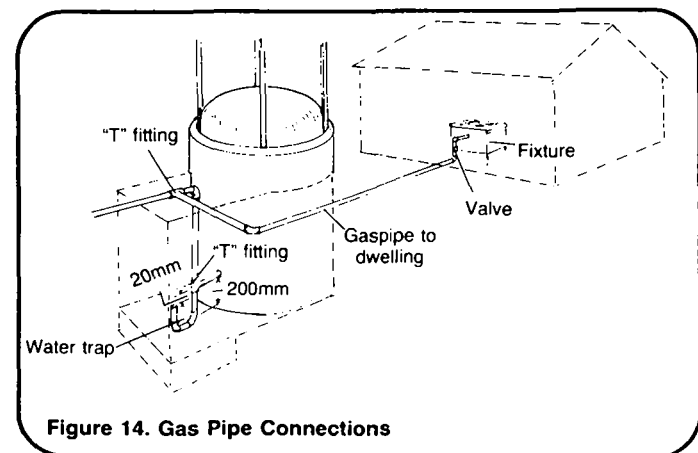
3. Lower the prefabricated gas cover in place. The guide wheels on the cover should fit into the guide posts. The stops on the guide posts will prevent the cover from sliding to the floor of the gas holder and damaging the gas pipe. See Figure 13.



## Installing Gas Pipes

1. Extend gas pipes from the digesters and attach a petcock and valve in each line. Join the lines with a "T" fitting. See Figure 13. Extend the line to the water trap pit and attach a "T" fitting in or near the pit. This fitting will be used to extend the line to the dwelling.

2. Run the gas line across the top of the pit near one side, then down the outside wall of the gas holder to the section of the pipe in the wall. See Figure 14.



3. Connect the gas line and the section of pipe with a "T" fitting. Attach a U-shaped arrangement of pipes to serve as a trap for condensation in the line. The inside leg of the "U" should extend 200mm below the section of pipe in the gas holder wall. The outside leg of the "U", the open end, should extend upward no higher than 20mm below the section of pipe in the wall.

4. Run a gas line from the "T" fitting in or near the pit to the dwelling. This line may be buried 100-150mm below ground to protect it from damage. Install a valve just inside the dwelling. See Figure 14. Extend the line and install the fixtures such as lamps, stoves, and water heaters.

5. After there is gas in the pipelines, check every connection point for leaks. Check the seal around the digester cover. Most leaks can be found by coating connections with a strong soap solution and watching for bubbles.

Table 1. Sample Materials List

Item	Description	Quantity	Estimated Cost
Labor	Construction foreman experienced with Biogas	1	_____
	Worker experienced with pipe fitting	1	_____
	Worker experienced with reinforced concrete	1	_____
	Unskilled workers	4	_____
	Supplies	Prefabricated floating cover: 3mm thick sheet iron; 1.60m diameter; 2.17m high	_____
	Guide posts; galvanized iron	_____	_____
	Guide wheels	_____	_____
	Gas pipe: 18mm diameter	_____	_____
	Valves	_____	_____
	Petcocks	_____	_____
	"T" fittings	_____	_____
	"L" fittings	_____	_____
	Fixtures	_____	_____
	Concrete mix	_____	_____
	Reinforcing material	_____	_____
	Material for forms	_____	_____
	Sealer for digester manholes	_____	_____
	Other	_____	_____
Tools	Shovels	_____	_____
	Picks	_____	_____
	Hammers	_____	_____
	Saw	_____	_____
	Trowels	_____	_____
	Wheelbarrow	_____	_____
	Containers: for mixing concrete	_____	_____
	Pipe wrench	_____	_____
	Threader	_____	_____
	Pipecutter	_____	_____
	Hacksaw	_____	_____
	Other	_____	_____

Total Estimated Cost = \_\_\_\_\_



**Table 2. Sample Work Plan for Constructing a Biogas System**

Time Estimate	Day	Task	Personnel	Materials/Tools
2 hours	1	Layout system on ground	Foreman (always present); 1 worker	Map; drawings; measuring tape; stakes
1½ days	1-2	Excavate for digesters	4 workers	Picks; shovels
2 days	3-4	Build digester floor, tops, and manhole covers	4 workers; 1 worker experienced with concrete	Wood; hammer; saw; nails; cement; sand; gravel; water; trowels; steel bars; mixing containers; horseshoes
4 days	5-8	Keep moist for 4 days	1 worker	Wet straw
1 day	9	Build digester walls	4 workers; 1 worker experienced with concrete	Wood; hammer; saw; nails; cement; sand; gravel; water; trowels; steel bars; mixing containers
4 days	10-13	Keep moist for 4 days	1 worker	Wet straw
1 day	14	Mortar tops in place; set manhole covers in place; fill excavation with soil	4 workers; 1 worker experienced with concrete mortar	Concrete mortar mix; shovels
1 day	15	Excavate for gas holder	4 workers	Picks; shovels
1 day	16	Build gas holder floor	4 workers; 1 worker experienced with concrete	Material for forms; cement; sand; gravel; water; trowels; steel bars; mixing containers
4 days	17-20	Keep moist for 4 days	1 worker	Wet straw
1 day	21	Build wall forms	4 workers; 1 worker experienced with concrete	Material for forms; cement; sand; gravel; water; trowels; steel bars; mixing containers
4 days	22-25	Keep moist for 4 days	1 worker	Wet straw
1 day	26	Build water trap pit	2 workers; 1 worker experienced with masonry	Shovels; trowel; mortar mix; bricks; gravel
2 days	27-28	Let set for 2 days	----	----
½ day	29	Fill excavation with soil	4 workers	Shovels
1½ days	29-30	Install guide posts and extend gas pipe in holder	4 workers; 1 pipe-fitter	Drill; bolts; guide posts; gas pipe; fittings; wrench; threader
½ day	31	Install gas cover	4 workers	Pre-built gas cover
1½ days	31-32	Install gas pipes	2 workers; 1 pipe-fitter	Gas pipes; fittings; valves; petcocks; wrench; threader; fixture

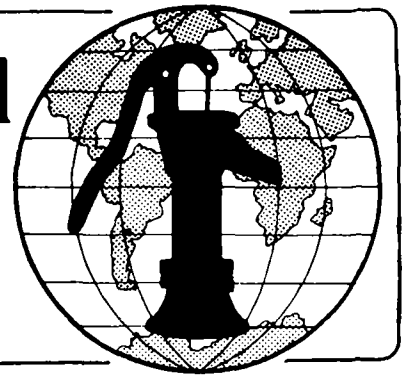
## Notes

## Notes

## Notes

**Technical Notes** are part of a set of "Water for the World" materials produced under contract to the U.S. Agency for International Development by National Demonstration Water Project, Institute for Rural Water, and National Environmental Health Association. Artwork was done by Redwing Art Service. Technical Notes are intended to provide assistance to a broad range of people with field responsibility for village water supply and sanitation projects in the developing nations. For more detail on the purpose, organization and suggestions for use of Technical Notes, see the introductory Note in the series, titled "Using 'Water for the World' Technical Notes." Other parts of the "Water for the World" series include a comprehensive Program Manual and several Policy Perspectives. Further information on these materials may be obtained from the Development Information Center, Agency for International Development, Washington, D.C., 20523, U.S.A.

# Water for the World



## Operating and Maintaining a Landfill Technical Note No. SAN. 3.0.1

A landfill is a means of disposing of solid waste by burying it. This prevents contamination of water supplies and breeding of flies and rats which may spread disease to people in the community. A landfill eliminates the unpleasant odors and unsightliness of solid waste. Operating a landfill involves excavating cover soil, placing wastes in piles, strips, or layers, compacting the waste, and covering it with the excavated soil. Maintaining a landfill involves inspection and repair of damage to the landfill and access road. Success of a landfill depends on compacting the waste and having good and ample soil to it.

This technical note describes how to operate and maintain a landfill. Read the entire technical note before beginning operation.

### Materials Needed

The project designer must provide three papers before operation can begin:

1. Location map similar to Figure 1, showing the site for the landfill in relation to dwellings, water wells, streams, roads, and so on.

### Useful Definitions

**CONTAMINATE** - To make unclean by introducing an infectious (disease-causing) substance such as leachate or bacteria from animal manure.

**GARBAGE** - Food and crop wastes from growing, harvesting, storing, preparing, cooking, or serving of food; these materials rot quite quickly.

**LEACHATE** - A liquid formed when rain, surface water, or ground water passes through a landfill and accumulates dissolved and suspended matter or organic wastes; leachate can contaminate water supplies.

**RUBBISH** - All material other than garbage that is thrown away, including broken dishes, utensils, and furniture; useless scraps of wood, metal, or glass; sweepings from house, yard, or street; and anything else that is discarded.

**SOLID WASTE** - Garbage, rubbish, animal manure, dead animals, and ashes.

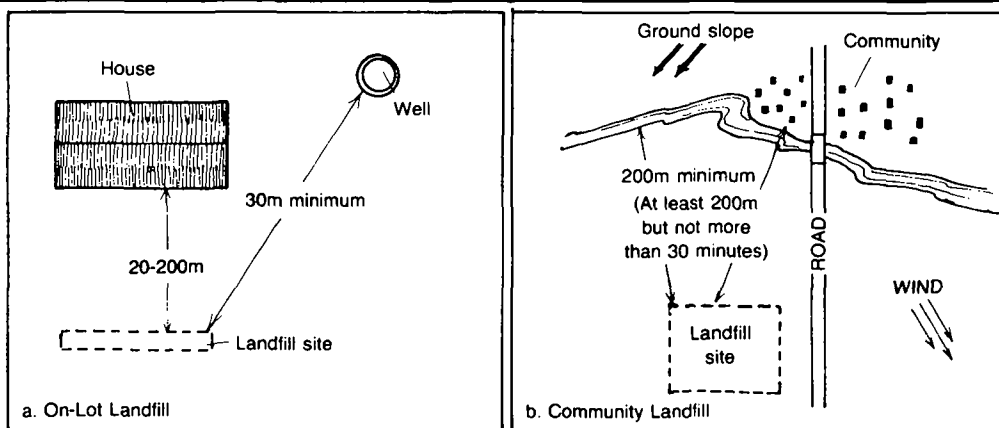


Figure 1. Location Map

2. Design drawings similar to one or more of Figures 2, 3, and 4, showing the dimensions of the landfill.

3. Materials list similar to Table 1, showing all personnel and equipment needed to operate the landfill.

You will also need:

4. The personnel and equipment described in the materials list.

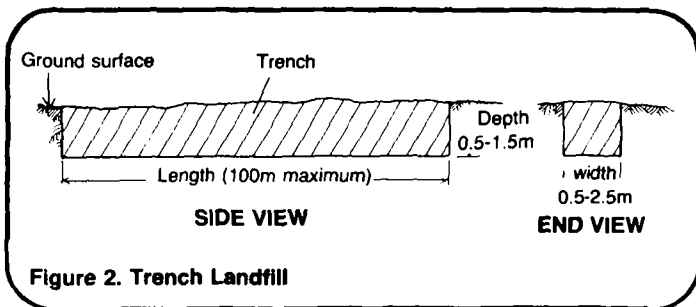


Figure 2. Trench Landfill

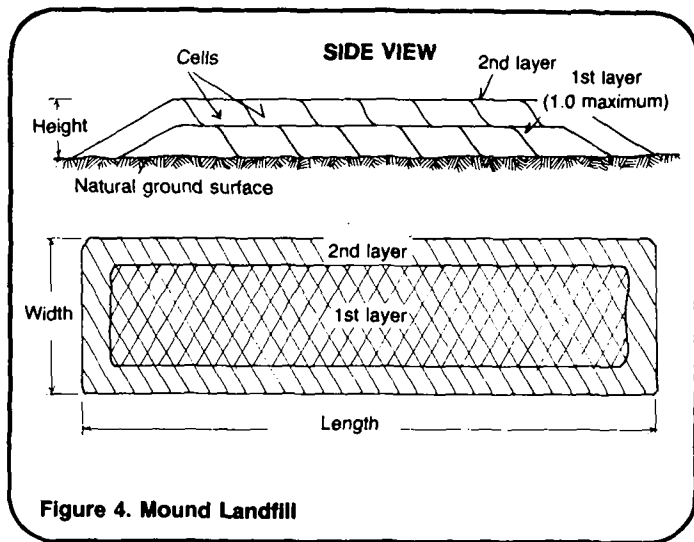


Figure 4. Mound Landfill

**Table 1. Sample Materials List**

Item	Description	Quantity	Estimated Cost
Labor	Foreman (for 5 years)	1	---
	Workers (for 5 years)	4	---
Equipment	Tape measure	---	---
	Animal-drawn plow or scoop	---	---
	Animal-drawn cart to transport cover soil	---	---
	Animals	---	---
	Shovels	---	---
	Rakes	---	---
	First-aid kit	---	---
	Boots	---	---
	Gloves	---	---
	Vehicle with tires, sled or paddies for compaction	---	---
Total Estimated Cost *			---

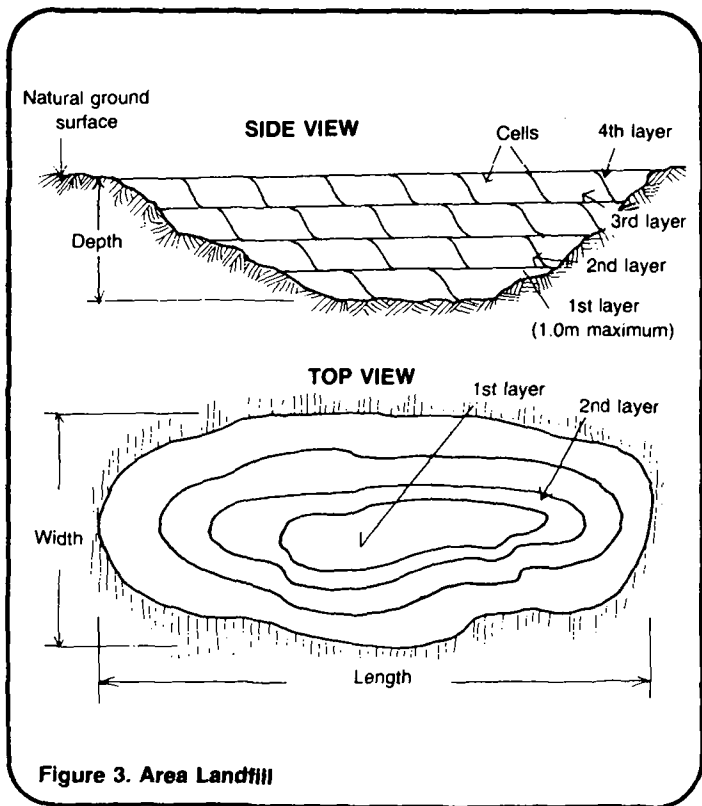


Figure 3. Area Landfill

**Caution!**

Care must be taken when handling solid wastes to prevent cuts from sharp-edged scraps and to prevent injuries from lifting heavy objects and containers. Boots and gloves should be worn by workers and community members using the landfill.

Cleanliness is important to prevent the spread of disease. Workers, community members, and householders should wash their hands after handling solid wastes, especially before preparing or eating food.

## Operating On-Lot Landfills

### Trench Method

1. Using the location map, design drawings, and measuring tape, locate the site and mark the dimensions of the trench on the ground. Set wooden stakes or pointed sticks at the corners and along the sides of the trench. These stakes may have to be replaced from time to time because the trench is designed to last at least five years. See Figure 5.

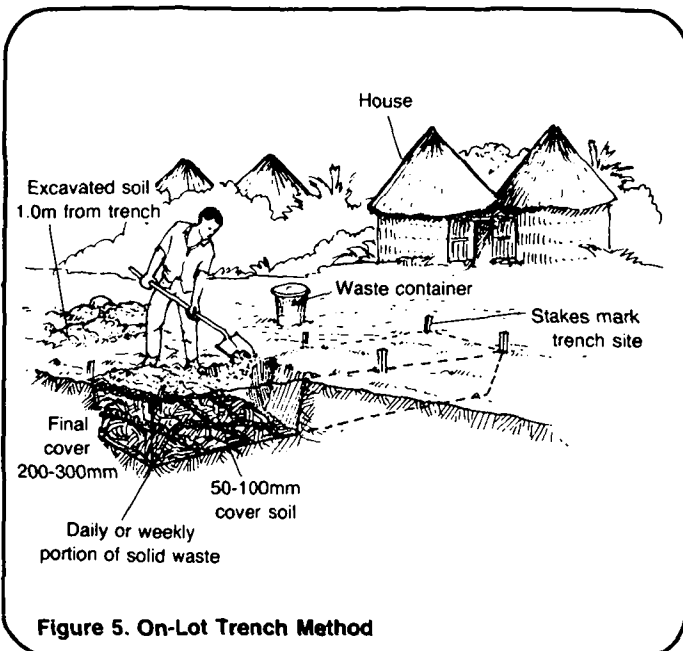


Figure 5. On-Lot Trench Method

2. Begin excavating the trench at one end. Dig to the design width and depth of the trench to avoid contaminating ground water with leachate. Dig only about 1.0m of the design length. If the entire trench length is dug, it may gradually fill with soil due to wind and rain erosion and have to be re-excavated.

3. Pile excavated soil about 1.0m from the edge of the trench to allow a person to move between the soil and the trench. See Figure 5.

4. Daily or weekly, dump garbage or other solid waste in the trench, starting at the end, and cover with 50-100mm of soil. Do not leave exposed solid waste in the trench. Compact it and cover immediately. See Figure 5.

5. When the toe of the waste and cover soil nears the unexcavated portion of the trench, dig another meter or so of length to the design width and depth. This may be two to eight months after the initial excavation, depending on the amount of solid waste and the design of the trench.

6. When the waste and cover soil have nearly risen to the original ground surface, place a final cover on it of 200-300mm of soil or composted material as shown in Figure 5. See "Operating and Maintaining Compost Toilets," SAN.1.0.6, and "Operating and Maintaining a Composting System," SAN.3.0.2.

### Area Method

1. Using the location map, design drawings, and measuring tape, locate the site and mark the boundaries of the depression or low spot with wooden stakes or pointed sticks. See Figure 6.

2. Excavate cover soil from the bottom and sides of the depression or from nearby higher ground. Pile it near the edge of the depression.

3. Daily or weekly, dump solid waste in the depression, rake it fairly level, and cover with 50-100mm of soil. See Figure 6.

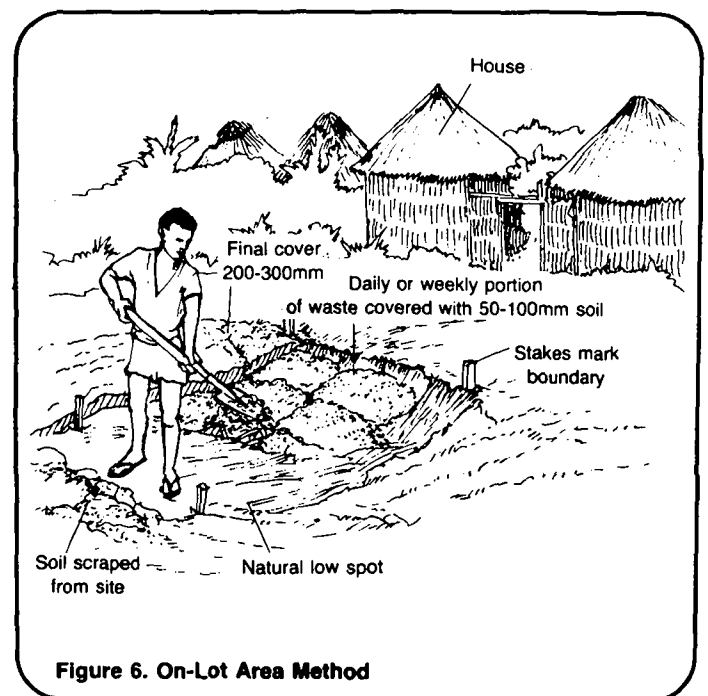


Figure 6. On-Lot Area Method

4. When the waste and cover soil reach the designed height of the fill, place a final cover on it of 200-300mm of soil or composted material.

### Mound Method

This method may not be suitable for on-lot disposal. It is generally easier to haul solid waste to an off-lot site than to haul cover soil onto the lot.

## Operating Community Landfills

### Trench Method

1. Using the location map, design drawings, and measuring tape, locate the site and mark the dimensions of the trench on the ground. Set wooden stakes at the corners and along the sides of the trench.

2. If the site is not along a road, an access road will have to be constructed. If there are no paid workers, this should be a community effort. Clear off vegetation along a path from the nearest road to the site and spread gravel, crushed rock, cinders, or equivalent on it. Make the access road wide enough for two vehicles or carts to pass. Improve the road from the community to the site or the access road with gravel or equivalent to ensure that it remains open in wet weather.

3. Begin excavating the trench at one end. If there are no paid workers, this should be a community effort with one or more days set aside for the work. The excavation could be done with shovels, but animal-drawn plows and scoops or mechanized equipment, if available, may be preferable. Dig to the design width and depth of the trench, but only about one-fifth to one-tenth of the length. If the entire trench length is excavated, it may fill with soil due to wind and rain erosion and have to be re-excavated. This will contain about six to twelve months' accumulation of the community's solid waste. See Figure 7.

4. Pile excavated soil 1-2m from the side of the trench to allow movement of carts between the soil and the trench.

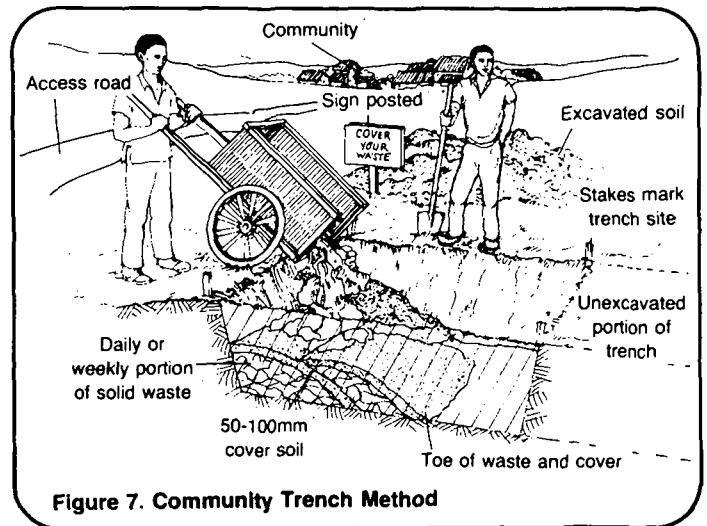


Figure 7. Community Trench Method

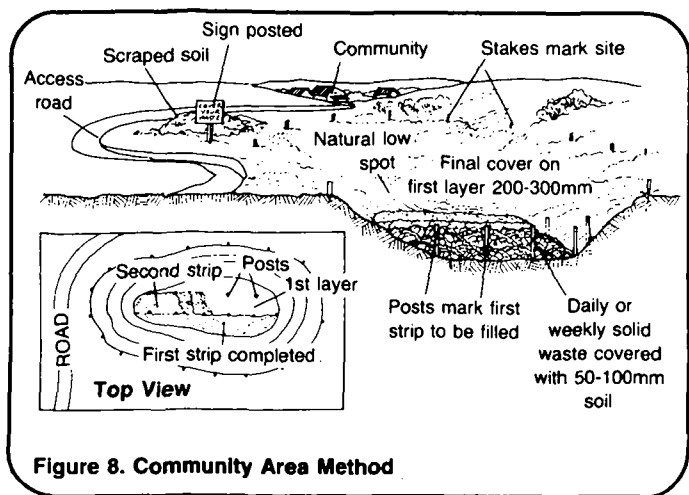
5. The landfill is now ready for use. It can be operated daily with individuals from the community freely disposing of waste and covering it with soil. Or it can be operated on a more controlled basis, with access to the landfill limited to once or twice a week with a volunteer supervisor present. The latter method will better ensure proper use of the landfill. If the landfill is operated by paid workers, they will be responsible for its proper use. These may be the same workers who collect solid waste in the community and transport it to the landfill. See "Operating a Solid Waste Collection System," SAN.3.0.3.

6. Post signs that inform the community of the days and hours that the landfill is open, and that remind the users to "Cover Your Waste!" If solid waste is left exposed in the trench, it is an open dump and not a landfill. An open dump is a health hazard; it is a breeding place for rats and flies and a physical hazard to children.

7. Have the community members or paid workers dump solid waste in the trench, beginning at the end, compact it, and cover it with 50-100mm of soil.

8. When the toe of the waste and cover soil nears the unexcavated portion of the trench, usually after at least six months, dig another one-fifth to one-tenth of the trench length of the design width and depth. This should be a community effort if it is not done by paid workers. See Figure 7.





6. Post informative and instructional signs. See step #6 for "Trench Method."

7. Have the community members or paid workers dump solid waste within the boundaries of the layer or strip, rake it fairly level, compact it, and cover with 50-100mm of soil.

8. As each portion of the layer or strip nearly reaches the design height, cover with 200-300mm of soil and extend the access road onto the filled portion. Wheel the carts or vehicles over the filled area and dump waste at the working face of the layer or strip. If necessary, lay down logs, bamboo matting, or equivalent, to prevent vehicles from sinking in. See Figure 8.

9. When the waste and cover soil have nearly risen to the original ground surface, cover it with at least 300mm of cover soil or composted material. See "Operating and Maintaining Compost Toilets," SAN.1.0.6, and "Operating and Maintaining a Composting System," SAN.3.0.2.

9. When the first layer or strip has been completed, set posts, poles, or long sticks to mark the boundaries and height of the second layer or strip.

10. When the landfill nearly reaches its designed height, compact it, and cover with at least 300mm of soil or composted material.

#### Area Method

1. Using the location map, design drawings, and measuring tape, locate the site and mark the boundaries of the depression or low spot with wooden stakes. See Figure 8.

2. Improve the access road. See step #2 for "Trench Method."

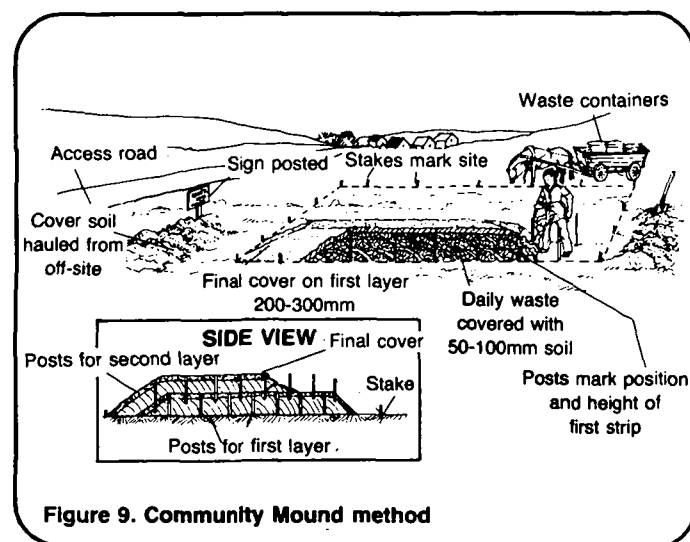
3. Scrape or excavate cover soil from within the depression or from nearby higher ground. If there are no paid workers, this should be a community effort. Pile the excavated soil near the edge of the depression but out of the way of traffic to and from the landfill.

4. If the depression is to be filled in strips or layers, set posts, poles, or long sticks to mark the boundaries and height of the first layer or strip. See Figure 8.

5. The landfill is now ready for use. See step #5 for "Trench Method."

#### Mound Method

1. Using the location map, design drawings and measuring tape, locate the site and mark the boundaries with wooden stakes. See Figure 9.



2. Improve the access road. See step #2 for "Trench Method."

3. Scrape or excavate cover soil and haul it to the site. If there are no paid workers, this should be a community effort. Pile excavated soil so that it is readily available yet does not impede the flow of traffic.

4. Set posts, poles, or long sticks to mark the boundaries and height of the first strip. See Figure 9.

5. The landfill is now ready for use. See step #5 for "Trench Method."

6. Post informative and instructional signs. See step #6 for "Trench Method."

7. Have community members or paid workers dump solid waste within the boundaries of the first strip, rake it fairly level, compact it, and cover with 50-100mm of soil.

8. As the first layer reaches its designed height, cover with 200-300mm of soil if the mound is to be multi-layered. If the mound is to be single-layered, cover with at least 300mm of soil or composted material. See Figure 9.

9. When the first strip has been completed, set posts, poles, or long sticks to mark the boundaries and height of the second strip. If the landfill is to be multi-layered, carts or vehicles must be wheeled onto the first layer. If necessary, lay down logs, bamboo matting, or equivalent, to prevent vehicles from sinking in.

10. When the landfill reaches its designed height, compact it, and cover with at least 300mm of soil or composted material.

## **Maintaining a Landfill**

Maintaining a landfill involves inspection and repair of the site and access road during operation and preparation for final use of the site after completion.

## Inspection and Repair

Keep the surface of the landfill fairly smooth and level during operation. This makes it easier to find damage due to erosion or burrowing animals. Inspect the surface of the landfill once a month and after heavy rains. Fill in with soil any eroded areas and holes made by burrowing animals. If burrowing animals are a constant problem, set traps or erect fences to keep them away. Surface water should not be allowed to flow over the landfill. If necessary, divert water with shallow trenches or small dams.

Inspect the access road once a month and after heavy rains. Repair eroded areas with soil, sand, and gravel, or equivalent.

## Operation

When the landfill has reached its designed limits of length, width, and height, a new landfill will have to be designed and put into operation. The new site may or may not be adjacent to the old one. Consult the project designer.

Plant grass or similar vegetation on the top and sides of the completed landfill. The area may be used for a park, soccer field, grazing land or other purpose. It should not be used to plant crops because deep roots will be impeded from growing and plowing may uncover solid waste.

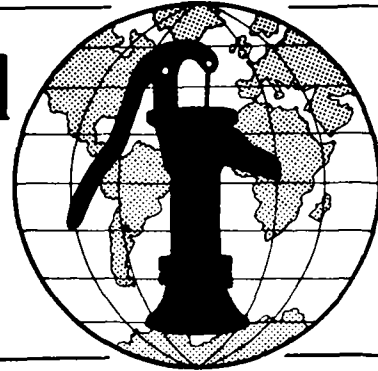
Inspect the access road once a month and after heavy rains. Repair eroded areas with soil, sand, and gravel, or equivalent.

## Notes

## Notes

**Technical Notes** are part of a set of "Water for the World" materials produced under contract to the U.S. Agency for International Development by National Demonstration Water Project, Institute for Rural Water, and National Environmental Health Association. Artwork was done by Redwing Art Service. Technical Notes are intended to provide assistance to a broad range of people with field responsibility for village water supply and sanitation projects in the developing nations. For more detail on the purpose, organization and suggestions for use of Technical Notes, see the introductory Note in the series, titled "Using 'Water for the World' Technical Notes." Other parts of the "Water for the World" series include a comprehensive Program Manual and several Policy Perspectives. Further information on these materials may be obtained from the Development Information Center, Agency for International Development, Washington, D.C., 20523, U.S.A.

# Water for the World



## Operating and Maintaining a Composting System Technical Note No. SAN. 3.0.2

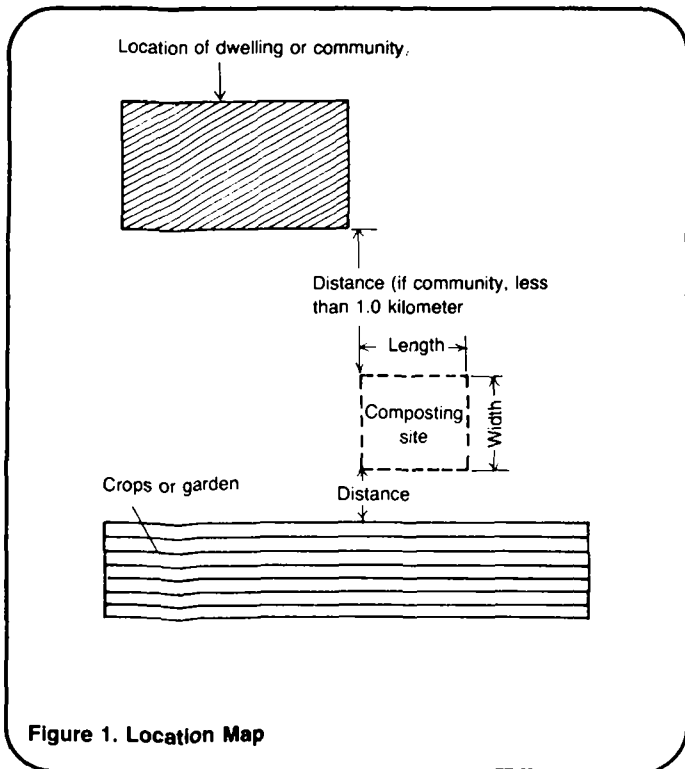
A composting system is a means of turning garbage, animal manure, other organic wastes, and, in some cases, excreta into compost. Operating a composting system involves preparing the organic materials, piling the material, turning the pile, and using the finished compost. Successful operation depends on turning the pile to keep it aerated. Maintaining the system involves keeping the site clean and keeping tools in good repair.

This technical note describes how to operate and maintain a composting system. Read the entire technical note before beginning operations.

### Materials Needed

Before operations can begin, the project designer must provide:

1. Location map similar to Figure 1.



2. Design drawings similar to Figures 2, 3, 4, or 5.

3. Materials list similar to Table 1.

You will also need:

4. All labor and tools described in the materials list.

### Useful Definitions

**COMPOST** - A dark, fairly dry, crumbly, odorless material that can be used to improve soil for crops; it is produced from organic wastes.

**EXCRETA** - Human body wastes.

**GARBAGE** - Food and crop wastes from growing, harvesting, storing, preparing, cooking, or serving of food; these materials rot quite quickly.

**ORGANIC** - Derived from living organisms.

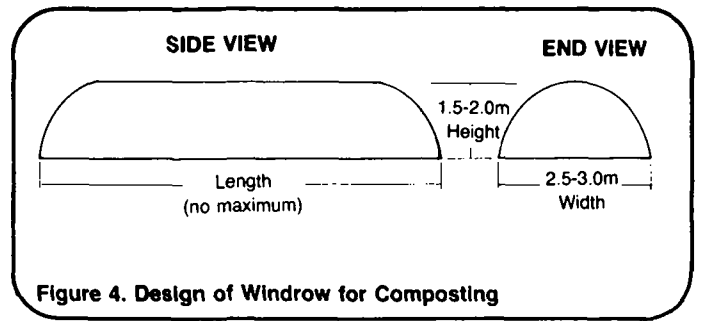
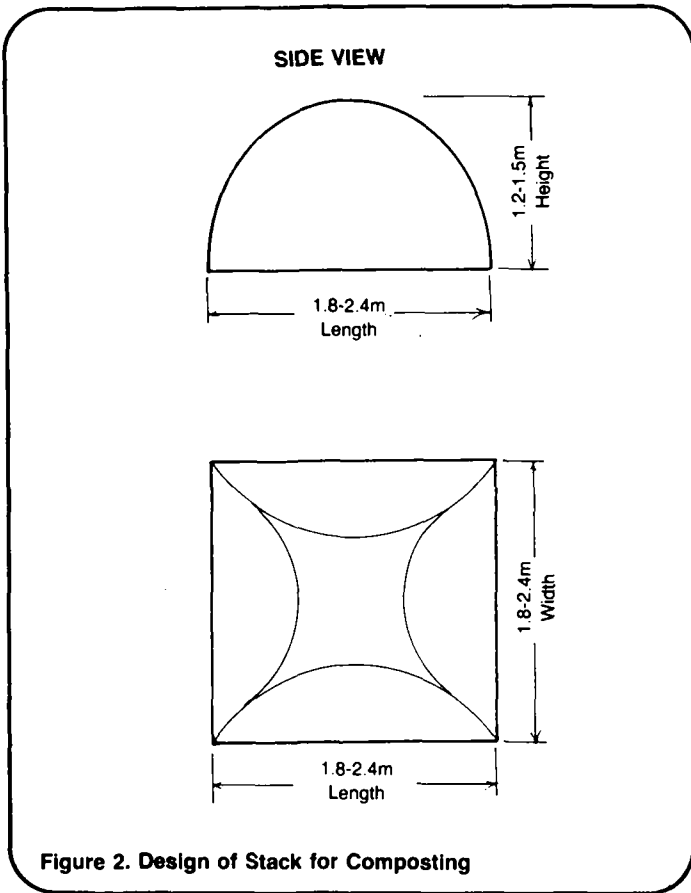
**Table 1. Sample Materials List**

Item	Description	Quantity	Estimated Cost
Labor	Supervisor	1	---
	Laborers	3	---
Tools	Pitchforks	---	---
	Hakes	---	---
	Shovels	---	---
	Brooms	---	---
	Hoes	---	---
	Wood pole: 2m long	---	---
	Carts	---	---
	Boots	---	---
	Gloves	---	---
	Coarse wire screens	---	---
	Shredding tools, clippers, knives, machetes	---	---

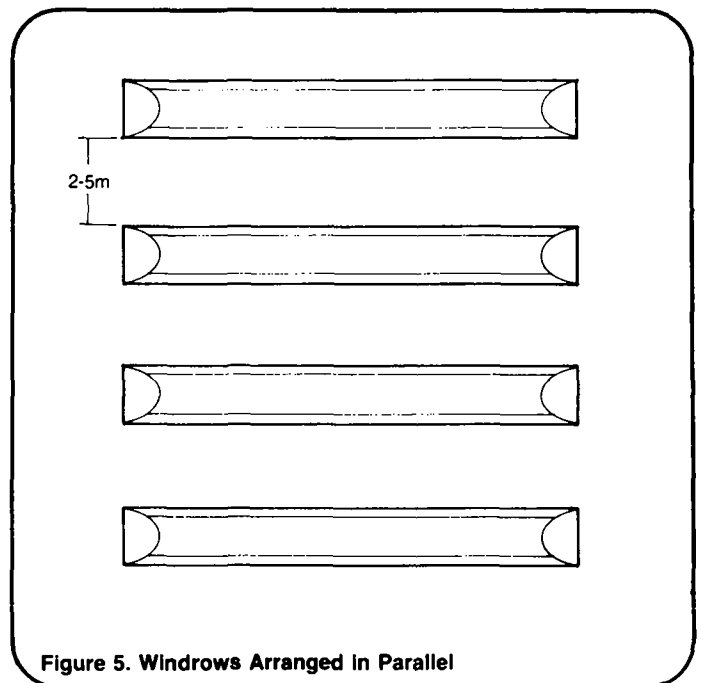
Total Estimated Cost = \_\_\_\_\_

### Preparing the Material

Only organic material can be composted. Separate out inorganic materials, such as metal, glass, plastic, rocks, gravel, and sand. This



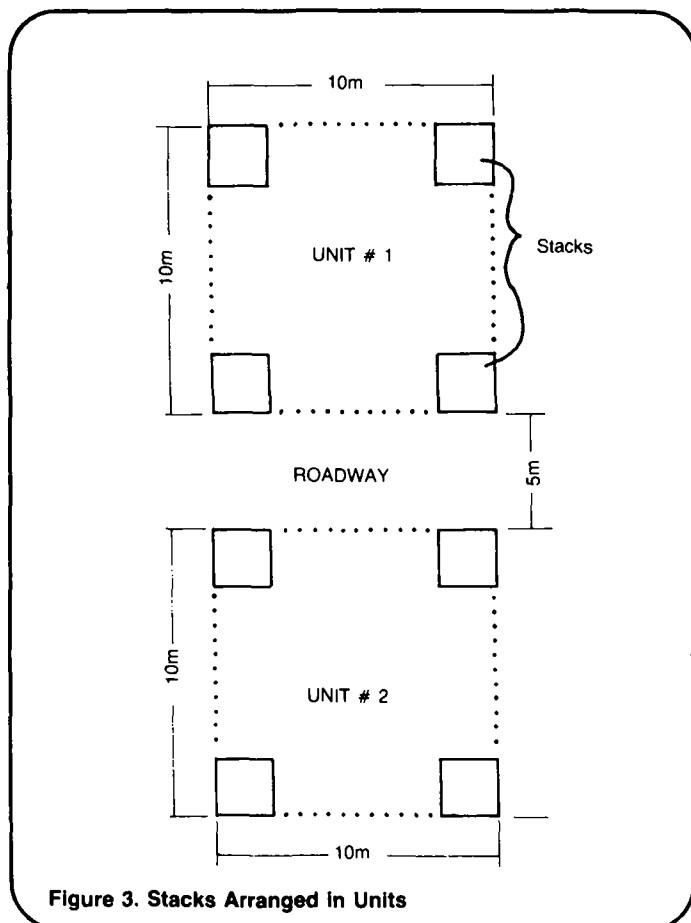
is best done prior to collection at the source of the waste--household, marketplace, or factory. For details on collection, see "Operating a Solid Waste Collection System," SAN.3.0.3.



When garbage and other organic wastes have been transported to the composting site, further preparation may be necessary. Separate out organic materials that will not readily decompose, such as branches, pieces of wood, and animal bones. Or, use coarse wire screen to separate out non-compostables after the compost is finished. Non-compostables should be buried at the compost site. Materials such as cobs, animal parts, and large pieces of organic waste should be chopped up before being added to the compost pile. See Figure 6.

### Piling the Material

Material to be composted is piled in stacks or windrows. Each pile consists of a balance between two types of orga-



nic waste. The first type includes dry vegetable matter such as straw, cane stalks, pea vines, potato tops, banana stems, dead leaves, and paper. The second type includes excreta, animal manure, and fresh food scraps. The best mixture will be learned by experience in the field. After separating the non-compostables, shred or cut large pieces to speed composting and make turning easier. In general, the mixture should be moist, but not soggy. A person should be able to step on it without his foot sinking in.

1. Begin the stack or windrows with a 200-400mm layer of straw or dry grassy material to soak up liquid. See Figure 6. If the windrow method is used, build the windrow in sections and spread only enough straw for the first section.

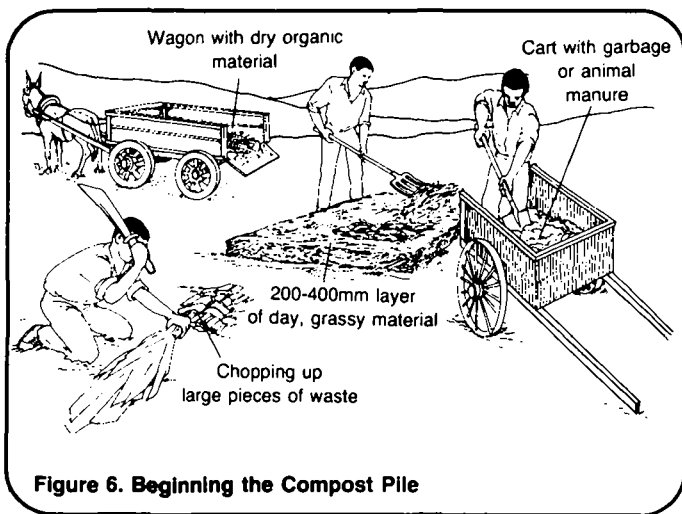


Figure 6. Beginning the Compost Pile

2. If excreta is not to be composted, add a balanced mixture of organic materials until the stack or section of windrow reaches its designed dimensions. Always pile the material loosely to speed the composting process.

3. If excreta is to be composted, the stack method should be used and the stack must be built in layers. See Figure 7.

3a. On top of the 200-400mm layer of straw, spread 300mm of a balanced mixture not including excreta.

3b. Use a mixture of organic materials to build a 300mm thick enclosure around the top of the second layer.

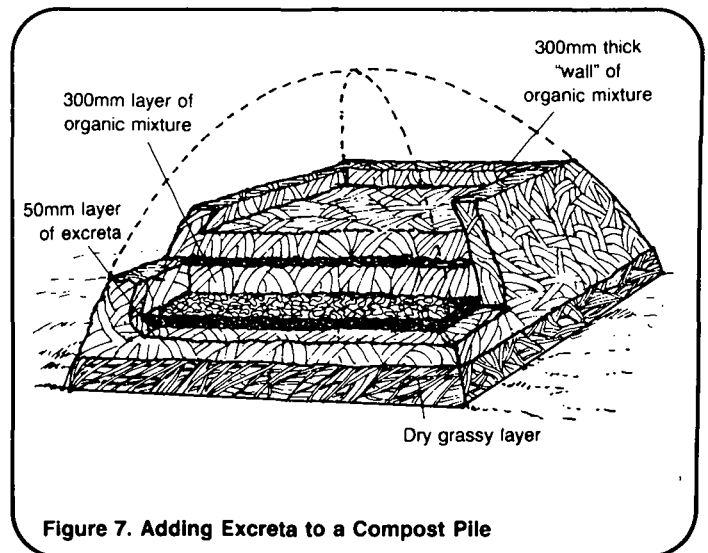


Figure 7. Adding Excreta to a Compost Pile

3c. Spread a 50mm thick layer of excreta within the enclosure.

3d. Cover the excreta with a 300mm layer of mixed organic materials.

3e. Continue building the stack in layers with 50mm of excreta and 300mm of organic materials until the stack reaches its designed height.

4. The entire stack or section of windrow may be covered with about 300mm of dry grassy material to reduce its attractiveness to flies. See Figure 8.

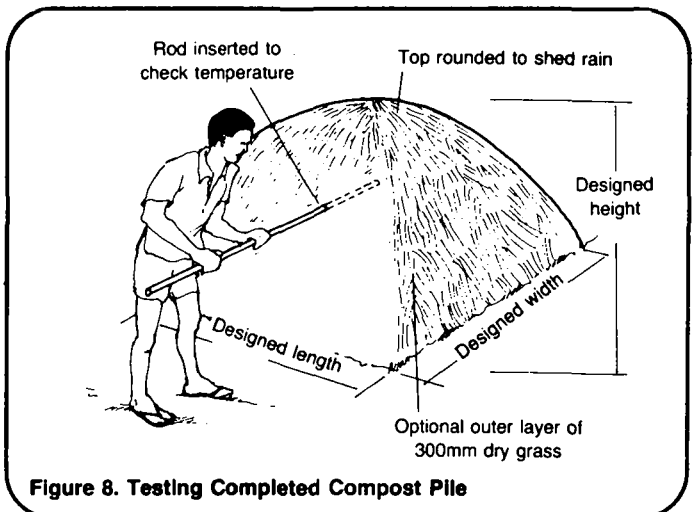


Figure 8. Testing Completed Compost Pile

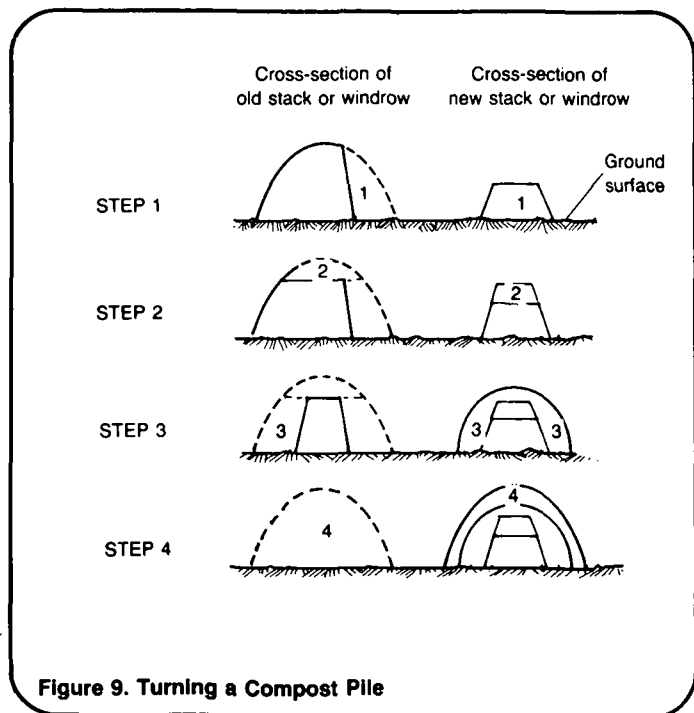
5. Make the top of the stack or windrow rounded to help shed rainwater.

6. As more organic material is brought to the composting site, build more stacks or add sections to the windrow.

## Turning the Pile

Soon after the stack or section of windrow is built, the interior will begin to heat up as biological processes change organic material into compost. The temperature inside the pile should reach about 60°C after a few days. Check the temperature by inserting a long wood or iron pole into the pile. See Figure 8. After ten minutes, withdraw the rod. The end should be too hot to hold in the hand and it should be damp, but not wet. If the pole and the interior of the pile are too dry, sprinkle the pile with water. If they are too wet, add dry grassy material to the interior of the pile. If the pile is still not hot after two to four days, the mixture of materials in the pile is not correct and the pile will have to be rebuilt. See "Piling the Material."

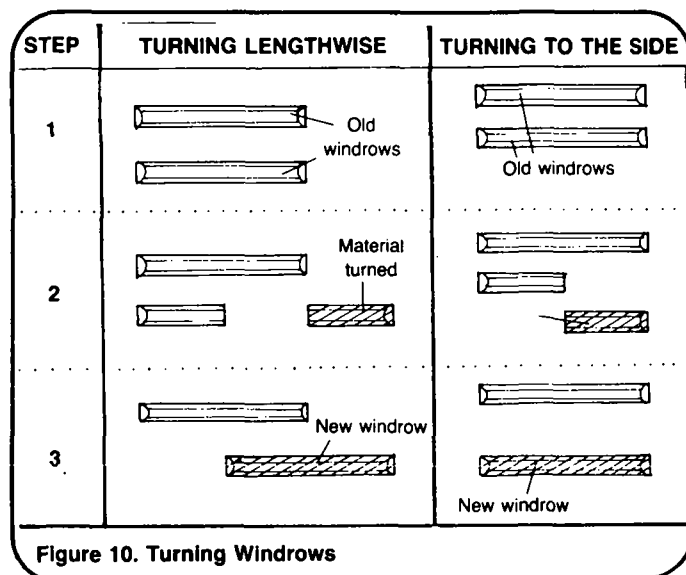
If the temperature is correct, the material inside the pile is decomposing into compost. After no more than five days, turn the pile inside-out with a pitchfork so that the cooler material on the outside of the pile can be turned into the inside. Figure 9 shows one method of turning a stack or section of windrow. Turning is very important since the heat inside the pile kills fly larvae and disease-causing organisms.



Turn the pile a second time after four or five days. By now, the contents of the pile will no longer look like the original organic materials. The composting process is nearly complete. After a third four to five day period, the contents of the pile should be finished compost. If not, turn the pile a third time. In temperate climates, composting takes three to four weeks. In tropical climates, less time is needed.

You can test for finished compost by sight and feel. It is a dark, loose-textured material. Squeezed in the hand, it forms a firm ball with a moist but not wet surface.

If windrows are used, they may be turned lengthwise or to the side as shown in Figure 10.



If a number of stacks are used, two stacks may be combined into one during the first turn, and two combined stacks combined during the second turn. See Figure 11.

## Using Compost

Finished compost will have up to 50 percent less volume than the original organic materials. It may be stored for up to six months before it is used.

Cart compost to the garden or crop land, shovel it on the ground, and work it into the soil with a hoe or rake.



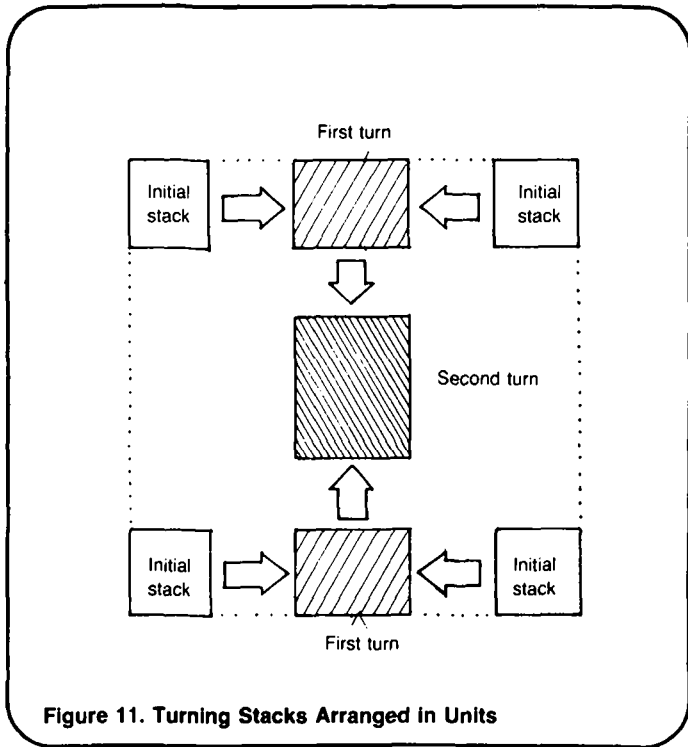


Figure 11. Turning Stacks Arranged in Units

See Figure 12. One  $m^3$  of compost can cover up to  $100m^2$  of ground. The only parasite that may survive composting is the eggs of the roundworm.

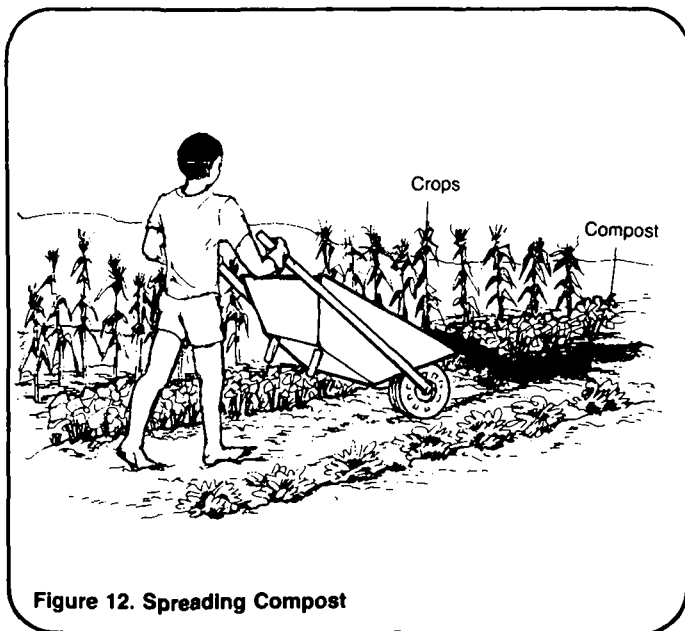


Figure 12. Spreading Compost

## Maintaining a Composting System

Keep the composting area clean. Use a coarse broom or small rake to sweep loose debris into the stack or windrow. Plant trees or bushes around the site to prevent wind from scattering material.

Keep pitchforks, rakes, carts, and other tools clean and in good repair.

Maintain a record similar to Table 2 showing all operation and maintenance activities. The turning day records are the most important so that all the piles can be turned on a regular basis.

Table 2. Sample Operations Record for a Composting System

Date	Task
6/1	Built stack A.
6/4	Checked temperature in A. Okay.
6/8	Turned stack A. First turn.
6/10	Built stack B.
6/13	Checked temperature in B. Okay.
6/15	Turned stack A. Second turn.
6/17	turned stack B. First turn.
6/19	Built stack C.
6/22	checked temperature in C. Okay. <sup>Removed stack A.</sup> spread in field.
6/24	Turned stack B. Second turn.
6/26	Turned stack C. First turn.
6/28	Built stack D.
7/1	Checked temperature in D. Okay. <sup>Removed stack B.</sup> spread in field.
7/3	Turned stack C. Second turn.

### Caution!

Always wear boots and gloves when handling compost.

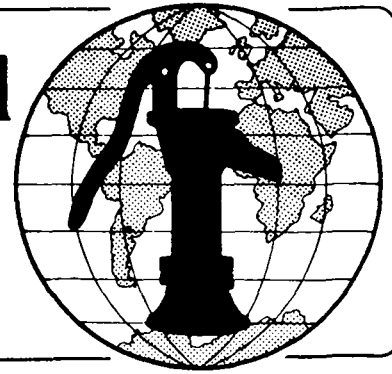
## Notes

## Notes

## Notes

**Technical Notes** are part of a set of "Water for the World" materials produced under contract to the U.S. Agency for International Development by National Demonstration Water Project, Institute for Rural Water, and National Environmental Health Association. Artwork was done by Redwing Art Service. Technical Notes are intended to provide assistance to a broad range of people with field responsibility for village water supply and sanitation projects in the developing nations. For more detail on the purpose, organization and suggestions for use of Technical Notes, see the introductory Note in the series, titled "Using 'Water for the World' Technical Notes." Other parts of the "Water for the World" series include a comprehensive Program Manual and several Policy Perspectives. Further information on these materials may be obtained from the Development Information Center, Agency for International Development, Washington, D.C., 20523, U.S.A.

# Water for the World



## Operating a Solid Waste Collection System Technical Note No. SAN. 3.O.3

Operating a solid waste collection system involves removing solid waste from houses, yards, marketplaces, factories, or public buildings and transporting it to a landfill, composting area, or biogas plant. Required maintenance includes cleaning and repairing equipment, containers, and vehicles, and continuing the routine of collection.

This technical note describes how to operate and maintain three types of solid waste collection systems. Read the entire technical note before beginning operation.

### Useful Definitions

**GARBAGE** - Food and crop wastes from growing, harvesting, storing, preparing, cooking, or serving of food; these materials rot quickly.

**RUBBISH** - All material other than garbage that is thrown away, including broken dishes, utensils, and furniture; useless scraps of wood, metal, or glass; sweepings from house, yard, or street; and anything else that is discarded.

**SOLID WASTE** - Garbage, rubbish, animal manure, dead animals, and ashes.

### Materials Needed

Before operations can begin, you need:

1. A materials list similar to Table 1 given to you by the project designer.

2. All personnel and materials described on the materials list; and, if a paid-worker system has been designed.

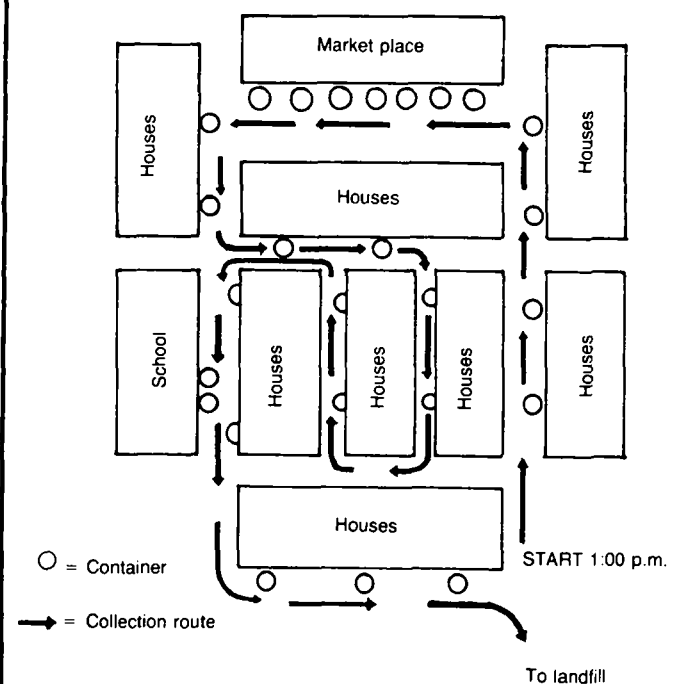
3. A scheduling chart similar to Figure 1 also given to you by the project designer.

**Table 1. Sample Materials List**

Item	Description	Quantity	Estimated Cost
Labor	Supervisor (for one year)	1	---
	Workers (for one year)	4	---
Supplies	Equipment: shovels	---	---
	brooms	---	---
	dust pans	---	---
	Containers: 200-liter metal drum with lids	---	---
	Vehicles: animal-drawn carts	---	---
	Other: gloves	---	---
	boots	---	---
	first-aid kit	---	---
	other	---	---

Total Estimated Cost = \_\_\_\_\_

**Route For Saturday P.M.**



**Figure 1. Sample Schedule Chart**

### Caution!

When lifting heavy containers, use leg muscles and not back muscles to avoid injuries. See Figure 2.

Treat cuts immediately.

Wash hands after handling solid waste.

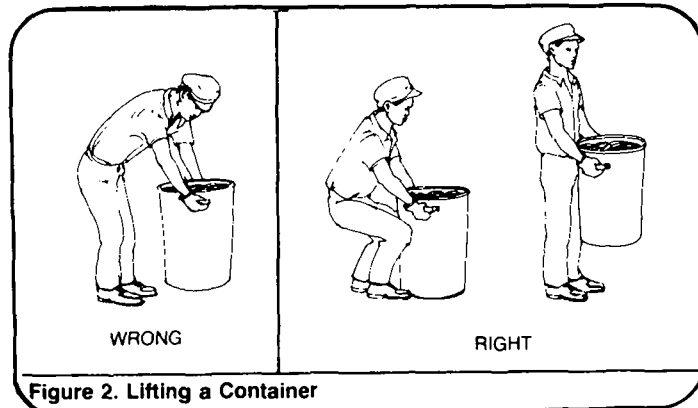


Figure 2. Lifting a Container

### Operating a Household Collection System

In this system, solid waste is removed from houses or yards and carried or carted to an on-lot site for disposal or reuse. See "Operating and Maintaining a Landfill," SAN.3.0.1, "Operating and Maintaining a Composting System," SAN.3.0.2, and "Operating and Maintaining a Biogas System," SAN.3.0.4.

Place a garbage can with a lid in the kitchen or near the house, perhaps on a stand to keep it away from animals. Put food scraps in the can after each meal. Every two or three days carry the can to the on-lot compost stack or landfill. When the can has been emptied, clean it out and return it to the kitchen or stand. See Figure 3.

Once or twice a week, shovel animal manure from the yard, stable, or corral into a container or cart. Spread straw in the container or cart beforehand to soak up excess liquid. Transport the manure to the compost stack, biogas plant, or landfill. When the cart is empty, thoroughly clean it out. See Figure 4.

Keep a metal bucket or other metal container near the house for ashes from cooking and heating fires. Store cold ashes in the container for use in privies if the village has them. See "Operating and Maintaining Privies," SAN.1.0.1.

Keep a basket or box with a lid near the house. At least three times a week, sweep out the house with a broom and dust pan and place the sweepings in the basket or box. When the container is half full or more, carry it to the landfill, empty it, and return it to the house.

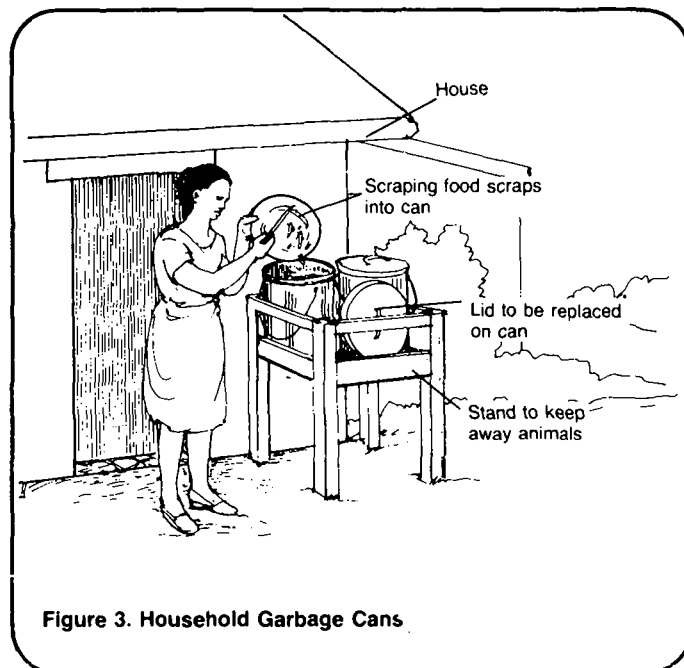


Figure 3. Household Garbage Cans

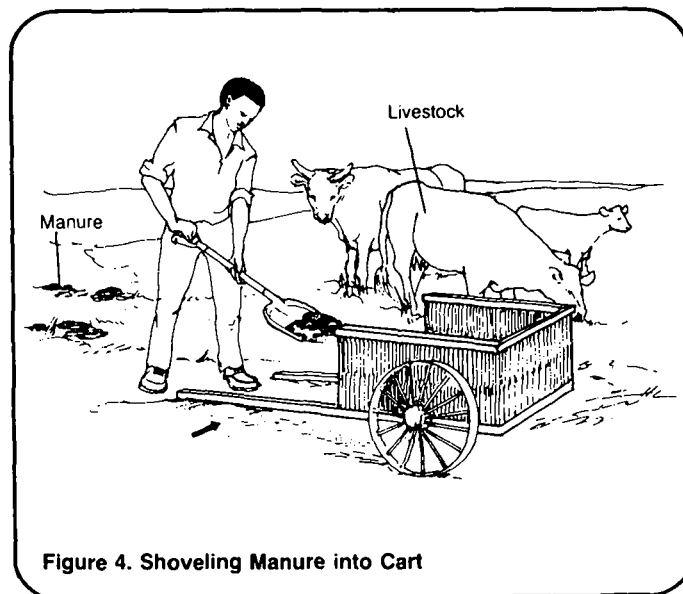


Figure 4. Shoveling Manure into Cart

## Operating a Community Collection System

In this system, householders, marketplace vendors, and other members of the community periodically clean out living and working areas and transport the waste to a community site for reuse or disposal.

Keep one or two barrels or baskets with lids near each house. If a composting system is being used, put garbage in one container and rubbish in another. If a landfill alone is being used, no separation of solid wastes is necessary. Once each week load the containers onto a cart. To lessen the workload, community members can help each other load and transport containers. Perhaps one cart can carry containers from a number of households. See Figure 6.

Keep one or more 50 to 200-liter containers with lids near each stall in the marketplace. Place wastes in the containers daily. At the end of each market day, thoroughly clean out the stalls and place sweepings in the containers. Load the containers on a cart and transport them to the community disposal site. When they have been emptied, clean them out and return them to the marketplace. For this system to be effective, every stall must be cleaned out, not just a few. Post signs promoting cleaning out living and working areas. See Figure 7.

Keep all containers covered with lids.

## Operating a Paid-Worker Collection System

In this system, community members place solid waste in containers and paid workers transport the waste to a community disposal site.

Build a storage shed near the disposal site. The shed should be made of locally available materials. It must be large enough to hold all collection vehicles, replacement parts, tools, and spare containers. It should be weatherproof and have a door with a lock.

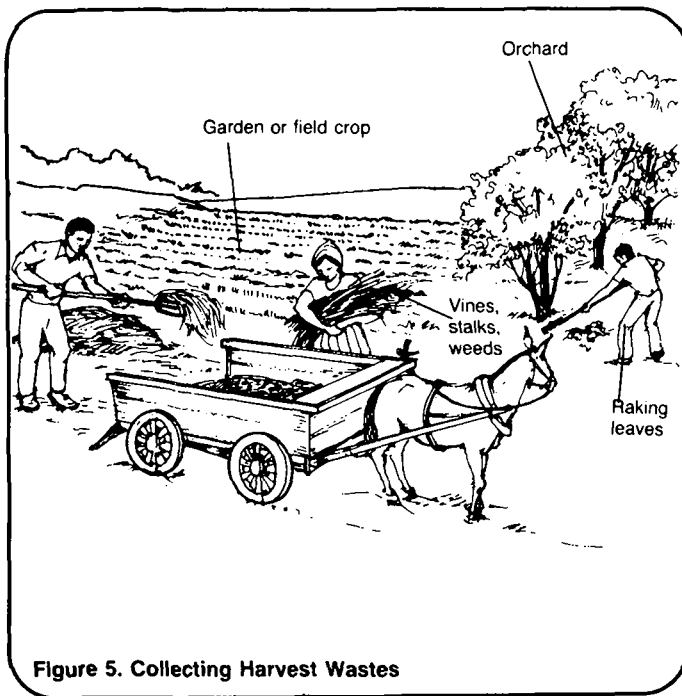


Figure 5. Collecting Harvest Wastes

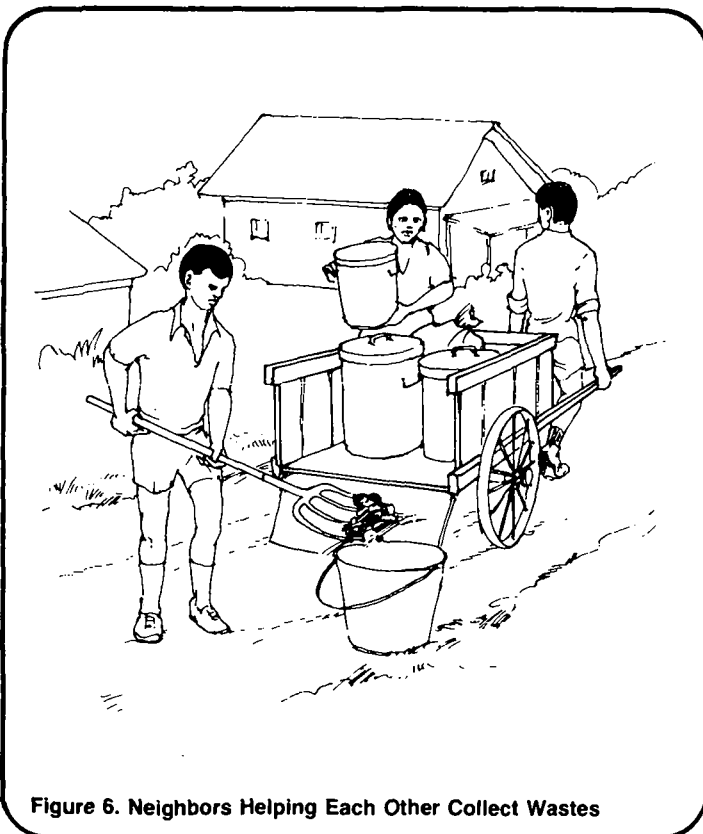


Figure 6. Neighbors Helping Each Other Collect Wastes

Once each month rake wastes from field, orchard, or garden into piles, load them into a basket or cart, and take them to the on-lot compost stack or landfill. See Figure 5.

Keep all containers covered with lids.

The supervisor of the system should inform the community members of the day and time of waste collection and where to place their containers for pick-up. It may be helpful to mark the pick-up points with paint marks or stakes. The supervisor should lead workers along the collection route from the starting point to the disposal site and show them the pick-up points. Keep a record sheet similar to Table 2, showing the route number, if more than one, the collection date, and the number of pick-up points, and noting any repairs, personnel changes, and changes in the route.

On collection day, the workers should load empty containers on the vehicle, travel along the established collection route, leave an empty container and pick up a full or partially

full one at each collection point, and transport the full containers to the disposal site. Containers may be emptied into a vehicle built for holding wastes for transport. Keep equipment and vehicles in good repair. Wear boots and gloves while working. Use leg muscles, not back muscles, to lift heavy containers. Treat cuts and scratches immediately. Always wash hands after work and before eating.

On collection day the community members should be certain that containers are at the pick-up points. Solid waste must not be piled on the ground. Get more containers if necessary. Users should periodically wash out empty containers.

Keep all containers covered with lids.

Table 2. Sample Record Sheet

Route	Day	Collection Points	Notes
A	Sat. August 8	22	
B	Wed. August 12	18	Replaced two missing container lids
A	Sat. August 15	22	
B	Wed. August 19	18	Repaired wheel on large wagon at end of route
A	Sat. August 22	22	Fired Jose, hired Juan
B	Wed. August 26	21	Three new collection points added to route B
A	Sat. August 29	22	
	Tues. Sept. 1		cleaned and inspected all equipment and vehicles. Okay.
B	Wed. Sept. 2	21	



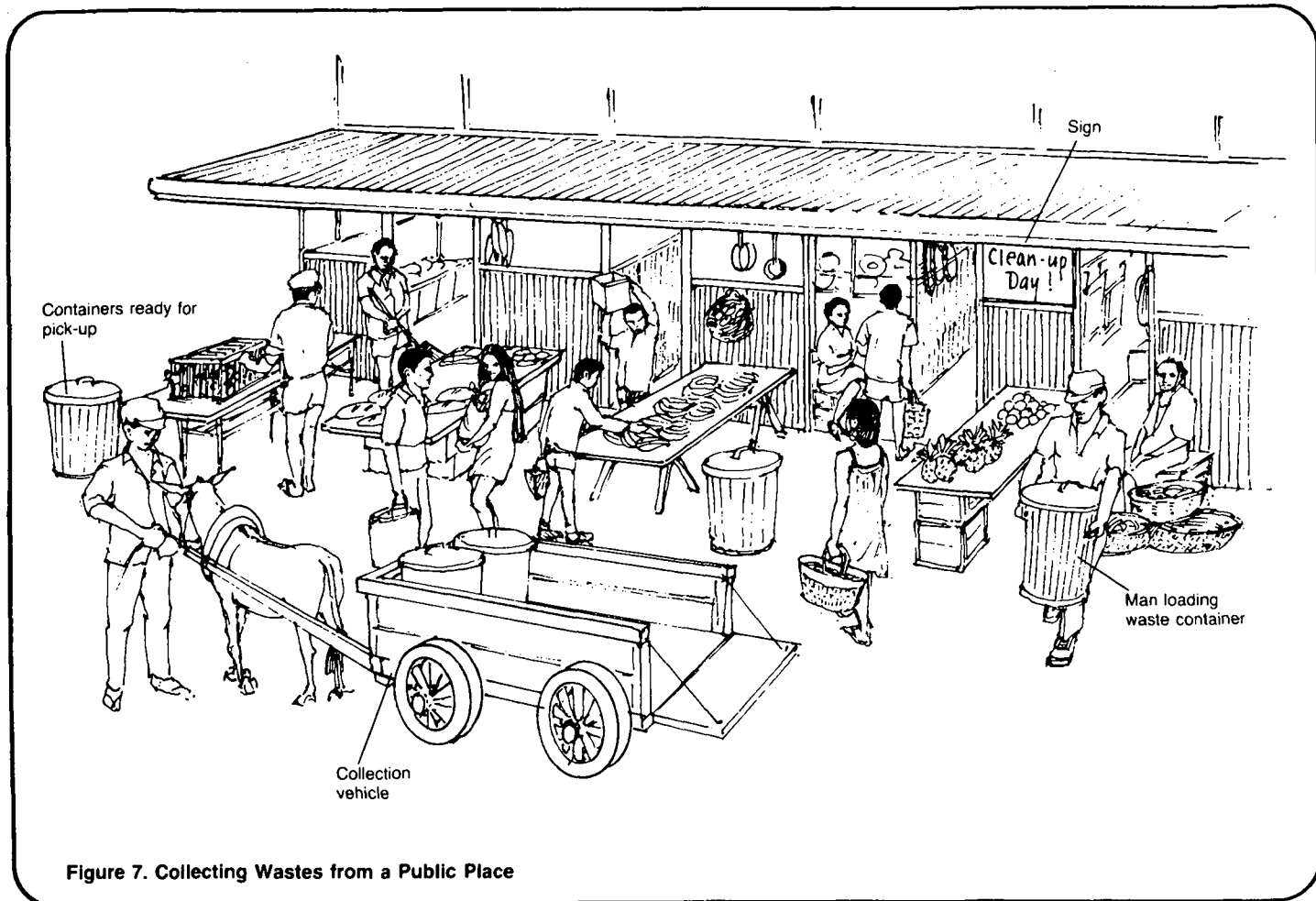


Figure 7. Collecting Wastes from a Public Place

### Maintaining a Solid Waste Collection System

Once or twice each month, inspect the storage shed and vehicles for damage or excessive wear. Repair or replace broken or worn-out parts. Once each week, thoroughly clean all containers, vehicles, and tools.

Once the routine of collection has been established, continue with it. This is important for all systems: household, community, and paid-worker. A collection system will last for as long as you want it to. As long as it lasts, the community will be a clean, healthy, and pleasant place to live and work.

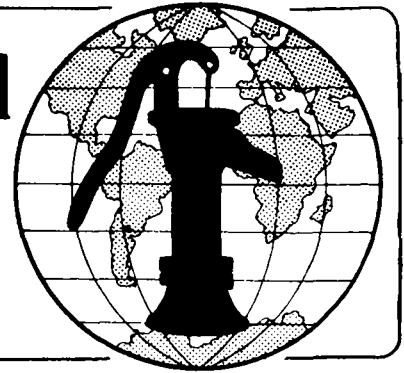
## Notes

## Notes

## Notes

**Technical Notes** are part of a set of "Water for the World" materials produced under contract to the U.S. Agency for International Development by National Demonstration Water Project, Institute for Rural Water, and National Environmental Health Association. Artwork was done by Redwing Art Service. Technical Notes are intended to provide assistance to a broad range of people with field responsibility for village water supply and sanitation projects in the developing nations. For more detail on the purpose, organization and suggestions for use of Technical Notes, see the introductory Note in the series, titled "Using 'Water for the World' Technical Notes." Other parts of the "Water for the World" series include a comprehensive Program Manual and several Policy Perspectives. Further information on these materials may be obtained from the Development Information Center, Agency for International Development, Washington, D.C., 20523, U.S.A.

# Water for the World



## Operating and Maintaining a Biogas System Technical Note No. SAN. 3.O.4

A biogas system is a means of digesting animal manure anaerobically to produce methane gas which is burned to provide heat or light. The system consists of one or more digesters, a gas holder, an arrangement of gas pipes, and one or more fixtures to burn the gas. Operating and maintaining a biogas system requires the services of a foreman experienced with these systems. Operating involves preparing the gas holder, filling the digester, testing for methane gas production, using the gas, and emptying and refilling the digesters every one to three months. Maintaining involves checking for gas or water leaks and repairing them at once.

This technical note describes how to operate and maintain a biogas system. Read the entire technical note before beginning operation.

### Useful Definition

**METHANE** - A gas produced when organic material such as manure decomposes in an airless environment; methane burns with a violet flame without smoke; it is explosive.

### Materials Needed

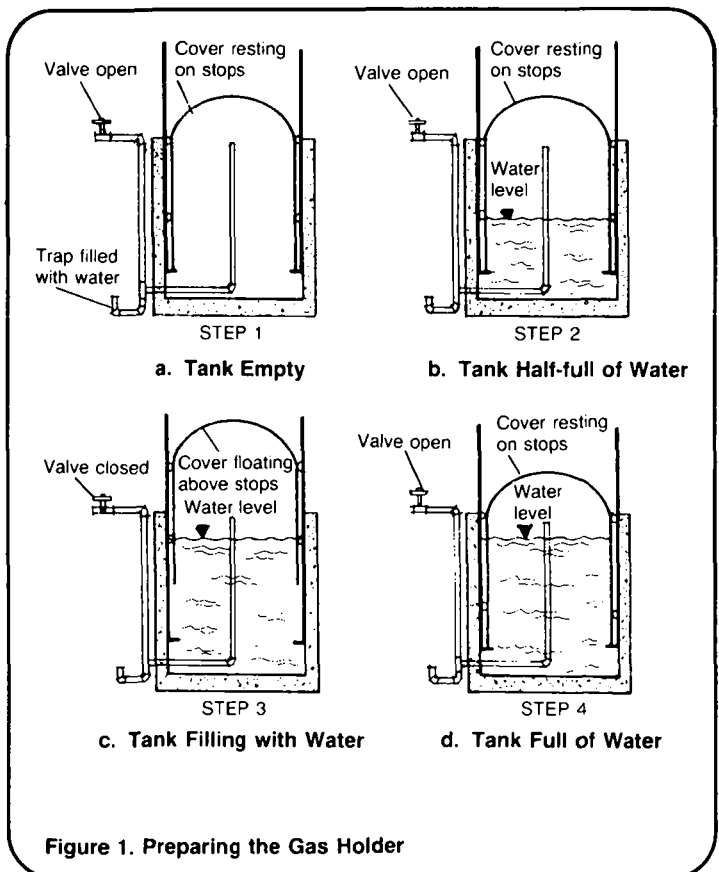
For operating: shovels, rakes, scoops, buckets, ropes, containers, carts, gloves, boots.

For maintaining: concrete mortar mix, gas pipe, pipe installer's tools, wrenches, threader, pipe joint compound, method for leak detection, replacement valves, and petcocks.

### Preparing the Gas Holder

1. Fill the water trap with clean water to make it gas-tight. This arrangement prevents condensation in the pipes from blocking the pipes and allows it to flow out of the system. See Figure 1a.

2. Close all valves and petcocks in the system. Open the valve leading to the first digester to be put into use. Remove the digester's manhole cover.



3. Fill the gas holder half-full with clean water. The floating cover should remain at its lowest position, resting on the stops on the guideposts, because as water fills the cover, the air inside is forced out through the gas pipe and through the open valve. See Figure 1b.

4. Close the valve.

5. Fill the gas holder nearly full with clean water. The floating cover should rise on its guideposts. Because the air inside is trapped, it cannot be forced through the gas pipes. See Figure 1c. Check that the cover rises smoothly and evenly within the posts. If it does not, make necessary repairs before proceeding. This may require removing the water.

6. Open the valve. The floating cover should sink to its lowest position, forcing the air out through the pipes and the open valve. See Figure 1d.

7. Close the valve.

### Filling the Digester

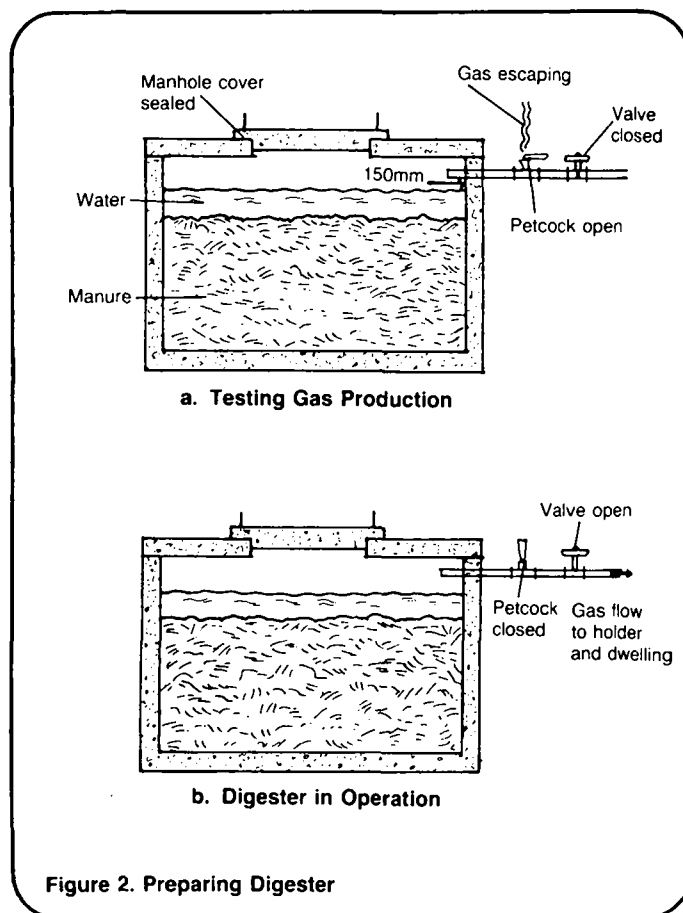
1. Store manure in stacks until ready for use. Turn the stacks every few days for one or two weeks. This will allow the material to partially decompose, reducing acid-forming substances and resulting in better gas production.

2. Fill the digester one-half to two-thirds full with partially-decomposed manure. Leave the manhole cover off and allow air into the digester for three days. This will further prepare the manure for gas production.

3. Fill the digester with water to within about 150mm of the gas pipe. Set the manhole in place and seal it with tar or equivalent to make it gas-tight. See Figure 2a.

### Testing for Gas Production

1. After the digester has been sealed, open the petcock and leave it open for two or three days. This will



allow gases to escape which are produced in the early stages of decomposition and which do not readily burn. See Figure 2a.

2. After a few days, open the petcock and attempt to ignite the gas being emitted. If it will not light, close the petcock.

3. Attempt to light the gas every day, closing the petcock after each attempt. It will take one or two weeks before the digester begins producing satisfactory gas. When the gas escaping from the open petcock can be ignited and will burn with a continuous flame, it is ready for use. Close the petcock and open the valve. See Figure 2b.

4. If methane gas production continues to fail after a month, it is probably because of acidic conditions in the digester. Do one or more of the following: (a) add lime or ammonium phosphate in a starting dose of 10 liters per  $m^3$  of digester contents and mix well; (b) add more horse or cattle

manure as these are alkaline; (c) add material from a digester that is already working well to help start the new digester.

### Using the Gas

1. Methane gas will fill the gas lines and begin to fill the floating cover, making it rise.
2. Open the valve in the dwelling and allow gas to reach the user's fixtures. Each fixture must have its own shut-off valve which must be kept closed until ready for use. See Figure 3.
3. The digester will continuously produce gas for one to three months, depending on the temperature and the exact contents of the tank. When a fixture is in use, gas will flow from the digester to the fixture. When the fixture is not in use, gas will flow from the digester to the gas holder. When gas production slows, for example, at night when it is cooler, and the fixture is used, gas will flow from the gas holder to the fixture.

### Caution!

Certain mixtures of air and methane gas are explosive. Do not smoke, cause sparks, or carelessly light matches near the system. Be especially careful when a digester is being opened. There is risk of an explosion at the surface and later in the digester as oxygen-rich air enters.

### Emptying and Refilling the Digesters

The contents of the digester will produce methane for a certain period of time, generally one to three months. The production will be low at the beginning of the time period, gradually rise to its highest rate near the middle of the time period, and decline to a low rate near the end. To maintain a relatively steady rate of gas production, alternate the use of the digesters. That is, when the first digester nears its peak of production, start up the second digester. When the second digester nears its peak, it will

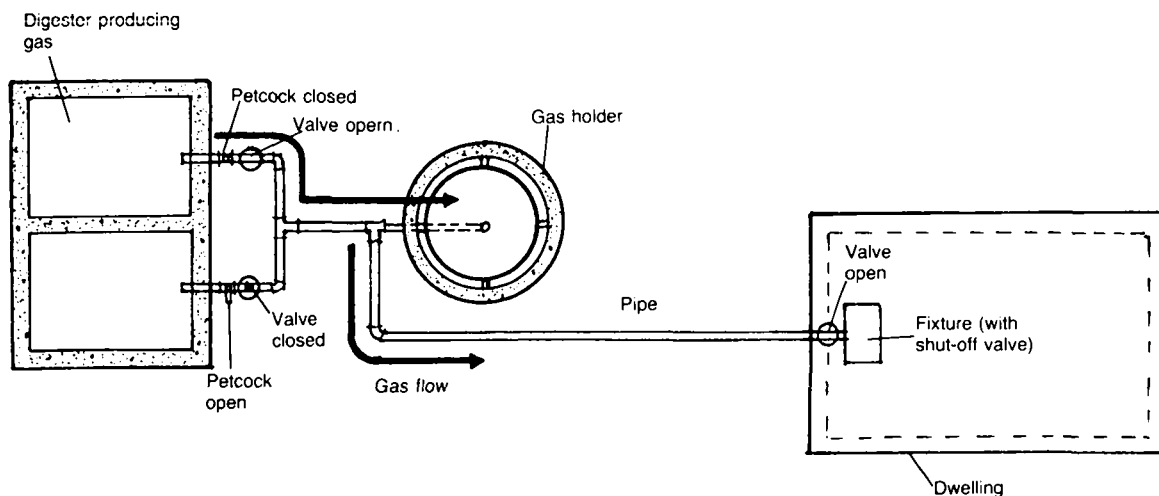


Figure 3. Biogas System in Operation

be time to empty the first digester and refill it with a fresh load. This alternating process must continue as long as gas is wanted. The length of the time period from start up to peak rate to emptying depends on digester capacity, digester load, manure quality, temperature and bio-chemical actions. With experience in the field, the best combinations and results will be learned.

1. When it is time to empty a digester, close the valve and open the petcock. Leave the petcock open for a few days to allow methane to escape from the digester.

2. Remove the manhole cover and allow the digester to air out for a few days.

### Maintaining the System

Routinely check for gas leaks. Methane leaking from gas pipes, digesters, or the gas holder will have a barnyard odor. If a leak is detected, it should be repaired at once. Leaks in the digester or walls of the gas holder can be repaired with concrete mortar. Leaks in the pipes may be repaired by tightening fittings or replacing sections of pipe. The system may have to be shut down to make repairs. In any case, repairs must be made by experienced personnel.

### Caution!

Gases present in the digester and the absence of oxygen can cause a worker to be overcome quickly and die. Never work around an open digester without a safety rope and strong workers standing by.

3. Remove most of the decomposed contents of the digester with scoops, buckets and ropes, shovels, or other means. See Figure 4. Leave about 100mm of solids and about half of the liquid material in the digester to enhance gas production in the next load.

4. Haul the removed contents in containers and carts to crop land. Spread it on the ground and work it into the soil. It is an excellent fertilizer since it is high in nitrogen compounds. See Figure 5.

Although all pathogenic organisms are killed by digestion, always wear boots and gloves when handling the contents of the digesters as an added precaution. If digestion is incomplete, round worm eggs may be present.

5. Reload the digester. See "Filling the Digester." Methane production will probably begin sooner than before. The old contents remaining in the digester seed the new manure.

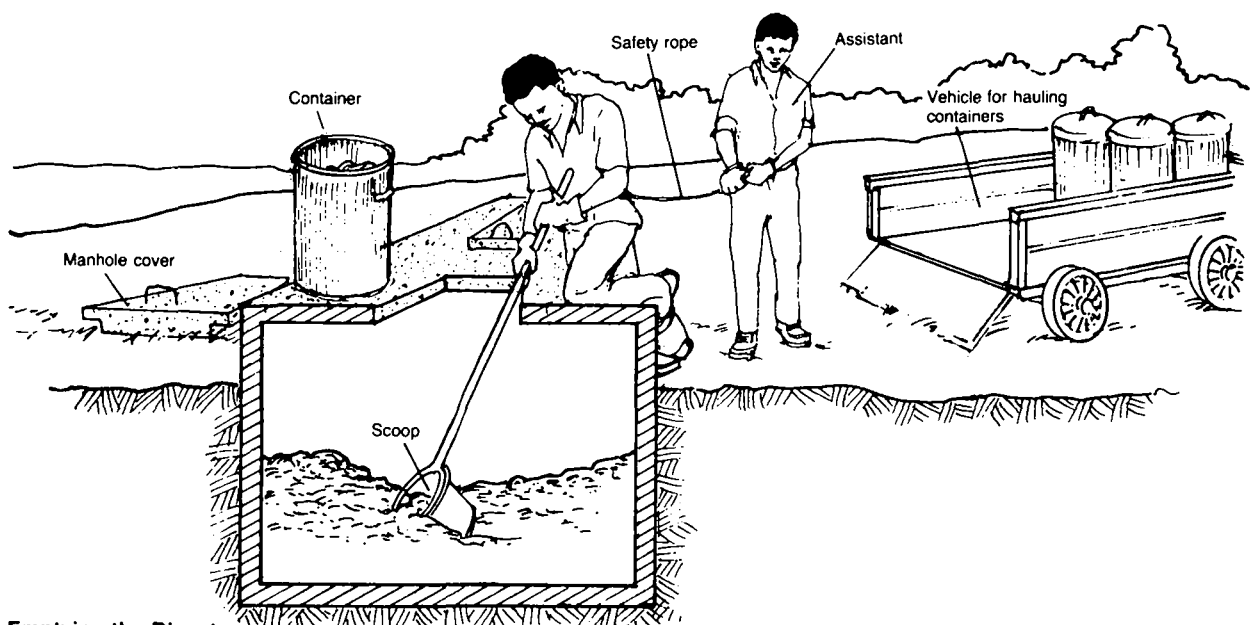
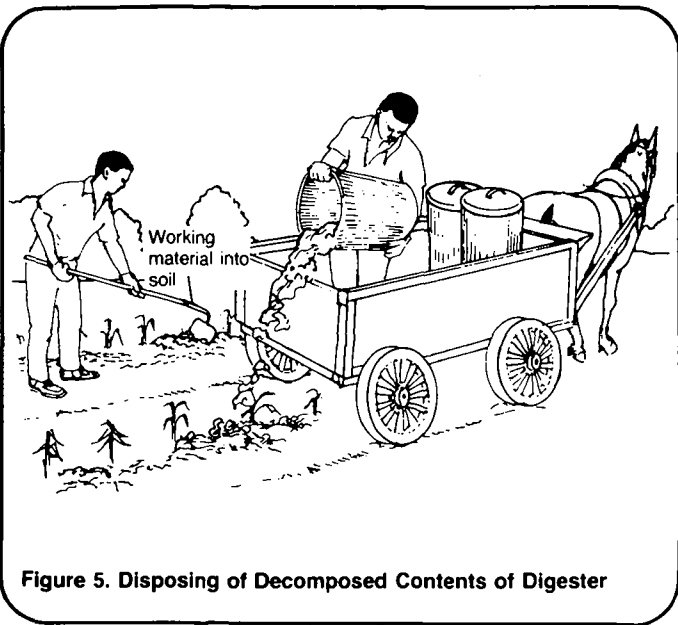


Figure 4. Emptying the Digester





Check for water leaks in the gas holder. The water level will fluctuate as the floating cover lifts and sinks, and there will be a slight loss of water after the holder is first filled as the walls cure. A continual loss of water indicates a leak. Locate the leak and repair it with concrete mortar. This may involve excavating around the gas holder.

Maintain a record similar to Table 1 showing all operation and maintenance activities.

Table 1. Sample Operation Record for a Biogas System

Date	Task
5/1	Stacked manure.
5/5	Turned stacks.
5/9	Turned stacks. Closed valve and opened petcock on Digester #1.
5/11	Removed manhole cover on Digester #1.
5/13	Emptied digester except for small amount. Spread contents in fields.
5/14	Loaded the digester with manure.
5/16	Add water to digester; sealed manhole cover; checked that valve was closed and petcock open.
5/18	Checked gas for ignition. No. Closed petcock.
5/19	" " " " " " "
5/20	" " " " " " "
5/21	" " " " " " "
5/22	" " " " " " "
5/23	" " " " " " "
5/24	Checked gas for ignition. Yes. Closed petcock and opened valve.

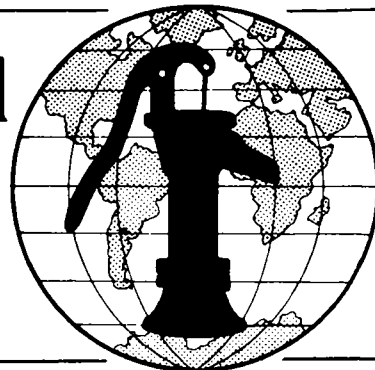
## Notes

## Notes

## Notes

**Technical Notes** are part of a set of "Water for the World" materials produced under contract to the U.S. Agency for International Development by National Demonstration Water Project, Institute for Rural Water, and National Environmental Health Association. Artwork was done by Redwing Art Service. Technical Notes are intended to provide assistance to a broad range of people with field responsibility for village water supply and sanitation projects in the developing nations. For more detail on the purpose, organization and suggestions for use of Technical Notes, see the introductory Note in the series, titled "Using 'Water for the World' Technical Notes." Other parts of the "Water for the World" series include a comprehensive Program Manual and several Policy Perspectives. Further information on these materials may be obtained from the Development Information Center, Agency for International Development, Washington, D.C., 20523, U.S.A.

# Water for the World

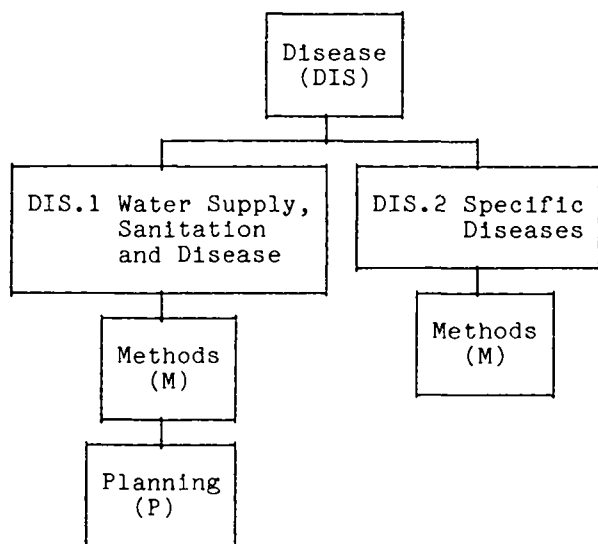


## Overview of Disease Technical Note No. DIS. G

The technical notes on disease are divided into two series as shown on Table 1: DIS.1 - Water Supply, Sanitation and Disease, and DIS.2 - Specific Diseases. Within the DIS.1 series, the technical notes are organized according to methods (M) and planning (P). The DIS.2 series contains only methods (M) technical notes. All technical notes have both a title and a number within each category indicating where they fit on Table 1. For example, DIS.1.P, "Planning Disease Control Programs," is part of the Water Supply, Sanitation and Disease series (1) and discusses planning (P). See "Overview of Water and Sanitation Systems Development," HR.G, for a full discussion of the organization of the technical notes and a list of all of them. The disease technical notes are listed at the end of this note.

water supply, sanitation and disease and about some of the water- and sanitation-related diseases. They are not intended to describe how to treat diseases or how to go about establishing comprehensive disease control programs. Many water- and sanitation-related diseases can best be controlled by developing safe, accessible water supplies and sanitation facilities as described in the technical notes on rural water supply and sanitation. Others require regional or countrywide control programs involving chemical spraying, vaccinations, and other complex undertakings. These technical notes on disease will give the reader a general understanding of some diseases and how they relate to water supply and sanitation. If a disease is a problem in an area, assistance should be sought from health workers, doctors, or other people with medical training.

Table 1. Organization of Disease Technical Notes



The technical notes on disease are intended only to provide general information about the relationship between

## Sources of Further Information

The books listed below will be useful to those interested in further reading on the subject of water supply, sanitation and disease. Some of them are very helpful in providing on-the-spot health care when no trained health professional is available.

Control of Communicable Disease in Man, edited by Abram S. Benenson, 1981. The American Public Health Association, 1015 Fifteenth Street, N.W., Washington, D.C. 20005 U.S.A.

Guide to Simple Sanitary Measures for the Control of Enteric Diseases, S. Rajagopalan and M.A. Shiffman, 1974. World Health Organization, Av. Appia, 1211 Geneva 27 Switzerland

The Primary Health Worker: Working Guide, Guidelines for Training, Guidelines for Adaptation, 1977.  
World Health Organization, Av. Appia, 1211 Geneva 27 Switzerland

Where There Is No Doctor: A Village Health Care Handbook, David Werner, 1980. The Hesperian Foundation, P.O. Box 1692, Palo Alto, California 94302 U.S.A. or TALC (Teaching Aids at Low Cost), Institute of Child Health, 30 Guilford Street, London WC1N 1EH England. (Book available in English, Spanish, Portuguese and Swahili. Swahili version only available from Rotary Club of Dar Es Salaam, P.O. Box 1533, Dar Es Salaam, Tanzania)

Water and Human Health, F. Eugene McJunkin, 1982. Development Information Center; U.S. Agency for International Development, Washington, D.C. 20523 U.S.A.

## List of Technical Notes

The following is a list of all the technical notes on disease.

### DISEASE

DIS.G Overview of Diseases

#### DIS. 1 Water Supply, Sanitation and Disease

##### Methods

DIS.1.M.1 Means of Disease Transmission

DIS.1.M.2 Methods of Improving Environmental Health Conditions

##### Planning

DIS.1.P Planning Disease Control Programs

#### DIS. 2 Specific Diseases

##### Methods

DIS.2.M.1 Methods of Controlling Schistosomiasis

DIS.2.M.2 Methods of Controlling African Trypanosomiasis

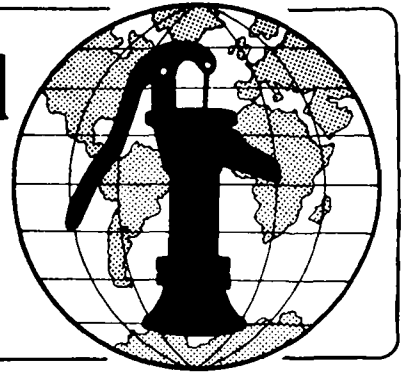
DIS.2.M.3 Methods of Controlling South American Trypanosomiasis

DIS.2.M.4 Methods of Controlling Enteric Diseases

DIS.2.M.5 Methods of Controlling Onchocerciasis

**Technical Notes** are part of a set of "Water for the World" materials produced under contract to the U.S. Agency for International Development by National Demonstration Water Project, Institute for Rural Water, and National Environmental Health Association. Artwork was done by Redwing Art Service. Technical Notes are intended to provide assistance to a broad range of people with field responsibility for village water supply and sanitation projects in the developing nations. For more detail on the purpose, organization and suggestions for use of Technical Notes, see the introductory Note in the series, titled "Using 'Water for the World' Technical Notes." Other parts of the "Water for the World" series include a comprehensive Program Manual and several Policy Perspectives. Further information on these materials may be obtained from the Development Information Center, Agency for International Development, Washington, D.C., 20523, U.S.A.

# Water for the World



## Means of Disease Transmission Technical Note No. DIS. 1.M.1

Water- and sanitation- related diseases are major causes of illness and death among people in both rural and urban areas in many developing countries. The health and well being of people cannot be improved without understanding these diseases and knowing how they are transmitted from one person to another.

This technical note describes what causes these diseases, how they are spread and the factors influencing their transmission. Methods for preventing the transmission of the water- and sanitation- related diseases can be found in the technical note, "Methods of Improving Environmental Health Conditions," DIS.1.M.2.

### Useful Definitions

**AQUIFER** - A water-saturated geologic zone that will yield water to springs and wells.

**BACTERIA** - One-celled microorganisms which multiply by simple division and which can only be seen with a microscope.

**FEACES** - The waste from the body moved out through the bowels.

**LARVAE** - Young forms that come from the eggs of insects and worm parasites.

**PARASITES** - Worms, insects or mites which live in or on animals or people.

There are about 30 diseases that are related to water and sanitation. Table 1 lists the 21 which are most important. Each of them affects from millions to hundreds of millions of people every year. All of these diseases are caused by living organisms that must spend much of their life in or on a human body. They include viruses so tiny that they can pass through the finest filter, bacteria and

protozoa that can be seen only with the aid of a microscope, tiny mites that are barely visible to the eye and worms that may be a meter long.

The transmission of all of these diseases is related in some way to water supply and sanitation, usually to inadequate disposal of human wastes and to contaminated water supplies. The diseases are transmitted through contact with or consumption of water, contact with infected soil, the bites of insects that breed in or near water and poor personal and family hygiene. Man is usually the source of the organisms that cause these diseases and human activity is an important factor in the transmission of them.

Following the order shown in Table 1, the transmission of the diseases will be discussed for each of the five categories.

### Waterborne Diseases (Water Quality Related)

In the waterborne diseases, the microorganisms which cause the disease are swallowed with contaminated water. All but one, Guinea worm, are caused by organisms found in human excreta, the source of the contamination. The infective stage of Guinea worm is not from fecal contamination, but is from a tiny larva that develops in a water-flea after the larva is discharged into the water. The larva comes from a blister on the skin of a person infected with the meter-long adult worm.

Cholera and typhoid fever are the waterborne diseases which are most feared because, when untreated, they have high death rates. However, the diarrheas and dysenteries are more important because of the infant deaths and huge numbers of illnesses they cause. In the developing countries,

**Table 1. Water and Sanitation-Related Diseases**

Category	Disease Common name	Medical name	Type of Organism	Transmission
Waterborne (Water quality related)	Cholera Typhoid fever Paratyphoid fever Bacillary dysentery Amebic dysentery Diarrhea Jaundice  Guinea worm	Cholera Typhoid Paratyphoid Shigellosis Amebiasis Salmonellosis Giardiasis Hepatitis  Dracunculiasis	Vibrio Bacteria Bacteria Protozoan Bacteria Protozoan Virus  Worm	By consuming (drinking) fecally contaminated raw water containing an infective dose of the vibrio, bacterium, protozoan or virus; except Guinea worm where transmission is by swallowing water flea infected with worm larva that was shed from skin blister on infected human.
Water-washed (Water quantity; and accessibility related)	Bacillary dysentery Diarrhea Viral diarrhea Trachoma  Pink eye Itch	Shigellosis Salmonellosis Enteroviruses Trachoma  Conjunctivitis Scabies	Bacteria Bacteria Virus Intracellular bacteria  Bacteria Mite	Anal-oral or skin-to-skin direct contact transmission resulting from poor personal cleanliness and hygiene caused from lack of water for sufficient washing, bathing and cleaning.
Water-contact (Body-of-water related)	Blood fluke disease	Schistosomiasis	Worm	Eggs in feces or urine hatch larvae in water, penetrate suitable snail, multiply greatly in snail, free-swimming larvae leave snail, penetrate skin when person has contact with infected water.
Water-related insect vectors (carriers) (Water-site related)	Yellow fever Malaria Filial fever Sleeping sickness River blindness	Yellow fever Malaria Filiariasis Trypanosomiasis Onchocerciasis	Virus Protozoa Worm Protozoa Worm	Mosquitoes, tsetse flies and black-flies, which breed in or near water, pick up disease organisms when they bite infected person; organisms grow in vectors and are inoculated into another person when insect bites.
Sanitation-related (Fecal polluted soil related)	Hookworm Roundworm	Ancylostomiasis Ascariasis	Worm Worm	Eggs or larvae become infective when feces are deposited on soil; eggs are eaten from contaminated hands or vegetables, or larvae penetrate skin that comes in contact with infected soil.

the diarrheas and dysenteries cause hundreds of millions of illnesses and millions of infant deaths each year.

The basic transmission of waterborne disease is person to person. The microorganisms for infected people contaminate water which is consumed by other people. Figure 1 shows a common way that water becomes contaminated. The contamination of water supplies occurs:

1. Where latrines and privies are located uphill from or very close to a water source such as a spring, stream, pond or well. Liquids carrying the organisms seep from the latrines into the water supply.

2. Where privy pits, soakage pits, or sewage absorption systems penetrate the water table of an aquifer located near the surface and shallow wells and springs whose water comes from the aquifer are contaminated.

3. Where wells and springs are unprotected so that surface run-off enters these water sources. The run-off after rainfall carries disease-causing organisms into the water source.

4. Where sanitation is poor. If people defecate on the ground or in bodies of water rather than in safe latrines or privies, disease-causing organisms can get into water supplies.

5. Where Guinea worm occurs, water is contaminated when the skin of an infected person with a blister caused by the worm is immersed in water and great numbers of larvae are released into the water. Some of the larvae are eaten by tiny water fleas (Cyclops). The larvae in the water fleas grow, shed their skins, and become infective. When a water flea containing an infective larva is drunk with water from the contaminated source, the little worm is transmitted to a new person where it grows to maturity under the skin.



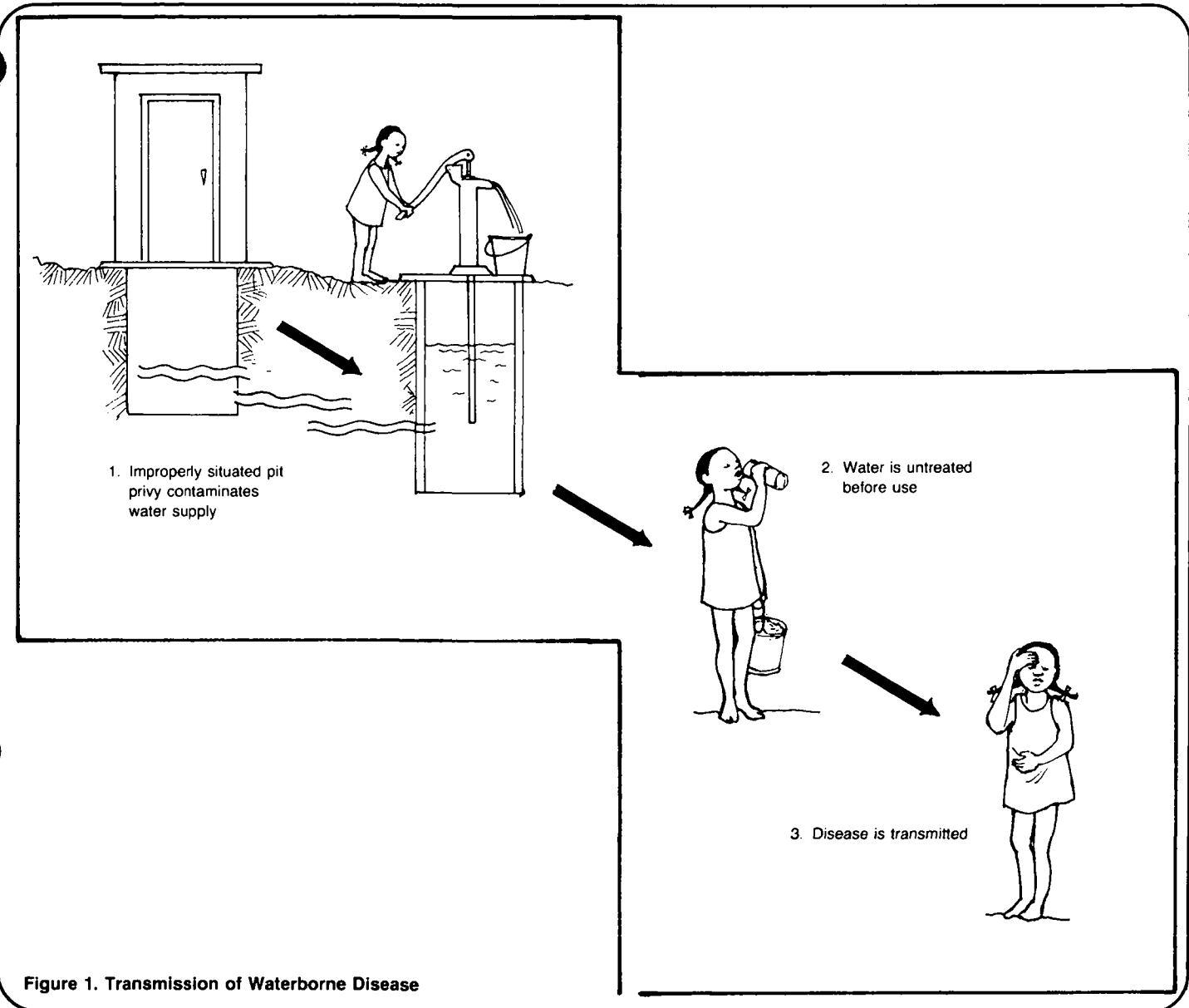


Figure 1. Transmission of Waterborne Disease

### Water-Washed Diseases (Water Quantity and Accessibility Related)

Water-washed diseases are diseases whose transmission results from a lack of sufficient clean water for frequent bathing, hand washing before meals and after going to the toilet, and for washing clothes and household utensils. Several common diseases fall into this category. Shigellosis (bacillary dysentery), salmonellosis (food poisoning), trachoma, and scabies are all diseases that can be passed by direct contact between people or by the direct contamination of food by dirty hands or flies. Figure 2 shows one way water-washed diseases are spread. The diseases in this group are transmitted:

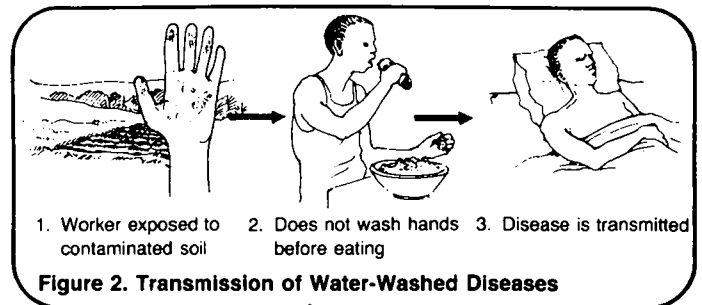


Figure 2. Transmission of Water-Washed Diseases

1. When a water supply produces insufficient quantities to meet peoples' needs or when the water supply is located at a distance from the users. The availability of only small amounts of water makes the practice of good personal and household hygiene difficult, or even impossible.

2. When feces are not disposed of in a sanitary way. Uncovered or unprotected latrines or stools passed on the ground are breeding places for flies and sources of bacteria. Bacteria and viruses are passed from feces to people by flies, contaminated fingers and food. Food contamination with salmonella quickly grows great numbers of the bacteria. When eaten, the food causes food-poisoning diarrhea with life-threatening consequences, especially for small children.

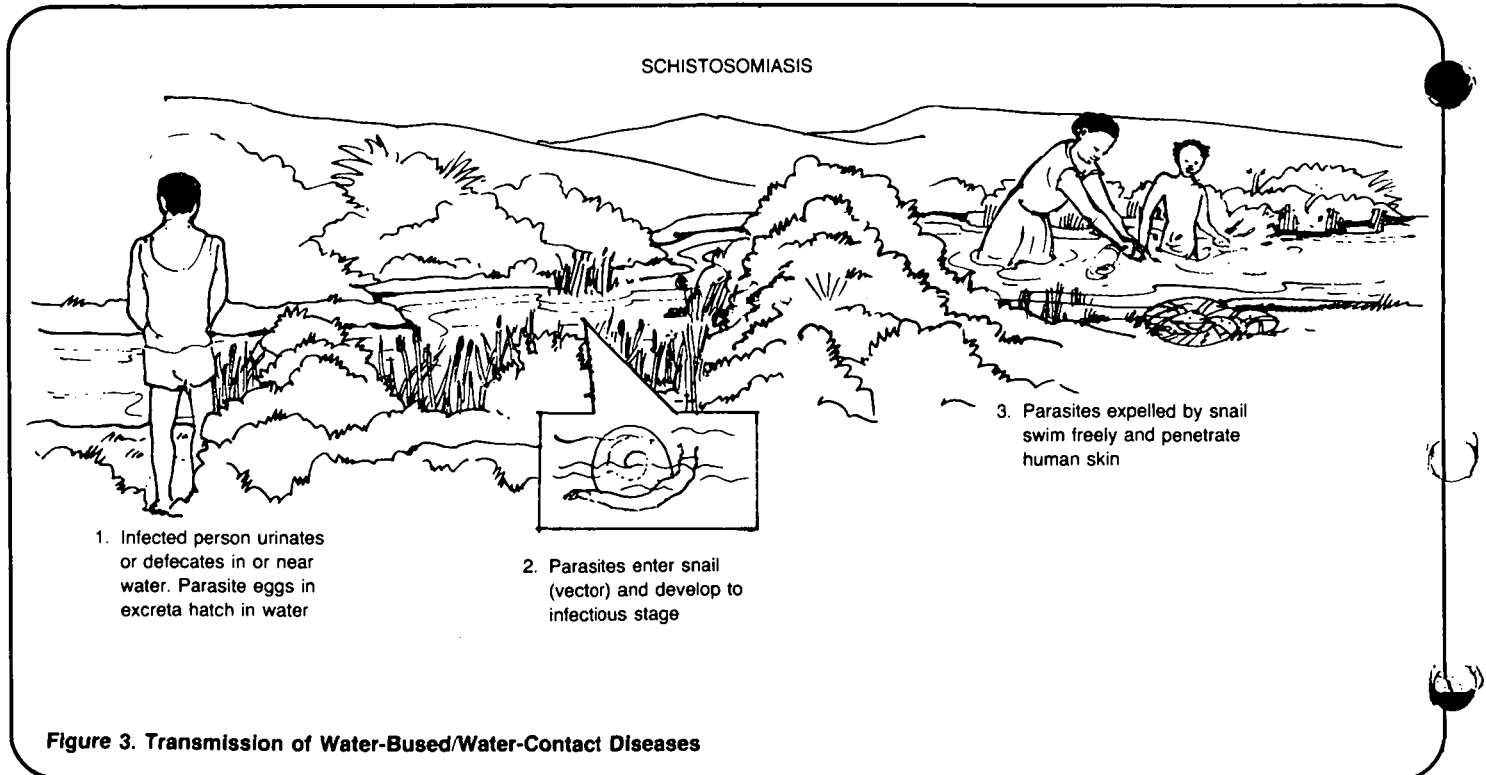
3. When people are ignorant of the need for personal hygiene and, for whatever set of reasons, either do not bathe frequently or use the same water and towels to wash more than one person, then trachoma and conjunctivitis are passed around within a family or other groups living together and scabies get passed from the skin of one person to the skin of another.

### Water-Contact Diseases (Body-of-Water Related)

Water-contact diseases are diseases which are transmitted when people have contact with infected water. The single most important water-contact disease is Schistosomiasis (blood fluke disease). It is very widespread in Asia, Africa and South America with

hundreds of millions of people at risk of getting the disease and millions suffering from it. Figure 3 shows how schistosomiasis is transmitted. Briefly, transmission is as follows: Schistosome eggs passed in urine or feces fall into water where a first stage larva hatches. The first stage larva, to survive, must find and penetrate a specific type of snail. In the snail, the first stage larva changes into a large number of forked-tailed second stage larva are produced over a period of months to years. Each day, several hundreds of these second stage larvae escape from the snail to swim about in the water seeking the warm skin of a human hand or food into which to penetrate. Once through the skin, the little worm enters the person's blood stream, grows to maturity (worms are about a centimeter long), works its way into the blood vessels of the intestine and urinary bladder, and lays its eggs in the wall of those organs. The eggs then cut their way through the tissues to the inside of the intestine or bladder and are passed with the feces or urine. So the transmission cycle continues.

Schistosomiasis is transmitted in areas:



1. Where poor sanitation is practiced so that feces or urine find their way into bodies of water that contain snails, or where rats or wild animals get the worms and keep the snails infected.

2. Where the appropriate type of snail is abundant and can become infected.

3. Where people enter infected water to bathe, wash clothes, dip up water, cultivate crops or swim.

4. Where irrigation projects or man-made lakes have extended the bodies of water in which snails can grow and have the chance to be infected from man or wild animals.

### Water-Related/Insect Vector (Carrier) Diseases (Water Site Related)

Water-related insect vector diseases are those that are transmitted by insects which breed in or near water. Transmission occurs when the insect becomes infected with the disease organism from biting a person or animal, and then bites another person. The parasites are injected into the skin or bloodstream by the insect bite. The insects breed in water that is used as water supplies (streams and rivers) and, in the case of mosquitoes, in water storage jars, and water tanks, or in shaded high humidity areas near streams or lakes.

The most common diseases in this category are:

- African trypanosomiasis (sleeping sickness) which is transmitted by the tsetse fly which thrives on high humidity and breeds in river areas under lush vegetation growing at water sites.

- Onchocerciasis (river blindness) which is transmitted by blackflies which breed while attached to rocks and vegetation in fast-flowing rivers and streams. Figure 4 shows how onchocerciasis is transmitted.

- Malaria which is transmitted by female anopheline mosquitoes which breed in a wide variety of water collections.

- Arboviruses (yellow fever) which is also transmitted by mosquitoes. The

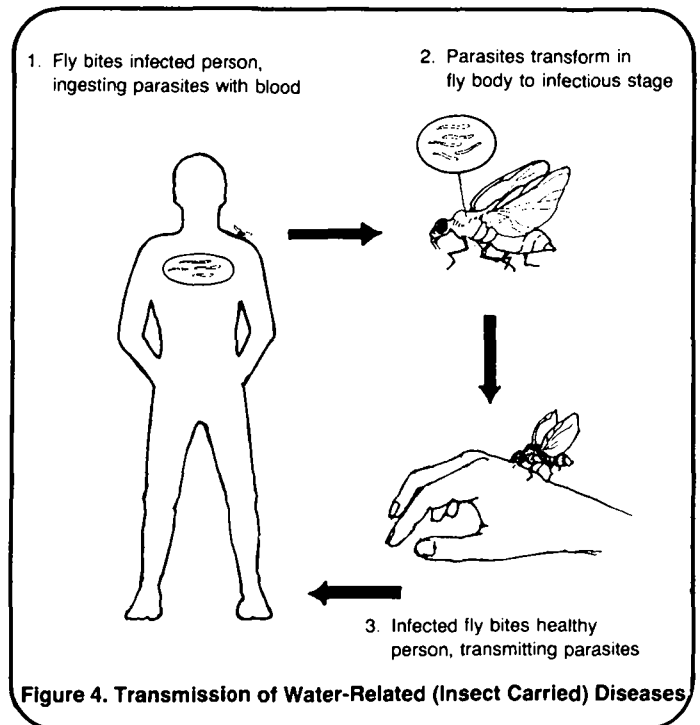


Figure 4. Transmission of Water-Related (Insect Carried) Diseases

type of mosquitoes that carries this disease is different from that which carries malaria. Mosquitoes that carry yellow fever breed in highly polluted stagnant water and usually rest in areas far from their breeding places.

- Filariasis which is a worm infection spread by mosquitoes. The mosquitoes that carry the parasite breed in any stagnant pond or pool or in water in cans, coconut husks, dishes, gutters or wherever water is standing.

The transmission of water-related insect vector diseases occurs in many types of situations in which the insect vectors are able to breed in large numbers, can bite persons infected with the protozoan or worm that causes the disease, and later, after the parasites have developed in them, have the opportunity to bite other people. In many situations, the water supply site where people come to get their water, is the place where the insects get their opportunity to bite both infected and other people. The household environment is also a place where some of these diseases are transmitted.

### Sanitation-Related Diseases (Fecal Polluted Soil Related)

Sanitation-related diseases are specifically those that are transmitted by people lacking both sanitary facilities

for waste disposal and knowledge of the need to dispose of wastes in a sanitary manner. The infective stage of the worm which causes those diseases develops in fecally contaminated soil. The most common diseases in this category are hookworm and roundworm.

Hookworm larvae develop and live in damp soil that has been contaminated with feces containing hookworm eggs. They penetrate the bare feet of people walking or standing on the infected soil. See Figure 5. Entrance can also occur through the hands or other skin areas.

Roundworm or ascariasis is transmitted by swallowing eggs which have become infective by developing on polluted soil. The eggs are eaten by children who play on the infected soil, drop food on the soil and then eat it, or eat from dirty hands or eat contaminated raw vegetables.

Both diseases occur:

1. Where there are not latrines and the soil is polluted, where latrines are not sanitary or where they are not used.

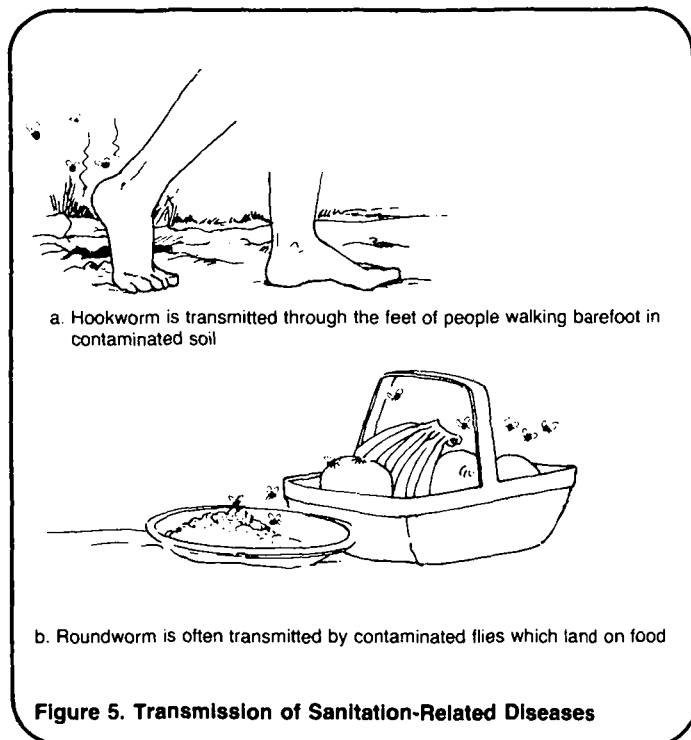
2. Where fresh untreated feces are used as fertilizer.

3. Where people are not educated to wash their hands before eating.

### Summary

This technical note has discussed several diseases which are common in many countries. They are all directly related to local environmental conditions and are all passed from person to person. The cycle, or chain of transmission, involves both direct transmission of the disease or else depends on an agent, or vector, for the transmission.

Once the chain of transmission is understood, means to break the chain should be adopted. Generally, relatively simple environmental measures need to be developed to stop the spread. The methods of doing this are discussed in "Methods of Improving Environmental Health Conditions," DIS.1.M.2.

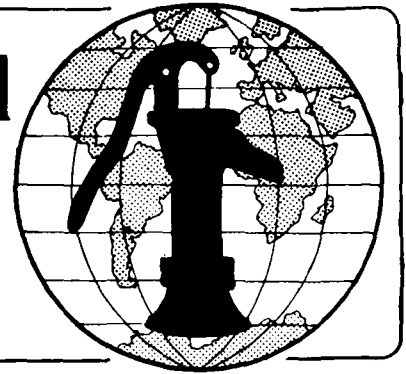


Notes

## Notes

**Technical Notes** are part of a set of "Water for the World" materials produced under contract to the U.S. Agency for International Development by National Demonstration Water Project, Institute for Rural Water, and National Environmental Health Association. Artwork was done by Redwing Art Service. Technical Notes are intended to provide assistance to a broad range of people with field responsibility for village water supply and sanitation projects in the developing nations. For more detail on the purpose, organization and suggestions for use of Technical Notes, see the introductory Note in the series, titled "Using 'Water for the World' Technical Notes." Other parts of the "Water for the World" series include a comprehensive Program Manual and several Policy Perspectives. Further information on these materials may be obtained from the Development Information Center, Agency for International Development, Washington, D.C., 20523, U.S.A.

# Water for the World



## Methods of Improving Environmental Health Conditions

Technical Note No. DIS. 1.M.2

The improvement of people's health may require that certain changes be made in the environment. Local conditions which contribute to the transmission of disease must be changed or eliminated. Water supplies have to be protected, improved or treated. Methods for the sanitary disposal of wastes must be used, insect vectors must be controlled, destroyed or guarded against, and educational programs must be instituted to make people aware of the need to prevent disease and teach them how to do so.

In the technical note, "Means of Disease Transmission," DIS.1.M.1, several categories of diseases were outlined and the specific mode of transmission of each was discussed. This technical note describes measures that can be taken to prevent the spread of water- and sanitation-related diseases.

### Useful Definitions

**HABITAT** - A region or area where a plant or animal grows, lives or is ordinarily found.

**SPILLWAY** - A channel built to control the level of water in a dam reservoir; flood water is drained from a dam through spillways.

**VECTOR** - An animal or insect that transmits a disease-producing organism from one host to another.

### Waterborne Diseases (Water Quality Related)

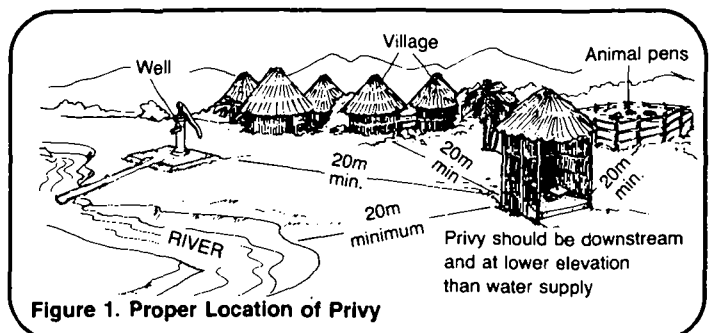
Waterborne diseases are those which are spread when the microorganisms causing them are consumed with contaminated water. Several methods of preventing water contamination and for improving the quality of water can be used. The need to biologically test

the water for evidence of fecal contamination is of great importance. Water can be tested by collecting samples and taking them to a central laboratory or by performing tests in the field using special kits. (These methods are discussed in "Taking a Water Sample," RWS.3.P.2 and "Analyzing a Water Sample," RWS.3.P.3.)

In some locations, there may not be a way to test water because of long distance to testing laboratories and lack of field equipment. If testing is impossible, the assumption that the water is contaminated should be made if conditions at the water site are such that the source is not fully protected. Furthermore, measures to improve those conditions and prevent the spread of disease should be assumed to be needed. The following measures are important for improving local environmental conditions.

- Make sure that people have and use sanitary latrines. The community members should be educated about the need for latrines and how their use can reduce the spread of serious disease.

- Educate the people in where to locate latrines and how to construct them properly. All latrines should be located at least 15m from the nearest source of water. They should be at a lower elevation than the water source to ensure that contamination through seepage is prevented. See Figure 1.



- Be sure that the pit does not puncture an aquifer. Latrine seepage that enters an aquifer can contaminate ground water (wells) and spring water supplies.

- Protect all wells and springs against contamination from surface runoff. Cap springs with spring boxes. Finish wells with a well head. Make sure that the well shaft is cased with concrete rings, pipe or brick. No surface water should seep into wells. See Figure 2.

- Control the breeding of flies by disposing of garbage and animal manure in a sanitary manner, and covering latrine openings when not in use. All community garbage should be disposed of in a sanitary landfill, while individual disposal can be achieved by digging small pits where rubbish can be burned and garbage buried. See Figure 3.

To control Guinea worm, eliminate all step-wells where the skin of water carriers can come into contact with

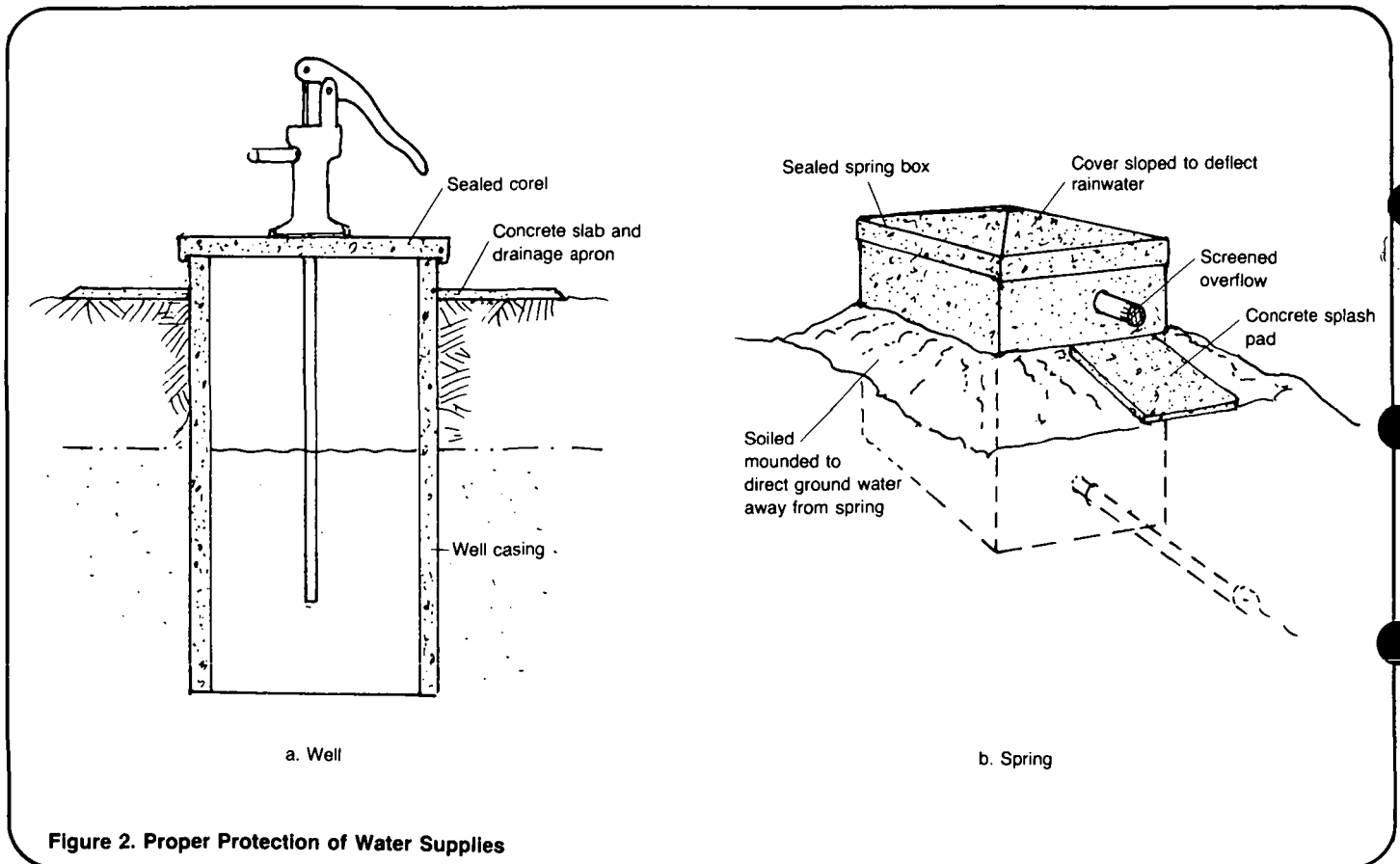


Figure 2. Proper Protection of Water Supplies

- For surface sources, especially those providing large quantities of water, set up an intake that allows for filtration of water before it enters storage. Filtration may not be sufficient to purify water and some form of treatment may be needed.

- Provide for treatment (further filtration or chlorination, for example) to purify water if needed. For household supplies, water can be boiled or chlorinated and stored in clean containers.

the water in the well thereby permitting the release of worm larvae into the water. Treat all water taken from open ponds or wells that might be contaminated with infected water fleas by filtering, chlorinating, or boiling it before drinking. These treatments will kill the larvae before they can infect a person.

### Water-Washed Diseases (Water Quantity and Accessibility Related)

These diseases are ones which can be prevented by the provision of sufficient quantities of safe water. To



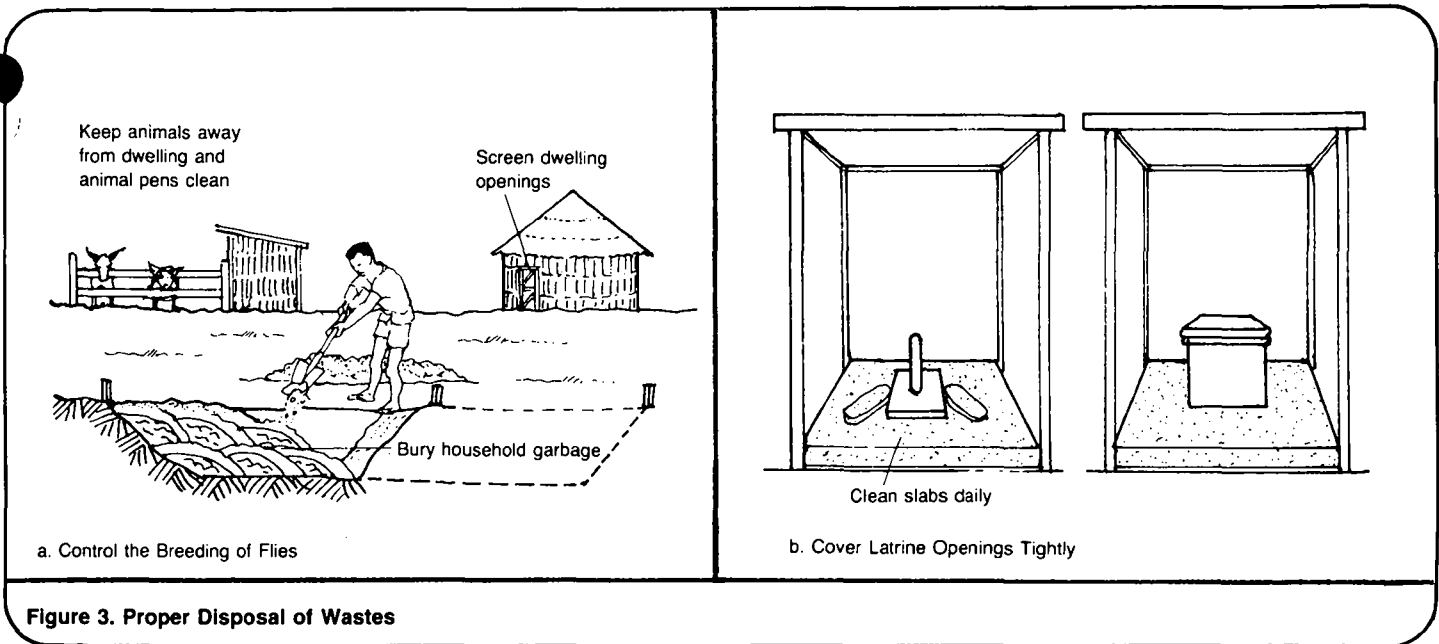


Figure 3. Proper Disposal of Wastes

prevent the spread of water-washed diseases, people should be educated and motivated to practice personal and family hygiene. Washing of hands and bathing in clean water are very important. Clothes and dishes should also be washed to ensure that skin diseases are not passed to people by contaminated hands, clothing, or utensils. The same wash water should not be used by more than one person. Common use of towels should be avoided.

In order to improve hygiene practices, sufficient, convenient quantities of water are needed. A method of developing a water supply of sufficient quantity, adequate quality and easy accessibility and reliability should be chosen with the involvement of the community. The source should be well-protected to prevent contamination of the water supply.

### Water-Contact Diseases (Body-of-Water Related)

Water-contact diseases are those which people get from having skin contact with water containing larval worms. There are both environmental and chemical means for controlling the spread of water-contact diseases.

Schistosomiasis is the major disease in this category. Schistosomiasis is controlled by breaking the chain of transmission at several points. The

following measures should be followed when attempting to control the spread of schistosomiasis.

- Encourage people to build sanitary facilities and use them. If the eggs in the feces and urine do not reach water they will die, preventing the infection of the snails. This method is useful but is only truly successful if everyone uses latrines for both urinating and defecating. Assurance that everyone over a large area would use them is impossible. Therefore, this method must be combined with a reduction of the snail population and by limiting human contact with infected waters.

- Reduce the snail population. In irrigation schemes, drainage ditches are better environments for snails than irrigation canals. Where drainage ditches are necessary, they must be treated regularly with chemicals that kill snails. When canals are built, line them with a smooth surface like concrete and provide for a rapid flow rate. Smooth surfaces are not attractive to snails and a fast flow of water removes them.

- Maintain the banks of all irrigation canals and bodies of water. Vegetation slows water flow and provides a good environment for snail

growth. Keep vegetation and weeds away from canals and beach areas. See Figure 4.

## Water-Related Insect Vectors (Water Site Related)

Diseases that fall into this category are caused and spread by insects that breed in water or in damp, high humidity environments near water sources. Several measures can be taken to control the populations of mosquitoes, tsetse flies, and blackflies which spread malaria, yellow fever, sleeping sickness (trypanosomiasis) and river blindness (onchocerciasis).

Control of virtually all these diseases involves the elimination of the mosquitoes and flies through environmental or chemical means. Although the application of both aerial and ground spraying of insecticides has proved very effective, there are questions about the environmental effects of using them on a large-scale for a long time. Chemical control is sure to continue, but other methods should also be incorporated into vector control plans.

- Control of the tsetse fly which transmits sleeping sickness can be achieved by changing the environment where flies breed. One method is bush clearing along water courses and around villages. An attempt should be made to use cleared areas for permanent agriculture or settlement and thereby keep the land clean of bush.

- Blackflies, which spread river blindness (onchocerciasis), breed in rapidly flowing rivers. Chemical means are the best control for blackflies but some alternative measures can be developed. When dams are built in fast-flowing streams and rivers, the upstream lakes cover the rapids and destroy the breeding areas of the blackfly. Spillways should be built on the vertical face of the dam to avoid creating a new breeding place for the flies.

Mosquitoes transmit both malaria and yellow fever. The control of these insects is important both on a large-scale and an individual household basis.

Large-scale measures other than spraying chemicals include the draining and filling of wet, swampy places where mosquitoes breed.

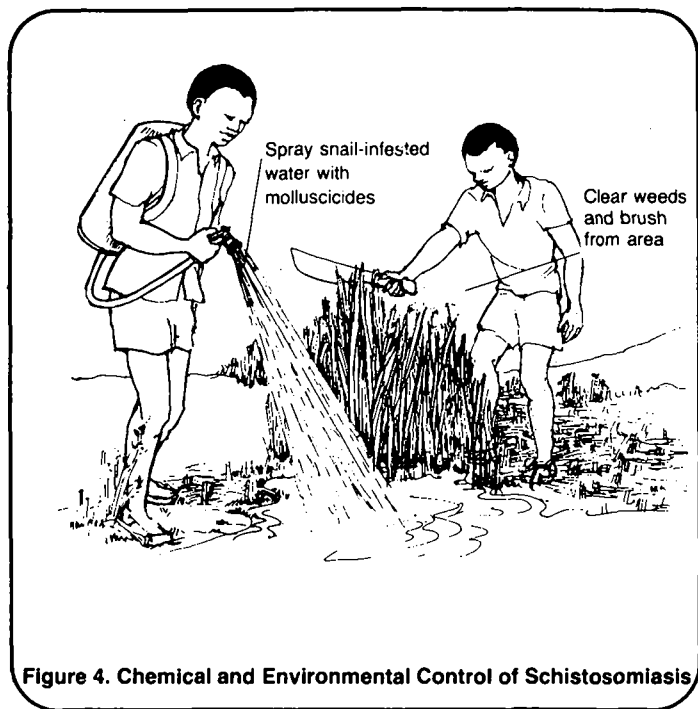


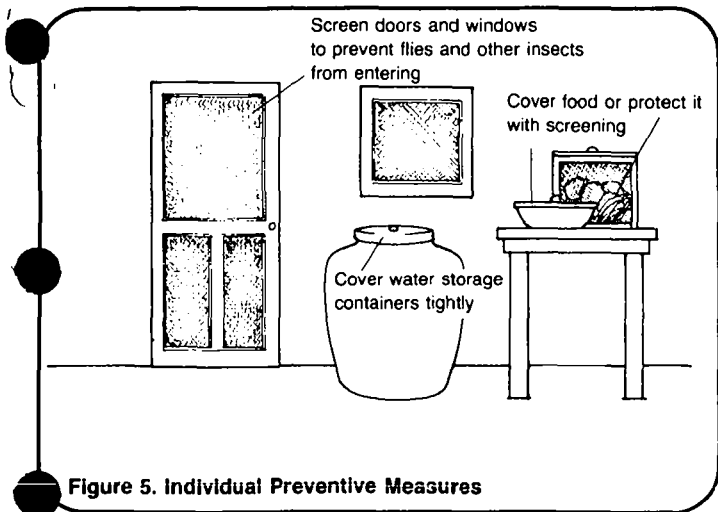
Figure 4. Chemical and Environmental Control of Schistosomiasis

- Drain large standing pools of water and fill in swampy areas to prevent the snails from breeding. Whenever possible, avoid the creation of small reservoirs or pools of water. These environments are very attractive to snails.

- Use chemicals that kill snails molluscicides. They are quite effective in controlling the snail population. Local spraying is the common method of applying molluscicides to water and is quite successful for irrigation projects. See Figure 4. Aerial spraying has also proved effective in many places. The application of molluscicides is less successful in large bodies of water because the water volume dilutes the molluscicides. Only if a specific local site on a large water body is treated with chemicals will success be achieved.

Swimming, bathing and clothes washing in infected water should be avoided. Whenever possible, houses and settlements should be located away from infected waters. In all settlements, both new and existing, potable, piped water systems should be developed. Safe water should be provided in sufficient quantities for drinking, bathing and washing.

Smaller-scale and individual measures should also be taken to control the breeding of mosquitoes. All possible standing water where mosquitoes could breed should be covered. Water storage jars and wells are particularly attractive breeding places for mosquitoes. Standing water in gutters should be removed and gutters should be sloped to remove water. At well sites, do not permit water to pool. Some sort of drainage should be built to move water away from the site and measures should be taken to prevent pools of water from developing. Remove any garbage where pools of water can collect and cover latrines so that mosquitoes cannot breed inside. Figure 5 shows some individual preventive measures.



- Make sure that all latrines have covers to prevent insects from breeding in the latrine pit.

- Provide sufficient quantities of water to ensure that people can practice personal hygiene. Make sure that people understand the need to wash their hands before eating and after defecating.

- Develop ways to keep flies off food. Screen areas where food is stored. Spraying the home periodically will keep flies and cockroaches away from food.

- Keep animals from entering the home and from coming into close contact with young children. Feces from animals can also spread disease.

### Summary

Methods for controlling the spread of disease range from very simple and inexpensive family-oriented approaches to large-scale, more expensive community, regional and national programs. The choice of method will greatly depend on the circumstances, the problems to be remedied and the resources available. Generally, no single method will prove sufficient and a combination of methods is necessary.

The simplest methods of control are those which can be instituted by the construction of simple water systems and sanitary waste disposal systems. These systems are discussed at length in the technical notes on rural water supply and sanitation. See "How to Use Technical Notes," HR.G, for a full list of technical notes.

No successful control program can be developed unless people are educated about the need for a system. A thorough health education program must be developed so that people recognize the problem themselves and are stimulated to search for the appropriate solutions. Community participation is discussed in greater detail in the technical notes on human resources.

These measures, coupled with spraying and a program of health, education will greatly help reduce the growth of the mosquito population.

### Sanitation-Related Diseases (Fecal polluted soil related)

Diseases in this category, such as hookworm and roundworm, are a direct result in fecal pollution of soil and the lack of knowledge about good hygiene practices. These diseases can be controlled by relatively simple environmental improvements.

- Educate people on the need to use latrines and train children to use them at a very early age. Diseases are sure to be spread where human wastes are deposited on the ground or in rivers and streams.

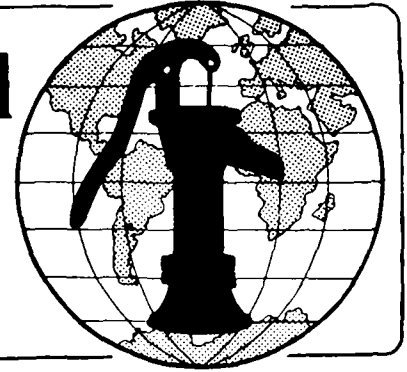
## Notes

## Notes

## Notes

**Technical Notes** are part of a set of "Water for the World" materials produced under contract to the U.S. Agency for International Development by National Demonstration Water Project, Institute for Rural Water, and National Environmental Health Association. Artwork was done by Redwing Art Service. Technical Notes are intended to provide assistance to a broad range of people with field responsibility for village water supply and sanitation projects in the developing nations. For more detail on the purpose, organization and suggestions for use of Technical Notes, see the introductory Note in the series, titled "Using 'Water for the World' Technical Notes." Other parts of the "Water for the World" series include a comprehensive Program Manual and several Policy Perspectives. Further information on these materials may be obtained from the Development Information Center, Agency for International Development, Washington, D.C., 20523, U.S.A.

# Water for the World



## Planning Disease Control Programs Technical Note No. DIS. 1.P.1

The planning of a disease control program should include certain steps to ensure its success. Program planning must include a high level of community participation. This will help the community recognize problems and become motivated to solve them in both the present and future. This technical note discusses the process by which planners develop successful projects. To ensure success, all these ideas require adaptation to local conditions.

### Useful Definitions

**SANITARY SURVEY** - A study of the sanitary condition of an area. The survey detects sources of water contamination and origins of disease through observation of local environmental conditions.

**VECTOR** - An animal or insect that transmits a disease-producing organism from one host to another.

Eight steps comprise a planning process to assure that all problems and possibilities are considered in the development, implementation and evaluation of a program or project. The steps are essential for mobilizing community support and creating a sense of responsibility for the program.

### Recognize the Problem

In a disease control program, there are two important steps to recognizing the problem. First, the specific diseases to be controlled must be identified. Where large numbers of people suffer from diseases such as river blindness, malaria, diarrheas, and the like, the symptoms can be observed and identified. Conversation with regional and local health officials will provide information on those diseases which affect people in the specific location.

Second, the means by which the diseases are transmitted need to be identified. This task is somewhat more difficult but usually includes poor sanitation facilities and practices, conditions that permit insect breeding, and unsafe water supplies. These can be identified through simple observation and by talking to community members. Specific identification is very important for determining appropriate solutions for environmental health problems.

Once the problem or need is recognized and an understanding of it is gained, community involvement in solutions can begin.

### Organize Community Support and Set Objectives

There are several important ways to promote community awareness and organize community support. First, to solve their own problems, both official leaders (political and religious) and non-official leaders (respected community persons) should be approached and the problems discussed with them. The leaders may be able to suggest ways to deal with the problem and to stimulate further awareness in the community through meetings and other community activities. At the least, once they are informed, they will likely lend their support to programs to solve the problems. In many cases, community leaders are those who are aware of needs and seek advice to achieve solutions. These people are excellent sources of leadership and should be used as resources in gaining community support.

Another important approach is to develop a program of education for the community. Health education for teachers, students and community groups

is essential in creating an awareness of needs and in motivating people to begin thinking of measures which they can take to improve local conditions.

Along with organized education programs, less formal educational activities should be organized. Visits to homes should be made and small group talks given to several neighbors. These small informal talks greatly complement organized education programs.

Throughout the education program, objectives should be defined and met. Objectives will greatly depend upon what needs are identified. An objective may be to eliminate hookworm in a community, or to provide potable water to the entire community. The objective should be fairly wide in scope. Basic objectives for water supply programs will focus on the need to provide water of sufficient quantity and adequate quality. Quality should be such that it meets or comes close to drinking water standards established by the World Health Organization. A discussion of drinking water standards is found in "Determining the Need for Water Treatment," RWS.3.P.1. Water supplies should be easily accessible and reliable.

Objectives for waste disposal systems involve establishing sufficient guidelines for adequate sanitary disposal of wastes and the prevention of seepage of wastes into waterways or water supplies. Solid waste disposal should be sanitary and prevent the breeding of flies and rodents which spread disease.

Useful information in planning and developing safe water systems is available in the rural water supply series of technical notes. Waste disposal systems are discussed in the sanitation series. See "How to Use Technical Notes," HR.G for a full list of technical notes. Once the objective is set, the means to reach it must be explored. The first step in deciding on the means involves collecting data about the community.

## Collect Data

The collection of data, combined with a sanitary survey, should provide the necessary information to determine

the structure of the disease control or prevention program. Data should be collected through interviews with local leaders, house visits and interviews with members of households and by trips to hospitals, clinics, agricultural cooperatives or any other regional or national governmental and private institutions where health and economic data are kept. The purpose of the data collection is to get a picture of the socio-economic conditions of the community. The sanitary survey is similar to the data collection process and really should be a part of it whenever the problem is recognized as a result of inadequate water supply or poor sanitation. Sanitary surveys should determine the conditions that contribute to the spread of disease: lack of latrines, sources of contamination of water, poor hygienic practices and others. Information on conducting a sanitary survey is available in "Conducting Sanitary Surveys to Determine Acceptable Surface Water Sources," RWS.1.P.2. Worksheet A and B show examples of information that can be collected in a sanitary survey.

Data collection permits the planner to understand the problem, conditions and possible solutions given the resources and attitudes of the people. Once a good picture of the community is gained, alternatives for solving the problem can be discussed.

## Formulate Alternatives

Once all available data on the community's health and socio-economic conditions have been collected, formulate possible solutions to the problem. The best program to follow will provide for three important results: (a) development of a community health education program stressing prevention of diseases, (b) establishment of an organized effort to solve community problems, and (c) creation of a desire in the community to continue its efforts in improving local conditions. In some cases, a fourth consideration should be added to the list. Preventive measures should be coupled with treatment for those already suffering from the disease. In that way, the disease is eliminated through both treatment and preventive measures which inhibit its further spread or development.



**Worksheet A. Questions to be Answered by a Sanitary Survey**

- |  |       |       |
|--|-------|-------|
| 1. Do potential sources of surface contamination exist | Yes   | No    |
| a) above the site or in the watershed?                 | _____ | _____ |
| b) at the site?  | _____ | _____ |

If yes, determine these sources and

- a) remove sources of contamination, and/or
- b) protect the water supply, or
- c) find a more acceptable water supply.

- |  |       |       |
|--|-------|-------|
| 2. Do potential sources of fecal contamination exist | Yes   | No    |
| a) above the site or in the watershed?               | _____ | _____ |
| b) at the site?                                      | _____ | _____ |

If yes, determine these sources and

- a) analyze the water, or
- b) remove sources of contamination.

If level of coliform bacteria is greater than 10 organisms per 100ml of water,

- a) water must be treated or
- b) an alternative source must be found.

- |  |       |       |
|--|-------|-------|
| 3. Does the water source have unacceptable chemical or physical qualities such as: | Yes   | No    |
| a) color?  | _____ | _____ |
| b) turbidity (1) all the time?   | _____ | _____ |
| (2) after a rainstorm?   | _____ | _____ |
| c) unpleasant odor?  | _____ | _____ |
| d) a lot of salt?  | _____ | _____ |
| e) excessive algae?  | _____ | _____ |
| f) excessive flourides?  | _____ | _____ |
| g) hardness?   | _____ | _____ |

- |   |       |       |
|---|-------|-------|
| 4. Do conditions for insect breeding exist?                             | Yes   | No    |
| a) latrines, wells, water storage jars and garbage pits left uncovered? | _____ | _____ |
| b) feces scattered on the ground?                                       | _____ | _____ |
| c) pools of standing water?   | _____ | _____ |
| d) brush areas around water and villages?                               | _____ | _____ |
| e) swampy areas near community?   | _____ | _____ |

If the answer is YES to any of these questions, study the water source carefully and analyze the water if possible. Generally, these conditions will make water unacceptable to the users and the source must either be treated or abandoned for a new one.

## Worksheet B. Planning the Development of a Surface Water Source

1. Name of community \_\_\_\_\_
2. Population \_\_\_\_\_
3. Type and number of water-related diseases in the community per year \_\_\_\_\_
4. Significant beliefs and taboos about health, sanitation and water \_\_\_\_\_
5. Present source(s) of water and form of distribution \_\_\_\_\_

Determine:

water quality (see RWS.1.P.2) \_\_\_\_\_

water quantity (see RWS.1.P.3) \_\_\_\_\_

accessibility \_\_\_\_\_

reliability \_\_\_\_\_

form of and location of distribution system \_\_\_\_\_

6. Potential source(s) of water \_\_\_\_\_

Determine:

water quality (see RWS.1.P.2) \_\_\_\_\_

water quantity (see RWS.1.P.3) \_\_\_\_\_

accessibility \_\_\_\_\_

reliability \_\_\_\_\_

7. Methods of waste disposal

sanitary \_\_\_\_\_

non-sanitary \_\_\_\_\_

none \_\_\_\_\_

8. Conditions appropriate to insect breeding \_\_\_\_\_

9. Community resources and organization

Determine:

a) sources of income \_\_\_\_\_

b) seasonal distribution of income \_\_\_\_\_

c) labor and materials available \_\_\_\_\_

d) infrastructure in existence \_\_\_\_\_

e) concerned community leaders and groups \_\_\_\_\_

10. Project Costs

Estimate total costs for:

a) equipment \_\_\_\_\_

b) materials \_\_\_\_\_

c) labor \_\_\_\_\_

d) maintenance \_\_\_\_\_

e) other costs (transportation, etc) \_\_\_\_\_

11. Sources of finance

Determine:

a) local funding capability \_\_\_\_\_

b) external funding possibilities \_\_\_\_\_

Determine the most appropriate disease control program for the community's needs and discuss cost and resource requirements of each alternative with community leaders. These discussions are necessary to determine community preferences and ultimately select an appropriate method.

### Select a Method

Where several problems exist or where different alternatives for solving the problem are available, it is important to choose the most appropriate method. When determining whether a method is appropriate consider the following:

Suitability to the Needs of the Community. Determine which program will truly meet the needs of the community now and in the future. Select a program that stresses prevention, that creates a system through which health education becomes accepted as an institution, and that stimulates people's desires to make improvements.

Social Acceptability. Select a method that involves the participation of the community. Community participation ensures that a chosen program will be acceptable to the community, that the community will be responsible for its implementation and continuation, and that the program will be successful in the long run.

Economic Factors. Determine whether the community has the economic resources to carry through the entire program. A community may be emotionally committed to a program but unless it can meet all the costs, success is doubtful. A successful project uses local contributions of labor, fund-raising activities and donations of agricultural or material goods. Often, preventive measures or the development of systems which promote prevention can be achieved using local resources that do not overburden the community. If medical treatment is proposed, help should be sought from the ministry of health or from private and public institutions.

Establish the Program. Once the best method is chosen, develop a program plan. The plan should serve as a guide for the life of the program and ensure that there are no organizational

problems or gaps in program implementation. In many cases, the program plan must be submitted to a governmental or donor agency for approval or funding and it should be quite complete. The program plan should state a goal, provide population and other statistical information, indicate the number of people benefiting from the program, and demonstrate how the project will benefit the community. Moreover, the following information should be included in any project plan: (a) proposed program, (b) costs, (c) sources of funding, (d) implementation schedule, (e) construction plans and materials list, and (f) operation and maintenance plans.

Proposed Program. A complete explanation of the program including all components should be included. Mention the educational, construction, and treatment aspects of disease control. Photographs of the site, maps and other important data should be included. Also, people involved in the program development and participants in the implementation should be named. Any institutional affiliation should be mentioned.

Costs. Estimated costs should be included in the program proposal for all materials such as production of audio-visual materials, construction and maintenance of latrines or water systems, and spraying or medicines. The value of labor should also be included even if volunteer labor will be used. Labor counts as a community contribution.

Sources of Funding. Use local funds whenever possible. Local funds can be obtained through contributions of money, and agricultural goods, through community fund-raising activities, from fees charged for medicines and from various other sources. Communities may be eligible for loans or for outside funding and should investigate the possibilities that are available. Most donor agencies require a minimum commitment and contribution by the community before money is given. Community contributions imply community acceptance and should be encouraged.

Implementation Schedule. Determine the amount of time necessary for completing the project. Preventive

measures may begin to be accepted and adopted by people only after a good education program has been instituted. Be sure to allow sufficient time for the education program to become effective. Consider the timing of the schedule to take into account the school year, harvests, heavy work times and the climate.

Construction Plans. If the program requires the construction of sanitary waste disposal facilities or protective water structures, include plans of the proposed design. Include with it a list of needed materials and estimated costs of these.

Operation and Maintenance Plan. Mention in the project plan methods that will be used to ensure the continued operation of the program. Discuss the training that will be done and identify who will be trained. Attempt to name a person or people who will assume responsibility for continued operation. One method that may be useful is to form a local committee to oversee the project and accept responsibility for it. It should include community leaders, people such as teachers or health aides with responsibility in the community, and others such as parents interested in improving local conditions.

If a water or waste disposal system is established, a method for ensuring the operation and maintenance of the system should be developed. Local technicians should be trained and given responsibility for the system. Methods for training these technicians and using them in the field should be outlined in the project plan.

#### Carry Out Construction of the System

When all planning and approval steps have been completed, it is necessary to construct the facilities needed to accomplish the goals set out in the plan. Depending on the size and complexity of the project, this can be done in a variety of ways. For the construction of simple systems, the work can be done with local skilled labor though it may be necessary to hire a foreman who understands the whole construction process and can organize and use local skilled and unskilled labor to get the job done.

If the project is large and complicated, it may be necessary to contract for all or the complicated parts of the system. In that case, the supervisors of the project will have to be skilled in writing and managing of contracts. They may need to obtain legal assistance from the regional or national environmental health agencies. However the system is constructed, it is important that the technical plans be carried out precisely and completely to avoid future problems in operation and maintenance.

#### Evaluate the System

Once the project has been completed or is in the final stages, evaluate it to see whether the goals set at the beginning have been met. The evaluation should provide useful statistics on the success of the program. For example, data can be collected on the number of structures for water protection and sanitary waste disposal. If possible, attempt to gain information on whether there has been a decrease in illnesses. Hygienic practices should be observed and evaluated to determine the influence of the program on the people's way of life. The following questions are examples of those which should be addressed in the evaluation.

(1) Have people received sufficient education to gain an awareness of the problem and become dedicated to improving environmental conditions?

(2) Have people willingly adopted the suggestions and advice about measures which should be taken?

(3) Are people willing to make contributions of time, material or money to the program?

(4) What has been the effect on disease in the community since the project has ended?

(5) Do people understand the connection between disease and lack of hygiene and sanitation?

(6) Are people sufficiently trained to handle problems that arise? Do they know where to obtain supplies? Is there a willingness to maintain the established system?

(7) Are measures being taken not only to prevent the spread of disease but also to treat those with it and thereby eliminate it completely?

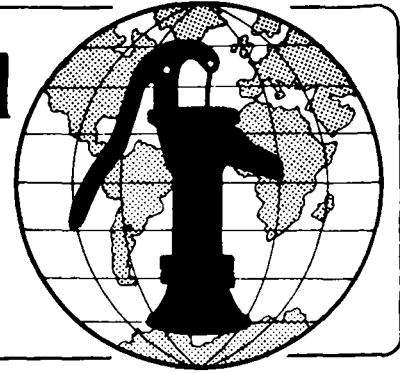
(8) How many people benefit from the project?

These types of questions should be asked when evaluating the program. Each evaluation should be thorough in order to provide information for the development of future projects. Compare the evaluation of this project to those in the past and those in other regions for valuable lessons in planning disease control programs.

## Notes

**Technical Notes** are part of a set of "Water for the World" materials produced under contract to the U.S. Agency for International Development by National Demonstration Water Project, Institute for Rural Water, and National Environmental Health Association. Artwork was done by Redwing Art Service. Technical Notes are intended to provide assistance to a broad range of people with field responsibility for village water supply and sanitation projects in the developing nations. For more detail on the purpose, organization and suggestions for use of Technical Notes, see the introductory Note in the series, titled "Using 'Water for the World' Technical Notes." Other parts of the "Water for the World" series include a comprehensive Program Manual and several Policy Perspectives. Further information on these materials may be obtained from the Development Information Center, Agency for International Development, Washington, D.C., 20523, U.S.A.

# Water for the World



## Methods of Controlling Schistosomiasis

Technical Note No. DIS. 2.M.1

Schistosomiasis or bilharziasis is a disease that is common throughout the world. It results from poor sanitary practices and from the development of projects to promote irrigation and provide hydroelectric power to growing communities. Although schistosomiasis is not a fatal disease, it does cause a great deal of pain and discomfort. Furthermore, people are weakened by the disease and cannot be as productive as when they are healthy.

This technical note gives a brief description of schistosomiasis and discusses methods that should be taken to control its spread. Both environmental and chemical measures for controlling schistosomiasis are mentioned.

### Useful Definitions

**PARASITE** - Worms, insects or mites which live in or on other animals.

**RESERVOIR** - A natural or artificial lake where water is stored.

### Disease Transmission

Schistosomiasis which is caused by a parasitic worm that lives inside the veins of the intestine or urinary bladder affects many people who live near fresh water or irrigation projects. The parasite must spend part of its life in a snail. It is spread in the following manner:

- A person with schistosomiasis passes worm eggs in urine or feces that get into water.

- In the water, the eggs hatch as larvae which seek and enter specific types of snails.

- In the snail, they form a sac in the liver where forked-tailed larvae are produced.

- Each day many scores of the larvae escape from the cyst into water where they seek contact with a person.

- On contact with skin, the parasite actively penetrates and travels through the bloodstream to the veins of the intestine or bladder. The parasites grow and lay eggs which are passed in urine or feces to continue the process of transmission. Figure 1 shows how schistosomiasis is transmitted.

Although an itchy rash can develop around the place on the skin where the parasites enter, and an affected person can have a fever and cough for two to four weeks afterwards, serious damage comes later when the worms reach adulthood and begin laying eggs. The body reacts to the eggs as they migrate through the wall of the intestine or bladder or are carried by the blood flow to other parts of the body. A person with schistosomiasis can have tumors, sores that do not heal, internal bleeding, diarrhea, a bloated abdomen caused by accumulated fluids, liver and spleen damage, and other symptoms. Sometimes the eggs can even cause heart, lung, and brain damage. Schistosomiasis is a very serious health problem. Even people who have a mild infestation can feel tired all the time, be drowsy and unable to concentrate on work, have stomach cramps and lose weight. While few people die from schistosomiasis, many people suffer a great deal because of it and die of other diseases because of their weakened condition. Since so many symptoms can indicate schistosomiasis, it can only be positively diagnosed when living eggs of the parasite are found in a stool or urine specimen, or when some other medical test is performed.

## SCHISTOSOMIASIS

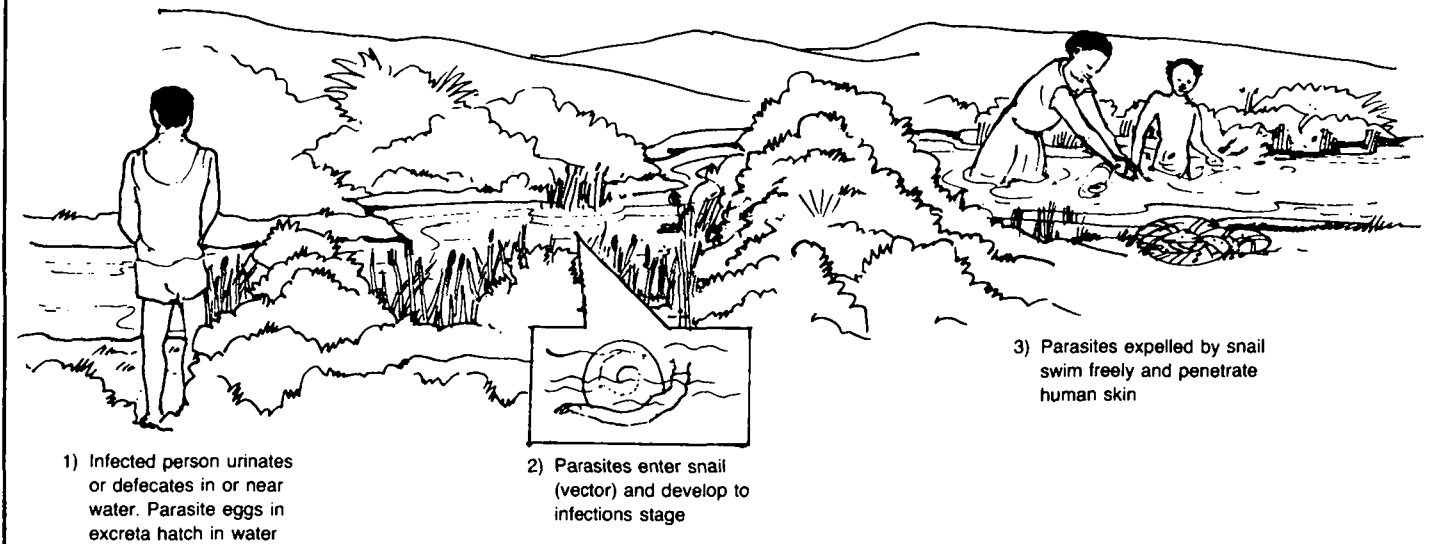


Figure 1. Transmission of Schistosomiasis

If schistosomiasis is found in an area, it can be fought by interrupting the life cycle of the parasite. This can be done through: environmental control, chemical control and treatment.

### Control of Schistosomiasis

Environmental Control. Changing local conditions and practices are very important in controlling the spread of schistosomiasis. Great progress can be made with improved sanitation and more appropriate irrigation methods. The following measures are extremely useful in controlling the spread of schistosomiasis.

- Educate the people about the disease. Develop an education program that adequately explains the link between poor sanitation and the spread of the disease. Teach preventive measures.

- Encourage people to build and use latrines for both urinating and defecating. Neither urine or feces should ever be passed directly into a stream or other body of water. If health education persists people will be aware of the need to use latrines and will build them. Instruct families in the use and care of latrines so that conditions are sanitary.

- Make sure that there is an adequate supply of good quality (uncontaminated) water near the community. A protected source should provide sufficient water for drinking, bathing and washing clothes, especially in areas where there is schistosomiasis. People should be encouraged to develop good water sources and to avoid entering infected waters. Generally this is easier said than done.

- Where water supplies are contaminated with schistosomiasis, treatment is necessary to remove the schistosomes. Treatment practices such as boiling and chlorination will kill the parasites in the water. Information on water treatment is available in "Methods of Water Treatment," RWS.3. Water treatment can be done on both an individual or household level or it can be community-wide.

- Where water supplies are provided, measures should be taken to ensure that the water does not become infected. Wells should be properly constructed, cased, capped and sealed from surface run-off. Springs should be well-capped and latrines should be built down hill from water sources and at least 15m away. See Figure 2.



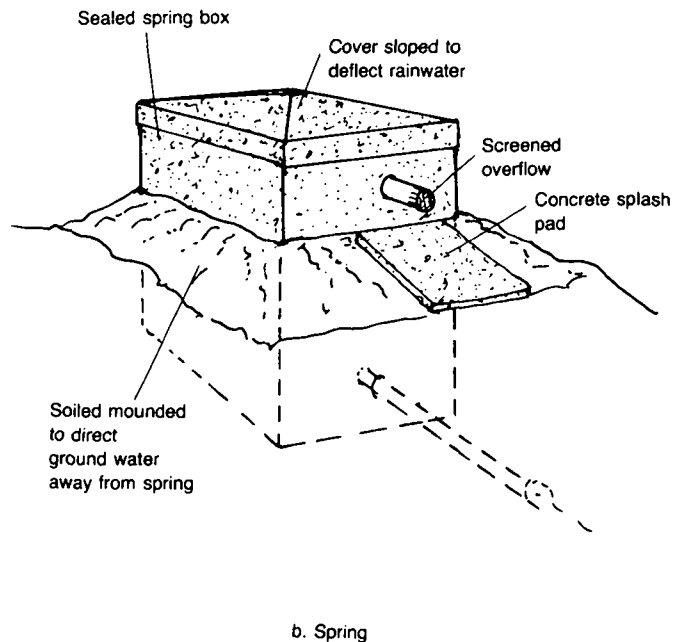
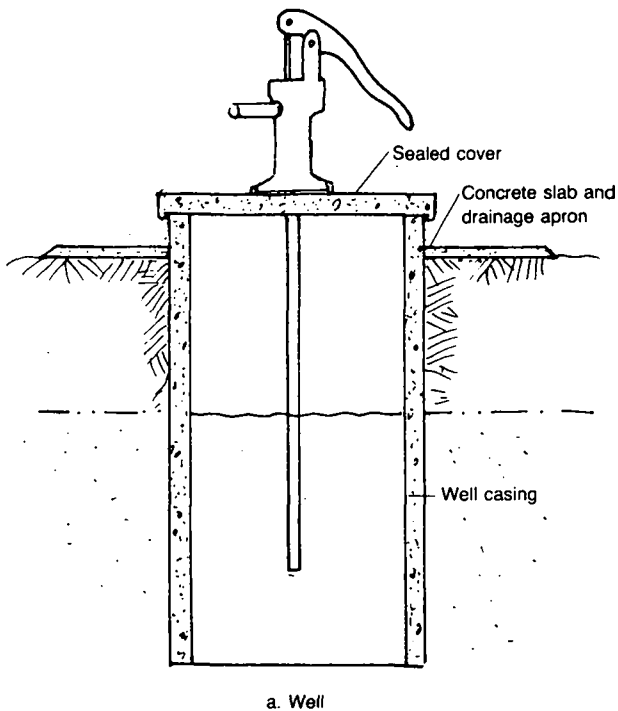


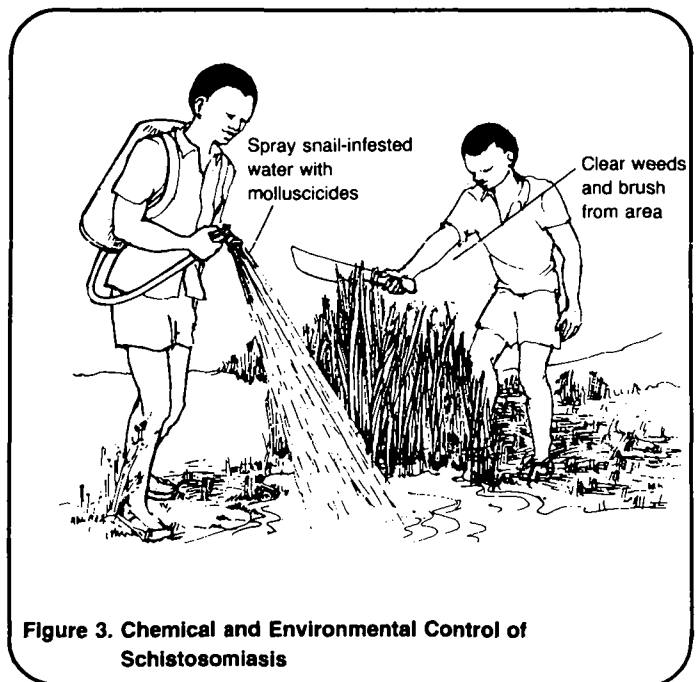
Figure 2. Proper Protection of Water Supplies

Where irrigation is used, the following procedures to limit and control snails are very important in controlling schistosomiasis.

- Eliminate standing water where snails can breed. Level the land to make irrigation more effective and reduce the chances of water forming pools. Standing water can also be channeled into a single pond which can be treated with chemicals to destroy snails. Small depressions where water can collect should be filled in.

- Build adequate drainage facilities. Either open ditch drainage or underground tile drains can be used. Underground drains are better for controlling the spread of disease, but are not generally possible for rural communities because of their cost. Open drains invite snail breeding, but control through spraying is possible. Open ditches which can be chemically treated are preferable to many small stagnant pools or wet areas that breed snails and cannot be treated. Good drainage also improves crop yields.

- Clean weeds and vegetation from streams and irrigation ditches as shown in Figure 3. Snails cling to vegetation and breed.



- Provide for increased water flow when designing canals or line canals with concrete to increase the flow in them. Snails cannot attach themselves to canal walls when the velocity of water exceeds 0.3m/second.

- Provide a system for raising and lowering the water level in canals.

When the water level falls, many snails are stranded on the sides of canals. Many will die or be eaten by predators.

- Do not use small reservoirs to store irrigation water overnight. These reservoirs quickly become breeding grounds for snails and thus for schistosomiasis. If overnight storage is necessary, use a large reservoir and make sure it is drained completely each day.

- During high snail breeding times, plant crops do not require large amounts of water. Attempt to identify that period of time or season when the snail population seems to be the greatest.

These control measures are very important in stopping the spread of disease. They should complement a well-organized public education program stressing health and improved irrigation practices. People must be educated about the problem and definite steps must be taken to solve it.

## Chemical Control

Along with environmental methods of control, chemical control plays a very important role in reducing the spread of schistosomiasis. Chemical control of schistosomiasis depends upon the use of molluscicides, chemicals that kill snails. There are several types of molluscicides, listed in Table 1 which can be placed in the reservoirs or irrigation canals to kill the snails. The use of molluscicides has the following advantages:

- the chemicals can be put in the water by one agency, and a small group of people can treat an entire area;

- the snails are completely, or almost completely, gone for a time, so a high level of control is possible; and

- the technology for putting chemicals into the water to control snails is well known and not difficult.

There are some disadvantages to chemical use, however:

- some chemicals that kill snails also can kill fish, or water plants;

- it is possible that the snails in an area may eventually become resistant to the chemical used to kill them, though this has not happened yet;

- improper use of a chemical-- putting far too much in the water, for example--can be harmful to people; and

- chemical application must be repeated.

The following chemicals are most commonly used. Bayluscide kills snails and snail eggs. It will not harm people or animals but it does kill fish. The chemical comes in liquid or powder form. Bayluscide is used often in controlling snails because it is not difficult to use and it is powerful so that only small quantities need to be used.

Frescon (N-tritylmorpholine) kills snails but not their eggs and therefore does not provide the amount of control that Bayluscide does. Frescon does not kill fish.

Copper sulfate kills snails but is not effective in killing snail eggs. It is also safe for fish. Because of its low cost and general availability, it is widely used for killing snails.

Sodium Pentachlorophenate (NaPCP) kills snails and snail eggs. The chemical does not work well against snails which live partly on land and partly in water as sunlight dilutes its strength.

Yurimin kills both snails and their eggs.

Table 1 lists the various molluscicides and specific information on them. The choice of chemical depends upon local availability and price. Usually, mixing instructions and strength applications are given by the manufacturer. Follow all instructions carefully when using chemicals. The amount to use and the frequency of application will greatly depend on the extent of the snail problem and its reoccurrence. Chemical control should be combined with effective environmental measures to provide for a complete and safe control program.

**Table 1. Molluscicides and Their Properties**

	BAYLUSCIDE (Niclosamide)	FRESCON (N-tritylmorpholine)	COPPER SULFATE	SODIUM PENTACHLORPHENATE	YURIMIN
Does it usually kill fish?	Yes	No	No	No	No
Does it kill plants?	No	No	Yes	No	No
Does it kill snail eggs as well as adult snails?	Yes	No	No	No	Yes
Is it affected by sunlight?	Yes	---	No	Yes	No
Is it affected by whether the water is running?	Yes	No	Yes	No	---
What forms are available?	Powder, emulsion	Emulsion	Powder	Flakes, pellets, briquettes	Granules
How soluble is it?	230 ppm* (pH dependent)**	---	32%	33%	Very slight

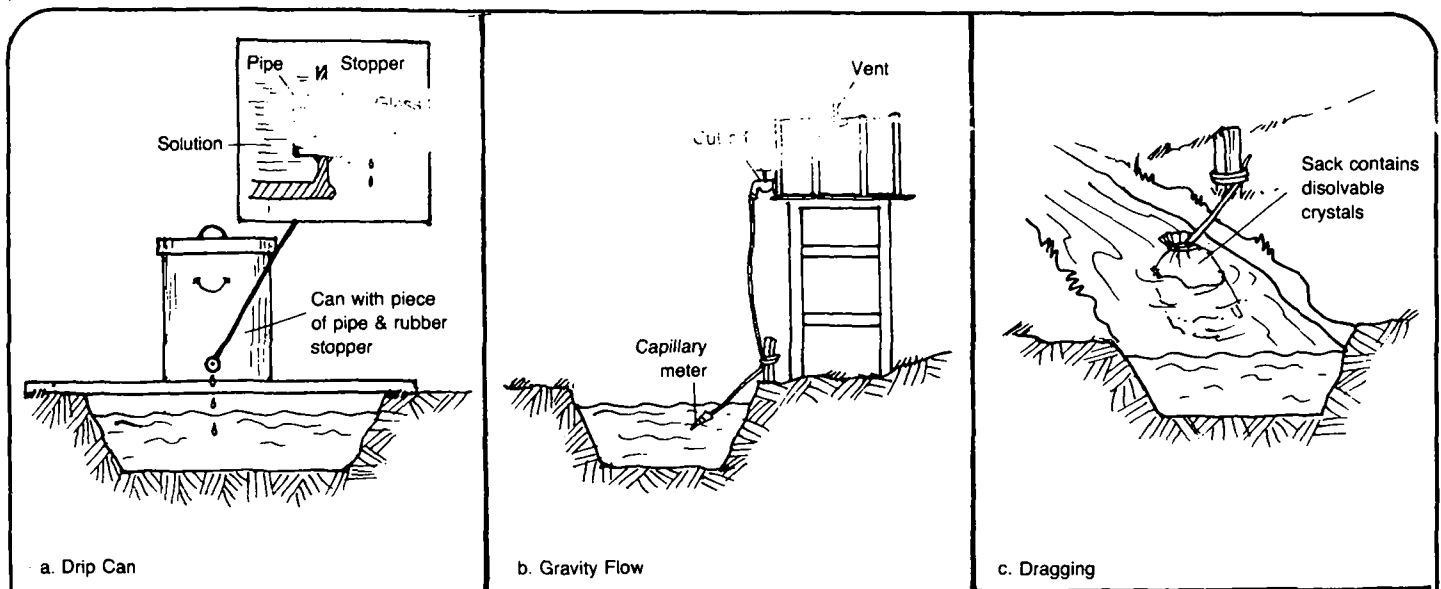
\* parts per million

\*\* how alkaline or acid the water is

Figure 4 shows various types of equipment needed to apply the molluscicides. Most require the use of a pump for spray application or else a drip feeder can be installed. A drip bag can also be developed and left to float in the water.

### Herbal Control

Endod is an Ethiopian plant which is poisonous to snails. The plant is very similar to a pomegranate. Snails avoid areas where endod grows, and those



**Figure 4. Means of Applying Molluscicides to Irrigation Ditches or Streams**

areas are generally free from schistosomiasis. In certain areas, growing endod for natural control of schistosomiasis may be possible and its use should be investigated. Endod seeds or plants could be imported and test growths done in agricultural research areas to check its suitability and effectiveness for snail-infested regions.

### **Individual Treatment**

Treatment of individuals can greatly reduce the weakening effects of schistosomiasis and help prevent further transmission of the disease. The drug Niridazole is commonly used for treatment but it does have certain bad side effects. However, treatment does not have to be stopped because of them. Niridazole is only effective in killing the adult worms and does not kill the eggs which are laid in the body and which may continue the chain of transmission.

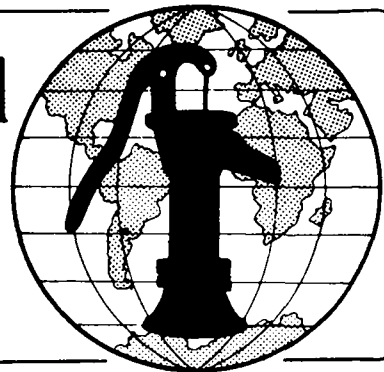
Treatment of individuals is thus relatively ineffective unless combined with other measures. Treatment on a mass scale should only begin when the appropriate environmental and chemical control measures have been taken. A disease control program should embody all aspects of control. Latrines, water supply and other projects should be implemented along with the introduction of mollusciciding. Once there is positive evidence of people's awareness of the problem and their willingness to do something about it and control measures have been instituted, treatment should begin on a mass scale. Only then will it have a positive effect.

## Notes

## Notes

**Technical Notes** are part of a set of "Water for the World" materials produced under contract to the U.S. Agency for International Development by National Demonstration Water Project, Institute for Rural Water, and National Environmental Health Association. Artwork was done by Redwing Art Service. Technical Notes are intended to provide assistance to a broad range of people with field responsibility for village water supply and sanitation projects in the developing nations. For more detail on the purpose, organization and suggestions for use of Technical Notes, see the introductory Note in the series, titled "Using 'Water for the World' Technical Notes." Other parts of the "Water for the World" series include a comprehensive Program Manual and several Policy Perspectives. Further information on these materials may be obtained from the Development Information Center, Agency for International Development, Washington, D.C., 20523, U.S.A.

# Water for the World



## Methods of Controlling African Trypanosomiasis Technical Note No. DIS. 2.M.2

African trypanosomiasis, more commonly known as sleeping sickness, is a widespread health problem in many parts of Africa. Two types of sleeping sickness are common, Gambian trypanosomiasis transmitted by a fly living along river banks, and Rhodesian trypanosomiasis transmitted by one that prefers woodland savannah. Both types of sleeping sicknesses are fatal to man if not treated.

This technical note discusses methods of controlling the spread of the disease through various environmental and chemical means of controlling the flies. The procedures mentioned should be followed when adopting a control program for sleeping sickness.

### Useful Definitions

**HABITAT** - A region or area where a plant or animal grows, lives, or is ordinarily found.

**VECTOR** - An animal or insect that transmits a disease-producing organism from one host to another.

### Disease Transmission

Sleeping sickness, or African trypanosomiasis is caused by a blood-inhabiting protozoan and is common in rural areas of many parts of Africa. The disease is spread by tsetse flies, of which there are many different kinds. The tsetse fly that spreads Gambian trypanosomiasis lives along rivers in areas of high humidity and lush vegetation. The fly which transmits Rhodesian trypanosomiasis lives in a drier savannah climate as it prefers large open areas. Both types of flies feed on both man and animals.

The tsetse fly is a blood sucker. Sleeping sickness is transmitted when the tsetse fly bites a person or animal with the sleeping sickness parasite in

its blood. The parasites pass into the body of the tsetse fly, undergo development, and are passed on to a new victim through the fly's saliva when it bites again.

When a person is bitten by an infected tsetse fly, after two or three days the area around the bite swells. The swelling itches and becomes red and painful. After five or six days, a swelling with a red spot on top appears, indicating infection. Some people are greatly bothered by the symptoms, others will barely notice them. When the parasites are in the blood, the disease is treatable. Symptoms include fever, swollen glands and a swollen spleen. In the latter stage of the disease, the parasites have reached the blood vessels of the brain and heart and constant weariness is the symptom. Without treatment, the patient will pass into a coma and die.

### Chemical Control

Chemical control is the best method of achieving large-scale tsetse fly control. The two insecticides commonly used for tsetse fly control are DDT and Dieldrin. The use of these insecticides can have very great environmental effects. They should be used with great care. Both insecticides remain in the fatty tissues of animals and are poisonous for fish and the animals that feed on them.

Aerial spraying permits large areas to be covered with a fine mist. This type of spraying can be done by airplane or helicopter. Helicopters may prove better because they can enter the thick brush where the flies breed and because the insecticide is forced downward to the ground by the force of air from the propeller. See Figure 1. Helicopter spraying is generally quite expensive, however. One spraying every

tical for eliminating the tsetse fly or destroying its habitat. Generally, it is best to combine environmental change with chemical spraying. Some environmental methods should be considered.

- Large scale brush clearing. Clear the brush that tsetse flies prefer for breeding. The best approach is to clear brush to make a barrier between a fly-free and fly-infested zone. A brush-free patch of ground 200m wide is usually sufficient to inhibit the spread of the tsetse fly.

Clearing can be done mechanically or manually. The area should be sprayed and workers' bodies well covered before clearing begins. Plan land clearing as a part of an overall design for crop-land development. In this way, any clearing will serve the dual purpose of preventing reinvasion of tsetse flies and providing new areas for suitable crop development.

- Where new towns are being developed, plan to locate them far from the breeding places of tsetse flies. Since tsetse flies do not travel far from their habitat, this method should prove effective. Another possibility which would prove effective but is difficult to implement is the transfer of entire populations from tsetse-fly-infested zones to non-infested zones. In this way, people would be removed from the danger posed by the flies. The cost of such a scheme would be very high and the organization very complicated.

- Establish a health education program to inform people about the causes of sleeping sickness and the measures which should be taken to avoid infection.

The education program should be structured in such a way that people can identify the fly and its habitat; an awareness of the transmission of the disease is created so that people understand the link between the insect and the disease; and people understand the dangers of the disease and what individual and community efforts can be made to eliminate the tsetse flies and the disease. People should learn to avoid areas where tsetse flies breed and to cover the body well when forced to enter a tsetse-fly-infested area.

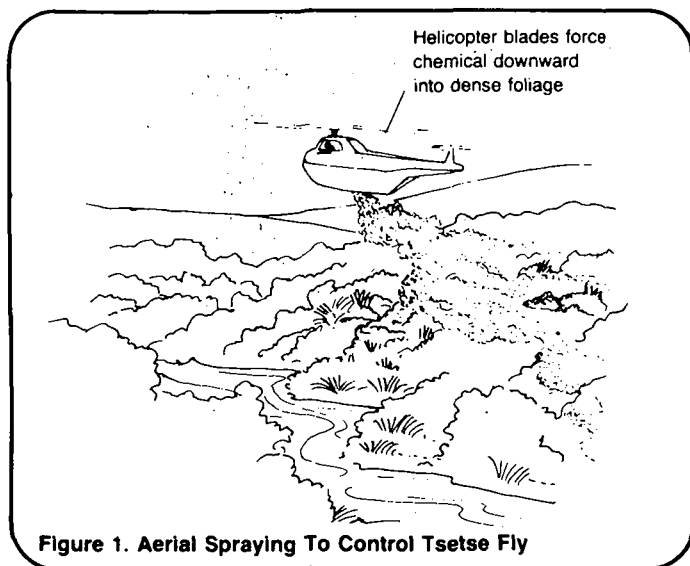
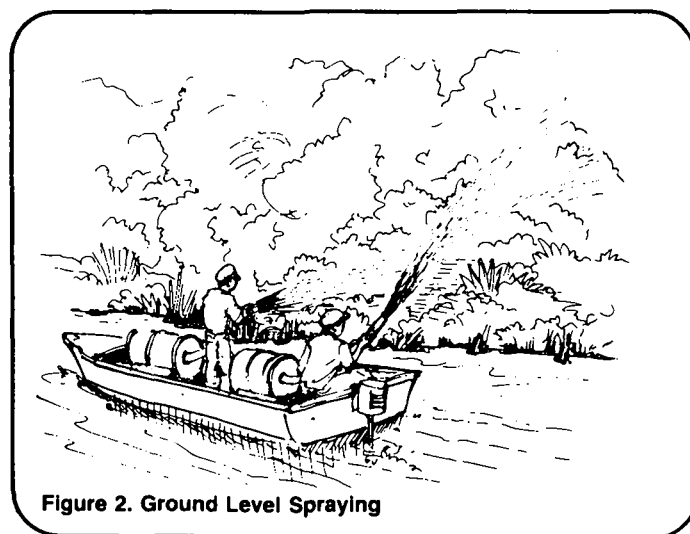


Figure 1. Aerial Spraying To Control Tsetse Fly

three or four months helps to reduce the fly population greatly.

Spraying can take place on the ground. Figure 2 shows a team of men spraying into thick brush along a river. Ground spraying is effective because heavily infested areas can be sprayed more often and more thoroughly. In some areas, combined aerial and ground spraying may prove the best



method. One spraying from an airplane or helicopter followed by a team of people hand-spraying riverside brush will prove very effective, especially where fly populations are dense.

### Other Control Measures

Some environmental measures are available to fight the tsetse fly but they are not very effective or prac-

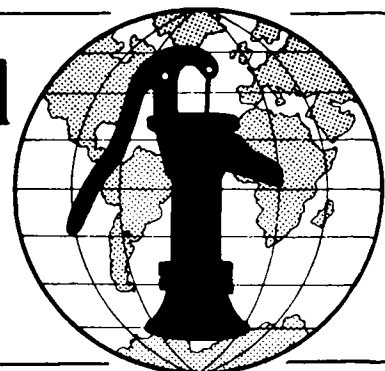


## Notes

## Notes

**Technical Notes** are part of a set of "Water for the World" materials produced under contract to the U.S. Agency for International Development by National Demonstration Water Project, Institute for Rural Water, and National Environmental Health Association. Artwork was done by Redwing Art Service. Technical Notes are intended to provide assistance to a broad range of people with field responsibility for village water supply and sanitation projects in the developing nations. For more detail on the purpose, organization and suggestions for use of Technical Notes, see the introductory Note in the series, titled "Using 'Water for the World' Technical Notes." Other parts of the "Water for the World" series include a comprehensive Program Manual and several Policy Perspectives. Further information on these materials may be obtained from the Development Information Center, Agency for International Development, Washington, D.C., 20523, U.S.A.

# Water for the World



## Methods of Controlling South American Trypanosomiasis Technical Note No. DIS. 2.M.3

South American trypanosomiasis caused by a blood and tissue inhabiting protozoan, is more commonly known as Chagas disease. It is becoming a widespread health problem throughout Latin America. Detection of the disease in most people is difficult and often no outside sign of infection is apparent. It is life-threatening and in most cases fatal. Young children are especially susceptible to it.

This technical note discusses methods of controlling Chagas disease and offers suggestions concerning implementation of a control program. Control is possible through relatively simple preventive measures.

### Disease Transmission

Chagas disease, or South American trypanosomiasis, is common in rural areas where poverty results in people living in poorly built and unsanitary houses. The disease is spread by a blood sucking cone-nosed bug which lives and breeds in animal dens and pens, thatched roofs, cracks and crevices of houses, and in mattresses, under beds, behind pictures and in dark corners. The bug is called a "Vinchuga" in Spanish or "Barbiero" in Portuguese. See Figure 1.

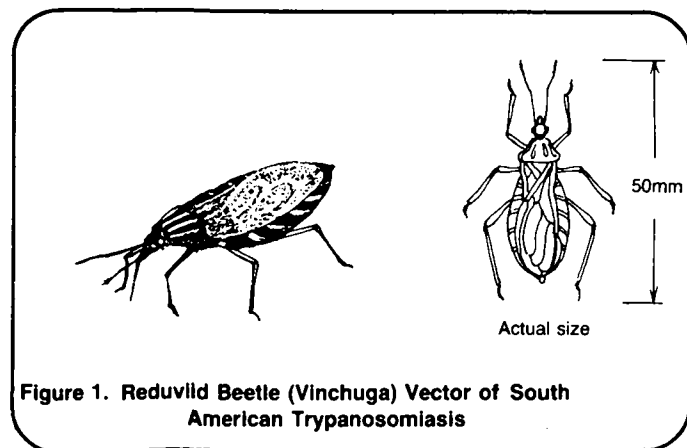


Figure 1. Reduvlid Beetle (Vinchuga) Vector of South American Trypanosomiasis

### Useful Definition

MAMMAL - Warm blooded animals whose offspring feed by mothers milk.

Chagas disease is spread in the following manner. The vinchuga bites an animal or person that has the parasite in its blood. The parasite enters the bug where it changes and multiplies and is passed out in the bug's feces. When the infected bug bites, it sucks blood until it is full, at which point it defecates. The parasite in the feces then enters through the bite wound in the skin or through some other cut. Generally, the vinchuga bites people on their faces around the mucus membranes or eyes. It bites mostly at night when people are sleeping. The person bitten does not feel the bite, but may feel an itch. By rubbing or scratching the bite, the feces are rubbed into the bite and the parasite enters the bloodstream.

It is not always possible to determine whether a person has been bitten. In some people, a red swelling or nodule forms after the bite indicating infection and a need for treatment. Often times, however, no red mark or nodule appears.

The parasites enter the cells of body organs and reproduce until the cell is destroyed and the parasites are freed to enter other cells. The heart and liver are especially affected with destruction of enough cells to damage normal function. Early phase symptoms are anemia, nervous illness, chills, and heart problems. Most patients die after several years of infection as internal organs fail.

## Control of Chagas Disease

Detection of the disease is still difficult and presently no drug is available for treatment. Research into cures for Chagas disease continues and is needed if the fatal effects of the disease are to be overcome. Today, the most effective and reasonable methods of control are preventive ones that focus on eliminating the bugs or preventing them from biting people. The following list of control measures should be studied and measures should be taken to use them to decrease the chance of infection.

In Chagas disease areas:

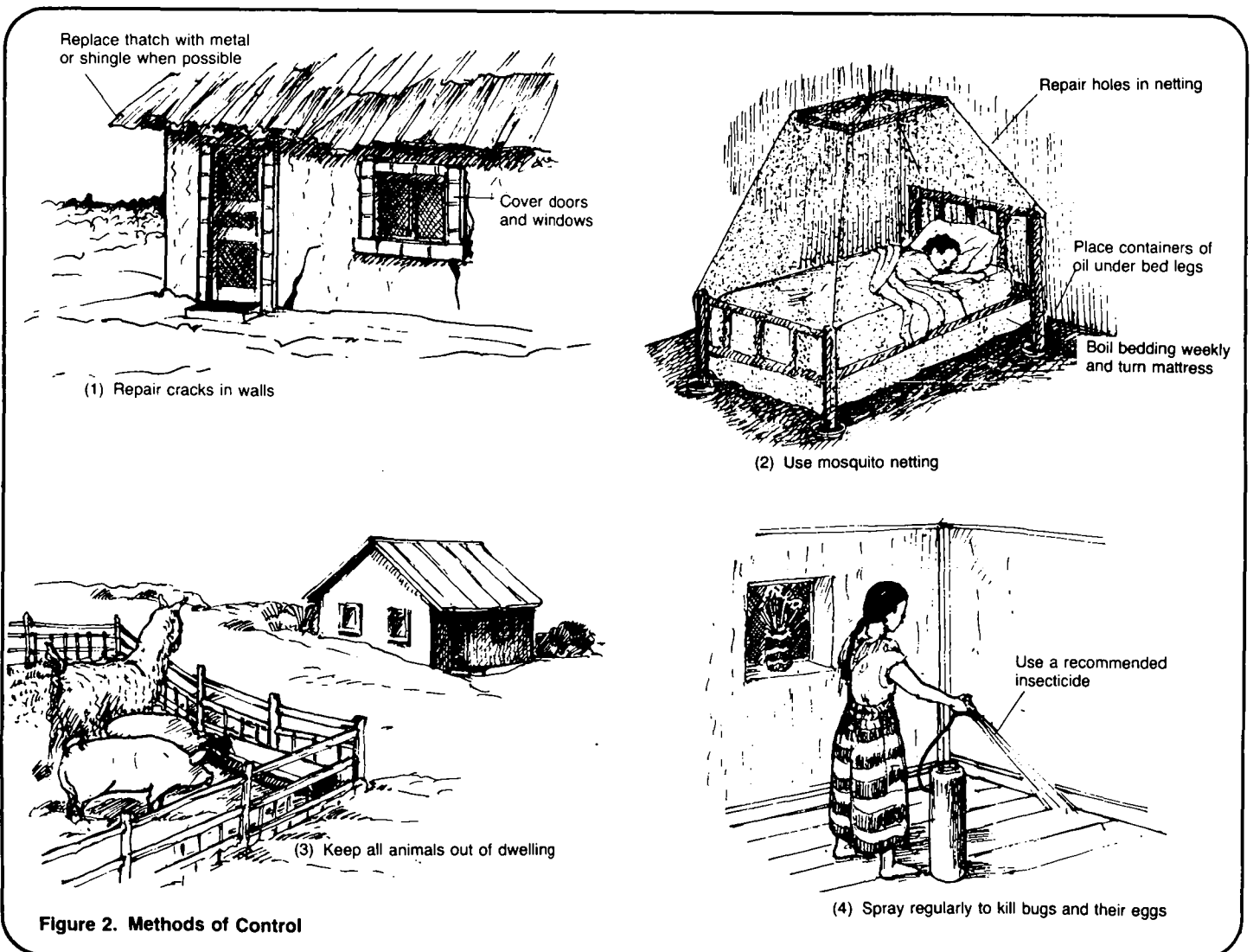
- Do not let animals into the house; especially do not let pigs, dogs, cats or other mammals sleep in the house at night.

- Build animal pens for pigs, rabbits or guinea pigs far from the house.

- Repair walls in houses. Fill in the cracks in houses and repair roofs and doors to eliminate bug hiding and breeding places. Vinchugas live in thatched roofs and, if possible the thatch should be replaced with other roofing material.

- Sweep floors, clean under the bed, pick up belongings from the floor. All these practices eliminate bug hiding and breeding areas.

- Turn over the mattress on the bed weekly. If there are vinchugas under the mattress, use insecticides to kill the bugs and air the mattress outside. Boil bed clothes to kill any eggs. In any case, mattresses should be aired monthly.



- At night, use mosquito netting so that the bugs cannot bite people. Mosquito netting is especially important for small children. Make sure that the netting is in good repair. Vinchugas can pass through large holes in netting.

- Spray houses with insecticide to kill bugs and eggs. Check with local health officials about the type of insecticides that should be used to control vinchuga. Use insecticides that are safe for people and domestic animals. Figure 2 shows these methods of control.

Most of the measures mentioned above are family or individually oriented and will work effectively to decrease chances of being bitten by an infected vinchuga. However, community-wide and national programs should be implemented to fight the spread of the disease. The development of a program to elimi-

nate Chagas should be a national concern. One method would be to develop regional teams to spray against vinchuga. In many countries, an agency or part of an agency is or has been in existence to spray against malaria. This same group can be re-instituted or expanded to spray against Chagas.

Another important activity is health education. People must be educated and made aware of the problem. Education should stress:

- Recognition of the vinchuga bug. Adults as well as children should see the bugs and be taught to recognize one.

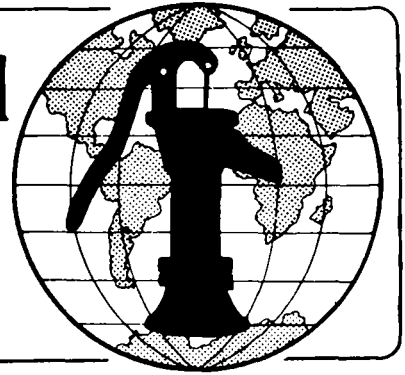
- Realization of the seriousness of the disease and the need to take action against it.

- Methods for controlling the spread of the disease so action can be taken.

## Notes

**Technical Notes** are part of a set of "Water for the World" materials produced under contract to the U.S. Agency for International Development by National Demonstration Water Project, Institute for Rural Water, and National Environmental Health Association. Artwork was done by Redwing Art Service. Technical Notes are intended to provide assistance to a broad range of people with field responsibility for village water supply and sanitation projects in the developing nations. For more detail on the purpose, organization and suggestions for use of Technical Notes, see the introductory Note in the series, titled "Using 'Water for the World' Technical Notes." Other parts of the "Water for the World" series include a comprehensive Program Manual and several Policy Perspectives. Further information on these materials may be obtained from the Development Information Center, Agency for International Development, Washington, D.C., 20523, U.S.A.

# Water for the World



## Methods of Controlling Enteric Diseases

Technical Note No. DIS. 2.M.4

Enteric diseases are those that affect the gastrointestinal tract of humans. They are caused by bacteria, parasites or viruses. The disease organisms are passed from infected people in their feces or urine. Others become infected when they take in the disease causing agents by eating soiled food or by drinking water contaminated with fecal matter. Enteric diseases are common throughout the world and, in most areas, some part of the population is always infected.

This technical note discusses measures which can be instituted to control the spread of enteric diseases. Special emphasis is given to basic preventive measures that should be taken to provide hygienic conditions in individual households and in the entire community.

### Useful Definitions

**DEHYDRATION** - A condition in which the body loses more liquid than it takes in.

**FECES** - The waste from the body, moved out through the bowels.

**PARASITE** - Worms, insects or mites which live in or on animals or people.

**STOOL** - Human excrement, or a single bowel movement.

**VIRUS** - Germs smaller than bacteria which cause some infectious (easily spread) diseases.

### Disease Transmission

The transmission of enteric diseases is by the fecal-oral route. The bacteria, parasites or viruses (germs) pass from the body of an infected person in excreta. The germs later enter the body of an uninfected person through the mouth. There are two main ways that germs can enter an uninfected person or re-enter the same person:

- Through the water that people drink. In many situations, water supplies are contaminated by enteric disease germs. If a person drinks fecally contaminated water, he is likely to suffer from an enteric disease.

- Through the consumption of food. Food can be contaminated by dirty hands or raw infected water, or by being exposed to fecally contaminated organic fertilizer or garden soil. Vegetables thus contaminated would only be safe to eat after being cooked or sterilized. Flies can carry germs to food. Flies that light on and taste food can inoculate food with germs that are consumed with the food.

Table 1 lists the principal enteric diseases and their routes of transmission. Diarrhea is a major symptom of all enteric disease. Many types of germs can grow on food if it is not refrigerated. Cholera and typhoid fever are dangerous to people of all ages. Cholera is an especially dangerous enteric disease. Among children, enteric diseases are a major cause of high mortality. Diarrhea is the leading killer of small children in most developing countries. It kills by dehydration.

### Controlling Enteric Diseases

The control of enteric diseases involves three important interrelated activities: a health education program, a safe water and sanitation program, and home treatment of patients. These three activities should be implemented simultaneously and continuously.

### Health Education

Most enteric diseases result from poor sanitation and a lack of safe (good quality) water in the community. Effective health education is necessary to help people understand the connection between improved hygiene and

**Table 1. Principle Enteric Diseases and Their Common Transmission Routes**

Diseases	Causative organisms	Common transmission route
Cholera	Vibrio cholerae, including biotype El Tor	Man - feces - water and food - man
Typhoid fever	Salmonella typhi	Man - feces - food and water - man
Paratyphoid fevers	Salmonella paratyphi: A, B, C,	Man - feces - food and water - man
Bacillary dysentery	Shigellae	Man - feces ( <u>flies</u> ) food (water) - man
Amoebic dysentery	Entamoeba histolytica	Man - feces ( <u>flies</u> ) food (water) - man
Infectious hepatitis	Hepatitis virus A	Man - feces - water and food - man
Diarrheal diseases	Shigellae, salmonellae, Escherichia coli, parasites, viruses	Man - feces ( <u>flies</u> ) food (water) - man

improved health. Health education aimed at eliminating the enteric disease should include the following:

- Formation of a community sanitation committee to coordinate the various activities and work needed to attack the problem.
- Participation of community groups. Teachers should be trained in the basics of disease transmission and prevention so that they can teach their students. Community groups, 4-H clubs, women's groups, other clubs, and the like should be active in health education.

● Development of audio-visual materials. Films, puppets, slides, songs, flashcards, and other methods can be used to make the problem and its solution clear to the members of the community. Students and clubs should be taught how to prepare their own audio-visual materials for demonstration.

- Implementation of specific education programs in clinics and hospitals.

Health education should start people thinking about the problem and create a desire to change their behavior to solve the problem. When people recognize the need to use a latrine and wash their hands, and understand the ways in which water is contaminated and

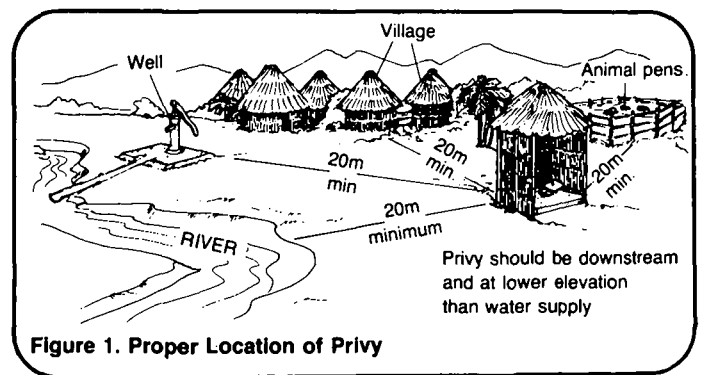
the role of flies and other vectors in the spread of disease, they will be more willing to do something to change the situation.

### Preventive Measures

Several measures can be taken to either remove sources of disease transmission or to prevent the sources from ever existing.

#### Latrines

- Build latrines at least 15m from any water supply or household. Be sure to site latrines so that they are downhill from any water source. Do not excavate pits into the water table. See Figure 1.

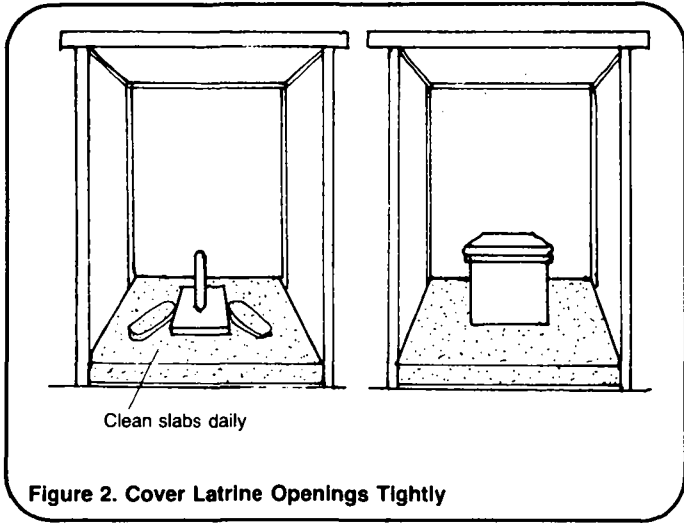


**Figure 1. Proper Location of Privy**

- Make sure that all latrines are sanitary. Ideally, the latrine should have a concrete floor. When not in use, the hole through the floor should



be covered. Uncovered latrines permit the breeding of flies which can carry disease agents from feces to food. See Figure 2.



● Accustom people to use latrines. One of the biggest problems is getting young children to use a latrine. Parents may use it but allow their children to defecate on the ground. Latrine openings should be sized so that children do not fear falling in. For more information on latrine design and construction, read the appropriate technical notes on sanitation. See "How to Use Technical Notes," HR.G, for a full list of technical notes. If latrines are not used, water sources can easily be contaminated by surface run-off.

## Water Supply

● Provide for a safe supply of water for the community. Read the appropriate technical notes on rural water supply. Protect all wells from the entrance of surface run-off. A well-head and a pump should be installed in order to prevent contamination from entering the wells.

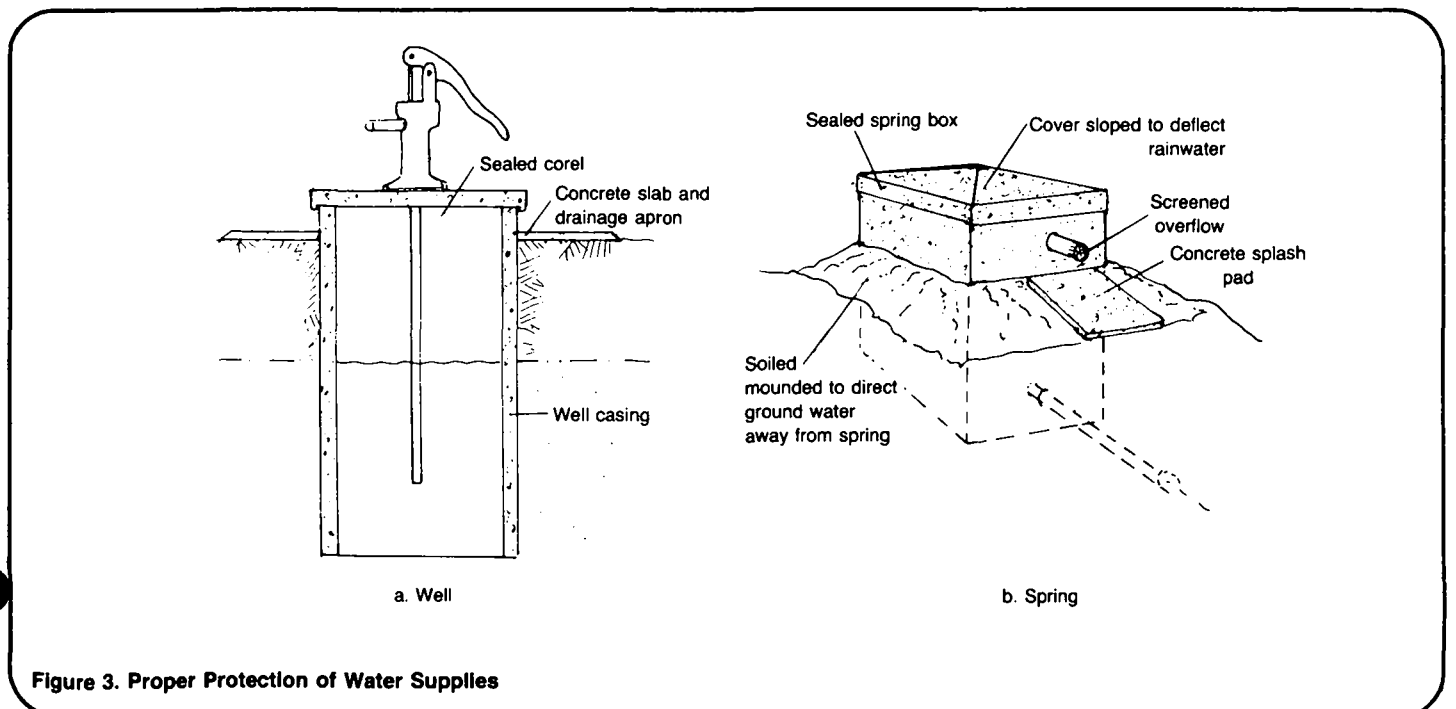
● Cap springs to prevent their contamination from surface run-off. See Figure 3.

● Where wells and springs are not protected or where surface water sources are used, water should be treated. Individual or community treatment should be used depending on the situation. Boiling and chlorination are the most common methods. For information on water treatment methods, see "Methods of Water Treatment," RWS.3.M.

## Hygiene

Personal and household cleanliness is important for preserving health. The following practices are essential for controlling the spread of enteric diseases. Figure 4 shows some of these practices.

● Always wash hands with soap and water before eating and after using the latrine.



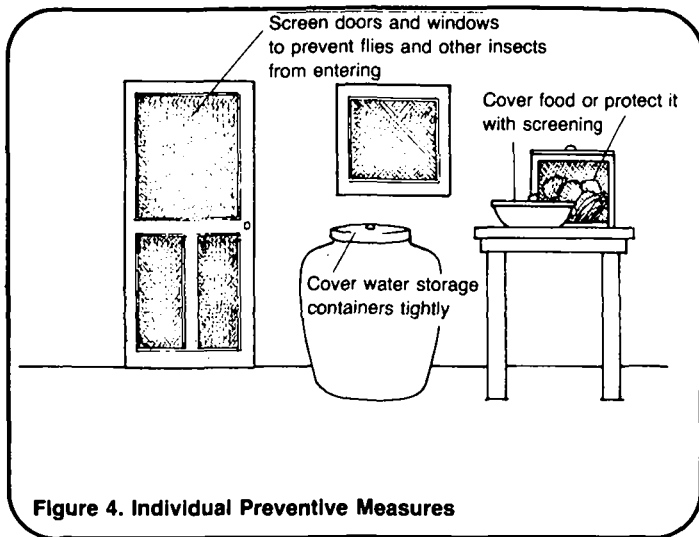


Figure 4. Individual Preventive Measures

- Require that food handlers are trained in personal hygiene and are aware of the need to store and cook food correctly.

- Dispose of all garbage properly. Make sure that garbage does not accumulate in such a way that flies can breed in it.

- Eat well. Diseases such as dysentery are more dangerous to people suffering from malnutrition.

### Treatment Measures

At the same time that health education and preventive measures are being implemented, measures to treat patients with enteric diseases should be adopted. When diarrhea is present, liquid and salt are rapidly lost and must be restored to the body. Many children die from diarrhea or dysentery when they do not have enough water in their bodies. Persistently and frequently give liquids to a person with diarrhea. In severe cases in children, rehydration liquid should be given. Preparation of a rehydration drink: to a liter of boiled water, add two table-spoons of sugar, one-quarter teaspoon of salt, and one-quarter teaspoon of baking soda. Give the dehydrated person sips of this drink every five minutes, day and night, until he begins to urinate normally. An adult needs at

- Wash fruits and vegetables before eating them. Be sure to scrub those vegetables which grow in ground that may be infected.

- Do not allow animals to enter the house.

- Store food in screened areas or in refrigerators and cover food with netting. These measures will keep flies away from food and help prevent the spread of disease.

- Keep the house clean by sweeping it daily.

Table 2. Foods for a Person with Diarrhea

When the person is vomiting or feels too sick to eat, he should drink:	As soon as the person is able to eat, in addition to giving the drinks listed at the left, he should eat a balanced selection of the following foods or similar ones:	
teas	energy foods	body-building foods
ice water	ripe or cooked bananas	milk (sometimes this causes problems)
chicken, meat, egg, or bean broth	crackers	chicken (boiled or roasted)
Kool-Aid or similar sweetened drinks	rice	eggs (boiled)
REHYDRATION DRINK	oatmeal or other well-cooked grain	meat, well cooked, without fat or grease
Breast milk	fresh maize (well cooked and mashed)	beans, lentils, or peas (well cooked and mashed)
	potatoes	fish (well cooked)
	applesauce (cooked)	
	papaya	
DO NOT EAT OR DRINK		
fatty or greasy foods	beans cooked in fat	alcoholic drinks
acidic raw fruits	highly seasoned food	any kind of laxative or purge

least 3 liters of water each day while a child needs 1 liter. Table 2 lists foods that should and should not be eaten by a person with diarrhea.

Where diarrhea is very severe and looks like it will not stop, keep giving liquids to the patient and seek medical help immediately. Seek medical help when:

- Diarrhea lasts more than four days and is not getting better or more than one day in a small child with severe diarrhea.

- A person is dehydrated and getting worse.

- A child vomits everything it drinks.

- The child begins to have fits or its feet and face swell.

- The person was sick or malnourished before the diarrhea began.

- There is blood in the stool.

Under these conditions, a more serious enteric disease may be present in the system and some type of drug treatment will be necessary.

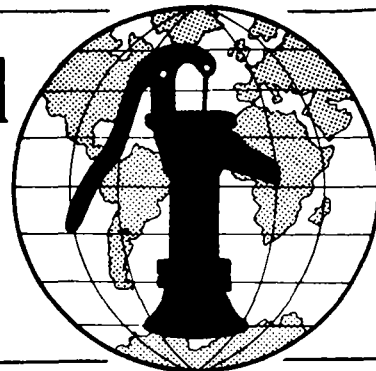
## Notes

## Notes

## Notes

**Technical Notes** are part of a set of "Water for the World" materials produced under contract to the U.S. Agency for International Development by National Demonstration Water Project, Institute for Rural Water, and National Environmental Health Association. Artwork was done by Redwing Art Service. Technical Notes are intended to provide assistance to a broad range of people with field responsibility for village water supply and sanitation projects in the developing nations. For more detail on the purpose, organization and suggestions for use of Technical Notes, see the introductory Note in the series, titled "Using 'Water for the World' Technical Notes." Other parts of the "Water for the World" series include a comprehensive Program Manual and several Policy Perspectives. Further information on these materials may be obtained from the Development Information Center, Agency for International Development, Washington, D.C., 20523, U.S.A.

# Water for the World



## Methods of Controlling Onchocerciasis Technical Note No. DIS. 2.M.5

Onchocerciasis, commonly known as river blindness, is a disease that affects many people in Africa and South America. It can cause a series of eye ailments which can lead to blindness. Among people living in areas where river blindness is present, large numbers have lost their sight.

This technical note discusses the chain of transmission and suggests several ways to combat the spread of the disease. Generally, the most effective methods of control involve the use of chemicals.

### Disease Transmission

Onchocerciasis is common in areas where specific types of blackflies (genus simulium) breed. Usually the best breeding grounds are fast-flowing rivers and streams. The blackfly spreads the disease in the following manner. See Figure 1 for the transmission chain.

- The blackfly bites a person who is infected with onchocerciasis.

- The larvae of the parasite are taken from the skin of the person and pass with the tissue juices into the blackfly.

- In the fly, the larvae become infective in about six to ten days. When the fly bites again the larvae pass from the fly into the person.

- Lumps form under the skin. These nodules contain adult round worms which produce large numbers of larvae that live in the skin waiting to be sucked up by a blackfly.

### Useful Definitions

**LARVAE** - Young forms that come from the eggs of insects and worm parasites.

**NODULE** - A small round swelling or lump.

**SPILLWAY** - A channel built to control the level of water in a dam reservoir; flood water is drained from a dam through spillways.

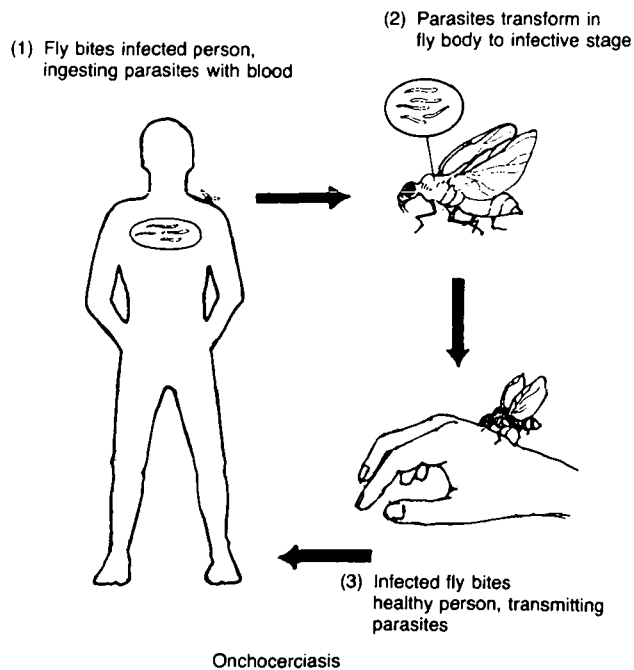


Figure 1. Transmission of Water-Related (Insect carried) Diseases

Of millions of larvae, only a few are taken in by blackflies. The rest wander through the host's tissues until they die in the human body. The body tries to fight the effects of the dead larvae by building scar tissue around them. These scars form in the body. Many larvae die in the lens and other parts of the eye. Eventually, the lens becomes so full of scar tissue that the person becomes blind.

The nodules containing the adult worms are not always easy to detect because they may be deep in the body. Generally the presence of nodules, patches on the skin and itchiness are symptoms of onchocerciasis.

## Control of Onchocerciasis

Control of the disease is focused on the control of the blackfly population through environmental and chemical means. Treatment is not very effective since sometimes the disease is difficult to detect. However, early treatment that kills the adult worms will help prevent blindness. The following control measures are recommended for fighting the spread of onchocerciasis.

Environmental Control. Environmental control of onchocerciasis involves eliminating the breeding sites of the blackflies. However, it is very difficult to control the disease just by environmental means. Some measures that are useful are also expensive and will be beyond the means of most rural people. Environmental measures that can be used to control onchocerciasis should be included in development projects. For example:

- Because most species of blackflies, particularly in Latin America, require fast-flowing water in which to breed, changing the stream flow can greatly help to reduce the numbers of blackflies. To eliminate the breeding places of blackflies upstream, a dam can be built. The backed-up water floods the fast-water breeding grounds.

- The design of dam spillways so that new breeding places are not created in them is not easy. Professional help should be sought in such design from specialists with experience in controlling blackfly

breeding. Do not build spillways in a series of steps because this design will only increase the reproduction of the flies, and succeed in moving the breeding place from one point to another.

- Build covered canals when developing an irrigation project. Covered canals are expensive and, in most cases, existing canals cannot be covered. When designing new systems, engineers should consider the added cost of covering in order to control blackfly breeding.

- Remove brush from the edges of fast-flowing rivers and streams.

Generally, little environmental control can be carried out where structures are already in place. Changing dams or canal design is economically impossible. Only where new projects are in the design stage can effective measures be included in a project. Where new communities are being proposed, an attempt should be made to locate them away from areas where blackflies breed. To more effectively fight the spread of onchocerciasis, a good program of chemical control should be established.

Chemical Control. By placing chemicals into breeding water, large numbers of blackflies can be destroyed. The larva stage of blackfly development is the time when control is effective. Chemicals kill blackfly larvae before they can mature.

Chemicals kill the larvae in three ways:

- The larvae eat the chemicals and are poisoned.

- The chemicals kill the larvae through contact.

- The larvae starve or smother when the chemical forces them to move away from their habitat.

Several chemicals are available for use in controlling blackfly populations. DDT has been used but because of the danger it presents to fish and animals, its use has been limited. Other effective, less dangerous chemicals are available.



Abate is the most commonly used chemical for blackfly control. Generally, it is applied to streams or other bodies of water where blackflies are known to breed using an airplane or helicopter. Methoxychlor is less commonly used than Abate because it is less powerful and a less effective killer. Methoxychlor is much less expensive than Abate and for that reason is often used. Both chemicals appear to be safer than DDT but both of them affect fish.

The choice of a chemical will depend on availability and price. Chemicals can be applied by pouring them directly into the water or by constructing a drop applicator as shown in Figure 2.

The chemicals are lighter than water and float at the top where blackfly larvae live. This also protects fish and plants that generally live below water. Where rivers have a continuous rate of flow over long stretches, single doses at a specific point can be applied. If the river has rapids and pools, the chemical will have to be applied at the headwaters of each set of rapids.

## Treatment and Education

Where onchocerciasis is suspected, a medical skin test is necessary to determine its presence. Also, the disease can be detected with an eye examination.

When the nodules appear on the body, they can be removed by surgery. Early removal lowers the number of worms in the body. However, when the nodules are inside the body and not easily detected, this measure is not useful. Removal of nodules from all people with the disease would be very time-consuming and virtually impossible.

Another possibility is to use drugs to treat people with the disease. There are drugs which kill the larval parasites in the body and drugs that kill the adult worm. No drug does both. The problem with drug use is:

- Drugs have severe side effects.
- Drug treatment can only stop the symptoms and prevent further damage.
- Drug treatment is expensive and not practical over large areas.

To control river blindness, it is very important to eliminate breeding places. People should be taught about the disease and how it is spread. Once an awareness of the disease is created, people will be more interested in cooperating in blackfly control programs. Community members should participate in and take responsibility for spraying programs and brush clearing. Instruct people in the importance of using netting when sleeping outdoors, especially during the daytime when the flies bite. Above all, help people to recognize the symptoms of the disease so that they can get medical help quickly.

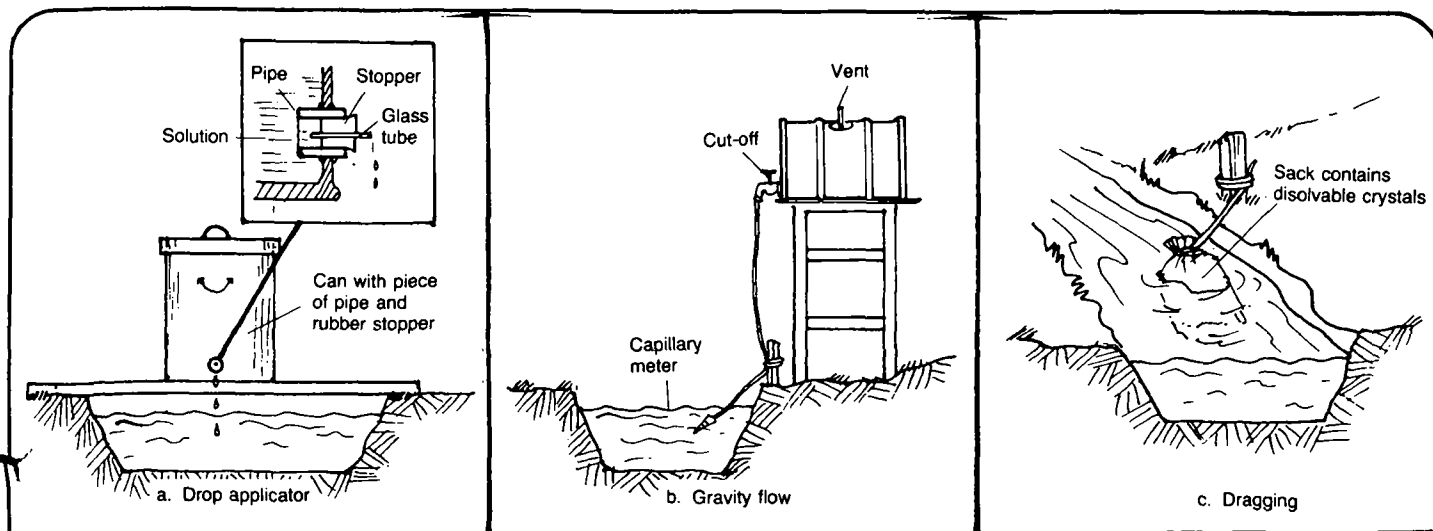


Figure 2. Means of Applying Chemicals to Irrigation Ditches or Streams

## Notes

**Technical Notes** are part of a set of "Water for the World" materials produced under contract to the U.S. Agency for International Development by National Demonstration Water Project, Institute for Rural Water, and National Environmental Health Association. Artwork was done by Redwing Art Service. Technical Notes are intended to provide assistance to a broad range of people with field responsibility for village water supply and sanitation projects in the developing nations. For more detail on the purpose, organization and suggestions for use of Technical Notes, see the introductory Note in the series, titled "Using 'Water for the World' Technical Notes." Other parts of the "Water for the World" series include a comprehensive Program Manual and several Policy Perspectives. Further information on these materials may be obtained from the Development Information Center, Agency for International Development, Washington, D.C., 20523, U.S.A.