

321.4
83RU



321.4-874

TAG TECHNICAL NOTE NUMBER 8

Rural Ventilated Improved Pit Latrines: A Field Manual for Botswana

John van Nostrand and James G. Wilson

KD 4732



A joint contribution of the Government of Botswana, the United Nations Development Programme and The World Bank to the International Drinking Water Supply and Sanitation Decade.

NOVEMBER 1983

4732 WH 874
321.4 83RU

Copyright © 1983
International Bank for Reconstruction and Development/
The World Bank, 1818 H Street, N.W.,
Washington, DC 20433, U.S.A.

Preface

This paper is one of a series of informal Technical Notes prepared by TAG¹ on various aspects of water supply and sanitation programmes in developing countries. These papers were originally prepared as internal discussion documents; their wider distribution does not imply endorsement by the sector agencies, government, or donor agencies concerned with the programmes, nor by The World Bank or the United Nations Development Programme. Comments and suggestions on the papers should be addressed to the Project Manager, UNDP Project INT/81/047, Water Supply and Urban Development Department, The World Bank, 1818 H Street, N.W., Washington, D.C., 20433, U.S.A.

Richard N. Middleton
Project Manager

Summary

This field manual has been specifically prepared for Village Sanitation Assistants (VSAs) and village householders who, as part of Botswana's national rural sanitation programme, are working together in the construction of rural ventilated improved pit (BOTVIP) latrines. The manual sets out overall design principles, several optional designs, current construction procedures and some maintenance guidelines. It contains an extensive number of construction illustrations and technical drawings. This manual will be translated into Setswana by the Department of Non-Formal Education at the Ministry of Education in Gaborone, Botswana.

Acknowledgements

The authors wish to acknowledge, with thanks, the advice and assistance they received from Botswana's Ministry of Local Government and Lands, Kgatleng and Southern District Councils, and members of the Environmental Sanitation and Protection Project (ESPP) team.

¹TAG: Technical Advisory Group established under the United Nations Development Programme Global Project GLO/78/006 (renumbered on January 1, 1982; now UNDP Interregional Project INT/81/047, "Development and Implementation of Low-Cost Sanitation Investment Projects"), executed by The World Bank.

Contents

1. Introduction	5
2. Design Principles	7
3. Constructing the Substructure	11
A. Preparing to Construct the Substructure	12
B. Unlined Rectangular Substructure Built in Stable Soils (BOTVIP A)	14
C. Lined Circular Substructures Built in Unstable Soils (BOTVIP B)	18
(i) Circular Substructure with Masonry Lining	18
(ii) Circular Substructure with Wire-Mesh Lining	22
4. Constructing the Superstructure	26
A. Preparing to Construct the Superstructure	27
B. Rectangular Superstructure	30
C. Circular Superstructure	36
5. Monitoring and Maintaining the BOTVIP Latrine	42
Appendices	
I BOTVIP A1: Rectangular Superstructure on Rectangular Substructure: Plan and Section	49
II BOTVIP A2: Circular Superstructure on Rectangular Substructure: Plan	51
III BOTVIP B1: Rectangular Superstructure on Circular Substructure: Plan	52
IV BOTVIP B2: Circular Superstructure on Circular Substructure: Plan and Section	53

V	Circular Substructure/Trapezoidal Block Lining: Plan and Section	55
VI	Circular Substructure/Wire-Mesh-and-Filter-Fabric Lining: Plan and Section	56
VII	Typical Rectangular Coverslabs: Plans and Section	57
VIII	Typical Circular Coverslab: Plan and Section	59
IX	Seat Insert: Plan and Section	60
X	Cement-Wash Hessian Ventpipe: Plan and Section	61

Photograph: John van Nostrand

1. Introduction

Botswana's current rural sanitation programme was launched with the Environmental Sanitation and Protection Project (ESPP) which was introduced in Kgatleng and Southern Districts between 1980 and 1982. During this period, over 250 ventilated improved pit (BOTVIP) latrines were completed in six outlying pilot villages. At the outset of this project, prototype latrines were erected at central locations within each village. Following ratification of at least one of the designs by the Village Development Committee, householders were responsible for constructing their own latrines, working in close collaboration with appointed and trained Village Sanitation Assistants (VSAs).

Since 1982, Botswana's rural sanitation programme has been expanded across the country on a District-by-District basis, under the direction of the Senior Public Health Engineer in the Ministry of Local Government and Lands in Gaborone. Additional programmes have been introduced in villages in Kweneng, Kgatleng, Southern, and

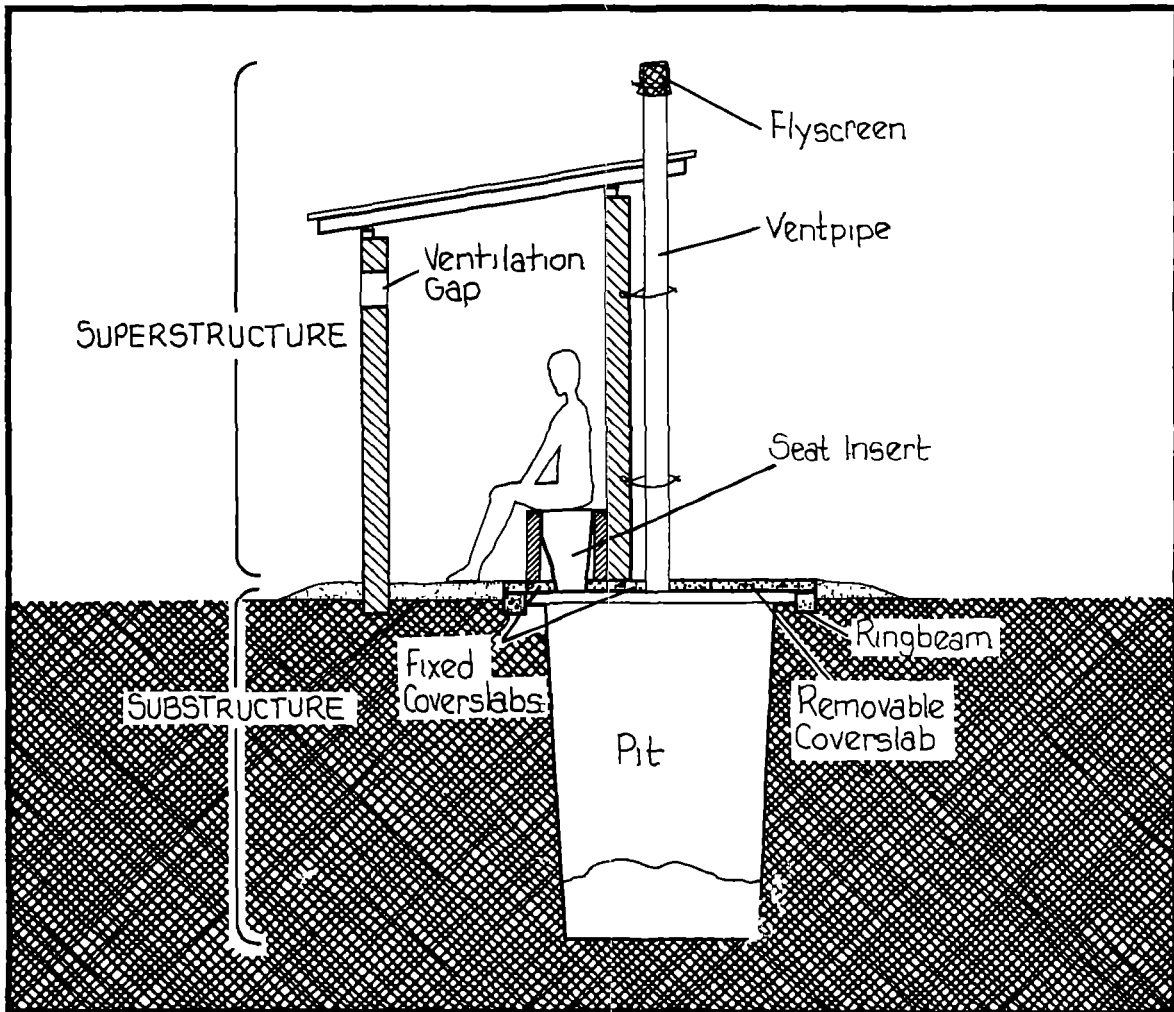

The BOTVIP Latrine

Ngamiland Districts under the direction of their respective District Sanitation Coordinators. At the village level, latrine construction programmes are directed by Village Sanitation Coordinators (VSCs). These programmes rely on self-help construction techniques and the use of local materials, thereby not only reducing costs but also encouraging continued construction of latrines in the six original Pilot Project villages, even after the termination of formal financial aid. Here, local VSAs continue to collaborate with individual householders in the construction of the actual latrines.

This manual has been prepared in anticipation of a gradual but steady increase in rural latrine construction in Botswana, in accordance with the Government's policy of expanding rural sanitation construction programmes as Districts become capable of carrying out the work. While it has been developed specifically for VSCs, VSAs and village householders, it will undoubtedly be of interest to other people involved in national and District rural sanitation programmes in Botswana and other comparable countries. The manual focuses on substructure and superstructure designs which were originally introduced and tested in the ESPP Pilot Project. These include lined and unlined, rectangular and circular, substructures, as well as alternative superstructures which combine traditional and contemporary building techniques and materials. The choice of particular designs will vary according to existing soil conditions, affordability and the types of materials which are available locally. It is likely that, as the programme expands, additional latrine designs will be developed which will prove to be equally acceptable. These will need to be incorporated into the manual once they have been tested in the field.

2. Design Principles

The latrine designs which are presented in this manual are referred to as “Botswana ventilated improved pit (BOTVIP)” latrines. BOTVIP latrines are a low-cost, hygienic, and relatively sophisticated form of sanitation. Because they are derived from traditional latrines, they are familiar to many people throughout Botswana. However, while they are similar to traditional latrines in some ways, important improvements have been made, based on some fundamental design principles. It is important that both the builders and the users of the BOTVIP latrines have a clear understanding of these principles in order to ensure that the latrines are correctly constructed and maintained so that they last as long as possible. Any person wishing to revise or improve on these designs in the future will need to ensure that any changes meet with these design principles.

Principle 1: Long Life

The major advantage of the BOTVIP latrine over traditional rural pit latrines is that it lasts for a longer time. First, the latrine superstructure is offset from the substructure so that most of its weight rests on undisturbed soil. This improves the BOTVIP’s stability and greatly reduces the possibility of collapse. Second, the pit is protected by a perimeter ringbeam which prevents erosion, particularly from rainwater. Third, the pit may be lined in unstable soil conditions. This further increases the life of the pit and facilitates its maintenance. Fourth, the BOTVIP is a dry latrine. In other words, it is not designed to receive any liquids other than urine and small amounts of water (used to clean the seat). This water either seeps away through the lining or pit walls into the subsoil, or it evaporates. Collectively, these design principles ensure that the BOTVIP latrine lasts for a much longer time than traditional rural pit latrines.

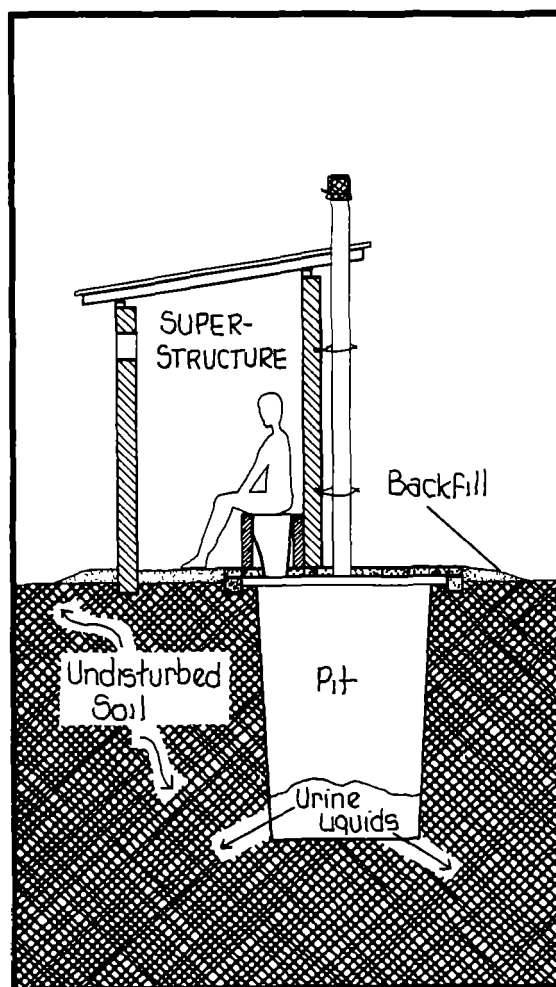

The BOTVIP Latrine

Principle 2: Ventilation and Insect Control

Traditionally designed pit latrines not only are prone to collapse but also have two other main disadvantages — they smell, and they give rise to serious insect problems. Both these disadvantages are substantially reduced in the BOTVIP latrine by the fact that the offsetting of the superstructure also permits the installation of a ventpipe. The ventpipe serves a dual purpose. First, it carries foul air out of the pit and away from the superstructure. This occurs mainly because wind blowing across the top of the ventpipe sucks foul air out of the pit. Ventilation also occurs on still days when the sun heats the air in the ventpipe, causing it to rise. Second, the ventpipe serves as an insect trap. Flies and other insects will only fly into the light. As a result, provided the superstructure is kept reasonably dark, insects will travel out of the dark pit up the ventpipe. However, when they get to the top of the ventpipe, they are trapped by the flyscreen, and they eventually die and fall back into the pit. The flyscreen also keeps insects from entering the pit through the ventpipe.

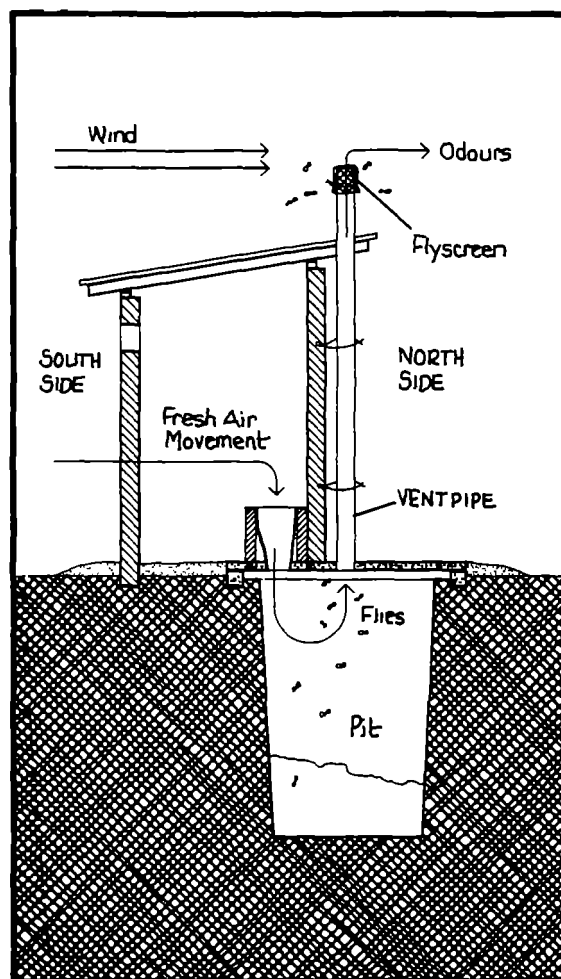

How the Ventpipe Works*

*Throughout this manual, the ventpipe is shown on the north side of the latrine superstructure. In Botswana, which is south of the Equator, this ensures maximum exposure to sunlight and, thus, maximum ventilation flow. In countries north of the Equator, the ventpipe should be located on the *south* side of the superstructure.

Principle 3: Improved Safety

The rural BOTVIP latrine is perceived by its users to be more stable and safer than traditional designs. First, users are not worried that the substructure will collapse. Second, parents consider it safe for their children. Since it has been established that people in Botswana prefer to sit rather than squat, a glass-fibre reinforced plastic (grp) seat insert is used. This seat insert is tapered, with the upper opening large enough to minimize fouling of the bowl (this cuts down on the amount of water needed to keep the bowl clean), and the lower opening small enough to relieve parents' fears that their babies or young children might fall through into the pit. Thus, the rural BOTVIP latrine is designed to be used by all age groups.

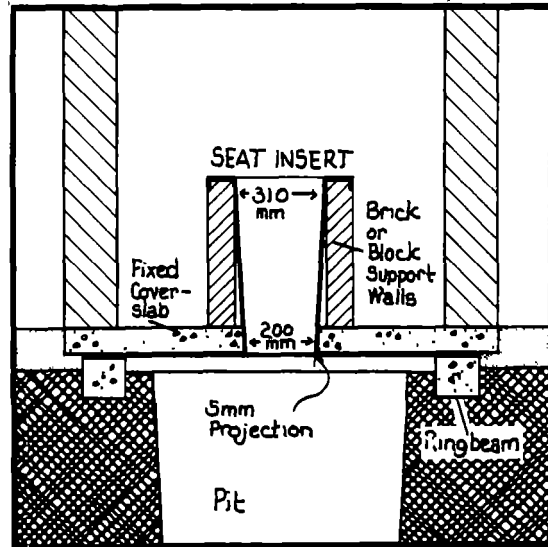

The BOTVIP Seat

Principle 4: Self-Help Construction

Responsibility for the construction of rural latrines lies with the village householder, who is assisted by a local Village Sanitation Assistant (VSA). Rural latrine designs seek to combine the use of contemporary and traditional building materials and techniques which will be familiar to both parties. Thus, these designs encourage self-help building practices which not only reduce costs and construction time but also encourage more people to use these improved sanitation facilities.

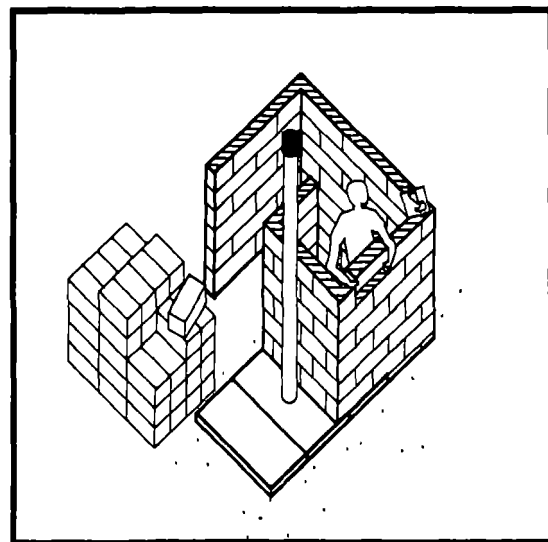

Constructing the Superstructure

Principle 5: Improved Maintenance

Most of the rural BOTVIP latrine designs provide removable coverslabs to the pit. These enable the pit to be maintained, repaired or, where a vacuum tanker truck is available, emptied. It is critical that, after the coverslabs have been replaced, an airtight seal is reestablished between them and the top of the ringbeam or lining walls. Most rural householders will relocate their latrine when it is full, and the BOTVIP components may be reused in a new location.

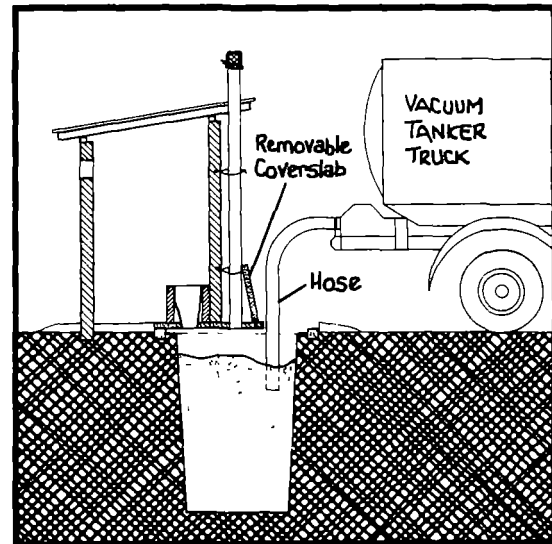

Emptying the Pit in Major Villages

3. Constructing the Substructure

This section presents a step-by-step outline of the methods used in constructing three alternative BOTVIP latrine substructures. The first pit is rectangular and unlined and is suitable for use in stable soils, such as heavy clay and rock, which are found where the majority of people live. The other two substructures are circular and lined for use in unstable soils, such as sand, sandy clay or loose clay, which are found in various locations throughout Botswana. The decision as to whether or not the pits in a particular location need to be lined should be made by the District Sanitation Planning Committee, using technical site information supplied by the Departments of Geological Survey and Water Affairs. The selected designs should also be ratified by the local Village Development Committee and the Village Sanitation Coordinator.

Most rural BOTVIP latrines are constructed by village householders working in close collaboration with a local Village Sanitation Assistant (VSA). Quality and efficiency of construction depends, to a large degree, on both parties having a clear idea of their respective roles and responsibilities.

The VSA is responsible for coordinating construction and sharing his expertise with the householder in order to ensure that the latrine is correctly constructed. If possible, the VSA should keep a written record of progress made on all plots during the construction period.

The householder is responsible for supplying labour, local building materials, and whatever tools he can. Failure by either party to complete his responsibilities on time can cause serious delays for the other and can undermine the village programme as a whole.

3A. Preparing to Construct the Substructure

Prior to the commencement of construction, both the VSA and the householder must ensure that they possess, or have access to, the necessary tools they will require to complete their particular tasks.

The Village Sanitation Assistant will need to carry:

- A notebook and a pen
- A copy of the design drawings
- Stakes and string
- A tape measure
- A mallet or hammer
- A spirit level
- A trowel
- Wire cutters
- A satchel or carrying bag

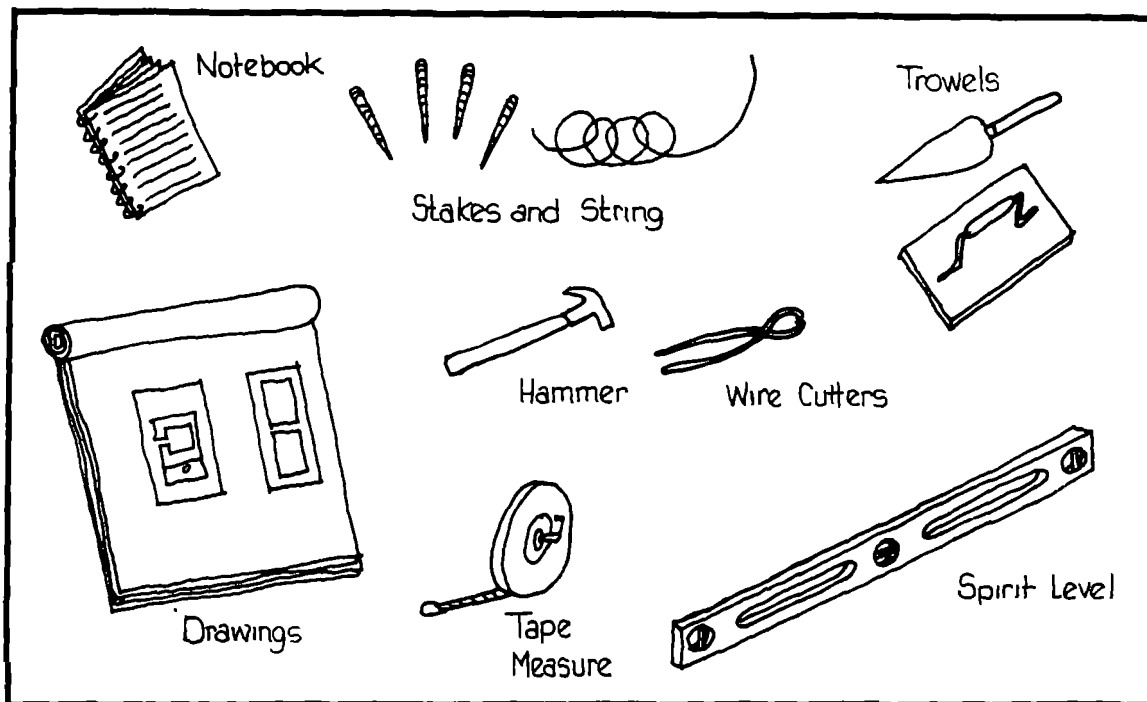

Village Sanitation Assistant's Equipment

The Householder should try to provide:

- A water bucket
- A wheelbarrow
- A spade
- A pick
- A block mould (suitable for making sand-cement blocks or mud bricks)

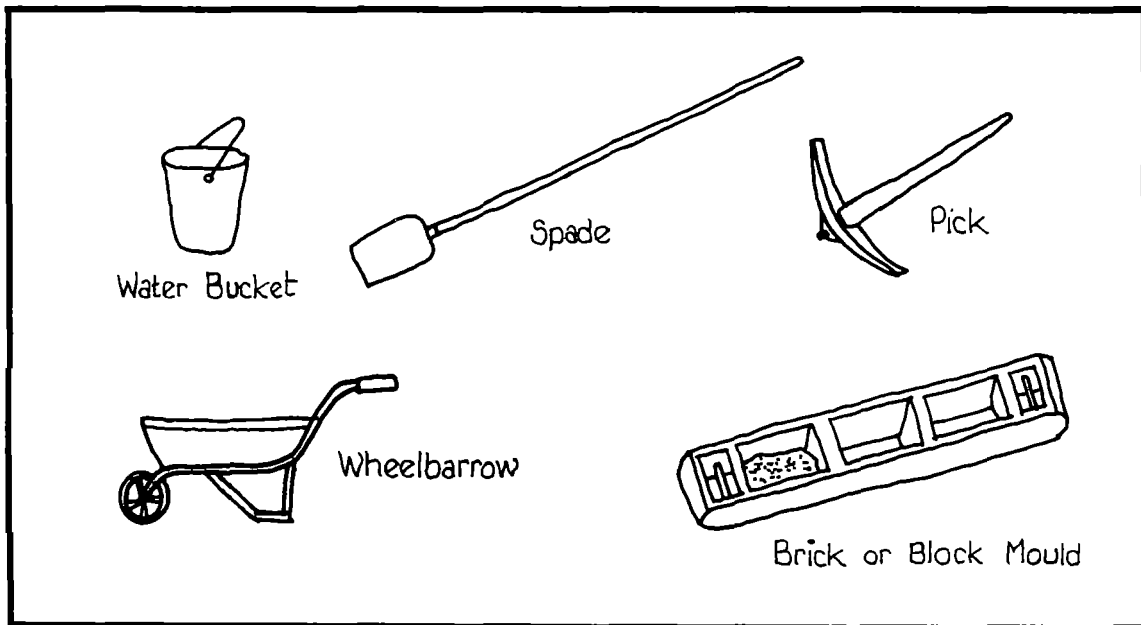

Village Householder's Equipment

In addition, the VSC will need to ensure that all necessary building components and materials have been, or will be, delivered to the site on time.

Depending on the latrine design, these may include the following:

- Cement, sand and stone
 - Trapezoidal lining blocks or wire-mesh-and-filter-fabric lining
 - Reinforcing bars or steel mesh
- (All of the above to be delivered to the village by the District Council)
- Coverslabs
(to be constructed off-site, under contract to the District Council, and delivered to site)
 - Plastic ventpipe (if this type is to be used)
 - Galvanized wire, hessian and flyscreen (for ventpipe)
(to be partially constructed off-site, under contract to the District Council, and delivered to site)

District Council tools and building materials should be stored in a locked temporary storage room centrally located in the village. The VSC should inspect all tools and materials before storage to ensure that everything is in good condition.

3B. Unlined Rectangular Substructure Built in Stable Soils (BOTVIP A)

This subsection describes an unlined rectangular (BOTVIP A) substructure which may be constructed in very stable soils such as rock, heavy clay or decomposed granite. The fact that a lining wall is not required obviously reduces the cost of the substructure. However, unlined pits should be constructed only in locations designated by the District Sanitation Planning Committee.

Step 1: Location, Orientation and Staking

The latrine substructure should be located by the householder, in close collaboration with the VSA. Generally speaking, the latrine should be located towards the rear of the plot. Where no door is to be provided on the superstructure, the entry should preferably not face east or west where the morning or evening sunlight can penetrate the interior of the substructure and so encourage insects to leave the pit through the latrine seat instead of up the ventpipe. It is also important to ensure that the entry will not be directly visible to either passersby or neighbouring plots. Preferably, the entry should face the house.

The latrine should be located at least 2 metres from existing trees or overhanging branches in order to maintain proper ventilation through the ventpipe. Ideally, the ventpipe should be located on the north side to ensure that it is heated by the sun on still days; this helps maintain proper ventilation.

Once the latrine has been correctly located and oriented, the VSA should stake out an area 1100 mm wide and 1800 mm long and run a string or ground-line between the stakes. Alternatively, a preconstructed rectangular wood frame or piece of canvas of these dimensions may be used for locating the stakes.

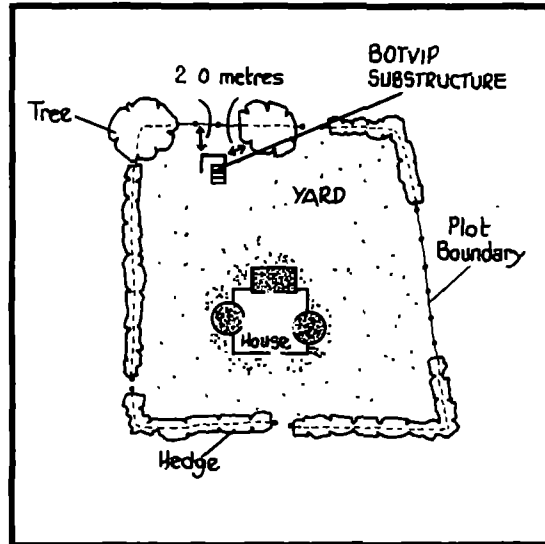

Locating the Rectangular Substructure

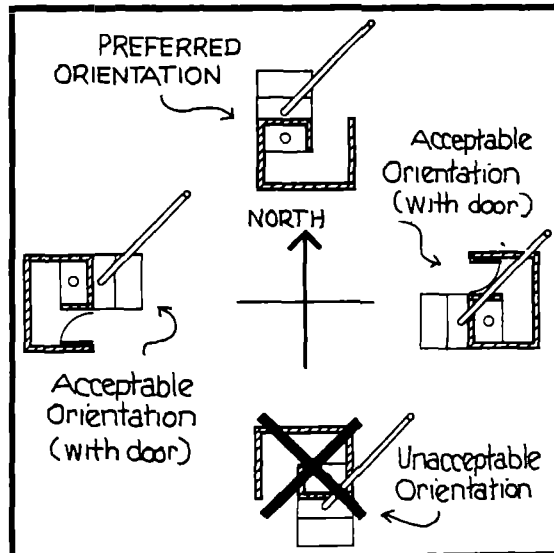

Orientation of Ventpipe

Note: Throughout this manual, the ventpipe is shown on the north side of the latrine superstructure. In Botswana, which is south of the Equator, this ensures maximum exposure to sunlight and so maximum ventilation flow. In countries north of the Equator, the ventpipe should be located on the south side of the superstructure.

Step 2: Ringbeam

After locating the substructure, the householder is responsible for excavating a shallow perimeter trench, 75 mm deep by 125 mm wide, inside the stakes, and fixing external wooden formwork 75 mm high around both sides in order to cast the ringbeam. The VSA, with assistance from the householder, then bends a 6-metre length of 8-mm reinforcing bar to the shape of the trench and fills the trench with concrete, placing the bar in the centre of the concrete.

In completing this operation, the VSA must ensure that:

1. The base of the trench is firm (if not, additional soil should be dug out until firm soil is reached).
2. The ringbeam is correctly aligned, dimensioned and squared.
3. The reinforcing bar is placed in the centre of the ringbeam.
4. The top of the ringbeam is 50 mm above natural ground level.
5. The concrete being used is mixed in the proportion of 1 cement to 2 sand to 4 stone (the water used should be clear, and the sand and stone free of clay and grass).
6. The concrete is well tamped, levelled, covered and kept moist (using, for example, wet hessian) for at least 3 days in order to allow it to cure properly.

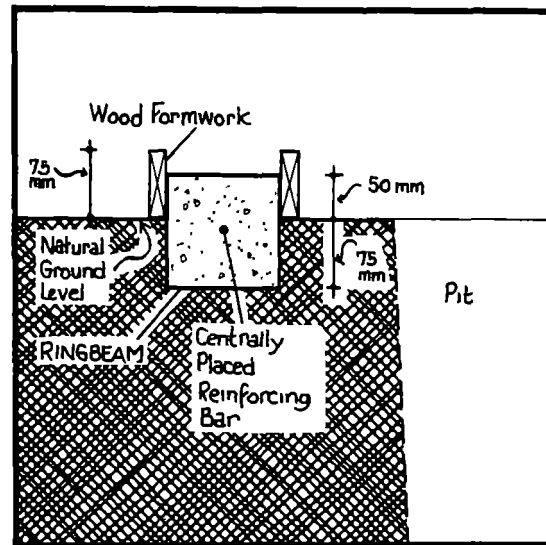

The Rectangular Ringbeam Showing Formwork

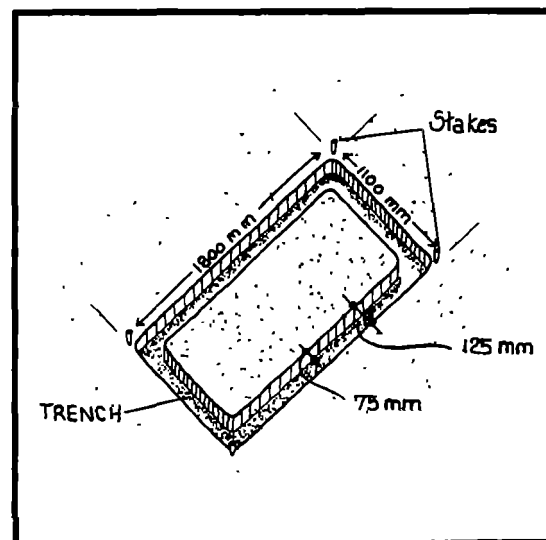

The Trench for the Ringbeam

Step 3: Excavation

After proper curing of the ringbeam, the householder is responsible for excavating a pit 600 mm wide by 1300 mm long, 125 mm *inside the ringbeam*. The walls of the pit should slope slightly (not more than 1 in 20) and the pit should be not less than 2 m deep.

In inspecting this operation, the VSA must ensure that:

1. The pit is properly located, 125 mm inside the ringbeam.
2. The dimension from top of ringbeam to bottom of pit is not less than 2 m.
3. The sides of the pit are correctly sloped and all loose soil removed.
4. Earth removed from the pit is evenly distributed around the ringbeam.

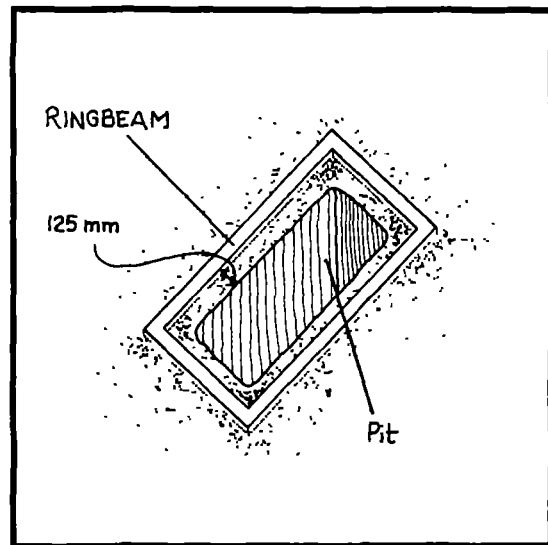

The Rectangular Excavation

Step 4: Coverslabs

After completing the excavation, the VSA is responsible for laying the three coverslabs, with the assistance of the householder. The coverslabs should be mortared to the top of the ringbeam. Loose soil should be graded to slope away from the top of the coverslabs in order to shed rainwater.

In undertaking this operation, the VSA must ensure that:

1. The coverslabs are in good condition. He should check for flaking, chipping, cracks, exposed reinforcing steel, and, in particular, damage to the abutting edges which may prevent them from being sealed properly. Poor-quality slabs must be returned to the District Council (which will replace them).
2. The mortar mix is 1 cement to 6 sand.
3. The openings in the coverslabs for the ventpipe and seat insert are correctly located over the pit.
4. The coverslabs are level.
5. All joints are airtight and watertight.

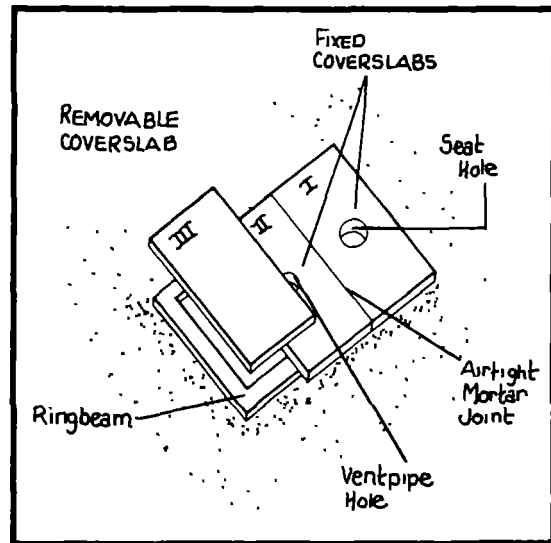

Laying the Coverslabs

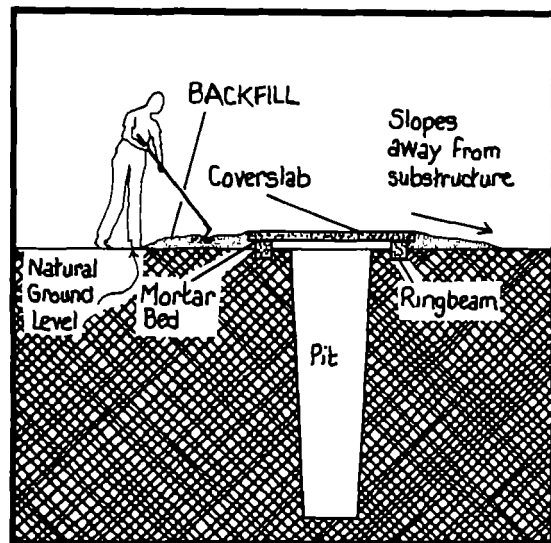

Grading the Backfill

3C. Lined Circular Substructures Built in Unstable Soils (BOTVIP B)

This section describes two alternative circular lined substructures which may be constructed where unstable soils (such as sand, sandy-clay or loose gravelly-clay) are found. These are particularly suitable for use in the Kalahari. The linings protect the pits from collapsing while at the same time permitting the seepage of urine and other small amounts of liquid into the adjacent soil.

(i) Circular Substructure with Masonry Lining

Step 1: Location, Orientation and Staking

The latrine substructure should be located by the householder, in close collaboration with the VSA. Generally speaking, the latrine should be located towards the rear of the plot. Where no door is to be provided on the superstructure, the entry should preferably not face east or west where the morning or evening sunlight can penetrate the interior of the substructure and so encourage insects to leave the pit through the latrine seat instead of up the ventpipe. It is also important to ensure that the entry will not be directly visible to either passersby or neighbouring plots. Preferably, the entry should face the house.

The latrine should be located at least 2 metres from existing trees or overhanging branches in order to maintain proper ventilation through the ventpipe. Ideally, the ventpipe should be located on the north side to ensure that it is heated by the sun on still days; this helps maintain proper ventilation.

Once the latrine has been correctly located and oriented, the VSA should measure and mark out a circle 1250 mm in diameter, using a central stake and a piece of string with a nail on the

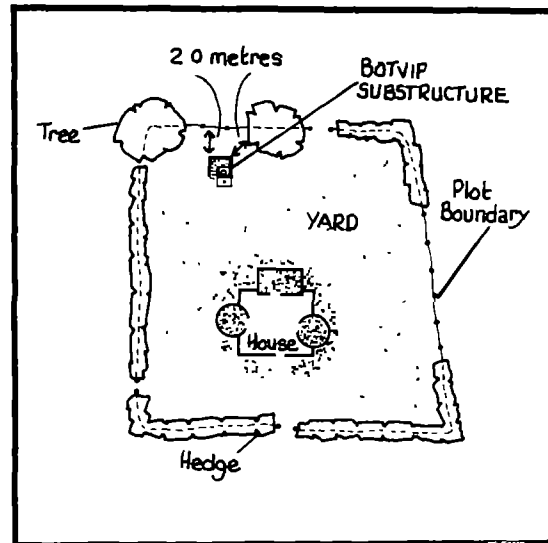

Locating the Circular Substructure

end of it. Alternatively, a pre-constructed circular wood frame or piece of canvas of a similar diameter may be used for determining the edge of the pit.

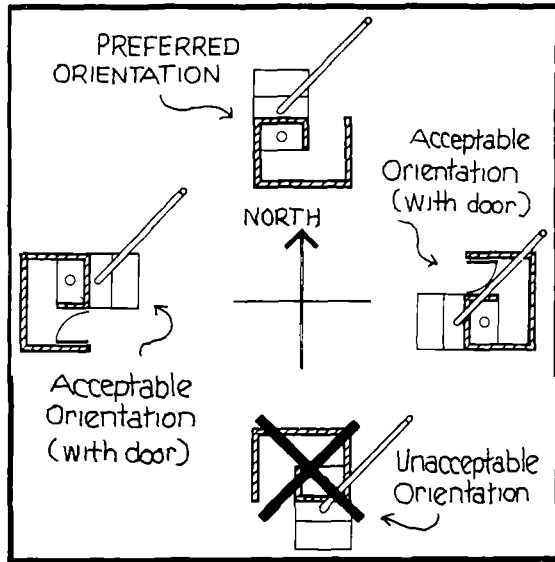

Orientation of Ventpipe

Step 2: Excavation

After locating the pit, the householder is responsible for excavating a circular pit 1250 mm in diameter and 2-3 m deep. Particular care must be taken, especially in very sandy soils, to ensure that the pit does not collapse. Shoring may be required.

In inspecting the pit, the VSA must ensure that:

1. The pit is stable and safe to work in. If there is any sign of instability, the pit should be abandoned, backfilled, and another location selected. **DO NOT ENTER A DANGEROUS UNSTABLE PIT.**
2. The pit is correctly sized.
3. The pit walls are vertical.
4. Excavated soils are piled neatly, well away from the pit.
5. Soils at the bottom of the pit are firm and form a level foundation for the blockwork.

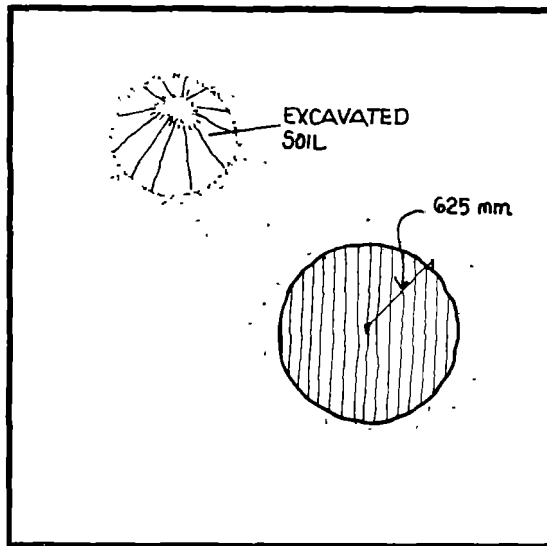

The Circular Excavation for Trapezoidal-Block Lining

Step 3: Blockwork and Backfill

Following inspection of the pit by the VSA, the householder is responsible for constructing the lining of the specially-made trapezoidal blocks (see Appendix V). The first course should be laid out loosely, levelled by the VSA, and then mortared. The householder then builds the lining wall up to just above ground level. On completion of the wall, the householder should backfill the space between the wall and the edge of the excavation with sandy soil or fine gravel. The top 500 mm should be backfilled with clay or a weak soil-cement mixture (10:1).

In inspecting this stage of construction, the VSA must ensure that:

1. Good-quality trapezoidal blocks are used throughout.
2. The mortar mix used in the first course is 1 cement to 6 sand.
3. All joints are left open except for the top three courses which must be fully sealed (with mortar mixed in the proportion of 1 cement to 6 sand) to prevent rainwater from entering the pit.
4. The top of the wall extends about 50 mm above natural ground level.
5. When the blockwork is completed, the earth at the bottom of the pit is loosened with a pick and all surplus mortar removed.
6. Backfill is compacted and slopes away from the top of the wall.

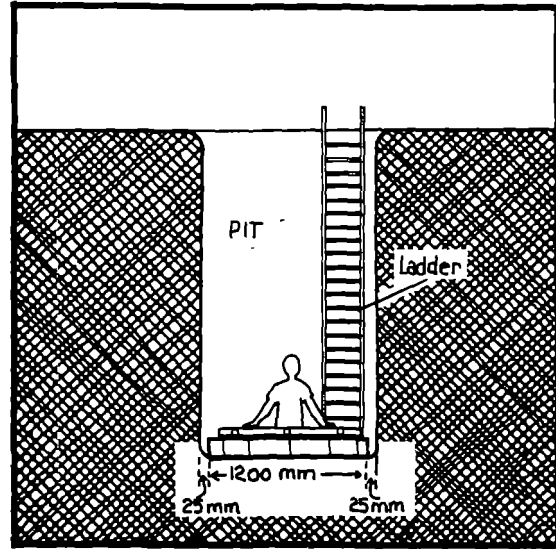

Levelling the First Course of Trapezoidal Blocks

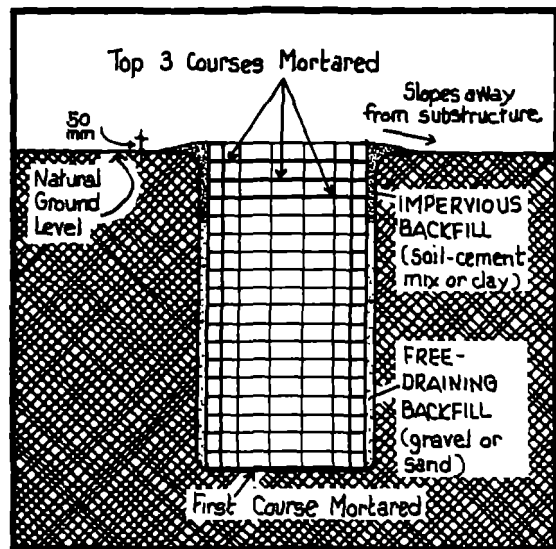

Backfilling the Excavation

Step 4: Coverslabs

After proper curing of the blockwork, the VSA is responsible for laying the coverslabs on mortar on top of the block wall, with assistance from the householder. Two rectangular coverslabs, or a circular one, may be used (see Appendices VII and VIII).

During this operation, the VSA must ensure that:

1. The coverslabs are in good condition. If not, they must be returned to the District Council (which will replace them).
2. The coverslabs are correctly oriented (see Step 1).
3. The mortar mix is 1 cement to 6 sand.
4. All joints are airtight and watertight.
5. Additional backfill is compacted to slope away from the top edge of the coverslabs.

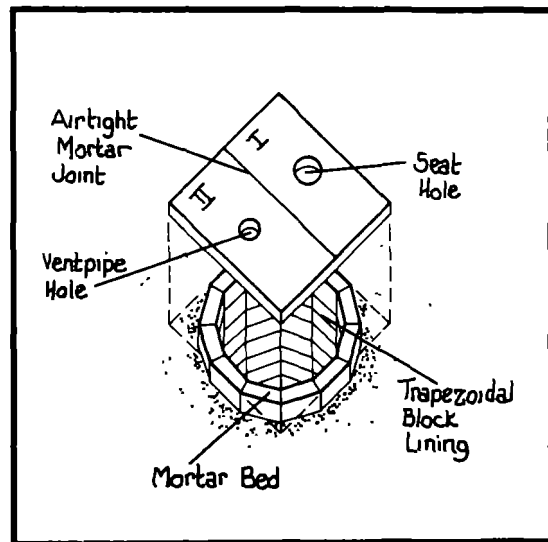

Laying the Coverslabs

(ii) Circular Substructure with Wire-Mesh Lining

Step 1: Location, Orientation and Staking

The latrine substructure should be located by the householder, in close collaboration with the VSA. Generally speaking, the latrine should be located towards the rear of the plot. Where no door is to be provided on the superstructure, it is important that the entry should not face east or west where the morning or evening sunlight can penetrate the interior of the substructure and so encourage insects to leave the pit through the latrine seat instead of up the ventpipe. It is also important to ensure that the entry will not be directly visible to either passersby or neighbouring plots. Preferably, the entry should face the house.

The latrine should be located at least 2 metres from existing trees or overhanging branches in order to maintain proper ventilation through the ventpipe. Ideally, the ventpipe should be located on the north side to ensure that it is heated by the sun on still days; this helps to maintain proper ventilation.

Once the latrine has been correctly located and oriented, the VSA should measure and mark out two circles of 900 mm and 1025 mm diameters respectively, using a central stake and a piece of string with a nail on the end of it. Alternatively, a preconstructed circular frame of a similar diameter may be used to determine the edge of the pit.

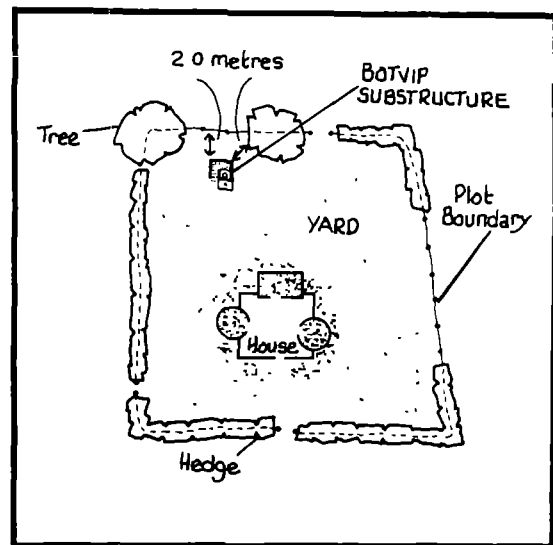

Locating the Circular Substructure

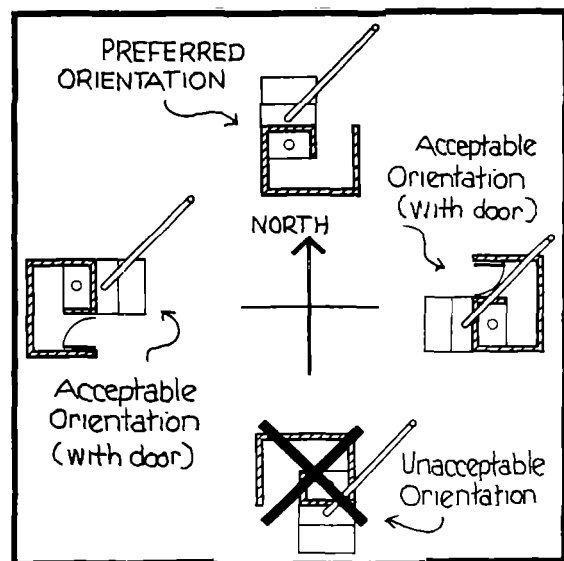

Orientation of Ventpipe

Step 2: Excavation

After locating the latrine, the householder is responsible for excavating a circular pit 950 mm in diameter and 2200 mm deep. Particular care must be taken, especially in very sandy soils, to ensure that the pit does not collapse. Shoring may be required.

In inspecting the pit, the VSA must ensure that:

1. The pit is stable and safe to work in. If there is any sign of instability, the pit should be abandoned, backfilled, and another location selected. **DO NOT ENTER A DANGEROUS UNSTABLE PIT.**
2. The pit is the right size and the walls are vertical.
3. The pit is 2200 mm deep.
4. Excavated soils are piled neatly, well away from the pit.

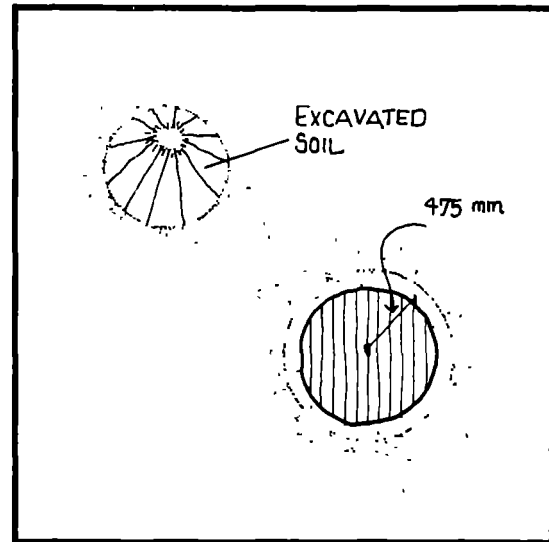

Circular Excavation for Wire-Mesh-and-Filter-Fabric Lining

Step 3: Lining and Backfill

After completing the excavation, the householder is responsible for placing the wire-mesh-and-filter-fabric frame (see Appendix VI) in the pit, with assistance from the VSA. They must ensure that the top of the frame extends to ground level. Once the lining is installed, the householder should backfill the small space between the frame and the edge of the excavation with sandy soil or fine gravel. The top 500 mm should be backfilled with clay or a weak soil-cement mixture (10:1).

In inspecting this operation, the VSA must ensure that:

1. The top ring of the frame is at ground level, and the wire ends extend straight up, 100 mm above ground level.
2. Backfill has been completed correctly.

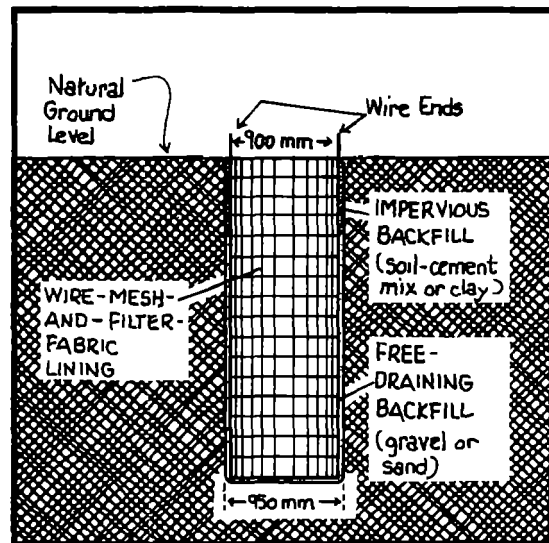

Placing the Wire-Mesh Lining in the Excavation

Step 4: Ringbeam

Following placement of the lining and backfill, the householder excavates a trench, 125 mm wide by 75 mm deep, around the periphery of the pit. He then bends the top of the wire-mesh frame outwards so that it projects into the ringbeam excavation. The VSA then pours a 125-mm-square ringbeam around the wire ends, using them as reinforcement. The ringbeam should rest flush against the lining which acts as a shutter.

In supervising this operation, the VSA must ensure that:

1. The ringbeam trench is correctly dimensioned.
2. The ringbeam concrete is mixed at 1 cement to 2 sand to 4 stone, and is well compacted.
3. The wire ends extend into the ringbeam and are secured.
4. The ringbeam is permitted to cure for at least 3 days. It may be kept damp during the curing period, using wet hessian, for example.

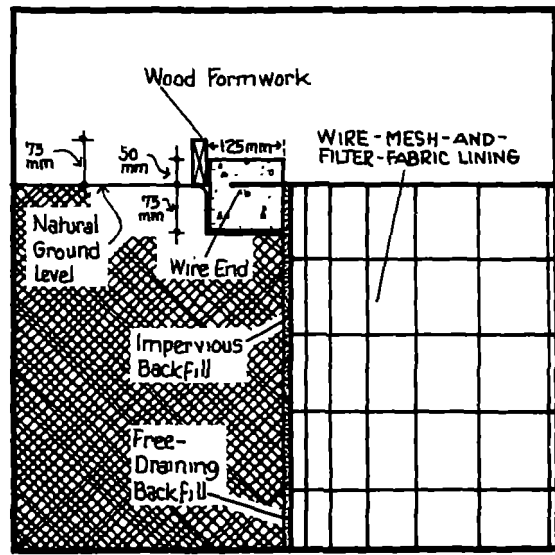

Pouring the Circular Ringbeam

Step 5: Coverslabs

Following proper curing of the ring-beam, the VSA is responsible for placing and securing the coverslabs to the top of the ringbeam, with assistance from the householder. Two rectangular coverslabs, or a circular one, may be used (see Appendices VII and VIII).

During this operation, the VSA must ensure that:

1. The coverslabs are in good condition. If not, they must be returned to the District Council (which will replace them).
2. The coverslabs are correctly oriented (see Step 1).
3. The mortar mix is 1 cement to 6 sand.
4. All joints are airtight and watertight.
5. Additional backfill is compacted to slope away from the top edge of the coverslabs.

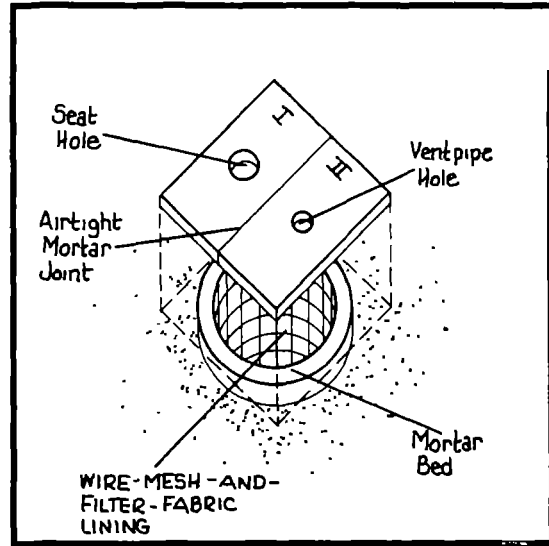

Laying the Coverslabs

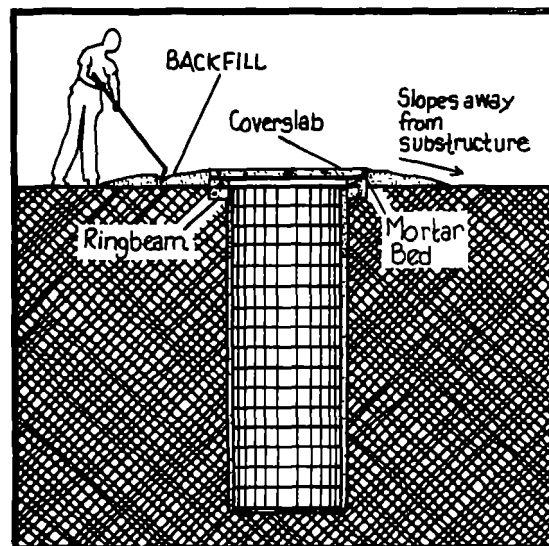

Grading the Backfill

4. Constructing the Superstructure

This section presents a step-by-step outline of the methods used in constructing two alternative BOTVIP latrine superstructures — one is rectangular, built using either traditional or contemporary methods and materials; the other is round, using only traditional methods, and traditional or contemporary materials. Either of these designs can be erected on any of the substructures which were presented in the previous section (see Appendices I-IV). As there are a large number of superstructure designs which are equally acceptable, these two should be viewed only as typical examples. Above all, it is important that the Village Sanitation Assistants (VSAs) inform householders that they may use a wide variety of building materials. Householders should be encouraged to use readily available local building materials which they can afford. These may include traditional materials (e.g., thatch, reeds, sun-dried mud-brick or poles) as well as contemporary ones (e.g., corrugated-iron roof sheets or sand-cement blocks). However, regardless of the design or materials used, the superstructure must be ventilated and kept reasonably dark inside to ensure that flies leave the pit up the ventpipe instead of through the seat.

As with the substructure, the superstructure is constructed by the householder, working in close collaboration with the VSA. It is important that both parties clearly understand their respective roles and responsibilities in order to avoid delays. Every effort should be made to complete the superstructure as soon as possible after the substructure is finished. The VSAs should visit village plots on a regular basis during construction periods to help people with any problems which may arise. They should also keep a record of the householders' progress.

4A. Preparing to Construct the Superstructure

Prior to the commencement of construction, both the VSA and the householder must ensure that they possess, or have access to, the necessary tools they will need.

The Village Sanitation Assistant will need:

- Wall pattern (optional)
- A tape measure
- A hammer
- A spirit level
- Trowels (for bricklaying and plastering)
- A spade
- Stakes and string
- A satchel or carrying bag

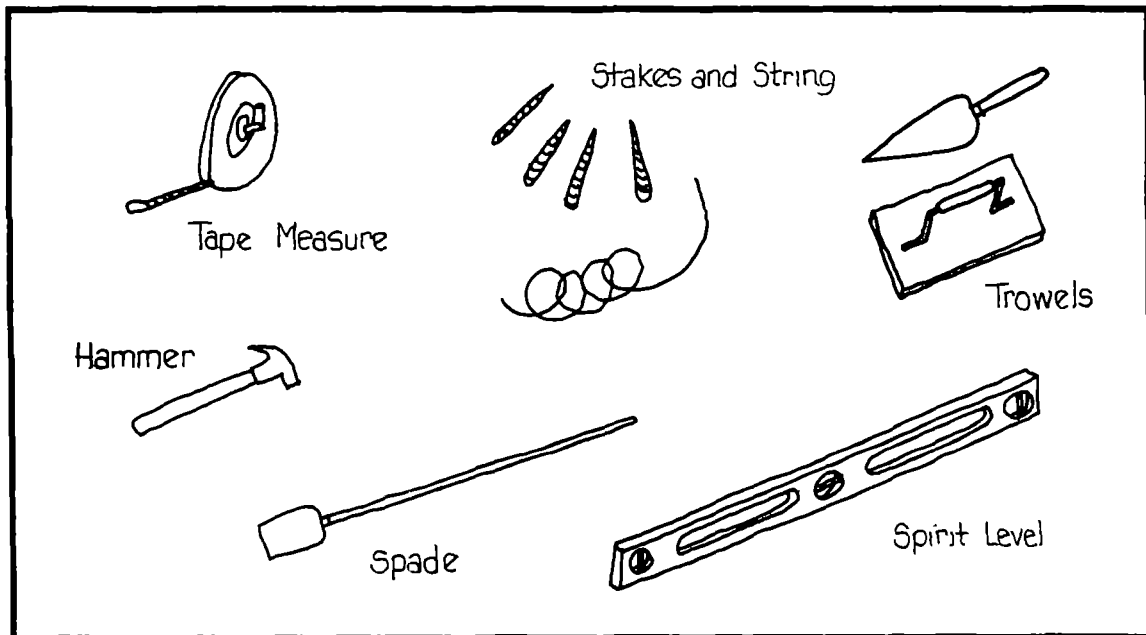

Village Sanitation Assistant's Equipment

The Householder will need to possess, or have access to:

- A brick or block mould
- A hammer
- A tape measure
- Trowels (for bricklaying and plastering)
- Wire cutters
- A saw
- A plastering brush (optional)

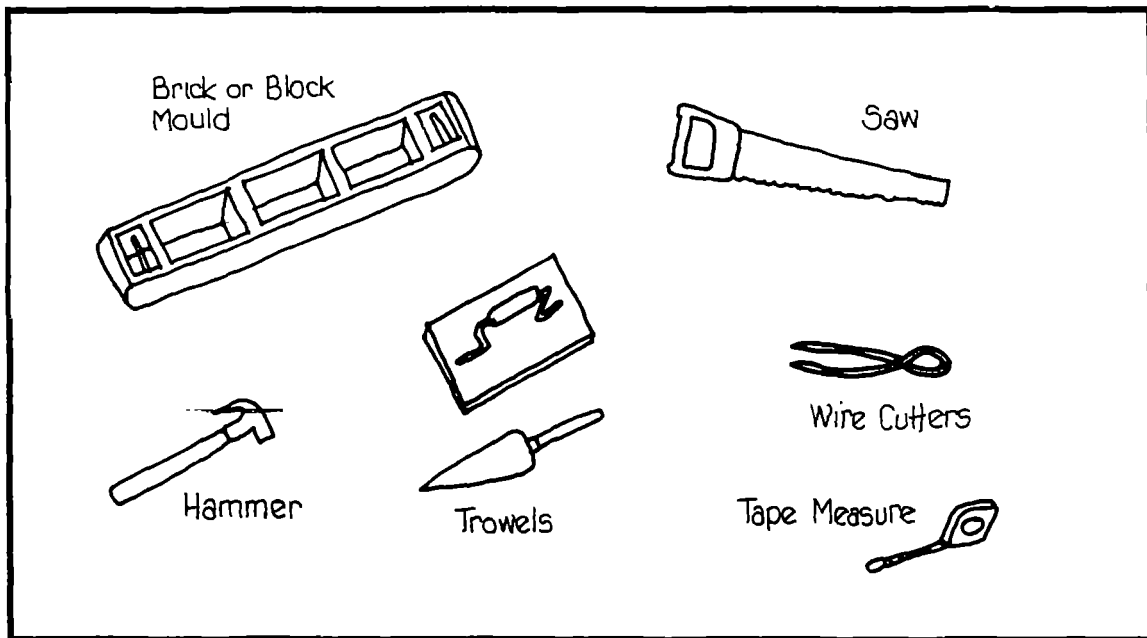

Village Householder's Equipment

In addition, the householder will need to purchase, seek out or make all the necessary building materials and assemble these before construction begins. These materials may include:

- Sand-cement blocks or mud-bricks
- Wood braces, wall plates or rafters
- Door frame (optional)
- Cement
- Corrugated-iron or asbestos roof sheets, or thatch
- Plaster
- Paint
- Galvanized wire
- Nails and screws

Finally, the VSAs must ensure that the ventpipes, flyscreens and seat inserts have been, or will be, delivered to individual plots on time.

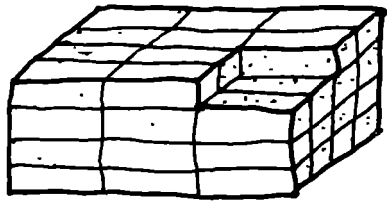

Bricks or Blocks

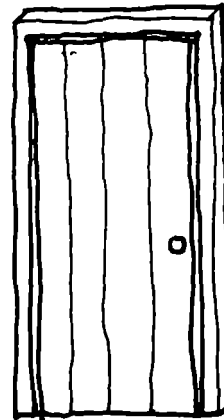

Door Frame

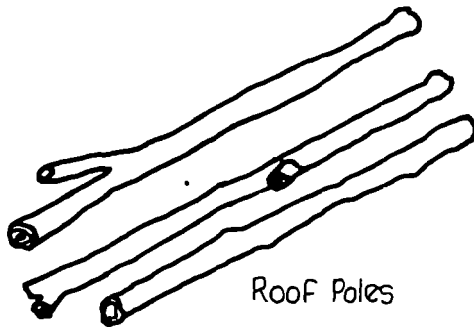

Roof Poles



Paint



Cement

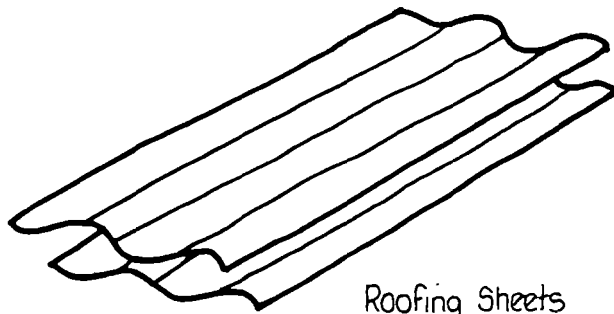

Roofing Sheets



Wire and Nails

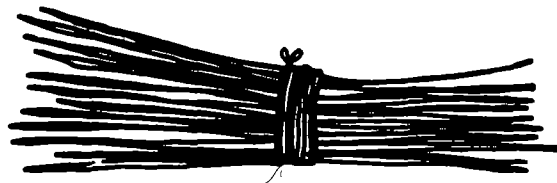

Thatch

Superstructure Materials Supplied by the Householder

4B. Rectangular Superstructure

This subsection describes the construction of a conventional rectangular superstructure. This superstructure may be built over either a rectangular or circular substructure. Local materials and construction practices should be encouraged.

Step 1: Location, Orientation and Staking

The VSA is responsible for locating and staking, or otherwise marking, the location of the superstructure. This may be done using either stakes and string or a preconstructed rectangular wall pattern. The exterior perimeter of the superstructure should be marked on both the top of the coverslabs and the ground.

In undertaking this operation, the VSA must ensure that the superstructure is correctly oriented. Ideally, the entry and ventpipe should be located on the north side, but decisions on this orientation should have been made during the construction of the substructure (see *Step 1* on page 14, 18 or 22). If a mistake was made during this earlier stage, it should be corrected before proceeding with the construction of the superstructure.

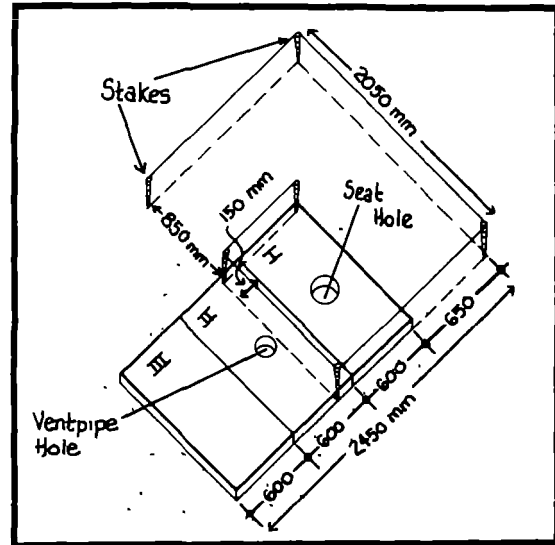

Marking out the Rectangular Superstructure

Step 2: Blockwork

After locating the superstructure, and because the tops of the coverslabs may occur at varying heights above natural ground level, the VSA must loosely lay out the first course of blocks that will rest on the coverslabs. He must then measure the height of this course above natural ground level, remembering to allow for the thickness of the mortar joint. The VSA should then calculate how many courses, including the foundation, will need to be laid in order to ensure that the top of the outside wall will be flush with the top of the wall on the coverslab.

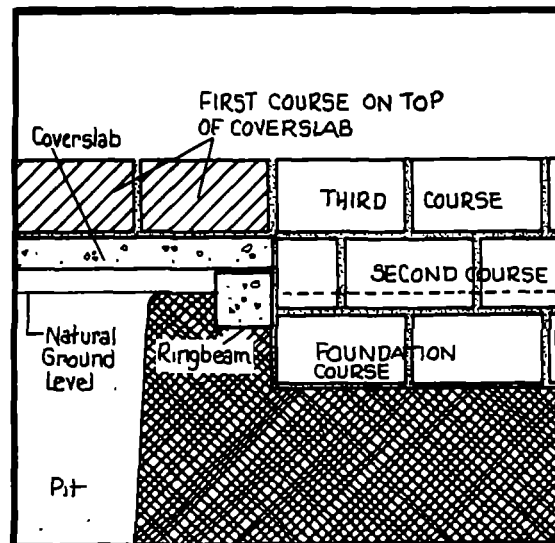

Laying the First Courses

The VSA commences construction by excavating a trench for the foundation which may be formed by either concrete or a first course of blocks. Once the foundation has set, he should continue to build up the wall until it incorporates the first course on the coverslab. The householder should take over after this and complete the walls to roof level. The top of the front wall should be higher (about 2.0 m) than the top of the rear wall (about 1.8 m) in order to support a roof which will drain to the rear of the superstructure. A small ventilation gap may be left in the rear wall. If desired, a door frame may be installed (see Step 6).

Where mud-bricks and plaster are used, the bottom 1 m of the exterior wall should be plastered (using a mortar mixture of 1 cement to 6 sand) and covered with a cement wash to protect against rain damage.

In undertaking and inspecting this stage of construction, the VSA must ensure that:

1. Blocks being used are of reasonable quality. They should not break if dropped on the ground from chest height.
2. Blockwork is plumb and level.
3. The mortar mix is 1 cement to 6 sand.
4. The ventilation gap is well located.
5. The walls are allowed to set for at least 3 days.
6. Provision is made for tying the rafters and the ventpipe to the blockwork.

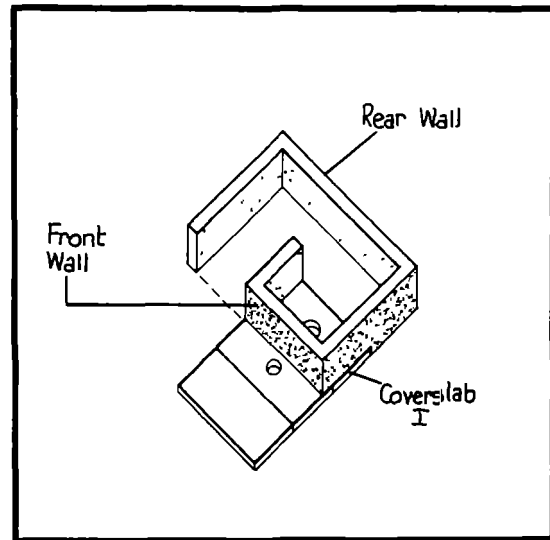

Constructing the Superstructure Walls

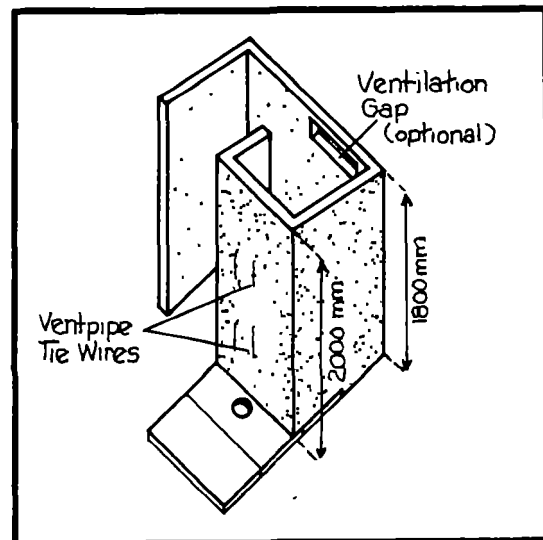

Completing the Superstructure Walls

Step 3: Installing the Seat Insert

Following completion of the blockwork, the VSA is responsible for advising the householder on how to install the seat insert or, if an insert is not being used, on how to build a seat.

Where the seat insert is used, a mud-brick or block frame is built up to accommodate it. Fresh mortar or mud is laid on the top of the frame and the insert pressed into the mortar or mud so that the base of the insert passes through the hole which was cast for it in the coverslab below. An alternative seat made of wood or a concrete slab with a hole in it may be set on the frame instead.

In supervising this operation, the VSA must ensure that:

1. The seat insert is in good condition.
2. The seat insert is correctly located and sits tightly on the coverslab.
3. The seat frame is allowed to set for 3 days after it is completed.
4. All joints are airtight and watertight.
5. All exposed surfaces are covered in smooth-finished cement mortar, mixed in the proportion of 1 cement to 4 sand.

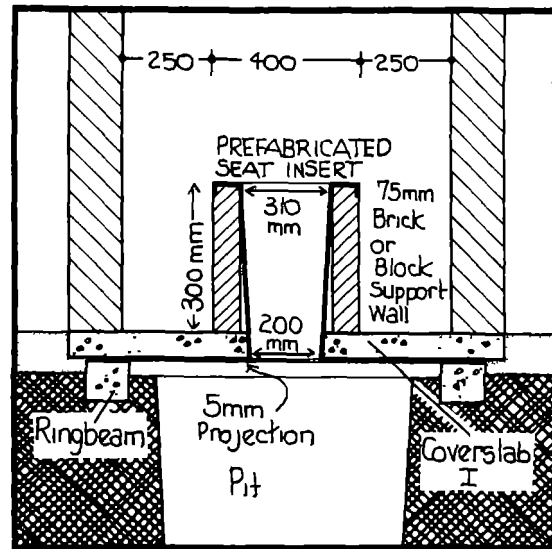

Building the Seat

Step 4: Roof and Drainage

After completing the seat, the householder is responsible for constructing the roof. Wood wall plates should be wired to the top of the front and rear walls, and corrugated-iron or asbestos sheets (cut to the correct size — 2000 mm by 1500 mm) fixed to the plates. The use of rafters is optional. A hole should be cut in the roof to allow the ventpipe to extend through it. All surplus soil should be graded, smoothed and compacted to provide good drainage *away* from the latrine.

In inspecting this stage of construction, the VSA must ensure that:

1. The wall plates are well secured to the top of the walls.
2. The roof sheets are properly secured to the plates (or rafters).
3. The roof will drain to the rear of the superstructure.

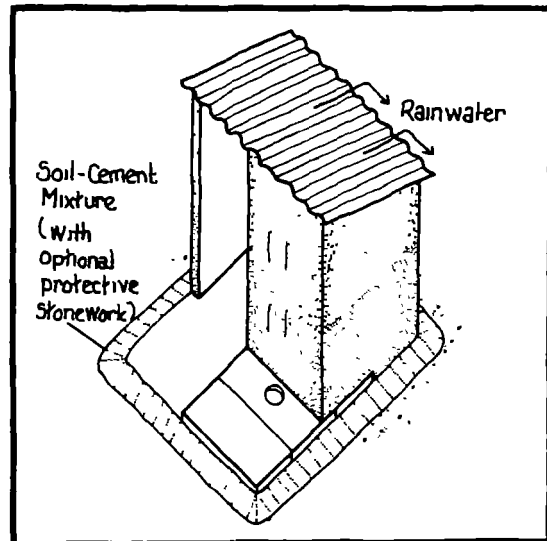

Roofing the Superstructure

Step 5: Ventpipe

Following the completion of the roof, the VSA is responsible for installing the ventpipe. The ventpipe may be either polyvinyl chloride (pvc) or cement-wash hessian (see Appendix X), depending on the funds available (i.e., the hessian type is much less expensive) and on the location of the village. A plastic-coated glass-fibre or stainless-steel mesh flyscreen must be secured to the top of the ventpipe with galvanized wire or a pipe clamp. When raised, the ventpipe should extend at least 500 mm beyond the highest point of the roof. It should be fixed to the front wall with galvanized wire and its base should be built up with cement mortar for additional support and to prevent insects and water from entering the pit.

In undertaking this operation, the VSA must ensure that:

1. The ventpipe is in good condition. (If not, return it to the District Council.)
2. The flyscreen is correctly attached to the ventpipe.
3. The ventpipe is securely fastened to the superstructure wall and the coverslab.
4. The joint between the ventpipe and the coverslab is airtight and watertight.
5. The ventpipe extends at least 500 mm beyond the tallest point of the roof.

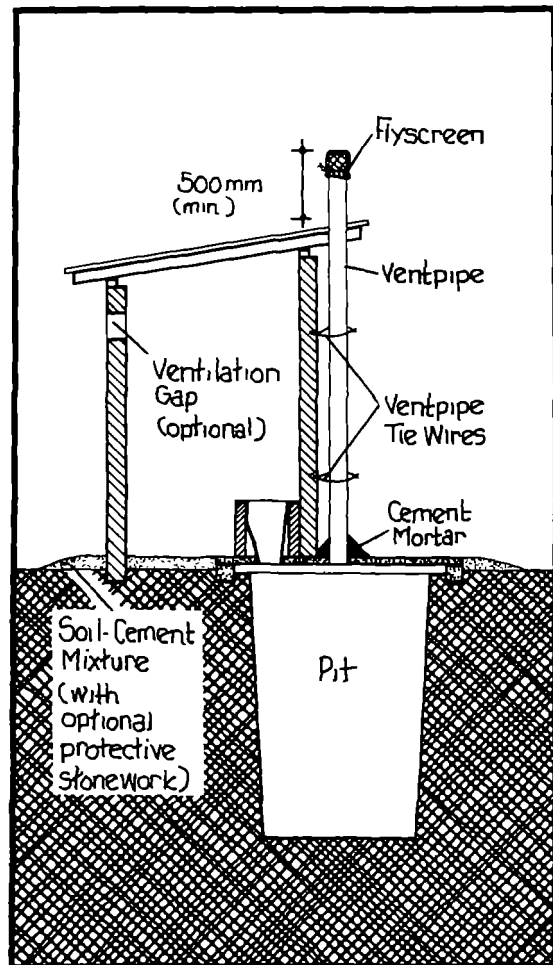

Section through the Rectangular Superstructure

Step 6: Finishing the Superstructure

A number of additional improvements may be made to the superstructure as time and money become available. These include:

1. *Superstructure Floor*

The floor of the superstructure should be built up to the level of the coverslabs and it may then be finished in polished concrete.

2. *Door*

A door should be added to the superstructure when funds become available. There are two optional locations for the door. The door must have an air gap at the bottom to allow for proper ventilation.

3. *Plastering*

The exterior and interior of the superstructure may be finished with plaster and paint, or with a mud-dung mixture. The lower 1 metre of the exterior wall should be finished in 1:6 cement, sand plaster or a cement wash to protect it against rain damage.

4. *Path*

A path to the latrine should be cleared and marked, and the area cleared of bushes. Grass should be left.

5. *Seat and Cover*

A standard seat and cover may be added to the seat insert. A gap must be left between the seat and cover to allow for continuous ventilation.

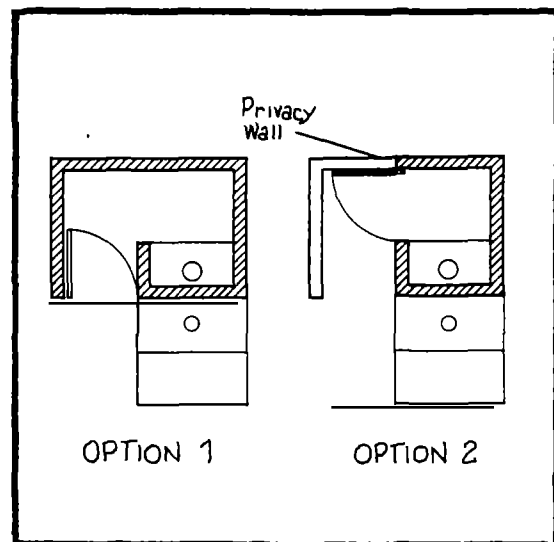

**Finishing the Rectangular Superstructure:
Optional Door Locations**

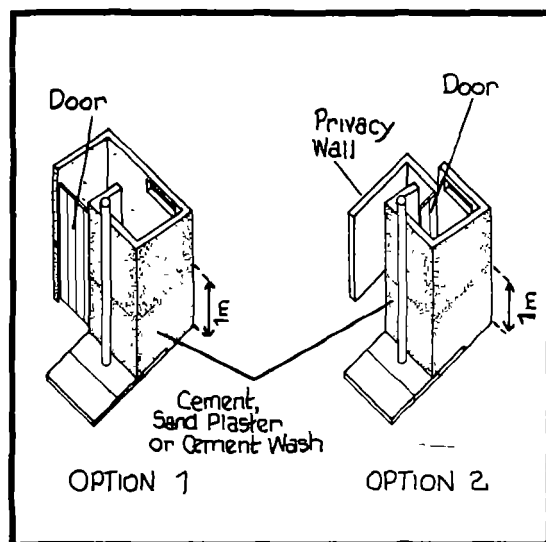

**Finishing the Rectangular Superstructure:
Optional Door Locations**

4C. Circular Superstructure

This subsection describes the construction of a circular superstructure. This type of superstructure may be built on either a rectangular or a circular substructure. The design is based on traditional construction techniques and can be built using either traditional or contemporary building materials.

Step 1: Location, Orientation and Staking

The VSA is responsible for locating and staking, or otherwise marking, the location of the superstructure. This may be done using either stakes and a string or a preconstructed circular wall pattern. The exterior perimeter of the superstructure should be marked on both the top of the coverslabs and the ground.

In undertaking this operation, the VSA must ensure that the superstructure is correctly oriented.

Ideally, the entry and ventpipe should be located on the north side, but decisions on this orientation should have been made during the construction of the substructure (see *Step 1* on page 14, 18 or 22). If a mistake was made during this earlier stage, it should be corrected before proceeding with the construction of the superstructure.

Step 2: Blockwork

After locating the superstructure, and because the tops of the coverslabs may occur at varying heights above natural ground level, the VSA must loosely lay out the first course of blocks or bricks that will rest on the coverslabs. He must then measure the height of this course above ground level, remembering to allow for the thickness of the mortar joint. The VSA should then calculate how many courses, including the foundation, will need to be laid in order to

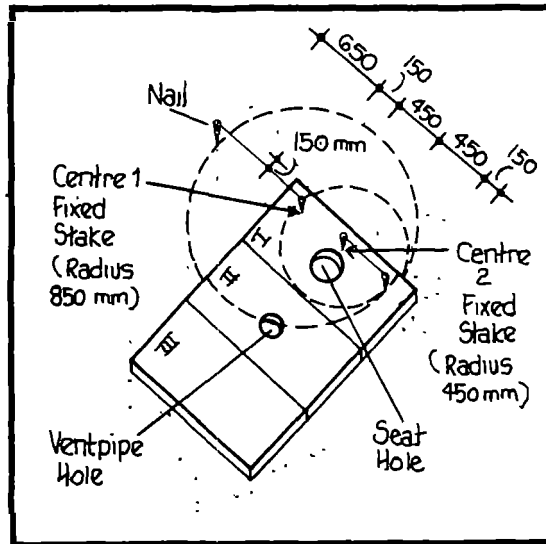

Marking out the Circular Superstructure

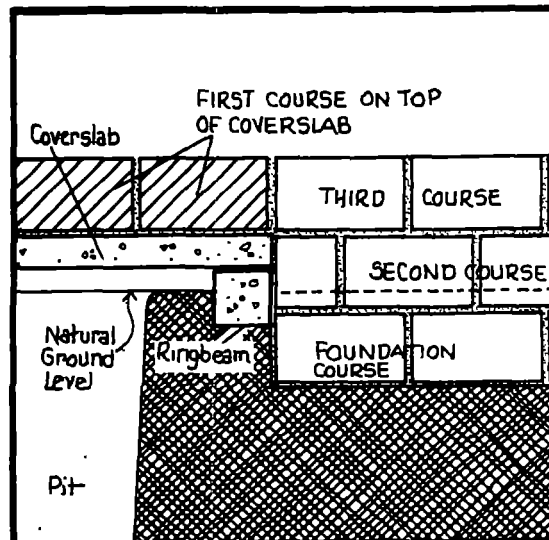

Laying the First Courses

ensure that the top of the outside wall will be flush with the top of the wall on the coverslab.

The VSA commences construction by excavating a trench for the foundation which may be formed by either concrete or a first course of blocks or bricks. Once the foundation has set, he should continue to build up the wall until it incorporates the first course on the coverslab. The householder should take over after this and complete the walls to roof level. The top of the front wall should be higher (about 2.0 m) than the top of the rear wall (about 1.8 m) in order to support a roof which will drain to the rear of the superstructure. A small ventilation gap may be left in the rear wall. If desired, a door frame may be installed (see Step 6).

Where mud-bricks and plaster are used, the bottom 1 metre of the exterior wall should be plastered (using a mortar mixture of 1 cement to 6 sand) and covered with a cement wash to protect against rain damage.

In undertaking and inspecting this stage of construction, the VSA must ensure that:

1. Blocks or bricks being used are of reasonable quality. They should not break if dropped on the ground from chest height.
2. Blockwork or brickwork is plumb and level.
3. If cement mortar is used, the mix is 1 cement to 6 sand. Mud mortar may vary according to local custom.
4. The ventilation gap is well located.
5. The walls are allowed to set for at least 3 days.
6. Provision is made for tying the ventpipe to the blockwork.

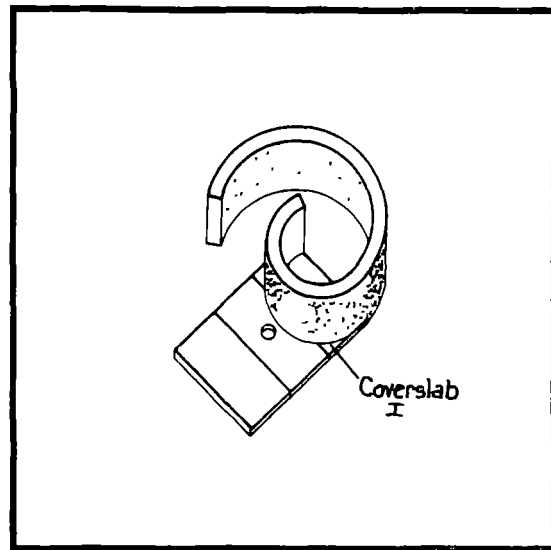

Constructing the Circular Superstructure Wall

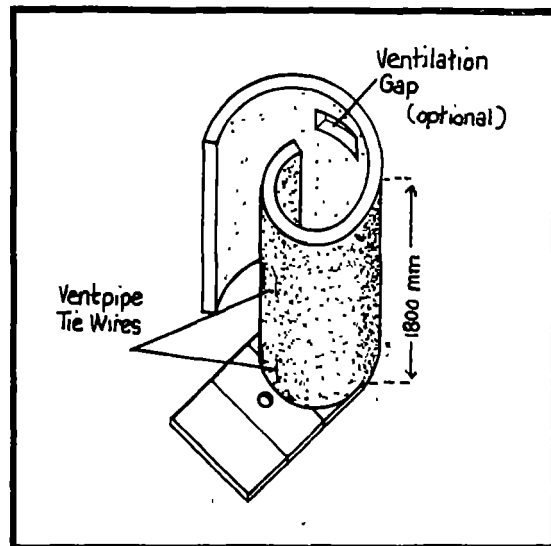

Completing the Superstructure Wall

Step 3: Installing the Seat Insert

Following completion of the blockwork or brickwork, the VSA is responsible for advising the householder on how to install the seat insert or, if an insert is not being used, on how to build a seat.

Where the seat insert is used, a mud-brick or block frame is built up to accommodate it. Fresh mortar or mud is laid on the top of the frame and the insert pressed into the mortar or mud so that the base of the insert passes through the hole which was cast for it in the coverslab below. An alternative seat made of wood or a concrete slab with a hole in it may be set on the frame instead.

In supervising this operation, the VSA must ensure that:

1. The seat insert is in good condition.
2. The seat insert is correctly located, and sits tightly on the coverslab.
3. The seat frame is allowed to set for 3 days after it is completed.
4. All joints are airtight and watertight.
5. All exposed surfaces are covered in smooth-finished cement mortar, mixed in the proportion of 1 cement to 4 sand.

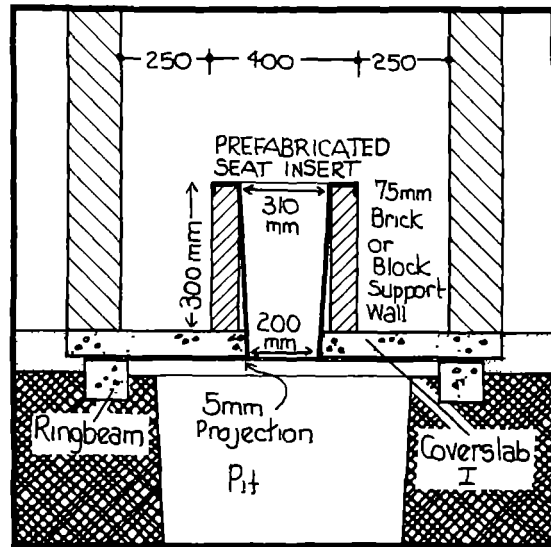

Building the Seat

Step 4: Roof and Drainage

After completing the seat, the householder is responsible for constructing the roof. Typically, this can be made of thatch lashed to a pole roof frame in the traditional fashion. The householder may wish to hire a professional thatcher in the village to build the roof for him. All surplus soil should be graded, smoothed and compacted to provide good drainage *away* from the latrine.

In inspecting this stage of construction, the VSA must ensure that:

1. The roof frame is well secured to the top of the wall.
2. The thatch is well laid.
3. The roof will drain away from the superstructure walls.

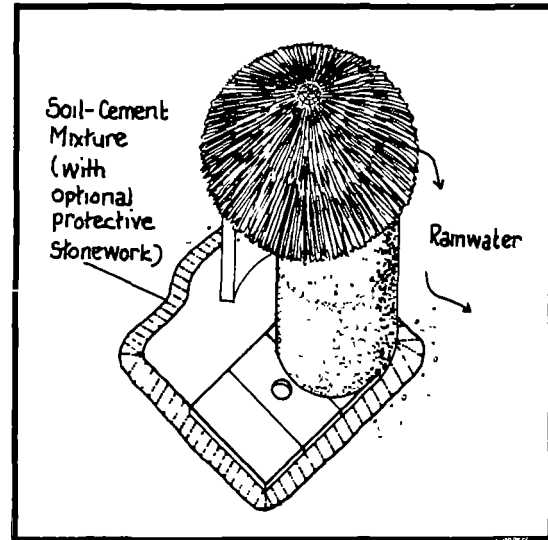

Roofing the Circular Superstructure

Step 5: Ventpipe

Following the completion of the roof, the VSA is responsible for installing the ventpipe. The ventpipe may be either polyvinyl chloride (pvc) or cement-wash hessian (see Appendix X), depending on the funds available (i.e., the hessian type is much less expensive) and on the location of the village. A plastic-coated glass-fibre or stainless-steel mesh flyscreen must be secured to the top of the ventpipe with galvanized wire or a pipe clamp. When raised, the ventpipe should extend at least 500 mm beyond the highest point of the roof. It should be fixed to the front wall with galvanized wire and its base should be built up with cement mortar for additional support and to prevent insects and water from entering the pit.

In undertaking this operation, the VSA must ensure that:

1. The ventpipe is in good condition. (If not, return it to the District Council.)
2. The flyscreen is correctly attached to the ventpipe.
3. The ventpipe is securely fastened to the superstructure wall and the coverslab.
4. The joint between the ventpipe and the coverslab is airtight and watertight.
5. The ventpipe extends at least 500 mm beyond the tallest point of the roof.

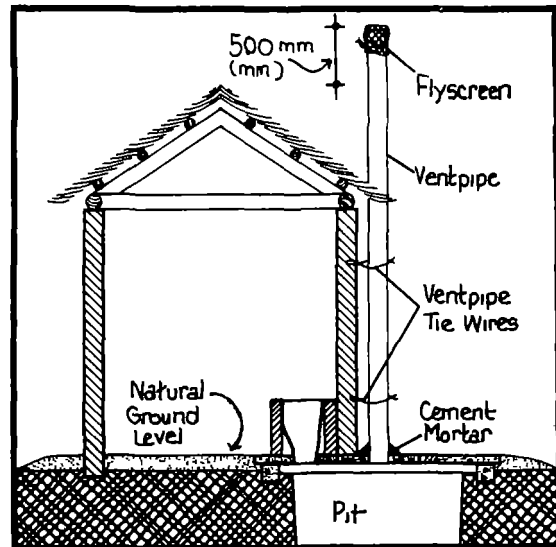

Section Through Circular Superstructure

Step 6: Finishing the Superstructure

A number of additional improvements may be made to the superstructure as time and money become available. These include:

1. *Superstructure Floor*

The floor of the superstructure should be built up to the level of the coverslabs and it may then be finished in polished concrete.

2. *Door*

A door may be added to the superstructure when funds become available. The door must have an air gap at the bottom to allow for proper ventilation.

3. *Plastering*

The exterior and interior of the superstructure may be finished with plaster and paint, or with a mud-dung mixture. The lower 1 metre of the exterior wall should be finished in 1:6 cement, sand plaster, or a cement wash to protect it against rain damage.

4. *Path*

A path to the latrine should be cleared and marked, and the area cleared of bushes. Grass should be left.

5. *Seat and Cover*

A standard seat and cover may be added to the seat insert. A gap must be left between the seat and cover to allow for continuous ventilation.

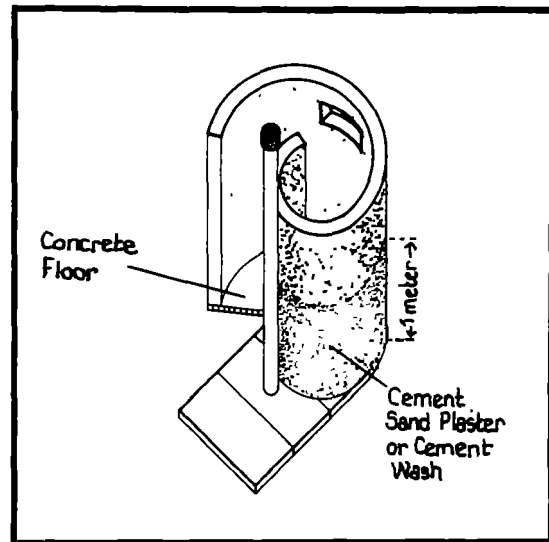

Finishing the Circular Superstructure

5. Monitoring and Maintaining the BOTVIP Latrine

The Village Sanitation Assistant (VSA) and the village householder share the responsibility for monitoring the ongoing use of rural BOTVIP latrines. The VSA should review the following principles of operation of the latrine (also illustrated on the BOTVIP Operations Sheet) with the householder, at the conclusion of the construction period. These latrines should be monitored in the months and years ahead and the householder should initiate a regular maintenance programme in order to ensure proper use and longer life of the latrine.

1. Do not pour water into the pit

The BOTVIP latrine is a dry latrine. Urine and small amounts of water entering the pit will eventually evaporate or soak into the soil. Excessive amounts of water from bathing or cooking must not be emptied into the pit. This water would accumulate and harbour breeding insects. It may also erode the pit. Bathing or cooking water should be emptied into a soakaway or drainage ditch outside the plot.

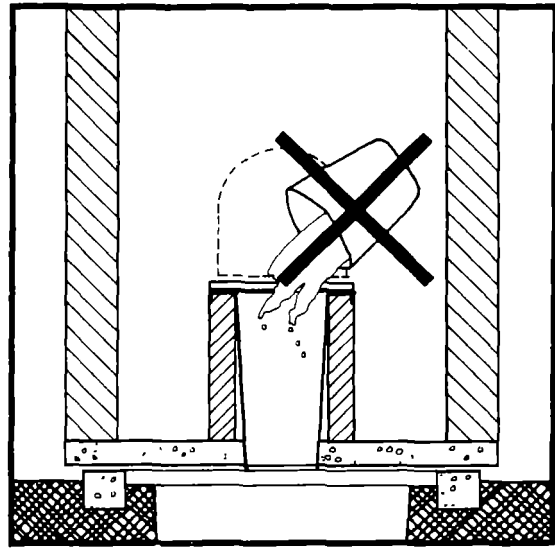

2. Do not put rubbish into the pit

Tins, bottles, vegetable matter or other refuse must not be thrown into the pit. These should be buried elsewhere on the plot.

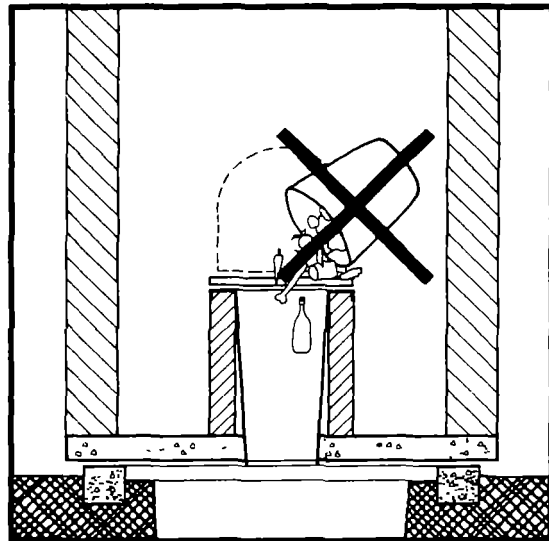

3. Keep the latrine seat covered

When not in use, the latrine seat should be kept covered. This will discourage insects from entering the pit and will keep the pit dark. Also, insects that do manage to enter the pit will be encouraged to fly up the ventpipe where they will be trapped by the flyscreen. A gap must be left between the seat and cover to allow for continuous ventilation.

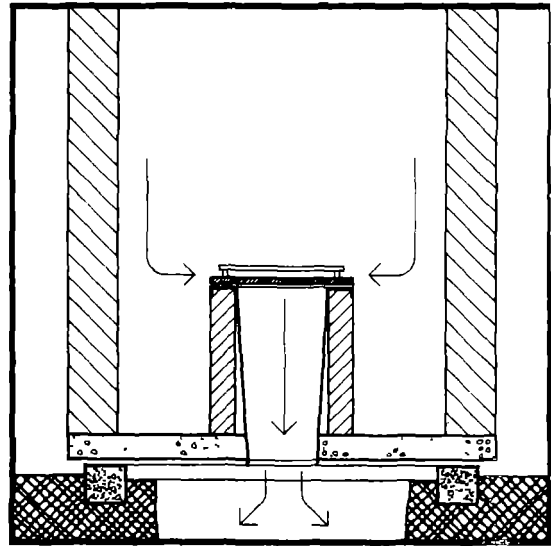

4. Inspect the flyscreen and coverslabs regularly

The flyscreen and the coverslabs should be inspected every 6 months to ensure that the flyscreen is properly secured and the coverslabs are in good condition and airtight. Only plastic-coated glass-fibre or stainless-steel replacement screens should be used. Any gaps between the coverslabs and the pit should be filled with cement mortar mixed in the proportion of 1 cement to 6 sand.

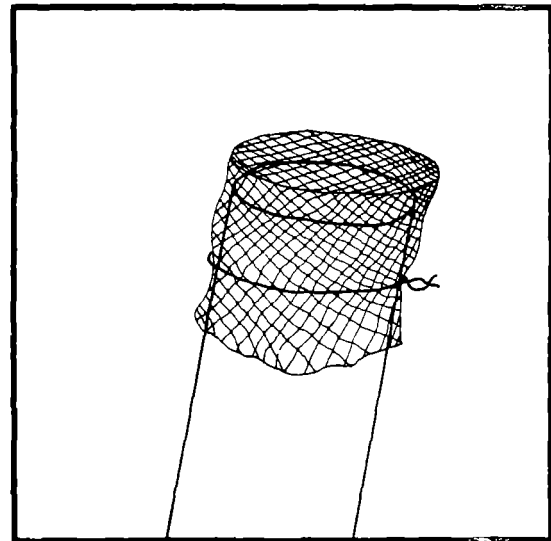

5. Keep the superstructure clean and in good repair

The inside of the superstructure and the latrine seat should be kept clean so as not to attract insects or to create foul smells which could discourage householders from using the latrine. If there is a smell, the door should be kept closed when the latrine is not in use. The door should have a ventilation gap at the bottom.

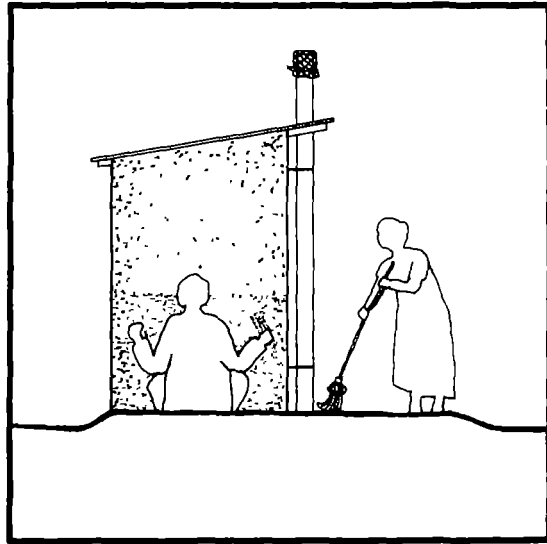

6. Ensure that the entire family uses the latrine

Every member of the householder's family, especially small children and elderly people, should use the latrine rather than adjacent grounds. Children's waste found outside the latrine should be dropped through the seat insert into the pit.

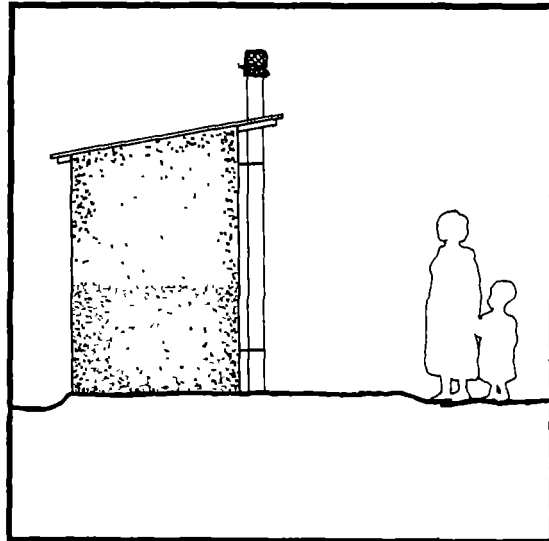

7. Ensure that the BOTVIP Operations Sheet is pinned up inside the latrine

A BOTVIP Operations Sheet, distributed to all latrine owners, should be pinned up inside the superstructure for all users to see.

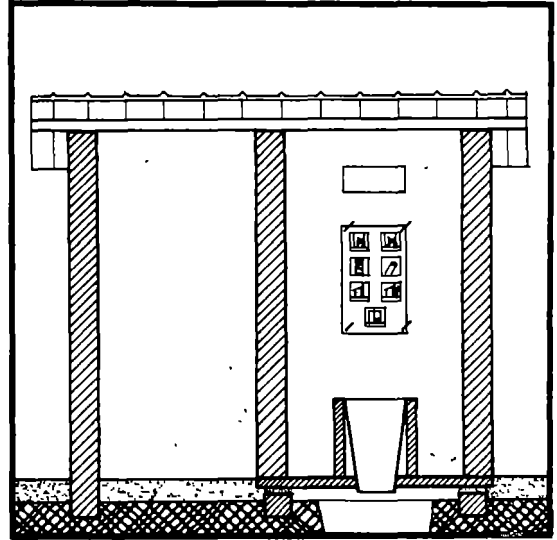

Appendices

Appendix I
BOTVIP A1 — Plan
Rectangular Superstructure on Rectangular Substructure

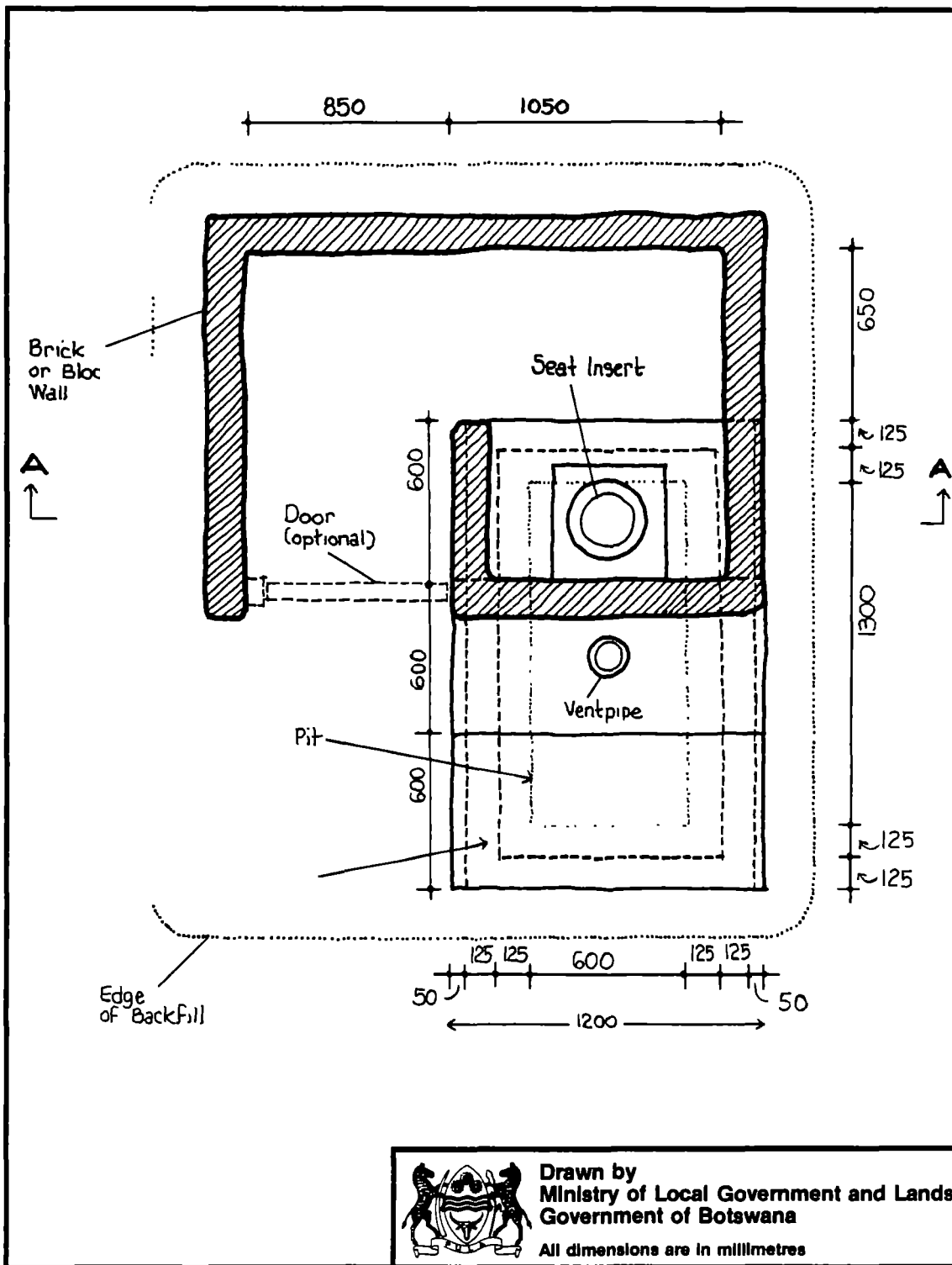

Appendix I (cont'd)
BOTVIP A1 — Section A-A

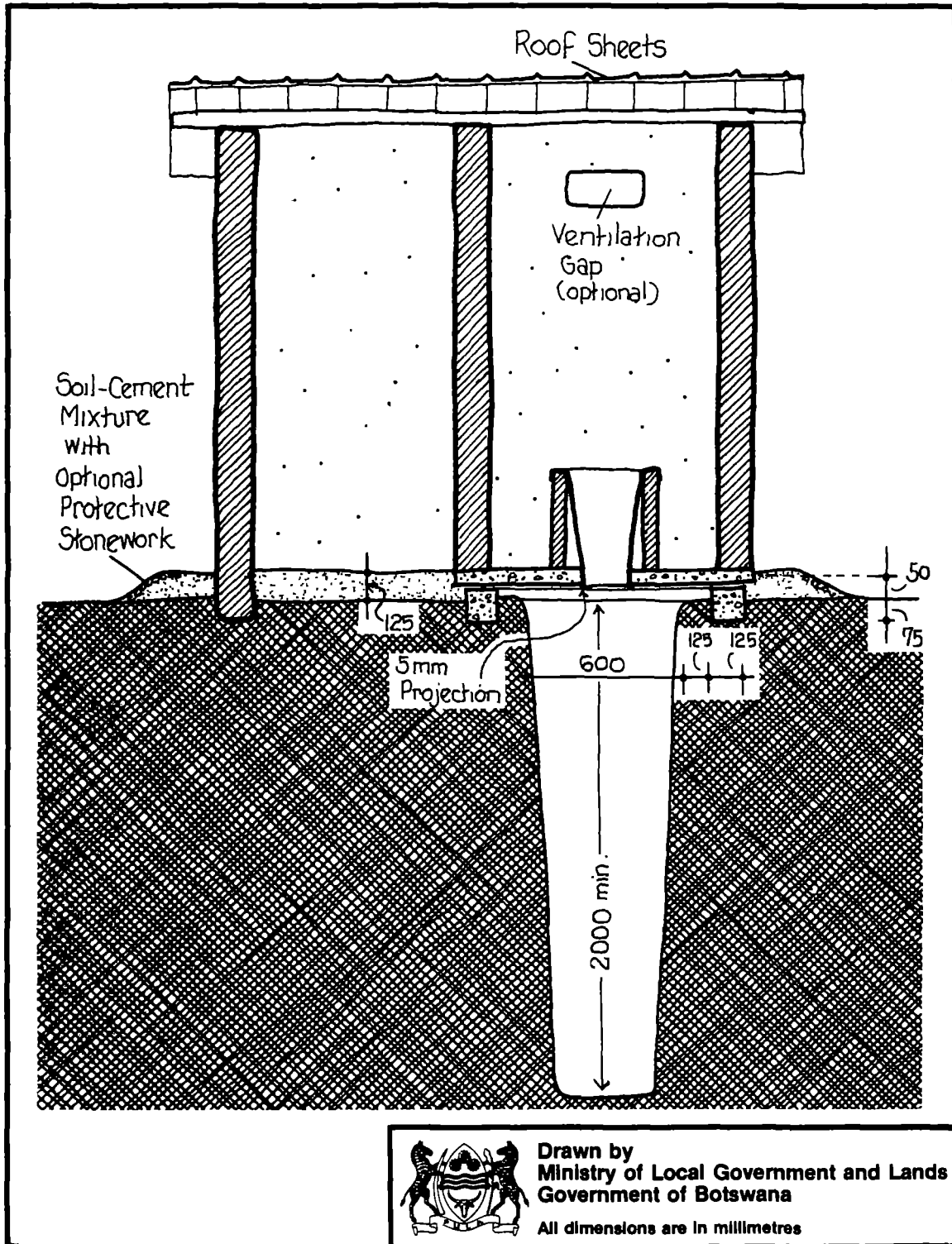

Drawn by
Ministry of Local Government and Lands
Government of Botswana
All dimensions are in millimetres

Appendix II
BOTVIP A-2 — Plan
Circular Superstructure on Rectangular Substructure

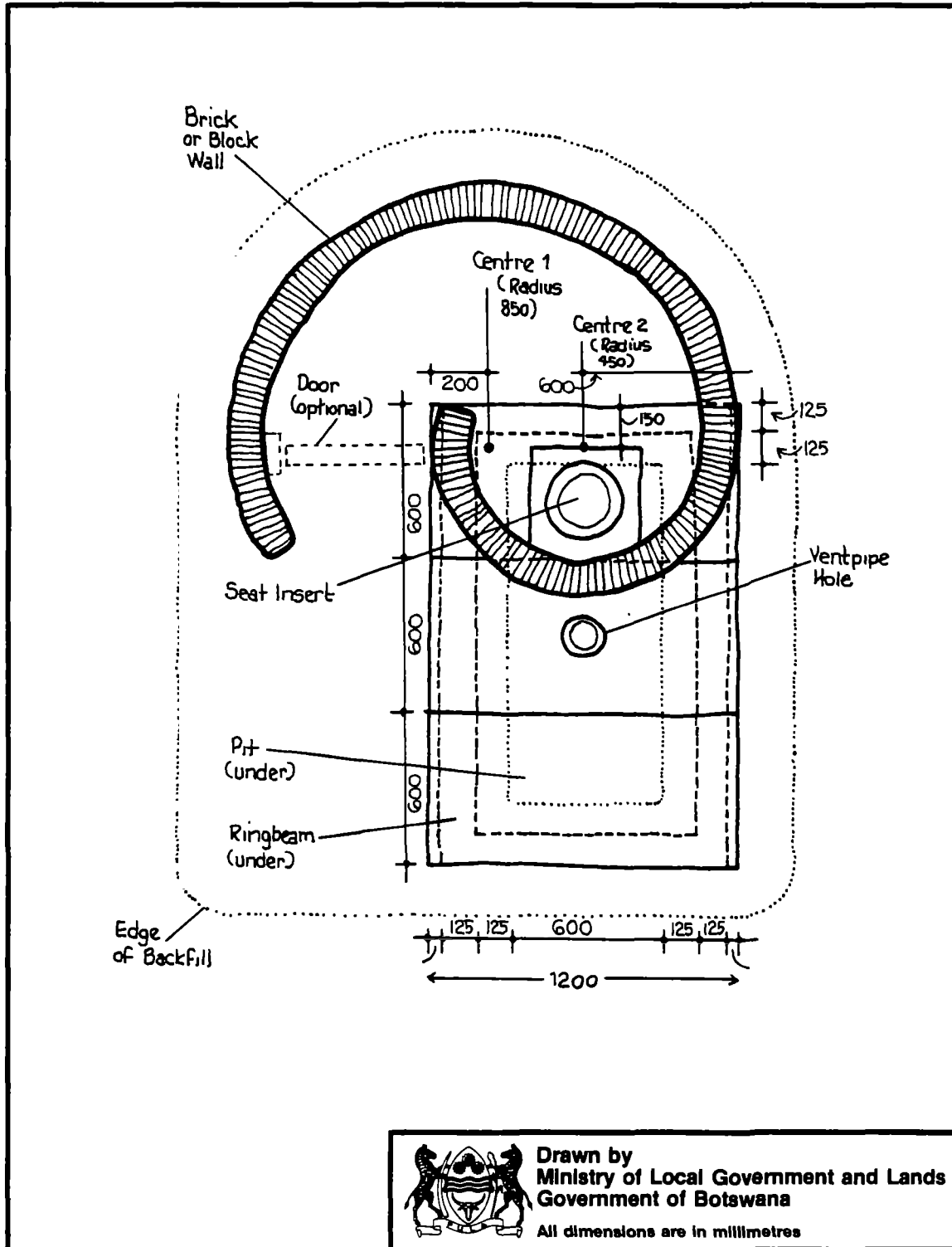

Appendix III
BOTVIP B1 — Plan
Rectangular Superstructure on Circular Substructure

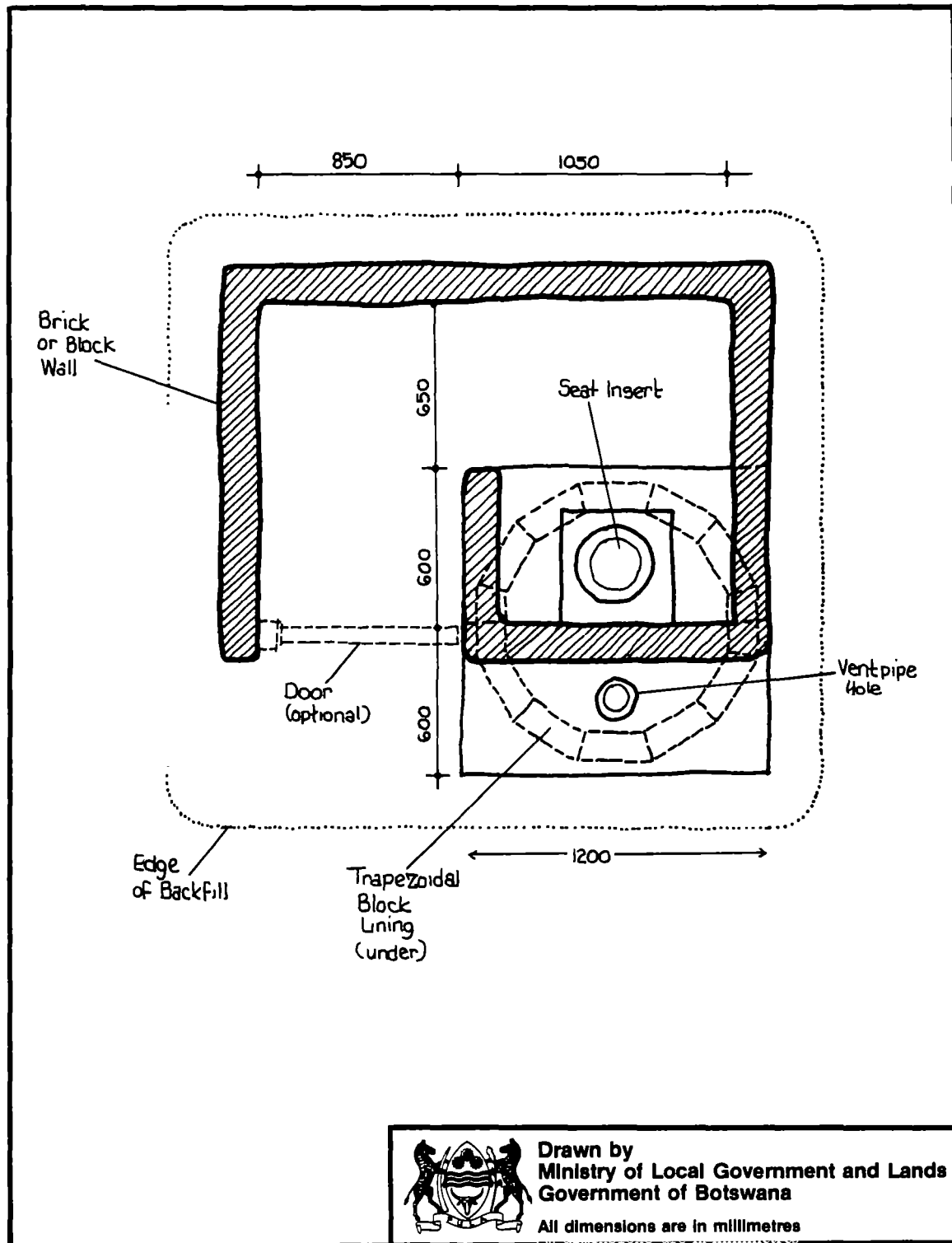

**Appendix IV
BOTVIP B2 — Plan
Circular Superstructure on Circular Substructure**

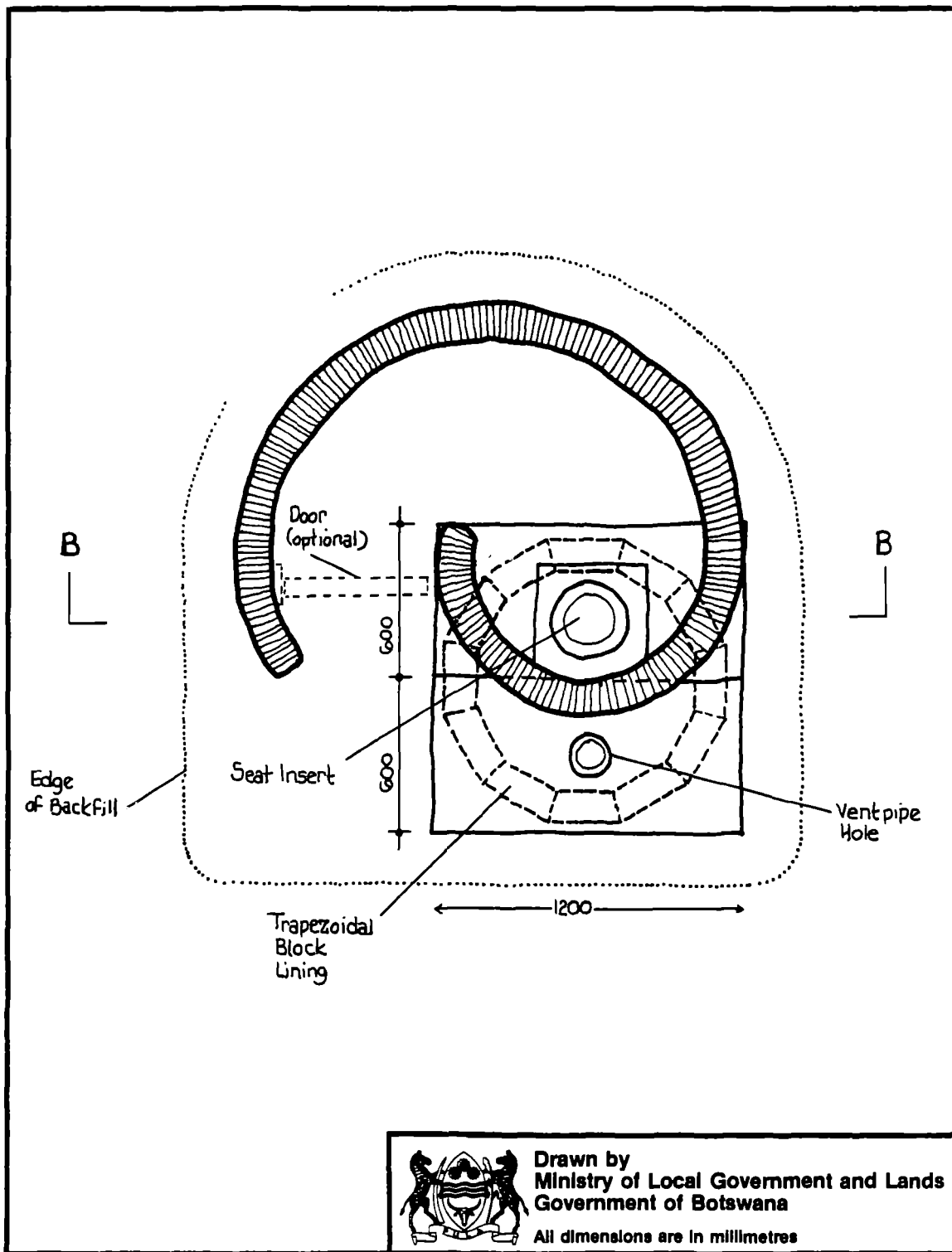

Appendix IV (cont'd)
BOTVIP B2 — Section B-B

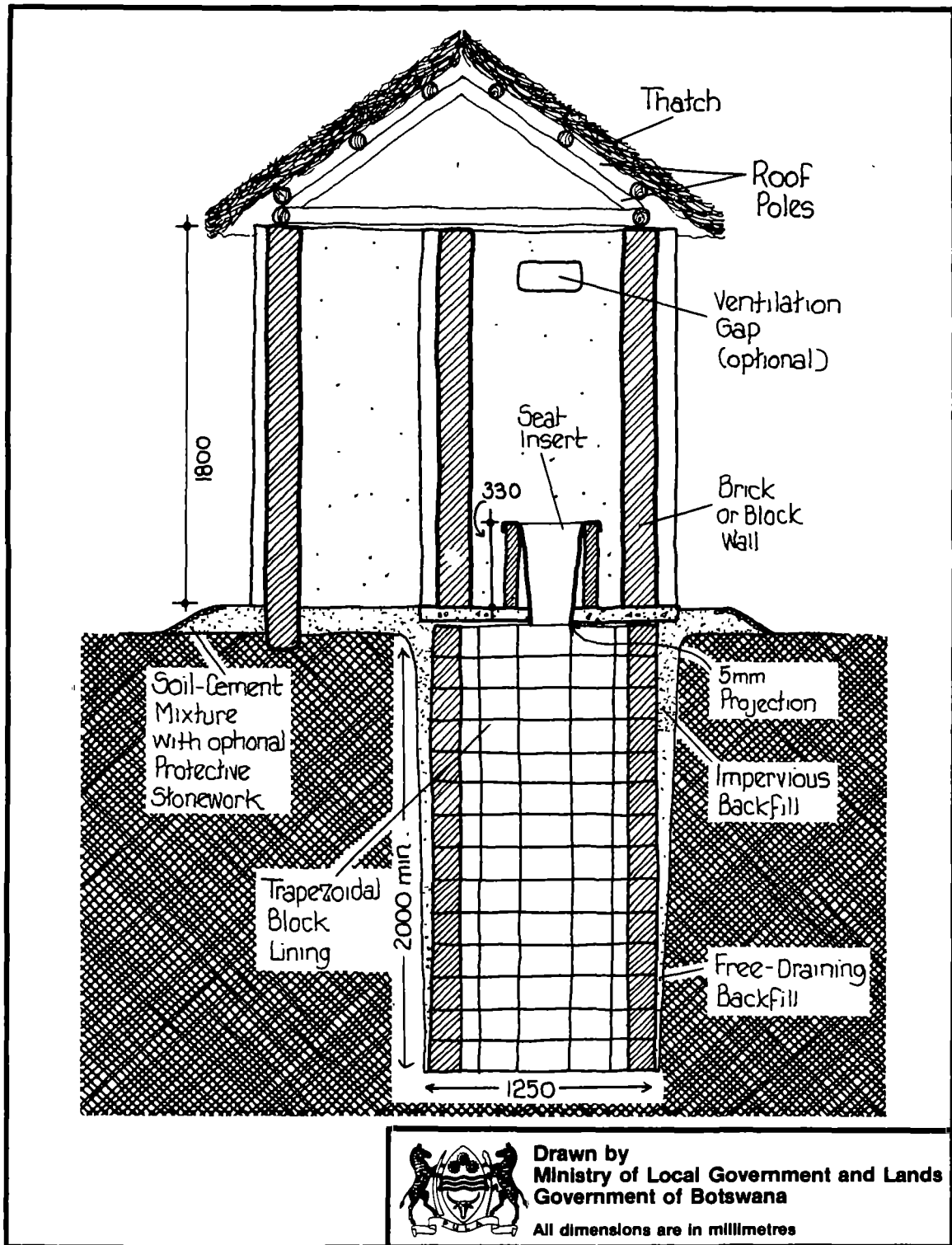

**Appendix V
Circular Substructure: Trapezoidal-Block Lining**

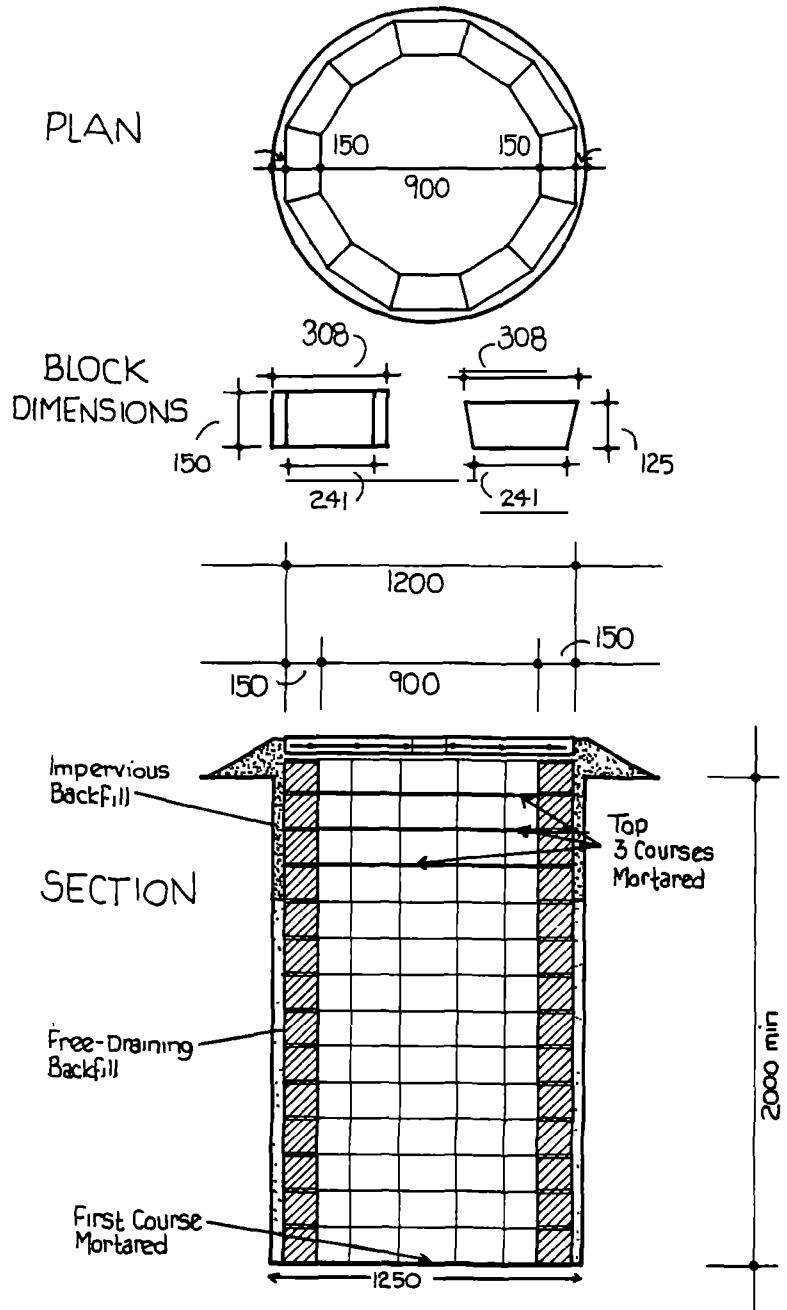

Drawn by
Ministry of Local Government and Lands
Government of Botswana

All dimensions are in millimetres

Appendix VI
Circular Substructure: Wire-Mesh-and-Filter-Fabric Lining

PLAN

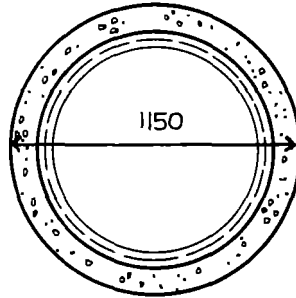

SECTION

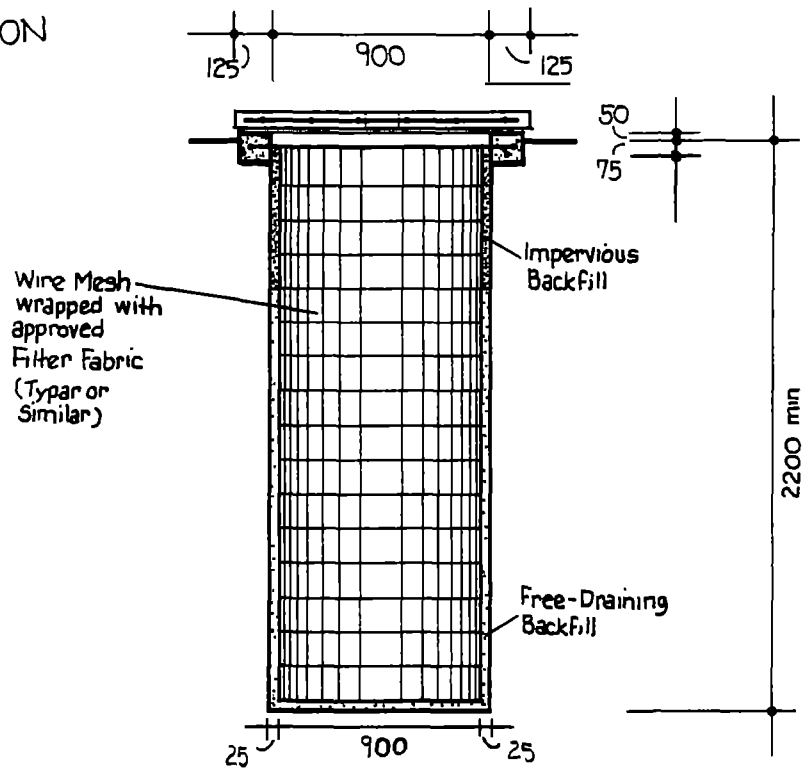

Drawn by
Ministry of Local Government and Lands
Government of Botswana

All dimensions are in millimetres

Appendix VII
Typical Rectangular Coverslabs — Types I and II

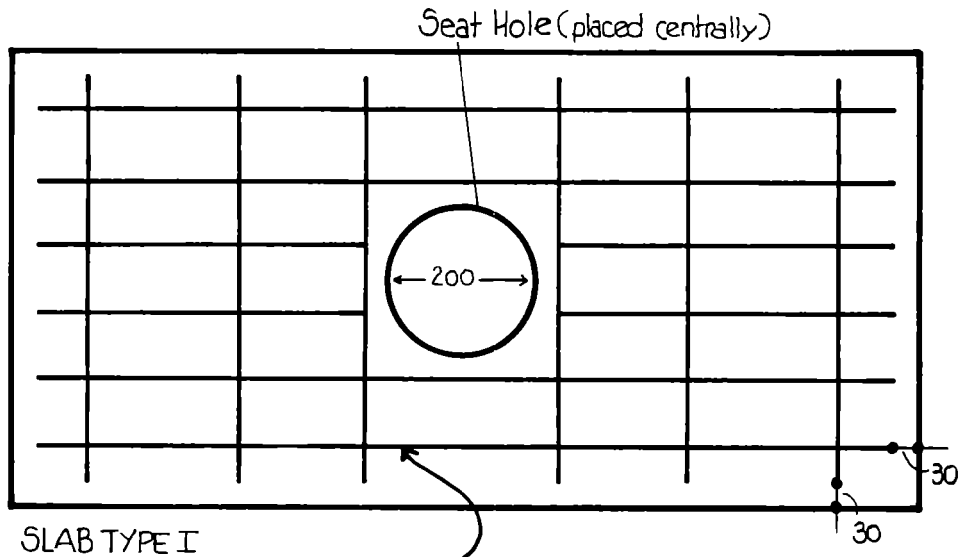

SLAB TYPE I

8mm Steel Mesh
or Reinforcing Bars Equally Spaced

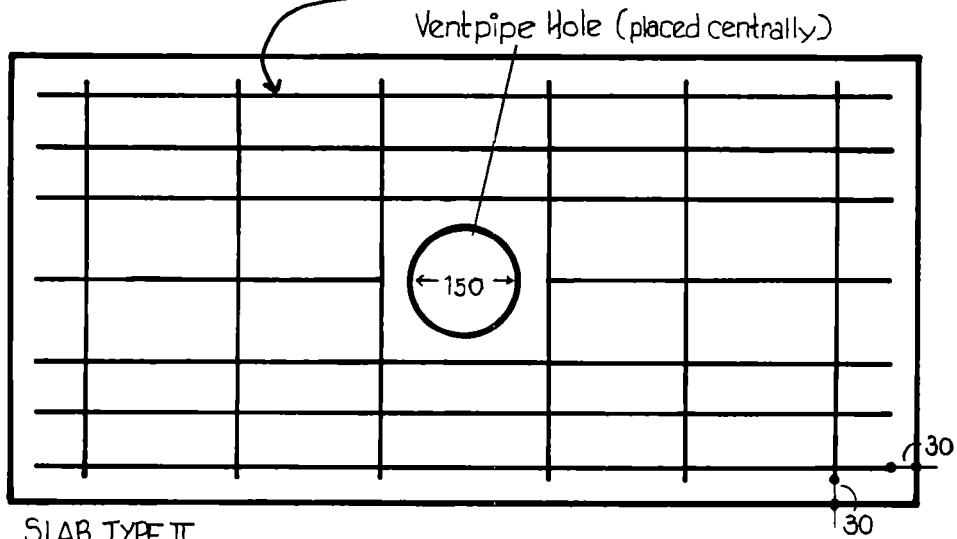

SLAB TYPE II



Drawn by
Ministry of Local Government and Lands
Government of Botswana

All dimensions are in millimetres

Appendix VII (cont'd)
Typical Rectangular Coverslabs — Type III

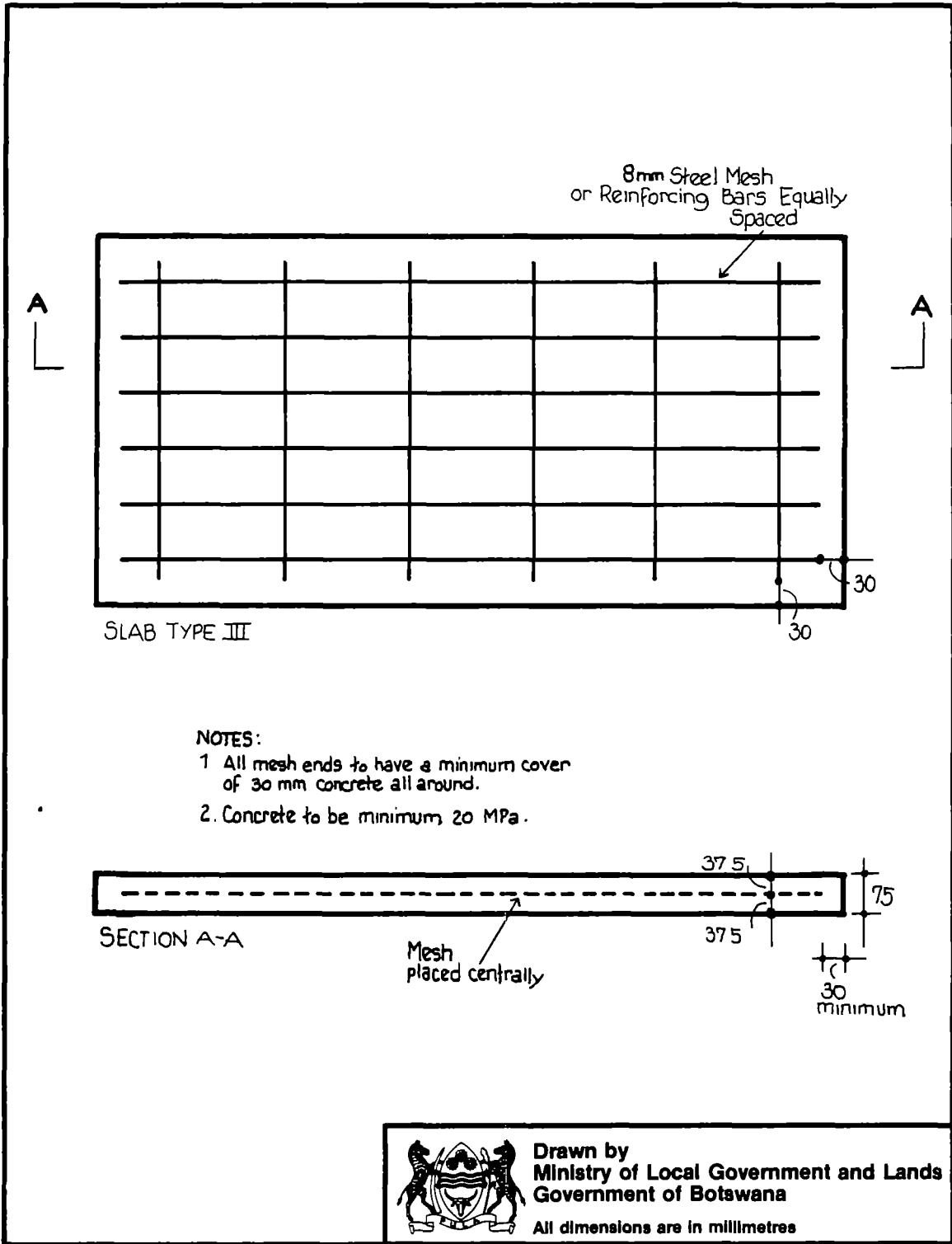

**Appendix VIII
Typical Circular Coverslabs**

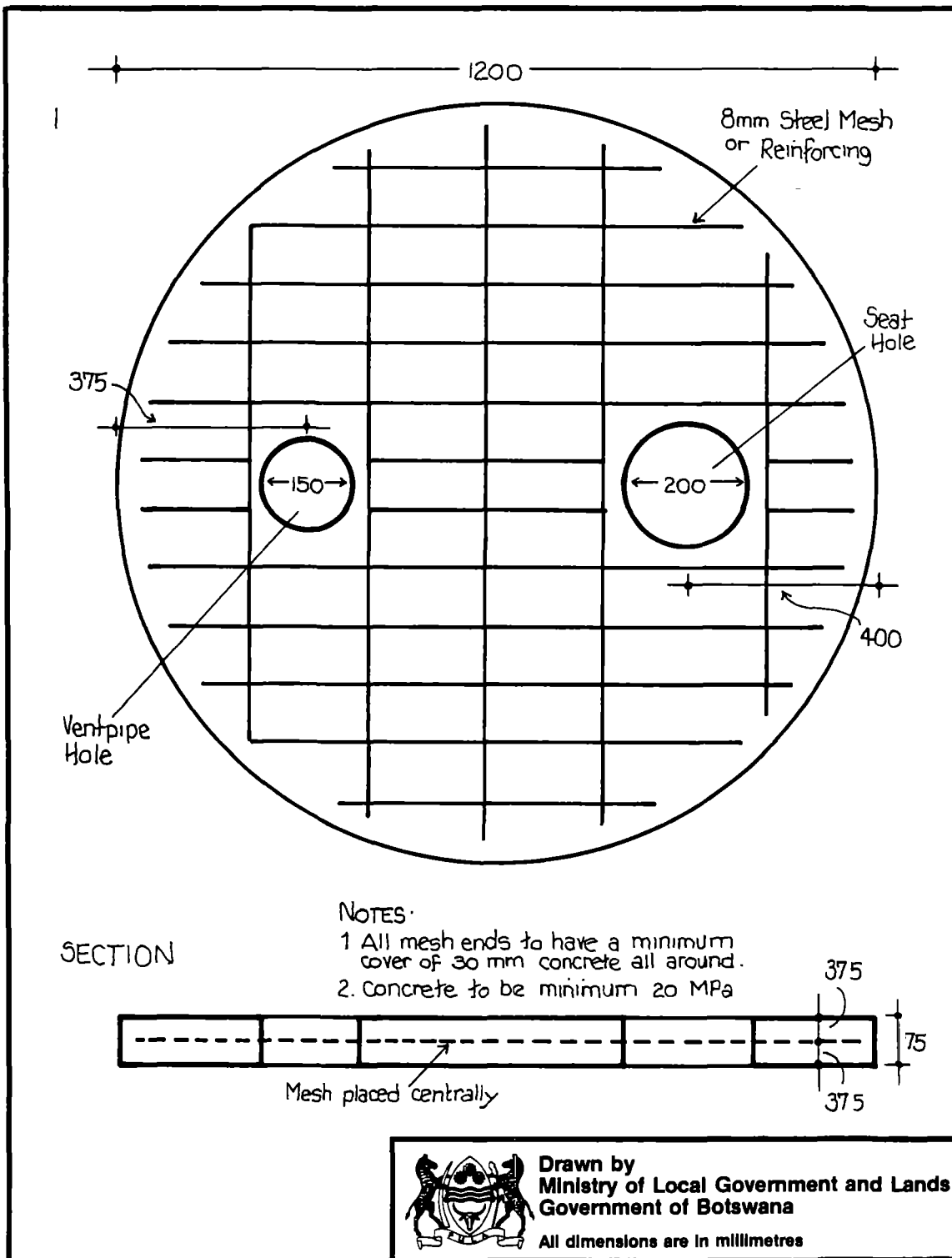

**Appendix IX
Seat Insert**

PLAN

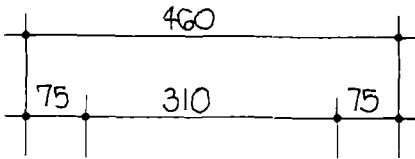
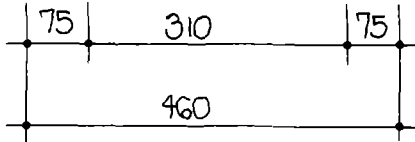
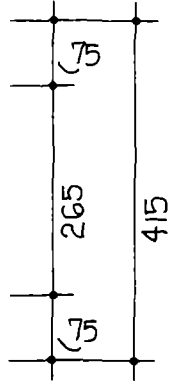
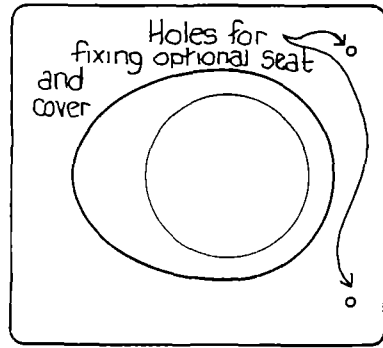

SECTION

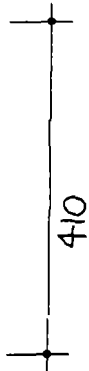
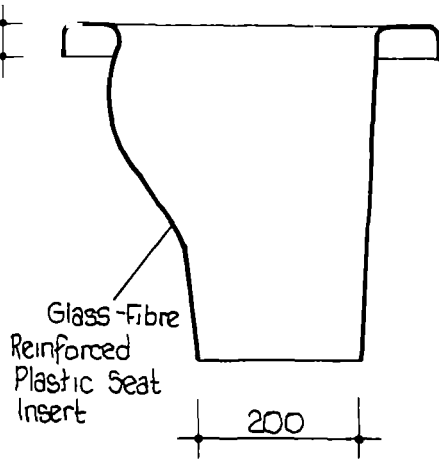
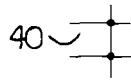

Drawn by
Ministry of Local Government and Lands
Government of Botswana

All dimensions are in millimetres

**Appendix X
Cement-Wash Hessian Ventpipe**

