

3 5 2 . 1

8 2 C O

Consolidation of information

Biogas Handbook

Pilot edition



General Information Programme and UNISIST

United Nations Educational,
Scientific and Cultural Organization

Paris,
November 1982

352.1 82C
4521

24/10/83
rechts treks Unesco

KD 4521

PGI-82/WS/19
PARIS, December 1982

352.1
82C0

CONSOLIDATION OF INFORMATION

Biogas Handbook

Pilot edition

Information
Tata Energy Research Institute

Prepared by
Miss A. Mazumdar
Tata Energy Research Institute

General Information Programme and UNISIST

United Nations Educational
Scientific and Cultural Organization

The present pilot edition is a photographic reproduction of the author's original manuscript prepared under a pilot project sponsored by the General Information Programme of UNESCO. The opinions expressed are not necessarily those of UNESCO or Tete Energy Research Institute and do not commit the organizations.

The Unesco Symposium on Information Analysis and Consolidation held in Colombo from 12 to 15 September 1978 recommended the establishment of pilot information consolidation units in selected priority areas and the distribution of their outputs for repackaging and adaptation for various categories of users.

In accordance with this recommendation, the Division of the General Information Programme of Unesco provided assistance to the Tata Energy Research Institute for the establishment of an information consolidation unit and for the preparation of information products consisting of evaluated, analyzed and consolidated information in three selected fields: biogas, windmills and cooking stoves.

At the end of Phase I of the Work Plan for 1980/81 agreed between Unesco and the Tata Energy Research Institute, the following pilot editions had been produced:

1. Biogas Handbook
2. Windpump Handbook
3. Cooking stoves Handbook
4. Review of the Literature on Promotion of Windpumps
5. Review of the Literature on Promotion of Biogas Systems

Phase II of the project involves the improvement of these pilot editions, their distribution and testing in the field, repackaging of the information for application by users at various levels and an evaluation of the results of the entire project at the end of 1983. In this context the opinions of the readers of these documents will be very useful. Comments should be addressed to:

Division of the General Information Programme
Unesco
75007 Paris

I N T R O D U C T I O N

The technology for the production of biogas, by anaerobic fermentation of organic materials which are abundant, low-cost and renewable in nature, is readily available. In fact, several thousand biogas plants are already in operation in many developing countries such as China, India, Thailand and others.

However, further widespread generation and use of biogas depend largely on the availability of inexpensive and appropriate plant designs, which could be constructed with locally available materials and skills. Also, it is important that financial institutions and national governments consider liberal fiscal incentives to make this technology attractive at the level of individual families as well as communities.

The present handbook explains the theory of biogas productions, factors affecting plant designs, and operation of plants. Details of several popular biogas plant designs, their construction, installation, operation and maintenance have been covered with appropriate illustrations. Designs of biogas utilisation devices and their operational requirements for use in lighting and cooking and as a fuel for prime movers have also been included. Further, the use of digested slurry as a source of organic fertilizer is discussed. Technical problems faced in the construction and operation of biogas plants and appliances have been identified along with the causes and known solutions.

The contents of this document have been evaluated by Dr. T.M. Paul and Mr M.A. Sathianathan.

CONTENTS

	Page No.
Introduction	i
Biogas Technology	1 - 8
What is Biogas ?	1
Mechanism of extraction	1
Methane production	2
Gas output	4
Plant Model	5
Pre-requisites for installation	5
Design considerations	6
Indian Expertise	9 - 38
IARI model	10
KVIC design	10
ASTRA contraption	26
SERC contrivance	27
Nightsoil input	29
Belur Math invention	30
Jwala biogas plant	32
Chinese Developments	39 - 65
Janata version	60
South Pacific Integrated Biogas System	66 - 69
Other Promising Designs	70 - 81
Bag digester	70
Modified of bag digester	77
Red Mud plastic digester	78
Maya Farms innovation	80
Biogas Utilisation	82 - 109
Properties	82
Utilisation devices	84
Burners and stoves	84
Lighting	98
Running I.C. engines	103
Pumping, cottage and agro-industries	108

	Page No.
Uses of Digested Sludge	110 - 116
As fertilizer	110
Slurry utilisation	112
Integrated systems	114
Health hazards	116
Tackling Technical Problems	117 - 128
Gas plant	117
Gas removing systems	118
Production	119
Operation	121
Storage	124
Utilisation	124
Do's and Don'ts	129 - 130
Biogas Vocabulary	131 - 133

LIST OF TABLES

<u>Table No.</u>	<u>Title</u>	<u>Page No.</u>
1.	Production of Biogas from Different Types of Raw Materials	4
2.	Composition of Biogas Produced from Cattle Dung and Night-Soil	5
3.	Quantity of Dung Required for Various Plant Sizes	7
4.	Material Requirement for 3 cu. m. KVIC Plant	14 - 15
5.	Material Requirement for Janata Biogas Plant	62
6.	RMP Generator Volume Requirement at 40°C	79
7.	Biogas Consumption for Various Purposes	83
8.	Calorific Value of Biogas	83
9.	Biogas Consumption Rate per Hour in Cubic Meters and Air Required for Operation of Different Types of Engines	106 - 107
10.	Biogas Consumption Per Hour for Handoperated Plastic Moulding Machine	108
11.	Amount of Nitrogen in Cow Dung	110

LIST OF FIGURES

<u>Figure No.</u>		
1.	IARI Biogas Plant	9
2.	KVIC Biogas Plant (Vertical Type)	11
3.	KVIC Biogas Plant (Horizontal Type)	11

<u>Figure No.</u>	<u>Title</u>	<u>Page No.</u>
4.	Plan of 3 m ³ KVIC Plant	16
5.	Digester Wall	17
6.	Position of Inlet and Outlet Pipes	19
7.	Gas Holder for 3 m ³ KVIC Plant	20
8.	Pipe connecting parts	21
9.	Joining of gas holder to gas pipe	21
10.	ASTRA Biogas Plant	27
11.	Nightsoil Biogas Plant	29
12.	Belur Math Gas Plant	31
13.	Jwala Line Diagram	32
14.	Jwala Biogas Plant	34
15.	Construction of Geodesic Dome	36
16.	Basic Design of a Chinese Biogas Unit	40
17.	Design of a Cast-in-Place Biogas Unit	44
18.	Casting of Dome According to Numbered Segments	45
19.	Excavating of Bottom According to Numbered Segments	46
20.	Design of an Excavated Biogas Unit with a Masonry Built Tank	47
21.	Use of Center Pole with Rope for Initial Laying out of Biogas Unit Excavation	48
22.	Overall Excavation with Cast Dome on a Bamboo Support	49
23.	Method of Building Dome with Bricks and Using a Pole for Maintaining Shape and Angle	50
24.	Design of a Biogas Unit Cut-in-Place in Primitive Soil	52
25.	Design of a Cut-in-Place Biogas Unit with a Cast Concrete Dome	53

<u>Figure No.</u>	<u>Title</u>	<u>Page No.</u>
26.	Janata Biogas Plant	61
27.	Brick Masonry Work	64
28.	A 300-gallon Concrete and Steel Digester	67
29.	Biogas Bag Digester	70
30.	Plan of the Pit for Bag Digester	72
31.	Drainage Channels	74
32.	Pressure in Biogas Bag Digester	75
33.	Water Traps	75
34.	The 5.6 m ³ All-Concrete-Digester	77
35.	Biogas Plant-Design (Maramba)	80
36.	Uses and Equivalentents of Biogas	84
37.	Biogas Burner (Watson type)	86
38.	A 50 mm Burner	88
39.	Gobar Gas Deluxe Burner (225/hr)	89
40.	Gobar Gas Deluxe Burner (450/hr)	89
41.	Gobar Gas Angitti Burner	89
42.	Gobar Gas Double Deluxe Burner	90
43.	Gobar Gas Double Deluxe Burner (Economy-Size)	90
44.	Fischer's Burner	92
45.	Adaptation of Wood-Burning Stove	92
46.	Shower-Head Burner	93
47.	L-Shaped Burner	93
48.	Hour-Glass-Shaped Burner	94
49.	Drum Burner	94
50.	Long-Arm-Burner	95

<u>Figure No.</u>	<u>Title</u>	<u>Page No.</u>
51.	Double-Ringed Burner	96
52.	The Biogas Stove	96
53.	Nepali Chulo	97
54.	Single-Mantle Lamps	99
55.	Double-Mantle Lamps (India)	100
56.	Biogas Table Lamp (Pakistan)	100
57.	Simple Biogas Lamp (China)	101
58.	Plan of Equipment Installation for Biogas Utilisation	103
59.	Diesel Engine Running on Dual Fuel	103
60.	Different Devices for Connecting Biogas Pipe to the Intake	104
61.	Carburettor ^{of} 10 bhp Petrol Engine Running on Biogas	105

BIOGAS TECHNOLOGY

What is Biogas ?

Biogas is a gaseous mixture of methane, carbon dioxide, hydrogen sulphide and several other gases, produced by anaerobic fermentation of organic material such as animal and human manure, leaves, twigs, grasses, industrial waste, etc. The presence of methane in biogas lends it the property of combustion which makes it suitable for cooking, lighting and powering prime movers.

Mechanism of extraction:

The fermentation process for formation of methane from cellulosic material through the agency of a group of organisms belonging to the family 'Methano bacteriaceae' is a complex biological and chemical process involving two main stages.

- Stage 1 : Bacteria break down complex organic materials, such as carbohydrates and chain molecules, fruit acid material, protein and fats. The disintegration produces acetic acid, lactic acid, propionic acid, butanoic acid, methanol, ethanol and butanol, as well as carbon dioxide, hydrogen, H₂S and other non-organic materials. In this stage the chief micro-organisms are ones that break down polymers, fats, proteins and fruit acids, and the main action is the butanoic fermentation of polymers.
- Stage 2 : The simple organic materials and carbon dioxide that have been produced are either oxidised or reduced to methane by micro-organisms, the chief ones being the methane-producing micro-organisms of which there are many varieties.

This stage may be represented by the following overall reaction :

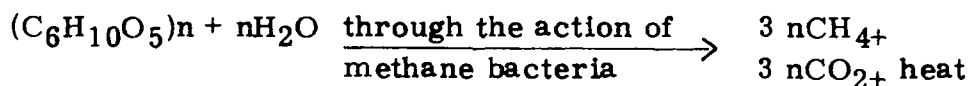

Individual reactions include :

- i. Acid breakdown into methane

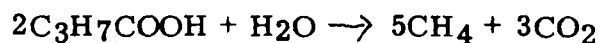

- ii. Oxidation of ethanol by CO_2 to produce methane and acetic acid.



- iii. Reduction with hydrogen of carbon dioxide to produce methane.

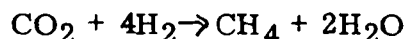

A careful balance should be maintained between the two stages. If the first stage proceeds at a much higher rate than the second, acid will accumulate and inhibit the fermentation in the second stage, slow it down and actually stop it.

Methane Production :

- Airtightness : Breakdown of organic materials in the presence of oxygen produces CO_2 and in the absence of it produces methane. Thus it is crucial to have the biogas pit airtight and watertight.
- Temperature : Temperature for fermentation will greatly affect biogas production. Depending on prevailing conditions methane can be produced within a fairly wide range of temperatures. However, the micro-organisms which take part in methane fermentation have the optimum activity at 35°C - 40°C . The production of biogas is fastest during summer and it decreases at lower temperatures during winter. Also methanogenic micro-organisms are very sensitive to temperature changes; a sudden change exceeding 3°C will affect production, therefore one must ensure relative stability of temperature.
- pH : The micro-organisms require a neutral or mildly alkaline environment - a too acidic or too alkaline environment will be detrimental. Ideal pH value is between 7.0 - 8.0 but can go up or down by a further 0.5. The pH value depends on the ratio of acidity and alkalinity and the carbon dioxide content in the biogas digester, the determining factor being the density of the acids. For the normal process of fermentation, the concentration of volatile acid measured by acetic acid should be below 2000 parts per million; too high a concentration will greatly inhibit the action of the methanogenic micro-organisms.

- Solid contents : Suitable solid contents of raw materials is 7-9%. Dilution should be in the ratio of 4:5 or in equal proportion.
- C/N ratio : A specific ratio of carbon to nitrogen must be maintained between 25:1 and 30:1. The ratio varies for different raw materials.
- Water content : This should be about 90% of the weight of the total contents. With too much water the rate of production per unit volume in the pit will fall, preventing optimum use of the digester. If the water content is too low, acetic acid will accumulate, inhibiting the fermentation process and hence production and also thick scum will be formed on the surface. The water content differs according to the raw material used for fermentation.
- Nature of organic materials : Materials rich in cellulose and hemi-cellulose with sufficient protenaceous substance produce more gas. Complex polysaccharides are more favourable for methane formation while only protenaceous materials produce little quantity of gas. Lignin as such does not contribute to the gas production.
- Supplementary nutrients : In case of cowdung, as it contains all the nutrients needed by organisms for the production of methane there is no necessity for addition of nutrients to it.
- Reaction period: Under optimum conditions 80-90% of total gas production is obtained within a period of 3-4 weeks. Size of the fermentation tank also decides the reaction period.
- Harmful materials : The micro-organisms that help to produce biogas are easily affected by many harmful materials. Maximum allowable concentrations of such harmful materials are as follows :

Sulphate (SO ₄ ⁻)	5000 parts per million
Sodium chloride (NaCl)	40,000 parts per million
Copper (Cu)	100 mg per litre
Chromium (Cr)	200 mg per litre
Nickel (Ni)	200-500 mg per litre
Cyanide (CN ⁻)	below 25 mg per litre

ABS (detergent compound)	20-40 parts per million
Ammonia (NH ₃)	1,500-3,000 mg per litre
Sodium (Na)	3,500-5,500 mg per litre
Potassium (K)	2,500-4,500 mg per litre
Calcium (Ca)	2,500-4,500 mg per litre
Magnesium (Mg)	1,000-1,500 mg per litre

These toxic material should either not be present or their concentration should be diluted, for example by addition of water.

Gas output :

The exact amount of gas produced depends on various factors. In the first instance the amount of animal droppings vary from animal to animal, feed given to the animal, season of the year, whether the animal is stable-bound or a free-grazing type etc. The following table gives an idea of the amount of gas available from different types of raw material. The figures however are likely to vary very widely.

Table 1

Production of biogas from different types of raw material :

Material	Amount of gas (m ³ /kg of fresh material)	
	Winter	Summer
Cattle dung	0.036	0.092
Night-soil	-	0.04
Pig dung	0.07	0.10
Poultry droppings	0.07	0.16

The composition of the gas produced again varies with the material used for fermentation. This is tabulated below.

Table 2

Composition of biogas produced from cattle dung and night soil :

Material	Composition of the gas (percentage)		
	Methane	Carbon dioxide	Hydrogen sulphide etc.
Cattle dung	55-60%	40-45%	negligible
Night-soil	65%	34%	H ₂ S 0.6%; other gases 0.4%.

Plant Model :

This is a composite unit of a digester and gas holder wherein the gas is collected and delivered at a constant pressure to gas appliances through a distribution system.

Depending on the amount of raw material to be handled, the digester may be of either a single-chamber or a double-chamber type.

There are two types of processes for anaerobic fermentation : Continuous and batch. The continuous process is suitable for free-flowing suspended materials while the batch process is applicable to light materials. The process is continuous in the sense that as the material to be fermented is charged into the fermentation tank, the same volume of the fermented material overflows from it.

Prerequisites for installation :

- Four-five animals, preferably stable-bound for a 2 m³ gas/day plant.
- Minimum 45 kgs of dung for a plant producing 2 m³ gas daily.
- Sufficient space for constructing the plant and for location of pits for outlet slurry.
- Space must be close to the source of raw material.
- Distance between the plant and the kitchen should be within 20 meters in the case of small plants.

- Space provided should be free from any intrusion of trees which may creep into the digester and cause damage.
- Space should be in the sun and away from low-lying areas.
- Location should be away from drinking water well.

Design considerations :

- Availability of building materials - stone, brick masonry, concrete, steel, plastic, etc.
- Level of water-table - special designs are available for high water-table areas.
- Input material to be used - raw materials include cattle dung and other animal excreta, including piggery wastes, poultry droppings, etc., human excreta, agricultural wastes such as straw, leaves, algae, bagasse, aquatic weeds, industrial wastes such as distillery sludge, wastes from tanneries, food industries, paper mills, etc.

The majority of plants are designed to work on either pig or cattle dung, a few for chicken dung or human faeces or a combination of different types of dung. The mode of feeding too changes, depending on type of material. For example, plants using vegetable matter need to be cleaned and refilled at least once or twice a year and thus operate on a batch mode basis.

Purpose for which the plant is required :

If the gas is used exclusively for :

- cooking, then the height of the gas holder is usually one-third the depth of the digester since it never has to hold more gas than for three or four hours use at a time;
 - lighting, for which the gas holder must be large enough to hold all the gas generated in 24 hours to be able to deliver it in 4 or 5 hours;
 - for other applications such as for running refrigerator, incubators, engines, etc., then the gas holder must have at least half of the digester volume.
- Amount of fertilizer expected from the gas plant :
- About 70% of the total solids put in can be expected to come out, and processing does not change the form or quantity of nutrients present.

- Amount of dung that can be collected per animal, bird or human which depends on the diet and size of the animal, degree of confinement, etc.
- Size of the plant: The average villager uses about 0.42 cu. m. of gas per day. The volume of fresh dung (D) available every day multiplied by 80 gives the volume of the digester (P) most suitable to handle that amount of dung.

$$D \times 80 = P$$

Pit volume divided by 2 gives the volume of gas generated daily (at 30°C). $P/2 = G$.

The volume of gas divided by amount of gas required by each person gives the number of persons served. This formula is correct if the slurry is made in the proportion of 1:1. The total daily input of slurry, regardless of its proportions, should be 1/40 of the pit volume.

The following table gives an estimate of the quantity of dung required for various plant sizes.

Table 3
Quantity of dung required for various plant sizes :

Size of plant (gas production/ day) (m ³)	Amount of wet dung required (kg)	No. of animals
2	35 - 40	2 - 3
3	45 - 50	3 - 4
4	55 - 60	4 - 6
6	80 - 100	6 - 10
8	120 - 150	12 - 15
10	160 - 200	16 - 20

References :

1. Biswas, D.K. "Towards better design of biogas plants for fuel and fertilizer." Bhagirath, Vol.22, Oct.1975, p.140-145.
2. Biswas, T.D. "Biogas plants: prospects and limitations." Invention Intelligence, Jan-Feb 1977, p.71-78.
3. Buren, Arian Van Ed. Chinese biogas manual. London, Intermediate Technology Publications, 1979, p.20-24.
4. Khandelwal, K.C. Gobar gas plant for you. New Delhi, Ministry of Agriculture and Irrigation, January 1978, p.3.
5. Saubolle, Bertrand R.S.J. Fuel gas from cowdung. Kathmandu, UNICEF, n.d., p.7-8.
6. United Nations, Economic and Social Commission for Asia and the Pacific. Guidebook on biogas development. New York, United Nations, 1980, p.95-98.

INDIAN EXPERTISE

The most common biogas plant design in operation in India today and being widely propagated by the Khadi and Village Industries Commission (KVIC), is popularly known as the KVIC plant. Gas plants of similar design with slight modifications such as the Belur Math plant, night-soil biogas plant of National Environmental Engineering Research Institute are also working satisfactorily. However, the first pilot gas plant for producing methane from cattle dung and other cellulosic organic materials was first designed by S.V. Desai and set up at the Indian Agricultural Research Institute (IARI), New Delhi, during 1941-42.

IARI MODEL

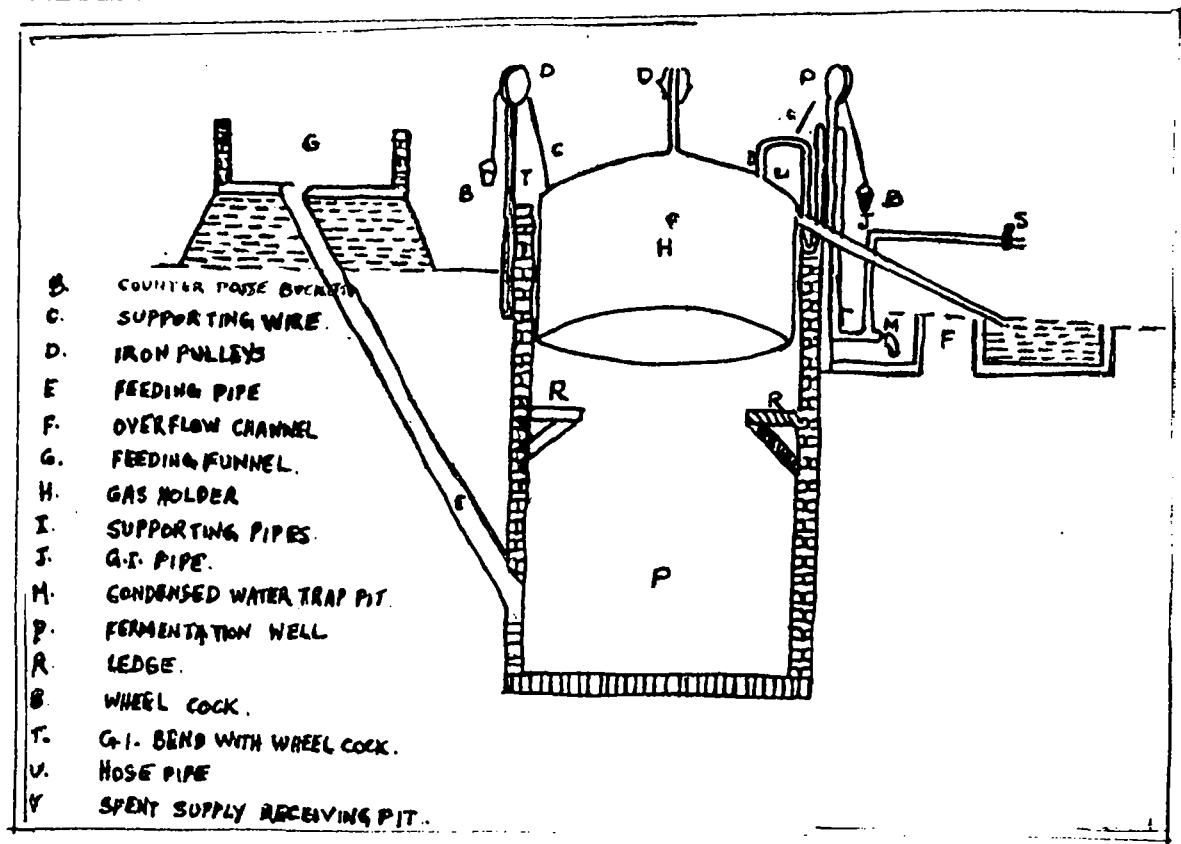

Fig. 1: IARI Biogas Plant

Description : (Ref. 1, 2, 3, 5)

The present village model biogas plant at the IARI consists of a digester which is a brick-lined slurry wall of dimensions 3.66 m in depth and 1.68 m in diameter with a floating mild steel drum, 1.5 m in diameter and 1.2 m in height, introduced upside down into it. The drum acts as a gas holder which rises up and floats upward when gas accumulates. In order to hold the gas holder in proper position and to balance its weight counterpoise buckets with a wire pulley system are also provided. Feeding is done through a funnel-shaped inlet pipe. Gas is let out for use through an opening in the top.

A small brick-lined pipe 30 cm x 30 cm x 30 cm just outside the well serves as a water catchment to remove the condensed moisture from the gas pipe.

These plants are available in sizes ranging from 3 m³-9 m³ in terms of the gas produced per day.

KVIC DESIGN

The KVIC (Khadi and Village Industries Commission, Bombay) design, based on the model originally designed by J. J. Patel in 1951, consists of the digester and gas holder combined in one unit.

There are two types of gas plants - vertical and horizontal - depending on the site of construction of the gas plants. These plants are available in sizes ranging from 3 m³ - 15 m³, 25 m³, 35 m³, 45 m³, 60 m³, 80 m³, 112 m³ in terms of gas produced per day.

Description: (Ref. 4, 5, 7)

- Digester : This is an underground masonry tank, the depth of which varies between 3.5 m - 6 m, according to the capacity of the plant. The digester of a small plant may be without a partition. However, it is advantageous to have a partition in bigger plants so that the digester may be used as two-stage digester.

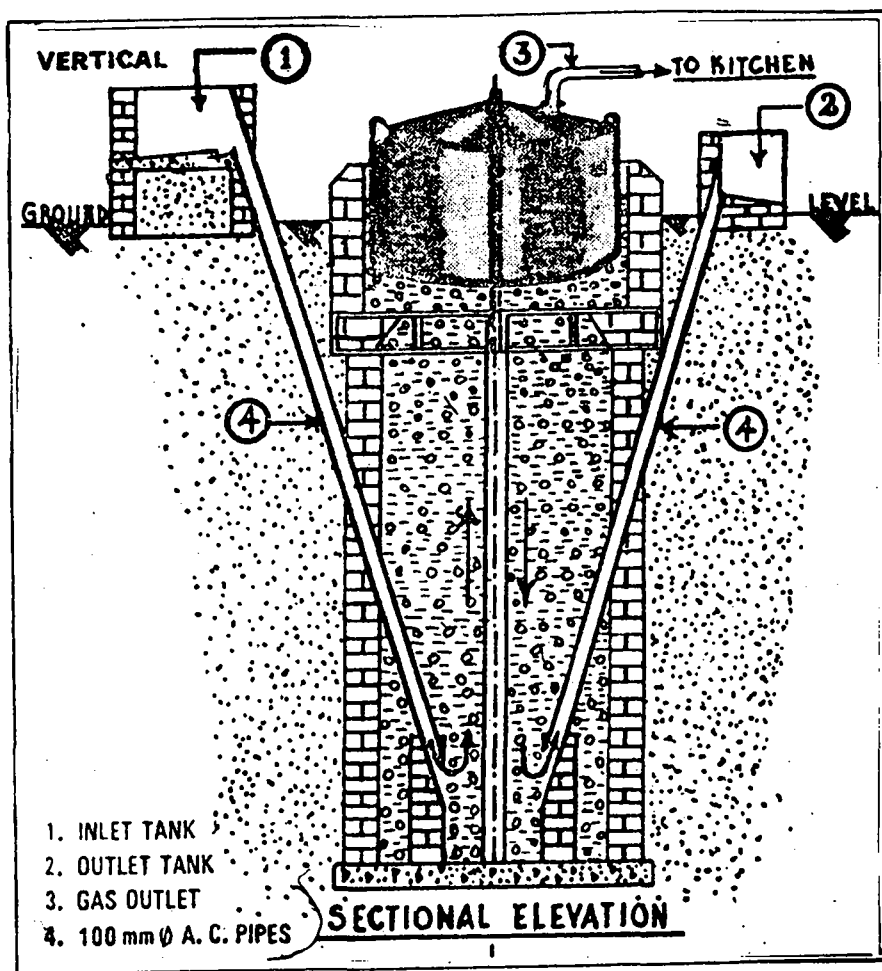

Fig. 2: KVIC Biogas Plant (Vertical Type)

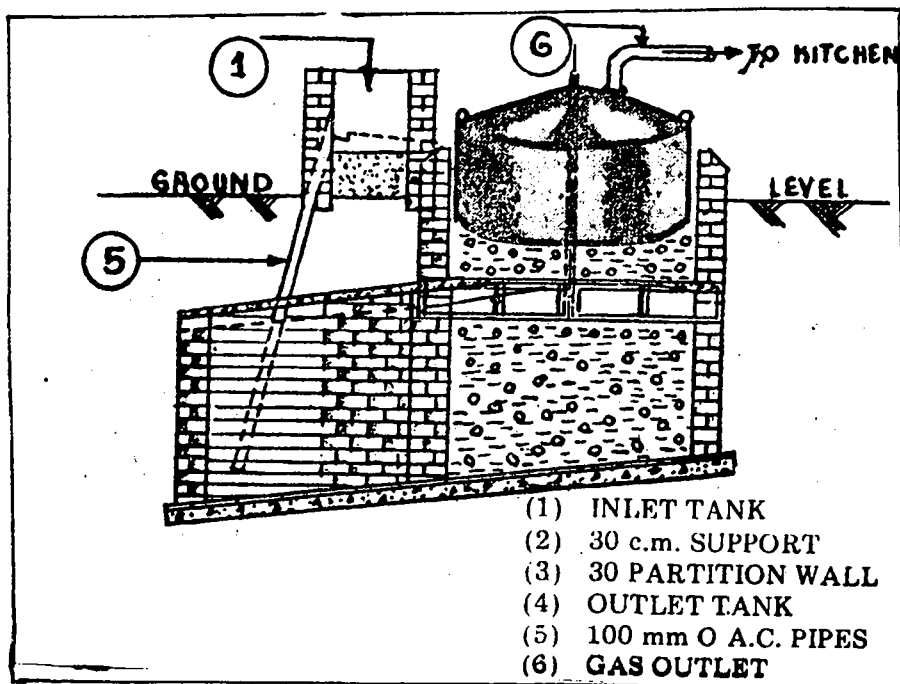

Fig 3: KVIC Biogas Plant (Horizontal Type)

Gas holder : This is a balancing tank for continuously receiving the gas produced in the digester and delivering it at a predetermined pressure to points of use, when required and also acts as a cover of the digester. It fits like a cap on the mouth of the well where it dips in the slurry and rests on a ledge constructed in the well for this purpose.

The drum rises as the gas is collected in it, and in its up-and-down movement, it is guided by a central guide pipe fitted in a frame which is fixed in masonry work. This arrangement allows the gas holder to rotate and break any semi-dried matt formed on the surface of the unstirred slurry in the digester and thus proved to be better than the earlier arrangement of having pulleys which got rusted and clogged, thus preventing the gas-holder from proper functioning.

- Inlet and outlet pipes : These are two slanting cement pipes reaching the bottom of the digester well on either side of the partition wall and have their opening on the surface in the inlet and outlet tanks.
- Mixing tank : This is a tank to mix cowdung and water and also serves as the inlet tank.
- Gas mains : To lead the gas to the kitchen or to light gas lamps within a distance of about 10 m a galvanized iron pipe of 1.2 cm - 1.9 cm diameter is usually used.

Construction details :

- Selection of site : Site selection is an important aspect to be considered prior to the actual construction of the plant.

Site should be -

- nearer to the kitchen to avoid costly pipeline;
- nearer to the cattle-shed to minimise transportation cost of cattle-dung;
- **away** from any existing well to avoid any pollution of well water;
- an open space to get full sunlight;
- away from trees to avoid roof damage.

Selection of size of biogas plant :

The basic parameters to be considered for designing gas plants of different capacities are :

- estimated production of gas per kilogram of fresh cattle-dung is assumed to be 0.036 m^3 ;
- dilution ratio of the media is 7-8% solid matter, i. e. 1:1.25 proportion of cattle-dung and water by volume;
- retention period is 30-50 days for different organic wastes and climatic conditions;
- delivery pressure is 10 cm water column;
- gas consumption is assumed to be 0.2 cu m per day per person;
- capacity of gas-holder has been fixed at 50-60% of the production of gas per day to suit the cooking requirement;
- capacity utilization in full.

Selection of type of gas plant : This is ascertained on the basis of the water table and sub-soil conditions.

Vertical type of plants can be installed in a place where the digester pit can be excavated to more than 3 m without blasting.

Horizontal plants are suitable in areas with hard rock and high water-table.

Materials used for construction :

The most commonly used materials for construction of KVIC plants are : cement, bricks, mild steel sheets and angles, stone chips, 1:2:4 cement concrete, etc.

Material requirement for a 3 cu.m. KVIC Plant is given in Table 4

Table 4 : Material Requirement for 3 cu. m. KVIC Plant

Materials	Quantity
<u>Vertical Plant</u>	
<u>For digester :</u>	
Bricks	2900 Nos.
Sand	2.8 m ³
Stone chips (2 cms.)	0.7 m ³
Stone chips (1.4 cm.)	
Cement	15 bags
A.C. Pipe (10.2 cms. dia.)	19 Rft
M.S. Rods (1.4 cms. dia.) (0.97 cms. dia.)	Required by horizontal plants only
<u>For Central guide frame :</u>	
3.2 cms. x 3.2 cms. x 0.6 cms. Angle iron	9 Rft
5.1 cms. dia. G.I. or M.S. pipe	6 Rft
22.2 cms. x 22.2 cms. x 0.6 cms. thick plates	2 Nos.
1.4 cms. x 3.2 cms. long bolts with nuts	16 Nos.
<u>Gas Holder :</u>	
3.2 cms. x 3.2 cms. x 0.6 cms. Angle iron	65 Rft
M.S. or G.I. or W.I. pipe (7.8 cms. dia.)	1.05 m
22.2 cms. and 3.2 cms. thick flange plates	9 Nos.
Flats 3.9 cms. x 0.6 cms.	12 Rft

Table contd. overleaf

Table 4 (Contd.)

Materials	Quantity
Vertical Plant	
Gas outlet pipe flange 2.5 cms. dia.	1 No.
G.I. Bend 2.5 cms. dia.	1 No.
Heavy duty gate valve 2.5 cms. dia.	1 No.
Nipple 2.5 cms. dia.	
Coping or socket 2.5 cms. dia.	1 No.
3 m, 2.5 cms. reinforced rubber pipe with 2.5 cms. adapters and rubber wastes at both ends	1 No.
12 gauge M.S. sheets (1.2 m x 1.8 m)	3 Nos.

Note : For the horizontal-type gas plant materials requirement is almost similar to that of the vertical plant. However, it requires about 20 bags of cement against 15 bags required by the vertical plant.

- Details of Construction :

Plan of the plant (See Fig. 4)

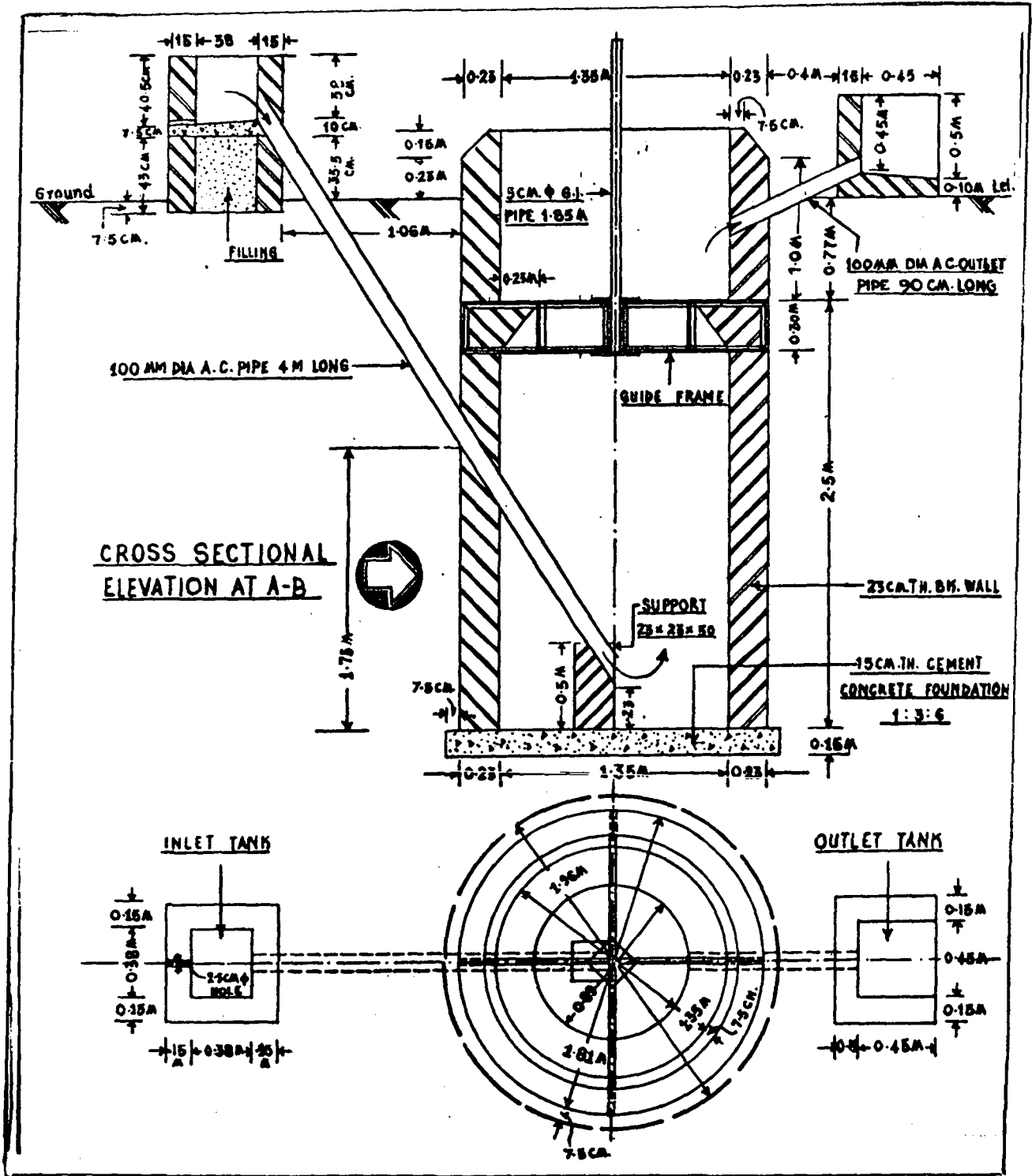

Fig. 4: Plan of 3 cu. m. KVIC plant

Digester : It is built underground with the top only about 22 cms. above the ground to facilitate feeding.

Size of the digester is governed by total gas required in 24 hours (4.8 m deep digesters are advocated). In places with hard rock and high water table horizontal digesters having the same volume as the vertical plants but with a decrease in height and increase in horizontal portion by R.C.C. slabs is used. The floor level and roof of the horizontal portion are constructed sloping towards the gas holder as this helps the easy movement of gas bubbles and slurry.

While constructing masonry well, care should be taken to properly fill up the portion of the pit outside the wall with the material previously dug out and rammed, using water after every 30 cms. of the wall. The digester wall must have a firm backing as seen in Fig. 5.

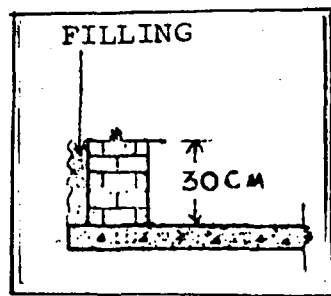

Fig. 5: Digester Wall

A partition wall is built in the middle of the digester, dividing it into two semi-circular compartments. The wall stops slightly below the top of the well, thus remaining submerged in the slurry.

The lower end of the feed pipe and discharge pipe open 30 cms. above the bottom and in the centre of the compartment. Also, the upper opening of the feed pipe should be between 30 cms. and 45 cms. above the top of the digester wall. The lower portion of the digester pipe opening in the discharge tank should be 7.5 cms. below the top of the digester wall. (See Fig. 6)

Digester slurry is discharged in a recess of about 7 cms depth and 14 cms width in the digester.

Gas holder: Size of the gas holder is dependent on the hours of use of the gas and whether the use is continuous or intermittent. In the case of family gas plants 50-55% of the day's production capacity is taken as the volume of the gas holder. (See Fig. 7)

In most small plants gas holders having 1.5 m diameter are built with 16 gauge M.S. sheet or G.I. sheet. Such gas holders exert a pressure of about 6 cms. water column which decreases to 2.5-4 cms. when the gas holder is counter-weighted. By using a 14-gauge sheet and decreasing the diameter to 4 feet and avoiding the counter-weights pressure can be increased to 9 cms.

The height of the gas holder should not exceed 1.2 m since the deeper the gas holder, the greater is the likelihood of it getting stuck and damaging the wall of the digester. Also the higher the gas holder the greater is the pressure of wind on it. The pressure on the gas, too, may be more than required and careful counterweighting will be required to regulate the pressure.

Length of the central guide pipe should always be $1\frac{1}{2}$ times the height of the gas holder, never more, as measured from its base and must always be in true vertical position in relation to the base. The guide pipe engages a little bigger diameter pipe welded into the centre of the gas holder throughout its height.

Inlet and outlet pipes : The inlet pipe should be of cement asbestos of about 9.5 cms. internal diameter, the lower end of the pipe opening in the centre of the digester (as discussed above). The upper end of the pipe opens on one side of the bottom of the mixing tank. The outlet pipe is at a distance from the bottom of the digester, depending on its size.

Mixing tank : It usually has the dimension of 75 cms. x 75 cms. x 45 cms. and is kept about 15 cms. -22.5 cms. higher than the top of the digester. A cover over the mixing tank is useful, especially in winter, to prevent loss of temperature.

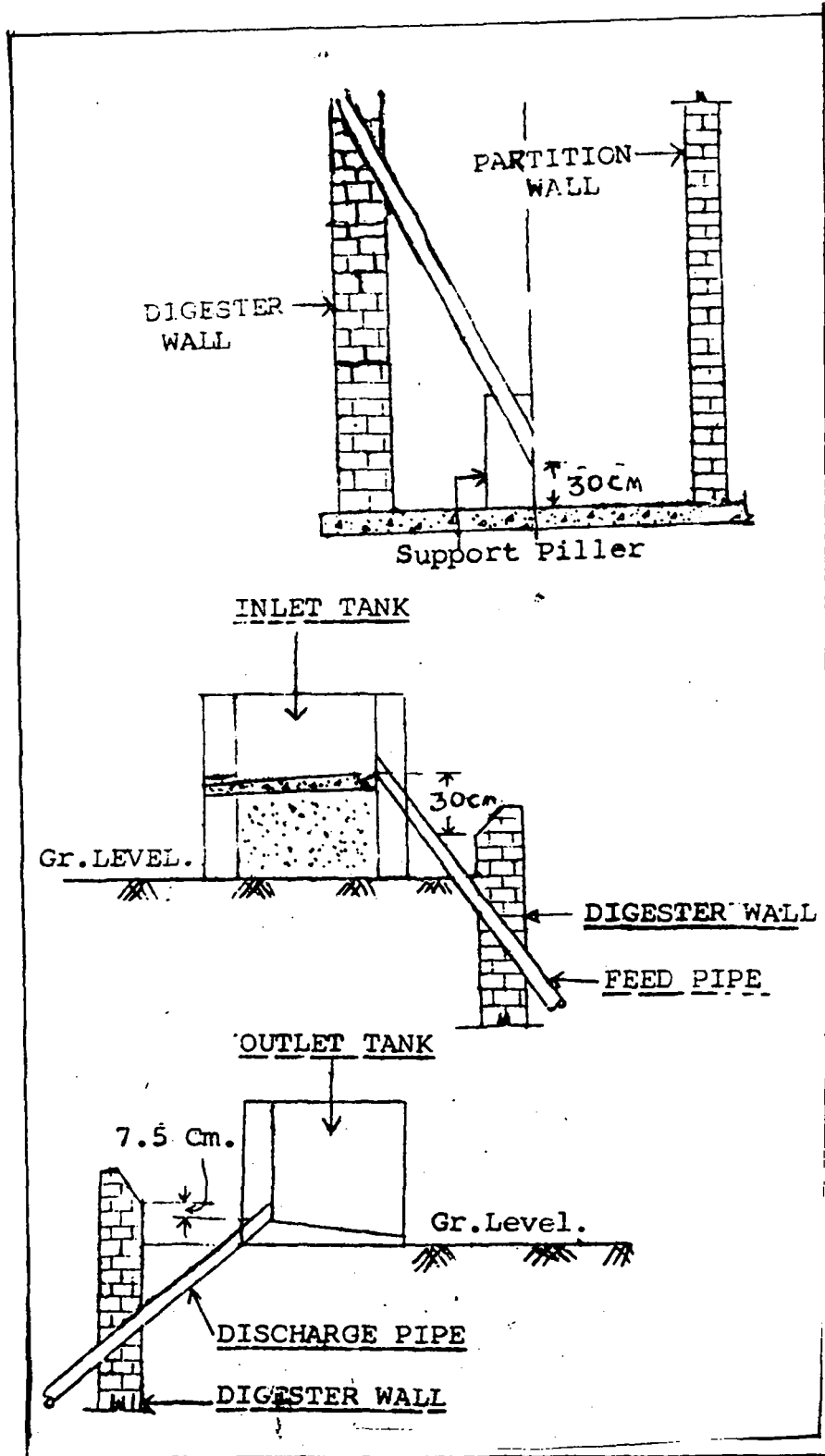

Fig. 6: Position of Inlet and Outlet Pipes

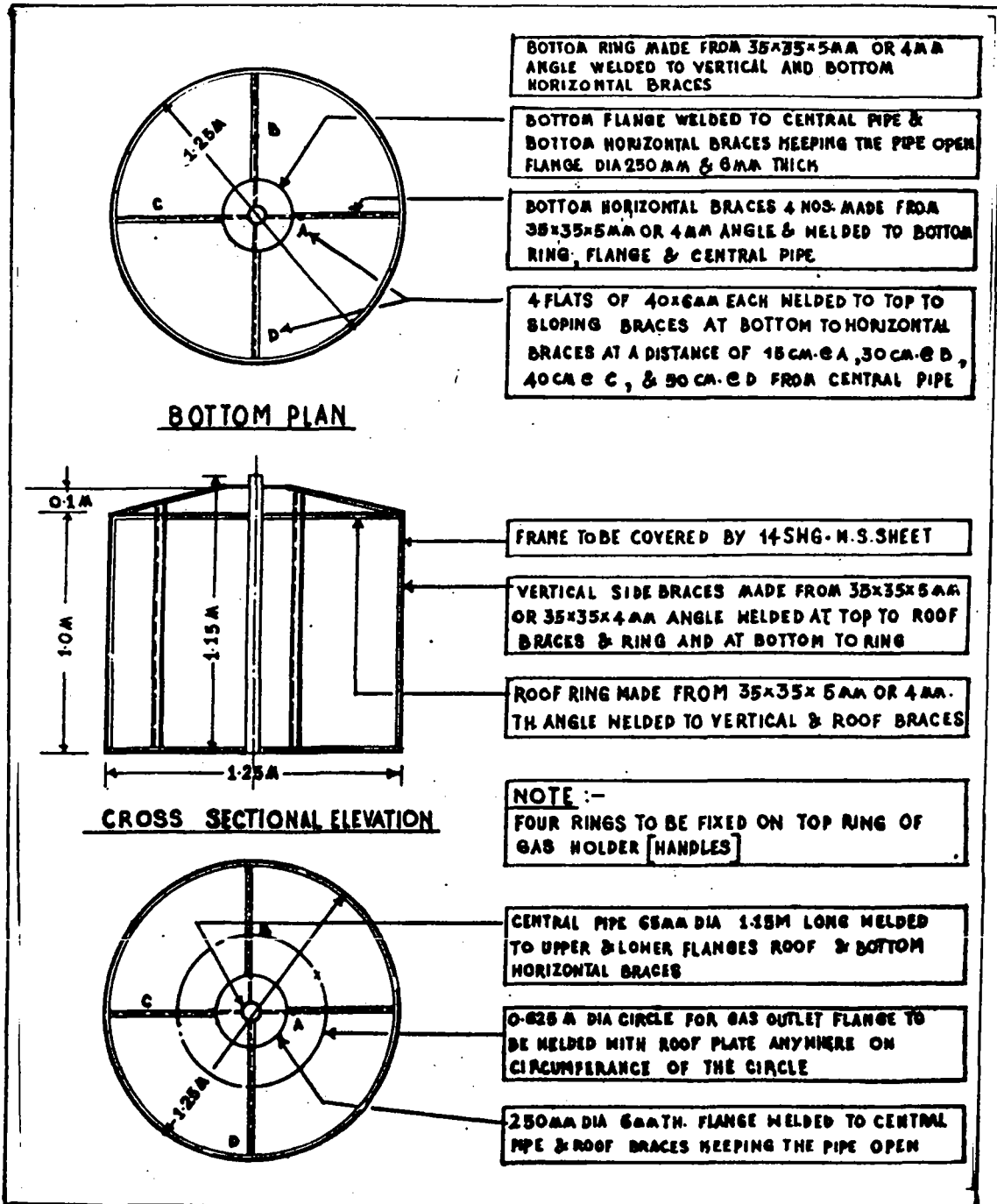

Fig. 7: Gas Holder for 3 cu. m. KVIC Plant

Gas Mains : The gas carrying pipe should be 2-5 cms. in internal diameter for domestic purposes. Where the distance between the gas plant and the point of use is more than 24 m it should be as follows :

<u>Distance</u>	<u>Internal diameter</u>
24 m - 36 m	3.0 cms.
36 m - 66 m	3.5 cms.
Above 66 m	5.0 cms.

Method of connecting the gas pipe to gas holder : (See Fig. 9)

Gas tapping is best done from the top of the gas holder. A 2 cm. band is screwed into a flange welded anywhere on the circular line midway between the centre and the periphery of the gas holder.

The gas main starts just above this opening facing the bend in the horizontal plane at a height of 1.12 meters.

The main valve is best fitted on the gas holder on either one or the other end of the bend. A 2.4 m non-collapsible rubber hose (of 2.5 cm internal diameter) is inserted on the free end of the bend or a nipple connected to it at the lower end. It is then taken round the centre to form just one circular loop and the upper end is inserted into the horizontally placed end of the gas main, in such a way that it does not touch anywhere else in any position of the gas holder. Such a joint of the rubber is essential for its long life (See Fig. 8).

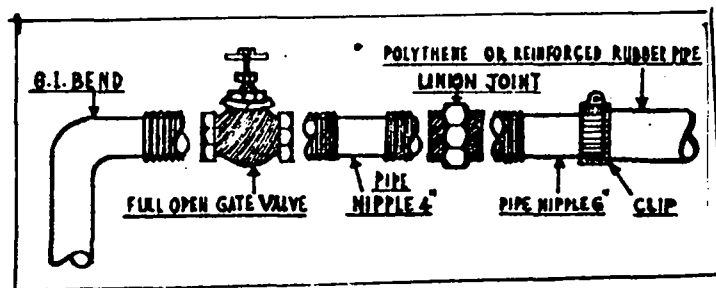

Fig. 8: Pipe Connecting Parts

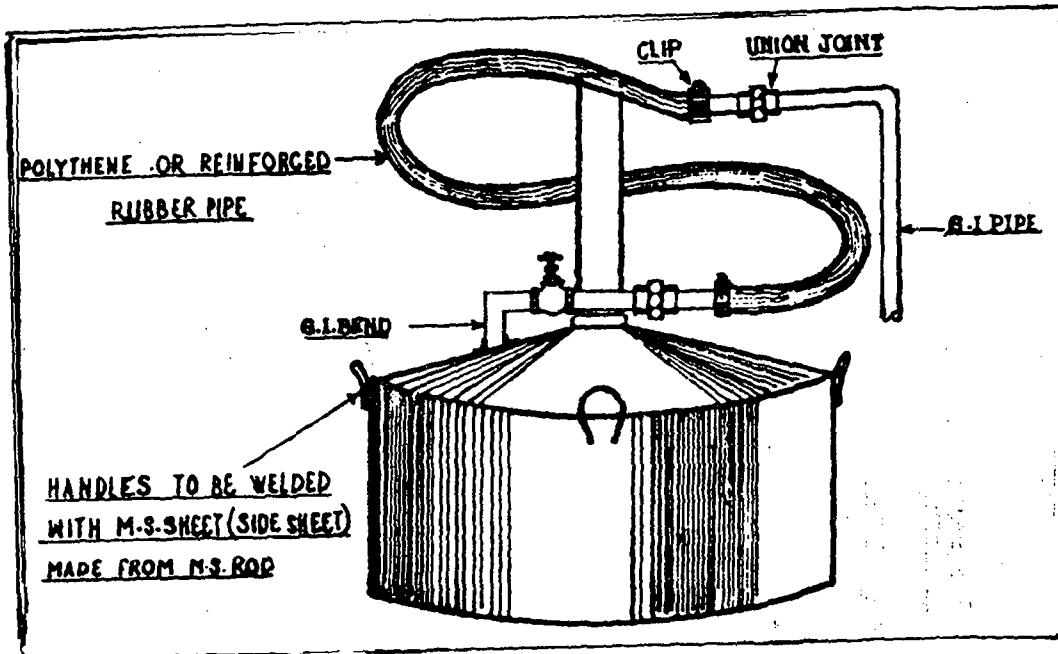

Fig. 9: Joining of Gas Holder to Gas Pipe

The flexible pipe connecting the gas holder with the gas carrying pipe should be a 5 ply rubber hose. Plastic pipes should not be used as they are likely to bend and cause accumulation of water.

The length of the rubber hose should not be more than 3 m and it should connect with the gas supply pipe fixed at a level slightly higher than the highest position to which the gas holder rises.

The main supply pipe will then proceed to the kitchen along the ground, care being taken to provide water removal plug at the lowest point. If the situation permits, it may proceed at the high level to the kitchen. In any case the pipe should not be exactly level, but should have a slope of one in 100 on one side, so that the water condensed in the pipe can run to one side from where it can be removed through the plug.

Points to be noted during construction :

- Brick-work should be plastered from inside as well as outside with cement coating to make it leak-proof.
- The bottom of the pit should be consolidated properly.

- The difference in the top level of the inlet and outlet pipes should be at least 0.45 m so that digested slurry comes out automatically when fresh slurry is added.
- Proper rest for the gas holder should be provided so that the top of the holder always remains 8 cm. above the slurry level.
- In digesters with a partition wall, the digester should be charged evenly on both sides of the well, maintaining equal slurry level on both sides.
- The guide should be fixed properly so that it allows free up-and-down movement of the gas holder.
- Back-filling and ramming outside the digester wall should be done properly.
- A rubber hose of suitable size and sufficient length should be fixed on the gas outlet so that the gas holder rises freely.
- Curing of the masonry should be complete.
- Gas produced for the first 3-4 days should be allowed to escape.

Operation of biogas units :

- Inputs : Raw material used is cattle-dung mixed with water in the ratio of 4:5 in volume.
- Loading : The biogas units are fed on a continuous basis. 10 days' time should be allowed for proper curing and plastering of the digester before starting the feeding of the digester.

Recommended quantity of wet dung (depending on the size of the plant) well mixed with water (slurry should not be too thick or too thin) and screened through a mesh, should be fed through the inlet pipe. Care should be taken to see that no sand or gravel or any dirt gets into the digester. To filter these a slope is provided in the inlet tank in the opposite direction of the inlet pipe.

Both the compartments of the digester must be filled equally at the time of the first loading as otherwise, due to uneven pressure, the partition wall is likely to collapse.

Any scum floating on top of the digester should then be removed and the gas holder housed on the digester. It is necessary to remove the entire air from the gas holder by allowing the same to settle down on the ledges of the digester.

Once the digester is filled up completely, the gas holder will rise in 15-20 days. Gas collected the first time should be let out as it contains more carbon dioxide. This process should be continued 2 or 3 times till combustible gas is obtained within 4-5 days.

- Scum-breaking : This should be done by rotating the gas holder once or twice every day to break the scum.
- Pressure : A pressure difference of 22.5 cms. -30 cms. seems to be satisfactory between the bottom of the mixing or feeding tank and the discharge outlet. The delivery pressure of the gas is taken as a 10 cm. water column.
- Emptying : The digester should be emptied with the help of buckets. No one should be allowed to inhale the gas or enter the digester pit.

Measures to be taken in winter :

To keep up the normal rate of gas production in winter, the following steps may be followed :

- Warm water may be used to prepare the slurry.
- The mixing tank may be kept covered.
- Temperature of the slurry may be increased with the help of a solar slurry heater or by using part of the gas for heating slurry.
- Addition of organic matter containing a high percentage of nitrogen such as urine, night-soil, etc. increases gas production and improves the quality of manure.
- Addition of non-edible oil-cakes, particularly neem cakes having high protein contents, jaggery wastes, kitchen waste, green leaves, water hyacinth at 1:1 ratio, help to maintain level of gas production in winter.
- Insulation of digester by sawdust or paddy husk, etc. and covering the entire digester by transparent PVC sheets help in maintaining the level of gas production.

Maintenance :

For proper function and maintenance of the KVIC plants the following measures are suggested.

- No soil particles or stones should be allowed to enter the digester.
- Before filling in the digester, it should be tested for leakage by filling with water and observing the drop in water level. A significant drop in water level will indicate leakage in the digester, which should be located and the gap filled up with cement.
- In case the gas holder does not rise, leakage of gas from gas holder and at various joints should be tested and repaired.
- Gas holder should be rotated once or twice daily to break the scum to increase gas production as well as to avoid corrosion.
- Water particles accumulating in the gas supply pipe should be drained out every 4-5 days.
- The slurry should be stored in a proper pit so that the liquid content may not leak through.
- The outlet pipe should be checked periodically in summer to avoid clogging.
- To avoid formation of crust on the gas holder, it should be periodically cleaned from the outside with fresh water.
- To prevent rusting of the gas holder and also to prolong its life, it should be repainted every year using the following methods :
 - the gas holder should be cleaned thoroughly by scrubbing with a wire brush;
 - rust remover should then be applied on it to clean it;
 - a primer should be applied next;
 - a first coat of synthetic coat should follow the primer;
 - a second coat of plastic synthetic paint of a different shade should be applied next so that any area which does not get a second coat will be easily detected.

For further information contact the following address :

Director, Gobar Gas Scheme,
Khadi and Village Industries Commission,
3, Irla Road,
Vile Parle (West),
BOMBAY 400 056.

Modifications/Improvements :

Efforts are being made to bring down the costs of the KVIC plants by optimisation of parameters and substituting the steel required for the gas holder by cheaper materials such as ferrocement, etc.

ASTRA CONTRAPTION

The cell for Application of Science and Technology to Rural Areas (ASTRA), of the Indian Institute of Science, Bangalore, have modified the KVIC design. This modified design has a lower retention period (35 days) with the dimensions of the digester and the gas holder optimized for minimum cost.

Further modification of this design incorporates a solar water heater and solar still.

Description :

The main features of this design are as follows :

- The mild steel sides of the gas holder are extended to 0.3 m above its black painted roof. This water tank permits a 0.1 m deep water pond to be formed on the roof of the gas holder.
- The pond is covered with a polythene sheet.
- By making transparent cover assume a tent-shape, the roof-top solar heater can serve the additional function of a solar still to yield distilled water.

The solar heated water from the pond can be used for mixing the input dung for hot charging the biogas plant. Also the condensed water droplets can be made to run down the sloping sides of the polythene sheet and made to fall into a channel where the collected distilled water can be tapped off.

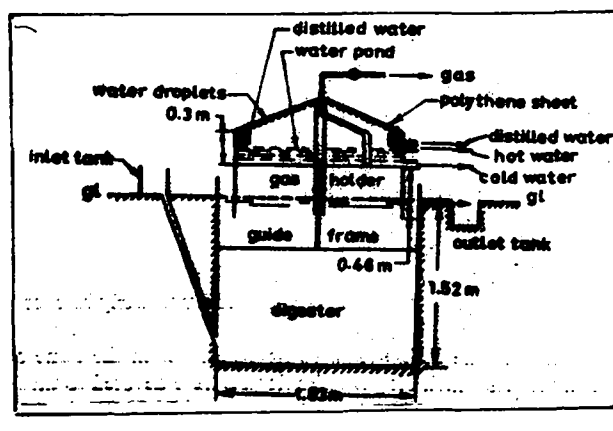

Fig. 10: ASTRA Biogas Plant

SERC CONTRIVANCE

A biogas plant with a ferrocement gas holder has been developed at the Structural Engineering Research Centre (SERC), Roorkee, Uttar Pradesh.

Description : (Ref. 4)

The plant consists of -

- a digester well made in brick masonry in cement mortar;
- ferrocement gas holder;
- inlet feed tanks and outlet effluent tank made in brick masonry in cement mortar; and
- asbestos cement feed pipe and asbestos cement effluent pipe.

Construction of the ferrocement gas holder :

The gas holder consists of a -

- cylindrical ferrocement wall unit, and
- dome-shaped ferrocement roof unit cast separately and assembled.

The wall unit is cast on a horizontal wooden mould lined with galvanised iron sheet.

The mould is made in several segments to facilitate easy assembling and demoulding. The mould is mounted on the process stand which enables rotation and stretching of the wire mesh. Mortar is applied over the wire mesh, layer by layer, so that all voids are filled thoroughly.

The reinforcement for the wall unit consists of three layers of galvanised iron-woven wire mesh. The bottom edge of the wall unit is reinforced by a ring made of mild steel angles which protects the edge from any damage during handling. Inserts are provided near the top and bottom edges for attaching the scum-breaking arrangement.

The roof unit of the gas holder is made in the form of a segment of a spherical dome, as this shape is the most efficient for resisting the force due to self-weight and internal pressure. It is cast on masonry moulds or wooden moulds. The reinforcement for the roof unit consists of three layers of galvanised iron-woven wire mesh. The dome is provided with six fillets equally spaced along the periphery for laterally supporting the wheels of the guides. A socket is placed on the surface of the dome for connecting the gas outlet pipe.

The wall and the roof units are cast side by side and when these have attained sufficient strength (usually after 7 days) the roof unit is supported over a number of props in alignment with the wall unit. Mortar is applied on the junction from the inside as well as from the outside. The curing is continued for another 7 days after which the mortar attains sufficient strength.

The mortar used for the gas holder consists of ordinary portland cement and medium (coarse + fine) sand in the proportion of 1:2 with a water/cement ratio of 9:20. The mix has a stiff consistency to facilitate application by hand on a curved surface. Admixtures are added to improve the impermeability. The crushing strength on 7 cm mortar cubes at 7 days has been found to be between 200 and 250 kg/cm².

The scum-breaking arrangement is attached to the inserts provided near the top and bottom edges of the wall unit. It consists of three mild steel bars at the top and bottom, placed

radially and connected by vertical bars. The radial bars function in addition as bracings for the gas holder. The scum formed on the surface of the slurry is broken by the bars on rotation of the gas holder once in a few days.

Surface Coatings for Ferrocement Gas Holder :

As the cement mortar is porous and therefore not fully impermeable to gas, it is necessary to apply suitable surface coatings to the inside and outside surfaces of the gas holder to improve its impermeability to gas. In addition, these coatings provide protection against corrosion. Trials using resin-based coatings developed in collaboration with the Central Building Research Institute, Roorkee, have given satisfactory results. Commercially available polyurethane coatings have also given a good performance.

NIGHT SOIL AS INPUT .

Introduction :

A night-soil biogas plant have been set up at the National Environmental Engineering Research Institute (NEERI), Nehru Marg, Nagpur 440 020 (formerly Central Public Health Engineering Research Institute).

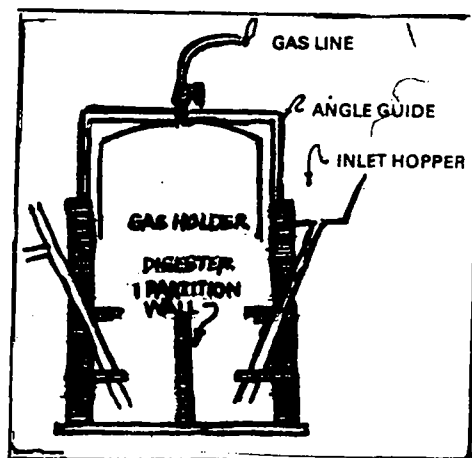

Fig. 11: Night-Soil Biogas Plant

Description : (Ref. 4, 5)

It is a masonry structure partly above ground and partly below the ground with a floating gas dome at the top to collect the gas. There is provision in the digester to feed the night-soil slurry and withdraw the digested slurry.

Operation :

Night-soil and water in the ratio 1:½ is fed into the digester after screening through a 2.5 cm mesh screen. The organic loading in the digester is about 0.8-2.2 kg. 10 lbs of slaked lime may be added in the beginning for acceleration of gas production. The retention time is 20 days. Gas production is 4.2 m³-5.6 m³ a day.

Once or twice the digested sludge from the night-soil digester is withdrawn on to a sludge drying bed, for dewatering and drying. The supernatant of the digester and the underflow of drying beds are further treated in a stabilisation pond.

For further information please contact :

The Director,
National Environmental Engineering
Research Institute,
Nehru Marg,
NAGPUR 440 020.

BELUR MATH INVENTION

This plant was installed by Swami Vimuktananda at the Rama-krishna Mission Saradapitha, Belur Math, Howrah, West Bengal.

Description : (Ref. 5,6)

The plant consists of two parts :

- A digester which is a simple pit dug in the earth and can also be built either with bricks or metal sheets. It has an inlet and an outlet and a gas-proof metallic cover.
- The gas holder consists of two cylindrical tanks, one inverted over the other. The lower one is filled with water. A gas-pipe runs through its bottom to above the water level. The lower end of this pipe is connected with the heating or lighting devices.

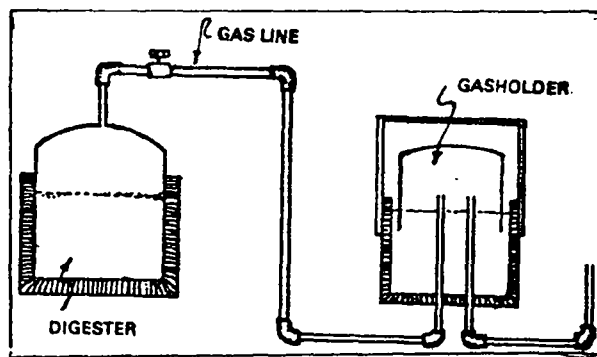

Fig. 12: Belur Math Gas Plant

Operation :

The available quantity of cowdung diluted with an equal quantity of water can be fed daily through the inlet into the digester. Fermentation starts in a few days. The gas formed then passes through a pipe to the gas holder and from there to the utilisation device.

JWALA BIOGAS PLANT

The JWALA biogas plant of the Murugappa Chettiar Research Center (MCRC) is basically a KVIC type of digester with a low density polyethylene (LDPE) - geodesic balloon as the gas holder. This type of plant is considerably cheaper than the KVIC plants, can be fabricated locally. Besides, the balloon material can be carried to any remote place in a small bag. The gas holder is easily removable and replaceable and the LDPE sheet used for gas holder neither requires regular maintenance, nor highly skilled personnel for its construction.

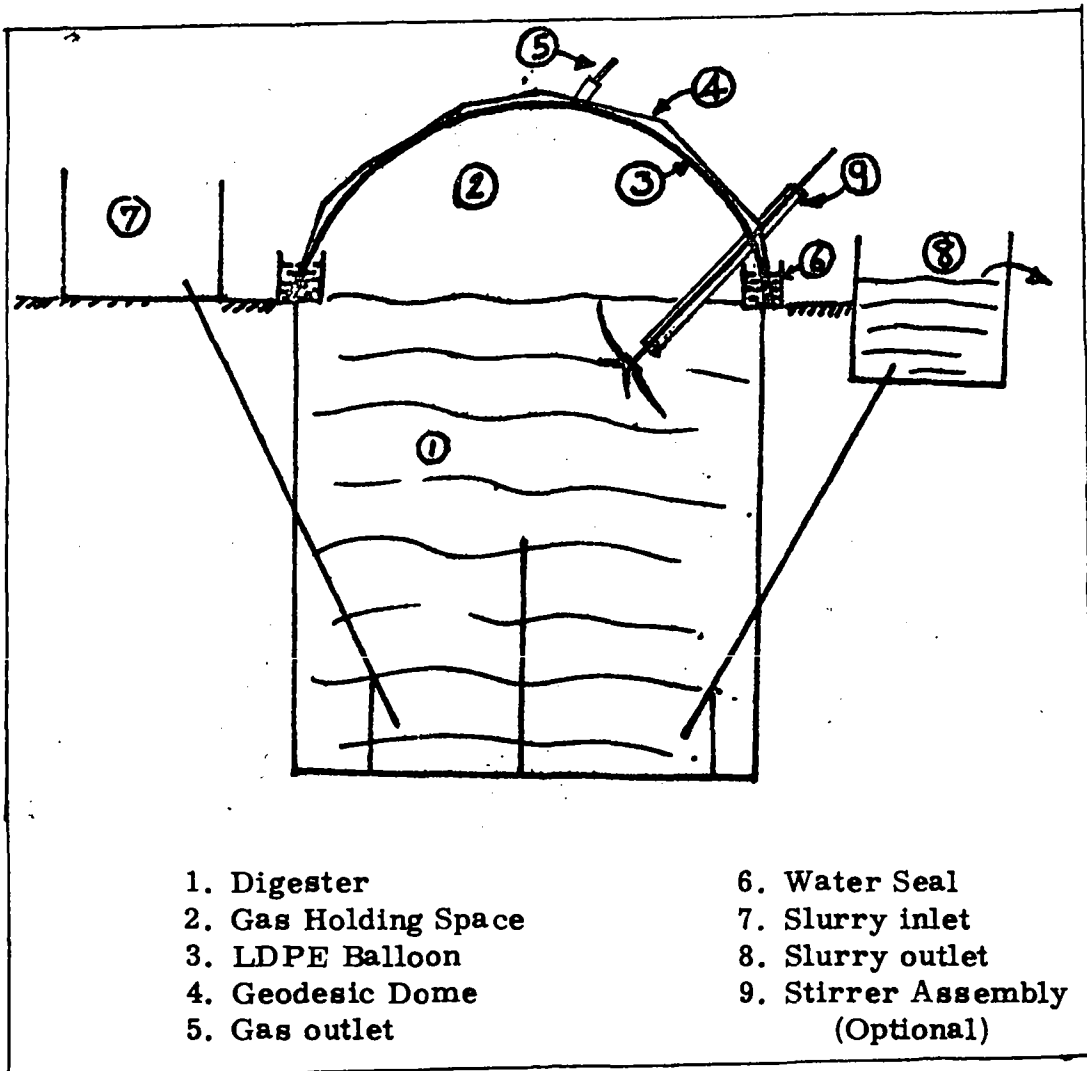

Fig. 13: Jwala Line Diagram

Description (Ref. 8)

The digester is the KVIC type with the inlet and outlet tanks connected to it by asbestos pipes with a baffle wall separating them inside the digester.

The LDPE sheet together with the half geodesic dome constitute the gas holder. The sheet generally used is black, low density polyethylene of 250 μ thickness. The function of the geodesic dome is to support the inflated sheet (or the balloon). The sheet is secured to the dome and the bottom of the dome is in turn held inside a waterseal to avoid gas leak. The height of the water seal also controls the pressure.

Scum breaking is achieved by means of a stirrer which has both reciprocatory and rotary motion. The stirrer rod passes through a guiding tube whose end is immersed in the slurry to prevent gas leakage.

Construction :

The digester is in the form of a circular well below the ground level (See Fig. 14). The 22.5 cms thick brick wall-built above the 1:4:8 concrete jelly base is plastered with 1:5 cement mortar. The height of the partition wall separating the inlet and outlet asbestos pipes varies from 0.5 to 0.75 times the digester depth or height. Lower heights are preferred to avoid contact with the stirrer blades.

The inlet pipe enters tangentially to the partition wall so as to give a better dispersion of the heavy materials like sand.

Once the desired height of the digester is reached, the water seal is built above it by preparing a concrete base. For this one layer of brick is extended on both sides of digester wall by keeping them horizontally. The maximum width of the water seal is 45 cms. Over this 7.5 cm thick concrete is laid.

3 mm-6 mm rods bent in the Ω form are placed at 8 or 10 points around the digester to provide the necessary stay for holding the dome. 5 cm thick bricks are used to build the inner and outer walls of the water seal in a single column. The height of the trough is between 30-40 cm. Good plastering is required to prevent water seepage.

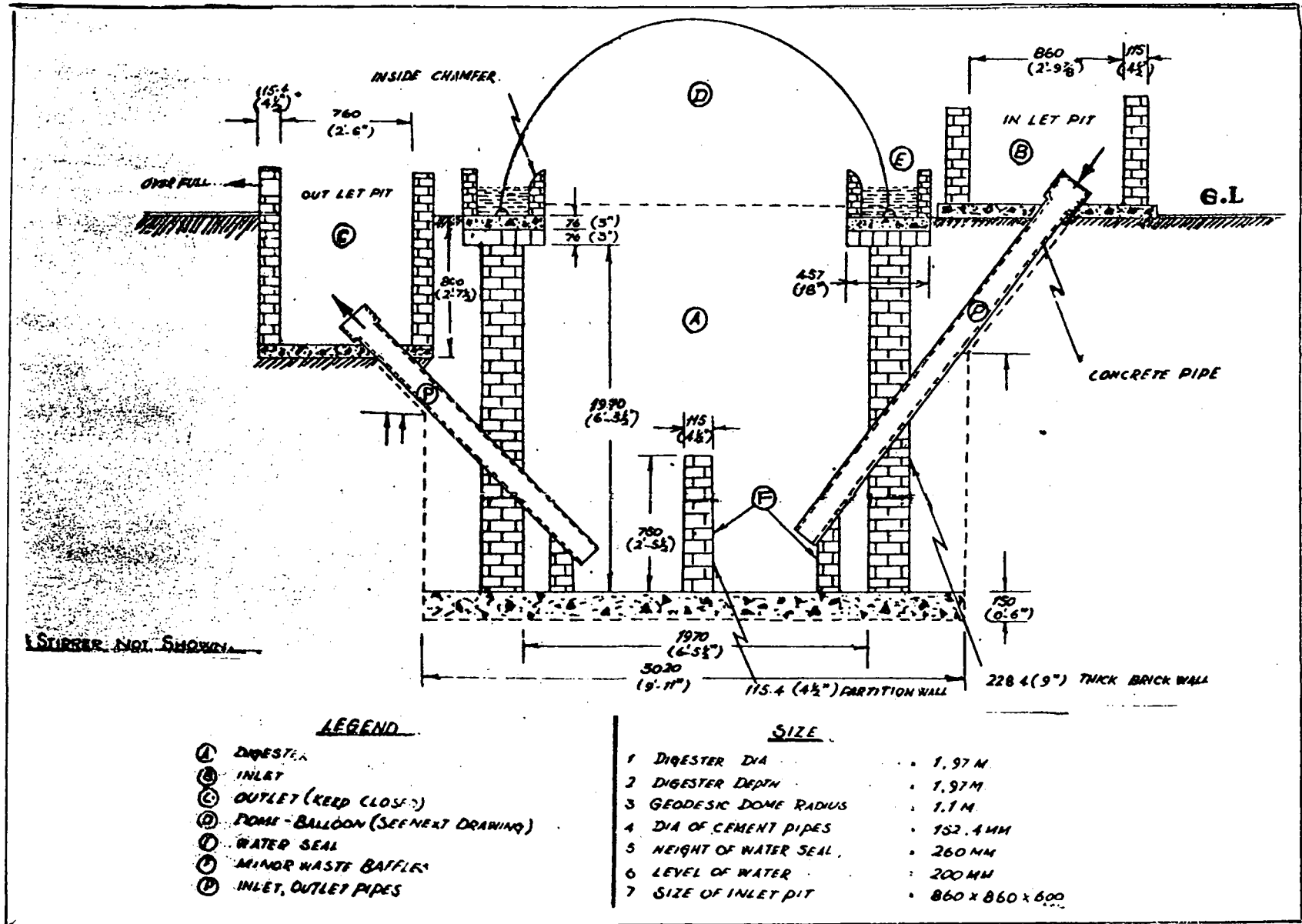

Fig. 14: Jwala Biogas Plant
(100 kg) day dung feed)

Construction of the half geodesic dome is illustrated in Fig.15. Two types of struts - 35 long struts and 30 short struts are required for building this dome. Length of these struts are as follows :

Long Strut = Radius of the dome x 0.6180

Short strut = Radius of the dome x 0.5465

The diameter of the dome is taken as the diametrical distance of the inner edges of the outer water trough.

The dome is constructed by connecting the different struts in a particular fashion. Different materials are used for making struts and different modes of connecting the struts have been experimented with. (Fig.15)

The gas holder is constructed out of black low density polythelene sheets which are highly resistant to ultra violet rays. A single piece of sheet is used nailed at the bottom struts of the dome all around and its periphery is tucked into the water seal. The gas outlet of the balloon is kept closed till the final pipe connections are made. The geodesic dome is then placed in the water seal so as to rest on the LDPE sheet. The gas connection is then lifted up and tied with the apex of the dome.

When the gas fills up the balloon, it assumes an uneven shape due to difference in tension created by placing the dome on the sheet. This can be smoothened out by pulling and adjusting the sheet under the extra bulges and loosening wherever required.

To protect the sheet, materials like gunny sack or palmyra mat are inserted between the sheet and the struts of the dome. The gas pressure on balloon pressing against the struts itself is sufficient enough to hold them in position without causing them to slip.

Fixing the gas outlet with LDPE sheet is a sensitive operation during which good amount of care has to be exercised. Materials used are 15 cm long, 2.5 cm thick wall pvc pipe threaded at one end for about 8-10 cm, two wooden blocks about 2 cm thick having a central hole for the pipe to go through, thick rubber gaskets sufficiently larger than the wooden blocks to provide cushioning, 2.5 cms check nuts, extra bits of LDPE sheets of the same size of the rubber gasket.

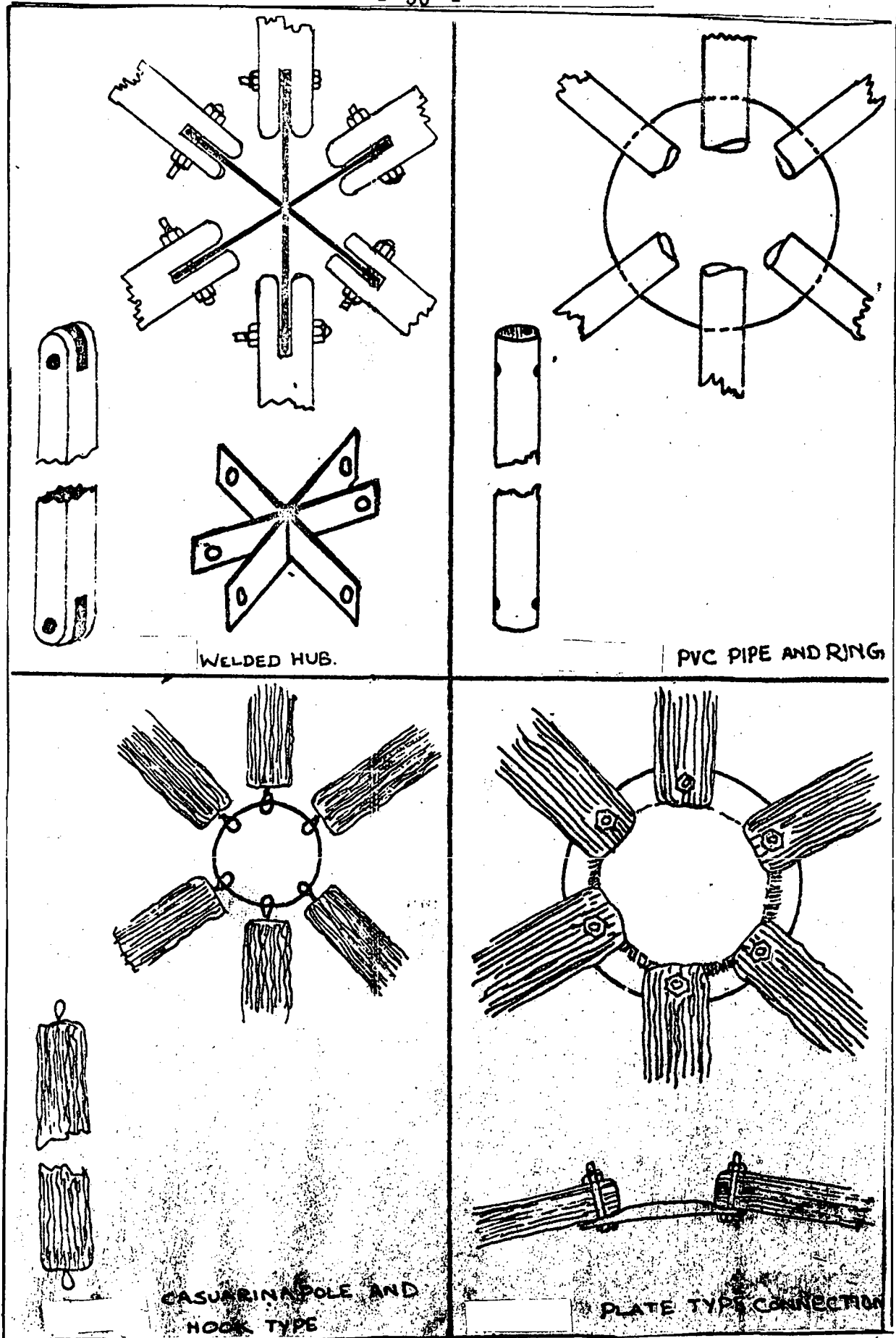

WELDED HUB.

PVC PIPE AND RING.

CASUARINA POLE AND HOOK TYPE

PLATE TYPE CONNECTION

Fig. 15: Construction of Geodesic Dome

A small hole, much smaller than the pipe diameter is made in the sheet, after marking its position centrally, through which the pipe is pierced without causing any extra tearing around it. Pieces of LDPE sheets pierced in the same manner are stuffed on both sides followed by the rubber gaskets over which the wooden blocks are placed and held tightly between the checknuts. This must be properly executed to overcome the leakage problem.

The stirrer rod turns through one inch pvc pipe (called guiding tube) the inner end of which is immersed in the slurry to prevent gas leakage.

The guiding tube is fixed with the sheet in the same manner as the gas outlet connection. The stirrer can be of any shape preferably with some vanes of materials such as wood or galvanised iron, etc. The stirrer rod is a 1-2 cm GI pipe connected to the stirrer by holding it in between the checknuts. The stirrer should not be too big as otherwise it prevents free rotation or too small which does not agitate the surface completely.

One of the supports for the stirrer assembly is the inner wall of the water trough. The angle of inclination can be altered as the central part of the guiding tube rests on the above wall and a fixed support is provided on the ground. By varying the height of the holding position of the stirrer in the fixed support the inclination varies.

Point to be noted during construction :

- The dome and balloon should be installed only after the digester is filled with the charge and the eruption of gas bubbles is observed all over the surface. This is necessary as in the absence of sufficient gas the balloon is in a sagging position and can be easily damaged.

For further information contact the following address :

Dr. C. V. Seshadri,
Director,
Shri A. M. M. Murugappa Chettiar
Research Centre,
Photosynthesis & Energy Division,
Tharamani,
Madras 600 042.

References :

1. Biswas, D.K. "Towards better design of biogas plants for fuel and fertilizer." Bhagirath, Vol.22, Oct.1975, p.140-145.
2. Biswas, T.D. "Cowdung gas plant for energy and manure." Fertilizer News, Vol. 19, No. 9, Sept.1974, p. 3-4 & 33.
3. Ghosh, A.B. "Research and development of cowdung gas plant." Presented at Symposium on radioisotopes, fertilizers and cowdung gas plants held in New Delhi, Dec.1979. New Delhi, Indian Agricultural Research Institute, 1961, p.364-369.
4. India, Department of Science and Technology, Biogas Technology and Utilization: A status report. New Delhi, Department of Science and Technology, 1981, p.12.23, 50-51, 74-75.
5. Reddy, A.K.N. and others. "Studies in biogas technology Part IV, A novel biogas plant incorporating a solar water heater and solar still." Indian Academy of Sciences, Proceedings, C.Engineering Science, Rural Technology, Vol.2, Part 3, Sept.1979, p.387-393.
6. Sathianathan, M.A. Biogas: Achievements and challenges. New Delhi, Association of Voluntary Agencies for Rural Development, 1975, p.22, 139-153.
7. Swami Vimuktananda, "Fuel gas from cowdung." Presented at: Symposium on radioisotopes, fertilizers and cowdung gas plant held in New Delhi, Dec.1979. New Delhi, Indian Agricultural Research Institute, 1961, p.402-403.
8. Umesh, B.V. "Biogas: The MCRC way." Madras, MCRC, 1981, 34p.
9. United Nations, Economic and Social Commission for Asia and the Pacific. Guidebook on biogas development. New York, United Nations, 1980, p.115-125.

CHINESE DEVELOPMENTS

The first biogas digester in China was built as early as 1936, by Professor Zhou Peiyuan, in Jiangsu. Electricity was generated from biogas in the same year in Zhuji County of Zhejiang Province. Over the past 20 years considerable research has been done on various digester models. The water pressure digester was invented in the 1950s, but early models leaked. By the late 1960s the leakage problem was solved with multi-layer anti-leakage cement plastering, and the design of the digester was modified to use local materials.

Description :

The modern Chinese biogas units are -

- circular,
- small and shallow.

The main features of this design are that -

- the two components of the plant - the digestion tank and gas holder are combined into one unit;
- the plant is underground, which saves space and improves temperature condition for complete fermentation;
- locally available materials are used to construct these units, which leads to variations in different locations and also to low building costs.

Details of designs of these biogas units (mostly household types) differ according to type of soil, water table and building material. Chinese biogas units usually come in sizes of 6 m³, 8 m³, 12 m³ in terms of digester volume.

Components :

- Fermentation compartment and gas storage tank : These two sections are combined into one unit. An upward extension of the digester (which is essentially the lower and middle portion of the fermentation compartment) into a dome-shaped structure acts as the gas holder.

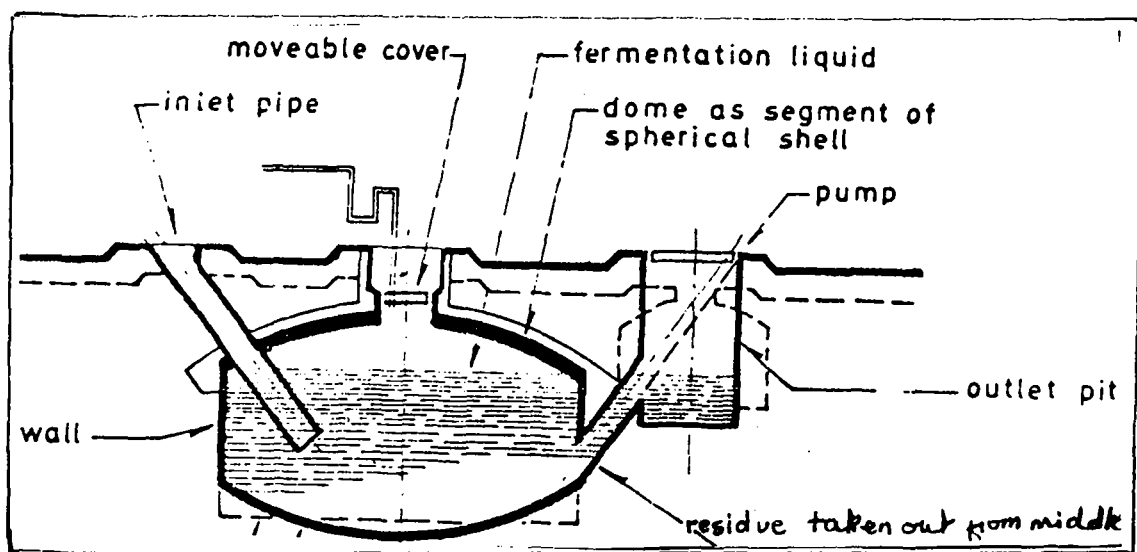

Fig. 16. Basic Design of Chinese Biogas Unit

- Separation wall: This is the wall above the mouths of the inlet and outlet in the fermentation tank. The depth of the wall normally calculated downwards from the top of the tank comes to about half the total depth of the pit. Too low a separation wall impedes air circulation and poses a danger of suffocation for the people who clear and maintain the pit, and too high a separation wall diminishes the gas storing capacity of the tank.
- Inlet and outlet: The materials to be fermented enters into the fermentation compartment through the inlet pipe which is normally a slanting tube with its lower end opening into the fermentation compartment about midheight. The upper end of the inlet should be linked to the excreta troughs of toilets and pigsties.

The residue from the fermentation process is extracted from the outlet, the size of which should be a minimum 7.5-10 cm. Also, there is some distance between the inlet and outlet to prevent freshly incoming materials from going into the outlet.

- Water pressure tank: In the older designs, this was built above the gas storage tank, with the cover to the pit forming the ceiling of the gas compartment and the bottom of the water tank. Its purpose was to maintain the gas pressure. However, in the present designs, increase in the volume of the outlet and in the height of the inlet and outlet above the cover, has made construction of a separate water tank, (for maintaining pressure) redundant. The present designs thus allow the packing of earth on top of the cover, which helps to increase the pressure exerted by the cover board and also maintain the temperature within the pit.

- Gas outlet pipe: This is set into the gas tank cover, the lower end of which opens into the gas storage tank on a level with the bottom of the cover. A plastic or rubber hose tubing is connected to the upper end of the outlet to pipe gas to its point of utilisation.

The connecting pipe may be made of steel, hard plastic or clay and is about 1 m-1.5 m long, depending on the amount of earth above the cover and its diameter is dependent on the diameter of the hose to be fitted on to it.

- Mixer: This is a wooden device (not shown in the diagram) used to stir the fermenting liquid and break through the crust or scum formed on the surface of the liquid, so as to let the gas come through normally.

The mixer is not necessary for small pits built for individual families. However, large pits exceeding a volume of 100 m³ should have a mixer to ensure normal gas production.

- Manhole: This is fitted at the top and has a removable cover. It facilitates maintenance and permits removal of sludge when cleaning out the digester as well as provides a means of exhausting gas prior to cleaning and also serves as a safety device in case the outlet pipe becomes clogged.

Construction of biogas units :

- Selection of size of biogas unit :

- The size of household biogas plants in China is determined by the amount of gas required for daily use by each family.
- Production of gas per cubic meter of raw material is assumed to be 0.15-0.30 m³ per day, depending upon climatic conditions and kind of material used.
- Consumption of gas per person per day for cooking and lighting is assumed to be 1.5 m³-2.0 m³.

- Choice of appropriate shape, foundation and volume of biogas pit :

Two shapes of the pit are commonly used. These are rectangular and circular.

While planning the construction of a pit, advantage must be taken of local materials and the choice of type of construction

should be suited to the soil conditions and availability of building materials.

In regions where stone is available it is convenient to build a circular pit out of stone slabs, or out of stones of irregular shapes; or a rectangular pit out of stone slabs.

In plains or river-bed regions, rectangular and circular pits can be built out of triple concrete.

A spherical pit is the most economical of building materials, and requires 40% less work, when built with stone slabs than a rectangular pit. The spherical shape allows a large internal volume and small opening, which facilitates sealing to prevent air and water leakage and also produces an even pressure on all sides, which facilitates construction.

Pits need not be lined in regions with sheer rock, gravel or shale, thus resulting in saving in building materials, transport and labour.

The pit should be at a site where the soil is suitably firm and the underground water level low and away from trees so that roots will not come into the pit or cause cracks. The pit should be close enough to the place of use.

The volume of the pit should be determined by estimating how much gas will be needed and how hot it will be used. The volume of the pit may be calculated on the basis of the fact that 0.4 m³ of gas is required per head per day.

Materials for construction :

The materials used for construction of Chinese biogas units are :

- Lime-clay: A mixture of lime and clay in the proportion of 1:9-19 by weight and varying in moisture-content from 21-24% is traditional building material in China, which, with the correct proportion of water, compaction and curing, becomes hard and durable.
- Lime-concrete: A mixture of lime, sand and gravel in the proportion of 1:3:6 by volume. To prevent flowering of lime on the walls of the tank, the ingredients need to be mixed thoroughly so that no visible lumps of lime remain. The mixture is usually poured in successive layers, each layer being tamped repeatedly for compaction.

- Low-strength concrete: This is a mixture of concrete having a compressive strength of 30 kgcm^{-2} and a paste made from lime and clay and is employed for the body of the tank.
- Concrete: This is made using portland cement.
- Others: Bricks, stones, rocks, slate, are also used for building digesters, depending on their local availability. In such cases the binding material is mortar, made with cement, sand and lime.

Materials requirement for building biogas units of sizes 6 m^3 - 8 m^3 (as required by a plant constructed by the Chang Ching Production Brigade)

Cement	:	500 kg
Gravel	:	1200 kg
Sand	:	1200 kg
Lime	:	25 kg
Bricks	:	Required number

Methods of construction :

The three common types of structure in use are :

- Tank cast in place (Fig. 17)
- Masonry tank (Fig. 20)
- Tank cut-in place (Fig. 24 & 25)

All units are built in the ground above ground-water level for preference, but in no case should the ground-water level exceed half the height of the digester wall. Cut-in-place tanks are exclusively above ground-water level.

The two major approaches to construction are as follows :

- in one method the tank is built with minimum displacement of soil which is dug out afterwards from the finished structure;
- in the second method all soil is first removed by digging a pit and the unit constructed in that pit.

Cast-in-place biogas units : (Fig. 17)

A shallow, circular pit is excavated in hard soil and at its base a ring trench is dug. Concrete is poured into the trench to form the outside wall of the digester. The untouched soil within the ring now serves as a base for casting the dome. The soil is shaped into the required dome-shape with the help of a wooden deck which is covered with a mat of bamboo branches on which is tamped an earthen backfill at least 30 cm. thick. Finally, a thin layer of sand is spread as a parting agent for casting the concrete dome.

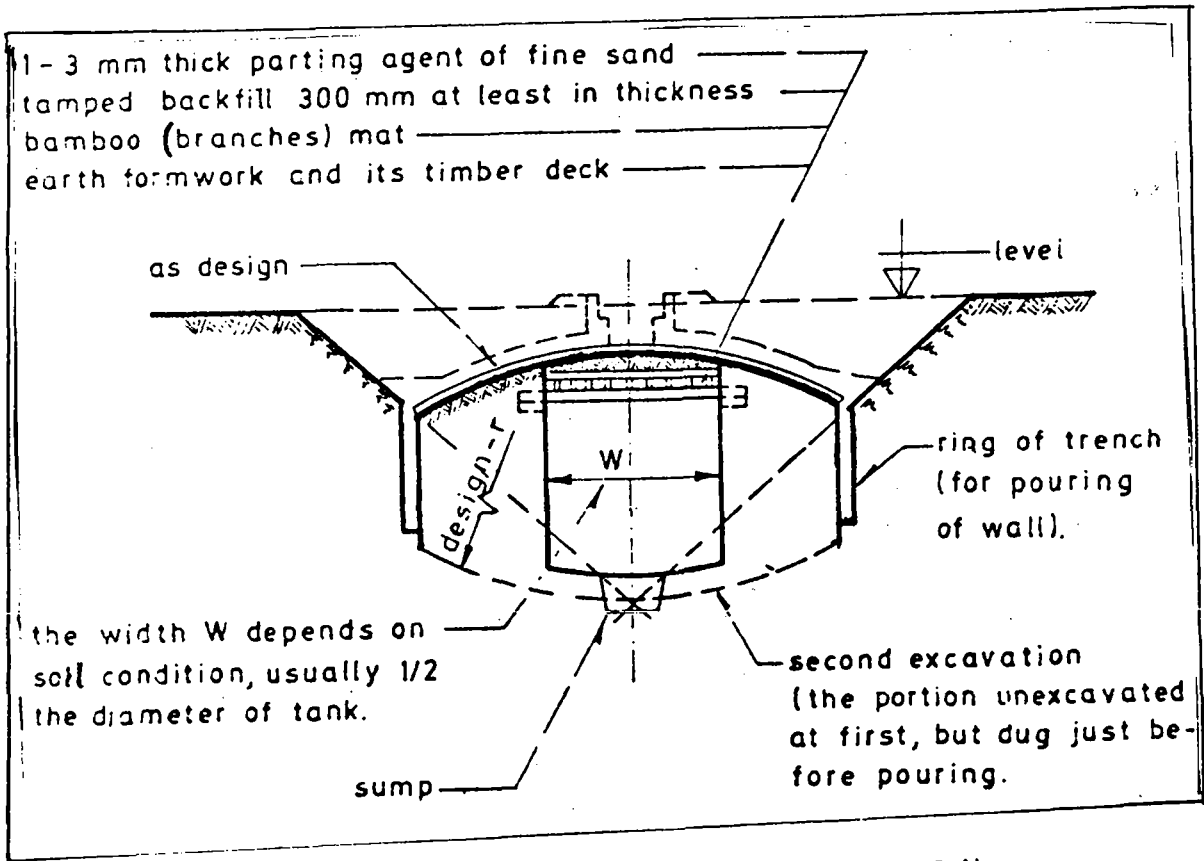

Fig. 17: Design of Cast-in-Place Biogas Unit

The dome is cast strip by strip as illustrated in Fig. 18

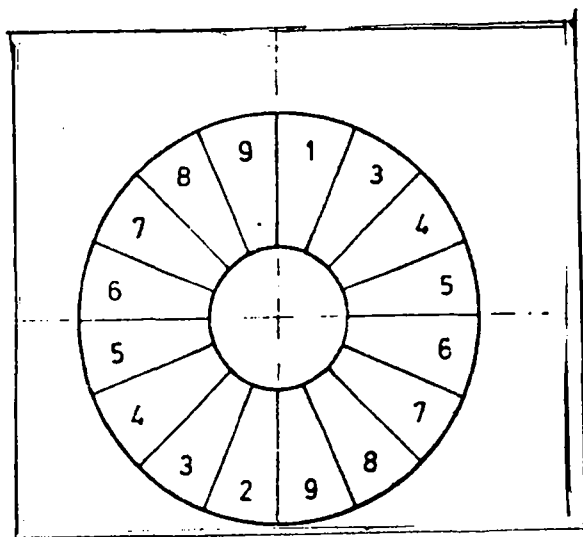

Fig. 18: Casting of Dome According to Numbered Segments

After curing, when the dome becomes hard, the earth beneath is excavated through the manhole at the top.

The bottom of the unit is divided into strips and digging is done in numerical order of strips as indicated in Fig.19 .

While digging under the digester wall bricks are placed at several points on the circumference as a temporary support for the wall.

On completion of the excavation, the floor is poured over with a concrete mixture.

Preliminary excavation (masonry tank) :

Fig. 20 illustrates the design for an excavated biogas unit with a masonry built tank.

In this procedure a circular pit is first dug, using a centre pole and piece of rope for controlling the radius (Fig. 21)

The floor is laid down in segments as explained for cast-in-place units. This is followed by erection of the wall and finally the dome is cast on a back-filled earth frame resting on an umbrella-shaped bamboo support (Fig.22)

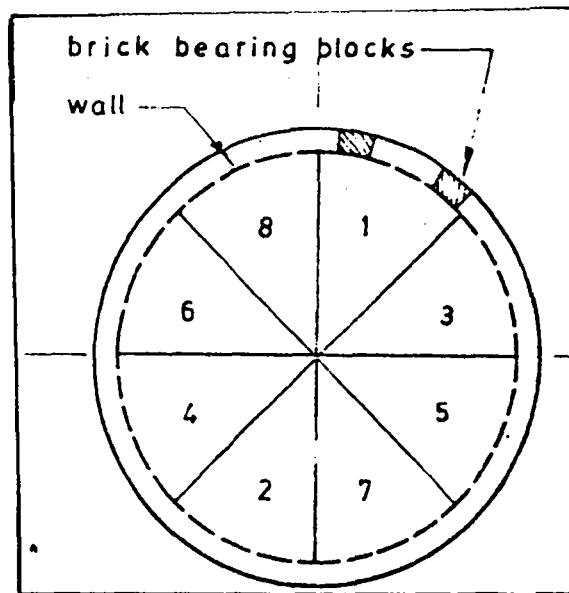

Fig. 19: Excavating of Bottom According to Numbered Segments

The clearance outside the wall is back-filled with earth, layer by layer in alteration with wall pouring.

If the building material is brick, stone, rock, pre-cast cement, etc., overall excavation is done first, then the floor construction and then the masonry.

If the dome is made from bricks, no umbrella-shaped structure is used.

The brick dome can be constructed using two bamboo sticks and a metal clamp. The sticks are to maintain the correct curvature of the dome and the clamp is to hold the bricks while laying. Fig. 23.

The length of the bamboo sticks is precise and is calculated from the height and diameter of the fermentation tank. The size of the metal clamp is just enough to hold two bricks breadthwise.

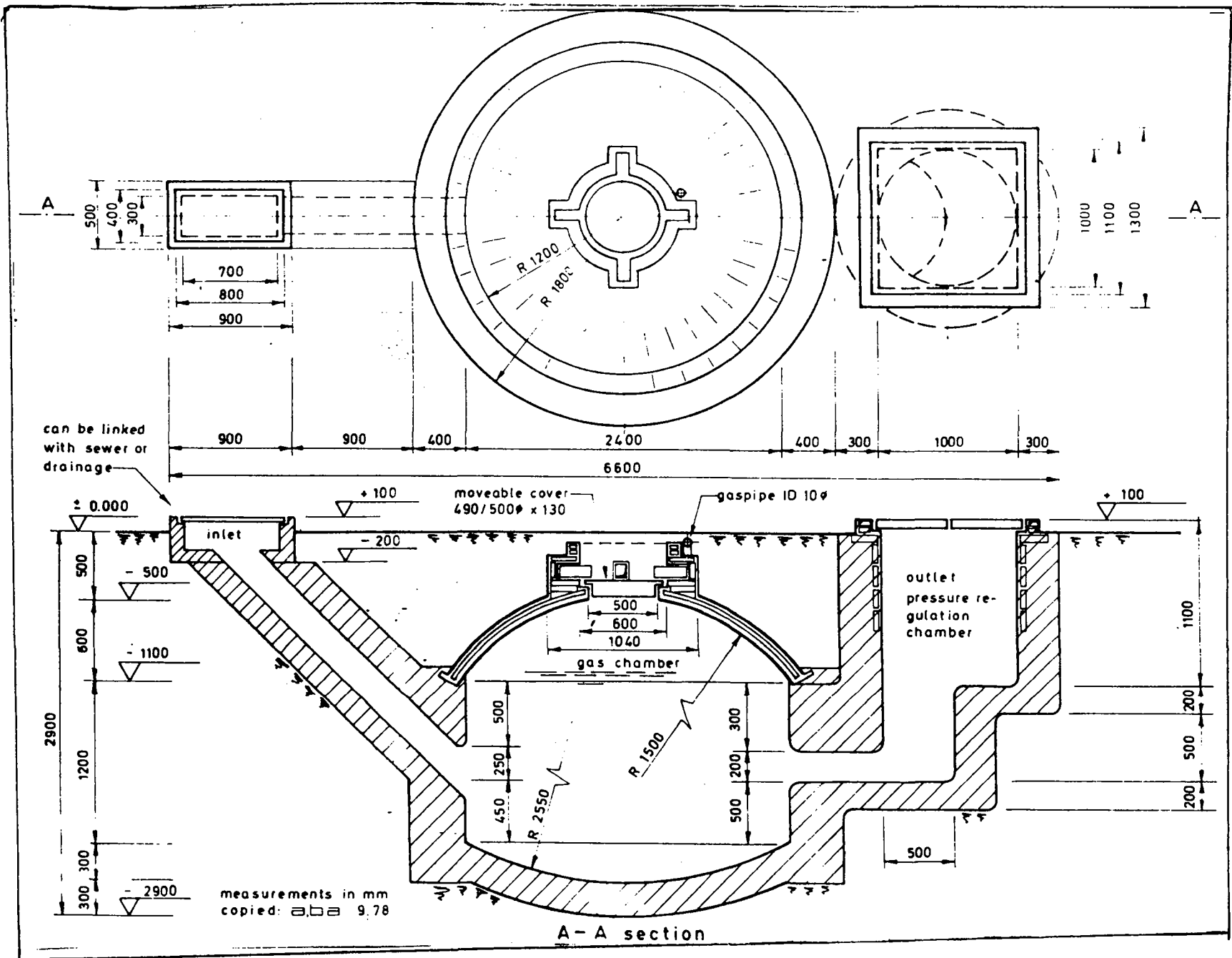

Fig. 20: Design of an Excavated Biogas Unit with Masonry-Built Tank

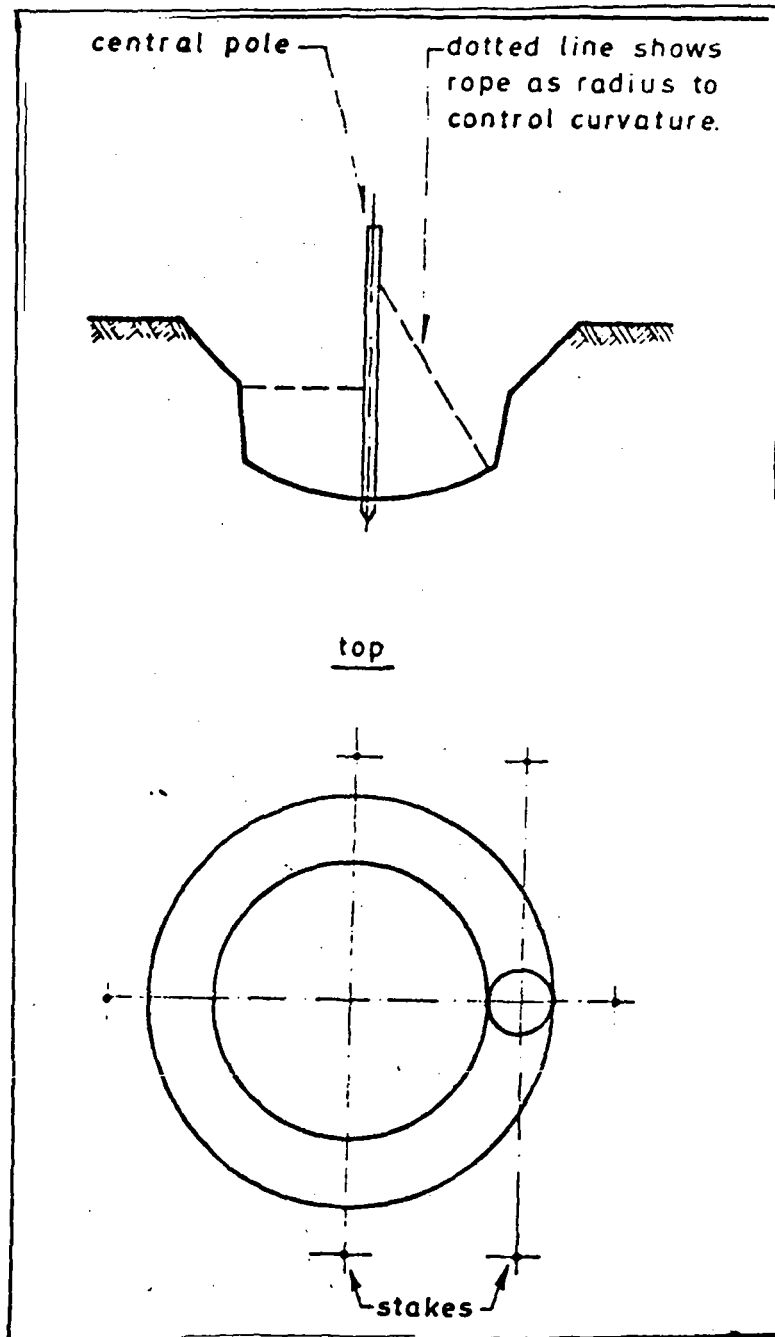

Fig. 21: Use of Central Pole with Rope for Initial Laying out of Biogas Unit Excavation

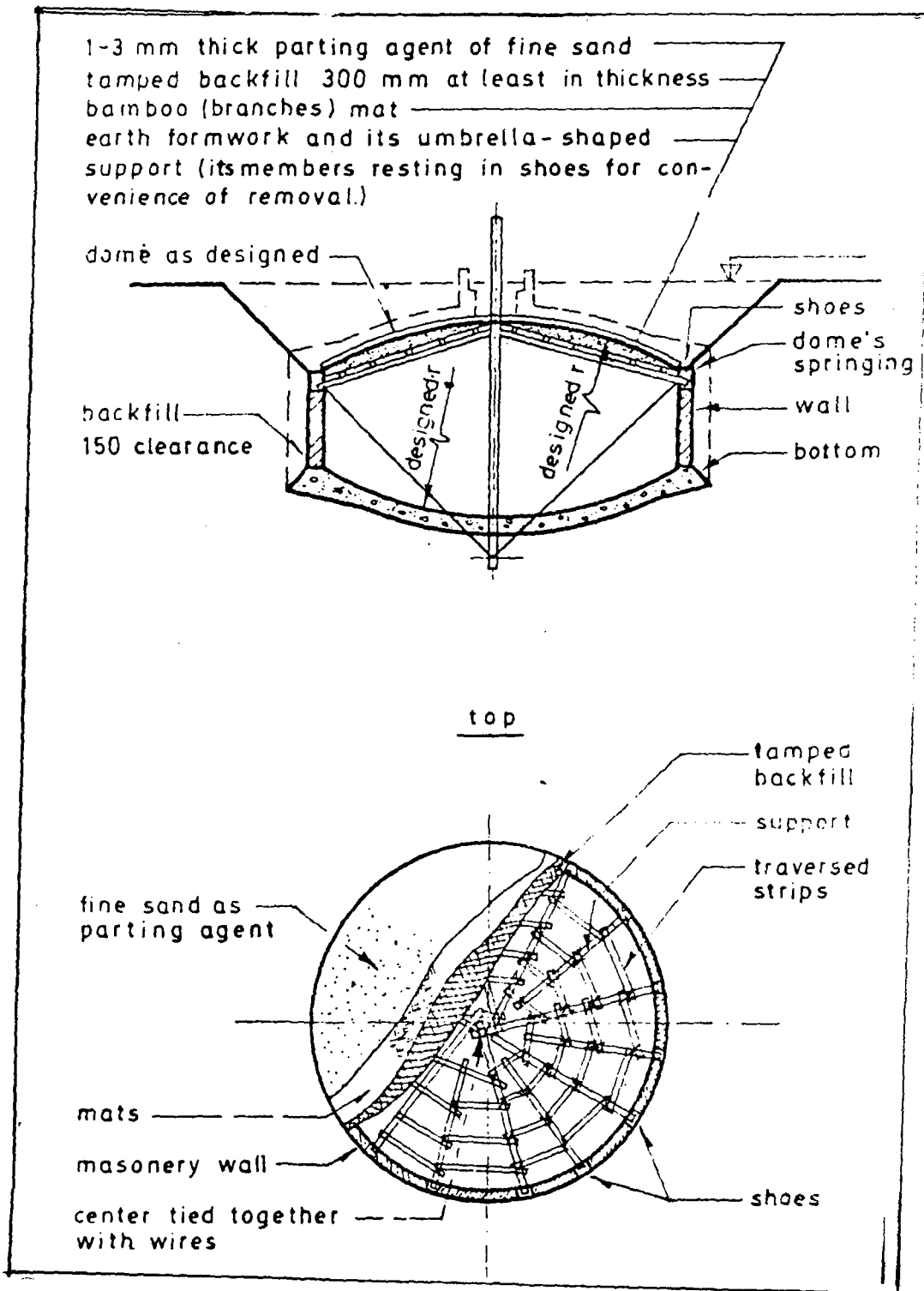

Fig. 22: Overall Excavation with Cast Dome on a Bamboo Support

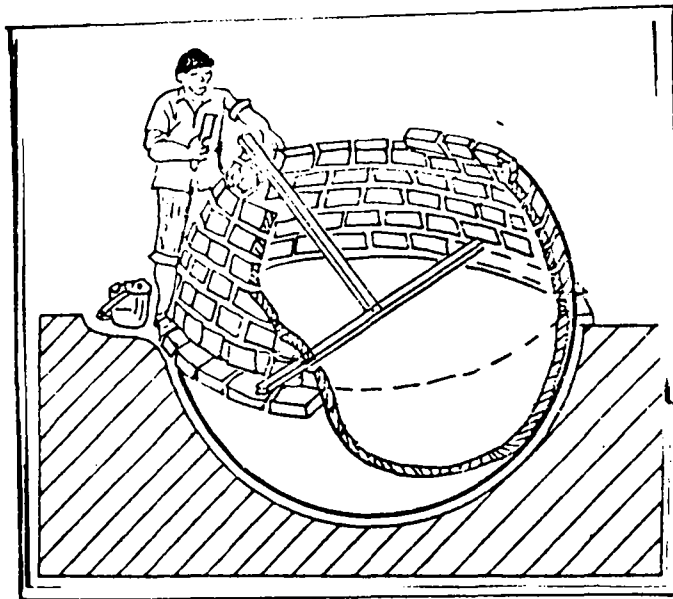

Fig. 23. Method of Building Dome with Bricks and Using Pole for Maintaining Shape and Angle

Cut-in-place biogas units: There are two variations of cut-in-place fermentation tanks -

- one is simply cut in primitive soil (Fig. 24) and the other has a cast dome (Fig. 25). After shaping and tamping the fermentation tank, plaster is applied directly onto the soil.
- In all cases inlet and outlet pipes are made in concrete and fitted after completion of the digester tank. The thickness of concrete is increased at the point where the inlet pipe passes through the dome's springing. The movable cover is also made from concrete and the opening in the dome is strengthened with a concrete ring or collar.

Plastering: Efficient plastering of the walls and dome of the biogas unit is a very important part of construction.

A multilayer plastering with a final brushing of pure cement slurry or lime and sand mixture is advocated. Three coats of plaster are usually applied.

- first coat of cement and sand (1:2.5), 8 mm thickness
- second coat of cement and lime (1:1), 3 mm thickness
- third coat of cement and lime (1:1), 3 mm thickness

Finally a brushing over with a slurry of pure cement or very thin layer of plaster made from lime and sand (1:1) is given.

The whole inner surface of the tank is examined by tapping with a stick before the third coat is applied. If a hollow sound is given off at any place that spot is dug out and replastered more solidly.

Gas outlet pipes inserted through the dome at the time of its construction are made of metal, plastic or bamboo.

- Points to note during construction :

- No explosives should be used for excavating or tunnelling because vibrations may cause cracks which in turn may result in seepage of water and loss of air-tightness.
- Top of the inlet and outlet compartments should exceed the ceiling or cover of the pit by about 50 cm.
- If the walls of the pit or the cover show above the ground, they should be covered with earth in order to slow down erosion caused by exposure to air.
- A pit left empty and dry may slip and the walls may break.

Operation of biogas units :

- Inputs : Raw materials mainly used are human and animal wastes (sources of nitrogen), leaves, grass and agricultural wastes (sources of carbon). Sewage and urban wastes are also used as feed material for larger biogas units.

Raw materials are used in different combinations, depending upon their availability.

The most common mixture is :

- night soil and animal (mostly pig) excreta: 40-50%
(night-soil composition varies from 10-30%)
- grass and crop residues: 10-15%
- water: 35-50%
- Carbon to nitrogen ratio varies between 1:15 and 1:25
- Solid to liquid ratio varies from 1:15 and 1:20

(Gas production decreases with increase in water quantity)

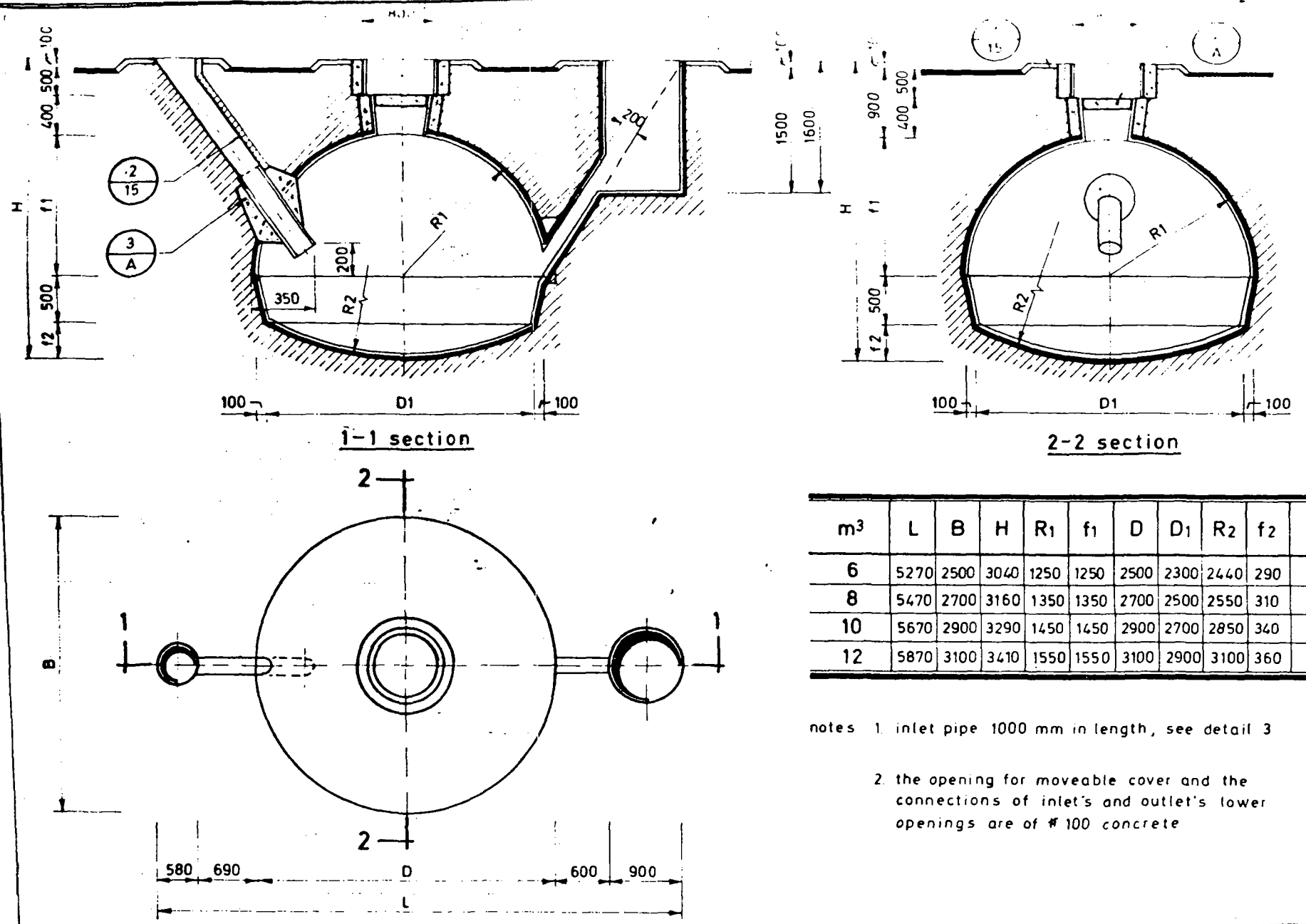

Fig. 24: Design of Biogas Unit Cut-in-Place in Primitive Soil

notes 1. inlet pipe 1000 mm in length, see detail 3

2. the opening for moveable cover and the connections of inlet's and outlet's lower openings are of # 100 concrete

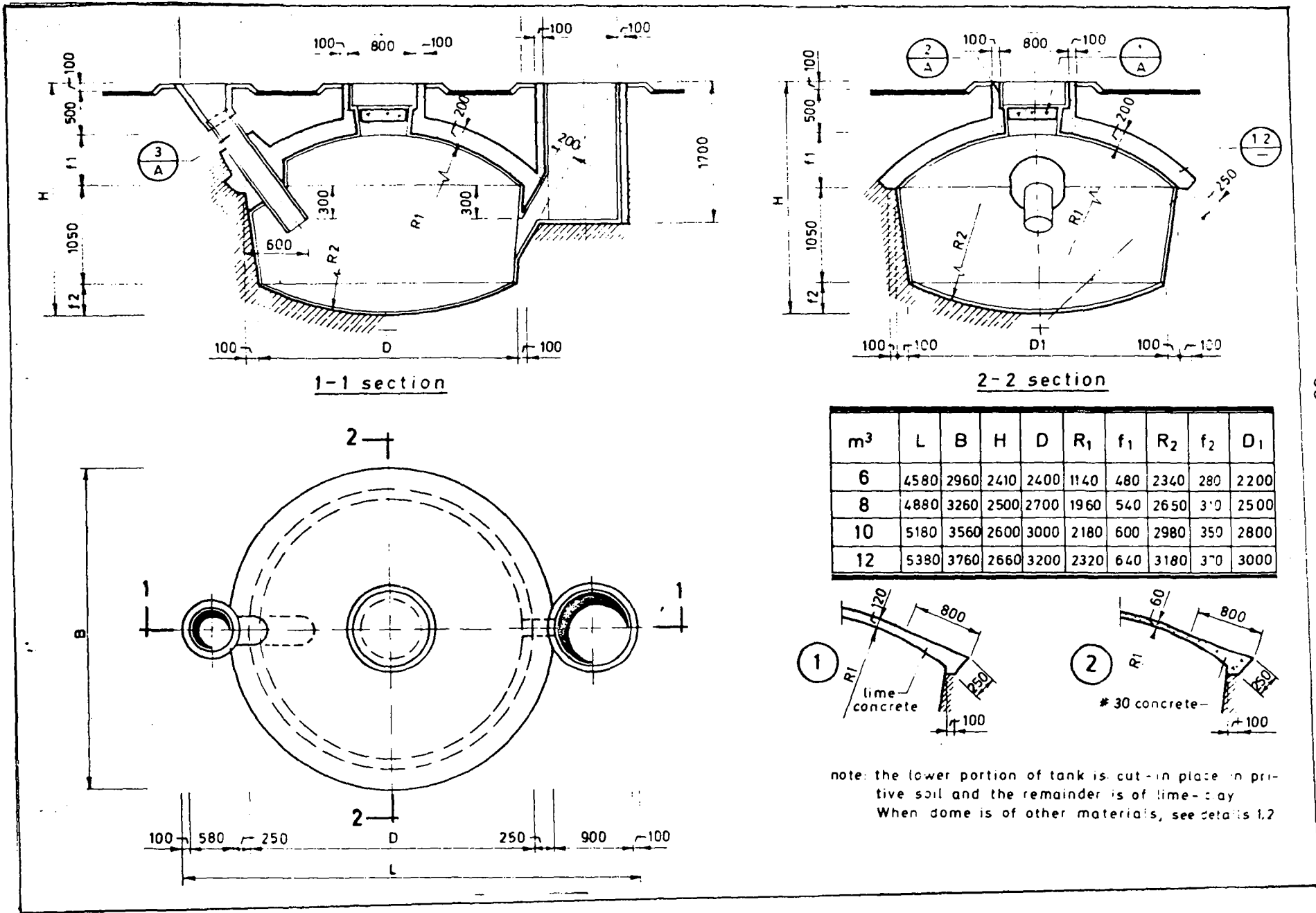

Fig. 25. Design of Cut-in Place Biogas Unit with a Cast Concrete Dome

- Loading : All the Chinese biogas units are a combination of batch-fed and continuous-fed types.

Usually carbon-source material is loaded in batches while nitrogen-source materials are slowly added daily.

The carbon-source material may be bulk-mixed with animal manure before loading.

Frequency of bulk loading is usually two to four times a year.

Daily addition of nitrogen-source material is in the form of washings from latrines and animal pens. No special arrangements are necessary except to connect the sources to the inlet tube of the digester. As a certain amount of excreta flows into the digester each day, an equivalent amount of digested slurry flows out into the outlet chamber.

This renders feeding arrangements easy, prevents heat loss and improves sanitary conditions.

To produce biogas immediately after loading, raw carbon-source materials such as grass and straw may be composted for ten days to several weeks with biogas effluents before being loaded into the digester. In this case, the pH may be adjusted by mixing in lime or ashes.

The first filling must be plentiful. First, the stalks, grass and weeds are filled in and then animal and human waste is put in through both the inlet compartment. Lastly, in order to expel all gas from within the pit, it should be completely filled with ordinary water. Some water should later on be removed to allow room for the accumulation of gas. The quantity of liquid material should never exceed $3/4$ of the volume of the pit.

During filling, the gas hose should be disconnected first from the gas outlet pipe and removable covers, safety valves should be opened so as to avoid pressure buildup during filling. When the filling is complete the cover and safety valve should be resealed with clay.

Gas production begins after one or two days in summer and one week in winter.

- Maintaining pressure : Due to the fixed dome design, gas pressure inside the digester becomes very high-about 1 m of water. The pressure varies according to gas production and use. When the pressure in the tank exceeds atmospheric pressure, slurry in the digester is forced into the outlet chamber and when the pressure in the gas storage tank decreases, the slurry from the outlet chamber flows back into the digester. Thus pressure in the tank is automatically controlled.
- Maintaining a suitable pH: Ideally, the pH in a pit should range from 7.0-8.5 and frequent checks should be made to maintain it at the correct level.

If acidity of the material being fermented increases after a normal period of fermentation, some of the older material should be removed and replaced with raw material. Lime or ash may be added to adjust the acidity and restore normal gas production.

- Stirring : Several methods may be used for stirring the liquid.
 - A long pole or other tool may be poked into the fermentation compartment through either the inlet or outlet compartment and moved around.
 - Some of the liquid could be extracted from the outlet compartment and then poured back in through the inlet compartment, causing convection currents in the liquid in the pit.
 - A fixed frame may be used to hold down in the fermenting liquid, any rising impurities, scum or particles.
- Emptying : The daily addition of washings from the latrine and animal pens results in an outflow of decomposed effluent into the outlet chamber. This effluent may be removed manually in wooden buckets for agricultural use, or sometimes led away by means of shallow troughs. Outlet chamber of large-scale biogas units may be emptied by pumps driven either by electricity or by biogas and the discharged effluent sprayed directly onto the fields.

In order to raise the temperature of the fermenting liquid, a certain quantity of horse or dog manure, house-pets or silk-worm manure, dry grass, stalks and leaves of ginger may be added.

The material should be frequently inlet and outlet after a fortnight of changing the material.

- Biogas pits linked to toilets or pigsties are a great advantage in raising winter gas production.
- By covering the biogas pit and the inlet and outlet compartments with earth, grass or pile-rotted material, the pit's fermentation temperature may be kept high. A little more exothermic fermentation material may be added while introducing new material.

Biogas pits connected to toilets and pigsties only need a cover over the outlet compartment to keep constant temperature.

- Frequent stirring of material in the pit is also effective in maintaining winter gas production.
- Maintaining a proper pH balance in the fermentation liquid is also very important during winter, and frequent checks should be made.
- Production of gas in winter is also directly related to the choice of site for the pit and the quality of construction.

Maintenance of biogas units :

As the Chinese model of the biogas digester is almost completely underground with no moving parts, routine maintenance is negligible. However, every time the unit is emptied prior to re-filling, checks should be made on plastering and on joints. Depending upon the material used, it may be necessary to renew the gas outlet pipe.

To check for air tightness and water tightness of the pits the following measures may be taken :

- The pit may be filled with water upto the cover and sufficient time allowed for the walls to get saturated. The water level on settling should be marked. If the level does not fall after a day, the pit is water-tight; otherwise it is not.

When the bottom and sides of the pit are watertight, a manometer may be connected to the gas outlet pipe and water added or air pumped in, so as to increase the pressure inside. When a noticeable differential has been reached in the manometer, adding of water or air-pumping should be stopped. After 24 hours, if there is no drop in pressure or the change is

negligible i. e. 1-2 cm, the pit is shown to be airtight.

In the pressure test, pressures greater than 100 cm difference in water level should not be built up, so as to avoid damaging the pit.

- Air-tightness may also be checked by filling the pit full of water, fixing the manometer and then extracting the water from the pit, thus building up a negative pressure or vacuum.

Causes and common locations of water and gas leakages :

- If the foundation walls of the pit have not been pounded firm, in addition to water leaks this may even cause the walls to slope and the bottom to sink.
- Leakage between stones due to the stone not having been properly cleaned before use, or the cracks not having been completely filled with mortar and pressed tight.
- Mortar or plaster coming loose after considerable vibration or an earthquake or if the pit was not guarded against the sun or the rain after plastering.
- Cement or sand used contained too many impurities.
- Leaks round the gas outlet pipe, caused by rust not removed at the time of installation.
- Leaks between the walls of the pit and its cover can occur if insufficient mortar was applied, when the cover was fixed in place or if there was any vibration after the cover was fastened on and plastered.
- The cover may have been incorrectly plastered, allowing the gas to leak by capillary action; or the interfaces between pre-fabricated concrete slabs and stone slabs may not have been chiselled into a V-shape.
- For pits made of triple concrete, the ratio of lime to sand, or water to lime, may not have been ideal, or the concrete was not mixed evenly, or the lime was not shaken thoroughly. May be not every layer of concrete applied was pounded tight. The plastering, too, may not have been of a high enough quality. The earth filling outside the wall may not have been pounded sufficiently tightly so that the walls may warp and cause air or water leaks.

- Large pressure built up inside the pit during water tests or air tests may cause cracks to form in the ceiling or walls. Over a short period of rapid, intake or output of contents, positive or negative pressures can build up.
- Filling up of a newly-built pit with materials before it has had time to cure or wrong choice of site might lead to air or water leaks.
- In areas where the underground water level is high, after outletting material in summer or autumn if the pit has not been immediately filled with material or water, the underground water can damage the bottom and cause leaks.
- If the earth has not been pounded firmly outside the walls of the pit during tests or during gas production, unequal external and internal pressure can make some of the stone building blocks move, leading to water or air leaks.

Repair of Biogas pits :

Method of repairing water and air leaks include -

- Cement and sand mixture in the ratio of 1:1 may be used to fill in the leaks and the repaired area covered with three or four layers of pure cement.
- Cracks should be chiselled wide open, the edges roughened and filled in with the mix, trowelled smooth and carefully protected. For stone pits, before repairs, any stone surfaces and cracks should be chiselled clean.

Any cracks in triple concrete pits should be opened up wide and deep and then filled with cement, lime and cinder or sand mix (volume ratio 1:2:3) and this should be pressed tightly into the cracks and made smooth.

- Any plaster flaking off in the gas tank should be cleaned off and new plaster applied.
- Where an air leak has not been clearly located, the gas tank should be washed clean and a coat or two of pure cement, or cement/sand mix (ratio 1:1 or 1:2) should be applied.
- When there is a leak at the point where the gas outlet pipe goes through the cover, the interface between the pipe and cover may be chiselled open and the pipe cemented anew.

- When subsidence of the pit bottom has led to water leaks, whether the whole bottom has subsided or whether the cracks are at the angles where the bottom meets the walls, the cracks round the walls should be enlarged by cutting a gully 1.5-2 cms wide and about 3 cms in depth all round the pit and then pounding concrete to a thickness of 3-4 cm over the whole bottom and in the encircling gully, so that it can solidify in one piece. When there are leaks in the bottom of a concrete pit, the bottom may be reinforced with a mixture of small pebbles and triple concrete, or with cement/sand mix.

Safety precautions :

- Pressure: A simple safety device consisting of two glass tubes each 1 m in length and 1 cm in diameter is fitted in irrespective of the size of the biogas unit. One end of the gauge is connected to the gas supply using a T-joint and the other is left open or fits into an inverted jar through a two-holed rubber stopper.
- Toxicity and explosion: As biogas is combustible, safety precautions should be taken to prevent any naked flame being introduced into the tank. Furthermore, methane is explosive if mixed with air in proportions ranging from 5-15% by volume. A 30% concentration of methane can anaesthetize a person while 70% concentration can asphyxiate. Thus the tank must be well ventilated before one enters - for cleaning, maintenance and so on. Breathing through a hose hanging inside or lowering a basket containing a live chicken may be used to test non-toxicity in the atmosphere.

For further information contact :

Szechuan Provincial Office of Biogas Development,
Chengdu,
Szechuan,
People's Republic of China.

MODIFICATIONS/ADAPTATIONS

JANATA VERSION (Ref. 2)

A modified Chinese type biogas plant was set up by the U. P. State Planning Research Institute, Gobar Gas Research Station in Ajitmal, in India, in 1977. This model is popularly known as the Janata Biogas Plant.

Description :

This plant has no steel gas holder and no moving parts. The gas holder is built as the dome cover of the well-like digester itself. Its main features are :

- simplicity in construction;
- use of locally available materials;
- no requirement of steel;
- use of locally available skills;
- low cost.

Components :

- Digester and gas storage tank: The digester is an underground dome. The crown has an opening which is provided with a cement-concrete disc cover sealed from all sides and held in position by its own weight. Gas is stored in the concrete dome which serves the purpose of a gas holder.
- Inlet and outlet : The plant has a sloping masonry inlet with a wooden cover and a rectangular plastered outlet with a wooden cover. The sloping outlet and inlet reach the bottom of the well, on either side of the fermentation tank, and have their openings at ground level.

Construction :

- Site selection: The area should be elevated, dry, open and exposed to sunshine for a greater part of the day near both the kitchen and the cattleshed.

The ground water level be at least 3 metres below the surface throughout the year.

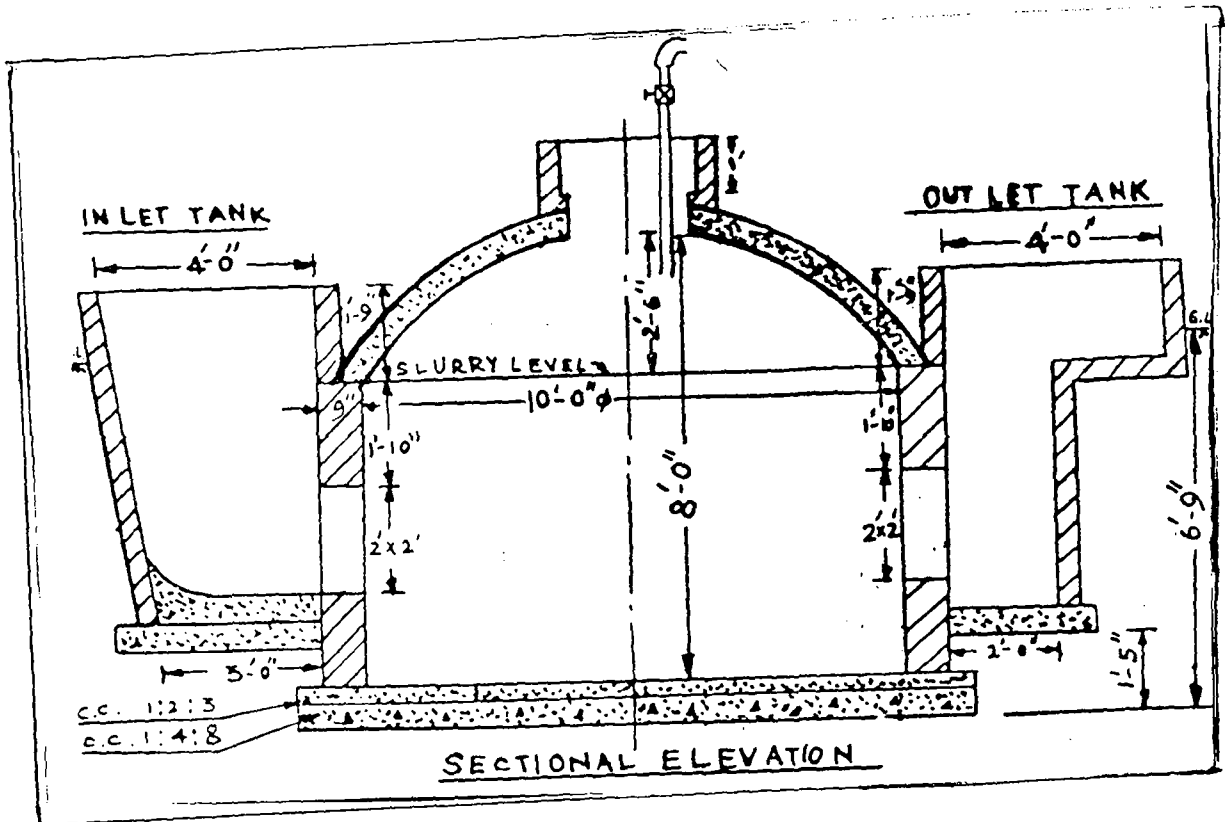

Fig. 26: Janata Biogas Plant

There should not be a drinking water well or hand pump within a distance of 15 metres around the gas plant.

- Size of the plant: Appropriate size of the plant should be selected keeping in view the availability of dung and requirement of gas for cooking purposes.

A plant producing 2 cu. m. of gas per day requiring about 30-45 kgs. of dung from 3-4 cattle is found to be suitable for the cooking needs of 5-8 persons. Plants are mostly available in sizes ranging from 2 cu. m. -6 cu. m. (in terms of gas produced per day).

- Materials for construction: Bricks and cement are the material commonly used in the construction of the plant. The other materials used are rubber hose pipe, PVC pipe or G.I. pipe etc.
- Quantity of material required for various plant sizes are given below :

Table 5 : Material Requirement for Janata Biogas Plant

Materials	Size of plant (cu - m)			
	2	3	4	6
No. of bricks per plant	1500	2200	4000	4500
No. of bricks for two compact pits	3600	3600	3600	3600
Brick Ballast (cu. m.)	1.2	1.5	2.5	2.7
No. of cement bags	20	25	35	40
Fine sand (cu. m.)	2	2.8	3.5	4
Coarse sand/Marrum (cu. m.)	0.50	0.56	0.70	0.75
Stone chips of 15-20 mm size (cu. m.)	0.20	0.25	0.34	0.42
300 mm long gas vent pipe (dia. in mm)	10	10	20	25
Enamel paint (litres)	4	4	5	6
No. of wooden cover	2	2	2	2

Method of construction :

Digester : A well is dug and built below the ground level, its depth being approximately 2 meters and its diameter about 3 meters.

Following this, the foundation should be laid using cement, sand and brick ballast in the ratio 1:4:8 and travelled firmly to make it water-proof. The thickness should be 150 mm for 2 and 3 cu. m. size plants and 250 mm for 4 and 6 cu. m. plants. In case of mortar, the ratio of 1:2:4 should be used.

The floor should then be cured with water for at least 4 days.

After 24 hours of laying the foundation, the digester wall should be constructed with bricks, leaving about 10 mm space outside.

The walls are constructed as follows :

- the header is laid first followed by the stretcher layers of bricks by pouring 15 mm thick mortar cement, fine sand, coarse sand in 1:1:5 proportion in between each brick upto the arch of the inlet and outlet openings in the digester. (See Fig. 27)

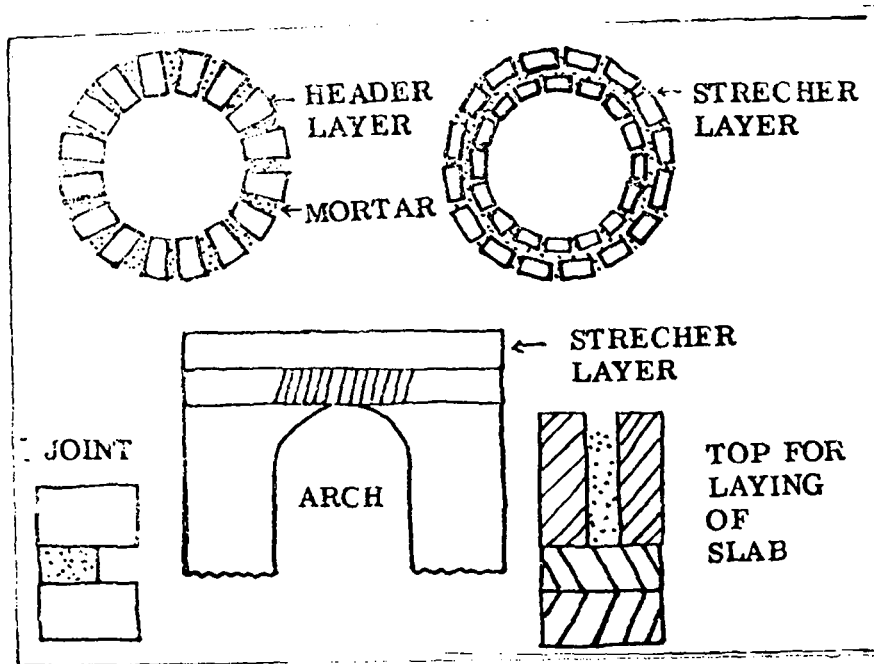

Fig. 27: Brick Masonry Work

- in case of 2 and 3 cu. m. size plants bricks are laid in stretcher only;
- for 2 and 3 cu. m. capacity plants 11.5 cm thick wall is constructed and for the other sizes, wall thickness is about 25 cm;
- to avoid cracks in the wall, earth should be filled firmly on the outside of the walls;
- arch-shaped openings (thickness of the arch being 11.5 cm) should be constructed for the openings of the inlet and outlet in the digester. Above the arch level a 75 mm thick row of bricks should be laid throughout the digester wall;
- digester wall above the arch opening should be constructed in stretcher with a mortar 1:1:3 of cement, coarse sand and fine sand;

- annular opening of 2 cm. width should be left for filling with 1:1:2 mortar before the construction of the dome;
- all vertical and horizontal joints of masonry should be filled with mortar;
- walls should be cured with water at least for 4 days.

Dome :

Shuttering should be done with wooden plants, poles and nails. Brick walls are erected with mud in the centre and at six diagonally opposite sites in the digester and bamboo poles and wooden planks fixed at a 30° slope. A layer of moist sand followed by another layer of dry coarse sand should be spread in the form of a dome and made hard.

The gas vent pipe is then fixed in the centre of the dome, keeping the socket towards the bottom, the base then covered with a cement-mortar curb 10 cm high and 20 cm in diameter to prevent leakage of gas.

Plastering of the dome should be done in two stages -

First, plastering should be done with 1:1:2 mortar to a thickness of 10 mm and troweled firmly followed by a plaster of 1:2:3 mortar to a thickness of 2 cm. The dome should then be cured for 6-8 days after which the shuttering work should be dismantled carefully.

The grooves left in the inside wall of the digester should be filled with 1:1 mortar and then the wall plastered with 1:2 mortar to a thickness of 1 cm. and trowelled firmly.

The digester wall should be rendered with pure cement twice and the plant cured for another six days by sprinkling water three to four times daily.

The inside of the dome and top portion of the digester wall should be painted with enamel or bitumen paint.

Operation :

Input: The raw material used is cowdung and water in the proportion of 4:5.

Loading: The plant is the continuous-fed type. The recommended quantity of slurry is fed daily into the inlet chamber. As the fermentation tank gets fed daily an

equal amount of spent slurry flows out through the outlet. Gas formation starts after 5 days. The pressure equalisation is based on the principle that increased gas pressure pushes slurry up the feeding outlet and a decrease in pressure is balanced by the return flow of the slurry into the tank.

Maintenance :

As the plant does not have any moving parts, wear and tear and maintenance required are negligible. However the plant, before use, must be tested for water and gas leakage using the methods discussed before (as for the Chinese biogas plant).

For further information contact the following address :

U. P. State Planning Institute,
Planning Research and Action Division,
Kalakankar Bhawan,
Lucknow
INDIA.

References :

1. Buren, Ariane Van, Ed. Chinese biogas manual. London, Intermediate Technology Publications Ltd., 1979.
2. Singh, Ram Bux and K.K. Singh. Janata biogas plants: Preliminary report on design and cost. Lucknow, Planning Research and Action Division, 1978.
3. United Nations, Food and Agricultural Organization. China: Azolla preparation and small-scale biogas technology - report on an FAO/UNDP Study tour to the People's Republic of China, May 21-June 11, 1978. Rome, Food and Agriculture Organization of the United Nations 1978, p.21-50.

SOUTH PACIFIC INTEGRATED BIOGAS SYSTEM

Introduction :

Integrated Biogas System (livestock-aquaculture-agriculture) in the South Pacific is mainly based on the Taiwanese experience of production of algae in shallow basins using septic-tank effluent, and the fertilization of fish ponds with human and animal excreta.

The biogas digester is the heart of the system because it treats the wastes sufficiently to allow the effluent to serve a useful purpose in the basins and then in the ponds before it is absorbed in the soil by plants. Without the digestion and liquefaction process inside the digester, the wastes would pollute both the water in the soil and the basins or ponds. The methane gas replaces other useless gases that would have been produced if air had been allowed inside the digester.

Description:(See Fig.28)

The digester consists of

- a digestion chamber which is double-walled, with the wastes entering the inner chamber;
- a settling chamber;
- a steel gas holder floating between the two walls that contain water topped with oil to prevent evaporation.

Construction and maintenance of the digester :

Construction and maintenance of the digester does not require any special skill.

The following points need ~~serious~~ ~~con~~ consideration -

- The digester must not leak;
- The digester must not be loaded much above the capacity for which it is designed, as this can increase the acidity of the mixture and stop the growth of the methane bacteria.

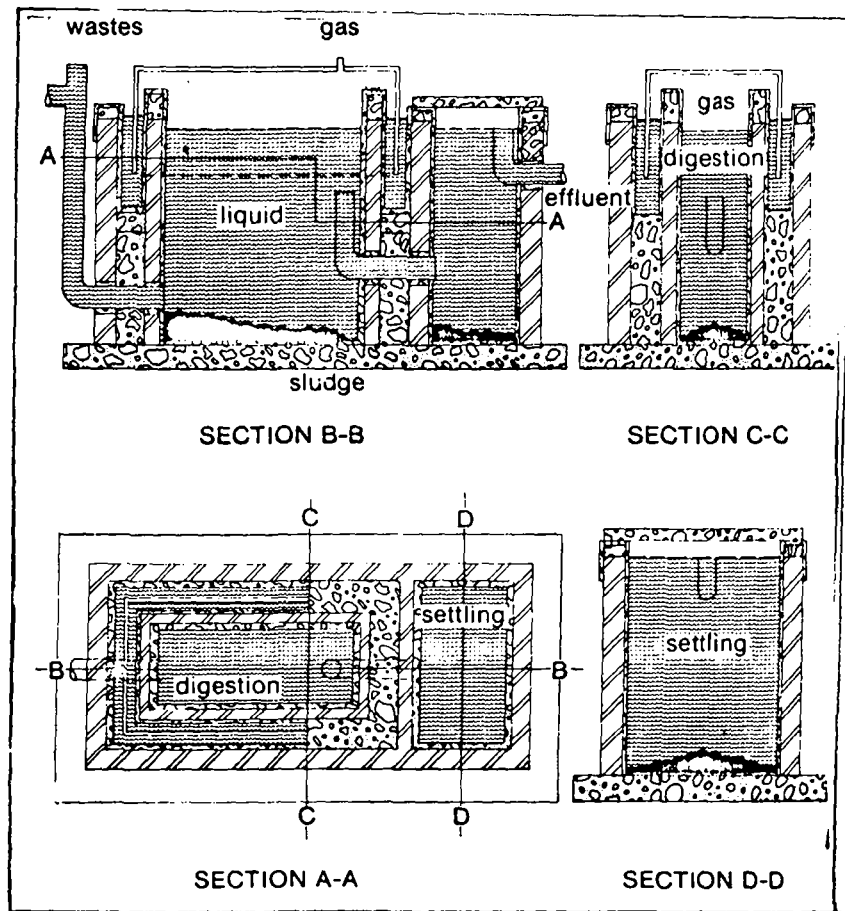

Fig. 28: A 300-Gallon Concrete and Steel Digester

- There should be a screen at the inlet to prevent grass and leaves from entering the digester and every day a plunger should be used to clear the inlet and push the wastes inside the digester as otherwise, floating wastes will accumulate at the inlet, preventing wastes from entering the digester.

Operation of the digester :

Wastes are washed into the digester twice a day with a specified volume of water so as to give a good dilution to the wastes (between 5 and 10 to 1) and a hydraulic retention¹ time of only one day. Such conditions allow the digester to be as small as possible (20 gallons per head of cattle, 10 per pig, and 1 per chicken or person) while making pH, ammonia toxicity, viscosity and constant stirring less critical.

The digester is covered with a fair-sized greenhouse to maintain the higher ambient temperature at all times for maximum gas production within one day.

BOD reduction is of the order of 30-40% but this can be increased to 50-60% if the supernatant liquid from the digester is settled for another day. This also improves the quality of the effluent which is discharged into the algae basin.

The water seal in the digester prevents the gas from escaping until the gas holder rises high enough to break the water seal. The gas holder drops down again until equilibrium is re-established. As more gas is formed but not used, the same thing happens again. This process works like a safety valve, allowing the extra gas to escape.

The effluent from the digester is subsequently oxidized in shallow basins while producing algae and in deeper ponds while producing fish and other aquatic life.

The mineralized effluent is then used in vegetable gardens for maximum food, feed and fibre production.

If the levels are well set, the whole system will work on the overflow principle, and one operation - that of washing the animal house twice a day - will load the digester to produce bio-gas, grow algae, feed the fish and duck ponds, and irrigate and fertilize crops.

The final effluent is of drinking water standard and will not cause any pollution or environmental damage.

For further information please contact :

Mr. George L. Chan,
P.O. Box 151 CHR B,
Saipan, Mariana Islands,
CM 96950,
U.S.A.

References :

1. Chan, George. "Integrated biogas development: Fiji." In Biomass energy projects - planning and management, edited by Louis J. Goodman and Ralph N. Love. New York, Pergamon, 1981. p.120-139.
2. United Nations, Economic and Social Commission for Asia and the Pacific. Report of the preparatory mission on biogas technology and utilization. October 2, 1975, p.40.

OTHER PROMISING DESIGNS

BIOGAS BAG DIGESTER

Introduction :

Dr. Chung Po of Taiwan has developed an inexpensive neoprene rubber bag digester which combines the digestion chamber, settling tank, and gas holder into one unit (see Fig. 29); and stores the gas above the digestion liquid. The digester is manufactured in Taipei by a local factory and is currently being propagated at the Institute of Natural Resources, University of South Pacific, Suva, Fiji.

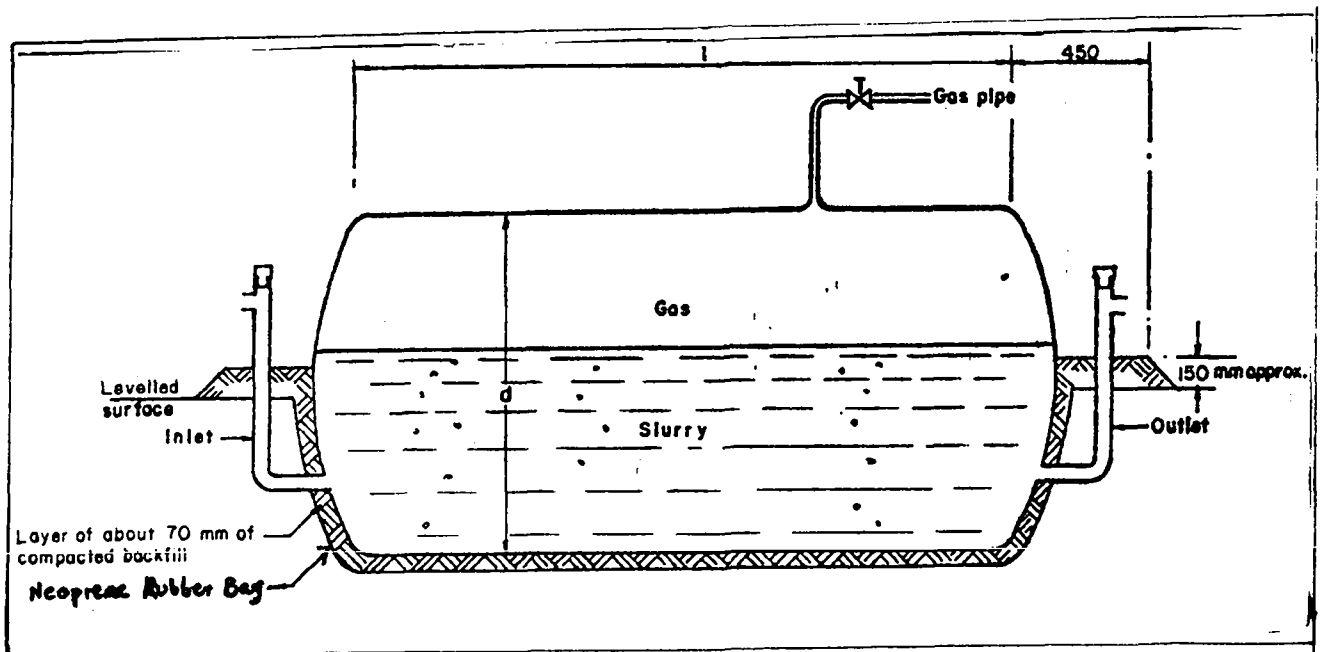

Fig. 29. Biogas Bag Digester

Description :

- Biogas bag: It is a cylindrical rubber bag approximately 3.3 m long, 1.5 m in diameter. With the inlet and outlet pipes, an area of at least 4.5 m long and 1.8 m wide is required for the digester. The biogas bag needs to be supported up to the level of the liquid slurry inside the bag and this can be done by placing the bag in a hole dug in the ground up to this level and by placing the outlet of the bag in level with the ground.

- Inlet and outlet pipes: These are heavy PVC tubings with metal clamp.
- Gas Line: About 1.25 cm diameter plastic garden hose of 30 m length may be used. Moisture traps should be provided at each low point in the gas line to remove water which escapes with biogas in the gas line.

Construction :

- Site selection :
 - The place of utilisation of the biogas bag should be close to the digester to avoid the need for a long gas pipe.
 - Inlets and outlets from the bag must be protected against the run-off from heavy rain storms. Rain water must be stopped from entering the biogas bag. In piggeries where rain water is often used to help to clean the piggery, a rain water drain should be provided around the biogas bag to the previous drainage area. This rain water drain should be open at all times except when waste is being washed from the pens.
 - The plant should be at least 6 m from the piggery to allow work space between the digester and the piggery.
- Pit for the digester : Digging of the hole for the digester should begin at the digester and along the fall of the land. Plan of the pit is illustrated in Fig.30 .

When the hole for the bag is complete, a trench about 22.5 cm wide to depth of within 30 cm from the bottom of the hole should be extended for a further 60 cm from the centre of each side. The bottom of the trench sections should be horizontal. The hole so dug should be carefully cleaned of all sharp stones, tree roots, glass or any other objects which could damage the rubber bag. Fine sand should be made to cover the bottom and sides of the hole to a depth of about 2.5 cm in case the hole is dug in soil which itself contains sharp particles.

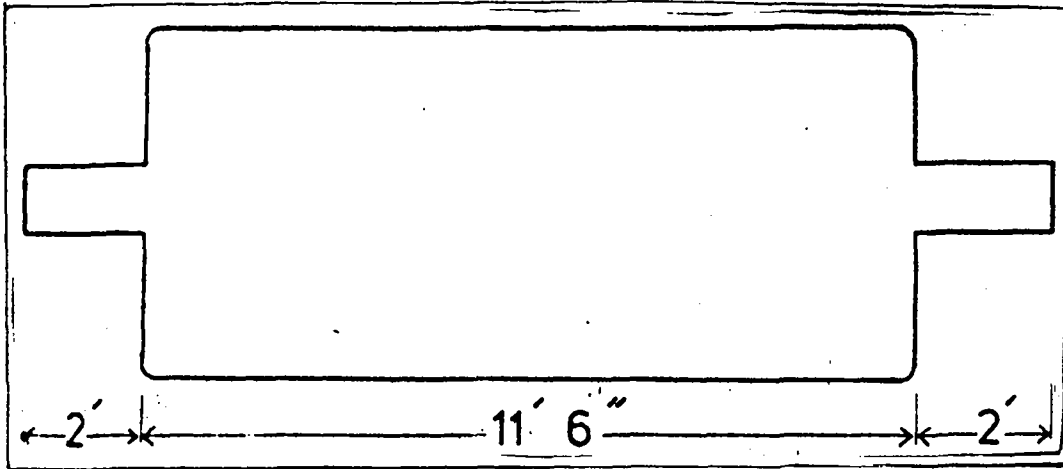

Fig. 30: Plan of the Pit for the Bag Digester

Next, any digging required for the drains from the piggery to the digester inlet, piggery to the rain water run-off area, digester outlet to the digester effluent collection area should be completed. These drains of concrete or PVC may be open or closed. Final concrete work for the channels to the digester should be left until after the digester has been installed.

- Preparing the biogas bag : The polymer rubber digester is prefabricated. Particular attention is required to support the outlet and inlet PVC pipes so that the rubber is not pinched against the rigid PVC pipes or metal bands over these pipes.

The bag should be inflated with air to check for leaks prior to installation, with the help of a portable motorized agricultural sprayer designed to mix air with the spray or dust. The bag may also be tested for leaks with soap or detergent bubble film. Leaks if found must be repaired immediately.

Before laying out the bag in the hole, straight pieces of PVC pipe, in the inlet and outlet elbows must be cemented using the supplied PVC cement. The outlet is the one closest to the gas pipe. A complete 1-2 m length may be cemented into the inlet and cut to size after installation. A 22.5 cm section of straight PVC pipe should be cut and cemented into the outlet elbow. The top "T" pieces should not be cemented to the vertical pipes at this stage.

Installation of the bag :

After the vertical pipes have been cemented into the inlet and outlet elbows, the bag should be laid out carefully along the hole dug. The inlet and outlet PVC pipe elbows should be placed in the trench extensions at the end of the digester hole.

If a source of air is available, the bag should be filled with air taking care to see that the bag is uniform in shape and is not caught in any section of the hole. Particular attention should be paid to the inlet and outlet elbows to see that the PVC elbow rests on the earth at the bottom of the trench extension and that the straight pipes are vertical. In case the bag catches against the earth, air from the bag should be released and the hole re-shaped after moving the bag away from the area.

The bag should then be checked for leaks. Fine sand should be placed around any area in which the bag is not touching the earth, especially around the inlet and outlet elbows. Wetting this sand will help to compact it around the bottom of the bag. The bag should be completely enclosed in sand at least up to the top of the horizontal PVC pipes coming out of the bag.

Water should be added to the bag until the level reaches the bottom of the straight vertical PVC pipe sections in the inlet and outlet.

With water in the vertical sections of the pipes, air from the bag cannot escape past the water. The gas pipe should then be sealed with a stopper or by placing the open end of the pipe in a container of water. The bag is then gas-tight. However, the pressure changes with temperature of the gas, with a resulting change in the firmness of the bag.

If it is not possible to blow up the biogas bag much more, attention should be paid to ensure that the hole is uniform in size. The biogas bag should be placed carefully along the dug hole, pulling the rubber to the edge of the hole. The inlet and outlet pipes should be placed in trenches at the end of each section, making the upright pipe as vertical as possible and then water should be added to the bag through the inlet or outlet are covered. If necessary, sand should be added only around the PVC inlet and outlet pipes to support them if the rubber looks caught. No sand should be added around the bag until some biogas is produced and the bag is filled. By sealing the gas pipe from the top of the bag with a stopper or by placing it in a

container of water, the bag should be made gas-tight. However, it cannot be checked until some biogas is produced.

Drainage channels should be completed as illustrated below in Fig. 31.

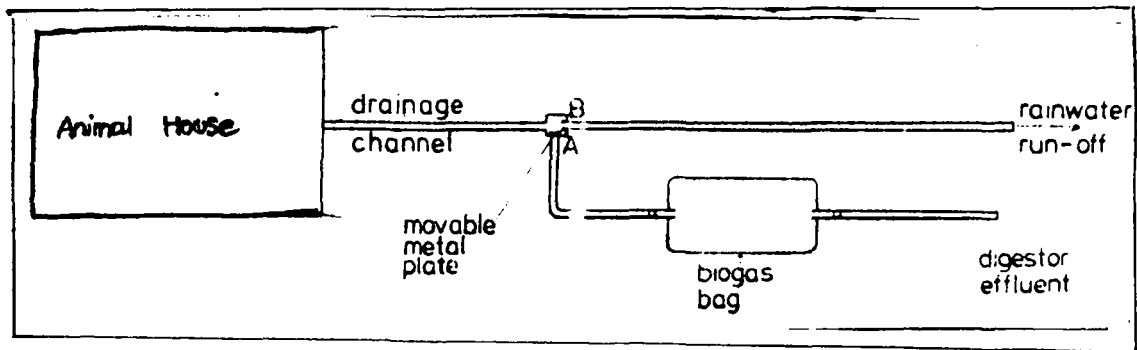

Fig. 31: Drainage Channels

Operation :

- Input: Raw material used is mainly piggery waste.
- Loading: It is a continuous-fed digester. Old faecal matter initially contains higher proportions of methane producing micro-organisms and its use is preferred. In the initial stages there should be as little water added as possible. However, the water level in the digester must be kept at least up to the level of the vertical PVC pipe sections in the inlet and outlet.

Biogas production starts within days, depending upon the substrate.

- Pressure control: Control of pressure of biogas is an important part of the operation of biogas digesters. In most cases, the pressure of the gas increases as the liquid head difference between the slurry inside the digester and that in contact with the atmosphere increases as shown in the following diagram.

Maximum pressure height difference before gas escapes from the digester should be less than 50 cm to minimize the danger of a pressure burst in the digester.

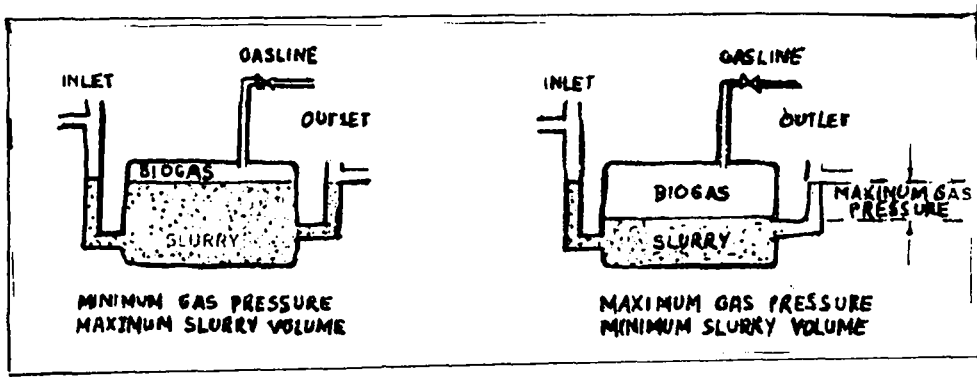

Fig. 32: Pressure in Biogas Bag Digesters

Another means of limiting the pressure is to install a combined water trap-pressure device in the gas line. Simplest of these is the 'T' trap as shown in the figure 30 below, the maximum pressure is equal to the distance of the down-piece of the 'T' beneath the surface of water. A pressure equal to 20 cm head of water should be sufficient to operate most gas appliances. As the water is allowed to overflow from the top of the container, the device functions as an automatic water trap.

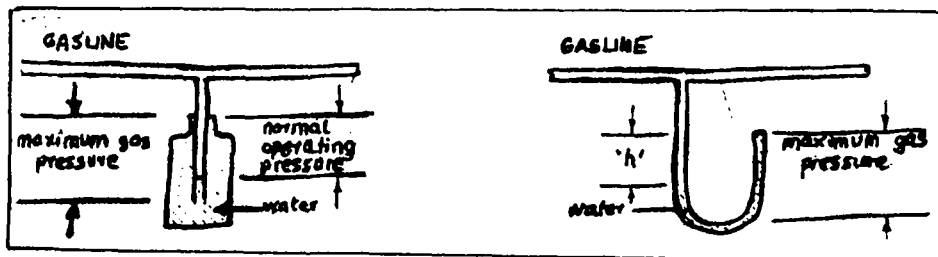

Fig. 33: Water Traps

A 'U' tube at a lower point of the gas line will also act as a water-trap. Water flows from the top of the 'U' at a constant pressure equal to 'L' cm of water. The disadvantage of the 'U' tube is that a pressure greater than 'mh' cm of water in the gas line will expell all the water from the tube and open the gas line to the air, which cannot occur with the 'T' trap. However, the 'U' tube does not function as a constant pressure device.

Repair and maintenance :

Large holes in the polymer rubber digesters are best found by visual inspection.

Small leaks are found after the bag is blown up.

Leaks below the level of the liquid surface appear as a damp patch on the outside of the bag.

Once the bag is filled with air or gas to a small pressure (7.5 cms-15 cms head of water), leaks may be detected with the aid of a bubble film. The bubble film may be produced by placing about 2.5 cm of water containing a small amount of detergent or soap in a plastic bottle and the bottle is shaken until it is filled with bubbles. The bubbles are next squeezed out of the bottle to form a continuous film on a small section of the blown-up bio-gas bag. Wetting the bag may help the bubbles stick. Any leaks are seen as the escaping gas pushes the bubble film aside.

The leak so found may be repaired with the bag either filled with air or deflated. However if it is inflated the gas should be left out from the bag until the top starts to fall in and there is no pressure in the bag. Then a small piece from the patching rubber should be cut so that it is 2.5 cm larger on all sides than the hole to be repaired. It should be ensured that the rubber is dry and both surfaces should be cleaned with a solvent, either petrol or benzene. After both the surfaces are dry, an even film of contact rubber adhesive should be applied to both surfaces until the adhesive is "tacky" to touch. The two pieces of rubber coated with "tacky" adhesive should then be held together for about 5 minutes and the patch allowed to dry for about 12 hours before subjecting it to gas pressure.

In cases of leaks along seams or old patches repairing has to be done carefully. Where a seam comes to the edge of a pitch, special care should be taken to push the patching rubber down to the edge of the seam. Old leaking patches should be completely removed if possible or completely covered with a new patch.

Modifications : (Ref. 1)

The bag digester has been later redesigned as a final product using reinforced concrete and is now called the all-concrete digester (see Fig.34). The digester uses the water displacement method to pressurize the gas. In order to maintain the pressure fairly constant, a water basin is built on top of the digester which makes use of the concrete slab and also maintains the water level in the settling chamber. Algae is also grown in this basin. Such a digester has been built at the Fiji College of Agriculture.

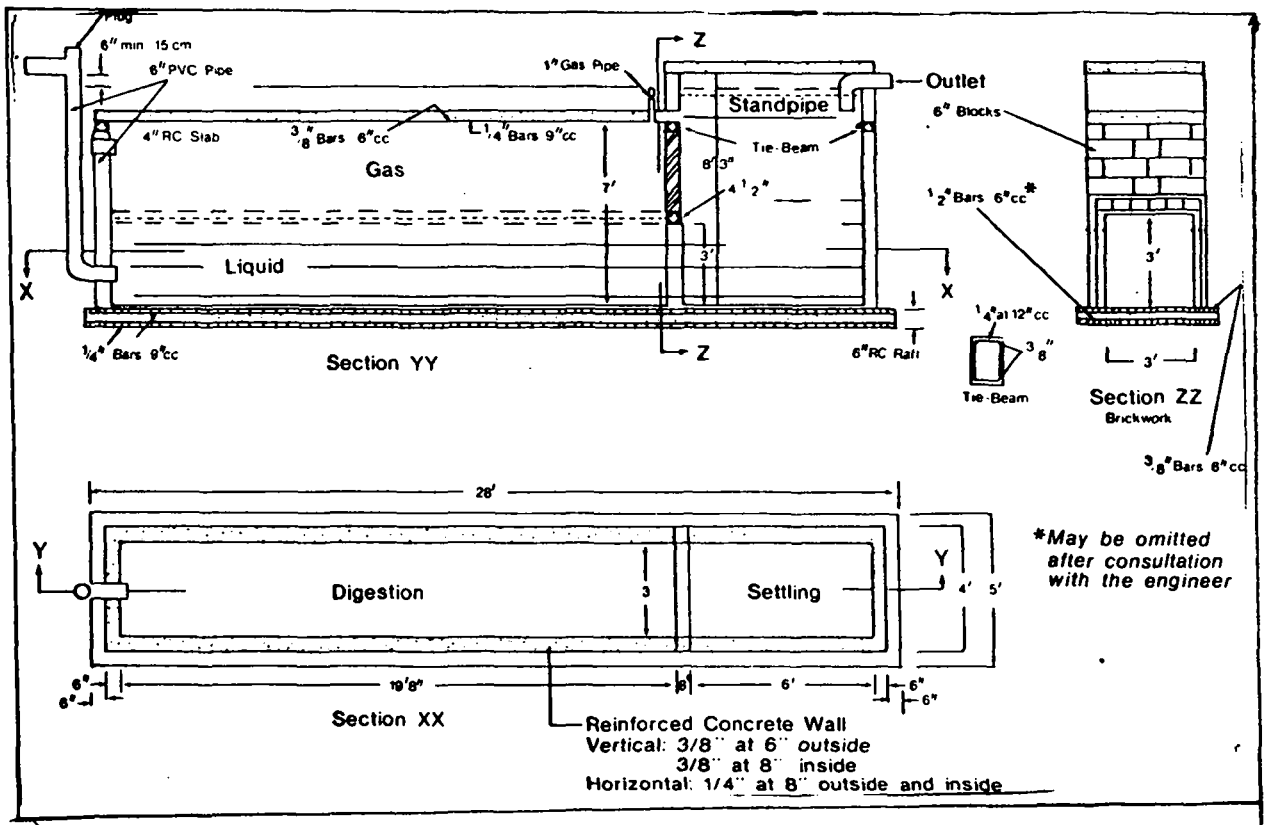

Fig. 34: The 5.6 m³ All-Concrete Digester

For further information contact the following address :

Dr. Chung Po,
Chairman,
International Symposium of Biogas,
Microalgae and Livestock Wastes,
AID/DOAP/CAPD, 37, Nan Hai Road,
Taipei,
TAIWAN (R.O.C.)

RED-MUD PLASTIC DIGESTER

Union Industrial Research Laboratories (UIRL), Taiwan, after years of experimentation and improvement have developed a Red-Mud Plastic (RMP) digester. (Ref. 2)

Characteristics of RMP :

- It is a mixture of red mud, PVC, plasticizer, stabiliser and other ingredients.
- It is elastic in nature.
- It is resistant to ultraviolet light and hydrogen sulfide gas.
- It can withstand tropical weather for 10-20 years unlike PVC.
- It is resistant to strong alkali and dilute acid.

Merits of RMP Biogas Generator :

- It is easy to manufacture, install and transport.
- It can be easily cleaned and nearly no maintenance is required.
- Its construction cost is low.
- Scum formed during fermentation sinks to the bottom of the RMP generator.

The generator volume required at a fermentation temperature of 40°C is shown in the following table.

Table 6 : RMP Generator Volume Requirement at 40°C

Volume M ³	dia. x L(m)	Suggested No. of pigs
15	1.6 x 8.0	30
20	2 x 6.5	40
30	2 x 9.5	60
50	2 x 16	100
100	2.5 x 20	200
200	3 x 28	400
250	3 x 35	500
500	4 x 40	1000
1400	5 x 71	2800

For further information please contact :

Dr. Tsu-Fu Wang,
Head of Dev. Dept. ,
Union Industrial Research Laboratories,
Industrial Technology Research Institute,
1021 Kuang Fu Road,
Ksinchu, Taiwan,
REPUBLIC OF CHINA.

MAYA FARMS INNOVATION

The biogas plant described here has been designed by Mr. F.D. Maramba, Sr., Maya Farms Division of Liberty Flour Mills, Philippines.

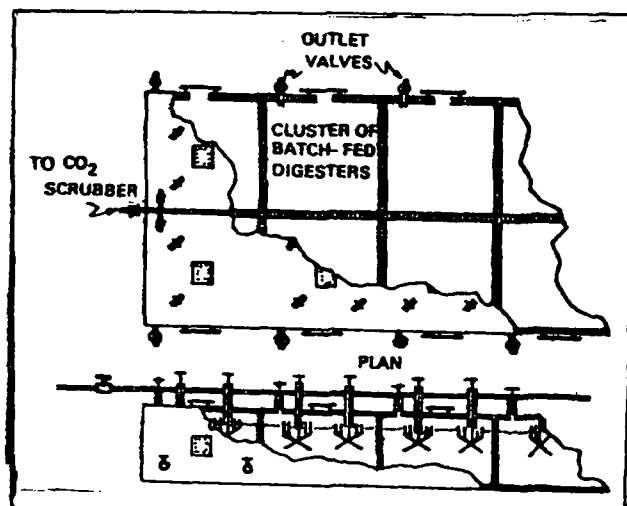

Fig. 35. Biogas Plant Design (Maramba)

Description : (Ref. 3)

This consists of a cluster of digesters, as many in number as the number of days retention time plus one. The capacity of each digester is equal to the daily available fresh slurry plus the necessary starter so that the digesters can be discharged and recharged once a day, one after another, to ensure a continuous supply of biogas.

The digesters are built so that side walls are shared by adjacent digesters. The digesters are cubical in shape and built above ground, which facilitates unloading. Feeding is done on a batch-fed basis. Liquid sludge is drained out through side outlet pipes and fibrous material removed through side manholes.

For further information please contact :

Mr. F. D. Maramba, Sr.,
Maya Farms Division,
Liberty Flour Mills, Inc.,
Metro Manila,
PHILIPPINES.

References :

1. Chan, George. "Integrated biogas development: Fiji". In Biomass energy projects - planning and management edited by Louis J. Goodman and Ralph N. Love. New York, Pergamon, 1981, p.130-131.
2. Hao, Paul, L.C. and others. Design and development of a red-mud plastic digester. Taiwan, Union Industrial Research Laboratories Industrial Technology Research Institute, n.d. 7p.
3. Maramba, Sr. Felix D. Biogas and waste recycling: The Philippines experience. Metro Manila, Maya Farms Division, Liberty Flour Mills, 1978. p.76.
4. Solly, R.K. Manual for installation and operation of biogas bag digesters. Suva, University of South Pacific, Institute of Natural Resources, n.d.

BIOGAS UTILISATION

Properties :

Biogas, which has the following properties can be used as a fuel for cooking, heating, lighting and running engines.

The properties are -

- Non-poisonous nature
- Burns with clean bluish sootless flame
- No offensive smell
- Has a very high octane rating
- Easy to produce
- Boiling point : - 161.5°C
- Critical temperature : - 82°C
- Critical pressure : 42 atmospheres
- Calorific value : 4700-6000 kcal/m³ (20-24 MJ/m³)
- Specific gravity : 0.86
- Wobbe No. : 732
- Flame speed factor : 11.1 (This is a low figure and hence the flame tends to "lift off" burners which are not properly designed)
- Inflammability in air : 6-25% biogas mixed with air will burn. (This is a relatively narrow range and thus biogas is safer than any other commonly used household gases)
- Thermal efficiency in standard burner : 60%
- Has higher heating value than producer gas, coal gas, and water gas.

Some of the uses and biogas requirements for various purposes are given below :

Table 7: Biogas consumption for various purposes

Application	Specification	Consumption of m ³ /hr
Cooking/person/day		0.336-0.42
Lighting (40 CP/amp/hr)		0.28
Gas Engines (for running/hr/horsepower)		0.448-0.504
Generating/kwh electricity		0.616
Gas stove	5 cm. dia. burner	0.322
	10 cm. dia. burner	0.462
	15 cm. dia. burner	0.63
Gas lighting	1 mantle lamp	0.07-0.084
	2 mantle lamp	0.14
	3 mantle lamp	0.168
Refrigerator	45 cm x 45 cm x 360 cm	0.042-0.056
Boiling water		0.28/gallon

The following is a comparison of calorific values of fuels :

Table 8 : Calorific value of biogas and other major fuels

Fuel	Unit	Calorific value	
		(MJ)	(kcal)
Biogas	m ³	20	(4700)
Electricity	kWh	3.6	(860)
Kerosene	litre	38	(9100)
Charcoal	kg	29	(6900)
Firewood	kg	20	(4700)
Butane	kg	46	(10900)
Cattle-dung cakes	kg	8.8	(2100)

The following illustrates the uses and equivalents of biogas.

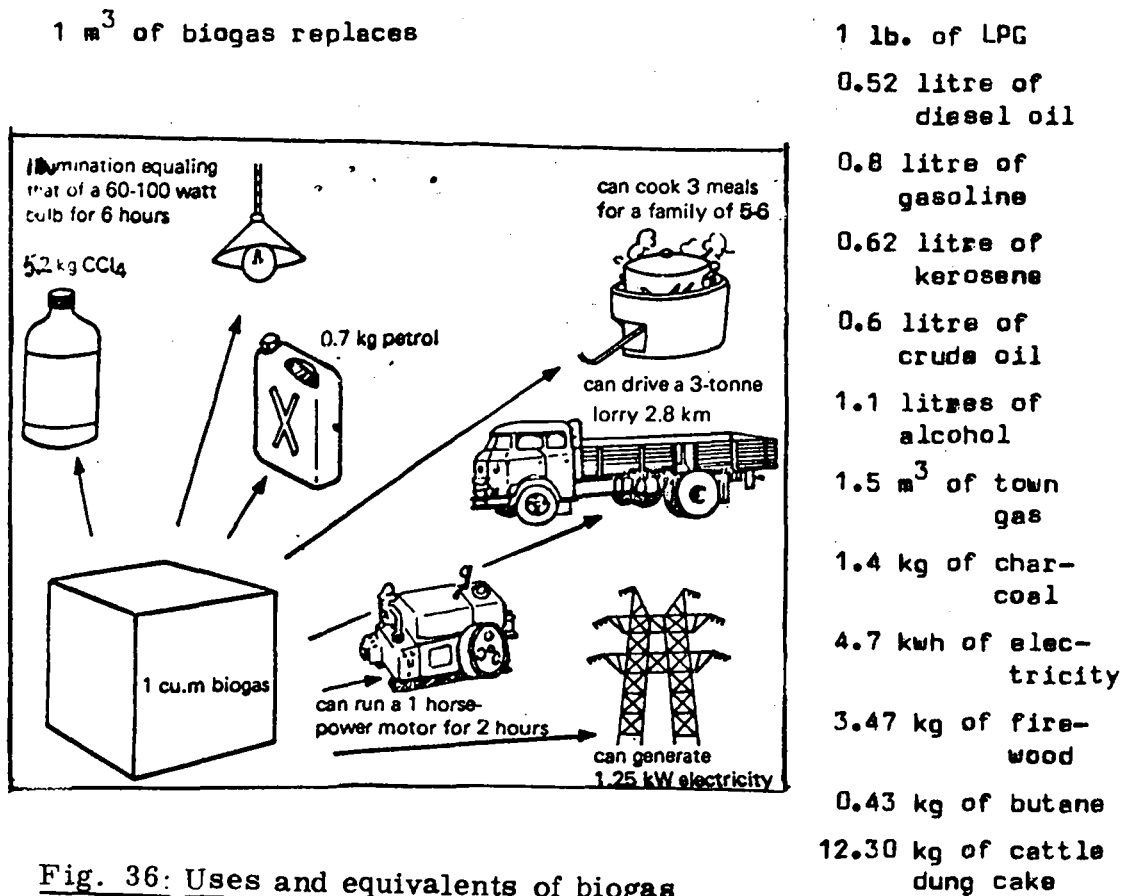

Fig. 36: Uses and equivalents of biogas

Utilisation devices :

Burners and stoves :

Biogas cannot be burned on the stoves used for natural gas or any petrol-based gas. Its flame speed factor is slower than natural gas and thus when biogas is fed to a burner built for natural gas the flame tends to lift off from the burner. Biogas fed at a lower pressure would stay on the burner, but may not burn efficiently and less heat would be recovered from each cubic meter of the gas.

The following are some of the factors to be considered for designing biogas stoves :

An appliance for cooking or lighting should have the following characteristics :

- Inlet channels should be smooth to reduce the resistance to flow of gas and air;
- Spacing and size of air holes should be suitable;
- Volume in the channel where the gas and air mix together should be large enough to allow complete mixture;
- Gas jet holes should not be too large but should allow easy passage of the mixed gas and air, to allow complete expulsion;
- Appliance should be simple, economical and cheap to make.

To use the gas efficiently, it is necessary to design a gas burner taking into account the following :

- Composition of biogas (60% methane and 40% carbon dioxide);
- Pressure of the gas (8.75-10 cm water column pressure);
- Flame velocity.

The following rules should be observed :

- Air must be thoroughly mixed with gas before it reaches the flame ports and should flow near the gas jet, ideally with a venturi. (In the absence of sufficient air there is a smell from the burning gas)
- Total area of the flame ports should be between 8-200 times the area of the gas jet.
- Distance from the flame ports to the surface of the cooking pot should be between 2.5 cm - 3.0 cm.
- Supports for cooking pots should not prevent air from getting to the flame.
- To allow cross-lighting from one flame port to the next, the distance between flame ports should not be more than 2.0 cm.
- To prevent back firing, the thickness of materials at the flow cork should be about 1.0 cm.
- For corrosion-resistance properties, cast iron is better than mild steel.

Dimensions for a 0.45 m per hour family-size stove :

Jet size : 2.25 mm dia.

Area of jet : 3.98 mm²

Flame port size : 6.0 mm dia.

Number of ports : 20

Total area of ports : 565 mm²

Ratio of jet area to flame port area : 1:142

Length of gas mixing pipe : 20 mm

Diameter of gas mixing pipe : 20 mm

Some simple designs :

Watson Type Burner

Watson House Laboratory recommends a burner with a flame port-area (sum of the areas of individual flame ports) to injector area ratio of about 300:1. Using a burner with 36 ports of 0.114 inches diameter each, injectors with orifice diameters of 0.038 and 0.041 inch respectively and supplying the gas at pressure ranging from 3 cm-20.5 cm water guage, efficient stable flames can be obtained. See Figure 37.

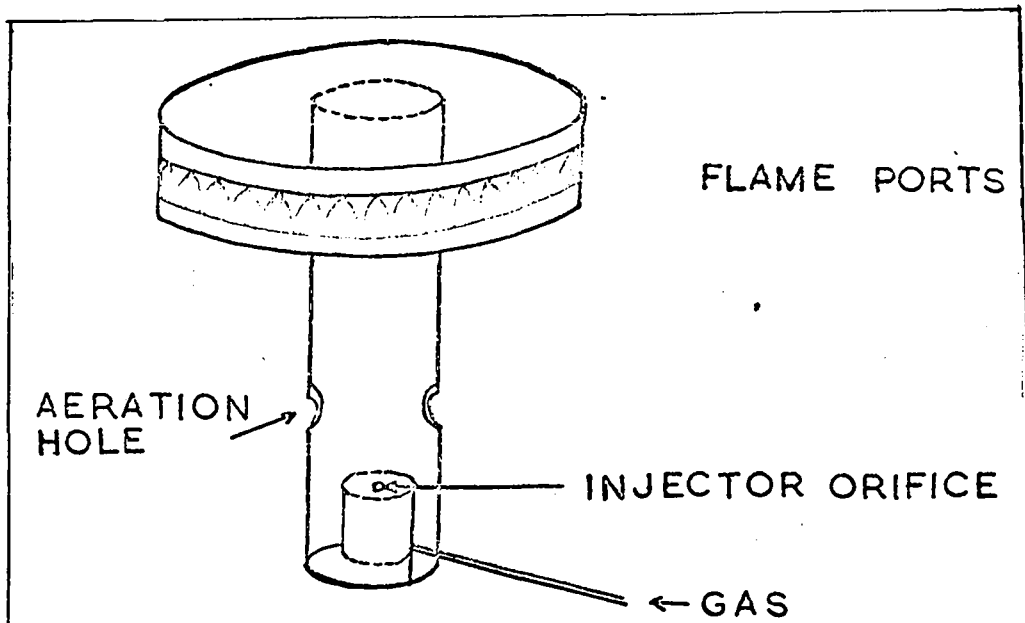

Fig. 37: Burner (Watson-type)

The IARI burners

The Indian Agricultural Research Institute has designed the following cheap and simple burners which can be easily fabricated.

- Tin Burner : This can be made from an empty cigarette tin by boring a 0.7 cm hole in the side, about 2 cm from the bottom, and soldering a 7 cm long tube of this diameter with 3 cm inside and 4 cm outside. The lid is perforated with a 2 mm nail in a circle of 4 holes with one hole in the centre. The tin is filled with a few stones for distribution of the gas. Gas passing inside the tin through the tube burns from the perforations at the top and yields a good flame for cooking. The burner is introduced in an earthen 'chulah' on which is placed the cooking pot.
- Angithi burner : This can be fabricated from flat tins of the size of the usual boot polish tin or larger flat tins. A 0.7 cm metal tube bent at right angle is soldered in a hole made in the bottom of the tin. The cover of the tin is perforated with 2 mm holes.

However tin stoves have certain disadvantages such as less efficiency, low temperature and tendency to rust quickly. Both the efficiency and temperature could be increased by making holes in the bottom of the tin to let in air and putting some stones inside to help mix gas and air.

- Low-cost burner : This simple burner made of cast iron can be used in different arrangements in order to suit various specific purposes.

This 5 cm burner weighs about 700 grams, the weight of which can be reduced to 400 grams by reducing the wall thickness. It has a flat base and can be kept on the floor. Gas-mixed air is introduced through a 0.6 cm diameter pipe of about 15 cm length having two holes of 0.6 cm through which air is drawn by the gas stream which emerges from a jet having a bore size of 0.2 cm.

Flame temperature of the order of 75⁰C has been obtained with this burner. The gas consumption is 2-4 ft /hour at usual gas holder pressures. The maximum efficiency of the burner has been worked out to be about 75% under optimum conditions.

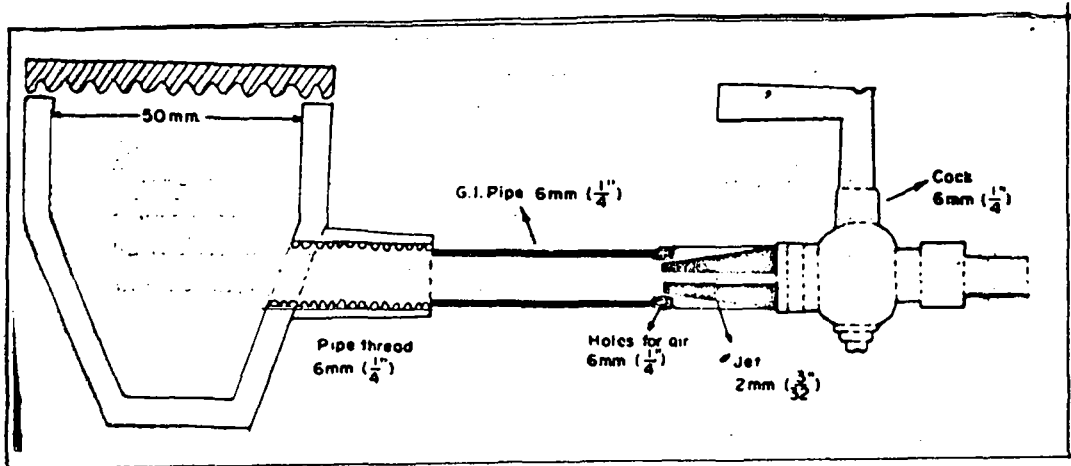

Fig. 38: A 50 mm IARI Burner

This burner can be conveniently used in many ways, the most convenient arrangement being a double burner for domestic use. A still simpler and cheaper arrangement is to keep a **single** burner surrounded by an earthenware ring to prevent the flame from air drifts (See Fig.38)

For permanent ovens, the burner arrangement becomes much cheaper. The burner with the supporting pipe can be directly fitted over the gas line projecting upright. A brick and clay surrounding makes the oven complete. This type of arrangement is most suitable for group cooking like in messes, restaurants, etc. At such places the capacity of the burner required is much higher and 7.5 cm or 10.0 cm diameter burners could be used on a similar design.

A 7.5 cm burner () has been made at IARI, incorporating provision for a 1.2 cm pipe in place of a 0.6 cm pipe and a jet size of 0.3 cm instead of 0.2 cm with 4 holes of 0.6 cm in front of the jet for air intake which was increased to four.

A conventional 7.5 cm to 1.2 cm pipe-fitting reducer can be conveniently used by getting the top 7.5 cm covered with a mild steel sheet by welding and by providing about 30 holes of 3 cm diameter on the circumference 7.5 cm side. The 1.2 cm side could be used for fitting a 1.2 cm nipple (about 15.0 cm in length), the other end of which can accommodate a jet, and holes for air can be made in the nipple.

The following are designs of some common burners manufactured in India.

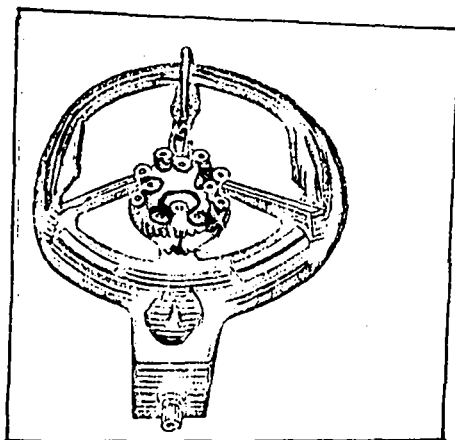

Fig. 39: Gobar Gas Deluxe Burner
(225 litres/hr)

This is the smallest of biogas burners using 225 litres/hr (0.225 cu. m/hr) of gobar gas. It burns with an intensity equal to half that of a kerosene pressure stove.

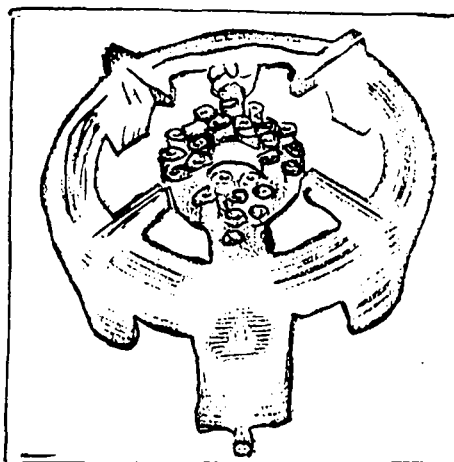

Fig. 40: Gobar Gas Deluxe Burner

This is similar to 39 but bigger in size, the gas consumption being 450 litres (0.448 cu. m.) per hour.

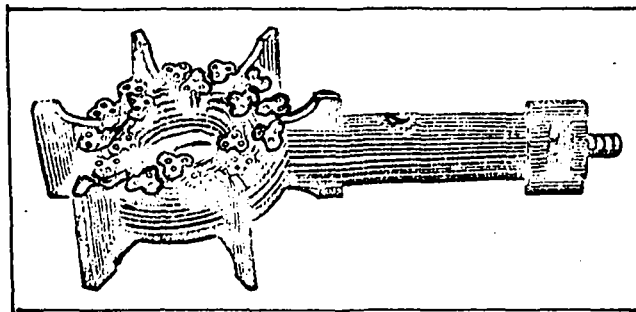

Fig. 41: Gobar Gas Angitti Burner (1130 litres/hr)

This burner uses 1130 litres/hr (1.2 cu. m./hr) of biogas. It is useful for community kitchens or hostels and institutions and can be used for industrial heating.

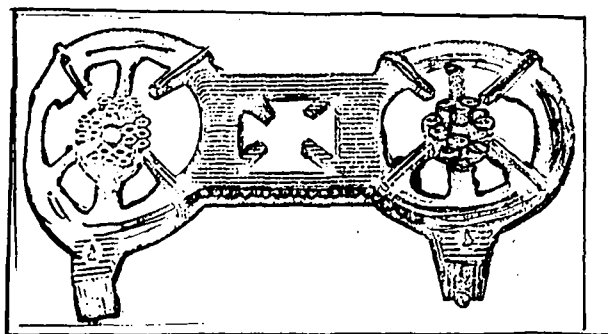

Fig. 42: Gobar Gas Double Delux Burner

This set of two burners uses 450 litres/hr. (0.448 cu. m/hr) of biogas each and burns with an intensity equal to that of kerosene pressure stove.

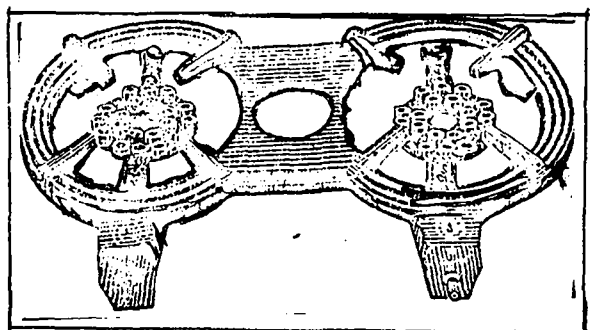

Fig. 43: Gobar Gas Double Deluxe Burner
(Economy-Size)

This set is a combination of two burners out of which one will use 450 litres/hr (0.448 cu. m./hr) and the other will use 225 litres/hr (0.5 cu. m./hr) of biogas.

Fischer's Burner

Duncan Fischer has designed an efficient burner that can be made by the village blacksmith. The burner consists of a length of 1 cm diameter iron pipe of 15-25 cms. The length of this pipe is determined by the size of the container (stove) which supports it. It can be secured to the stove in any satisfactory manner with bolts or wire. When properly situated in the stove, the flame spreader support will rest at a distance of 2.5 cm below the vessel to be heated. An ideal spreader support is a bicycle bell drilled to slip over the end of the burner pipe. This provides a shield for the flame, making it less subject to the effect of air currents generated by the rising heat. The spreader cap is a piece of bell-shaped metal perforated with small holes to cause the gas to be spread out as it escapes around the circumference of the pipe.

To make this gas inlet jet, the burner pipe is to be closed with either brass or lead between the gas cock and the air intake holes, after which a hole $1/16''$ in diameter is drilled through it to provide the jet. The diameter of this hole should be precise as the mixture of air and gas in the proper proportion depends on it.

The burner is secured to the mainline either with a standard fitting or a short piece of rubber tubing. The gas supply is turned on and off with a gas cock, the most suitable one being threaded at both ends to receive a 15 cm pipe. At a point in the mainline ahead of the gas cock a small piece of wire gauze may be fitted into the mainline to prevent the possibility of a flashback. The gauze will absorb and extinguish a flame should it occur below the burner.

Wood burning stove adaption :

A common village wood burning stove may be adopted by inserting a pipe and filling the stove with stones as seen in Fig. 45. Air can be controlled with a piece of wood placed over the front hole.

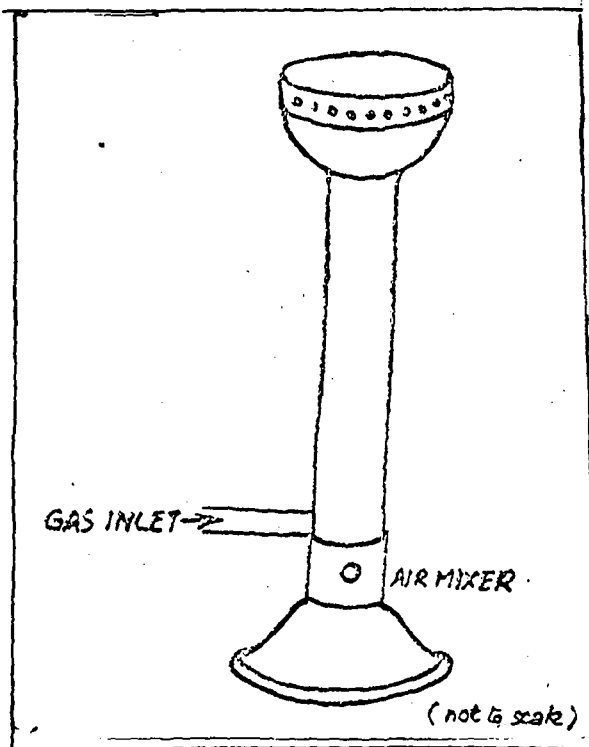

Fig. 44: Fischer's Burner

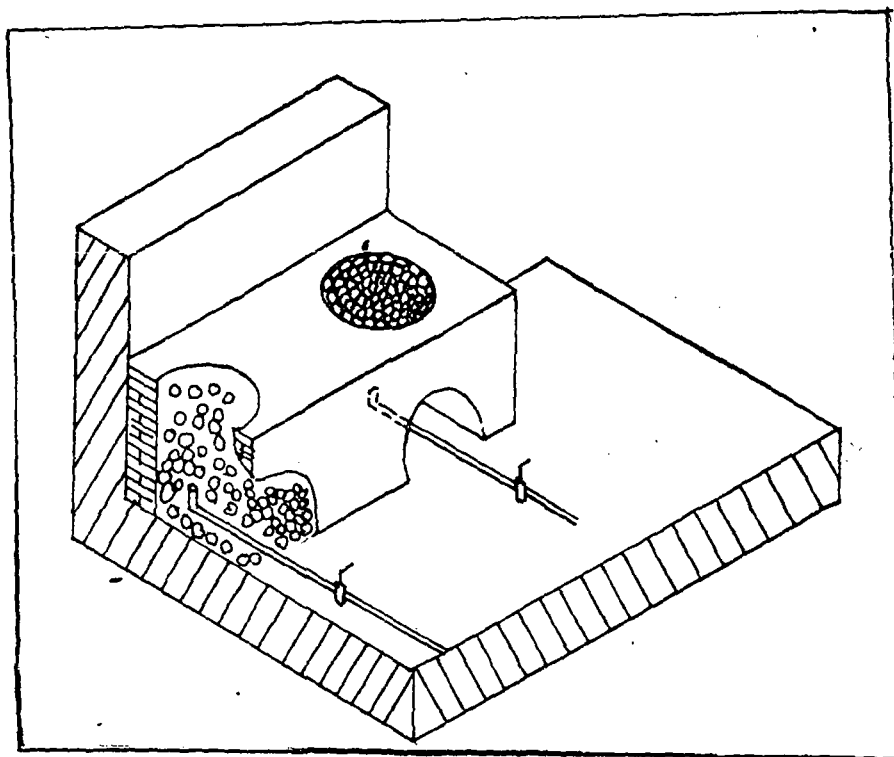

Fig. 45: Adaptation of Wood-Burning Stove

Chinese clay or cement stoves :

- Shower head burner : It has a strong and concentrated flame. The diameter of the shower head is 4-8 cm. and the diameter of the base is twice that of the top. About 30 burning holes or flame ports each 0.15-0.2 cm. in diameter are made, in three or four rows. The air inlet is about 0.1 cm. long and 0.5 cm. wide. Gas/air ratio is usually changed by varying the position of the gas nozzle relative to the air inlet.

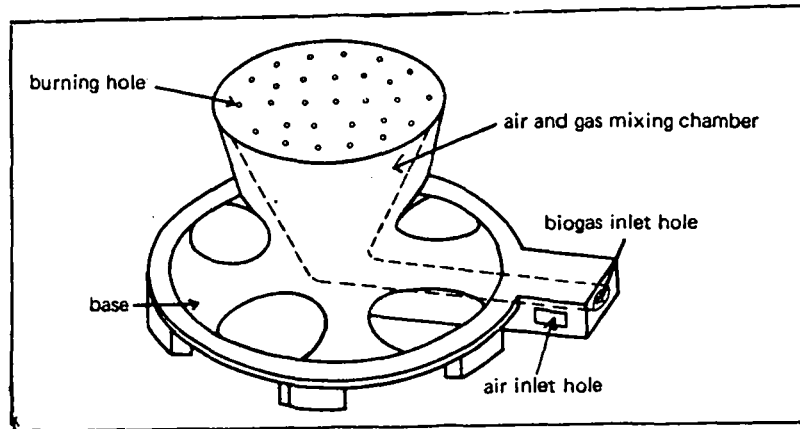

Fig. 46. Shower Head Burner

- L-shaped burner : This is a variation of the above type of burner. It consists of a base, shower head and an L-shaped gas-inlet pipe. This burner is controlled by a three-pipe mouthpiece. Its advantages are that the flame is strong and short and economises on gas functions readily.

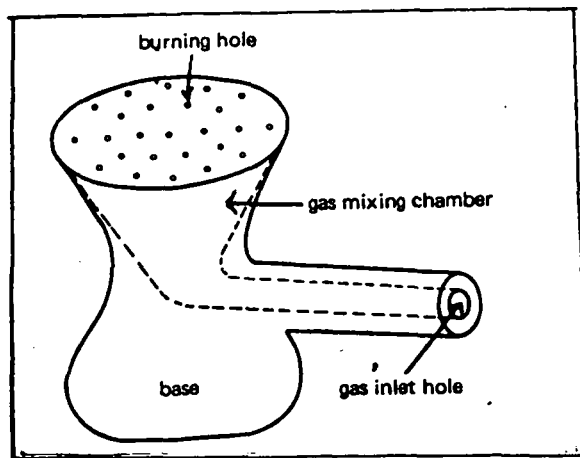

Fig. 47. The L-Shaped Burner

- Hour-glass-shaped burner : This can be made simply by mounting a steel shower head 5-7 cm. in diameter on to a base made of triple concrete.

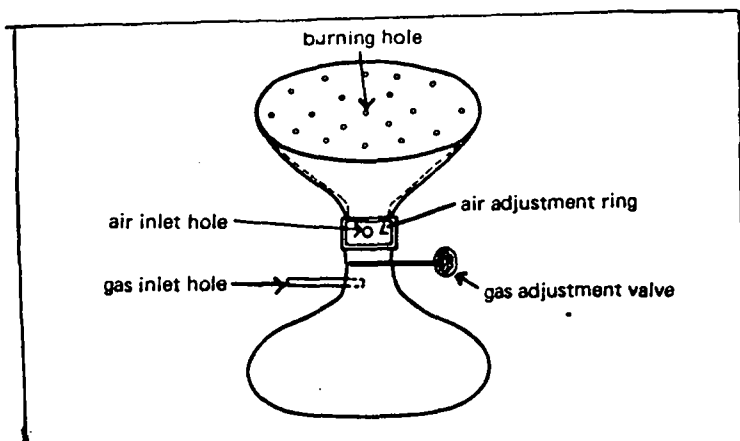

Fig. 48: Hour-Glass Shaped Burner

- Drum burner : Any easily available material can be used to make a cylindrical drum 15-20 cm. in diameter. The inside forms the gas/air mixing chamber and hence should be empty. On the top there are about 30-40 bearing holes drilled from the inside, outwards. At the lower end of the drum is a gas inlet hole 0.6-0.8 cm. in diameter. A 10-15 cm. long tube may be fitted into this hole and the tube may have a hole 1 cm. long and 0.5 wide to serve as the air inlet hole.

As the biogas and air mix properly in the drum mixing chamber before burning, combustion in this type of burner is very efficient.

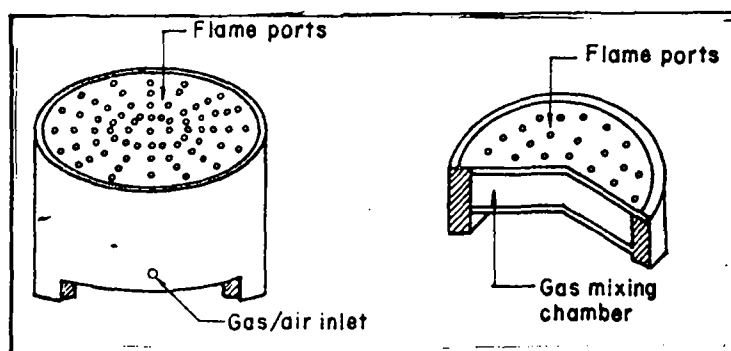

Fig. 49: Drum Burner

- Revolving burner : This burner has a base and a cover, an air inlet hole at the centre and an enclosed ring for circulation of gas and air. To one side there is a gas and air inlet hole and the cover consists of the burning holes.

To construct this burner, a mould is made from clay and fine cinder powder. A circular base with a 2 cm. diameter air hole in the centre is made. Around the air hole along the top, a circular groove 1 cm. in diameter is made. Then according to the size of the burner a cover is made in which there is an air hole the same size as that in the base. In the region surrounding the air hole a number of holes, 1 cm. in diameter, are drilled putting in 3 holes for every 2 cm. Then the cover is fitted on the base and the interfaces sealed airtight.

During burning, gas is ejected from the holes, with a continual supply of air from the hole in the centre. As there is a good supply of air, the flame is strong.

- Long-arm burner : It is an adaptation of the natural burner. It gives a strong flame and is simple to construct. Iron and aluminium pots can be used on this burner.

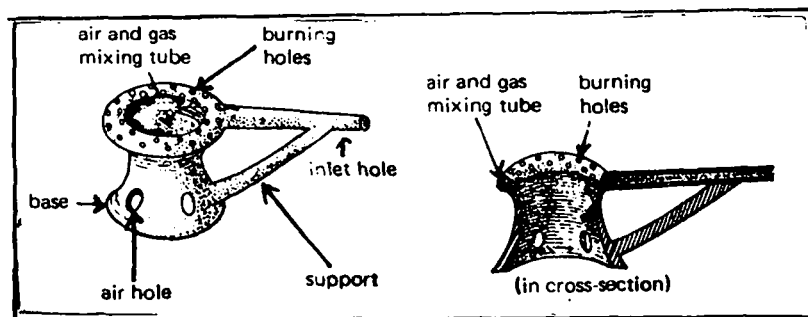

Fig. 50: Long-Arm Burner

- Double-ringed burner : This type of burner is suitable for iron frying pans. It's similar to the long-handled burners, but the inner ring is slightly smaller than the outer ring and also a little lower.

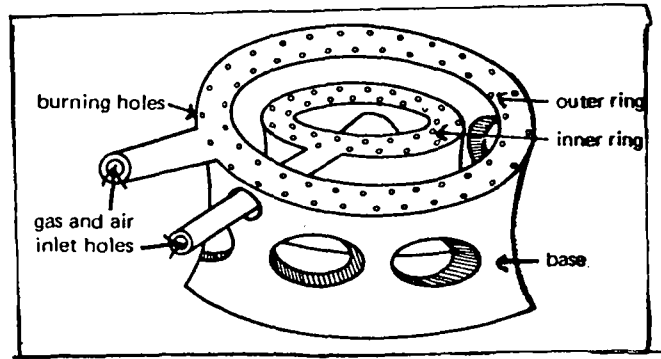

Fig. 51. Double-Ringed Burner

- Biogas stove with cooking vessel built into it : In this, the gas is led directly into the cooker with the gas jet pointing directly at the bottom of the iron or aluminium sauce-pan. The mouthpiece is inserted through a hole in the bottom of the stove cavity which also lets in a suitable amount of air for mixing and burning with the stove cavity. A certain distance between the mouthpiece and the hole in the bottom of the stove must be maintained to achieve a proper mixture of air and gas in the cooker and around the bottom of the sauce-pan during combustion.

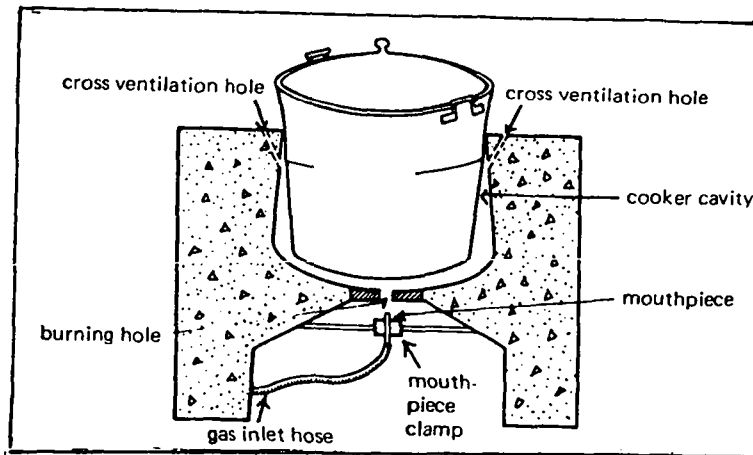

Fig. 52: The Biogas Stove

All-Metal Fabricated Stoves :

Nepali biogas chula

The main features of this device are :

- it has a unique "turnover" support for flat or round-bottomed cooking pots;

- consumes 0.45 m³ of gas per hour;
- it is easy to clean by removing burner caps;
- it uses cast iron burner for long life;
- it has simple and easy to operate air adjuster for maximum gas burning efficiency.

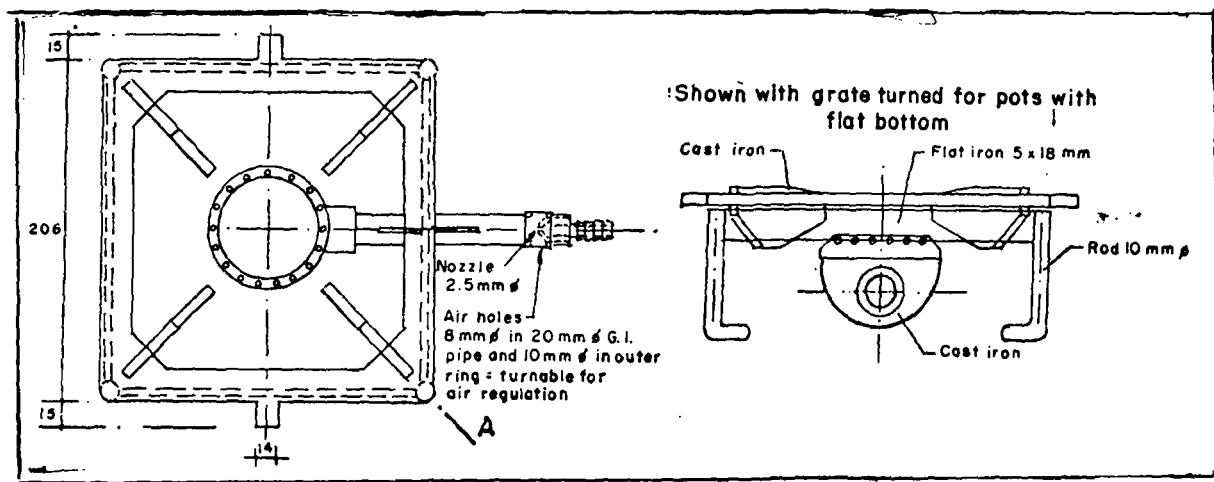

Fig. 53: Nepali Chulo

Testing the biogas burner :

When the burner has been completed and is ready for testing, a few simple procedures should be followed. Biogas burns even without a burner if a lighted match is held to the end of the pipe where gas is escaping. In order that the flame maintains itself it is necessary to have a proper mixture of air and gas escaping at the top of the burner. The mixing is accomplished at the bottom of the burner where the gas mixes with the air as it passes the air inlet holes. With the burner fitted to the main line and with the gas cock open the flame should maintain itself when a lighted match is applied and then drawn away.

If on the first trial the flame does not support itself, the gas cock should be closed slightly to reduce the volume of gas passing through. The volume of gas, if excessive, will be out of proportion with the proper volume of air and will thus blow the flame out, when the match is removed. Also, same problem arises, if the number of air intake holes is out of proportion. Covering two or more air holes should determine if an excess of air intake is the problem. If it can be determined by the above procedure that the volume of gas is too much, the size of the gas

inlet jet should be reduced with a few light taps of a hammer on the surface of the jet. Ideally it would be desirable to have an insufficient volume of air intake in the beginning and then to gradually increase the volume of air by drilling additional holes until an efficient flame is produced.

Insulation of biogas ovens and stoves :

As much of the heat produced from the burning of biogas is lost through convection and conduction, it is best to build stoves out of materials with low heat conductivity and which are fire-resistant. Placing the ring, or jet, inside a stove, of some sort may prevent any incompletely combusted gas/air mixture from escaping by keeping it in the stove cavity to burn more completely.

Operation of stoves :

After connecting the stove to the gas tap, using a rubber tube, the air adjuster should be closed fully. A match should be lit and applied to the flame ports before the gas tap is opened fully. The cooking vessel should be put on it next. In case the flames are weak and long and rise over the vessel, the air adjuster should be opened to admit some air to the point when the burning gas will create a noise. The air adjuster should then be closed till the flames are about 2.5 cm-3.0 cm and the upper cone of the flame touches the cooking vessel for efficient burning.

Maintenance :

The flame ports should be cleaned out when necessary. When a removable flame port cap is not fitted, the stove should be held upside down to prevent any dirt from getting inside and also to remove dirt which has fallen inside.

Lighting :

Biogas lamps are mainly useful in unelectrified rural areas. Most of the biogas lamps are about 100 candle-power and use 0.11-0.15 m³ gas per hour.

Types of biogas lamps :

- Single mantle lamps (Indian) : The mantles are soft and are not expensive. There are two types of these -
 - inside type with simple cover, which is about 100 candle-power (approximately 60 watts electric bulb).
 - outside type with cover to protect it from wind and rain, which is about 100 candle power.

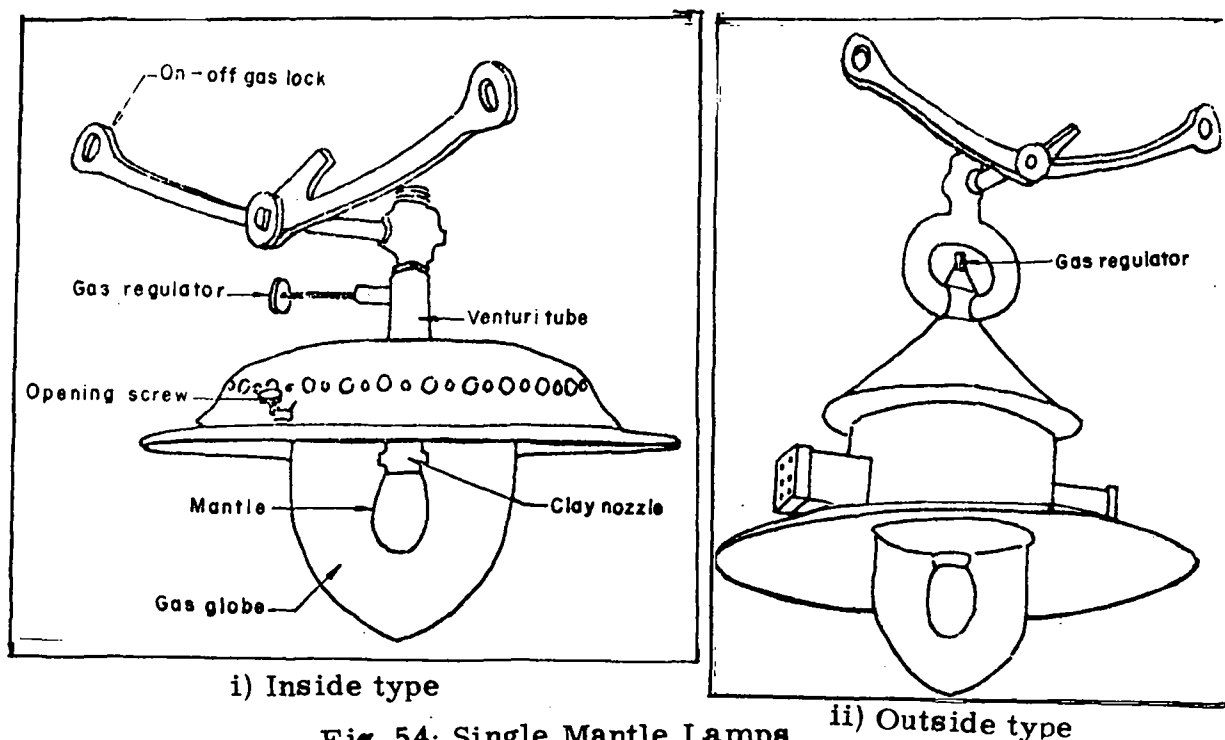

Fig. 54: Single Mantle Lamps

- Double mantle lamps (Indian) : Mantles are preformed and expensive and are of two types -
 - inside type has 2 mantles, 100 candle-power with simple cover.

However it has a large hole in the base of the glass globe which allows insects to fly inside and break the mantles. These are available as a ceiling mounted model (Fig. 55) and a table model (Fig. 56)

- outside type has two mantles, 100-candle power with cover to protect it from wind and rain.

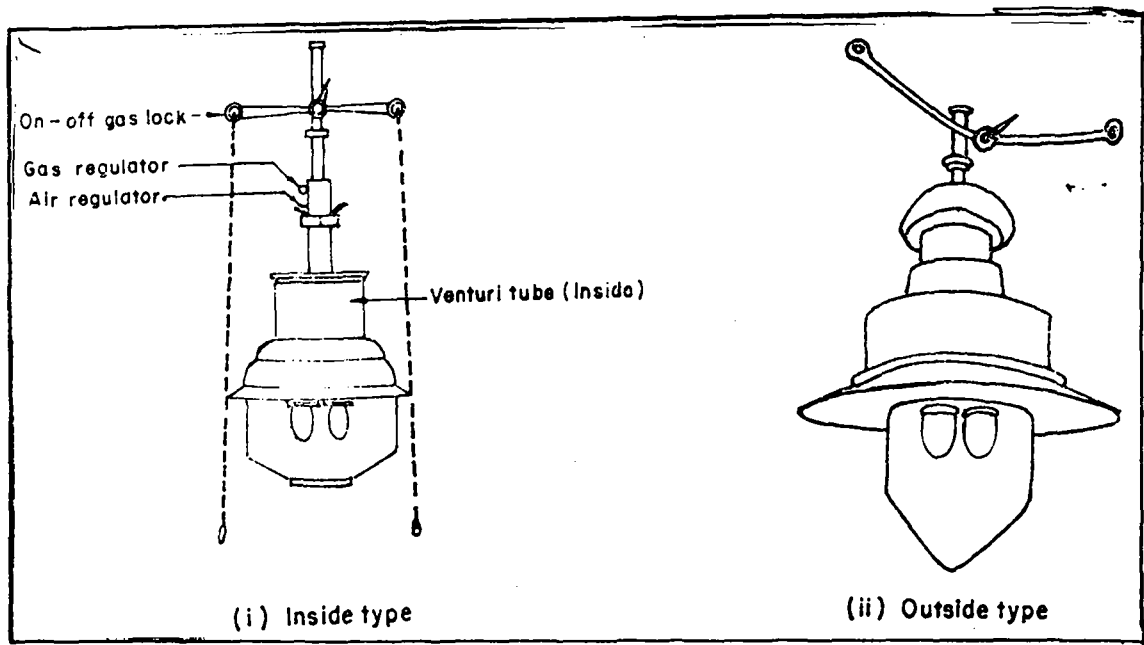

Fig. 55: Double Mantle Lamps (India)

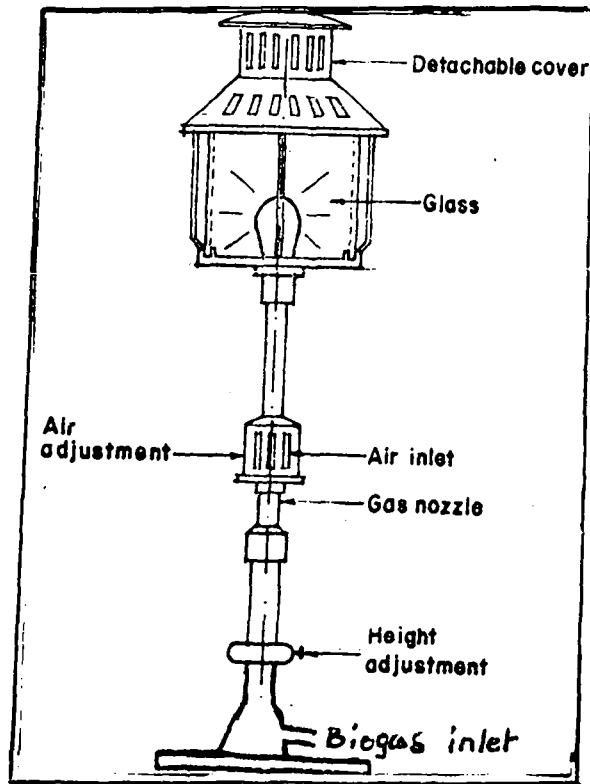

Fig. 56: Biogas Table Lamp (Pakistan)

- Biogas lamp (China) : It is quite simple and consists of four parts :
 - an aluminium tube about 10 cm long and 1.5 cm in diameter with four air holes of 0.3-0.4 cm a little below the top of the tube which is open;
 - a gas diffuser held at the bottom of the aluminium tube, to which the mantle is attached;
 - a disc reflector with a glass globe fits at the bottom of the aluminium tube just above the diffuser;
 - a slim glass or plastic tube, 12 cm long and looking like a pipette and which slips into the aluminium tube and its top end is connected through a plastic pipe to the gas mains.

In the clay biogas lamp the tube and the gas diffuser are made in one piece from clay. The reflector is also made of clay to reduce the cost.

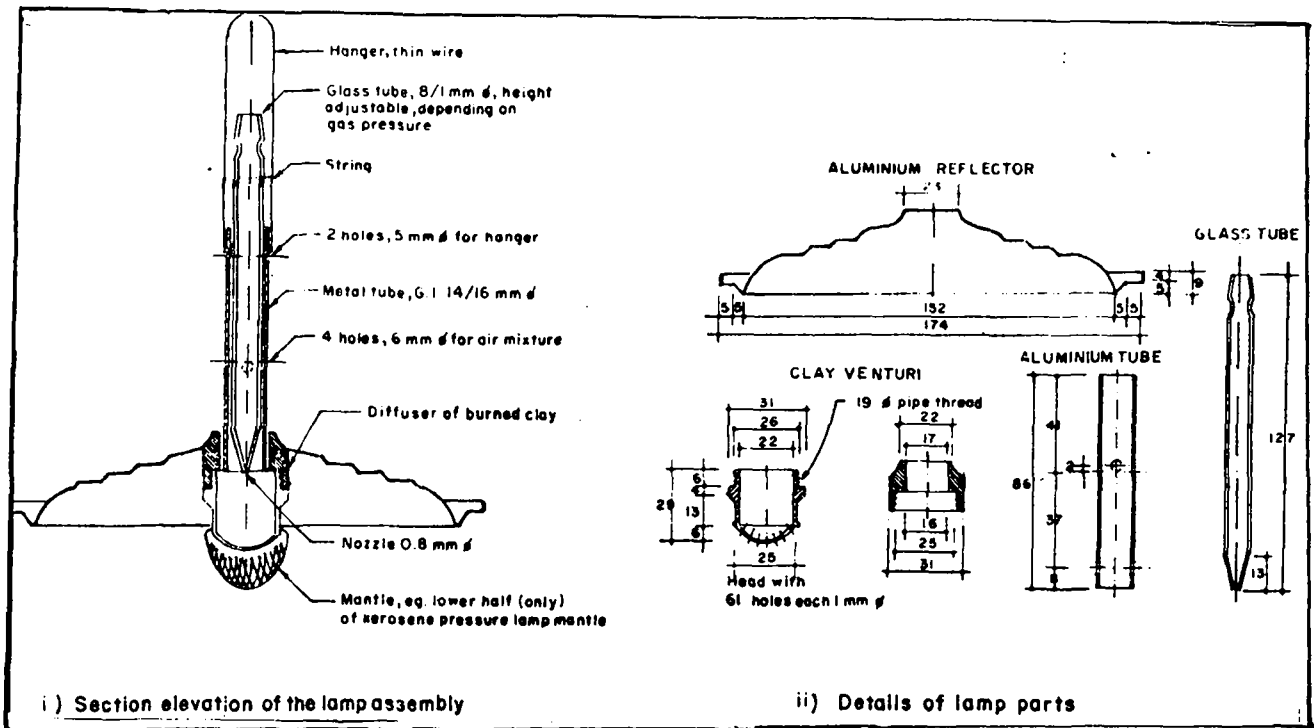

Fig. 57. Simple Biogas Lamp (China)

- Table lamps : These are best fitted halfway up a wall and burn very brightly. As the gas enters from below, the gas hose is not exactly damaged.

Mobile lamp : It is quite efficient. In this case the head is pointed upwards. The first time it is used, it must be turned upside down, the mantle allowed to set in its shape and then turned over and used.

Operation of lamps :

The lamp is opened and the clay nozzle (venturi) is fitted. The mantle should be opened to form a hollow ball and tied to a venturi. The gas cock and regulator may be opened fully and the mantle lit and allowed to burn. The lamp may be closed once the mantle starts burning.

The lamp should be heated up till it makes a noise and the regulator adjusted till the mantle is at its brightest. It is not necessary to adjust the gas again until the mantle is changed.

The gas cock should be closed to turn off the lamp.

To relight the lamp, first the match should be lit and applied close to the mantle either through the hole in the bottom of the glass globe or by opening the reflector and then the gas turned on. (Explosion may occur if the sequence is reversed). After heating, the lamp gives a good steady flame.

When a new mantle is to be fitted, the clay nozzle should be removed and the venturi tube thoroughly cleaned out of any insects, cobwebs, carbon or dirt. The reflector and the gas globe should be washed with soap and water, whenever necessary, and left to dry completely before the lamp is lit as otherwise the glass may crack and the surface of the reflector may go dull.

Maintenance of lamps :

Dirt, especially insects' nests in the venturi tube should be thoroughly cleaned using a piece of cloth wrapped round a pencil or stick.

The needle in the gas regulator must be long, thin and have a fine point and should come down low enough to protrude through the jet and close it off.

Installation and use of biogas appliances :

The following is a diagram of a rough plan of equipment installation for using biogas.

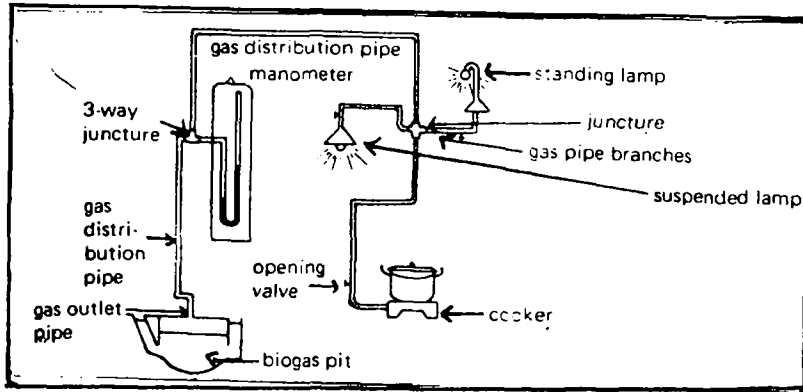

Fig. 58: Plan of Equipment Installation for Biogas Utilization

All hoses and valves should be checked for air-tightness before fitting and a rough plan (see the above figure) should be made of the positions where all valves, lights, stoves, and any Y or X joints should be fixed. Valves should best be fitted on to a wall. The hose should be cut according to requirements and tested. The number of connections and joints should be reduced to a minimum. Connections between valves, hoses, branches, etc. should be airtight.

Running I.C. Engines :

- Diesel engines : Use of biogas in diesel engines is limited to the stationary engine since (gas pressure is slightly above atmospheric pressure and cannot be transported to long distances.

Existing diesel engines can be modified to run on dual fuel while still retaining the ability to use diesel fuel only.

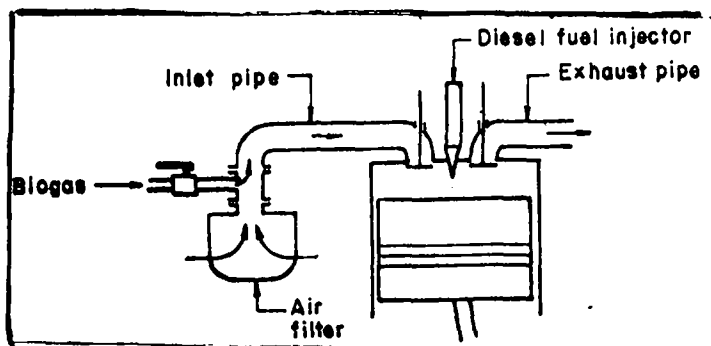

Fig. 59: Diesel Engines Running on Dual Fuel

The following points should be considered while modifying the diesel engine :

- Compression ratio : Original compression ratio should be retained, and advance injection angle should not be changed to ensure normal running of the engine on dual fuel and diesel and also facilitate maintenance and repair.
- Modification of the intake : To provide biogas after the air filters into the inlet pipe, the intake should be modified. Some of the designs suggested for the introduction of biogas into the intake are shown below.

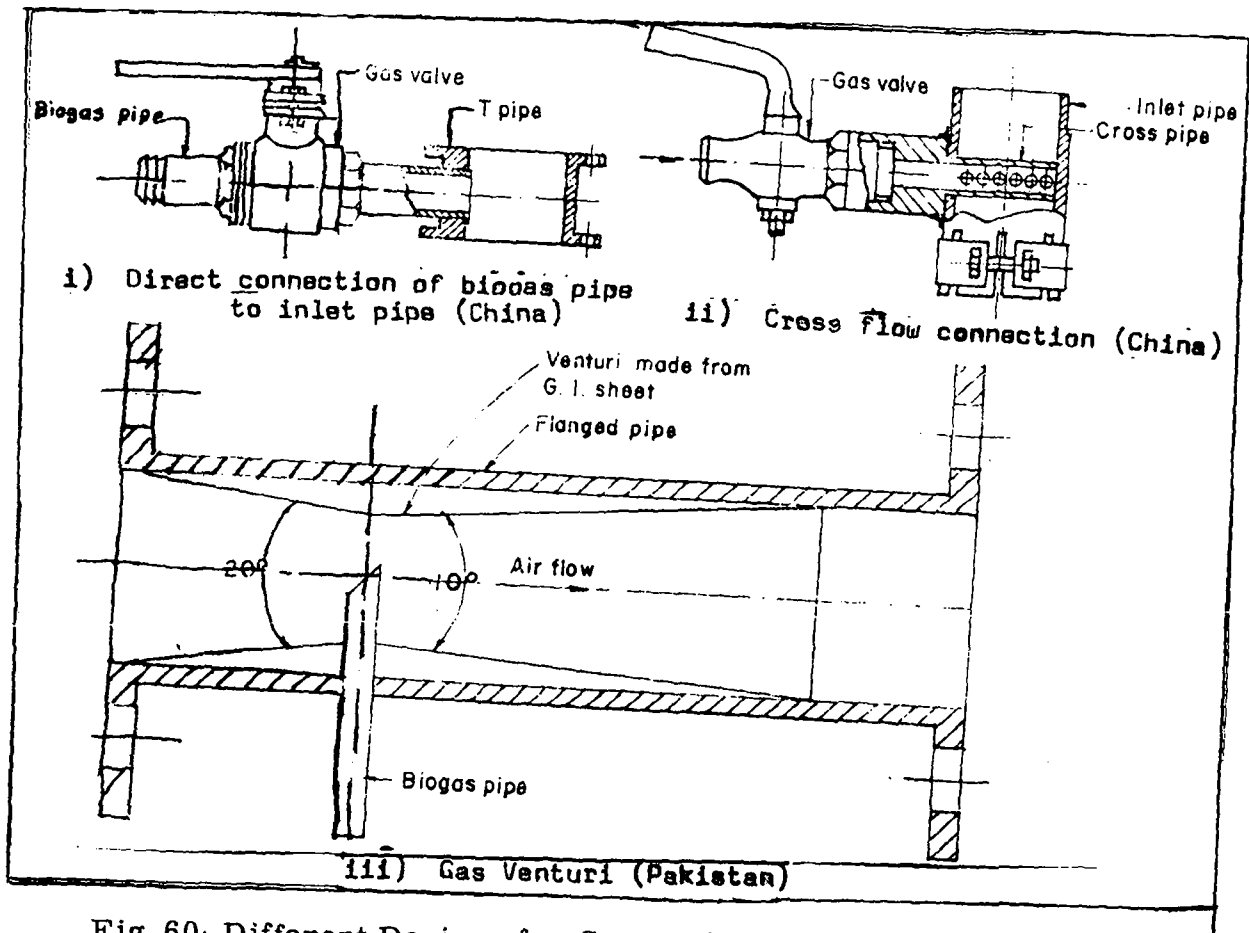

Fig. 60. Different Devices for Connecting Biogas Pipe to the Intake

In order to give the proper biogas/air mixture gas inlet devices are designed to suit different engine designs and inlet pipes.

- Starting : Diesel fuel is only used for starting.

- Operation : The biogas valve is opened slowly after the **engine** has been running with diesel fuel for a while. Due to the action of the speed governor, the diesel fuel supply will be reduced. In order to ensure smooth running and better fuel consumption, while the engine is operating, the biogas valve should be opened or closed in response to the change in engine speed or load. The engine should be operated on as steady a speed as possible while running on biogas.

In order to stop the engine the biogas valve should be closed first, followed by the throttle valve.

- Maintenance : There is no significant difference in maintenance when the engine is run on biogas.
- Petrol engines : These engines can run on 100% biogas.
- Air intake : This is the same as that used for diesel engines. An alternate design is given below.

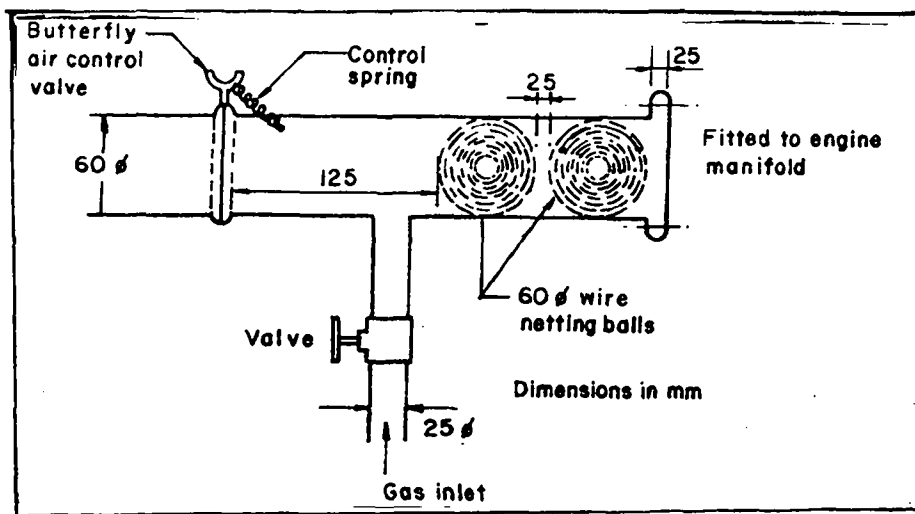

Fig. 61: Carburettor for 10 bhp Petrol Engine Running on Biogas

A plastic bag provided near the gas inlet so that the engine can suck in gas more easily is found to be advantageous for engine less than 10 hp.

Table 9 : Biogas Consumption Rate per Hour in Cubic Meters and
Operation of Different Types of Engines

Sl. No.	Make of Engine	Fuel system	Cylinder and cycle details of engine	Brake horse-power	Horizontal or vertical	Speed i. e. R. P. M.	Dia-meter of the gas supply line	Gas pressure water column inch required
1	2	3	4	5	6	7	8	9
1.	Stuart Engine coupled with 250 Watts 110 Volts, D.C. Generator (Made in England)	Petrol Engine	Single cylinder four cycle	1 B.H.P.	Vertical	High speed 1800	0.4 cm	5 cm-10 cm
2.	Open Engine coupled with 1 K.V.A. 110 Volts A.C. Generator (Made in U.S.A.)	Do	Do	3 B.H.	Vertical	High speed 1500	0.4 cm	5 cm-10 cm
3.	Kubota Engine (Made in Japan)	Powerine	Single cylinder two stroke	5 B.H.P.	Horizontal	Low 900	0.4 cm	2.5 cm-7.5 cm
4.	Kubota Engine (Made in Japan)	Kerosene engine	Single cylinder four cycle	10 B.H.P.	Horizontal	Low 600-800	0.4 cm	2.5 cm-7.5 cm

Contd.

Table 9 (Contd.)

Sl. No.	System of cooling	Gas consumption (cu. m.) per hour		Air in Cu. m. required for		Working efficiency of the engine	
		Normal load	Full load	Normal load	Full load	Liquid fuel	Biogas
10	11	12	13	14	15	16	17
	Air-cooled	0.462	0.518	2.66	3.024	250 Watts	225 Watts
	Do.	1.344	1.624	7.392	8.904	1000 Watts	850 Watts
	Water-cooled	2.3	2.66			5 H. P.	4.03 H. P.
	Do.	4.34	4.9			10 H. P.	8.2 H. P.

Pumping, Cottage and Agro-Industries :

Biogas can be used for pumping water for irrigation and water supply, and as power for agro-industries.

At the Gobar Gas Research, Ajitmal Station of the Planning Action Research Institute, a 10 h. p. engine has been operated by biogas to cut chaff, grind flour and pump water, for generating electricity for lighting and running of fans and for operating a plastic moulding machine.

The gas consumption of the machine for different operations is given below :

Table 10 : Biogas consumption per hour for hand-operated plastic moulding machine

Commercial appliance	Size	Output/ hour	Gas consumption
1. Plastic moulding machine-button-making	1/4 oz.	120 shots	0.134 cu. m./hr-500 watts/hr.
2. "	1/2 oz.	100 shots	0.14 cu. m./hr-600 watts/hr.
3. Plastic machine: Toy-making	1 oz.	85 shots	0.154 cu. m./hr-650 watts/hr.
4. "	1/2 oz.	75 shots	0.238 cu. m./hr-1,000 watts/hr.

References :

1. Buren, Ariane van, Ed. Chinese biogas manual. London, Intermediate Technology Publications, 1979, p.99-109.
2. Jain, M. K. "Low cost burners for biogas." Presented at : National Symposium on biogas technology and usage held in New Delhi, November 29-30, 1977, p.33-35.

3. Sathianathan, M.A. Biogas - Achievements and challenges. New Delhi, AVARD, 1975, p.61-80.
4. United Nations, Economic and Social Commission for Asia and the Pacific. Guidebook on biogas development. New York, United Nations, 1980. p. 56-62, 93-86.

DIGESTED SLUDGE AND ITS USES

Most solids not converted into methane settle out in the digester as a liquid sludge. Depending on the raw materials used and the conditions of digestion, this sludge contains many elements essential to plant life - nitrogen, phosphorous, potassium plus small amounts of salts (trace elements), indispensable for plant growth such as boron, calcium, copper, iron, magnesium, sulphur zinc, etc.

As fertilizer :

The properties which make digested sludge suitable as fertiliser are :

- Digested sludge contains nitrogen (considered particularly important because of its vital role in plant nutrition and growth) mainly in the form of ammonium (NH₄) whereas nitrogen in aerobic organic wastes (activated sludge, compost) is mostly in oxidized form (nitrates, nitrites). Increasing evidence suggests that for many land and water plants ammonium may be more valuable as a nitrogen source than oxidized nitrogen in the soil as it is much less apt to leach away and more apt to become fixed to exchange particles (clay and humus).

Tests done on nitrogen effectiveness of cattle-dung following different practices give the following results.

Table 11: Amount of nitrogen in cow dung

Field practice	Nitrogen effectiveness Index (percent)
Dung spread and ploughed immediately	100
Dung piled for 2 days before spreading and ploughing	80
Dung piled for 14 days before spreading and ploughing	55
Dung piled for 30 days before spreading and ploughing	50
Effluent from gas plant introduced immediately into irrigation water	100
Dried biogas plant effluent spread and ploughed	85

- The volume of the manure after processing is greater than if the same dung had been put in a farmyard manure pit.
- The phosphorous and potash put into a gas plant come out with very little reduction.
- The sludge, like all compost materials, adds humus and supports microbiological activity in the ground, increasing porosity of the soil and water-holding properties, all of which add up to increased crops. Unlike chemical fertilizers which are effective for a period of one year only, it is effective for a period of 3 years.

The sludge may be used as fertilizer in -

- Liquid form : In this form the slurry can be taken in buckets and put on vegetable gardens and around fruit trees.
- Diluted form : The slurry is carried by irrigation water to fields and it is important to spread it all over the fields and not allow it to accumulate at one spot.

However, certain points should be noted while using the sludge as fertiliser.

- Fresh digested sludge, especially from manures, has high ammonia content, and in this state may act like a chemical fertilizer by forcing a large dose of nitrogen on the plant and thus increasing the accumulation of toxic nitrogen compounds. Thus it is best to let the sludge "age" for a couple of weeks either in the open or in a closed container for a few months before using it on crops. The fresher it is the more it should be diluted with water before application.
- The continued use of digested sludge in any one area tends to make soils acidic. To prevent this a little dolomite or limestone should be added at regular intervals to the sludge plots, allowing at least 2 weeks' interval between applications to avoid excess nitrogen loss. As limestone tends to evaporate ammonia, a temporary nitrogen loss may be experienced when it is applied on the sludge plots.
- Unlike digested municipal sludge, sludge from farm wastes does not contain large amounts of heavy metals or salts. So there is not much danger in applying it heavily over a period of time.

However, attention should be paid to the structure of the soil. If it contains a lot of clay, the sludge will tend to accumulate and possibly present problems in the root area of plants. Thus sludge plots need to be watched closely until the plants' response to the use of sludge in the particular soil is known.

Most vegetable crops such as potatoes, tomatoes, radishes, carrots, cauliflowers, onions, garlic, etc., fruit trees such as orange, grape, apple, guava, mango, etc., and crops including sugar-cane, rice, jute are found to respond well to the use of digested sludge as fertilizer. Crops like jowar, bajra, wheat, oilseed crops, cotton, etc., are found to be less responsive.

Use of this digested sludge directly from the digester offers problems.

- Problem of conveying this sludge to the field is seen as the foremost problem. In some digesters, there is a built-in arrangement whereby the digested slurry is pumped into tankers and carried to the spot where the manure is required or where it can be composted. A small cart tanker could be designed which would involve additional cost.
- Manures are applied at specific times and so it is necessary to be able to store them for use when required.

Slurry utilisation :

- The simplest method is to lead the effluent slurry to 'Kutchas' pits dug in the open, and allowing the slurry to dry there. Three similar pits may be dug and filled in turn. The size of the pits may be such that by the time the third pit is filled, the sludge in the first pit is dry enough for carting. However, in using this method some manurial value may be lost, and in the rainy season protective roofing may have to be provided over a large area. Further, there may not be sufficient space adjacent to the digester.
- Slurry filter-bed : An effective filter-bed 3 m long, 1.2 m broad and 0.6 m deep with an opening at the opposite end of the sloping bottom has been designed by Indian Agricultural Research Institute. The spent slurry from the fermentation well is led by a channel to flow and cover a six-inch compact

layer of green or dry leaves filled in the bed. Water from the slurry filters down and flows out of the opening into a pit. This water can be reused for preparing fresh dung slurry for feeding the gas plant. The semi-solid residue left on top of the bed has the consistency of dung and can be transported and stored in a pit for use when required.

- Use as compost : The slurry, being full of bacteria which break down vegetable matter very well, is an excellent composting material.

Two or three pits of 80 cm depth are dug. This allows the slurry to dry a bit and is not hazardous to animals which might walk into it. The slurry is poured on top of the layer of straw, animal bedding, leaves or other vegetable matter. Alternative layers of vegetable matter and slurry are added until the pit is full. The pits must be large enough to hold all the compost until it can be put on the fields.

This compost is put on the fields in the normal manner and should be ploughed in quickly.

Slurry from the fixed dome digester is used directly in the field. The sludge obtained twice a year when the digester is emptied is composted in the manner described above.

In places with a high water-table it is occasionally necessary to lift the compost out of the pits and put it on the ground to dry sufficiently for transporting to the fields.

In another method, the slurry is run into shallow pits and allowed to dry partially or fully in the sun. It is then dug out and stored in piles until it is time to spread it on the fields.

- Dehydration of slurry : The spent slurry as it comes out of the gas plant contains about 90% moisture and takes a long time to dry in the sun. Experiments conducted on this aspect have shown that the slurry could be absorbed in materials like dry broken leaves, sawdust, charcoal dust, etc., and then spread out to dry. The operation of soaking and drying can be repeated to yield twice the quantity of manure obtainable by drying the slurry alone. The nitrogen contents of the manures will depend on the original composition of the materials used but this can always be corrected to make the manures fit for use by enrichment as described below :

- Enriched organic manure : The dried spent slurry by itself or by the above process may be enriched with fertilizer nitrogen and, in addition, with phosphorous if required, to obtain concentrated organo-mineral manures which could be applied in comparatively small quantities to act as a good plant growth stimulant. The enrichment can be carried out by taking 11 kg. of urea and 31 kg. of superphosphate and dissolving these in about 15 litres of water. This solution is then absorbed in 48 kg. of dry low-grade manure, mixed thoroughly and spread out in the sun to dry. The enriched manure would then contain at least 5% nitrogen and 5% phosphoric acid in addition to its original quantities of these plant nutrients.

Integrated systems :

In this system, the slurry is used to feed algae ponds, fish-ponds and to fertilize fields. The food thus produced is used to feed humans and animals and their waste is used to produce more gas, and the cycle continues.

- Animal-feed :

The dry sludge from the biogas plants looks and handles like humus and does not have the offensive smell of manure, neither does it attract flies. The biogas process, moreover, retains the nutrients and enriches the sludge with B complex vitamins, particularly vitamin B12, which are synthesized during the biogas digestion.

Solids are recovered from the sludge by allowing them to settle out in settling tanks by draining the liquid and then dried, preferably under the sun or by artificial means in the absence of sun. However, solids should not be subjected to very high temperatures which can destroy the vitamin content. The dried lumpy solids are then ground and detoxified before mixing with the other feed materials. In small operations where wet feeding is practised, the settled sludge may be fed with the slope without drying.

- Algae production :

After the solids are recovered from the sludge, the remaining liquid, which contains nutrients and trace minerals, is considered to be a good promoter of algae.

Chlorella, a single-celled high protein (36-40% protein content) can be harvested with the liquid portion of the sludge in a shallow pond lined with concrete, metal or plastic material to avoid contamination and to make harvesting easier. Chlorella can be used in amounts up to 10% of animal feeds to replace soyabean soil meal for protein supplementation.

- Fishponds :

The liquid portion of slurry can be used in fishponds. The amount added to fishponds has to be controlled to avoid excessive growth of algae.

There are several ways to integrate pond cultures with digesters.

- Sludge hydroponics : Hydroponics is the process of growing plants directly in nutrient solution rather than soil. The nutrient may consist of soluble salts (i. e. chemical fertilizers) liquid organic wastes like digested sludge and effluent. Plants grown hydroponically in sludge-enriched solutions can serve a variety of purposes for organic digester operations :

- They can eliminate the cost and energy of transporting liquid fertilizer to crop lands since they can be grown conveniently near digesters.
- They tend to be more productive than conventional soil crops, and this can serve as a high-yield source of fodder, compost, milch or silage.
- They can serve as convenient high-yield sources of raw materials for the digester itself.

Usually the water plants are grown in shallow ponds filled with a diluted sludge solution. The process consists of slowly adding sludge under a gravel bed lining the pond and covered with a layer of fine sand. Over the sand, plants are sprouted in containers floating on the effluent that percolates up through the gravel and sand layers. After sprouting, the grasses then root and anchor in the sand and gravel.

- Sludge-algae-fish culture; The essence of such a system consists of placing sludge into ponds and stimulating the growth of algae. The algae is then used as feed for small invertebrates or fish growing in the ponds.

- Sludge-algae-methane system : In this system green algae is grown in diluted sludge, then harvested, dried and digested to produce methane for power and sludge for recycling. It provides protein rich food supplements both for human and animal diets, helping to overcome food shortage and protein deficiency. Gas production is increased through recycling part of the algae through the digester and better and more manure is produced. Further, land that is unsuitable for agriculture can be used for producing food.

Health Hazards

The presence of heavy metal content especially if industrial waste is used and disease-carrying organisms in the slurry and sludge is of concern.

This depends on several factors such as input material, type and amount of disease-carrying organisms in the waste used; temperature-high temperature gives a greater kill-rate; residency time - a longer time gives a greater kill-rate.

However this material is much freer from disease-carrying organisms than the input material. Further improvements take place if the effluent is subsequently composted.

References :

1. Maramba, Sr. Felix D. Biogas and waste recycling: The Philippine experience. Metro Manila, Liberty Flour Mills, Maya Farms Division, 1978, p.153-164.
2. Sathianathan, M.A. Biogas: Achievements and challenges. New Delhi, AVARD, 1975, p.81-89.
3. United Nations, Economic & Social Commission for Asia and the Pacific. Guide book on biogas development. New York, 1978, p.87-89.

TACKLING TECHNICAL PROBLEMS

The following are the problems faced in the construction, operation, maintenance, storage and utilisation of the biogas plant :

- Gas plant

- Digester

1. Problem : Cracking of the digester wall due to hydraulic pressure from inside or from outside in horizontal gas plants.

Cause : Lack of consolidation of soil on the outside of the digester wall, resulting in cavities in soil surrounding the masonry wall, and leading to the development of cracks in the digester wall.

Solution : Outlet part of the plant should be packed in layers of soil of 30 cm thickness each, with sufficient water, after the construction of the digester is completed. This would increase the life of the structure and also reduce seepage loss to some extent.

2. Problem : Rising of the digester floor with the rise of ground water-table.

Cause : a) Faulty compaction of the bottom.
b) Hydraulic pressure of ground water.

Solution : Pressure is neutralised when the plant is full. So where the water-table is high the plant should always remain full.

3. Problem : Bursting of the digester with excessive gas pressure.

Cause : a) Gas holder at the top becomes jammed in the digester due to drying of the scum in between the gas holder and digester and restricting movement of the holder.

b) Guide frame gets loosened from its support and the holder cannot move freely.

Solution : a) Scum should not be allowed to dry and should be forced down with a rod twice or thrice a week.

b) Guide pipe should be rewelded and rivetted and guideframe, etc., should be checked before installing it in the digester.

- Gas Holder

1. Problem : Corrosion of the gas holder (reported to be more in the coastal region).

Cause : Gas holders, commonly made of mild steel, remain in contact with digester slurry and with the gas containing methane and other gases, including H₂S which is highly corrosive.

Solution : Painting of the gas holder with black paint or even coal tar each year. Alternate materials like PVC, ferrocement, galvanized iron, fibreglass, etc. may be used to manufacture the holder.

- Inlet and outlet and centralguide pipes

1. Problem : Clogging of the inlet/outlet pipes.

Cause : Accumulation of feed or scum.

Solution : Should be washed or flushed regularly with clean water or should be cleaned with a pole moving up and down.

2. Problem : Breakdown of central guide-pipe.

Cause : Rusting.

Solution : Replacement (as it is mostly beyond repair).

- Gas pipe carrying gas to the kitchen :

1. Problem : Collection of condensate.

Cause : Presence of water vapours in the gas.

Solution : Condensate should be blown out periodically - twice or thrice a week. The pipe may be kept at a slope to ease blowing off.

- Gas removing systems

1. Problem : Rubber hose pipe deteriorates.

Cause : Lack of availability of good quality rubber hose pipe.

Solution : Gas removing system through a centre-guide allows the gas holder to rotate freely and by covering the centre support, the rust problem in this location may be solved.

2. Problem : Leaks at either end of flexible pipes.

3. Problem : Pipe gets twisted up and flattens in places (especially if plastic pipes are used).
4. Problem : Soft pipes sag and condensates collect in the power points necessitating daily removal.
5. Problem : Central support pipe rusts and breaks at times.
6. Problem : If the pipe is hooked underside it prevents gas holder being rotated.
7. Problem : Slurry enters the pipe and blocks it if the pipe is not long enough.
8. Problem : Pipe may be too low in the ground for condensate removal.

- Production :

- Seasonality of gas production :

1. Problem : Reduction in production of gas in winter (Reduction in production by 50% in summer).

Cause : Methanogenic bacteria are mesophilic and reduction in temperature adversely affects gas production. The fall in gas production starts when temperature falls below 20°C.

Solution : a) Insulation : The whole plant including the gas holder may be insulated with material such as straw.

b) Glass house effect : A plastic airtight tent may be built over the gas plant. Care must be taken to avoid an explosion in case any gas gets collected in the tent.

c) Solar heating : This could be done by introducing tubes carrying solar heated water into the fermentation tank. But this will involve utilisation of an auxiliary water pump as the conventional thermal convection of solar water heaters will not work, the fermenter being at a lower level than the solar collector. This method is neither economical nor practical. By using separated digester design, the roof can be made to serve as a solar energy absorber. This will have no control on the temperature of the fermentation, and there will be diurnal as well as seasonal variations in the yield.

If the specific gravity of the slurry is increased by 10%, a smaller digester may be used. This would compensate for the cost of the solar heater.

- d) Heating with biogas : With a 1 cu. m. digester for a 2.8 cu. m. gas/day plant, 0.28 cu. m. of gas per day may be used to keep the temperature at 27°C, when the ambient temperature is 15°C.
- e) Thatched roof of gas holder : This would prevent loss of heat through the gas holder.
- f) Reflecting surfaces : A curved wall located and painted to reflect the sun onto the still digester may be used.
- g) Composting around the digester wall : Compost pits built around the digester and emptied and refilled regularly in rotation would give continuous heat to the gas plant.
- h) Heating water : The water used for preparing the slurry may be preheated by exposing to the sun.
- i) Addition of urine, urea : Addition of about 1 litre cattle urine per 1-4 cu. m. digester volume daily increased gas yield. Arrangements can be made for collecting the urine fraction in cattle sheds as such or by absorbents which can then be immersed in water and the extract incorporated in the well. One level teaspoon of urea added per day per 3 cu. m. digester volume also enhances gas production.
- j) Addition of other materials : About 70 g of powdered leaves or wheat straw added per cubic metre of digester volume will increase yield of gas.

Enzymes, too, have been found to increase gas production but the method is extremely expensive.

Water hyacinth added to cattle dung enhances gas production. Water containing algae when added gives a significant increase in gas production, especially in plants using pig manure.

Formation of scum

- 1. Cause : a) Presence of undigested vegetable matter (e.g. straw, water hyacinth or coarse dung such as elephant dung), animal bedding (e.g. straw, sawdust), animal clothing (e.g. pig hair, chicken feathers) and not properly broken dung.
- b) Slurry not properly mixed.

Solution : a) Mixing the slurry to disperse the floating material.

b) Agitation or semi-circular rotation of the drum may help mix the slurry. It may also be necessary to introduce special stirrers or mixing devices for this purpose.

- Problems with pH

1. Problem : pH too acidic (6 or less)

Cause : a) Adding raw material too fast.
b) Wide temperature fluctuation.
c) Presence of toxic substances.
d) Build-up of scum.

Solution : a) Reduce feeding rate.
b) Stabilize temperature.
c) Remove scum.

2. Problem : pH too alkaline (more than 7)

Cause : Initial raw material too alkaline

Solution : Have patience. Never put acid into the digester.

- Operation

- Starting Problems

1. Problem : Gas holder (of floating type) does not rise or bag (of flexible bag type) does not inflate or pressure (of fixed dome type) does not rise.

Cause : a) Very few bacteria.
b) Lack of time.
c) Feeding of slurry while waiting for gas holder to fill.
d) No water in water outlet device.
e) Leak in gas holder or gas pipe
f) Gas tap or cock or condensate tap open.

Solution : a) Seed with slurry from a working plant before adding the new slurry to the digester; rotate the gas holder daily.

b) In cold weather it takes about 3 weeks to fill the gas holder for the first time.

c) No slurry should be fed in until the third gas holder of burnable gas has been produced.

d) About 0.25 litre of water should be poured into the dipper pipe and the excess removed.

e) Should be located and repaired.

f) All open taps should be closed.

2. Problem : Gas holder or bag (or pressure in fixed dome type plant) goes down very quickly once main gas valve is opened.

Cause : Condensate or water outlet tap open (if fitted) or gas tap for burner open or gas cock for lamp open.

- b) No water in water outlet device or syphon.
- c) Major leak in pipe-work.

Solution : a) Close the taps.

- b) Pour water into water outlet device to remove excess water.
- c) Leaks should be located and repaired.

3. Problem : Gas holder or bag or pressure (in fixed dome plant) rises very slowly.

Cause : a) Temperature too low.

- b) Thick scum on top of slurry.
- c) Too much slurry put in daily.
- d) Slurry mixture suddenly changed a lot.
- e) Chemicals, oil, soap or detergent put into slurry.
- f) Gas leak.
- g) Slurry mixture too thick or too thin.
- h) Washing out mixing tank with extra water and allowing it to go **into** the digester.

Solution : a) Temperature may be raised by the methods

- b) Remove the scum layer by agitating the drum daily and seeing to it that no straw or grass, etc. get into the plant.
- c) Correct amount of slurry should be added daily.
- d) Slurry mixture should not be altered too much at a time.
- e) Daily feed with dung and water only, to be continued.
- f) Leak should be located and repaired.
- g) Slurry to be made of the right consistency.
- h) No extra water should get **into** the digester.

4. Problem : Too little gas although pressure is correct.

Cause : Gas jet is blocked.

Solution : Gas jet to be cleaned with split bamboo or needle.

5. Problem : No gas at burner.

- Cause :
- a) Main valve is closed.
 - b) Gas tap is blocked.
 - c) Burner or pipe is completely blocked by condensate.
 - d) Leakages in the main/feeding pipes.

- Solution :
- a) Open the valve.
 - b) Clean the tap.
 - c) Remove the condensate.

6. Problem : First gas produced will not burn.

- Cause :
- a) Wrong kind of gas.
 - b) Air in the gas pipe.

- Solution :
- a) First gas should not be burned as air may be mixed with it and could explode. Also, frequently the first gas produced in winter has a high percentage of CO₂.
 - b) Air should be allowed to escape until there is a definite smell of gas.

7. Problem : Slow rate of gas production or no gas production.

- Cause :
- a) Increase in toxicity with retention time.
 - b) Increase in solid content.
 - c) pH too acidic or too alkaline.
 - d) Low temperature.
 - e) Addition of significant quantity of different types of feed material to a working digester, for example, addition of an equal mass of vegetable matter to the digester utilizing pig waste.
 - f) Digester filled with exhausted dung heaps.
 - g) Digester filled up with raw dung followed by water to make the slurry.

- Solution :
- a) Dilution or low loading makes ammonia toxicity less critical.
 - b) Stirring, dilution or low loading reduces viscosity.
 - c) As discussed earlier on p.121
 - d) As discussed earlier on p. 119
 - e) Do not change the slurry mixture of a working digester.
 - f) Do not use exhausted dung heaps.
 - g) Make the slurry as recommended.

Storage !

1. Problem : Biogas cannot be bottled like LPG.

Cause : Biogas with 50-80% methane content cannot be liquefied at ambient temperature.

2. Problem : Special heavy cylinders needing special manufacturing skills are required to store biogas in gaseous form.

Cause : a) Biogas can be stored in the gaseous state only at pressure of the order of 5,000 psi which would necessitate a container of 0.1484 cu. m. volume to store a month's cooking energy for a family of 5.

b) To store or transport energy equivalent of 16 litres of petrol as compressed gas at 2000 psi, requires a cylinder of 1.6 m by 0.27 m weighing 60 kg (presuming removal of oxygen).

Solution : To store the gas under low pressure and to avoid the cost of manufacturing special heavy steel cylinders rubber, neoprene, polythene balloons may be used.

3. Problem : Ordinary available LPG cylinders cannot be used.

Cause : Available LPG cylinders are designed for about 1500 psi which means the biogas supply for a family's cooking will last for only about 10 days.

4. Problem : Other problems include cleaning the gas of CO₂ and H₂S before bottling and utilisation of 20% of energy available in methane to compress the gas.

Remarks : The amount of gas available at one place must be enough to justify installation of the requisite machinery for the bottling of the gas. The cost of cleaning the gas, compressing, purchasing the special high pressure storage bottle, transporting these heavy bottles make the proposition of bottling biogas uneconomical and unpractical.

- Utilisation

- Cooking

1. Problem : Transportation of methane.

Cause : a) Cannot be stored in liquid form.

b) Storage in gaseous form requires cylinders which need special manufacturing skill and are costly.

c) Gas can be transported to a maximum distance of 20 m by a gas pipe from its point of generation to the kitchen.

2. Problem : Need for special design of appliances for cooking.

Cause : a) Low pressure of biogas.
b) Low flame, propagation speed of methane which is further slowed down by the pressure of carbon dioxide.

- Stove

1. Problem : Flames are long and weak or far from the flame ports or do not stay alight.

Cause : a) Incorrect air supply.
b) Incorrect gas pressure.

Solution : a) Air supply to be adjusted.
b) Correct pressure of about 75-85 mm (3-3.5 in) water gauge should be used.

2. Problem : Flame small.

Cause : a) Gas jet in stove partially blocked.
b) Insufficient pressure.
c) Flame ports partially blocked.

Solution : a) Stove should be disconnected and a check should be made to see that the gas is getting that far. Gas jet to be cleaned.

b) Check whether it is due to the gas holder not being turned daily to mix the slurry or if it is due to thick scum which needs to be removed.

c) Flame ports should be cleaned.

3. Problem : Flame pulsates.

Cause : a) Condensate lying in the main gas pipe.
b) Condensate should be removed. If water still remains, the pipe should be relaid or an extra water outlet tap should be fitted if necessary.

c) Stove should be turned upside down and condensate poured out.

4. Problem : No gas at stove.

Cause : a) Main gas valve closed.
b) Condensate completely blocking main gas pipe.
c) Gas jet in stove blocked.

Solution : a) Valve should be opened.
b) Condensate should be removed.
c) Already discussed on pg.125

- Lighting

1. Problem : Light is poor.

Cause : a) Gas regulator and/or air regulator (if fitted) require adjusting. (b) Gas pressure too low. (c) Obstruction in lamp between gas regulator and venturi.

Solution : a) Adjust gas regulator.
b) Correct gas pressure to be used for lamps (75 mm or 3 in) water gauge. Pressure should be increased by adding weights to the gas holder. Scum if any should be removed.
c) Venturi should be removed and cleaned out thoroughly.

2. Problem : Inferior in quality to electric light.

Cause : a) High waste heat of biogas.
b) Poor quality of light.

3. Problem : Mantles break frequently.

Cause : a) Gas pressure too high.
b) Wrong type of mantle.

Solution : Correct gas pressure should be used. Jet nozzle should be set further from the diffuser in case of a Chinese type.

4. Problem : No gas at lamp.

Cause : Gas jet in lamp blocked.

Remedy : Gas regulator should be operated to clean the jet.

5. Problem : Although lighting directly with biogas reduces the cost of electricity generation and distribution, the saving is offset by the need to purchase biogas lamps requiring regular servicing.

Also mantle lighting in general is inefficient. A 40 watt gas lamp which consumes 1260 cu. m. of gas will be required per hour to light six lamps. But with the same gas one kilowatt electricity can be generated which could energize 25 lamps of 40 watts each.

- Running engines

1. Problem : Power obtained with biogas is less than that obtained by liquid fuels.

2. Problem : Engines get hotter running on biogas.

Remedy : The cooling system needs to be in good repair.

3. Problem : Use is limited to stationery engines.

Cause : Gas pressure is slightly above atmospheric pressure and cannot be transported to long distances.

4. Problem : Calorific value of biogas lowered.

Cause : Presence of carbon dioxide.

Solution : Remove carbon dioxide by the following methods :

a) Bubbling biogas through 10% aqueous solution of mono-ethanolamine (MEA).

b) Caustic potash solution is effective in reducing biogas by 0.5-1.0%.

c) Bubbling the gas through lime water.

d) Increased production of CO₂ during the initial stages of the digestion can be reduced by holding freshly prepared slurry under anaerobic conditions for 24 hours before admitting it to the digester.

5. Problem : Corrosion of engine components.

Cause : Presence of hydrogen sulfide (H₂S) which increases especially with addition of biological waste other than cowdung.

Solution : Iron filings may be used to absorb H₂S. About 2.5 kg of it absorbs 1 cu. m. of H₂S. Care should be taken to replace the iron filings every time a sludge forms on its surface.

6. Problem : Conversion of diesel engines to biogas engines warrant major modifications such as governor adjustments in the engine design thereby excluding the presently existing designs from direct use and also necessitate setting up of very large gas plants.

References :

1. Grewal, N.S. and Malvinder Singh. "Maintenance of gobar gas plants." Progressive Farming p.30.
2. Myles, Raymond and J. B. Singh. "Promotion of biogas plants for small and marginal farmers on individual and community basis." Presented at : AFPRO seminar on integrated approach to agricultural development held in Bangalore, October 3-5, 1979.
3. Sathianathan, M.A. Biogas: Achievements and challenges. New Delhi, Association of Voluntary Agencies for Rural Development, 1975.
4. United Nations, Economic and Social Commission for Asia and the Pacific, Guide-book on biogas development. New York, United Nations, 1980, 70-73.

DO'S AND DON'TS

Do's :

- Cover the top of the inlet and outlet opening, especially of the Chinese type plants, firmly to avoid accidental falling of calves, children, etc.
- Mix recommended quantity of dung free from earth and gravel with water in 4:5 proportion and feed the mixture daily into the inlet chamber. Specific gravity of the slurry should be 1.045-1.90.
- Mix dung and water till there are no lumps which may otherwise cause reduced gas production.
- Purge air from all delivery lines by allowing gas to flow for an interval prior to first use.
- Stir the slurry several times a day to enhance gas production.
- Use good-quality and efficient burner and other gas appliances.
- Clean the burner fortnightly.
- Light the match first before opening the gas cork.
- Remove the condensed water from the pipeline periodically.
- Remove floating solid material found if any between the digester wall and the gas holder.
- Install a safety pressure gauge in the kitchen near the window.
- Repair the plant in case of major gas leakages being observed.
- Paint gas holder annually preferably with black enamel paint.
- Use the digested slurry as such for manuring of crops or for hastening the process of composting.
- Keep patience for production of gas during initial filling of the plant with slurry.

Dont's :

- While mixing the slurry do not put :
 - Any earth in the mixing-pit of the go-bar. It will fill up the bottom of the digester pit and cause problems.
 - Any straw or grass, etc., in the mixing pit. If any does get in remove it before letting the slurry into the digester pit.

- Do not let any oil, soap or detergent into the plant as these substances kill the bacteria and stop all gas production.
- Do not put any animal bedding (sawdust used in chicken houses) in the gas plant.
- Never build up gas pressure inside the gas plant for over a long period.
- Never pour acid in the digester as this will increase production of H₂S.
- Never allow any person to enter the gas plant when it is full of dung slurry.
- Never inhale the gobar gas to avoid any health hazard.
- Never use more than 40% urine to avoid increase in ammonia which will give less gas and poorer quality and in course of time may stop gas production.
- No smoking, no candles, no fires, no matches, no lamps or other open flame to be used in case of smell of unburnt gas.

BIOGAS VOCABULARY

This is a vocabulary of some of the important terms commonly used with reference to biogas technology.

- ANAEROBIC DIGESTION : The stabilisation of organic material by bacteria in the absence of oxygen. The process involves two distinct groups of bacteria and can be represented by :

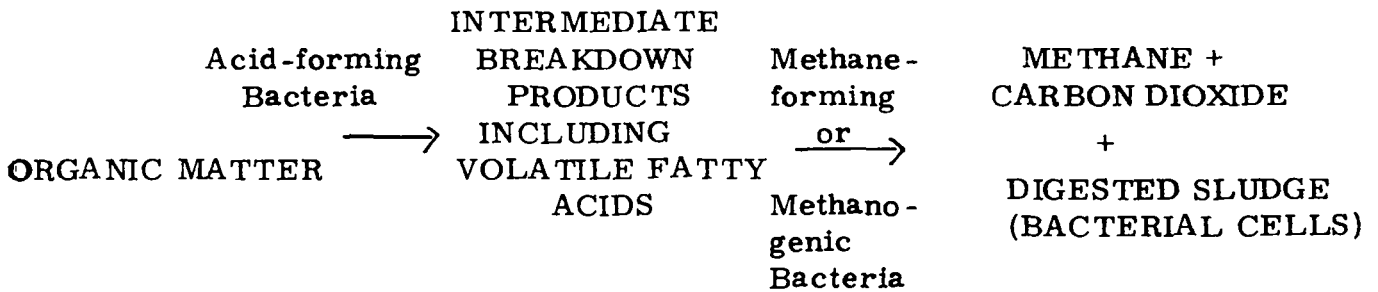

- BATCH PROCESS : In a batch digestion process, material to be digested is loaded (perhaps with a seed) into the digester at the start of the process. The digester is then sealed and the contents left to ferment. At completion digested sludge may be removed and the tank reloaded. Daily gas production varies during the process; it is slow at the start, passes through a maximum and declines towards the end of the digestion cycle.
- BIOGAS : It is the term used for the gaseous mixture produced during anaerobic digestion. The mixture is chiefly composed of methane (CH₄) and carbon dioxide (CO₂), in the range of ratios 1-2:1.
- BIOGAS PLANT : It is the device used to process organic wastes to produce biogas and sludge and/or simply to serve a useful purpose such as control of pollution; it consists mainly of the digester and gas holder.
- CARBON: NITROGEN (C/N RATIO): Is the ratio by weight of carbon to nitrogen in a sample. In general a ratio of around 20-30:1 is considered 'best' for anaerobic digestion.

- CONTINUOUS DIGESTION PROCESS : It involves the continuous feeding of waste material with the removal of the equivalent volume of treated waste (digested sludge). The process is usually started with the addition of a seed; it may take several detention days before the process conditions become steady. For many purposes this is more efficient and convenient than batch digestion. Process involving daily addition and removal are most properly described as semi-continuous.
- DIGESTER : It is the tank in which the anaerobic digestion takes place. This is always sealed but there is a great range of designs and materials.
- DIGESTED SLUDGE : It is residue remaining after digestion, containing some undigested solids, and stabilised organic matter; it is a black tarry-smelling sludge with value to soils, both for its content of nutrients and stabilised organic matter.
- DILUTION RATE : It is the reciprocal of the mean retention-time of the flowing medium in the digester. Thus, $D=1/R.T$.
- EFFLUENT : It is the liquid stream leaving a treatment plan.
- FEED : It is the waste input or influent stream to the digester.
- FEED CONCENTRATION : It is a measure of the content of the feed, expressed as the weight percentage of dry matter or total solids (T.S.) in the feed. It is particularly important to note the method of analysis used.
- FERMENTATION : It is the process of chemical change in organic matter brought about by living organisms.
- FLAME SPEED FACTOR : Measure of the speed at which a flame will travel along a column of the gas.
- GAS HOLDER : The part of the biogas plant where biogas is collected and stored.
- GAS PRODUCTION : It is the quantity of gas (whether total) biogas or methane as indicated, generated per unit of time, and normally expressed as $\text{ft.}^3/\text{day}$ or m^3/d . This should always be quoted under standard conditions of temperature and pressure.
- LOAD(LOADING RATE) : It is usually expressed as the rate of addition of mass of volatile matter to the digester per unit digester capacity (typical units are $\text{mg. Vs}/\text{m}^3 \text{ day}$).
- METHANE : It is a compound of carbon and hydrogen; it is a colourless, odourless, inflammable gas, the main constituent of natural gas and biogas.

- NIGHT SOIL : It is the term used to describe the sanitary wastes, with or without flush water, from households not connected to a main sewerage system.
- NUTRIENTS : They refer (in this context) to those elements and compounds present in digested sludge, or an effluent, which are necessary for plant (including algal) growth.
- pH : This is the term which denotes the acidity and alkalinity of a substrate.
- RETENTION TIME : Number of days organic waste slurry is supposed to remain inside the digester, that is from the day the slurry is charged till it comes out of the digester.
- SCUM : It is the waste material formed on top of the liquid slurry, and can be a severe problem in digesters receiving much fatty or floatable material. Methane formation can be inhibited if the scum is allowed to accumulate and to set hard.
- SLURRY : Liquid mixture fed into the biogas plant. Digester slurry is the liquid manure coming out of the gas plant.

REFERENCES :

1. Maramba, Sr. Felix O. Biogas and waste recycling: The Philippine experience. Metro Manila, Liberty Flour Mills, Maya Farms Division, 1978. p.218-222.

/RHM
