



## **ecosan – closing the loop in wastewater management and sanitation**

Proceedings of the International Symposium, 30–31 October 2000, Bonn, Germany



Deutsche Gesellschaft für  
Technische Zusammenarbeit (GTZ) GmbH

**Division 44**

Environmental Management, Water, Energy, Transport

Sector project

ecosan – ecologically and economically sustainable  
wastewater management and sanitation systems

**ecosan –  
closing the loop in wastewater  
management and sanitation**

**Proceedings of the International Symposium,  
30–31 October 2000, Bonn, Germany**

Eschborn 2001

**Published by:**

Deutsche Gesellschaft für  
Technische Zusammenarbeit (GTZ) GmbH  
Postfach 5180, 65726 Eschborn, Germany  
Internet: <http://www.gtz.de>

Section 44 – Environmental Management, Water, Energy, Transport  
Sector Project ecosan

**Responsible:**

Christine Werner  
e-mail: [christine.werner@gtz.de](mailto:christine.werner@gtz.de)  
Internet: <http://www.gtz.de/ecosan>

**Edited by:**

Christine Werner, Jana Schlick, Gernot Witte, Anke Hildebrandt

**Printed by:**

Universum Verlagsanstalt, 65175 Wiesbaden, Germany

## Foreword

Conventional forms of centralized and individual sanitation do not offer sustainable solutions to the massive worldwide sanitation problems. Despite the intensive efforts of many institutions at national and international level, many developing countries cannot afford to provide adequate water supply and sanitation services to their populations, as the initial cost and operation of conventional systems are often much too expensive. Consequently, about 2.2 million people in developing countries, most of them children, die every year from diseases associated with lack of safe drinking water, inadequate sanitation and poor hygiene. Conventional “flush and discharge” and “drop and store” disposal systems cause worsening pollution, mainly of ground- and surface water by organics, nutrients, pathogens, hazardous material and such other polluting substances as pharmaceutical residues, hormones etc. Moreover, conventional waterborne sewage systems add to the waste of precious drinking water by misusing it as a transport medium for faeces, urine and waste. But the main reason why conventional sanitation systems are coming under increasing criticism is that they deprive in general agriculture and, hence, food production of the valuable nutrients contained in human excrements, especially in urine, thus representing a typical, linear end-of-the-pipe-technology that contributes to the degradation of soils and to the loss of natural productive capacity due to a lack of nutrients.

A possible solution to such problems is an alternative sanitation concept called “ecological sanitation”, or “ecosan” for short, which represents a more holistic approach towards ecologically and economically sound sanitation. The key objective of this approach is not to promote any particular technology, but to bring forward a new philosophy of dealing with what in the past has been regarded as waste and wastewater. The systems representing this approach are based on the systematic implementation of a material-flow-oriented recycling process of nutrients and water as a hygienically safe, circular and holistic alternative to conventional solutions. Ideally, ecological sanitation systems enable the complete recovery of all nutrients from human faeces, urine and greywater to the benefit of agriculture, thus helping to restore soil fertility, to assure food security for future generations, and to minimize water pollution while ensuring that water is used economically and, to the greatest possible extent, reused - if necessary after adequate treatment - for such purposes as irrigation, groundwater recharge or even direct reuse, if needed.

With a view to advancing the further research and development, testing and dissemination of these closed-loop-approaches, the Deutsche Gesellschaft für Technische Zusammenarbeit GmbH (GTZ), acting on behalf of the German Federal Ministry for Economic Cooperation and Development (BMZ), has embarked on a supra-regional sector project entitled “ecosan – ecologically and economically sustainable wastewater management and sanitation systems”.

In preparation for the project, the International Symposium “ecosan – closing the loop in wastewater management and sanitation” was held in late October 2000 in Bonn, Germany, in order to sound out the present state of affairs and the areas calling for pertinent activities. It was intended to initiate and intensify interdisciplinary and international communication and cooperation and to help investigate and accommodate external expectations regarding the possible role of the GTZ-sector-project within that international context. The event was attended by nearly 200 participants from all over the world representing a wide variety of political, private-sector and scientific institutions, external support agencies, various NGO's and GO's, and a broad array of specialty fields - sanitation, hygiene, agronomy, social science and urban planning are examples. Well-known experts who already have been dealing with ecosan

strategies for several years, alongside of interested parties and institutions new to the subject, took part and exchanged openly and very productively their experiences, visions and open questions.

With the proceedings of this symposium, we are pleased to present you an enlightening overview of current activities, ideas and debates that were pursued in the course of the event as part of an emerging global network and joint action targeting a successful, worldwide re-orientation towards ecological sanitation in North and South alike. In accordance with the spirit of this symposium, the GTZ sector project will continue to support and strengthen this network through cooperative development and implementation of - especially urban - pilot projects, together with international and local partners, and through the active dissemination and exchange of theoretical and practical know-how and information about existing and new ecosan-related developments. We cordially invite any party interested in productive cooperation to contact us and take part!

But before that, we wish you an interesting and inspiring set of lectures and reports!

Your GTZ ecosan-team

In April 2001

## Table of Contents

	page
<b>Programme of the International Symposium on Ecological Sanitation „ecosan – closing the loop in waste water management and sanitation”</b>	1
<b>1 Keynote addresses: Sustainable water management – a global challenge for the 21st century</b>	
Statements	
<i>Dr. Uschi Eid</i> (Parliamentary State Secretary, BMZ, Germany)	9
<i>Anil Agarwal</i> (Director CSE, India)	13
<i>Wolfgang Kroh</i> (Senior Vice President KfW, Germany)	19
<i>Dr. Christoph Beier</i> (Director Planning and Development Department GTZ, Germany)	22
Minutes of the plenary discussion	25
<b>2 Plenary Session – What are the existing approaches and visions?</b>	
Lectures	
ecosan – a holistic approach to material–flow–management in sanitation <i>Christine Werner</i> (GTZ, Germany)	29
Towards a recycling society Ecological sanitation – closing the loop to food security <i>Dr. Steven Esrey</i> (Unicef, USA)	34
Slum networking – using slums to save cities <i>Himanshu Parikh</i> (Consultant, India)	45
Sanitation and sustainable water management in Germany <i>Dr. Robert Holländer</i> (BMU, Germany)	47
The bellagio principles and a household centered approach in environmental sanitation <i>Roland Schertenleib</i> (EAWAG, Switzerland)	52
Development of ecosan-systems <i>Uno Winblad</i> (Consultant, Sweden)	58
Planned funding activities on concepts and technologies of alternative, decentralized water supply and sanitation <i>Dr. Andrea Detmer</i> (BMBF, Germany)	63
New developments of ecosan in Germany and Europe <i>Prof. Dr. Ralf Otterpohl</i> (TUHH, Germany)	68
Hygienic safety and water-reuse-potential increased by means of bio- membrane-technology <i>Prof. Dr. Wolfgang Dorau</i> (UBA, Germany)	80

AKWA 2100, scenarios for alternative urban water infrastructure systems <i>Dr. Harald Hiessl</i> (Fraunhofer Institut, Germany)	89
Minutes of the plenary discussion	95

### 3 Parallel Sessions

---

#### Parallel Session 1: Options and limitations for the application of recyclables; agricultural needs, hygienic and economic aspects

---

Lectures	
Production of fertilizer water from wastewater <i>Prof. Dr. Peter Kunz</i> (University of applied Sciences of Mannheim, Germany)	103
Participatory hygiene and sanitation promotion in ecological sanitation in Zimbabwe <i>Cleophas Musara</i> (Mvuramanzi Trust, Zimbabwe)	106
Urban farming and ecosanitation: Nigerian Experience <i>Prof. M.K.C. Sridhar</i> (University of Ibadan, Nigeria)	109
Possibilities and limits of wastewater-fed aquacultures <i>Dr. Ranka Junge Berberovic</i> (University of Wädenswil, Switzerland)	113
Results of Parallel Session 1 presented at the plenary	123
Minutes of Parallel Session 1	125
List of participants	127

#### Parallel Session 2: Rethinking Sanitation - Bellagio-Principles and Household centered environmental sanitation approach (HCES)

---

Lectures	
Appropriate sanitation technologies for Botswana <i>Tony Richards</i> (GTZ, Botswana)	131
The practise and potential of ecological sanitation in India and the sub-continent based on current research and demonstration of compost toilets in India <i>Paul Calvert</i> (Consultant, India)	139
Implementing the bellagio principles and the HCES approach: a framework for action <i>John Kalbermatten</i> (Consultant, USA)	146
Results of Parallel Session 2 presented at the plenary	155
Minutes of Parallel Session 2	157
List of participants	161

---

**Parallel Session 3:  
Implementation of holistic sanitation strategies within socio-cultural,  
political and urban planning frameworks**

---

Lectures	
Ecological sanitation - case study Adulala-Oromiya/Ethiopia <i>Prof. Dr. Gerd Förch</i> (GTZ / Rodeco, Ethiopia)	165
Public awareness and mobilisation for ecosanitation <i>Madeleen Wegelin-Schuringa</i> (IRC, Netherlands)	168
Potentials of alternative water systems from the economical point of view <i>Prof. Dr. Dr. Karl-Ulrich Rudolph</i> (Consultant, Germany)	178
Results of Parallel Session 3 presented at the plenary	187
Minutes of Parallel Session 3	189
List of participants	193

---

**Parallel Session 4:  
Practical experiences with alternative sanitation strategies, best practises/  
typical problems and questions**

---

Lectures	
Dry sanitation in Palestine, a pilot project in the Hebron District 2000-2001 <i>Gert de Bruijne</i> (Palestinian Hydrology Group, Palestine)	197
Ecological sanitation and wastewater management systems in North America and the Pacific Islands <i>David del Porto</i> (Consultant, USA)	204
Experiences with ecosan projects in Germany and Austria <i>Dr. Martin Oldenburg</i> (Consultant, Germany)	209
Reducing wastewater problems in low-income semi-urban communities in Kathmandu valley <i>Eveline Bolt</i> (IRC, Netherlands)	216
Results of Parallel Session 4 presented at the plenary	227
Minutes of Parallel Session 4	229
List of participants	231

---

**Parallel Session 5:  
Potential and limitations of the „scenario technique“ as a contribution to  
sustainable urban planning**

---

Lectures	
A national PhD programme for developing future sanitation systems in Sweden <i>Dr. Jan-Olof Drangert</i> (Linköping University, Sweden)	235
Urban and rural sanitation concept with nutrient recycling and energy gain <i>Dr. Katharina Backes</i> (Consultant, Germany)	238
Wastewater irrigation in the State of Victoria, Australia <i>Dr. Percival Thomas</i> (La Trobe University, Australia)	245



Auroville 2001 – a town dependent on its rain- and wastewater <i>Harald Kraft</i> (Consultant, Germany)	251
Results of Parallel Session 5 presented at the plenary	263
Minutes of Parallel Sesion 5	265
List of participants	269

#### 4 Annex

---

Additional papers not presented at the conference	
Health implications of reusing dehydrated faecal matter <i>Aussie Austin</i> (CSIR, South Africa)	275
ECOSAN – the recycling sanitation system <i>Gunder Edström and Almaz Terrefe</i> (Sudea, Ethiopia)	278
Valuable use of urine, faeces, household waste and some greywater <i>Gunder Edström and Almaz Terrefe</i> (Sudea, Ethiopia)	281
Ecosan as one element of advance towards an ecological urban planning <i>Hans-Joachim Hermann</i> (GTZ, Germany)	285
Faecal contamination of a fish culture farm where hospital wastewater grown duckweeds are used as fish feed <i>Dr. Sirajul Islam</i> (ICDDR, Bangladesh)	289
Potential of reed beds (constructed wetlands) for sustainable wastewater treatment in residences and industry <i>Dr. Margarita Winter</i> (Base Tech, Germany)	299
Sustainable wastewater treatment with soil filters <i>Brigitta Züst</i> (Center for Applied Ecology, Switzerland)	307
List of participants	313

## PROGRAMME

### International Symposium Ecological Sanitation

30./31.10.2000 Bonn, Germany

### ecosan - closing the loop in wastewater management and sanitation

29.10.2000

18.00 -  
20.00 Registration of participants

30.10.2000

Moderation: Dirk Jung

8.30 Registration of participants (continuation)

9.30 **Stefan Helming** (Head of Division Water, GTZ, Germany)  
Opening remarks

9.35 Keynote addresses

**Sustainable water  
management - a global  
challenge for the 21st century!**

**Dr. Uschi Eid** (Parliamentary State Secretary  
BMZ, Germany)  
**Anil Agarwal** (Director CSE, India)  
**Wolfgang Kroh** (Senior Vice President KfW, Germany)  
**Dr. Christoph Beier** (Director Planning and Development  
Department GTZ, Germany)

Introductory statements and panel discussion

11.00 COFFEE BREAK

**What are the existing  
approaches & visions?**

11.30 **Christine Werner** (GTZ, Germany)  
ecosan - a holistic approach to material-flow-management  
in sanitation

11.50 **Dr. Steven Esrey** (Unicef, USA)  
Closing the loop: Links between ecosan, agriculture and  
food security and  
presentation of parallel session 1

- 12.25 **Himanshu Parikh (Consultant, India)**  
Slum Networking - Sustainable sanitation strategies to reach the urban poor

13.00 LUNCH

- 14.30 **Dr. Robert Holländer (BMU, Germany)**  
Sanitation and sustainable water management in Germany
- 14.45 **Roland Schertenleib (EAWAG, Switzerland)**  
Household centered environmental sanitation approach (HCES) and presentation of parallel session 2
- 15.20 **Uno Winblad (Consultant, Sweden)**  
Development of ecosan-systems, municipal planning aspects and presentation of parallel session 3
- 15.55 **Dr. Andrea Detmer (BMBF, Germany)**  
New funding activities on alternative technologies

16.10 COFFEE BREAK

- 16.45 **Prof. Dr. Ralf Otterpohl (TUHH, Germany)**  
New ecosan developments in Germany and Europe and presentation of parallel session 4
- 17.20 **Prof. Dr. Wolfgang Dorau (UBA, Germany)**  
Hygienic safety and water-reuse-potential increased by means of bio-membrane-technology
- 17.50 **Dr. Harald Hiessl (Fraunhofer Institut, Germany)**  
AKWA 2100, scenarios for alternative urban water infrastructure systems and presentation of parallel session 5

18.25 BREAK

- 19.00 First meeting of parallel sessions 1-5

20.00 DINNER BUFFET IN THE "RÖMERKELLER"

**31.10.2000**

Moderation: Dirk Jung

**Need for action & fields of cooperation**

8.30 Introduction to the second day

9.00 **Parallel sessions 1-5**  
**Impulse presentations and discussions**

**Parallel session 1**

**Options and limitations for the application of recyclables; agricultural needs, hygienic and economic aspects**

Key-question: How can we focus new sanitation strategies on the agricultural context?

Moderation: **Dr. Steven Esrey (Unicef, USA)**  
**Christine Werner (GTZ, Germany)**

**Armin Rettenberger, Prof. Dr. Peter Kunz (University of applied Sciences of Mannheim, Germany)**  
Production of fertilizer water from waste water

**Cleophas Musara (Mvuramanzi Trust, Zimbabwe)**  
Participatory hygiene and sanitation promotion in Zimbabwe

**Prof. M.K.C. Sridhar (University of Ibadan, Nigeria)**  
Urban farming and ecosan in Nigeria

**Dr. Ranka Junge Berberovic (University of Wädenswil, Switzerland)**  
Possibilities and limits of wastewater-fed aquacultures

**Parallel session 2**

**Rethinking Sanitation - Bellagio-Principles and Household centered environmental sanitation approach (HCES)**

Key-question: What are the needs for international action in implementing the Bellagio-Principles and the HCES-approach?

Moderation: **Roland Schertenleib (EAWAG, Switzerland)**  
**John Kalbermatten (Consultant, USA)**

**Klaus Kresse (GTZ, Germany)**  
UN report on the state of the earth

**Tony Richards (GTZ, Botswana)**  
Appropriate sanitation technologies for Botswana

**Paul Calvert (Consultant, India)**  
Practise and potential of ecosan in India

**John Kalbermatten (Consultant, USA)**  
Framework for action

**Parallel session 3**

**Implementation of holistic sanitation strategies within socio-cultural, political and urban planning frameworks**

Key-question: What are the strategies to achieve the acceptance and participation of target groups and politicians?

Moderation: **Uno Winblad (Consultant, Sweden)**  
**Madeleen Wegelin-Schuringa (IRC, Netherlands)**

**Prof. Dr. Gerd Förch (GTZ / Rodeco, Ethiopia)**  
 Sanitation Project Adolala – a case study from Oromiya/Ethiopia

**Madeleen Wegelin-Schuringa (IRC, Netherlands)**  
 How to get people interested into ecosan

**Prof. Dr. Dr. Karl-Ulrich Rudolph (Consultant, Germany)**  
 Potentials of alternative systems from the economical point of view

#### Parallel session 4

#### **Practical experiences with alternative sanitation strategies, best practises/typical problems and questions**

Key-question: How can we identify and evaluate best practises?  
 What are the priority research demands?

Moderation: **Prof. Dr. Ralf Otterpohl (TUHH, Germany)**  
**David del Porto (Consultant, USA)**

**Gert de Bruijne (Palestinian Hydrology Group, Palestine)**  
 Dry sanitation project in Palestine

**David del Porto (Consultant, USA)**  
 Ecosan in the United States, Canada and the Pacific Islands

**Dr. Martin Oldenburg (Consultant, Germany)**  
 Experiences of ecosan projects in Germany and Austria

**Eveline Bolt (IRC, Netherlands)**  
 Reducing wastewater problems in low-income semi-urban communities in Katmandu valley

#### Parallel sessions 5

#### **Potential and limitations of the „scenario technique“ as a contribution to sustainable urban planning**

Key-question: What are the means for realistic and sustainable planning methods?

Moderation: **Dr. Harald Hiessl (Fraunhofer Institut, Germany)**  
**Frank Sperling (Emschergenossenschaft, Germany)**  
**Dr. Jan-Olof Drangert (Linköping University, Sweden)**

**Dr. Percival Thomas (La Trobe University, Australia)**  
 Wastewater irrigation in the State of Victoria, Australia

**Dr. Jan-Olof Drangert (Linköping University, Sweden)**  
 National programme of future sanitation systems in Sweden

**Dr. Katharina Backes (Consultant, Germany)**  
 Urban and rural sanitation concepts with nutrient recycling and energy gain

**Harald Kraft (Consultant, Germany)**  
 Auroville 2001 – a town dependent on its rain- and wastewater

10.30 BREAK

11.00 continuation of the parallel sessions

13.00 LUNCH

14.15 **Plenary session**

Moderation: Dirk Jung

Presentation and discussion of the session-results in plenum

Identification of supra-country and donor-relevant need for action regarding the systematic advancement of ecosan programmes in development cooperation

16.00 **Stefan Helming (Head of Division Water, GTZ, Germany)**  
Official close

COFFEE BREAK & DEPARTURE

**Abbreviations:**

PSts	-	Parliamentary State Secretary
BMZ	-	Federal German Ministry for Economic Cooperation and Development
CSE	-	Center for Science and Environment
KfW	-	German Development Bank
GTZ	-	German Agency for Technical Cooperation
BMU	-	Federal German Environment Ministry
EAWAG	-	Swiss Federal Institute for Environmental Science and Research
TUHH	-	Technical University of Hamburg-Harburg
BMBF	-	Federal German Ministry for Education and Research
UBA	-	Federal German Environmental Agency
IRC	-	International Water and Sanitation Centre



## 1 Keynote addresses

### Sustainable water management – a global challenge for the 21st century!

#### Statements

<b>Dr. Uschi Eid</b>	(Parliamentary State Secretary, BMZ, Germany)
<b>Anil Agarwal</b>	(Director CSE, India)
<b>Wolfgang Kroh</b>	(Senior Vice President KfW, Germany)
<b>Dr. Christoph Beier</b>	(Director Planning and Development Department GTZ, Germany)





**Dr. Uschi Eid**

Parliamentary State Secretary,  
Federal Ministry for Economic Cooperation and Development  
Postfach 120322, 53045 Bonn, Germany

Distinguished Guests,

Ladies and Gentlemen,

I am pleased to be able to welcome you on behalf of the German Ministry for Economic Co-operation and Development to today's symposium. I especially welcome those of you who have travelled to Bonn from other countries or even continents.

I personally am delighted that you have come, since water management is a topic to which I have devoted particular attention in the past and wish to do so in the future. Having spent long periods myself in East Africa in particular and made extensive visits to all kinds of water-related projects in the Southern African region, I have on the one hand become very familiar with the prevailing water problems in these African regions. On the other hand I have also experienced some very innovative and promising policy approaches and incredibly committed politicians and people from all kinds of backgrounds who are dedicated to finding solutions.

I would just like to mention, for example, the co-operative spirit that is the driving force behind the transboundary co-operation between riparian states on the Nile and the outstanding commitment of all states within the SADC region to dealing appropriately with water issues.

In staging this symposium, the BMZ is exploring new avenues. We wish to devote greater attention to the topic of wastewater and to gain new knowledge to help in our further work. In order to do so, we want to benefit from your expertise and your experience and I hope that you, yourselves, will gain something from the dialogue that will take place today and tomorrow. I hope that over the next few days you will have an open and interdisciplinary discussion that will result in innovative and far-reaching ideas to help solve the water crisis.

**Water - an issue affecting our future**

Finding solutions to the world water crisis is probably the most challenging task the international community is facing today. A change in perception as well as concrete action is required to achieve sustainable and integrated water management.

Across the world there are 1.3 billion people who have no access to clean water. Twice as many have no adequate sanitation facilities.

Children and women in particular lack access to sufficient water, as do small farmers. Ecosystems are damaged or destroyed by overexploitation of water and by pollution.

Unfortunately, the facts available at present indicate that the situation is likely to become more, rather than less, acute in the future. Population growth implies an increased demand for water. The increasing pollution of water by private households, industry and agriculture further depletes supplies of clean water. One key problem is the wastage of water due to inefficient use, be it in agriculture or urban water supply. Often, it is because water is free or heavily subsidised that it is wasted in this way. Ultimately, increasing water shortages lead to rising prices and battles over distribution that can even, in some cases, escalate into violent conflicts. These conflicts may arise between individual consumers, groups of consumers, regions or countries.

In the future, water must be used more sparingly and more efficiently. To achieve this, not only do we need a new awareness among users, planners and the authorities but the necessary political decisions will also have to be taken. Managing demand is frequently not only a more sustainable way of dealing with the problem but also cheaper than tapping new sources.

Water has now also become a major issue for international debate. In its Global Environment Outlook (GEO 2000), the United Nations Environment Programme (UNEP) quite correctly points out that, second only to the dangers of climate change, the freshwater crisis is the greatest ecological threat of our times.

This urgent need to take action in the area of freshwater has just recently been emphasised in the United Nations Millennium Declaration adopted by the Millennium Assembly on 8 September 2000. The Millennium Assembly declares that by 2015 the proportion of people who are unable to reach or to afford safe drinking water will be halved and that the unsustainable exploitation of water resources will be stopped by developing water management strategies at regional, national and local levels that promote both equitable access and adequate supplies.

### German development co-operation in the water sector

Ladies and gentlemen,

Given these world-wide water problems and these ambitious international commitments, one thing is clear: water supply and sanitation and the integrated management of water resources are quite rightly a major priority of the federal German government's development co-operation. This has been the case in the past and will remain so in future. Providing as it does a sum of between DM 600 and 800 million each year, Germany has long been one of the international community's largest donors in the water sector.

Solving water problems is not first and foremost a task for the donor community. What is needed above all is a farsighted and viable policy on the part of the countries themselves. Development co-operation cannot and should not by any means supplant the initiatives and independent efforts made by the partner countries and in the regions but should, instead, underpin them. We want to support our partners, the developing countries, in realising such a policy. However, where the political will to create and enforce an enabling environment is lacking, development co-operation can achieve little or nothing.

In addition to our many development co-operation projects, the federal German government also wishes to foster progress in the debate on the proper and sustainable use of freshwater under the aegis of the United Nations. That is why Germany is staging the "International Conference on Freshwater" in December 2001 in preparation for "Rio + 10". The week before last, I was at Expo 2000 to open the first session of the international steering group that is making the preparations for this conference. A great deal of commitment and expertise was in evidence at the discussions that took place over two days in Hanover. We hope that real progress will be achieved on vital international water issues at the end of next year in Bonn.

In view of the massive demands and the urgency of the water problem, our partner countries must take determined action. German development co-operation wishes to help achieve this. It would, however, be illusory to pin all our hopes on the players at national level and on international co-operation. It is my conviction that we need the co-operation of non-governmental organisations and the private sector. Here is where I see an opportunity for new, useful and efficient partnerships that will benefit all involved. In many developing countries, the private sector is investing in and operating water supply and sanitation facilities. We greatly welcome this involvement on the part of the private sector, as it is often useful from a development policy

point of view. In many of our development projects, we help to ensure that private sector involvement is not in any way detrimental to the poor or the environment.

Yet there is another innovation we require in addition to new partnerships: an efficiency revolution in the water sector. How can we use water more efficiently across the world, in industry, agriculture and for household use? How, in particular, can we achieve these aims with the diminishing financial resources available? It is not only technical solutions that are required for this revolution in efficiency. We need a new awareness among users, managers, planners and the authorities, but the necessary political decisions will also have to be taken – something of which I, as a politician, am perfectly aware.

### **“Ecological sanitation – closing the loop in wastewater management and sanitation”**

Ladies and gentlemen,

Today's symposium aims to help further develop innovations in the field of sanitation that will enhance efficiency in the water sector. In this way, we are quite deliberately focusing on the often neglected field of wastewater treatment. Let me state quite clearly: where wastewater treatment is inadequate, hygiene is often below standard and scarce water resources are polluted and wasted. In this way, inadequate, as well as inappropriate, water treatment incurs considerable costs. This, then, is a topic of interest not only for water-stressed areas but also for a country rich in water such as Germany. In August this year, a mayor in the federal state of Brandenburg went on hunger strike together with some colleagues to protest against the ecologically and economically questionable decision by the authorities to attach her small municipality to the central sewage grid.

The issue we are dealing with today is more than the simple liquid form of water and I am pleased to see a real mix of people at this conference representing an interdisciplinary and international approach. I believe we can learn from each other: even if water problems are regional phenomena, in the North-South dialogue we share our quest for new solutions. We in Germany are also interested in low-cost and environmentally friendly solutions. We in Germany can only benefit from your experience and expertise.

The idea behind Ecological Sanitation is a persuasive one: water is utilised as a foodstuff that is in scarce supply rather than as a means of transporting faecal matter through an expensive water-borne sewerage system. Urine and faecal matter are used as fertiliser and do not pollute scarce water resources. Practical solutions are already being tried out in developing and developed countries, but it is not everyone that has heard about them. What is lacking is an awareness that this is a sustainable alternative, compatible with the needs of the future.

I am pleased that Bonn, headquarters of the Secretariat of the Convention to Combat Desertification, is the venue for this symposium and that some of our colleagues from the Secretariat are also here today. The concept of Ecological Sanitation looks at water not in isolation but in the context of agriculture, erosion control and the maintenance of soil fertility in the broadest sense. Thus, Ecological Sanitation makes a major contribution to the implementation of the United Nations Convention to Combat Desertification. This Convention has, for the first time, defined the principles that are beneficial in utilising scarce resources, such as that of decentralising responsibility or of popular participation. The fact that the Convention is based on the principle of partnership is of vital importance for the maintenance of soil fertility. (Just a note in passing: I am particularly pleased about the US Senate's ratification of the Convention within the last few days and would like to offer my congratulations. A further party to the Convention has thus now recognised it and will set about implementing it.)

Ladies and gentlemen,

“Closing the loop in wastewater management and sanitation” – this is the idea behind our plan for the research and development project lasting several years. In this way, the BMZ hopes to learn how to further develop the approaches it is pursuing in the field of wastewater. This symposium should help us in this and in establishing contacts with you for the future.

I would like to extend a warm welcome to you once more and hope that you will enjoy being in Bonn. I wish you good and productive discussions and look forward very much to your conclusions. I hope each of you will take away a few good ideas from this conference.

Thank you.

**Anil Agarwal**

Director, Center for Science and Environment India,  
41, Tughlakabad Institutional Area, New Delhi, 110062, India

Water-borne sewerage is a waste disposal paradigm that works neither for the poor nor for poor nations and settlements. This paradigm is extremely expensive because it has high economic costs, environmental and public health costs and, as a result, high political costs.

Let us look at these costs one by one.

**Economic costs of sewers:**

Sewer systems need heavy inputs of money for:

- (a) *Constructing urban sewerage;*
- (b) *Maintaining urban sewerage; and,*
- (c) *Constructing and operating sewage treatment plants.*

Most developing countries cannot afford these costs. Using these systems means a huge and perpetual subsidy and, unfortunately, these subsidies invariably benefit only the rich.

**Environmental costs of sewers:**

There are several environmental costs of sewers. Some of these are:

*(a) Heavy use of riverine waters for urban areas*

In a rapidly urbanising country, as most developing countries are at the moment, this means heavy use of river waters and growing conflicts between urban and rural water users. In late 1999, for instance, faced with a serious drought in the coming dry months, the government of Gujarat reserved the waters of the Kankavati reservoir for the town of Jamnagar. In December, people of Falla village, who were earlier benefitting from this water, protested against the reservation. The police opened fire and killed three villagers and injured 20 others. These conflicts will intensify with increasing urbanisation and become unmanageable during drought periods. Overexploitation of rivers is so high that many rivercourses do not even have 'minimum river flows'. In the case of the Yamuna which passes through the capital, Delhi, the Supreme Court has had to order a 'minimum river flow'.

*(b) Hydrocide*

Discharge of domestic sewage leads to heavy pollution of rivers and often even of urban groundwater aquifers. The latter is a particularly serious problem because groundwater is often drunk in a country like India without any treatment and is becoming an important source of drinking water even in cities.

*(c) Disruption of nutrient cycles (nitrogen, phosphorus, potassium and various micronutrients) and consequent depletion of soil fertility*

Whereas the nutrients contained in human food come from agricultural lands, sewer systems dump the nutrients contained in human wastes into waterbodies. This not only destroys these

waterbodies over time, it leaves the agricultural lands depleted of nutrients over time. Artificial fertilisation is mainly limited to nitrogen, phosphorus and potassium but soils contain numerous micronutrients as well which get depleted over time. The lack of these micronutrients not only becomes a limiting factor in plant productivity but the resulting lack of these nutrients in human food becomes a threat to human health. Even by the early 1980s, Punjab, the centre of India's Green Revolution, had large tracts of land with zinc, manganese and iron deficiency. Ludhiana district, which records the highest yields of many crops, was also recording the highest deficiencies of micronutrients. Though scientists still have to find out much about the health effects of consuming micronutrient-deficient foodgrains, scientists at the Postgraduate Institute of Medical Sciences in Chandigarh, capital of Punjab, have found that consuming zinc-deficient foodgrains can lead to retarded growth and sexual development, defective wound healing and carbohydrate intolerance.

### *Roma and Edo*

In this context it would be important to note the difference between the water cultures of the people of ancient Rome and the town of Edo which grew into the mega-metropolis of Tokyo. The people of Rome brought their drinking water with the help of long aqueducts which today are regarded as architectural marvels of the bygone Roman civilisation. But the people of Rome lived on the banks of the river Tiber. They really had no need to bring water from afar. Unfortunately, they did not know to dispose off their human wastes like the modern Western civilisation and ended up polluting the river, thus forcing them to go far in search of clean water. This makes Roman aqueducts not a symbol of intelligence but one of great environmental stupidity. The aqueducts created social problems too. There was not enough water. There were few standposts. Most of the water went to the elite and very little was left for the poor.

On the other hand, Edo, which too was situated on several streams, ensured that all its human wastes were collected and returned to the farmlands. Its neighbouring rivers remained clean and it tapped its water from them through an extensive piped water supply. Though the Edo society was as inegalitarian as that of Rome, its water supply was not.

### **Public health costs of badly managed sewer systems:**

Sewer systems are built to protect public health but badly managed sewer systems can become a serious threat to public health. For example:

(a) *There can be serious outbreaks of waterborne diseases* resulting from:

- River pollution (because of sewage outfalls);
- Groundwater contamination (because of leaky sewer lines);
- Contamination of piped water supply systems (because of leaky sewer lines leading to infiltration of pathogens into drinking water pipelines, especially when they do not have water, which is the case in many cities in developing countries as they cannot provide water round the clock); and,
- Sewage backflows (because of badly maintained and blocked sewers or because of increasing use of non-biodegradable materials like plastic bags).

In the Indian city of Aligarh, sewer lines overflow all the time. A study conducted by the Aligarh Muslim University for the Centre for Science and Environment found that 49 per cent to 70 per cent of the households, depending on different localities, complained of seasonal or permanent waterlogging due to overflowing sewage drains. As a result, people have raised the plinth of their houses to keep the sewage from flowing into their houses. This has resulted in a huge

market for earth – as much as 1,000 cubic metres per day -- supplied today by numerous villages around the city destroying precious agricultural land.

These problems become particularly serious when there are urban floods. In Indian cities this is becoming a serious and growing problem. With natural drainage channels blocked because of poor urban planning, stormwater drains are not able to cope with the monsoon storms and overflow on to the surface often mixed with sewage. The worst affected in urban floods in all Indian cities are the poor who live in the low value lowlying lands. For days you can have an ironic situation: Water, water everywhere but not a drop to drink.

### Political costs of sewer systems:

The economic, environmental and public health costs cited above lead to several political costs as well. Some of them are:

*(a) Growing tensions between urban and rural populations over increasingly scarce water*

A classic case of these tensions is presented by Delhi. The city has so overexploited its surface and groundwater resources that every summer it has to fight for water from the neighbouring states of Haryana and Uttar Pradesh whose farmers have to suffer because of the political clout of Delhi.

*(b) Growing disparity between urban and rural populations in terms of waste disposal facilities*

Sewer systems are so expensive that almost no government in the developing world is even thinking of making such systems for rural settlements.

*(c) Growing disparity within urban populations in terms of waste disposal facilities*

Even most poor urban dwellers cannot afford sewer systems. The urban remain an 'unreached' population.

*(d) There is also gender injustice*

In most cultures, women need the maximum privacy for their ablutions. And, as a result, they suffer more than men in the absence of private sanitary facilities.

The *political economy* of sewer systems is extremely atrocious in poor developing countries. Hardly any poor city is able to recover its investments in sewer systems. As a result the users of these sewer systems get a subsidy. But almost all users in poor cities are the rich. Thus, sewers only lead to a subsidy for the rich to excrete in convenience. The poor always remain the 'unserved' in this waste disposal paradigm. In addition, the government has to invest in sewage treatment plants whose costs are again rarely recovered from the rich users of flush toilets. The Indian government looks for foreign aid or loans for these sewage treatment facilities.

Almost all small rivers are badly polluted in India today. Even bigger ones like the Yamuna have become nothing but filthy drains. Before the Yamuna Action Plan was started, the river was receiving 1,700 million litres untreated sewage along the 22 km stretch of Delhi. The total BOD load was 132 tonnes per day and the total coliform count in the river water was 9,000,000 MPN/100 millilitres.



## River clean-up programmes

But even with foreign aid and subsidisation of the rich, do river clean-up programmes work? If India's experience is anything to go by, they don't because of several reasons, some of which are:

*(a) Lack of funds*

Even if the government were to bear the full capital costs of sewage treatment plants, few urban municipalities have the financial resources to bear the expensive operating costs. As a result, sewage treatment plants, even when built, often stand idle.

*(b) Lack of political will*

There is very little political will to clean up the rivers. It is not an electoral issue.

*(c) Lack of public involvement*

Public concern about water pollution is quite limited and episodes like outbreaks of waterborne diseases have a short public memory especially as they affect mostly the urban poor. Most citydwellers turn their backs on their rivers. Lack of public consciousness and lack of public involvement in river pollution management results in lack of public pressure on the political system to deliver.

*(d) Corruption*

River clean-up programmes are mainly cement, bricks, pumps and pipes in the current human waste disposal paradigm. Given limited public and political interest in these works, there is enormous scope for corruption which results in poor work.

*(e) Badly maintained sewer systems*

It is not enough to set up Sewage Treatment Plants (STPs). The sewer lines leading to these plants should also be well maintained. In Delhi, a number of STPs have been set up but they work well below their capacity because the sewer lines leading up to them are badly choked. Sewage from these choked and broken lines is diverted to functioning lines and, as a result, the STPs at the end of these lines are overloaded leading to untreated sewage flowing into the river. Thus, there is an ironic situation. While some plants are overloaded, some are under-utilised.

*(f) Constant chasing of the coverage target in rapidly urbanising countries*

Even if a river clean-up programme were to work, in a rapidly urbanising situation, a city would soon outgrow the sewage treatment capacity created at a high cost. Further investments will be needed all over again.

In India, the Ganga Action Plan and its successor, the National River Action Plan which covers other rivers, have both been plagued by these problems and are generally considered to be failures.

## Rich Indians ape the West

The upshot of all this is that rich Indians drink bottled water leaving the poor to suffer the life-threatening results of their excretion. Bottled water use is growing rapidly in India – doubling and tripling every year. Today 300-odd bottled water companies supply 400 million litres of water at a turnover of about Rs. 700 crore (US\$156 million). The market is becoming so big that even giants like Pepsi and Coca Cola have entered it. If 300 million urban Indians were to drink bottled water one day, the industry would have a turnover 8-10 times the size of the current auto industry.

## Desperate need for an alternative paradigm

Poor countries are in a desperate need for an alternative, cost-effective, non-sewage paradigm of human waste disposal.

The capital-intensive, material-intensive urbanisation process of the West works only for rich countries, not poor countries. Urban sewerage is a classic example of the malfunctioning of the Western-style urbanisation process in poor countries.

Ecological Sanitation is a paradigm that we must explore in all earnestness. But *we must make sure that the new technologies take into account cultural constraints* otherwise they are unlikely to succeed. Some of these constraints are:

(a) *The technologies must be such that they can be accepted by the richest of the rich.*

The poor aspire to live like the rich. If the ecosanitation technologies are only serving the hitherto ‘unserved’ poor, they will continue to aspire for the sewage-based sanitary systems used by the rich. In that case, ecosanitation technologies will only become an interim alternative, one to be discarded as soon as people become rich. Even if people cannot afford them, the stress on the hydrological system will become unbearable.

An excellent example of poor people aspiring for sewer systems comes from the outstanding Orangi Pilot Project in Karachi, Pakistan. The poor settlers said clearly that they did not want any pit latrine. They wanted a sewer-based disposal system.

(b) *The technologies must be such that even the ‘pure castes’ can accept them.*

Not all people have history like that of the Japanese, Chinese or Koreans who have handled human excreta for ages. Even they are becoming Brahmins now that they are becoming rich and aspiring for flush toilets.

Time is against us in poor developing countries. Our population is growing and our population is getting rapidly urbanised. The sewer-based paradigm will only create more disparities and more environmental mayhem.

## What we need today are two key actions

*Firstly, we need massive investments in R&D for non-sewage alternatives.* While investments in sewer systems run into billions of dollars every year despite all the problems they create, R&D investments in non-sewage alternatives do not reach even a few tens of millions. The current R&D investment must at least tripled or quadrupled.

*Secondly, we need massive support for experimental / pilot projects. We know enough about ecosanitation technologies that we now need to learn from field projects. By massive, I mean catalytic and adequate support, not huge sums of money.*

**Wolfgang Kroh**

Senior Vice President, Kreditanstalt für Wiederaufbau (KfW)  
Postfach 111141, 60046 Frankfurt, Germany

Secretary of State Dr. Eid,

Dear Mr. Agarwal and Mr. Beier,

Ladies and Gentlemen,

First of all I wish to thank GTZ for organizing this important symposium and also for giving me the opportunity to speak to this distinguished auditorium of experts.

As far as the global situation in water management and sanitation is concerned I will not try to add new facets to what has already been said by Dr. Eid and also by Mr. Agarwal.

I think, we all agree that there is a pressing need for improvement and also for new approaches and innovative technical solutions.

I shall rather confine myself to some remarks reflecting KfW's past experience in this field and lessons learned, which we think should be considered in our future actions.

As part of the German Official Development Assistance Programme, our bank, KfW, commits investment loans and grants of some 500 Million DM per annum for water supply and wastewater treatment projects in more than 30 developing countries.

This is about one fifth of our total commitments within German Financial Cooperation, which is thereby one of the world's largest bilateral sources of financing for this sector.

We have been active in the area of rural water supply and sanitation for many decades. Adapted, decentralized solutions which account for basic needs are still a top priority. Such investments are usually accompanied by campaigns to raise awareness and encourage hygiene.

Following sectoral reforms new operating concepts have been established and tested recently in many countries.

In urban areas, our commitment concentrates on medium-sized cities. Here in many cases we are together with German Technical Cooperation through GTZ, which plays a key role for strengthening the management capacity of local project sponsors.

It is also worth mentioning that more than half of our commitments for urban areas are currently made for wastewater projects.

This demonstrates the high priority given to community hygiene and water resource conservation.

In our actual work we observe that the following aspects are increasingly gaining importance:

- a) the availability of water resources and their management,
- b) the increasing competition over the use of water resources among private, industrial and agricultural users,
- c) rising water quality problems, and – in some cases -
- d) the need for considering water cycles.

I would like to mention a few examples from our current project portfolio to illustrate how relevant the topic of this symposium already is for our practical work:

- We finance a number of wastewater projects which fulfil the requirements for the re-use of treated wastewater, among others in Tunisia, in Jordan and in the Palestinian Territories. [In the latter two countries, a comprehensive study of the possibilities of re-using wastewater in agriculture is being carried out.]
- In Turkey, concepts for using sewage sludge in agriculture were developed. Thus far the practical implementation of these concepts has generated satisfactory results.
- In Namibia, at the end of this year, a plant will take up operations which will purify pre-treated wastewater to produce drinking water. In coming years, this plant will supply up to 40 % of the capital's requirements! In the case of Namibia we linked our financing to significant improvements in demand management by way of price increases and water conservation campaigns the results of which have proven highly successful.
- Finally, new technologies are also being tested such as anaerobic processes to treat municipal sewage in Ecuador and in Egypt. In this context we would like to underline the good co-operation with GTZ. Their programme "Promotion of Anaerobic Technology", for instance, has developed approaches which are now implemented at larger scale through Financial Cooperation.

In connection with new concepts and the use of "appropriate or adapted" technologies, I would like to point to the following lessons:

1. Conventional wastewater treatment systems do have their merits in particular where sewerage systems already exist. And this is frequently the case for example in the Middle East and North Africa countries. By expanding these options, significant results may be achieved with limited funds.

In addition, conventional technologies provide solutions which most of our partners know, accept and do desire.

[The main practical problem, in these cases, is to determine the appropriate treatment process and the adequate capacity of treatment works. ]

2. I will not conceal the fact that the delimitation of centralized vs. decentralized solutions in city outskirts, slums and scattered settlements can be very difficult. [The same holds true for design parameters and for treatment standards.] The wishes of our partners as well as suggestions made by consulting engineers sometimes exceed the limits of ecological and economic viability. Frequently, we have to adjust expectations and to apply concepts for gradual expansion. [Therefore in most of our projects central sewerage is limited to high density settlement areas whereas in the remaining areas on-site systems are promoted.]
3. Solutions for re-use of treated wastewater and of sewage sludge in order to close water and nutrient cycles are gaining priority, in specific in very densely populated arid regions. However, based on our first experiences this undertaking can be highly complex and challenging from a technical, socio-economic and organizational point of view.
4. Promoting "appropriate technology" - in our view - implies that we focus on the very problems to be solved: Thus, depending on local conditions, in principle a wide range of technical solutions from simple latrines to sophisticated treatment facilities may emerge as being "appropriate".

In any case, there are no universal solutions.

As an outlook and for your further consideration during this symposium, I would like to mention some of our conclusions.

1. We appreciate that during this symposium new technologies will be discussed which aim at separating water and nutrient cycles. Because of their ecological merits, these new

technologies need to be further explored and tested. However, with regard to their large-scale application in developing countries, we should be cautious as long as we do not have gathered substantial practical experience in our own countries (- apart from pilot projects).

2. The framework of laws, statutes, standards and tariffs, as well as the management efficiency of project implementing agencies and service providers significantly influence the success and sustainability of the investments promoted.

In order to fully cover operating and investment costs these institutional and policy frameworks need to be further improved in many countries.

3. Choice of technology and framework conditions depend on political decisions about sectoral strategies. In order to support reform, the formulation of respective milestones, pre-conditions and covenants may be useful, but also compromises have to be found and transformation will also need time.
4. In arid countries, huge opportunities for resource conservation lay in irrigated farming and not so much in the domestic domain - a fact evident when considering the problem from a broader perspective.

In conclusion, let me stress that technologies we would like to be accepted by our partners must have proven to be cost-effective, safe and environmentally sound before they can be used for large-scale application!

KfW will participate and collaborate in the efforts towards more effective and efficient wastewater and sanitation projects. Therefore, we welcome the exchange of views during this symposium.

I thank you for your kind attention and I wish this symposium to be a great success!

**Dr. Christoph Beier**

Director Planning and Development Department,  
Deutsche Gesellschaft für Technische Zusammenarbeit  
(GTZ) GmbH  
Postfach 5180, 65726 Eschborn, Germany

Ladies and Gentlemen,

Please allow me too to bid you a very cordial welcome here this morning at the Gustav Stresemann Institut.

It gives me great pleasure that so many of you have accepted our invitation to attend today's ECOSAN – Symposium. My special thanks go to those of you who have spared no effort to travel from far away to discuss your experience and ideas on the topic of "ecologically and economically sustainable sanitation". I am deeply impressed by the commitment you all show.

Today's Symposium is being hosted by **Deutsche Gesellschaft für Technische Zusammenarbeit (GTZ) GmbH**. As Director of the Planning and Development Department which is responsible for thematic work within the GTZ, I am glad that this event has stimulated such good attendance. After all, this is as an almost global exchange of opinions and experience about future challenges in urban development and sustainable management of scarce resources.

In Germany we make institutional distinctions between what we call technical and financial development co-operation. While the GTZ stands for advisory services to our partner countries – technical co-operation - , the KfW is responsible for financial co-operation – and thus also for funding the implementation of innovative solutions developed in the context of technical co-operation. I am particularly happy that Mr. Kroh as Director of the KfW is attending this Symposium. Since the two institutions co-operate successfully in the water sector in many countries, we naturally hope that alternative approaches to wastewater management will eventually find a stronger platform in project funding at the KfW.

I assume that you do not all have the GTZ's organisation chart in your mind – and I should like to spare you this today as well. However, for those of you who have not come across the GTZ so often yet, I should like to outline who we are, what we do and where we see the focal areas and our tasks for the future.

The GTZ is an organisation owned by the Federal Republic of Germany. We are the technical support and implementation institution for the German government in international co-operation. Our major client is the Federal German Ministry for Economic Co-operation and Development (BMZ). However as a limited liability company, we work for other donors as well – for instance for other ministries, national governments, or international organisations such as the EU, UN or World Bank.

Our activities are not profit-oriented – any revenues from such commissions are channelled back into our project work.

The GTZ has some 10,000 employees in 120 countries in Africa, Asia, Latin America and Eastern Europe to carry out its tasks. Only about 1/10 of these, roughly 1,200 people, are currently working at our Head Office in Eschborn. Most of our staff are engaged directly in our projects in the field. Some 4/5 of them, in other words about 8,000 persons, are local staff in our partner countries.

We work for the German Government to sustainably improve the living conditions for people in the poorer countries of the South and the East. Technical Co-operation – as we understand it - is all about boosting the performance capacity of both individuals, organisations and institutional

structures in our partner countries by harnessing, transferring and mobilising skills and expertise, and by enhancing the environment in which they are to be applied. We want to help people to help themselves and to strengthen their institutions in a manner which will ultimately render us superfluous.

The focus of our work has shifted from individual projects to support of structural reforms and solutions of organisational problems. We often assume an intermediary role when clashes of interest arise. Our preferred mode of delivery is to work from within the institutions, as advisors on the management of change, rather than to lead a dialogue from without. We therefore feel that our work complements sector work led by the World Bank or the KfW.

During our many years of activity in various fields of development co-operation, we have not only been able to pass on a great deal of expertise to our partners, but also and above all we have learned a lot from our partners too, and we want to continue learning together.

This means that we cannot come to a standstill with what appear to be proven strategies. Instead we also accept the challenge of finding new solutions. In this particular case of new approaches to urban sanitation, I am personally thrilled by the fact that the challenge can apparently not be solved by gradual improvements to existing solutions but needs a complete turn-around in approach.

We have also acquired important experience during our work in developing countries over the years. We have gained local knowledge and social competence in dealings with the people, with public authorities, policies, religion, cultural and geographic features etc.

Our stable presence in the field enables us to develop projects further with our partners, to acquire intensive knowledge of the needs and general conditions of the target groups, so that we can pursue the goal of implementing customised approaches.

Thus we are involved in a constant learning process together with our partners at home and abroad. We consider advancing this learning process to be an important task. Accordingly the Planning and Development Division is devoted not only to specialised backstopping for our local projects, but also to developing and promoting innovative solutions geared to practice world wide. In fact, “knowledge management”, better: the management of knowledge flows has become the main focus of work in head office.

Of course this learning process goes hand in hand with a continuous exchange of knowledge, not just between ourselves, but above all with our partners in the public and private sector, at home and abroad, and other development-policy organisations.

We can only develop the content of our work further and efficiently via such an exchange. This is why we organise events like the one we have here today.

Right from the very start of our work, the **Water Sector** has been one of the main pillars of Technical Co-operation. Alongside water supply and sanitation projects, watershed and resource management, the shared use of international waters and the involvement of the private sector in this field have been important subjects of our work.

As we can see – water is a resource of vital importance for society. Water is humankind's principal food and is indispensable for the production of further foods. Sound water management is an indispensable precondition for development. The water cycle remains an important constituent part of our climate system. We also rely on it to conserve vital resources and, for instance, our biodiversity. Shortages in water seriously affect our daily life. They cause distress and social tensions that can lead to open conflicts.

Water pollution and inadequate sanitation aggravate want and deprivation, make the task of water procurement even more difficult and cause illnesses. Poor population groups are most severely affected by this situation. Thus according to WHO estimates, some 80% of all diseases



occurring in many emerging countries, and one third of all deaths, are attributed to polluted water and hygiene deficiencies. Despite this, only about 5% of the world's wastewater is treated. More than one billion people have no access to clean water, and even fewer benefit from sound sanitation.

During the early years of the GTZ's work, the development of new water resources played a major role. However, the inadequate management of wastewater causes pollution of the environment and of the water resources, which further aggravates water scarcity. Life expectancy is directly linked with the availability of safe drinking water and related sanitation.

That is why an increasing number of projects is now devoted to wastewater treatment, as well as to improved utilisation of existing resources, water-saving measures and recycling, not to forget protecting water deposits against further pollution.

The GTZ is currently supporting more than 10 projects aimed chiefly at the wastewater sector, and a further 30 projects which include wastewater treatment as one of their focal areas of work. A growing number of these are projects that promote a wide variety of alternative wastewater treatment strategies.

To pick out just a few examples here I should like to mention an irrigation project with brackish water and wastewater in Jordan, the development of decentralised sanitation systems in Egypt, or near-natural wastewater plants in Argentina. Advisory services on environmental policy, for instance in the development of necessary legal bases for water supply and sanitation and for realising pilot plants, belong to our standard scope of tasks.

Against the background of an increasing demand for water led by rising world population numbers, ever faster urbanisation and (hopefully) economic growth, the further development of sustainable strategies for urban areas is becoming dramatically more important.

Used water in all its various forms must be recycled in a manner that secures long-term water supply and sanitation.

The term "Ecological Sanitation" covers ways of wastewater management that primarily serve the principles of recycling water and nutrients as well as reducing the need for fresh water. We use the term "Ecosan" not for a specific technology. Rather we use it for a whole range of technologies and institutional arrangements which address both the issue of water scarcity and better sanitation. We have a lot of questions concerning Ecosan but very little answers. This is why we have presented the issue to our Government for funding as a research and development project, and this is why we hold this Symposium starting here today.

We must find alternatives to the solutions that have prevailed so far, and we have come together today to discuss such alternatives. We want to talk about the various concepts and how they can be implemented – and we are aware that we need to look not only at technologies, but at the whole concept of urban development in its technical, economic and cultural aspects.

Allow me to wish you and us much success in our efforts.

## Minutes of the plenary discussion <sup>1</sup>

- Lester Forde: How do developing agencies attempt to prevent the export of unsustainable technologies?
- Uschi Eid: The checklist of project support criteria states that technologies should be ecologically and socially sound. In actual practice, however, the ministry cannot always ensure that. However, the political lines are in place.
- Wolfgang Kroh: Frequently, one finds oneself confronted with unsustainable expectations. Sustainability is not merely a question of technology. The process of selecting (technical) solutions calls for support with allowance for a broad range of aspects.
- Christoph Beier: In a free market, there is nothing you can do to keep people from selling whatever they please. We do, however, wish to engage in close cooperation for the selection of appropriate solutions.
- Uschi Eid: Something must be done to alter the behavioral patterns of "the rich". Major cities like Berlin and Frankfurt must opt for sustainable solutions of their own, if they wish to propagate the like in other parts of the world.
- John Kalbermaten: (to Ms. Eid) The Roman aqueducts actually were not a sign of intelligence, but we still keep acting as if they had been. We are living within a channeled system that is amenable to only marginal improvement. We are talking about people who earn \$ 2 a day and have not yet got past square one in terms of sanitation. These people need solutions of a kind that could not be compared with ours.
- (to Mr. Kroh) We need to work toward acceptance for new technologies instead of waiting for an all-clear signal. Does KfW [Kreditanstalt für Wiederaufbau = development loan corporation] support pilot projects in emerging countries to find out whether or not certain as yet untried approaches would be useful? Such technologies often encounter a lack of acceptance. What is KfW doing to get the people interested and provide support to the decision makers?
- Wolfgang Kroh: We also provide funding for pilot-scale projects. There are misgivings out there, including for example cultural prejudices against the agricultural use of sewage sludge. Things like that entail mutual compromises.
- Paul Calvert: Trying to convince people by word alone doesn't help much. Demonstrations are more successful. The GTZ scheme should include demonstration projects about training and awareness-raising.
- Christoph Beier: No amount of talking can achieve direct change, and pilot projects really are necessary, but they have to fit well into the respective situational constraints. Consequently, drafting and planning must be attended to with due care. Likewise, pilot projects must be designed with allowance for "capacities" and cultural aspects. This symposium is supposed to illuminate ways and means of designing projects.

<sup>1</sup> Minutes taken by Fauke Kebekus



## 2 Plenary Session

### What are the existing approaches and visions?

#### Lectures

**ecosan - a holistic approach to material-flow-management in sanitation**

Christine Werner (GTZ, Germany)

**Towards a recycling society, ecological sanitation – closing the loop to food security**

Dr. Steven Esrey (Unicef, USA)

**Slum networking – using slums to save cities**

Himanshu Parikh (Consultant, India)

**Sanitation and sustainable water management in Germany**

Dr. Robert Holländer (BMU, Germany)

**The Bellagio Principles and a household centered approach in environmental sanitation**

Roland Schertenleib (EAWAG, Switzerland)

**Development of ecosan-systems**

Uno Winblad (Consultant, Sweden)

**Planned funding activities on concepts and technologies of alternative, decentralized water supply and sanitation**

Dr. Andrea Detmer (BMBF, Germany)

**New developments of ecosan in Germany and Europe**

Prof. Dr. Ralf Otterpohl (TUHH, Germany)

**Hygienic safety and water-reuse-potential increased by means of bio-membrane-technology**

Prof. Dr. Wolfgang Dorau (UBA, Germany)

**AKWA 2100, scenarios for alternative urban water infrastructure systems**

Dr. Harald Hiessl (Fraunhofer Institut, Germany)



## **Ecosan - a holistic approach to material-flow-management in sanitation**

**Christine Werner**

Deutsche Gesellschaft für  
Technische Zusammenarbeit (GTZ) GmbH  
Postfach 5180, 65726 Eschborn, Germany

### **Welcome**

Dear Colleagues, Ladies and Gentlemen,

After more than one year of intense preparations for a new research project on closed-loop-approaches to wastewater management and sanitation, and after the exciting preparation of this event, I am glad to welcome all of you today, and I do this also in the name of my colleagues Jana Schlick and Gernot Witte.

After the official political opening of this symposium, allow me to explain the background and the objectives of our event to you in more detail. For this I should like to look at the following four points:

1. the problem analysis of today's water-use and sewage treatment and our motivation to work on alternative solutions
2. our understanding of the term "ecosan"
3. the expectations that you and we might have of this symposium
4. the question of what will happen after this event

### **Problem analysis of today's water-use and sewage treatment:**

As we have already heard from our Vice Minister, Ms. Eid and Mr. Beier, improvement of the water supply and sanitation conditions in countries of the Third World and newly industrialising countries has been a focal area of the GTZ's work ever since it was established 25 years ago. Although Germany, like many other donors, considers water supply and sanitation to be a priority field of development cooperation action, even after all this time we still have a long way to go in most of these countries before a satisfactory drinking water supply situation is reached. And in the sanitation sector the problems have in fact become steadily more acute. We know that in spite of the many efforts only about 5 to 10 % of the wastewater worldwide is treated, and this often insufficiently. Most of the wastewater is discharged without any treatment into the fresh water bodies, supposedly to flow on as nevercomeback into our oceans. We know very well that this has severe adverse impacts. As in other fields of the environment, a time bomb is ticking in our water balance.

In the meantime we know from experience that in particular our western disposal solutions consisting of centralised water-borne sewage systems leading to multistage sewage treatment plants seem to be unsuitable as a blanket solution for developing countries, particularly in arid climate zones. The main reasons for the partial failure of our supposedly "modern" technologies are their enormous investment, operating and maintenance costs, their high water consumption and other drawbacks. As you will hear in some other papers in the course of this event, these

centralised systems are running into criticism to a growing extent in the industrialised states too on economic and ecological grounds.

However, conventional individual disposal systems, such as latrines and cesspits, also make poor alternatives - especially in view of increasing population densities and the substantial groundwater pollution they cause.

Against the background of ecological sustainability, though, the most important factor is that all conventional types of wastewater and sewage disposal systems usually deprive agriculture, and hence food production, of the valuable nutrients contained in human excrement and especially in urine. Indeed, in a water-borne sewage system, potable water is used to carry wastewater into the freshwater cycle, where it causes various further environmental problems. Furthermore, in addition to the organic burden and the nutrient and pollutant load, new substance groups such as e.g. hormones and medicament residues have been coming under scrutiny.

Consequently the current core problems in the field of water supply and sanitation can be summarised as follows:

- The discharge of organic and inorganic nutrients and pollutants leads to pollution and eutrophication of water bodies.
- The already existing shortage of useful water reserves is being dramatically aggravated by the permanent soiling of our ground-water and surface-water bodies.
- The discharge of hormones and medicament residues (e.g. antibiotics) contaminates bodies of water, flora and fauna with new substance groups that also have a negative effect on the provision of drinking water.
- Valuable drinking water is misused and squandered as a carrier in water-borne sewage systems.
- Potable water can only be provided with increasing technical and financial inputs.
- Germs are hardly retained or broken down in conventional sewage treatment plants, so that the bodies of water are hygienically polluted by discharge of treated wastewater too.
- The valuable nutrients contained in human excrement and in wastewater are "eliminated" with high technical and energy inputs in conventional sewage treatment plants. In other words they are actually destroyed or discharged unproductively into the water bodies.
- The substantial energy content of the organic carbon compounds contained above all in faeces is hardly used at all either, not even in state-of-the-art sewage treatment plants. In most cases this energy is simply lost completely.
- On the other hand, in order to assure our food production artificial fertilisers are produced with a high-energy input using non-renewable fossil sources. These artificial fertilisers a) do not represent an alternative for developing countries on financial grounds alone, if for no other reason, b) they cause additional damage to the soil, and c) they also contaminate water bodies.

### **Our understanding of the term "ecosan"**

As we have learned during the preparation of this symposium, a number of different definitions and concepts of the term "ecosan" appear to exist. These range from near-natural wastewater treatment processes to compost latrines, from dehydrating latrines with urine separation to complex, mainly decentralised systems, aimed not only at closing the nutrient cycles and

rendering them safe, but also at closing local water cycles and minimising the outlay of resources, perhaps even of producing energy.-

In our understanding, the term "ecosan" represents a vision of sustainable sanitation systems which are based on a systematic material-flow-oriented recycling process that constitutes promising, up-to-date, holistic alternatives to conventional solutions. Ideally, ecological sanitation systems permit the complete recovery of all nutrients from faeces, urine and greywater, benefiting agriculture and minimising water pollution, as well as allowing economical use of water and its maximal reuse, particularly for purposes of irrigation.

An even broader understanding of the term could also include the use, storage and seepage of rainwater, treatment and recycling of solid organic wastes, minimising the energy input for waste disposal and utilising the energy content of solid and liquid wastes.

These effects can be achieved by various means – spanning the full range from strictly low-tech solutions (e.g. the arborloo in rural areas) to expressly high-tech solutions (e.g. using separation latrines, vacuum transport systems and anaerobic or membrane treatment technology).

As we see it, every approach that ultimately leads to closing the loops and to reuse of nutrients, water and energy should fall under the term "ecosan". Even if these chiefly comprise semi-centralised or non-centralised sanitation systems, ecosan approaches e.g. in urban conurbations can therefore be represented by a combination of centralised sewerage systems and downstream sewage treatment plants. However, the treatment technology would then have to be oriented to rendering the effluent hygienically safe instead of to eliminating the nutrients, and the hygienically safe wastewater would then have to be used for agricultural irrigation.

In addition to technical systems, ecosan-strategies should include interdisciplinary approaches to the integration of strategies for raising public awareness, marketing the recovered nutrients, applying them safely in agriculture, and establishing a service business for building and operating the installations. Holistic strategies for wastewater management and sanitation comprise direct linking with neighbouring subjects: agriculture (especially urban farming) and food security, health care, urban planning, as well as waste management in general and the economy are indispensable parts of closed loops.

Altogether we want to attain a new basic understanding of wastewater handling, in which faeces and urine are considered not as pollutants, but instead as useful resources. We must manage to integrate all affected parties in this development, from the users to the political and administrative level, and to create an atmosphere of socio-cultural acceptance.

This is an ambitious target.

We need to carry out a great deal of research, testing, optimising and evaluation to find out how the loops can be closed sustainably.

### **What can we expect of this symposium, and what should we not expect?**

I think that the development of an ecological sanitation system is an essential need that connects solutions of our qualitative and quantitative water supply problems with urgently required reorientation towards sustainable and resource-conserving agriculture. It thus represents a vital module for poverty reduction and food security for future generations.

At the present time we are all still largely at the stage of visionary thinking, planning and experimenting. So far we only have a few isolated finished and tested solutions, and these generally only on a small, pilot scale, focused chiefly on rural areas.



At this symposium, therefore, we are not yet able to offer you any ready-to-use, bankable ecosan-solutions for all needs.

That is why the two main intentions of this symposium are:

1. to press ahead together with the development of practicable, operationally reliable and cost-effective large-scale approaches for both rural and urban areas by exchanging the experience you all have in a variety of forms, and
2. to educate and persuade, not least in order to create a politically favourable atmosphere for implementing such approaches.

We intend to offer and also to gather a lot of information and an overview structured according to the headlines of our two symposium days:

1. The **state of affairs** in the field of ecosan:

What ongoing local and international initiatives, research programmes, projects and tendencies exist?

We have learned that it is impossible for us to offer a forum for all well-known or not so well known interesting commitments – not even for nearly all of them. Since it is not possible to pick up lecturers as if they were stacked in a public library, we shall not be able to avoid certain aspects staying in the background a little more than others either. Nevertheless, we expect a broad cross-section - today in the plenary session and in general, as well as in the thematically accentuated parallel sessions tomorrow.

2. **The short and long-term need for action** in order to develop, strengthen and disseminate ecosan solutions.

How shall we accentuate our future work and what inputs for global progress of holistic wastewater management should it or can it bring?

We hope for **impulses for our practical work** after we have all passed through these doors tomorrow afternoon:

- impulses for the development and transformation of promising information, ideas and contacts in practical, fruitful work
- and impulses for strengthening the joint political and technical power mentioned before to push through alternatives

### What is to be done after this event?

We see this event as the prelude to the supra-regional research project scheduled to go on for several years, as mentioned before. However, since we shall all be engaged for a long time with the topic of reorienting sanitation along the lines of sustainable strategies, we only view it as a link in the chain of persistent and necessary dialogue and as one point of intersection in a growing network.

So finally I hope,

1. that I have been able to explain our assessment of the serious problem situation facing us globally in the field of water supply and sanitation,

2. that I have been able to clarify our definition of ecosan approaches as a vision of economically and ecologically sustainable water and sanitation systems that lead to closed loops by using a wide variety of centralised or decentralised technologies,
3. that it is clear that although we are pursuing far-reaching visions with ecosan, we still need to invest a great deal of work in development for universal application of appropriate, practicable solutions, as well as in marketing and acceptance. And that this symposium is therefore primarily a presentation and discussion forum to support this development work.
4. that I have stimulated you to continue working with us in our research project and with all the others you have met or will meet here, even after this symposium, as a global ecosan-network. We hope for cooperation across any borders of a geographical, professional or administrative kind with you personally, with the organisations you represent, with the parties concerned and the responsible persons and bodies in order to identify any areas of overlap and duplication in our work – not only in times of limited financial means – to complement each others' activities where possible and to benefit mutually from this.

**For only by these means can we advance along the path to holistic solutions – by holistic proceedings.**

Thank you.

## Towards a recycling society ecological sanitation - closing the loop to food security

Dr. Steven A. Esrey

UNICEF  
3 UN Plaza, New York, N.Y. 10017, USA

### Introduction

One of the most potent forces in the world today is urbanisation. Some of the seemingly disconnected problems associated with urbanisation - water scarcity, food insecurity and pollution - are really the manifestation of several underlying assumptions and actions. One assumption is that there are no limits to resources such as water and land. Another is that the environment can assimilate the wastes that we produce from using these resources. These assumptions lead to linear flows of resources and wastes that are not reconnected. It used to be that people grew food and recycled their wastes close to where they lived. We have opened up that cycle, and the technological developments based on these assumptions are no longer applicable. In fact, the technological developments have become part of the problem, not the solution.

In 1992 at the time of the Rio Summit, 75% of the natural resources harvested and mined from the Earth were shipped, trucked, railroaded and flown to 2.5 percent of the earth's surface, metropolitan areas. Eighty percent of the natural resources are converted into waste, which are disposed of.<sup>1</sup> When water is used as a transport medium and a sink to dispose of these wastes, including excreta, it is virtually impossible to prevent toxicants, heavy metals, and other contaminants from getting into rivers, ground water, lakes and coastal bodies even with state-of-the-art sewage treatment. In the process huge amounts of fresh water, up to 50,000 litres per person per year, are contaminated and deemed unfit for other purposes.<sup>2</sup> And more than 90% of sewage in developing countries is discharged without any treatment.<sup>3</sup>

The belief that resources can be ultimately wasted, or disposed of, makes a recycling society impossible. Today, there is a massive flow of nutrients, in the form of food, from rural areas to cities, and these nutrients, in the form of excreta, are disposed of into deep pits or lakes, rivers and coastal waters. This has several major consequences, one of which being nutrients and organic matter in excreta are toxic to different life forms living in water (e.g., some fish and coral reefs). Fish can become contaminated and infect people. Fish stocks, a major source of protein and livelihood for people, are in decline in part from sewage pollution. Biodiversity, the different forms of life that supply all our needs, is also reduced, threatening human well-being. In addition, the linear flow of nutrients from rural areas to urban waste sinks results in soil infertility, necessitating the addition of chemical fertilisers and pesticides.

The urbanisation of rural counties and regions results in the paving over of farmland. Water runoff and storm sewers do not allow ground water to recharge, and fresh water has to be extracted at great cost from farther and farther away. Food also has to be produced farther and farther away from where people live, often on less fertile land. The cost of piping water and

---

#### References

- <sup>1</sup> Smit J. Urban agriculture and biodiversity, *Urban Agriculture Magazine*, 2000; 1(1): 11-12.
- <sup>2</sup> Esrey SA et al. *Ecological Sanitation*, Sida, Stockholm, 1998.
- <sup>3</sup> Briscoe J and Steer A. New approaches to structural learning. *Ambio*1993; 22(77):456.

transporting food into urban and peri-urban areas increases, and its quality may deteriorate along the way.

By 2015, about 26 cities in the world are expected to have a population of 10 million people or more (Figure 1). To feed a city of this size today, at least 6,000 tonnes of food must be imported each day.<sup>4</sup> Every day, 20,000 tonnes of food are transported to New York City, and half of it, in the form of organic matter and sewage are hauled away. The rest is converted in energy, carbon dioxide and heat.<sup>5</sup> In 1988, about 25% of the developing world's absolute poor were living in urban areas. Today, 56% of the absolute poor live in urban areas. The world's urban poor spend much of their income on food, in many cases more than 50% of their income. They will not be able to afford imported food - food from other countries or food grown far away in their own countries. Dietary intakes are therefore subject to fewer nutrients. A recent review of differences in urban and rural dietary intakes indicates that on average, energy intake of urban residents is around 200 kcal less than for rural residents.<sup>6</sup> There is a need to produce food closer to where people live.

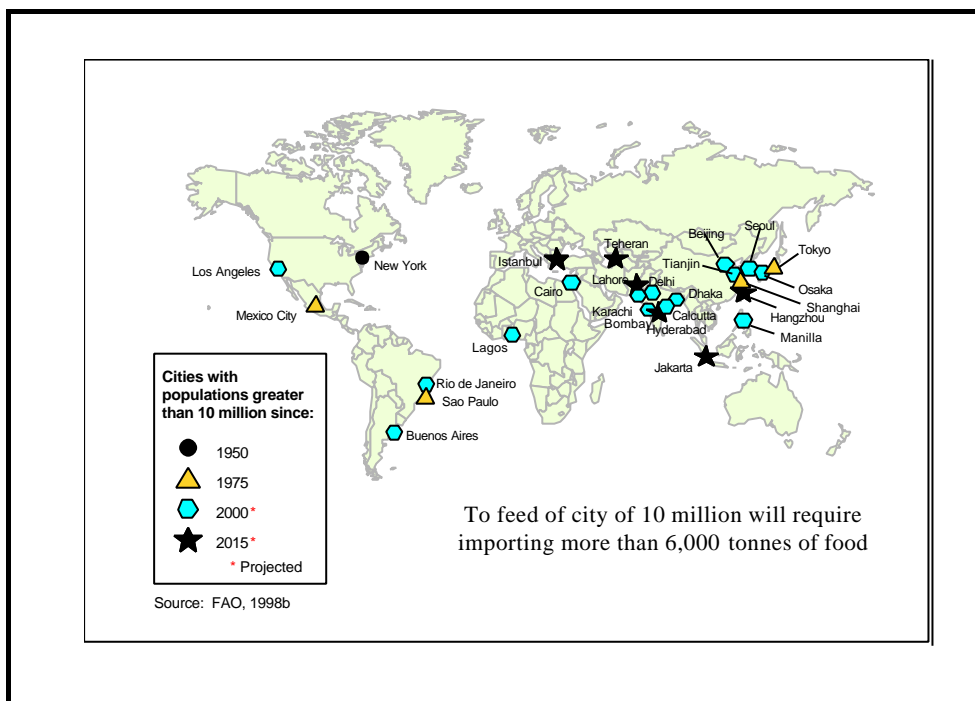

**Figure 1: There is need for urban agriculture**

These problems will only get worse as long we continue to design solutions based on false premises. If we change our linear attitudes of resources and wastes, towards a circular one, we can reconnect these resources and wastes, reduce our problems and advance towards a recycling society. Sanitation can be a technology that connects the two. Unfortunately, half of humanity does not have access to any type of sanitation. This is, of course, a fundamental denial of human dignity, and it is a main cause of death from infectious disease in two to three million children every year. The rest of humanity relies on conventional approaches to sanitation, which fall into one of two categories: waterborne systems or pit latrines. The design of “flush and discharge” and “drop and store” technologies was based on the premises that

<sup>4</sup> FAO-SOFA, The State of Food and Agriculture, FAO, Rome, 1998.

<sup>5</sup> Nelson T. Closing the nutrient loop, World Watch, November/December, 1996.

<sup>6</sup> Van Braun J, McComb J, Fred-Mensah BK, Pandya-Lorch R., Urban food insecurity and malnutrition in developing countries: trends, policies, and research implications, IFPRI, Washington, DC, 1993.

excreta is a waste and the waste is suitable only for disposal. It also assumed that the environment could assimilate the waste. These premises are no longer true. Either way, resources that are converted to wastes are not reconverted back into resources, failing to complete the nutrient loop.

The problems we have today cannot be solved with the same kind of thinking that created them. Business as usual approaches to sanitation, by either failing to provide any service or providing conventional services, represent a failure in the design of sanitation. A new approach is needed. The logical response to our current dilemma is to design systems and processes so they do not create waste in the first place. Waste does not exist in nature, only in our minds. All waste is a food for another living organism. Therefore, we should not argue about where to put our wastes, who will pay to dispose of it, and how long we can wait until it leaks into the environment. We should design systems that imitate healthy ecosystems found in nature. We need innovative solutions to today's problems, technical solutions that protect ecosystems and harmonise with natural systems. We need a different way of thinking about these problems, and we must challenge the assumptions that led to conventional solutions that we use today.

### Ecological sanitation - an ecosystem approach

The new approach is called Ecological Sanitation. It represents a shift in the way people think about and act upon human excreta. Ecological sanitation is a system that is intelligently designed and constructed to mimic nature at every step. The new paradigm is an ecosystem approach (Figure 2), a move away from a linear to a circular flow of nutrients - towards a recycling society. Nutrients and organic matter in human excreta are considered a resource, food for a healthy ecology of beneficial soil organisms that eventually produce food or other benefits for people. The new approach recognises the need and benefit of protecting environmental health and promoting human well-being, recovering and recycling nutrients, and conserving and protecting natural resources. It represents a closed-loop approach to nutrients and water problems. Its defining features - it's safe, it's green and it's valuable - are a major shift from conventional sanitary solutions.

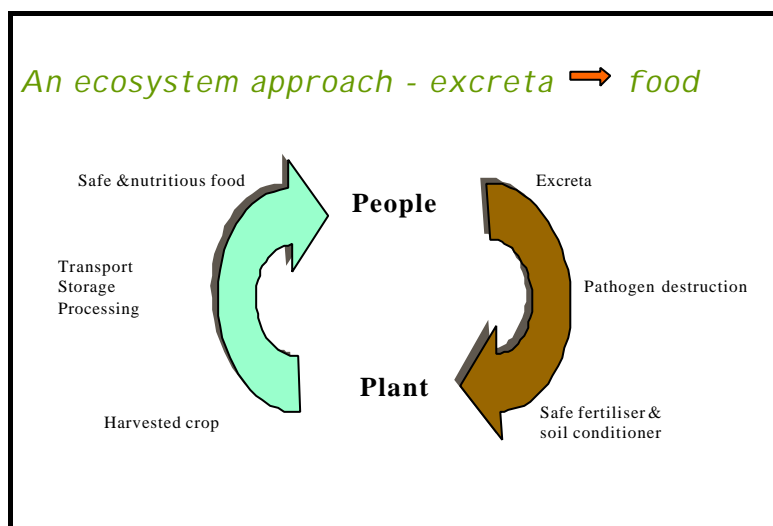

**Figure 2: Ecological sanitation is safe, green and valuable**

Ecological sanitation is safe. Excreta are treated and processed on site, and if so required off site, until completely free from pathogens and inoffensive. Excreta, especially faeces, may be

processed a second time by composting or dehydration. Key factors that accelerate pathogen destruction are increasing pH, elevated temperatures and desiccation. All are non-toxic means to disinfect excreta. Thus, ecological sanitation prevents transmission of infectious disease agents reducing the burden of disease. Pathogens that gain access to water bodies through conventional approaches pose a long-term threat to human health. Pathogens have been shown to survive in water much longer than on land,<sup>7</sup> and pathogens may survive in marine environments for years.<sup>8</sup> Because ecological sanitation is not polluting, it contributes toward the protection of human health by providing a healthy environment. Human excreta also contain very low levels of heavy metals. For example, in Sweden urine contained less than 3.2 mg cadmium per kg of phosphorous compared to 26 mg Cd/kg P in commercial fertilisers and 55 mg Cd/kg P in sludge.<sup>9</sup> Conventional solutions install barriers to keep excreta, laden with pathogens, away from people, and treatment is an after thought as best. Sewerage also serves as a conduit for concentrating industrial contaminants, such as heavy metals.

Ecological sanitation is also green. Ecological sanitation is not merely about a new latrine design. It is a new way of thinking: a “closed-loop-approach” to sanitation, in which excreta are returned to the soil instead of water. Thus, the closed-loop approach is non-polluting, keeping fresh and marine water bodies free of pathogens and nutrients. It is a zero-discharge approach. Drinking water is preserved for drinking, rather than flushing. The environmental and human health risks are minimised or eliminated.<sup>10</sup> Fish populations, coral reefs, and biodiversity are protected. Nitrogen pollution, with adverse human health effects, is reduced. This includes nitrogen from excreta as well as nitrogen from commercial fertiliser runoff. Conventional sanitation solutions assume the environment can handle the waste, but they shift the burden to downstream communities.

Ecological sanitation is valuable for a number of reasons. In addition to the obvious economic value of excreta to sell it or to use it for food production, there are other secondary benefits. When excreta are processed and returned to soil as organic matter, soil structure and water-holding capacity is improved and fertility is restored. Valuable nutrients contained in excreta, mostly in urine, are returned to the soil for healthy plant growth. Ecological sanitation is also a decentralised operation, at the household or community level as opposed to a centrally operated system. It has also been demonstrated that local entrepreneurs can design and build ecological toilets as well as train people on the use of the toilet and value of the end product. Recycling nutrients and home gardening are often the domain of women, who may now have an additional income or increased control over food access, increasing gender equity and food security. Thus, ecological sanitation is individual and community empowering, income generating, and when the resources are used to produce food it diversifies the diet and improves nutritional status.

There are two basic design features of ecological sanitation. One is urine-diversion, in which urine and faeces are never mixed; they are kept separate at all times. The toilet has a dividing wall, in which the urine exits from the front of the toilet, and faeces drop below the toilet from the back of the bowl. Another is more commonly known as composting, in which urine and faeces are combined, and the product is composted. In each case it is possible to manage urine, faeces or excreta with little or no water, and it is also possible to keep the end product out of ground and surface waters.

<sup>7</sup> See Reimers RS et al on survivability of *Ascaris* under differing condition in wastewater: Parasites in southern sludges and disinfection by standard sludge treatment (EPA-600/S2-81-166, Oct 1981), Investigations of parasites in sludges and disinfection techniques (EPA-600/S1-85/022, Jan 1986), and Persistence of pathogens in lagoon-stored sludge (EPA/600/S2-89/015, Jan 1990).

<sup>8</sup> Ezzell C. It came from the deep, *Scientific American*, June 1999, page 22-23.

<sup>9</sup> Jönsson H, Stenström T-A, Sundin A, Source separated urine, nutrient and heavy metal content, water saving and faecal contamination, *Wat. Sci. Tech.* 1997; 35(9):145-152.

<sup>10</sup> Esrey SA. Rethinking Sanitation: Panacea or Pandora's Box, In *Water, Sanitation and Health*, Edited by Chorus I, Ringelband U, Schlag G, and Schmoll O., IWA, London, 2000.

## Resource value of human excreta

Human excreta are comprised of two basic components, urine and faeces. When urine and faeces are kept apart, they have different properties, are produced in different quantities, and require different care in processing. Published figures indicate that more than 1 kg of urine is produced daily, while less than 150 g of faeces, including moisture, is produced daily.<sup>11</sup> These figures, of course, vary by type of diet, location, age, activity and health status.

Urine contains nearly 80% of the total nitrogen found in excreta (Table 1). Urine also contains two-thirds of the excreted phosphorous and potassium. The majority of the carbon excreted, up to 70%, is found in faeces. The quantities shown above may suggest that excreta contain few nutrients. Each person urinates annually about 4 kg of nitrogen, 0.4 kg of phosphorous, and nearly 1 kg of potassium; total excretion is 4.5 kg of nitrogen, more than a half kg of phosphorous, and 1.2 kg of potassium. In an urban setting of 10 million people, this equates to 45 million kg of nitrogen, nearly 6 million kg of phosphorous, and more than 12 million kg of potassium. It also represents 10 million litres of nutrient rich and mostly sterile water that is excreted. The water that is not flushed by 10 million people equates to 0.15 km<sup>3</sup> of water saved by using ecological sanitation, fresh water that could be used for other purposes, such as food production, without risk of infection. Other elements, such as calcium and magnesium, are excreted in nearly equal amounts in urine and faeces. There are many other nutrients found in human excreta, but they are not shown above. Although using only urine is valuable, both urine and faeces should be recovered and recycled to avoid long term depletion of soils.

**Table 1: Select components found daily in human excreta per person<sup>12</sup>**

Elements (g/ppd)	Urine	Faeces	Urine + faeces
Nitrogen	11.0	1.5	12.5
Phosphorous	1.0	0.5	1.5
Potassium	2.5	1.0	3.5
Organic carbon	6.6	21.4	30
Wet weight	1,200	70-140	1,200-1,400
Dry weight	60	35	95

Globally, 2 billion hectares have been degraded since World War II, 23% of globally used land.<sup>13</sup> If only agriculture land is considered, 38% is degraded. Most of the degradation had occurred in Asia, Africa and South and Central America. The two main causes of degradation are loss of topsoil from water erosion and fertility decline. In Africa alone, 8 million tons of nutrients are lost every year, representing US\$ 1.5 billion per year.<sup>14</sup> Annual depletion of NPK (N+P<sub>2</sub>O<sub>5</sub>+K<sub>2</sub>O) per hectare from African soils varies from less than 30 kg/hectare to more than 60 kg/hectare. The excreta from 10 people during the course of a year could return more than

<sup>11</sup> Del Porto D, Steinfeld C. The Composting Toilet System Book, Center for Ecological Pollution Prevention, Concord, Mass., 1999; Jönsson, H. Assessment of sanitation systems and reuse of urine, In Drangert J-O, Bew J, and Winblad W, Ecological Alternatives in Sanitation, Proceedings from Sida Sanitation Workshop, Balingsholm, Sweden, 1997.

<sup>12</sup> See Del Porto D, Steinfeld C, 1999. The Composting Toilet System Book, Center for Ecological Pollution Prevention, Concord, Mass.; Drangert J-O, Bew J, Winblad U, 1997. Ecological sanitation: Proceedings from Sida Sanitation Workshop, Balingsholm, Sweden.

<sup>13</sup> Scherr S.J. Soil Degradation: A threat to developing-country food security by 2020?, Food, Agriculture and the Environment, Discussion Paper #27, International Food Policy and Research Institute, Washington DC, 1999.

<sup>14</sup> Henao J & Baanante C. Nutrient depletion in the agriculture soils of Africa, 2020 Vision Brief 62, International Food Policy and Research Institute, Washington DC, 1999.

60 kg/hectare to soil, restoring fertility. The effects of soil degradation and loss of fertility on food consumption, agriculture income and national wealth are significant.

Failure to restore soil fertility over the last several decades has been speculated as a cause of reduced nutrient content of North American and British foods. A recent sampling of foods showed 20-40% less calcium, iron, and Vitamins A and C than was the case several decades ago.<sup>15</sup> Exactly why this is occurring is not known, but modern agricultural methods do return all nutrients it takes from the land. Conventional agricultural practices consider soil a way station for nutrient uptake by plants, not a viable living organism where plants grow and thrive. Recycling a whole range of nutrients, as well as organic carbon, to the land is needed for a healthy, balanced soil.

### **Ecological sanitation, urban agriculture and nutrition security**

As urbanisation continues and the number of urban poor exceeds the rural poor, the need for urban agriculture is greater now than ever before. Food production and costs can be reduced by lowering the costs of inputs and producing food closer to where people live. Urban agriculture and home gardening can produce more food per unit space, because food can be grown on roofs, walls and in and around buildings. This in turn improves food security, and when food and non-food products are grown to generate income, food security and nutritional status can also improve. It is well known that women, who dominate the sphere of urban farming and gardening, are more likely to spend their extra income on food than men. Increasing national food availability will help to reduce child malnutrition.

Urban agriculture, the growing of food and non-food plants, trees and livestock in urban and peri-urban areas, was largely abandoned last century, but it is enjoying a revival in the past few decades.<sup>16</sup> In Moscow, for example, urban agricultural activity increased three-fold between 1970 and 1990. In Dar es Salaam it nearly quadrupled from 1968 to 1988, and in Romania it more than tripled (up 333%) from 1990 to 1996. In Argentina home gardening association members grew from 50,000 in 1990 to 550,000 in 1994. In metropolitan areas in the United States, food production increased from 30% in 1988 to 40% in 1996, and from 1994-1996 the number of farmer's markets selling locally-grown produce increased 40%. In great Bangkok 60% of the land is under cultivation. Urban agriculture facilitates the closing of the loop to food security. The demand for food by consumers and water and nutrients by producers reconnects resources and wastes in a safe, non-polluting and economic fashion.

By closing nutrient loops and improving soil fertility and structure, yields will be higher per unit space, plants will be healthier and more nutritious, and lower levels of external inputs and less water will be required. Growing food closer to consumers also strengthens local communities.

### **Impact of ecological sanitation on urban development and planning**

Urban planning and development requires the provision of water and sanitation services, access to food, health care, and healthy environments among other services. The advantages of ecological sanitation on urban development and planning are many and of enormous value. This section reviews the potential advantages of ecological sanitation compared to conventional sanitation. The major issues are divided into five categories: financial, ecological, governance, urban agriculture, and health and nutrition. Such a strict categorisation of issues is rather

<sup>15</sup> Mayer A-M, British Food Journal, 1997; 99 (6):207-11 and [www.organicgardening.com/watchdog/nutrientsdecline.html](http://www.organicgardening.com/watchdog/nutrientsdecline.html).

<sup>16</sup> Smit J. Urban Agriculture: Food Jobs and Sustainable Cities, UNDP, New York, 1996.



artificial, because a benefit in one category has spin-off benefits in other categories, just as a disadvantage in one creates problems elsewhere in the system.

Achieving ecological sanitation solutions does require a change in how people think about and act upon human excreta. In some societies human excreta are considered a valuable resource, and the handling of excreta poses no problem. In fact, urine has been used as a resource in many parts of the world for centuries.<sup>17</sup> It was used in Europe for household cleaning, softening wool, hardening steel, tanning leather and dyeing clothes. The Greeks and Romans used it to colour their hair, and African farmers use it for fermenting plants to produce dyes. The Chinese pharmaceutical industry uses it to make blood coagulants. In other societies excreta, and in some cases particularly faeces, have been considered dirty for centuries. Experience shows, however, that urine diversion is acceptable, and the handling of urine poses far fewer taboos than does faeces. Many people do not know that faeces can be processed and converted into humus, with all the typical characteristics: pleasant-smelling, easy to handle as soil, and innocuous.

#### Financial:

Conventional sanitation, particularly water-borne solutions, requires large infrastructure investments. Globally, water and sanitation investments, ignoring operation and maintenance costs, require \$30 billion annually. By the year 2025, it could be \$75 billion annually.<sup>18</sup> Much of this cost is to lay pipes and sewers to transport and dispose of waste and contaminated water. Conventional toilets in modern societies flush away up to 15,000 litres of pure water every year for every person, only to dispose of 500 litres of urine and 50 litres of faeces. With ecological sanitation the need for sewers to transport large volumes of polluted water is greatly reduced. Wastewater consisting of only urine and grey water would be recycled locally using less costly decentralised systems. Ecological toilets in developing countries range from \$10 per family in China to the cost of modern toilets, including child friendly seats, in Sweden. Thus, these systems are adaptable to local budgets, and can be upgraded over time as income and demand rise. In addition, most sewage treatment plants, if operated effectively and efficiently, require large amounts of electricity. Three percent of the electrical consumption in the United States goes to sewage treatment plants.<sup>19</sup> Recycled nutrients and organic matter from excreta also reduces the need for commercial fertilisers, a great expense for small farmers and gardeners, and if these resources are used in urban settings, where they originate, it also reduces the cost of transporting food to cities.

#### Ecological:

Ecological sanitation requires far less water to operate, and it does not dispose of human excreta into water bodies. Because less water is needed to flush toilets, less water is needed to serve households, up to 60,000 litres for a family of four. This represents a huge ecological and financial saving in water withdrawals for households. On the other hand, nearly all sewage in developing countries is discharged into receiving bodies of water with no treatment.<sup>20</sup> In addition to the spread of human excreta into the environment, industrial pollutants are spread as well when industrial wastes are connected to household sewer systems, as is commonly done. Pit latrines can also leach nutrients and pathogens into ground water and disperse into the

<sup>17</sup> Reed B, Shaw R. Using human waste, Technical brief no. 63. The WELL Center, London, No date.

<sup>18</sup> Cosgrove WJ, Rijsberman FR. World water vision: making water everybody's business. Earthscan, London, 2000.

<sup>19</sup> Engen T. The Urban Century: The Water Crisis, In: Urban Stability Through Integrated Water-Related Management, Proceedings of the 9<sup>th</sup> Stockholm Water Symposium, Stockholm International Water Institute, Stockholm, Sweden.

<sup>20</sup> UNCSD, Comprehensive assessment of fresh water resources of the world. Economic and Social Council, fifth session, 5-25 April. E/CN.17/1997/9, New York, USA. 1998.

environment during floods.<sup>21</sup> In either case water environments are contaminated, spreading pathogens and other toxicants to those downstream. Wastewater and sludge, if returned to irrigate crops, are notorious for spreading pathogens and increasing the risk for infectious diseases to workers and consumers, which overburdens existing stretched health care systems. Nutrients in water lead to other environmental, and ultimately, financial problems. Fish stocks decline and die-off, reducing a source of income and high quality food. Coral reefs die, reducing coastal wave barriers that eventually lead to coastal damage. In addition, tourism dollars are reduced as these localities become less desirable as holiday spots.

#### Governance:

Ecological sanitation can be introduced and operated as decentralised systems. These systems can be built and maintained at the household and community levels. Primary treatment of pathogens can occur within the toilet unit, and secondary processing can occur within the community if necessary. If the resources of the toilet are recycled locally, there can also be decentralisation of food production. If the household or local community cannot use the contents that these toilets provide, they can be packaged and sold to farmers, gardeners, or others in need of fertilisers or compost. This increases employment opportunities at the local level, while keeping the environment clean and green. Current sanitation systems often need to subsidise investment costs with little hope of recovering those returns, in part because the valuable excreta is disposed and its resource value is lost. In addition to employment generation to manage the output of the toilets, local entrepreneurs have demonstrated that the production and sale of ecological toilets is possible, and training of users is both viable and possible from a behavioural perspective. Building pit latrines in cities can be a risky business, as often scarcity of land, inappropriateness of soils and lack of privacy are difficult to overcome. Ecological toilets, particularly urine diversion toilets, can be built into the home, reducing building costs for additional outside walls.

#### Urban agriculture & horticulture:

Ecological sanitation is based on a closed-loop flow of nutrients. Nutrients in the form of excreta are recycled. Conventional sanitation solutions force nutrient and water loops to open, creating the need to bring nutrients and other inputs for agricultural and horticulture from farther away. If they are available and used locally, where people live, they become easily accessible at lower cost than other forms of commercial fertiliser. Recovery and recycling of nutrients from human excreta and other organic matter provide a complete nutrition for plants. Access to affordable and more nutritious food increases food security. In addition, post-harvest food losses can be reduced if food is grown and consumed locally. This also represents a saving in water as well as nutrients.

#### Health and nutrition:

Historically, improvements in sanitation from conventional technologies have resulted in less disease for the users of these technologies, but not necessarily for those downstream. The conventional solutions keep pathogens away from the people who use them. Because there is a daily stream of pathogens being discharged, barriers must be continuous without failure or breakdowns. This has been demonstrated to be virtually impossible, particularly in developing country contexts when those living downstream are exposed to pathogens and other contaminants, and their health is threatened. Ecological sanitation differs from conventional

<sup>21</sup> Falkenmark M, et al. Water: A reflection of land use, Swedish Natural Science Research Council, Stockholm, 1999.

solutions in that the pathogens are treated at the site of excretion, and processed further if necessary, in addition to creating barriers. This represents a critical design feature. Thus, ecological sanitation has the potential to reduce disease transmission, infections in people, and improve well-being, particularly of vulnerable groups. This allows better appetite and utilisation of food that is consumed, creating a healthier society. Of course, inappropriately designed ecological toilets or behaviours that extract the nutrients when still laden with pathogens could spread disease. Therefore, it is important to get it right from the start. When food is grown further away from where people live, it not only costs more, but perishables, which often contain valuable micronutrients, are less likely to reach consumers, particularly people with little income. Urban farming and home gardening, though, can result in better diets, improving macro- and micro-nutrient intakes as well as improved nutritional status of vulnerable groups, such as women, children, the elderly and disabled.<sup>22</sup>

A review of child malnutrition identified four underlying determinants of growth failure: national food availability (23%), healthy environments (20%), women's education (43%) and women's status (11%).<sup>23</sup> Ecological sanitation impacts favourably on each of these determinants by providing healthier environments and reducing disease, making food more accessible and affordable, empowering women and providing them with disposable resources, and keeping girls in school and better equipped to learn.

The discussion above is summarised below (Table 2). Many advantages to society may accrue with adoption of wide-scale Ecological Sanitation technologies. There are financial benefits, including employment creation and income generation, as well as less expenditures for paying for environmental damage. Ecological benefits accrue as nutrients and water loops are closed. Decentralised toilet systems can foster urban agriculture activity, improving health and nutrition and empowering people.

**Table 2: Comparison of Ecological and Conventional Sanitation in Relation to Urban Planning**

<b>Ecological sanitation</b>	<b>Comparison feature</b>	<b>Conventional sanitation</b>
Adapted to community budgets Recurrent costs recovered faster Less need for commercial fertilisers	Financial	Large infrastructure investments Large operation & maintenance costs Large transportation & energy costs
Protects environments Conserves water Supports biodiversity	Ecological	Pollution of ground & surface waters Loss of biodiversity Unhealthy environments
Decentralised systems Employment generation Promotion of gender equity	Governance	Centralised systems Subsidies to rich Depends on institutional capacity

<sup>22</sup> Maxwell D, Levin C, Csete J. Does urban agriculture help prevent malnutrition: evidence from Kampala. Food Consumption and Nutrition Division (Paper no. 45) of the International Food Policy and Research Institute, Washington, DC, 1998.

<sup>23</sup> Smith LC & Haddad L. Explaining child malnutrition in developing countries: a cross-country analysis, Research Report 111, International Food Policy Research Institute, Washington, DC, 2000.

Ecological sanitation	Comparison feature	Conventional sanitation
Close-loops/circular flows Easier access to nutrients Healthier soil and plants	Urban agriculture	Open-loops/linear flows Reliance on expensive fertilisers Need for pesticides and herbicides
Less disease transmission Increased food security More nutritious diets	Health and nutrition	Potentially disease transmitting Higher costs for food Less consumption of perishables

### Closing the Loop - examples from around the world

#### Mexico and Central America:

In Mexico City, experimentation with fermented urine to grow food has shown that leafy vegetables do very well.<sup>24</sup> This includes lettuce, cilantro, parsley, celery, fennel, scented herbs, prickly pear, and chile piquin. Average results were obtained for cauliflower, broccoli, cabbage and root produce (turnips, carrots, beets and onions). Fruiting plants, such as tomatoes, squash, cucumber, peppers and eggplants have not done as well with fermented urine as with other fertilisers. This may be due in part to the continual use of nitrogen, in the form of fermented urine, during the fruiting process. When the subsoil is enriched with worm compost, the results for fruiting plants improve dramatically. In the case of tomatoes, produce is increased from 3 to 5 kg per plant when the compost is enriched with the phosphorous and potassium compounds from worm composting.

Recently, university investigators<sup>25</sup> in Cuernavaca, Mexico have been experimenting with human urine as a source of nitrogen in organic vegetable production. The experiments have compared human urine versus a control on the production of chard, celery and beets. Although the testing is not complete, the results indicate better yields in the urine-fertilised vegetables compared to the control, and no diseases or pests have been found.

Ecological sanitation is also in place in El Salvador and Guatemala with thousands of units. In El Salvador, there is less interest at this time for recycling human excreta, partly because of lack of perceived space to grow food, but inhabitants in Hermosa Provincia have moved urine-diverting toilets into their homes after realising that there are no smells or flies.

#### China and Asia

In Guangxi, in China, urine diversion is also gaining momentum.<sup>26</sup> Rooftop gardening uses only urine to grow vegetables, such as tomatoes, cabbages, beans and pumpkins. Faeces are carted to the fields. Urine and faeces are used in fields to grow corn, rice and bamboo. Of course, in China farmers have commonly used night soil, often untreated, to grow food. It has been recognised for centuries as a valuable fertiliser. Recently, urine diversion has begun to be

<sup>24</sup> Personal communication, Francisco Arroyo, 2000.

<sup>25</sup> Salgado, MT et al. Human urine as a source of nitrogen in organic vegetable production in Cuernavaca, Morelos, México, Abstract, 2000.

<sup>26</sup> Personal communication, Mi Hua, 2000.

accepted, and in the next year, more than 20,000 urine-diverting toilets will be built in the province, which includes both densely populated rural and urban areas.

In addition to China, Ecological Sanitation is being used in Vietnam, Philippines, and India in addition to Island communities in the Pacific and India oceans. In some of the Island communities, such as Fiji, toilet gardens in homes and schools have been installed.<sup>27</sup> These systems combine urine and faeces as well as grey water.

## Africa

In Zimbabwe, there has been much experimentation in the past few years with Ecological Sanitation.<sup>28</sup> It is now spreading to peri-urban areas, with various toilets designed for different purposes being tried. In addition to urine-diverting toilets, other ecologically sound toilet systems are also being used. The 'arborloo' is a system in which both urine and faeces are deposited in a shallow pit. When it is nearly full, it is topped off with soil and allowed to digest and decompose for several months. At that time, trees are planted in the topsoil. Preliminary experimentation has shown that fruit trees and trees raised for firewood grow well. Early experimentation with growing food is also positive with yields enhanced.

Other African countries, including Botswana, Ethiopia, Kenya, Mozambique, and South Africa, have been experimenting with Ecological Sanitation. In Botswana, a productive homestead has been demonstrated, which recycles human excreta to grow food on walls. In Ethiopia, ecological sanitation is also being experimented with in urban and rural areas, in which families grow trees, ornamentals and food.

Many of these initiatives have come about because of local problems - water shortages, pollution and the cost of commercial fertilisers. Today, support for Ecological Sanitation comes from many quarters: international agencies such as UNDP, UNICEF and the World Bank, donors such as Sida, GTZ and DFID, international NGOs such as CARE and Wateraid as well as local and national NGOs.

## Summary

Linear approaches to problems, in which resources are used and converted into wastes, only to be disposed of, represent a failure in human ingenuity and a flaw in technology design. If we are to create a recycling society, we need to capture the wastes, render them safe and return them to productive resources again. Ecological sanitation is a system that does just that. It is a system that imitates healthy ecosystems found in nature. It contributes to environmental health and human well-being by reducing disease transmission and disposal of wastes, by recovering and recycling water and nutrients for increasing food security. It is far more feasible financially and ecologically than conventional approaches to sanitation by reducing external inputs into a closed-loop system and by reducing the export of outputs and wastes from the system. It creates decentralised economies, empowering people, providing for local livelihoods, and enhancing community cohesion. If coverage can be increased, ecological sanitation can serve as the missing link to sustainable urban development, reverse the unconscious pattern of linear thinking and actions, and be a technical solution that protects ecosystems and harmonises with natural systems.

<sup>27</sup> Del Porto D, Steinfeld C. The Composting Toilet System Book, Center for Ecological Pollution Prevention, Concord, Mass., 1999.

<sup>28</sup> Morgan P, Ecological sanitation in Zimbabwe: a compilation of manuals and experiences, Harare, 1999.

## Slum networking – using slums to save cities

**Himanshu Parikh**

Himanshu Parikh Consulting Engineers  
2 Sukhshanti, near Ambawadi Circle, Ahmedabad 380 006,  
India

The concept of Slum Networking as developed by Himanshu Parikh, an engineer-planner, and demonstrated in Indore Habitat Project is a radical solution to the problems of urban slums.

It is taken for granted that in the cities of developing countries, environmental degradation, poor infrastructure and the mushrooming of slums are inevitable. *Slum Networking does not accept that the constraints, both physical and socio-economic, are insuperable. It is underpinned by a conviction that slums need not exist and this massive transformation can be achieved in a finite time frame.* This confidence is based on the success of Indore Habitat Project and on the subsequent evolution and replication of Slum Networking in the cities of Baroda, Ahmedabad, Mumbai.

Slum Networking is a community driven approach which sees slums, not as resource draining liabilities but, instead, as opportunities of change. In a holistic frame which converges scales, activities, agencies and resources it exploits the slum fabric in the context of the total city for sustainable and cost effective improvement in the quality of life of its people as a whole.

The objective of Slum Networking is not to find solutions unique to the slums, but instead, explore the commonality between the slums and the better parts of the city to integrate the two. There is a close correlation between the slum locations and the natural drainage paths of a city. This again helps to build up low cost service trunks, particularly for gravity based systems of sewerage and storm drainage, together with environmental improvements such as creation of fresh water bodies, cleaning up of polluted rivers, development of green pedestrian spines and restoration of waterfront structures. The slums naturally benefit from the improved city level support. For the city too, the slums offer opportunities of change through this symbiotic process.

As per the 1991 census, the population of Indore city was 1.25 million out of which slum dwellers accounted for 0.35 million. The slums in Indore were characterised by overcrowding, dilapidated housing, unhygienic conditions, grossly inadequate basic amenities, unplanned layouts and poor accessibility. These areas housed economically weaker sections of the community often engaged in casual service occupations.

In a project designed by Himanshu Parikh, executed by Indore Development Authority, and financed by Overseas Development Administration U.K., the Slum Networking concept has been demonstrated successfully in the city of Indore. Over a period of six years, the slum matrix of the city covering 450,000 persons has been upgraded with high quality environmental and sanitation improvement together with extensive community development programmes related to health, education and income generation. Many slums are now heading towards full literacy, frequency of epidemics has dramatically reduced and incomes, particularly of women, have increased. The costs of improvements in Indore slums are a fraction of the conventional methods and the benefits extend well beyond the slum fabric.

Most development alternatives designed for the urban poor rarely transcend beyond the slum boundaries. In contrast, as a byproduct of Slum Networking, Indore now has 90 kms. of piped sewer mains installed in the non-slum areas in a city which, until recently, had no underground sewerage to speak of. As a result, the polluted rivers of the city are being converted to fresh

water lakes in stages and associated with that, the historical riverside structures are restored and new pedestrian greens formed. Out of the 360 km. of roads provided in slums, about 80 km. on the slum peripheries were linked up at the city level to reduce the traffic congestion on the existing trunk roads. Similarly, the storm drainage runs in the slums were placed in such a manner that large areas of the remaining city were also relieved of flooding.

Slum Networking was awarded the 1993 UN World Habitat Award. In 1996, at UN HABITAT II in Istanbul and again in 1998 in Dubai, Slum Networking was chosen as a Global Best Practice by UNCHS. In 1998, it was awarded the Aga Khan Award for Architecture.

## Sanitation and sustainable water management in Germany

**Dr. Robert Holländer**

Federal Ministry for the Environment,  
Nature Conservation and Nuclear Safety  
P. O. Box 12 06 29, 53048 Bonn, Germany

### 1. Focus

The focus of the German Federal Ministry for the Environment, Nature Conservation and Nuclear Safety (BMU) is less on the issue of certain technologies and more on the issue of striving for environmental quality as a precondition for sustainability. Developing, establishing and implementing environmental concepts, environmental quality standards and environmental instruments are among the main tasks of the BMU. What has been achieved on the path to sustainable water management, what is still to be striven for and, in this context, what will be the requirements to be fulfilled by sanitation systems ?

### 2. Water and environmental protection

As a general provision, the German Federal Water Act § 1a determines that waters are to be managed in such a manner that avoidable impairments of their ecological functions are prevented, that contamination of the water or any other detrimental change in its properties is to be prevented and that the economical use of water should be aimed for which is imperative from a water balance perspective. To implement such rather general provisions, environmental quality standards are helpful. Different scientific approaches have been used to derive quality standards for substance concentrations in waters. The task of reaching a higher environmental quality standard for a national or international water body within a certain period of time is generally the result of a political agreement.

Of particular relevance for the environment, when discussing sanitation and sewage systems, are water quality targets for nutrients.

As a first step, in 1985 the 2nd International North Sea Conference agreed to reduce the phosphorus and nitrogen inputs in vulnerable areas by 50% by 1995. The Oslo-Paris Commission (OSPARCOM) aimed to implement this target. By 1995 the North Sea riparians (except France) had met the phosphorus target but nitrogen inputs were only reduced by about 20%. Therefore, the 4th International North Sea Conference extended the target for nitrogen and recommended increasing implementation efforts for municipal sewage plants and in the agricultural sector.

For the Baltic Sea, in the framework of HELCOM, it was agreed to reduce nutrient inputs by 50 % between 1987 and 1995. In the catchment area of the Baltic Sea, as was the case for the North Sea, the reduction target for phosphorus was met but the target for nitrogen was missed.

A closer look at a nutrient balance for Germany prepared in 1999 (UBA Texte 75/99, see table 1)<sup>1</sup> reveals that the biggest contribution to phosphorus input reduction was made by point sources like municipal sewage treatment plants and industrial direct dischargers. As far as the

<sup>1</sup> Umweltbundesamt, Texte 75/99, Nährstoffbilanzierung der Flussgebiete Deutschlands, Forschungsbericht 295 25 515, ISSN 0722-186X, Umweltbundesamt, Postfach 330022, 14192 Berlin



diffuse sources are concerned, municipal areas also made a considerable contribution to this reduction, whereas phosphorous washed out from soil and as a result of erosion actually increased. In 1987, the share of point sources - 64,000 t P/a - was still twice as large as the share of diffuse sources - 30,000 t P/a -, but in 1997 the trend had reversed with 12,000 t P/a for point sources and 25,000 t P/a for diffuse sources.

Inputs of nitrogen at point sources were reduced by 46% (municipal sewage treatment plants reduced their share by 33%, industrial direct dischargers by 79%) while all diffuse sources together only achieved an input reduction of 10 %. In 1997 the share of diffuse sources of the total input of nitrogen into surface waters was 72% while point sources amounted to 28% (of which municipal sewage treatment plants made up 25% alone), see table 1.

From an environmental point of view, Germany has to strive for further reductions of nutrient inputs into surface waters. Although past reductions were achieved mainly by significantly reducing the inputs of industry and municipal treatment plants, further input reductions in the municipalities might be possible. Even if this opens up possibilities for the application of new sanitation technologies in Germany it is obvious that further input reductions at the municipal level will not be sufficient. For nitrogen in particular, the major part of future reductions will have to be achieved at non-point source inputs. Otherwise it will be very difficult to reach the national environmental target that nitrogen concentrations in all surface waters should conform with water quality class II by the year 2010. In 1999 this quality standard (chemical quality class II = 3 mg of nitrogen per litre) was met at only 12 % of all sampling points <sup>2</sup>.

**Table 1: Nutrient inputs into surface waters in Germany (UBA-Texte 75/99)<sup>1</sup>**

	Nitrogen			Phosphorus		
	1983 – 87 1000 tN/a	1993 – 97 1000 tN/a	Difference in %	1983 – 87 1000 tP/a	1993 – 97 1000 tP/a	Difference in %
Groundwater	401.4	394.4	- 1.7	6.6	5.7	- 12.7
Drainage	168.3	121.4	- 27.9	3.5	3.3	- 7.1
Erosion	12.2	12.3	+ 0.8	7.5	8.1	+ 8.1
Run-off	13.4	13.6	+ 1.6	2.5	3.3	+ 30.4
Atmospheric deposition	14.1	10.5	- 25.2	0.3	0.2	- 29.2
Urban areas	43.7	34.1	- 21.9	9.2	4.0	- 56.3
<b>Total non-point sources</b>	<b>653.0</b>	<b>586.3</b>	<b>- 10.2</b>	<b>29.6</b>	<b>24.6</b>	<b>- 16.8</b>
Municipal sewage treatment	303.3	204.9	- 32.5	56.9	11.4	- 80.0
Industrial direct discharge	128.3	27.5	- 78.6	7.1	1.3	- 82.3
<b>Total point sources</b>	<b>431.6</b>	<b>232.4</b>	<b>- 46.2</b>	<b>63.9</b>	<b>12.6</b>	<b>- 80.3</b>
<b>Total input</b>	<b>1084.6</b>	<b>818.6</b>	<b>- 24.5</b>	<b>93.5</b>	<b>37.3</b>	<b>- 60.2</b>

<sup>2</sup> personal communication, Umweltbundesamt, Division II.3.4

### 3. Sustainable use of resources

#### Water

Environmental objectives for freshwater consumption do not exist in Germany. Germany enjoys favourable climatic conditions so that, on average, there is no water scarcity. Nevertheless, there are a number of reasons for an economical use of freshwater as stipulated in the German Federal Water Act.

Primarily it is local shortages that are the deciding factor in concrete considerations. Also, the reduction of water consumption is closely linked to lower energy consumption. Lower water consumption contributes to achieving climate protection goals. Furthermore, resource and nature conservation concerns call for groundwater aquifers for the extraction of drinking water not to be overloaded. Therefore, along with a range of measures for promoting life-cycle management and resource-efficient production procedures in industry and trade, the Federal Environment Ministry has introduced various initiatives over the past ten years for reducing water consumption in private households and public institutions.

Protecting resources is not only achieved by means of efficient and rational use, but also by recharging groundwater resources. The Federal Soil Protection Act of March 1998 provides Germany with a legal instrument for protecting soil in its function for recharging ground water, and over the past couple of years has continued to promote land desealing which has begun in many municipalities, and the local infiltration of clean rainwater.

Complete local rain water harvesting is complementary to some ecosan technologies. But there are many doubts voiced that German cities, under present hydrological conditions, can do entirely without storm water and waste water mains.

#### Nutrients / sewage

In 1993 Germany produced 3.2 mio t of sewage sludge, which according to EU statistics corresponded to 40% of the total EU sewage sludge production of 7.6 mio t. Of these 3.2 mio t only 31% was recycled in agriculture, 57% was land-filled and 17% incinerated.

The German Sewage Sludge Ordinance of 1992 lists numerous restrictions for sewage sludge recycling. Unfavourable pH values as well as too high concentrations of pollutants like pathogens, heavy metals and persistent organic pollutants may exclude agriculture utilization of valuable sewage sludge components. Even though the principle of sustainable use of resources should call for extensive nutrient recycling, in a number of cases municipal sewage sludge is too contaminated to be used. This contamination stems from diffuse inputs in urban areas i.e. the widespread use of chemical products (or products from which chemicals are released) in households and in the public and the private sector.

New sanitation technologies have to take this into account too. They should allow an even wider nutrient reuse. Therefore their capacity for holding back possible contaminants must be at least as good as that of conventional systems.

#### 4. Urban infrastructure

Obviously a town consists of more than an agglomeration of residential buildings. In industrialized countries, an urban area generally comprises also traffic areas, public services, small and medium enterprises and quite often even bigger industries. Also, urban areas often undergo a shift of use and development patterns over time so that for example shops, workshops and doctors' practices may close down at one place and open up at another.

Conventional waste water systems are flexible enough to accommodate such changes. What if a town would not operate one waste water system (consisting of installations for storm water and urban waste water) but had to come to terms with a large number of operators of small scale sanitation treatment units not connected with each other? Tailor-made decentralized sanitation systems may have difficulties coping with shifting user patterns when towns develop.

More important is that conventional waste water and storm water installations offer a system for a large range of urban effluents that is relatively easy to manage and administer. This is a decisive advantage in a sector which bears considerable environmental risks. In waste management, with a multitude of stakeholders and market mechanisms for environmental safe treatment and disposal of wastes we learned that compliance control can be quite a weak point. In Germany, unlawful waste disposal had to be made a criminal act subject to the Criminal Code. There is even an international convention dealing with exports and disposal of hazardous wastes. Therefore, the possibilities of public control and the administrability also have to be taken into consideration when discussing systems to deal with municipal effluents. Inadequately managed waste water systems may lead to diffuse pollution, increasing groundwater contamination and environmental deterioration in the same way as is reported of overloaded and insufficient waste water systems in fast growing cities<sup>3</sup>.

#### 5. Conclusions

Drawing conclusions from an environmental point of view some conditions emerge that may be of importance for the further development of new sanitation technologies:

- Pollution of waters has to be further reduced. This holds true for toxic substances as well as for nutrients from both diffuse and point sources.
- New substances and products are being developed, used, and discharged into waste water plants. There is no reason to assume that the use of chemical products in modern society will be restricted to conventional sewage systems. Most probably, also new decentralized sanitation systems, when widely in use, will have to cope with this fact.
- So, decreasing requirements for urban wastewater treatment is not very likely.
- Re-use of nutrients should be given preference over the destruction of nutrients in technical plants. This will be an issue of growing importance in the future.
- Any system to replace existing sewage systems has to be at least as cheap, safe, hygienic, manageable and sustainable. The existing systems represent huge investments and as long as they are working sufficiently well, starting up new systems in industrialized

<sup>3</sup> i.e. Ralph Heath, The Impact of an African Mega-City on the Water Resources and Local Economy, 4th Int. Conf. on Diffuse Pollution, Bangkok, Thailand, 16-20 January 2000

countries will need more and clearer demonstrations of the comparative advantages of these systems.

- The Federal Environment Ministry welcomes therefore the on-going research projects that will give further insight on the competitiveness and the feasibility of new sanitation concepts in Germany.
- Finally, for the European Union we may hope that better consideration of environmental and resources costs as required by the new EU Water Framework Directive will lead to better knowledge and to an optimisation of sanitation, pollution control, and resource management.

## The Bellagio Principles and a household centered approach in environmental sanitation

**Roland Schertenleib**

Water and Sanitation for Developing Countries (SANDEC),  
Swiss Federal Institute for Environmental Science and  
Technology (EAWAG)  
Ueberlandstrasse 133, CH-8600 Duebendorf, Switzerland

### Background

**1.2 billion people do not have access to safe drinking water**  
**3 billion people do not have access to proper sanitation**  
**50% of all solid waste is uncollected**  
**No one knows how many people are flooded out each year**  
**and**  
**3 billion people have to survive on less than US\$ 2/day**

The large number of people around the world who still do not have access to adequate water, sanitation, drainage and solid waste disposal services provides sufficient evidence that conventional approaches to environmental sanitation<sup>1</sup> are unable to make a significant dent in the service backlog which still exists. At the same time, the world's natural supply of freshwater is subject to increasing environmental and economic pressures. The situation is likely to worsen dramatically unless determined action is taken, because continuing population increases and increasing per capita water demand, fueled by improving economic conditions, will further contaminate and deplete sources of water which are finite, and in many countries already over-exploited.

In 1999, at a workshop in Hilterfingen, Switzerland, a sub-group of the Environmental Sanitation Working Group (ESWG) of the Water Supply and Sanitation Collaborative Council (WSSCC) conceived of a new approach to overcome the serious lack of sanitation services, causing illnesses and slowing the economic progress of hundreds of millions of people in developing countries: the Household Centred Environmental Sanitation (HCES) Approach. The group concluded that this approach offered the best hope of achieving the goal of "Water and

<sup>1</sup> Environmental Sanitation (ES) has been defined as: "Interventions to reduce peoples' exposure to disease by providing a clean environment in which to live, with measures to break the cycle of disease. This usually includes disposal of or hygienic management of human and animal excreta, refuse and wastewater, the control of disease vectors, and the provision of washing facilities for personal and domestic hygiene. ES involves both behaviours and facilities which work together to form a hygienic environment." The Hilterfingen Group added to these components stormwater management, and water to the extent that water influences the method of waste disposal.

Sanitation for All within a Framework which balances the Needs of People with those of the Environment to support a Healthy Life on Earth”<sup>2</sup>.

### Challenging conventional thinking

A group of 25 experts drawn from a wide range of international organisations involved in environmental sanitation, both from headquarters offices and the field, met at Bellagio, Italy, from 1-4 February 2000 in order to review the recommendations of the Hilterfingen Group, and to develop them further<sup>3</sup>. The participants all accepted the need to challenge conventional thinking, and to do so persuasively to the wider international water resources and waste management community, public and private, as well as among the broader community of economic, social, and urban policy-makers. The basis for this need is as follows:

- ‘Business as usual’ cannot provide services for the poor; the rapid rate of urbanisation poses particular problems of squalor, human indignity, and threat of epidemic.
- ‘Business as usual’ is not sustainable even in the industrialised world; sewerage and drainage systems are over-extended and the use of water of drinking quality to transport human excreta is extravagant, wasteful, and the wastes thereby flushed add to the pollution of the environment.
- The under-utilisation of organic residues is economically wasteful, and belongs to a distorted view of waste management as confined to issues of disposal as opposed to resource utilisation.
- Centralised systems designed and implemented without consultation with, and the participation of, stakeholders at all levels are out-moded Stalinist or high Victorian responses to public health and environmental problems, and are ineffective in today’s world. Stakeholder participation is vital.
- There is a lack of integration between excreta disposal, wastewater disposal, solid waste disposal, and storm drainage. Many problems would be resolved by a new paradigm which placed all aspects of water and waste within one integrated service delivery framework.
- The pressures of humanity on a fragile water resource base, and the corresponding need for environmental protection and freshwater savings, require that wastewater and wastes be recycled and used as a resource, within a circular system based on the household, community, and municipality, rather than a linear system.
- The export of industrialised world models of sanitation to environments characterised by water and resource scarcity is inappropriate, and amounts to an amoral continuation of wrong solutions.

### The Bellagio Principles

In the light of these compelling arguments for radical re-thinking, the following principles were proposed as the underpinning basis for a new approach:

<sup>2</sup> EAWAG/SANDEC: Household-centred environmental sanitation: Report of the Hilterfingen workshop on environmental sanitation in the 21<sup>st</sup> century (15 – 19 March 1999)

<sup>3</sup> SANDEC/WSSCC: Summary Report of Bellagio Expert Consultation on Environmental Sanitation in the 21<sup>st</sup> century (1 – 4 February 2000)

1. **Human dignity, quality of life and environmental security at household level should be at the centre of the new approach, which should be responsive and accountable to needs and demands in the local and national setting.**
  - solutions should be tailored to the full spectrum of social, economic, health and environmental concerns
  - the household and community environment should be protected
  - the economic opportunities of waste recovery and use should be harnessed.
2. **In line with good governance principles, decision-making should involve participation of all stakeholders, especially the consumers and providers of services.**
  - decision-making at all levels should be based on informed choices
  - incentives for provision and consumption of services and facilities should be consistent with the overall goal and objective
  - rights of consumers and providers should be balanced by responsibilities to the wider human community and environment.
3. **Waste should be considered a resource, and its management should be holistic and form part of integrated water resources, nutrient flows and waste management processes.**
  - inputs should be reduced so as to promote efficiency and water and environmental security
  - exports of waste should be minimised to promote efficiency and reduce the spread of pollution
  - wastewater should be recycled and added to the water budget.
4. **The domain in which environmental sanitation problems are resolved should be kept to the minimum practicable size (household, community, town, district, catchment, city) and wastes diluted as little as possible.**
  - waste should be managed as close as possible to its source
  - water should be minimally used to transport waste
  - additional technologies for waste sanitisation and reuse should be developed.

### The Household-Centred Environmental Sanitation Approach (HCES)

The approach of environmental sanitation developed by the Hilterfingen Workshop and termed the 'Household-Centred Environmental Sanitation' model is largely based on the Bellagio Principles. The Environmental Sanitation Working Group is convinced that the HCES approach offers the promise of overcoming the shortcomings of business as usual because its two components correct existing unsustainable practices of planning and resource management. These components are:

- 1) *Household Centered Environmental Sanitation (HCES)* makes the household the focal point of Environmental Sanitation Planning, reversing the customary order of centralized top-down planning. It is based on the concept that the user of services should have a deciding voice in the design of the service, and that environmental sanitation problems should be solved as close as possible to the site where they occur. Only problems not manageable at the household level should be "exported" to the neighborhood, town, city and so on up to larger jurisdiction. Making the household the key stakeholder also provides women with a strong

voice in the planning process, and changes the government's role from that of provider to that of enabler; and

- 2) The *Circular System of Resource Management (CSR)* that, in contrast to the current linear system, emphasizes conservation, recycling and reuse of resources. The circular system practices what economists preach: waste is a misplaced resource. By applying this concept, the circular system reduces “downstream” pollution.

### Structure of decision making in the household-centred approach

The conventional approach to water supply and environmental sanitation is based on a highly-centralized system of decision-making, usually under the control of the national government. In recent years, many governments have attempted to decentralize, first by deconcentrating their functions, then by delegating these functions to second-and third-tier governments (for example, to provinces and municipalities). Eventually, some governments have devolved responsibility for service provision to local authorities.

The results of these efforts have been mixed. Deconcentration and delegation leave central policy-makers in charge, and do little to encourage initiatives by local office-holders and managers; decisions are still made at the center, which also holds tightly onto the purse strings.

The problems with devolution generally result from the fact that only the new responsibilities, not the means of implementing them, are transferred to the local authorities. Frequently the government neither relinquishes its revenue-generating powers, nor provides the local authorities with the funds necessary to successfully operate the services for which they are now responsible.

The HCES Approach is a radical departure from past central planning approaches. As shown in the figure it places the stakeholder at the core of the planning process. Therefore, the approach responds directly to the needs and demands of the user, rather than central planner's often ill-informed opinions about them.

It is based on the following principles:

- Stakeholders are members of a “zone”, and act as members of that zone (“zones” range from households to the nation). Participation is in accordance with the manner in which those zones are organized (for example, communities and neighborhoods consist of households, towns consist of communities, etc.).
- Zones may be defined by political boundaries (for example, city wards and towns) or reflect common interests (for example, watersheds or river basins).
- Decisions are reached through consultation with all stakeholders affected by the decision, in accordance with the methods selected by the zone in question (for example, votes at national level in a democratic system, town hall meetings at local level, or informal discussions at neighborhood level).
- Problems should be solved as close to their source as possible (for example, where feasible, a community should provide services to households within it; common wastewater treatment facilities for several communities should be provided by a consortium of the communities). Only if the affected zone is unable to solve the problem should the problem be “exported”, that is, referred to the zone at the next level.
- Decisions, and the responsibility for implementing them, flow from the household to the community to the city and finally to the central government (there may also be intervening zones that need to be considered; for example, wards within the city, districts within a



province; or provinces within the nation). Thus, individual households determine what on-site sanitation they want; together with other households, they decide on the piped water system they want for their community, together with other communities, they determine how the city should treat and dispose of its wastewater. Policies and regulations are determined by central government, with implementation delegated to the appropriate levels flowing towards the household.

**Circular system of resource management**

An important principle of the HCES approach is to minimise waste transfer across circle boundaries by minimising waste-generating inputs and maximum recycling/ reuse activities in each circle.

In contrast to the current linear system, the *Circular System of Resource Management (CSR)* emphasizes conservation (reducing imports) of resources, and the recycling and reuse of resources used (minimizing exports). Resources in the case of environmental sanitation are water, goods used by households, commerce and industry, and rain water. The circular system practices what economists preach: waste is a misplaced resource. By applying this concept, the circular system reduces “downstream” pollution.

**Implications of applying the HCES model**

However the boundaries of each zone are defined<sup>4</sup>, implementation of the HCES approach requires stakeholders within the zone to plan and implement environmental sanitation infrastructure and service delivery in a manner that is

**Decision Making in**

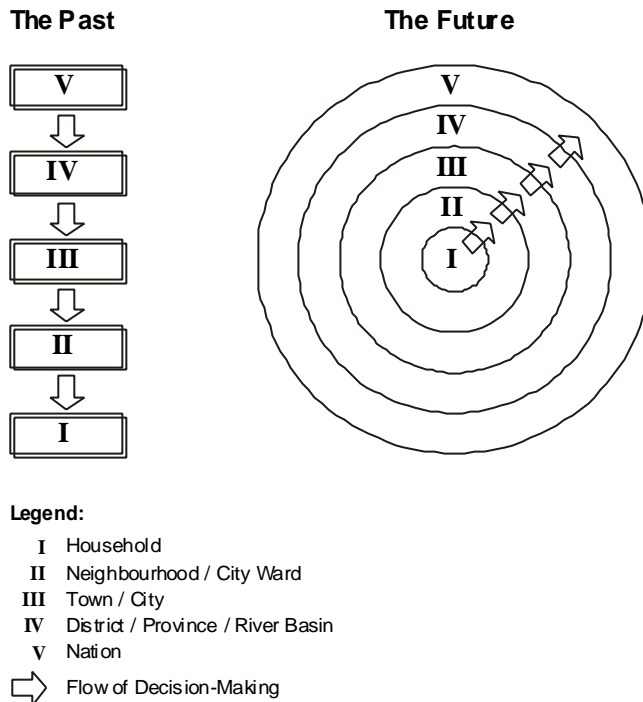

**Principle Of Minimising Waste Transfer Across Circle Boundaries**

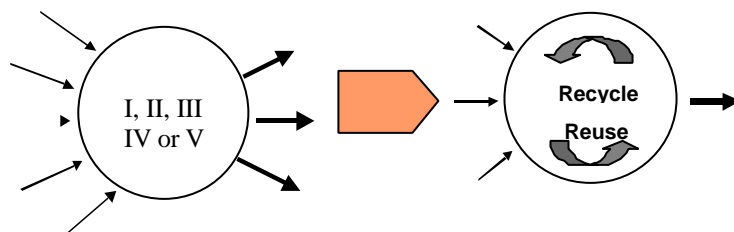

<sup>4</sup> It should be noted that the boundaries appropriate to each of the various sub-sectors may not be identical. A fundamental exercise in establishing the HCES model is therefore to determine how best to treat the study area in terms of zones and sub-zones, as well as of sectors and sub-sectors. This is probably best resolved through an analysis of actual case studies, rather than as an abstract theoretical concept.

sustainable with the resources which are available to them within the zone (or which can be made available from another zone). The approaches that should guide them in arriving at such sustainable solutions within each zone include some or all of the following:

- *Water demand management*, in order to minimize wasteful use of water, and so reduce the need for new source development and limit the production of wastewater;
- *Reuse and recycling of water*, in order to minimize the need for wastewater collection, treatment and disposal;
- *Solid waste recycling*, in order to reduce the burden of collecting and disposing of solid wastes;
- *Nutrient recovery*, whether at the household level (for example, eco-sanitation), or on a wider scale (for example, urban agriculture);
- *Improved rainwater management*, reducing runoff by on-site or local measures, including detention and treatment, and the reuse of stormwater to benefit the community, such as storage for fire fighting and recreational or amenity use, thus reducing uncontrolled discharge to surface waters;
- *Strong emphasis on intermediate technologies*, so as to encourage household- and community-level construction, operation and management of facilities, and permit reuse and/or disposal at the local level;
- *Institutional arrangements and mechanisms* that stress the involvement of the users, encourage the participation of the private sector, facilitate cooperation across zone or sub-zone boundaries (such as wholesale – retail relationships for service delivery), and ensure the provision of technical assistance across zone boundaries where needed;
- *Economic analysis procedures* that clearly illustrate the economic benefits of good planning as well as the consequences of sub-optimal development (for example, in terms of environmental damage; wasteful use of water, energy or other resources; or relying on imported skills and equipment and so failing to make the best use of local resources);
- *Effective and sustainable financial incentives* to encourage the adoption of economically-desirable alternatives;
- *Financial procedures* that determine whether problems should be solved within the zone itself, or whether a joint solution should be selected to serve more than one zone (for example, a city-wide system serving a number of wards). Where economic and financial considerations indicate that a shared solution is preferable, appropriate cost-sharing mechanisms need to be established.
- *Cost recovery practices* (predominantly user charges in Zones I and II; tax revenues elsewhere) that ensure financial viability, are socially equitable, and promote the “circular system” and the productive use of “wastes”.

In summary, programs and projects designed in accordance with the HCES approach will, like all successful and sustainable development efforts, have to address all aspects of development: social, institutional, economic and financial, and technological. The difference is that they will truly be “bottom up”, beginning with the preferences and capabilities of the households.

## Development of eco-san systems

Uno Winblad

Winblad Konsult AB  
Heleneborgsgatan 52, 11732 Stockholm, Sweden

### Introduction - definition

There are those who claim that ecological sanitation is “just another technology” - like ventilated improved pit latrines or small bore sewers. But that is to miss the point. Conventional sanitation is based on hiding human excreta in deep pits or diluting them with water and exporting them to the neighbours downstream. Ecological sanitation stands for another way of thinking - a completely different approach to sanitation. Ecological sanitation is based on the insight that the Earth is a closed ecological system where nothing permanently disappears.

Ecological sanitation relates human excreta to the environment, taking into account their effects on soil, water and living organisms, including neighbours (Esrey et al 1998).

Everything that today is labelled ‘ecological sanitation’ is not necessarily that. I use the term ‘ecological’ for sanitation systems that

- prevent pollution,
- destroy pathogenic organisms, and
- recycle human excreta as fertilizer.

To be called ‘ecological’ a sanitation system should (try to) fulfil these three criteria. A system that fulfils only one, for example by recycling nutrients, does not qualify as ecological sanitation. Zero discharge is an essential part and so is prevention. A main characteristic of the ecological approach is that we try to prevent the problems rather than deal with them at the end of a pipe.

Our main concern is therefore with sanitation as an ecological subsystem - part of a larger ecological system, part of the biosphere. This subsystem has components relating to nature: climate, soil, water, vegetation. It has components related to culture: beliefs, behaviour, municipal and household economy. And it contains technical components: squatting pans, pipes, fans, solar heaters, containers, vehicles.

My assignments for this symposium are to outline the international development of ecological sanitation systems and to briefly discuss urban planning aspects of large-scale implementation. My main conclusion is that any attempt to introduce an ecological sanitation system must be accompanied by a substantial amount of social marketing, instruction of builders, users and operators and follow-up.

### International development

No single person can be credited with inventing ecological sanitation, urine diversion or composting. They have been practised in China and elsewhere in Asia for hundreds, maybe thousands, of years.

What is new is that we now, since the emergence of the environmental movement in the 1960s and 1970s, try to combine these age old concepts with present day science and technology and

adapt them to modern urban living. This means attractive design, freedom from odours and flies, easy operation, effective pathogen destruction and cost-effectiveness. It also means that we must create the institutions required to manage ecological sanitation systems on a large scale in urban and peri-urban areas.

I shall quickly highlight the development of ecological sanitation over the past 100 -150 years with the help of a series of slides (\* = slide). But first I shall show a picture of a basic, rudimentary latrine that has been used from time immemorial by peasant households in southern China:

- \* latrine, Guangxi Province, China (photo)
- \* latrine, Guangxi Province, China (drawing)

Although this system does not fulfil the three criteria just outlined, it can be regarded as the great-grandmother of ecological sanitation.

In the 19th century various types of earth closets were patented in Britain (Moule 1875).

- \* Henry Moule's earth closet (drawing)

About 90 years ago a German landscape architect, Leberecht Migge, developed the eco-san concept for urban areas and actually put it into practice (Jarlöv 1996).

- \* Migge: organic loop with the 'Metroclo' toilet (diagram)

Leberecht Migge's company also produced and sold a urine diverting toilet.

- \* Migge's toilet, the 'Metroclo' (section and perspective)

Twenty years later, in the 1940s, a Swedish teacher, Rickard Lindström, invented the Clivus Multrum (Lindström 1965).

- \* Clivus Multrum, original (section)

The Vietnamese double-vault toilet was developed in the 1950s (Viet 1978).

- \* double-vault toilet (drawing)
- \* double-vault toilet, Ha Bac Province, Vietnam (photo)

It is still widely used in north Vietnam and also in El Salvador, where it is known as the LASF toilet.

My own interest in this field goes back some 40 years when I began working on housing and urban development in Africa.

- \* Etege Mesk housing project, Addis Ababa (drawing)
- \* Etege Mesk (photo: street)
- \* Etege Mesk (photo: house)

This eventually developed into a project for a Scandinavian architectural competition, 'Housing in Developing Countries' held in 1970 (Scan Plan 1970).

- \* Housing in Developing Countries, bird's eye view (drawing)
- \* Housing in Developing Countries, prototype toilet (model)

While I did much of my early work in Ethiopia and Tanzania, another Swede, Gus Nilsson, was working on dryland farming, food security and recycling in Botswana (Winblad 1992). Nilsson is an agriculturalist and a holistic thinker. On the outskirts of Gaborone he has developed his 'productive homestead' concept based on rainwater harvesting, intensive vegetable production and recycling of human excreta.

- \* 'The Productive Homestead', Gaborone, Botswana (rainwater harvesting, vertical gdn)
- \* 'The Productive Homestead', Gaborone, Botswana (toilet processing chamber)
- \* 'The Productive Homestead', Gaborone, Botswana (evapo-transpiration bed)

There was a parallel development in Scandinavia and north America in the 1970s. The Minimum Cost Housing Group at the University of Montreal published the book "Stop the 5 gallon flush" (Minimum 1976) and the Farallones Institute in California produced manuals for self-builders on how to build composting toilets. Davis del Porto is another of those early north American ecological sanitation pioneers. He has recently published a book on the subject (Del Porto 1999).

Over the next 20-25 years these ideas have been picked up around the world.

- \* Cuernavaca, Mexico (bathroom)
- \* Cuernavaca type (model photo)
- \* Barrio Arco Iris, El Alto, Bolivia
- \* Ecuador, solar heated (exterior)
- \* Ecuador, solar heated (interior)
- \* Yongning County, Guangxi Province, China
- \* Pharmaceutical factory, Järna, Sweden (staff toilet)
- \* Pharmaceutical factory (processing chamber)

## Urban planning aspects

There are now hundreds of thousands of eco-san toilets around the world. Many of them have been in use for 10 to 15 years - in Scandinavia, North America and Vietnam even longer. We are beginning to get good scientific data on pathogen destruction. But there is one important gap in our knowledge: We have as yet no example of a large-scale, community wide, urban application.

Many people assume that ecological sanitation is a concept for rural environments. Of course it can, and should, be applied in rural areas. But I see it primarily as an urban solution. The introduction in the past century of flush toilets and pipe networks for the transmission of sewage have caused such extensive degradation to nature and been so destructive to public health that it should no longer be propagated as "the solution". The great challenge facing us in this century is to develop ecological sanitation systems for urban centres.

Today there are only a few small urban applications. An example is in the Hermosa Provincia community, a 'barrio' consisting of about 130 household living at very high density on the top of a small hill in the centre of San Salvador. This community solved its sanitation problem about 10 years ago by building urine diverting, double-vault toilets (LASF type) attached to the house or located indoors.

- \* Hermosa Provincia (street, access doors)
- \* Hermosa Provincia (toilet)

Hermosa Provincia, like all other small scale projects we have today, depends entirely on the individual household to manage the entire system. In the future, when ecological sanitation systems are applied to whole neighbourhoods and towns, the maintenance burden on the individual household can be reduced. We can have service contracts for collection, secondary

treatment and end use of the sanitized products. We can establish neighbourhood recycling stations with collection workers who are trained in instructing and assisting households.

- \* neighbourhood composting plant, Mexico City (sign)
- \* neighbourhood composting plant, Mexico City (bins)
- \* tricycle (prototype), the Eco-san project, Nanning, China

The layout of an urban area is to a large extent determined by the kind of technical infrastructure that is to be provided. An urban region planned from the beginning for decentralized management and recycling of human excreta, greywater and garbage is likely to look different from one based on centralized sewerage and garbage collection. There will be no need for gravity fall sewers, pumping stations and treatment plants. Greywater can be treated locally in natural and artificial wetlands. The neighbourhood composting and recycling stations would take care of most of what is now going to landfill sites or incineration plants.

All this will greatly influence the layout of urban areas as well as the municipal economy. The design of houses, apartment buildings, office blocks and schools will obviously be affected. It is possible to install ecological sanitation systems in existing buildings but for optimum results neighbourhood, building and infrastructure should be planned together.

- \* Kalmar University, exterior
- \* Kalmar University, toilet
- \* Kalmar University, processing chambers

It is not sufficient to demonstrate that it would be technically feasible and culturally acceptable to provide an urban area with an ecological alternative to conventional sewerage. We must also convince the municipal decision makers that it is an inexpensive alternative.

The initial construction costs alone for sewerage OECD cities is about USD 50.000 per household (Goodland & Rockefeller 1996; Lian Chawii 2000). I am convinced that an ecological sanitation system can be provided for a fraction of that cost. Unfortunately there is as yet no comprehensive study comparing the overall costs to society of these two alternatives - ecological vs conventional sanitation. Here is an important task for the forthcoming GTZ study of ecological sanitation.

## Conclusions

The theme of this session is "... existing approaches and visions". - I have very briefly outlined existing approaches. We are still in the early stages of the development of ecological sanitation. Compare with the development of air traffic: 100 years ago the brothers Wright could fly a few hundred yards with a machine carrying 1 person. Twenty years later it was possible to fly across the Atlantic, and today we fly around the world in aircrafts carrying 300-400 passengers. The early flights by the brothers Wright and today's long distance flights are based on the same aerodynamic principles.

Ecological sanitation is today where flying was in the beginning of last century. We do not know what ecological sanitation may look like 50 or 100 years from now. So far the emphasis has been on the design of on-site or in-house devices and how to operate them. But in the future we will be able to apply ecological principles to towns, big cities and whole metropolitan areas. The vision, the real challenge, is the ecological city, a city based on equity, sustainability and maintaining the quality of the environment for future generations.

Because we are in the early stages of the development of ecological sanitation the concept is unknown and likely to be misunderstood. A major part of our development efforts must therefore consist of social marketing, instruction, follow-up and more instruction.

## References

- Chawii Lian (2000): Japan at crossroads, in Down to Earth, 31 May 2000, New Delhi, India.
- Del Porto D and Steinfeld C (2000): The compost toilet system book. Center for Ecological Pollution Prevention, Concord, Mass., USA.
- Esrey S, Gough J, Rapaport D, Sawyer R, Simpson-Hébert M, Vargas J and Winblad U (ed)(1998): Ecological sanitation. Sida, Stockholm, Sweden.
- Goodland R and Rockefeller, A (1996): What is environmental sustainability in sanitation?, in UNEP-IETC Newsletter, Summer 1996. Nairobi, Kenya.
- Jarlöv L (1996): Stadsekologi och trädgårdskultur. Byggnadsnämnden, Stockholm, Sweden.
- Lindström R (1965): A simple process for composting small quantities of community waste, in Compost Science: Journal of Waste Recycling. Spring 1965, p 30-32. Rodale Press, Emmaus, PA, USA.
- Minimum Cost Housing Group (1976): Stop the five gallon flush. A survey of alternative waste disposal systems. McGill University, Montreal, Canada.
- Moule H (1875): National health and wealth. W Macintosh, London, UK.
- Scan Plan Contact (1970): Housing in developing countries. SPC Report No 1/1970. Stockholm, Sweden.
- Viet Chy (1978): Phan tieu, nuoc tieu va cach su dung (Human faeces, urine and their utilization). Agricultural Publishing House, Ho Chi Minh City, Vietnam.
- Winblad U (1992): The productive homestead - report of a study tour. Sida, Stockholm, Sweden.

## Planned funding activities on concepts and technologies of alternative, decentralized water supply and sanitation

**Dr. Andrea Detmer**

Federal Ministry of Education and Research (BMBF),  
Heinemannstr. 2, 53175 Bonn-Bad Godesberg



**Planned funding activities on concepts and technologies of alternative, decentralized water supply and sanitation**

Dr. Andrea Detmer  
Federal Ministry of Education and Research  
(BMBF)







Staatsministerium  
für Bildung  
und Forschung

bmb+f

## Current bmb+f activities on decentralized water supply and sanitation concepts

### Research projects

Various running research projects in the field of technological modules, e.g. anaerobic sewage treatment, low-sewage excreta discharge, treatment and utilization of rainwater and partially treated or low-polluted sewage, separation of wastes, waste incineration and composting, unit-type heating power technology

### Studies

- Integrated systems for supply and sanitation in urban areas, TU München
- Determination of the international state of the art on alternative water supply systems, University Witten-Herdecke

BMBF PUBLIK



Staatsministerium  
für Bildung  
und Forschung

bmb+f

## Announcement (in preparation): ® Integrated approach

Quasi-autarkic state of residential areas, concerning supply and disposal of water, energy, waste etc.

Development of overall concepts for representative residential areas and transferable settlement scenarios, compilation of necessary technology modules and integral solutions

Different solutions for industrial countries, developing and threshold countries, technology transfer

BMBF PUBLIK



Ministerium  
für Bildung  
und Forschung

**bmb+f**

**Industrial countries**  
**Developing countries, Threshold countries**

**in consideration of**  
**natural, socio-economic and cultural conditions**

- Climate
- Infrastructure
- Legislation
- Ressources
- Religion
- Quality standards
- etc.

BMBF PUBLIK

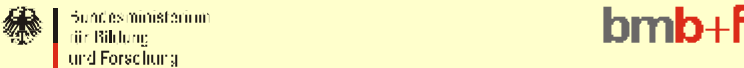

Ministerium  
für Bildung  
und Forschung

**bmb+f**

**Announcement (in preparation):**  
**(A) Overall concepts (I)**

Improvement and combination of individual techniques/processes to an overall concept with socio-cultural, economic and climate aspects being taken into account.

**1. Characterization of various residential areas / structures**

- Determination of the need for supply and disposal services
- Definition of the necessary quality and quantity of supply and disposal materials
- Determination of the necessary and sufficient infrastructure
- Definition of the optimum settlement structure size

BMBF PUBLIK



## Announcement (in preparation): (A) Overall concepts (II)

2. Modeling of possible combinations of technologies (cleaning processes close to nature, low-sewage excreta discharge, unit-type heating power technology etc.) for selected structures on the basis of the state of the art and definition of development deficiencies and monitoring strategies
3. Studies concerning the social and legal acceptance of extensive water recycling (drinking water from sewage!!)
4. Definition of requirements to be complied with by "new" modules for the overall concepts being fulfilled



## Announcement (in preparation): (B) Technological modules

- Technologies for recycling liquid effluents from washing and dishwashing machines
- Development of safe and environmentally compatible processes for the hygienization of partially treated or low-polluted sewage and rainwater
- Development of maintenance structures with minimum costs arising
- Technologies for the simultaneous treatment of organic wastes (e.g. kitchen waste) during sewage treatment
- Integration of storage concepts (e.g. also for water for fire fighting) in residential structures
- Optimization of multiple-pipeline systems in settlements and buildings (necessary number, laying, protection from misuse)
- Alternative systems for low-water excreta discharge
- New technologies for using waste waters for irrigation purposes



Bundesministerium  
für Bildung  
und Forschung

**bmb+f**

## Contact

**Forschungszentrum Karlsruhe GmbH**

**Projektträger des bmb+f und BMWi  
für Wassertechnologie und Entsorgung (PtWT+E)**

**Postfach 36 40  
D-76021 Karlsruhe**

**Telefon: 07247/82-4850  
Telefax: 07247/82-2377  
E-Mail: [mail-ptwt@ptwt.fzk.de](mailto:mail-ptwt@ptwt.fzk.de)  
Internet/www: <http://www.fzk.de/ptwt>**

BMBF PUBLIK

## New developments of ecosan in Germany and Europe

**Prof. Dr. Ralf Otterpohl**

TUHH Technical University Hamburg-Harburg  
Director of the Institute for Municipal and Industrial Wastewater  
Management  
Eissendorfer Str.42, D-21073 Hamburg, Germany

### Abstract

One person produces about 500 litres of urine and 50 litres of faeces per year (=blackwater). Today, the same person, having access to tap water, produces in a range of 20.000 to over 100.000 litres of wastewater (=greywater if not mixed with blackwater). Black- and greywater have very different characteristics. If the blackwater would be collected separately with low dilution it can be converted to safe natural fertiliser, replacing synthetic products and preventing spreadout of pathogens and water pollution, too. If toilet waste is mixed with a lot of water, the large volume turns to a potentially dangerous flow of waste that has to be treated at high costs. At the same time this mixing makes simple treatment and higher quality reuse impossible because of faecal contamination and excess of nutrients. The reason for this inappropriate handling of important resources is the long lasting lack of technical developement of flushing toilets. Flushing faeces to surface waters helped spreading diseases and devastating epidemics in 19th century europe (Evans, 1987) and in more and more developing countries around the world in the last decades. According to WHO around 4 million people die from polluted water every year.

Separation of different qualities and their respective appropriate treatment for reuse is common in industrial wastewater management. This type of source control thinking is fundamental for new concepts. Due to the very different characteristics of blackwater (from the toilets) and greywater (household wastewater without blackwater) new sanitation concepts will produce fertiliser from blackwater and give a good opportunity for reuse of treated greywater. Blackwater has a composition where most of the organic matter and particulate nutrients are in the solids (brownwater). In contrast, the yellow water (urine) contains nearly all of the valuable soluble nutrients as N, P, K and others.

New promising sanitation systems are built in several countries as pilot projects. A pilot project for a vacuum-biogas system for 350 inhabitants is built in Lübeck, Germany. This semicantral system is capable to realise resources and energy recovery in more densely populated areas of house-blocks of up to 5.000 people. Larger populations could be served by additional systems because of limitations in the length of the vacuum pipes.

Another advantageous sanitation system for smaller villages and single houses is based on urine-sorting flush toilets (no-mix-toilets). Yellow water is collected with low or better without dilution and can be used directly on brown land - the nutrient composition suits many types of soil. There are some projects done in Sweden, that show the feasibility of this technique. A further developement is done in a pilot project that has been buildt in the rural water-mill museum 'Lambertsmühle' in the region of Cologne, Germany. Brownwater (the solids and flush from the sorting toilet) is converted to small volume by a two-chamber composting tank with a filtration system, where each chamber is used for a year and left without further charge the other year. The compost can be used for improvement of long term soil fertility.

## 1. What is wrong with conventional sanitation?

The traditional sanitation concept is "end-of-the-pipe"-technology. Acute problems (not the long-term-ones) are solved instead of avoiding them from the beginning with appropriate systems. This situation has become the standard approach in industrial wastewater treatment and resulted in technologies of source control with appropriate reuse technology. In the field of municipal wastewater treatment the discussion about this has just started (Henze, 1997). The first installations of the water and nutrient wasting WC and sewerage systems were criticised by many people, but alternative systems had not been reliable enough at that time (Lange, Otterpohl, 1997; Harremoës, 1997). Easy availability of water for a formerly small population in humid countries, mining of fossil nutrients and cheap energy stopped the development of systems with source control.

Sanitation concepts should take responsibility for the future of nature as well as human beings into consideration. There is no reason to wait for public or political pressure, because the public relies largely on the experts. Basic facts for sustainable systems are obvious, nevertheless pilot-projects for new approaches are necessary. Serious planning might end the common practice of the auto-matic installation of the water closet - sewerage - wastewater treatment plant (WC-S-WWTP) systems without any consideration of alternatives.

Agenda 21 of the United Nations includes no accounts of sustainable sanitation concepts (Agenda 21, 1992) although water and fertile land are core subjects for survival of future generations. Sanitation is not specified without consideration of the consequences of the implementation of the conventional system world-wide. Many experts of sanitation agree on the possibility of resulting disasters even in a short time-span in economically poorer countries.

An assessment of the amazing variety of technical options and their respective economic and social implications will be necessary in order to get to a further development of sanitation. A collection of some source control solutions was given by Henze et al. (1997) and Otterpohl et al. (1999).

Efficient sanitation concepts will mostly have to co-operate with agriculture in order to avoid emissions and allow for reuse of water and nutrients. Sustainable agriculture has to be water-friendly and improve or at least maintain soil quality. Industrial agriculture results often in degradation of fertile top-soils with alarming progress (Pimentel, 1997). Organic fertilisers produced by sanitation and waste management can help to care for maintaining and improving the fertile topsoil.

If faeces are mixed with the wastewater by the usage of conventional flush toilets this results in a high water demand, spread out of potentially dangerous pathogens and micropollutants (residues of pharmaceuticals) in a large volume of water but also a loss of an option for economic reuse of greywater and to produce fertiliser. The initially small amount of faeces could be hygienised easily and with cheap methods. For the strange mixture called municipal wastewater hygienisation is an expensive further treatment step.

Conventional sewerage systems have a couple of severe disadvantages although they are a very costly part of the infrastructure (if rehabilitation is done). Combined systems emit raw wastewater into receiving waters with the overflows, storage tanks are very expensive if the number of overflows shall be low. Separate systems are often not better or even worse because of the large number of wrong connections. Sewerage systems usually drain large amounts of water from the region, even in industrialised countries the drainage often amounts to the same volume as the total amount of wastewater. This water dilutes the wastewater and the resulting lower concentrations in the effluent of a treatment plant looks like low emissions, although loads may be high. In many cases sewerage systems are exfiltrating raw wastewater into the ground with a potential for pollution.

Discussion on hormones, their mimics and emission of medical residues by the users including hormones from widely used contraceptives are showing another weakness of sanitation systems. These substances reach receiving waters easily especially because of their polarity (easily soluble) in combination with often very low degradation rates in conventional treatment plants. Another potentially very important issue is the possibility of the transmission of resistances against antibiotics through their uncontrolled release to the environment. (Daughton and Ternes, 1999) Biological reactors are an excellent environment for exchanges of resistances while very few plants hold back all bacteria.

## 2. Regional planning in wastewater management

Regional planning has an important effect on the economics of the wastewater system. Costs for the sewerage system are on average 70% of the total of sewerage plus treatment plant costs in more densely populated rural and periurban areas in Germany. This figure can well be exceeded a lot if circumstances are less favorable. Since some years decentral on-site treatment is accepted as a long term solution in many countries. However, legal requirements are very low compared to those for larger WWTPs. It can easily be calculated that on-site plants can contribute far over their population proportion in loads. On the other hand it would be relatively simple to implement new on-site sanitation systems with full reuse of nutrients.

Proper decisions on where to connect houses to a sewerage system and where to build on-site facilities or small decentral plants are important. Good regional planning can avoid the deadlock of specifically very expensive sewerage systems that use all the money that could serve the environment in highly efficient decentral treatment and collection systems. There are cost calculation procedures that include long-term development in the balance of operation- and investment costs and products (reuse water, fertiliser, soil improver). The price of secondary products can be very relevant in economically weak and water scarce countries where water and industrial fertilisers are not subsidised. Source control sanitation can exceed the performance of the most advanced large end-of-the-pipe plant many fold at often much lower costs.

Drawbacks for decentral plants with proper technology are lack of maintenance. Legal conditions of responsibility and check up periods are essential, however this should be organised in a cost efficient way. Design of decentral systems could be in a way that collection of fertiliser and maintenance could be combined with periods of 6 or 12 month. Local farmers may be appropriate partners.

## 3. Basic considerations for the design of source control sanitation and proper management of water

Design of source control sanitation aims for a high hygienic standard and full reuse of resources. This is exactly what can be reached by clever source control. However, design has to be checked to the ability of achieving these goals. It is almost sure that strange concepts will come up from those who do not understand the simple basic principle: "No waste, full reuse". Naturally socio-economic conditions have to be taken very seriously. The background of the new systems has to be explained to the users. The fundamental step is the identification of the very different characteristics of the main components of household wastewater that are presented in Table 1. There is a certain variation as conditions are different, Table 1 gives a typical range of values.

Table 1: Characteristics of the main components of household wastewater

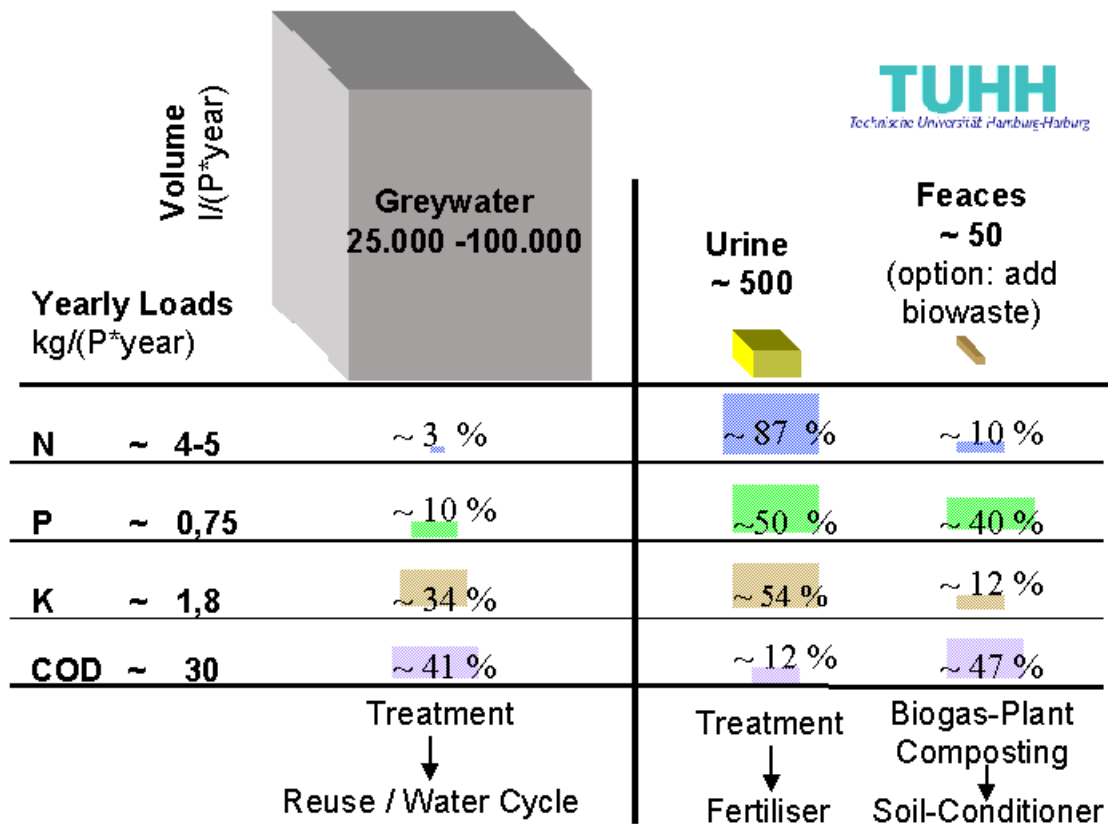

Table 1 suggests the following conclusions:

- Most of the soluble nutrients are found in urine. If urine is separated and converted to agricultural usage, the biggest step towards nutrient reuse and highly efficient water protection will be taken.
- The hygienic danger of wastewater comes almost exclusively from faecal matter. Separation and low or no dilution opens the way to excellent hygienisation with the end product 'organic soil improver'.
- Wastewater that is not mixed with human 'waste' (faeces and urine) is a great resource for high quality reuse of water. Bio-sandfilters and membrane technology open cost efficient ways of production of secondary water - on-site, local or regional scale can be appropriate.
- Source control should include evaluating products that end up in the water. High quality reuse will be far easier when household chemicals are not only degradable (original substance disappears, even if metabolites do not degrade) but can be mineralised with the available technology. Pipes for drinking water should not emit pollutants (e.g. copper or zink)
- Rainwater runoff is one of the reasons for building sewerage systems. If decentralised systems are built rainwater runoff has to be taken care of. Economic reasons will often prohibit to construct sewers for rainwater if decentral sanitation systems are to be installed. Local infiltration or trenches to surface waters for relatively unpolluted rainwater is often feasible and can be combined with usage, too. Prevention of pollution includes avoiding copper or zink gutters and rainwater pipes that can cause heavy metal pollution.



At the Global Water Forum in The Hague, 2000 there were big disputes about water scarcity. One nearly unheard voice from CSE (Centre for Science and Environment, Delhi, India) presented a different opinion: "There is no water scarcity, only mismanagement". They have strong evidence from incredible success of decentralised rainwater harvesting on local scale. In times of devastating draughts in Gujarat in 1999 there were many villages that had enough water. These villages had introduced many fold measures to direct rainwater to the aquifers with small check-dams, directing rainwater runoff to the wells and filling cisterns (Manish Tiwari, 2000). We can add that the introduction of conventional sanitation can well be mismanagement, except where reuse of the mixed wastewater in a combination of irrigation and fertilisation can be done around the year. Source control sanitation and greywater reuse can probably bring the demand of new water (e.g. from the cistern) down to low figures as to 10% of what is considered efficient today.

Up to some years ago development of source control sanitation was almost always working with composting toilets. There is a lot of experience from many thousand installations all over Europe. Many of those are working successfully, but acceptance is usually limited to people who have high regard for ecological issues. Furthermore most of the nutrients are trickling through as leachate (see table 1) that is often put into the greywater. There is a need of further development, urine diversion and concepts for real reuse (requiring 200 to 300 m<sup>2</sup> per person) would be key issues.

#### **4. New types of sanitation in Europe NoMix-toilets and gravity flow**

This concept is suitable for single houses and rural settlements based on no-mix toilets (often called separating toilets, more correctly sorting toilets). The yellow-water (urine) flows over a separate pipe into a storage tank where it stays until it is used for agricultural purposes. The storage period should be at least half a year, since this is an appropriate time for collection and part of the eventual medical residues can be destroyed during this time period. These substances are always of concern, but fast emissions to surface waters where drinking water is produced in many cases may be the worse of two bad options. Production of pharmaceutical products does increasingly consider the fate of residues after use. There are some projects in Sweden that show the potential also for complete settlements, storage will be more difficult in warmer climates. A further recent development in Germany is to provide an additional low-cost and low maintenance system with a potential of full resources recovery also for the solids. Another project in Sweden is using a bucket system, what is simple and cheap but that would not be accepted by many users. The system that was chosen in Germany collects the brownwater (faeces) that are flushed with an appropriate amount of water (e.g. 4 or 6 litres) and is either collected separately or together with greywater and discharged into one chamber of a two chamber composting tank (with filter-floor or filter bag) (see Figure 1) where the solids are pre-composted. After a one-year collecting, dewatering and composting period, the flow is directed to the second chamber while the first one is not fed for one year. This allows further dewatering and pre-composting and makes removal from the tank safer (although the matter is not hygienised then).

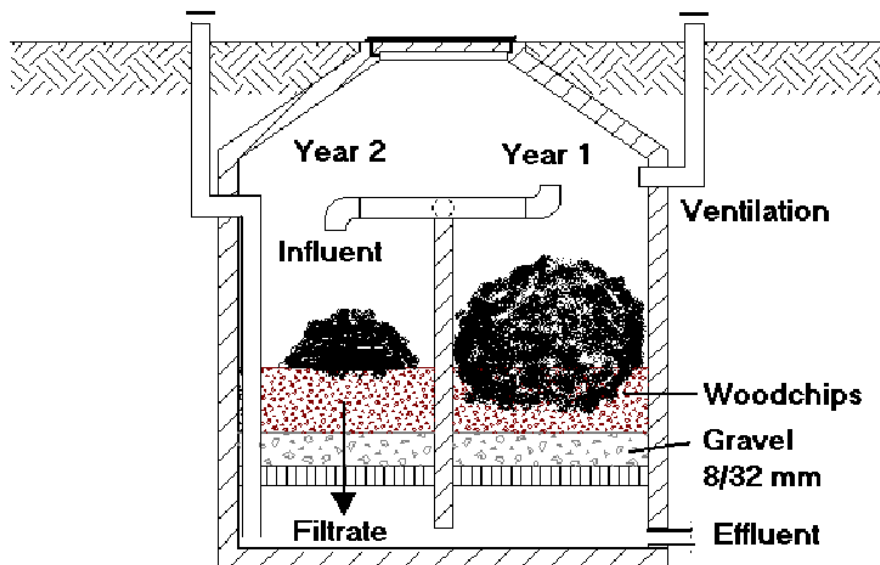

**Figure 1: Two chamber composting tank**

The products are removed from the composting tank and either used as soil improver in brown land or brought to further full composting - they could be mixed with kitchen- and gardening waste to decompose completely and allow further hygienisation e.g. by composting. The ripe compost is used for soil conditioning. The filtrate from the composting tank will be low in nutrients due to the previous separation of urine - the dissolved nutrients are mainly found in urine. Therefore, the filtrate can be treated together with the greywater (except if high quality reuse is planned).

The greywater is pre-treated either in the composting tank with the brownwater (avoiding 3rd pipe inside and from the house to the tank) or treated completely separate for quality reuse. The next step of efficient treatment can either be a bio-sandfilter (constructed wetland with a vertical intermittent flow) or in a combined activated sludge reactor with micro- or nano-filtration. These two technologies form an efficient barrier against pathogens and can achieve high quality effluents with little maintenance. The purified water is discharged to a local receiving water, infiltrated into the ground or collected for reuse. The constructed wetland requires very little energy but requires some space of about 1 to 2 m<sup>2</sup> per inhabitant.

The design parameters for the elements of the components of this system can be derived from advanced decentral technology with consideration of changes in loads. Greywater alone will typically have around half the COD load at 2/3rd of the flow. Filtrate from composting chambers will probably not have a big influence except for potential additional pathogens loads. Collection and storage of urine can be designed straight forward, urine contributes a maximum of 1,5 litres per person and day. Waterless collection will be the goal though it is not fully developed yet. Flush water must be a small flow, otherwise storage, transport and usage are getting difficult. Waterless collection seems to avoid problems of scaling (solids growth on pipe surface), too. The calcium from water can add to formation of minerals. Storage tanks must be resistant against chemicals, pipes and tank must be very watertight - small but steady infiltration rates can result in high dilution and more frequent transport requirements. Further experience can be drawn from the pilot projects that are realised now.

The concept presented here, depending on the boundary conditions, can also be build differently. Especially interesting is to include the concepts into regional planning. With the

instrument of least-cost-planning a very cost-effective solution for a whole area may be found as well as a gradual introduction. In any case, the understanding of background and motivation must be well explained so that inhabitants are motivated to co-operate.

Practical experiences with urine sorting toilets exist mainly in Sweden with more than 3000 installations. It has been clearly demonstrated that this technology is feasible. Drawbacks are observed from too small diameters of urine pipes that clog from scaling. The step to waterless collection has not been done yet in Sweden. A German company is working on a well designed toilet with waterless urine collection. But even with waterless separating toilets one major problem is left. Men are often reluctant to sit down for urinating, despite the unavoidable spreading of urine in the bathroom. This would cause a loss of urine to the brownwater. Younger people seem to accept sitting more easily and understanding the strong effect on the personal local water protection could help adapting. The luxury solution is the private urinal, that should be a well developed waterless model. The business of waterless urinals had severe problems with the wrong type of cleaning chemicals and faults in construction. New models are available in ceramic material, combination with hydrophobic nano-coating is technically feasible and will come soon, hopefully. This type of surface will also be a big progress for sorting toilets. Another problem with sorting toilets is the disposal of paper that is used after urinating by most women and some men. There could be a paper bin for this paper, otherwise it can be disposed into the faecal bowl. If not flushed there would not be additional water consumption. New ideas for this problem would be helpful.

A lot of composting chambers are in successful operation mainly in Austria and Germany. Constructed wetlands with vertical percolation and step feed are becoming the standard solution with space requirements of less than 3 m<sup>2</sup>/PE. These can be smaller for greywater. Small activated sludge plants with membranes as phase separation are becoming increasingly popular and would reach even better performance with greywater.

The Technical University Hamburg (TUHH) and Otterwasser GmbH, Lübeck have developed the system described above for Wupperverband, Wuppertal for the on-site treatment on a historic water mill near Burscheid (area of Cologne). The system is presently operated by the Lambertsühle e.V. (private initiative for the restoration of the water mill). This mill is becoming a museum on the pathway from grain to bread. In the first meeting the idea was to add with some distance the explanation of the pathway 'from bread to grain'.

## 5. New types of sanitation in Europe II

### Vacuum-toilets and vacuum transport to a biogas plant

An integrated sanitation concept with vacuum toilets, vacuum sewers and a biogas plant for blackwater is implemented for the new settlement 'Flintenbreite' within the city of Lübeck (Baltic Sea, Germany, NN 2000). The area with a total of 3.5 ha is not connected to the central sewerage system. The settlement will finally be inhabited by about 350 inhabitants and is meant as a pilot project to demonstrate the concept in practice. However, all components of the project are in use in different fields of application since many years and therefore well developed. Vacuum toilets are used in ships, airplanes and trains. There are already some implementations in flat buildings for saving water. Conventional vacuum sewerage systems serve hundreds of communities. Anaerobic treatment is in use in agriculture, in industrial wastewater treatment, biowaste treatment, on many farms and for faeces in ten-thousands of applications in South East Asia and elsewhere. The system that is built in Lübeck consists mainly of the following components (Fig. 2):

- **vacuum closets (VC) with collection and anaerobic treatment with co-treatment of organic household waste in a semi-centralized biogas-plants, recycling of digested**

anaerobic sludge to agriculture with further storage for growth periods. Use of biogas in a heat and power generator (heat for houses and digester plus electricity) in addition to natural gas.

- decentralised treatment of grey wastewater in vertical constructed wetlands with interval feeding (very energy efficient)
- rainwater retention and infiltration in a swale system

The heat for the settlement is produced by a combined heat and power generating engine which is switched to use biogas when the storage is filled. Heat is also used to heat the biogas plant. In addition there is a passive solar system to support heating of the houses and an active solar system for warm water production. Figure 2 is not meant for showing all the details but shall give an idea of the concept with collection and treatment of faeces.

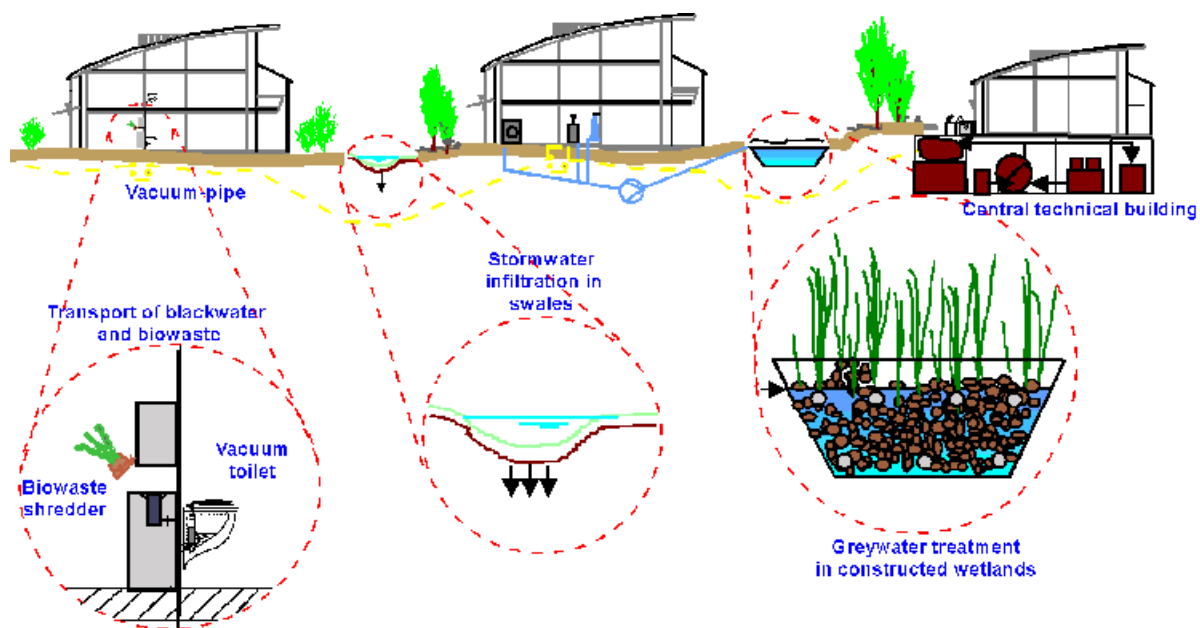

Figure 2: Vacuum - biogas system, greywater bio-filter and rainwater infiltration

At the digester a vacuum pumping station will be installed. The pumps have an extra unit for the case of failure. Pressure in the system is 0,5 bar operating both the vacuum toilets and the vacuum pipes. Pipes are dimensioned 50 mm to allow good transport by the air. They have to lie deep enough to be protected against freezing and must be installed with an up- and down-gradient around 20 cm every 15 meters to create plugs of the transported matter. Noise is a concern with vacuum toilets but modern units are not louder than flushing toilets and give only a short noise. However, people have to get used to it.

Faeces mixed with the shredded biowaste (only blackwater for mixing) are hygienised by heating the feed to 55°C for 10 hours. The energy is further used by the digester that is operated mesophilic at around 37°C with a capacity of 50 m<sup>3</sup>. Another concern is the amount of sulphur in the biogas. This can be minimised by controlled input of oxygen into the digester or into the gas flow. The biogas plant is meant to be a production unit for liquid fertiliser as well. It is important to consider pathways of pollutants from the beginning. One important source for heavy metals are copper or zinc-plated pipes for drinking water. These materials will be avoided and polyethylene pipes will be used. The sludge will not be dewatered for having a good composition of the fertiliser and for not having to treat the sludgewater. The relatively small amount of water added to the blackwater keeps the volumes small enough for transportation.

There will be a 2 weeks storage tank for the collection of the digester effluent. Biogas will be stored in the same tank within a balloon that gives more flexibility in operation. The fertiliser will be pumped off by a truck and transported to a farm that has a seasonal storage tank for 8 month. These tanks are often available anyway or can be built with little investment.

Decentralised treatment of grey wastewater should be done by biofilm or membrane processes. Appropriate technologies would be membrane-bio-reactors or constructed wetlands. These systems form both a barrier against eventual pathogens. Water can be reused in watering the gardens or with infiltration to the rainwater system. Greywater is relatively easy to treat because it has low contents of nutrients. Several projects on technical scale have demonstrated the feasibility and good to excellent performance of decentralised greywater treatment (NN 1999). These plants allow reuse of the water in toilet flushing, what is not economically feasible in the Lübeck project because of the low water consumption of the vacuum toilets. For Flintenbreite vertically fed constructed wetlands with sizes of 2 m<sup>2</sup> per inhabitant are constructed (could be smaller, too). These are relatively cheap in construction and especially in operation. There is a primary clarifier as a grit chamber, for solids and for grease control. First measurements in the effluent have shown very low nitrogen concentrations, however phosphorous was higher than expected. A simple pre-precipitation will be added.

The infrastructure for Flintenbreite including the integrated sanitation concept is pre-financed by a bank and operated by the private company infranova GmbH, where participating companies, planners and the house- and flat-owners are financially integrated and will have the right to vote on decisions. Parts of the investments are covered by a connection fee, just like in the traditional systems. Money saved by not having to construct a flushing sewerage system, by smaller freshwater consumption and by co-ordinated construction of all pipes and lines (vacuum sewers, local heat and power distribution, water supply, communication-lines) are essential for the economical feasibility of this concept. The fees for wastewater and biowaste charged cover operation, interest rates on additional investment and rehabilitation of the system. A part of the operation costs has to be paid for a part-time operator: this also offers local employment. The company cares for operation of the whole technical structures including heat and power generation and distribution, active solar systems and an advanced communication system that is available for the inhabitants.

The material and energy intensity of the structure has been studied by the MIPS-method in comparison to a traditional system at the Wuppertal Institute in Germany (Reckerzügl and Bringezu, 1998). Material and energy intensity is less than half for the decentralised system as for a conventional central system serving a medium densely populated area (see Table 2). For the central system most of the material intensity results from the construction of the sewerage system. The predicted effluent values are based on averages of measurements of greywater. Effluent qualities are presented in comparison to average values of a modern treatment plant with an advanced nutrient removal and good performance.

Source control systems can be considered high efficiency technology. Research on pilot projects will bring more development and show new ways for all the different social and geographical situations of our crowded planet. A somewhat similar approach was installed at the same time in a rural area near Oslo in Norway, where blackwater from vacuum-toilets is collected by trucks and brought to treatment (Skjelhaugen, 1998).

## **6. New types of sanitation in Europe III**

### **'Sustainabilise' existing wastewater infrastructure (up to now theory)**

Urine collection can convert a conventional sewerage system to one with a very high rate of nutrient reuse and very low nutrient emissions. When most of the urine is kept out of the waste-

water treatment plant, nutrient removal becomes obsolete (Larsen and Udert, 1999). There are two basic approaches: Central or decentral (semi-central) collection. The central approach would be to store urine in small tanks and to open them at late night times when the sewerage system is nearly empty. A remote control system would empty the tanks at the respective correct time to create a concentrated flow that can be caught at the influent of the treatment plant (Larsen and Gujer, 1996). This method is limited to sewerage systems with a good gradient and appropriate retention times, however it could be applied to branches of the sewerage system, too. Decentral storage and collection is the other possibility. There is no project yet, but there are certainly many situations where this type of system would be feasible.

If all the blackwater is collected and treated separately, a conventional sewage system can become a greywater recycling plant and produce secondary water. Conversion could be done over decades if necessary. Economics have to be considered well, because except in very densely populated areas rehabilitation of sewerage systems requires high specific investment.

## 7. Risks, obstacles and restrictions

The first objective for sanitation must be minimising hygienic risks. New systems should be better than the conventional sanitation systems, that have a good hygienic standard for inside the houses but in most cases not for the receiving waters.

Sanitation is a very sensitive matter with respect to the strong wish for clean bathrooms and to the taboos around the issue. Failure can be the consequence (and has been in many cases) if this is not considered and included in project development. The issues around new sanitation systems is somehow complex, but they cover an area of basic needs of humans. Not mixing of food and water cycles, returning matter from the land to the land and zero emissions to the waters can be explained to prospective users of new sanitation systems.

Wastewater infrastructure is usually built to be extremely long lasting. This restriction of change seems so overpowering for many people that they can not even imagine different solutions for the future. We have to consider the lifetime of existing house installations, sewerage systems and treatment facilities in order to avoid financial problems. Change is easier for newly constructed settlements or rehabilitation of complete houses. The lifetime of house installation is far shorter than that of sewerage systems. Components of source control sanitation could be installed in each renovated flat and be connected to the conventional systems first. This can be economic with the water saving from the beginning, later after conversion of a group of houses separate treatment can be implemented.

## 8. Welcome the future!

It is quite a challenge to participate in the development of emerging new technology. Professional skills and open-minded search for solutions are needed to find better ways for future sanitation. Open dialogue and exchange of experiences are essential in order to bring the matter forward. There are so many possibilities, that all social and economic conditions can be met. Creativity is needed to find the appropriate technology and the best way of implementing, operating and financing it. There is an extremely strong need for new solutions whether media, politicians and the public notice or ignore it. Even though many industrialised countries will need decades for conversion due to the long lasting existing infrastructure, these countries are the ones with good resources for research and pilot installations.

**References**

- Agenda 21 (1992) The United Nations Program of Action from Rio, United Nations, New York, USA, 1992
- Beck, M. B., Chen, J., Saul, A. J. und Butler, D.: Urban Drainage in the 21st Century: Assessment of new technology on the basis of global material flows, *Water Science & Technology*, Vol. 30, No. 2, 1994, pp. 1-12
- Boisen, Thorkil, (1996) (TU Denmark, Dept. of Building and Energy), *personal information*
- Daughton, Ch.G.; Ternes, Th.A.: Pharmaceutical and Personal Care Products in the Environment: Agents of Subtle Change? *Environmental Health Perspectives*, Vol. 107, Supplement 6, Dec. 1999, pp 907
- Eavans, Richard J. (1987): *Death in Hamburg. Society and Politics in the Cholera-Years 1830 - 1910*, Oxford University Press, Oxford ASIN: 014012473X
- Harremoes, Paul: Integrated Water and Wastewater Management, *Water Science & Technology*, Vol. 35, No. 9, 1997, pp. 11-20
- Hellström, Daniel (1998): *Nutrient Management in Sewerage Systems: Investigation of Components and Exergy Analysis*. Department of Environmental Engineering, Division of Sanitary Engineering. Lulea, Lulea University of Technology.
- Henze, M.: Waste Design for Households with Respect to Water, Organics and Nutrients, *Water Science & Technology*, Vol. 35, No. 9, 1997, pp. 113-120
- Henze, M., Somolyódy, L., Schilling, W. und Tyson, J.: Sustainable Sanitation. Selected Papers on the Concept of Sustainability in Sanitation and Wastewater Management, *Water Science & Technology*, Vol. 35, No. 9, 1997
- Lange, Jörg und Ralf Otterpohl (1997): *Abwasser. Handbuch zu einer zukunftsfähigen Wasserwirtschaft. Pföhren*, Mallbeton Verlag, (revised 2<sup>nd</sup> edition 2000, in german) ISBN 3-9803502-1-5
- Larsen, T. A. und Gujer, W.: Separate management of anthropogenic nutrient solutions (human urine), *Water Science and Technology*, Vol. 34, No. 3-4, 1996, pp. 87-94.
- Larsen, T. A., Udert, K.M.: Urinseparierung - ein Konzept zur Schließung der Nährstoffkreisläufe, *Wasser & Boden*, 51/11, (1999) pp 6
- Manish Tiwari, D.: Rainwater harvesting - Standing the Test of Draught, *Down to Earth*, Vol. 8, No.16, Jan. 15, 2000, Centre for Science and Environment, Delhi, India, pp 30
- NN (1999): Internal report of Technical University Hamburg
- NN (2000): [www.flintenbreite.de](http://www.flintenbreite.de)
- Otterpohl, R. und Naumann, J.: Kritische Betrachtung der Wassersituation in Deutschland, in: Gutke, K. (Hrsg.): *Umweltschutz, Wie? Symposium "Wieviel Umweltschutz braucht das Trinkwasser? September 1993*, Köln, Kirsten Gutke Verlag, 1993, S. 217-233
- Otterpohl, R., Grottker, M. und Lange, J.: Sustainable Water and Waste Management in Urban Areas, *Water Science and Technology*, Vol. 35, No. 9, 1997, pp. 121-133 (Part 1)
- Otterpohl, Ralf; Albold, Andrea and Oldenburg, Martin: Source Control in Urban Sanitation and Waste Management: 10 Options with Ressource Management for different social and geographical conditions, *Water, Science & Technology*, No.3/4, 1999 (Part 2)

- Otterpohl, Ralf, Oldenburg, Martin, Büttner, Sebastian (1999) Alternative Entwässerungskonzepte zum Stoffstrommanagement, Korrespondenz Abwasser (46), Nr.2
- Otterpohl, R.; Oldenburg, M.; Zimmermann, J.: Integrierte Konzepte für die Abwasserentsorgung ländlicher Siedlungen, Wasser & Boden, 51/11, (1999) pp 10
- Pimentel, David (1997) Soil Erosion and Agricultural Productivity: The Global Population/Food Problem, Gaia 6, 1997, no.3
- Reckerzügl, M; Bringezu, St.: Vergleichende Materialintensitäts-Analyse verschiedener Abwasserbehandlungssysteme, gwf-Wasser/Abwasser, Heft 11/1998
- Skjelhaugen, O.J. (1998) System for local reuse of blackwater and food waste, integrated with agriculture; Technik anearober Prozesse, TUHH, Technische Universität Hamburg-Harburg, DECHEMA-Fachgespräch Umweltschutz, ISBN 3-926959-95-9
- Winblad, U.; Kilama (1985) Sanitation without water, Macmillan Ltd, ISBN 0-333-39139-X
- Winblad, U., (edt.) (1998) Ecological Sanitation, SIDA, Stockholm, ISBN 91 586 76 12 0



## Hygienic safety and water-reuse-potential increased by means of bio-membrane-technology

**Prof. Dr. Wolfgang Dorau** Umweltbundesamt Berlin  
Postfach 33022, 14191 Berlin, Germany  
Versuchsfeld Marienfelde, Schichauweg 58, 12307 Berlin,  
Germany

**Dr. Axel Schönfeld** Tambacher Strasse 14b, 12249 Berlin, Germany

### Summary

Bio-Membrane-Technology reveals a large potential of increasing the performance of the purification process of used water, normally marked as sewage or municipal wastewater. Apart from the ecological advantage of discharging better-cleaned effluents into waters, bio-membrane-technology offers a real chance to repeatedly re-use municipal wastewater, thus reducing the demand of drinking or fresh water.

The emphasis of this report does not lie in demonstrating modern technology but in showing, that bio-membrane-technology is the result of both a sharp methodical cut into the technical process structure of the conventional sewage treatment and a decisive cut into hygienic methods of how to characterize and produce hygienic safety. The outcome of this rethinking and restructuring is a combination of the well-known biochemical degradation process with modern membrane filtration technology. The most striking operation of this technology is the introduction of a barrier into the once unhindered, free through-flow of water in conventional sewage plants. This barrier in the form of membranes is impenetrable to all kinds of micro-organisms, whether pathogenic or not, and allows to keep all micro-organisms respectively a far higher amount of biomass in the biological treatment stage in a kind of a cage. Keeping the biomass in a cage-like bioreactor results automatically in an increase in biochemical degradation capacity and degradation stability. The formerly big through-flow tanks convert to smaller, closed bioreactors with far better possibilities to control the biochemical degradation process according to different purification aims. The use of membranes guarantees that all kinds of micro-organisms will be retained, independently of shape, number, chemical, thermal or mechanical stability and resistance to antibiotics, whether known or not known to be in the raw waste water.

In other words: The great achievement of bio-membrane-technology is to establish hygienic safety not by intensive and expensive analytical monitoring and controlling (with limited effect) but by just choosing and operating membranes, that is by choosing a method and by operating a methodically sound technology that is in itself safe, inherently safe. We believe that this kind of treatment structure is essential for every ecosan-like concept that aims at the repeatedly use of limited fresh water resources.

### 1. Introduction

For its programme on improved water use, the international symposium "Ecological Sanitation", convened by the German Institute for Technical Cooperation (GTZ), has coined a new term, "Ecosan", a combination of the words "ecology" and "sanitation". The merging of the two terms

into this new one lets us recognise the GTZ symposium's basic idea that a sustainable water use strategy must fundamentally and irrefutably reconcile the concerns of the natural environment (ecology) and the demand of human beings for sufficient amounts of clean water (sanitation). Since 1989, the former Institute for Water, Soil and Air Hygiene of the German Federal Health Office has been developing and testing methodological and technical modules for an ecosan concept – though not under this term. These will be presented in the following contribution. Following the Institute's integration into the German Federal Environmental Agency in 1994, this work has been continued by the German Federal Environmental Agency.

## 2. Current situation

In spite of all scenarios invoking the increasing shortage of fresh or drinking water in many regions of the world, people's water use habits have changed little to date. Following one-time use, the water is usually discharged into surface waters as dirty, unhygienic waste water, degrading surface waters ecologically and as a potential drinking-water resource. The contamination of surface waters by pathogens of infectious diseases puts at risk their use for bathing just as much as their use for water abstraction or irrigation.

In many industrialised countries waste water is subjected to biological treatment prior to discharge in order to safeguard the ecological functions of the receiving waters by removing at least most of the organic pollution load. The necessary technical input and financial resources are unaffordable for many so-called underdeveloped countries. Yet, if even in countries which practise waste water treatment all the technological and financial resources do not prevent their sewage treatment plants from discharging unhygienic water and thus degrading the hygienic quality of their surface waters, what perspectives remain for countries that are financially weak? "Building even more expensive and larger treatment plants equipped with even more purification stages" cannot be the answer. Waste water treatment priorities in these countries are different. Protection of the population against infectious diseases has absolute priority over ecological water quality control objectives, no matter how necessary these might be.

Draining faecally contaminated sewage away from households and human settlements is always an appropriate and necessary first step from a public health perspective, since it drastically reduces the risk of direct infection. The demand on the subsequent second step, i.e. on the waste water treatment, is that it should first and foremost produce and guarantee hygienically safe water. Purified water has to be free of pathogens, thus ensuring the function of watercourses as a drinking water resource for humans and livestock. As much as conventional sewage plants may help to achieve ecological objectives, their technical structure however makes conventional waste water treatment plants unfit to fulfil this demand. That is why thought must be given to the question of how waste water treatment should be restructured so that it first serves health protection purposes and in addition to it can also integrate the necessary protection of waters. This contribution will show that a sewage treatment of this kind is technically feasible by using membrane filtration and that the use of this technology offers a big potential of progress in water re-use.

The priority for health protection is not an academic question. It is also a question of current interest to Germany. In 1995, the European Commission brought a case against Germany before the European Court of Justice for non-compliance with the EU Bathing Water Quality Directive, and the final ruling in 1999 was against Germany. The main charge in the case was continued non-compliance with hygiene requirements in a number of bathing waters.

The charge brings to light a fundamental shortcoming of the conventional municipal waste water treatment technology as used in countries the world over. The shortcoming is that the conventional mechanical-biological treatment relies on sedimentation to separate biomass from

the treated waste water. Sedimentation principally cannot and does not achieve a complete retention of micro-organisms and suspended solids. The biomass of waste water treatment plants contains a multitude of pathogens from faecally contaminated domestic sewage, which are carried into surface waters together with the non-settled fraction of the biomass. The effluents even of modern conventional WWTPs thus continue to contaminate surface waters with pathogens and consequently are a potential risk to public health.

There is another, indirect health hazard in the non-pathogenic fraction of the biomass that is carried out of sewage plants. Faeces and other excretions are the main carriers of micro-organisms resistant to antibiotics, and of non-metabolised antibiotics from medical treatment and from the use of antibiotics in meat production. The accumulation of antibiotics and antibiotic-resistant bacteria in WWTPs as well as the high biomass densities in sewage plants create favourable conditions for and accelerate the multiplication both of resistances to antibiotics and the development of multiple resistances. As long as biomass is not completely separated from the effluent and as long as sewage sludge is re-introduced into biological cycles through agricultural use, the dissemination and multiplication of resistances to antibiotics via WWTPs will remain uncurbed.

Since Germany and similar countries are not deficient in financial resources and modern WWTPs, the deficiencies in sewage treatment there lie in the treatment methods and, frequently, in the lacking awareness of health protection concerns with regard to sewage treatment. A relatively large percentage of the German population is aware of the pollution mineral oil can cause (1 litre of mineral oil can render 1 million litres of drinking water unusable). However, there is little awareness that with respect to the microbial pollution, untreated municipal waste water has just as high a pollution potential. One litre of biologically treated waste water (conventional treatment) would have to be diluted with some 10,000 to 100,000 litres of pathogen-free surface water to meet the European Union's minimum hygiene requirements for bathing waters. More often than not these conditions cannot be met even in countries with high precipitation. In addition, a question to be discussed is whether regulations like the present EU Bathing Water Quality Directive can guarantee sufficient health protection (see ref. [6]).

Once again the saying proves to be true: dilution is no solution. The deficiency at issue is that "sanitation", or hygiene, or health protection, are aspects which are simply neglected when conventionally treated waste water is discharged into surface waters. This deficiency is not of a technical nature, but is **methodological**.

### 3. Hygienic safety as a basic element of water reuse

When the neglect of health protection concerns has been recognised to be the main deficiency in municipal waste water treatment as practised to date and when this deficiency is to be overcome, some questions must be asked and answered:

- What does hygiene mean in a waste water context? How can it be measured?
- What hygiene-related objectives can and must be pursued to make the hygienically safe re-use of purified municipal waste water possible?
- How can these objectives be achieved? What structural and technical measures have to be taken?

When trying to answer these questions a further important deficiency comes into the open: the lack of criteria to assess hygienic safety resp. the lack of reliable criteria to grade the hygienic status of treated wastewater.

The real target of any technical measure to disinfect waste water is the removal of real pathogenic bacteria, viruses and parasites from the clarified water. However, the true contamination with these pathogenic microbes cannot be measured directly. It is only known from long-time hygienic observations and experience that it is realistic to expect pathogenic microbes in sewage, although unknown in kind and quantity. The common approach of measuring the hygiene status by means of indicator organisms, usually relatively harmless intestinal bacteria, only indicates that the water is contaminated by faeces, which is a truism in the case of municipal waste water. The measurement of indicator organisms delivers no information about the types and quantities of pathogens that can be expected to actually be present at time x and at another time y.

This uncertainty accompanies every step of the conventional mechanical or biological treatment. Even if waste water undergoes an additional chemical disinfection will the real hygiene status of the treated water remain uncertain, if the effectiveness of the treatment is or can be measured only by way of indicator organisms.

Given so much methodological uncertainty, it seems almost presumptuous to demand that waste water treatment deliver hygienically safe effluents. Hygienic safety means nothing less than the virtually complete absence of all micro-organisms in treated waste water, irrespective of the nature and quantity of the pathogens and other micro-organisms it originally contained.

As the uncertainty inherent in evaluating the hygiene status of waste water by means of indicator bacteria is a problem which basically cannot be remedied, we have searched for waste water treatment and assessment methods that guarantee hygienic safety without there being a need to know and measure the extent to which waste water is contaminated by hazardous micro-organisms prior to treatment. The title of this contribution already indicates which methodological approach we have opted for. Based on the results of our analysis of the problem and several years of technical testing, we consider an integrative combination of modern membrane technology and well-tried biological treatment to be the optimal solution (see Figure 1). A detailed discussion of the associated advantages has been given in previous publications (see ref. [9], [11]).

The following discussion is limited to a brief description of the point at which conventional waste water treatment technology is modified and of what an integrative combination of membrane technology and biotechnology, bio-membrane technology for short, should be taken to mean. The methodological weak point of conventional waste water treatment is the incomplete removal of biomass from treated waste water by gravitation or sedimentation. Since bacteria are suspended solids, non-settled bacteria cannot be prevented from continually drifting out of the plant. WWTPs are operated according to the hope principle, meaning their operators can only hope that bacteria do in fact break down the pollutants contained in waste water as much as was determined at the time the plant was designed and that sedimentation is in fact capable of capturing most of the bacteria within the plant. If for some reason they are not willing to degrade and settle as intended there is no barrier to stop contaminations and biomass from floating into the receiving waters. The whole art consists in creating favourable conditions for the bacteria to degrade and settle, however they cannot be forced to do it. That is why the regular outlets of WWTPs always simultaneously function as hidden emergency outlets.

The decisive difference between conventional plants and plants with bio-membrane technology is that bacteria can be forced to stay in the sewage plant completely and that they can be forced to degrade far more than usually - and what is essential too – with a far higher elimination stability. The technical way to retain the complete biomass within the plant is established by immersing membrane filters into the biomass. Membrane filters act as barriers which bacteria are unable to pass (see Figure 2). They are kept in tanks with no regular overflow like in a cage. The rise in degradation performance and stability is an automatic effect as the biomass multiplies automatically and thus moves into a state of severe substrate (food) shortage. To

survive bacteria start degrading even those organic compounds that in conventional plant remain untouched. The absence of sedimentation tanks and the reduction in treatment volume considerably reduces the size of the plants and costs (see Figure 3). As soon as these cost reduction will be higher than filter costs (sinking) bio-membrane technology will have a higher performance in purification and hygiene at lower costs than the conventional treatment. The effect of the complete retention of all micro-organisms results in a very secure retention of all kinds of pathogenic microbes. A more in-depth discussion of the method can be found in the technical literature. In Europe, bio-membrane plants serving a range from household-size (see Figure 4 and 5, decentralised WWT) to up to 30,000 inhabitants have already been built. Larger plants, to serve up to 80,000 people, are under construction or at planning stages.

With this methodological change to waste water treatment we are pursuing three objectives:

Improvements

- to the economics of waste water treatment,
- to the ecological status (protection) of surface waters, and
- to health protection.

The drastic increase in removal efficiency and reliability and the associated hygienic safety should be a requisite element of every concept whose aim is the multiple re-use of purified municipal waste water.

#### 4. Requirements on future municipal waste water treatment

The introduction of the membrane technology should be understood not merely as a technical change but rather it should also be accompanied by a conceptual upgrading of waste water treatment. The present basic waste water treatment concept followed worldwide has been geared to removing individual substances or groups of substances from waste water. To our understanding this substance-by-substance approach is bound to fail as it is connected with an increasing rise in costs of treatment, analysis and monitoring the more substances have to be controlled.

Membrane technology allows to adopt a different approach. Membrane technology is strictly a separation technology. It enables a change to a practice that is focussed on recovering the pure chemical “water”. Customised membranes can be developed to regulate which substances are tolerated to pass membranes together with the chemical “water”, albeit not for all cases. Membrane technology lets us come closer to the objective of transforming waste water **treatment** into waste water **purification**. In common usage, “purification” means making an article fully fit for re-use any given number of times by freeing it from impurities.

Hygiene in the field of water use has a dual nature: On the one hand, significant volumes of high-quality (i.e. pathogen-free) water are needed for personal and sanitary hygiene. On the other hand, by this use these very volumes of water are rendered unusable for any hygienically sensitive subsequent use. If these very same volumes of water were to be returned to the level of purity they originally had in terms of pollutant content and hygiene, we would have a highly productive and available water resource. Bio-membrane-technology offers a big potential in this respect.

Scenarios for the future development of the world population predict that in the not too distant future a large part of the world population will live and work in so-called mega-cities, i.e. in population centres with tens of million inhabitants. This means that large quantities of pure, high-quality water will be needed within densely populated areas and that equally large

quantities of polluted and unhygienic waste water will be generated. To our understanding the future waste water treatment in these mega-cities in particular must have a methodical and technical structure to ensure that water can be re-used repeatedly without posing a risk to public health. The most rigid scenario would be that waste water is directly reprocessed into drinking water (example: Windhoek/Namibia). However, normally and ideally it should be discharged as highly purified (waste) water into watercourses for re-integration until it is again abstracted. At the point of discharge the purified waste water must be as clean as to **improve** rather than to **degrade** the quality of the receiving waters in terms of chemical and microbial pollution, allowing uses throughout its course that demand adherence to high standards of purity and hygiene. Surface waters even in regions with mega-cities would thus become clean enough to be used for leisure and recreation.

Under this concept, waste water treatment is assigned the higher-grade function of a **guarantor of an unrestricted re-use of water**. To fulfil this function, it must achieve considerably higher removal efficiencies and, above all, higher levels of reliability. It cannot be expected that the consistent application of these requirements will result in surface waters remaining crystal-clear throughout their courses. Nonetheless, the introduction of high-purity waste water is a way to compensate for and keep in check unavoidable, quality-degrading diffuse inputs into waters. This concept requires that the greatest part of the treatment effort be transferred to the stage **prior** to re-introduction into watercourse.

Based on several years of experience with the operation of a bio-membrane plant and the understanding of its technical and biological performance we have gained, we have come to the conclusion that the bio-membrane technology should become a cornerstone of a future waste water purification concept – not primarily because it is modern technology but because of its methodical and structural advantages and its potential to solve or at least to ease future water management problems.

## 5. References

- [1] Council Directive 76/160/EEC of 8 December 1975 concerning the quality of bathing water, Official Journal of the European Communities No. L 31, pp. 1-7 (1976)
- [2] Gesetz zur Verhütung und Bekämpfung übertragbarer Krankheiten beim Menschen (Bundes-Seuchengesetz) vom 21.12.1992, Bundesgesetzblatt I, p. 2094
- [3] Jahresbericht 1997, Umweltbundesamt, Berlin, pp. 100/101
- [4] Feuerpfeil, I., López-Piña, J., Schmidt, R., Schneider, E., Szewzyk, R., Antibiotikaresistente Bakterien und Antibiotika in der Umwelt, Bundesgesundheitsblatt-Gesundheitsforschung-Gesundheitsschutz 1/99, pp. 37-49
- [5] Berg, G., Monitoring for Viruses Disseminated in Water, Monogr.Virol., Vol. 15, pp. 17-29 (Karger, Basel, 1984)
- [6] Kay, D. et al., Predicting likelihood of gastroenteritis from sea bathing: results from randomised exposure, The Lancet, Vol. 344, October 1994, pp. 905-909
- [7] Bitton, G., Water and Wastewater Disinfection, in: Wastewater Microbiology, Wiley-Liss, pp. 113-135
- [8] Bitton, G., Pathogens and Parasites in Domestic Wastewater, in: Wastewater Microbiology, Wiley-Liss, pp. 77-100

- [9] Dorau, W., Erfahrungsbericht zum kontinuierlichen Betrieb einer Membranbiologie ohne Überschussschlammabzug, Begleitbuch zur 2. Aachener Tagung, Siedlungswirtschaft und Verfahrenstechnik, 15/16 September 1998, contribution A 11
- [10] Jahresbericht 1996, Umweltbundesamt, Berlin, pp. 89-90
- [11] Dorau, W., Removal of pathogens from waste water effluents by microfiltration technology – Necessity and chances of improving the elimination of pathogens and classical contaminants drastically, European Water management, volume 1, number 2, 1998, pp. 42-52

## 6. Figures

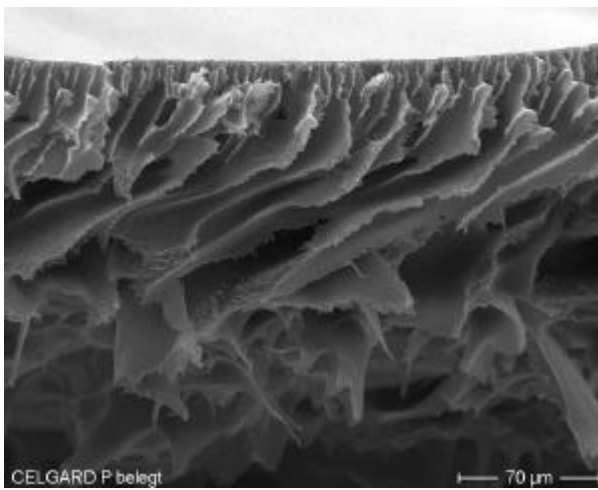

**Figure 1: Electron micrograph of the cross-section of an asymmetrical membrane**

Source: Christian Adam



**Figure 2: Electron-microscopic enlargement showing the surface of a membrane with captured particle (bacterium?)**

Source: Christian Adam

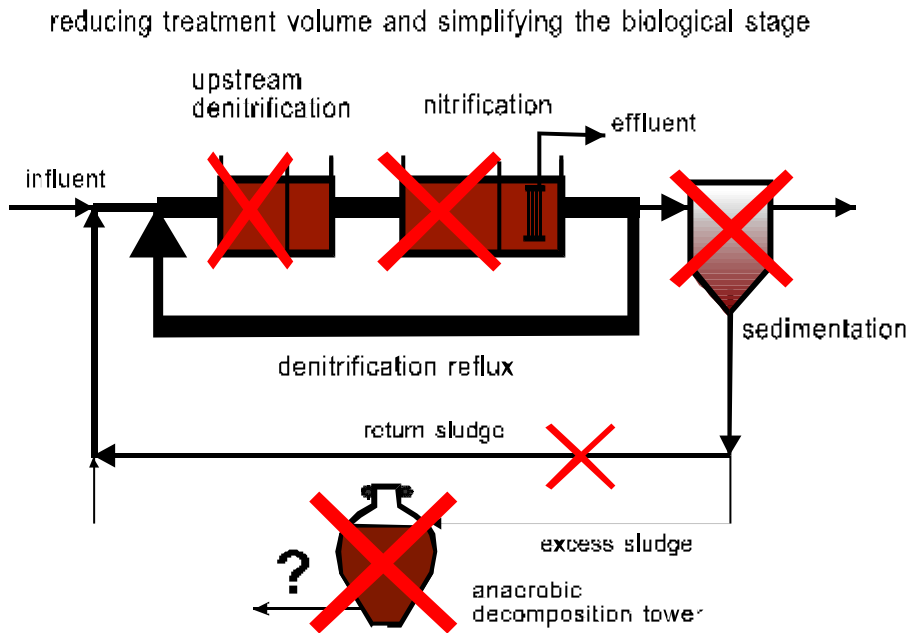

**Figure 3: Reduction of treatment volume of the biological treatment (X marks treatment steps no longer necessary or reduced)**

**function principle BioMIR<sup>®</sup>**

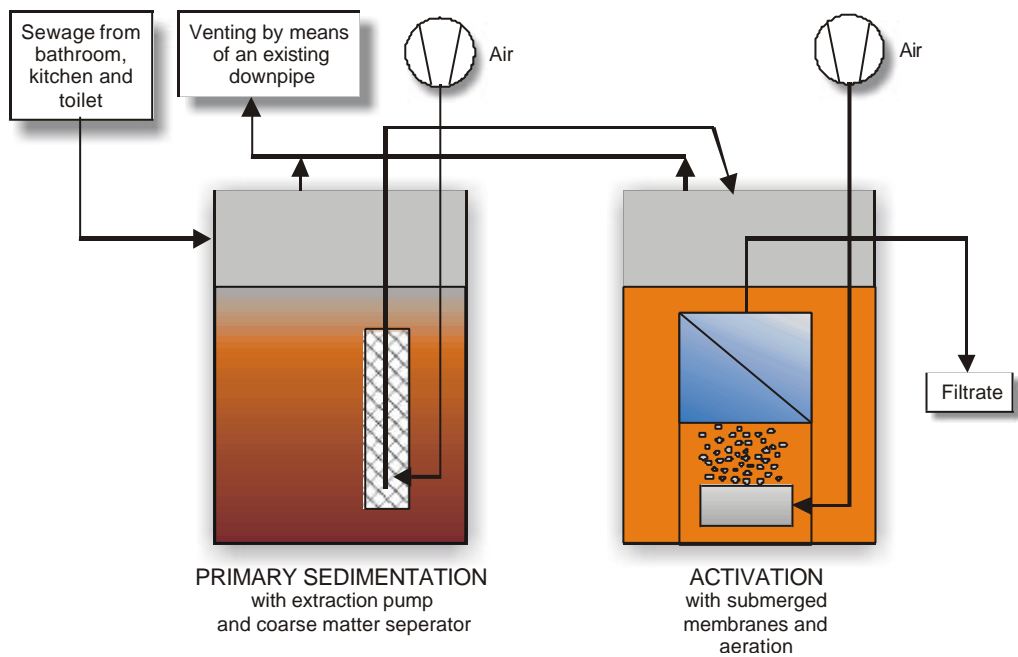

**Figure 4: function principle of private sewage treatment (household-size)**  
(Source: Busse GmbH.)



installation of BioMIR® in the basement

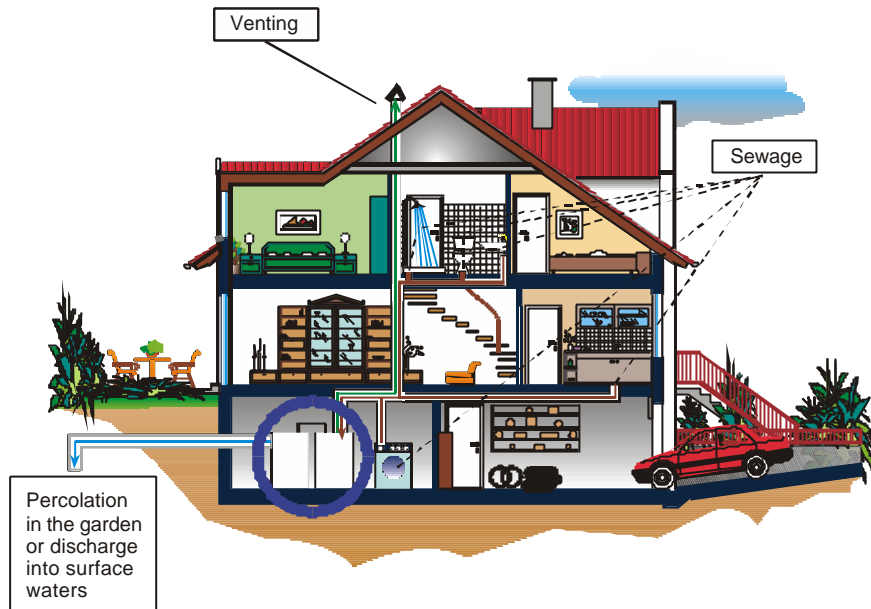
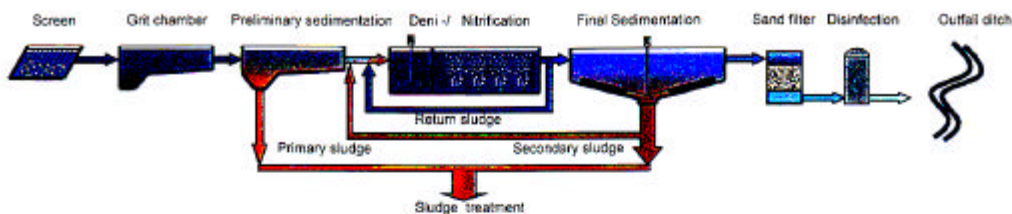
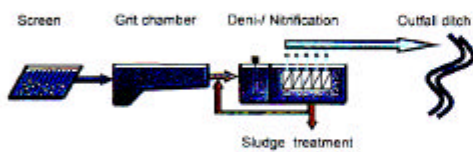

Figure 5: Private sewage treatment applying bio-membrane technology (Source: Busse GmbH.)



Flow chart conventional activated sludge process



Flow chart membrane-biology

The higher biomass concentration, which is achieved by using the membrane filtration as separation process, considerably increases the volumetric loading performance thus saving much of the reaction volume. A suitable choice of the membrane-size-cut enables the process to decouple the hydraulic and substrate residence time. Therefore substances can be eliminated, which are difficult to degrade biologically.

The process units final sedimentation, filtration and disinfection are replaced by the membrane filtration system.

The most important advantages of membrane-biology are:

- Biological cleaning and filtration in one single system
- A high volumetric loading performance allows very compact and space-saving building methods
- Simple extension and enlargement of existing systems
- Release of basin volumes or increase of possible connections without construction measures by 5-6 times higher biomass concentration
- Reduction of biologically difficult degradable substances
- No scum problems
- Very low sludge production by less sludge loading
- Waste water disinfection by retention of germs and virus
- Effluent with service water quality

Figure 6: Comparison of bio-membrane technology / Conventional activated sludge process (Source: Preussag AG)

## AKWA-2100 scenarios of alternative urban water infrastructure systems

**Dr. Harald Hiessl**

Fraunhofer Institute Systems and Innovation Research (ISI),  
Breslauer Str. 48; 76139 Karlsruhe, Germany.

### 1. Introduction

In Germany as in other industrialized countries urban water supply and wastewater systems have been build and operated for more than 100 years. Several times these systems have been adapted to changing needs and requirements. However, there are numerous reasons for a re-assessment of these structures and their basic technological concept:

- For example, substantial investments are needed to repair, rebuild, extend existing urban wastewater systems in Germany over the next 15 years. Estimates are that 13 Bill. DM/a are required. Additionally, 11 Bill. DM are necessary for operation and maintenance of these systems annually.
- Of the overall expenditures for urban wastewater systems in Germany on average 80 % is brought up for the collection and only 20 % for the treatment of municipal wastewater.
- Increasing emission and immission standards, as they result from the new European Water Framework Directive will require substantial additional investments of largely unknown height in wastewater treatment.
- Finally, more and more substances like pharmaceuticals and their metabolites, antibiotic and endocrine substances are finding their way into the wastewater. Since the present treatment technology can not handle these pollutants, new treatment technology are required to protect our waters, the aquatic habitats and ourselves from chronic damages. There are no estimates about the financial needs, but they probably will be considerable.

Summing up, this means that in Germany we will make substantial investments in our urban sanitation systems during the next decades. Before investing large amounts of money into today's 100 year-old urban sanitation concept it is high time to step back and to explicitly identify the basic choices and long-term options available to handle urban water problems in a sustainable way. Independently of the final decision about the options to be implemented good decisions are characterized by being able to choose and a clear expression of the set of criteria used to assess the alternatives. That is what AKWA-2100 is all about.

### 2. Goals of AKWA-2100

AKWA-2100 is an ongoing pilot-project. Its overarching goal is to identify long-term strategic options and concepts for urban water infrastructure systems in Germany which contribute to a sustainable development. The primary interest is to conceptualize options especially for re-developing sanitation systems in already existing urban areas and not so much for systems to be build on green fields during the development of new areas.

Since the local characteristics and circumstances are the most important determinants for urban sanitation systems AKWA-2100 is build around two case studies. These are the water

infrastructure systems of Asseln, a suburb of Dortmund, and of Bork, a suburb of Selm two municipalities in the state of North-Rhine Westfalia, Germany.

Members of AKWA-2100's interdisciplinary project team are the two municipalities of Dortmund and Selm; the Emscher-Genossenschaft, a regional wastewater board; the Department of Economics and the Department of Civil Engineering of the Ruhr-University Bochum; the Institute of Sanitary and Waste Engineering of the Technical University of Aachen; the Fraunhofer Institute of Systems and Innovation Research (ISI) in Karlsruhe; Stein & Partners, an engineering consulting firm. Project partners from industry are Hochtief, an international construction company; Roediger, a manufacturer of vacuum technology; and Munters Euroform, a manufacturer of water treatment components.

In AKWA-2100 the scenario approach as it was advanced by Schwartz (1991) is used to develop long term alternatives because scenarios are especially suited to deal with complex planning situations and high degree of uncertainties as it is the case for urban water infrastructure systems. Such situations can be characterized as follows:

- A large number of actors / stakeholders is involved.
- There are various pervasive uncertainties involved: For example the uncertainty with respect to future goals and objectives of the various actors or the uncertainty with respect to future technological, social, economical etc. developments.
- The future consequences of today's decisions are hard to diagnose.
- Decision makers are often restricted in their scope although
- there are complex interactions of a multitude of spheres of life to be considered.
- For various reasons they also show a tendency to be „short sighted“ with respect to time.

The scenario approach helps to deal with these difficulties constructively. It stimulates the imagination of those involved, provide a common language for multidisciplinary teams, supports a shared understanding of the problem under research by structuring the group thinking processes in the interdisciplinary project team, and finally it enables the appropriation of the results by the decision makers.

### 3. The AKWA-2100 scenarios

In AKWA-2100 three generic scenarios of alternative urban water infrastructure systems were developed. They are called “Continuation”, “Municipal Water Reuse”, and “Local Recycling”. Due to the long lifecycle of water infrastructure systems of 50 and more years it is essential to take a long-view in the AKWA scenarios, too. Therefore, the year 2050 was selected as time horizon for the scenarios knowing that there will be no steady state and the only constant is change.

In the following a brief outline of just the major technical aspects of the 3 generic scenarios will be given. The institutional, organizational, and the other non-technical aspects associated with the scenarios not explicated due to space limitations.

The “**Continuation**”-scenario is a direct descendant of today's system. It preserves the two basic characteristics of today's system, the combined sewer concept and central treatment plant. In this scenario the water consumption of the private households - which is completely supplied with drinking water quality - is reduced to 100 Liter per person and day (l/p/d) through standard application of water efficient fixtures and appliances. Potable water, in this scenario, is still supplied through by a central water supply utility.

Further, in industry freshwater consumption and wastewater discharge to the public sewer systems have been strongly reduced. This was possible through adoption of the eco-efficiency paradigm by the industry which led to a systematic substitution of water and the application of highly water efficient process technology and a high degree of water reuse in water using processes. This was made possible through membrane technology, which has gained substantial application in all fields of water and wastewater treatment. Especially in industry this technology allowed a high degree of reclamation and reuse of process water as well as the recycling of valuable resources in the wastewater. In public sanitation membrane technology became an important treatment technology, too. Co-fermentation of sewage sludge and organic wastes became a standard.

About 30 % of the rainfall runoff are now uncoupled from the combined sewer system either by direct on-site infiltration or by collection in a storm sewer system with appropriate treatment and direct discharge to receiving waters.

The second scenario is the „**Municipal Water Reuse**“-scenario (Figure 1). It represents a fundamental extension of today's sanitation system. In this scenario the various urban water streams are managed much more separately than in the “Continuation”-scenario. Storm water is collected and managed separately from sanitary wastewater. Further the sanitary wastewater is deprived from its nitrogen load through separation of the “yellow” fraction (urine).

**Figure 1: The AKWA-2100 scenario “Municipal Water Reuse”**

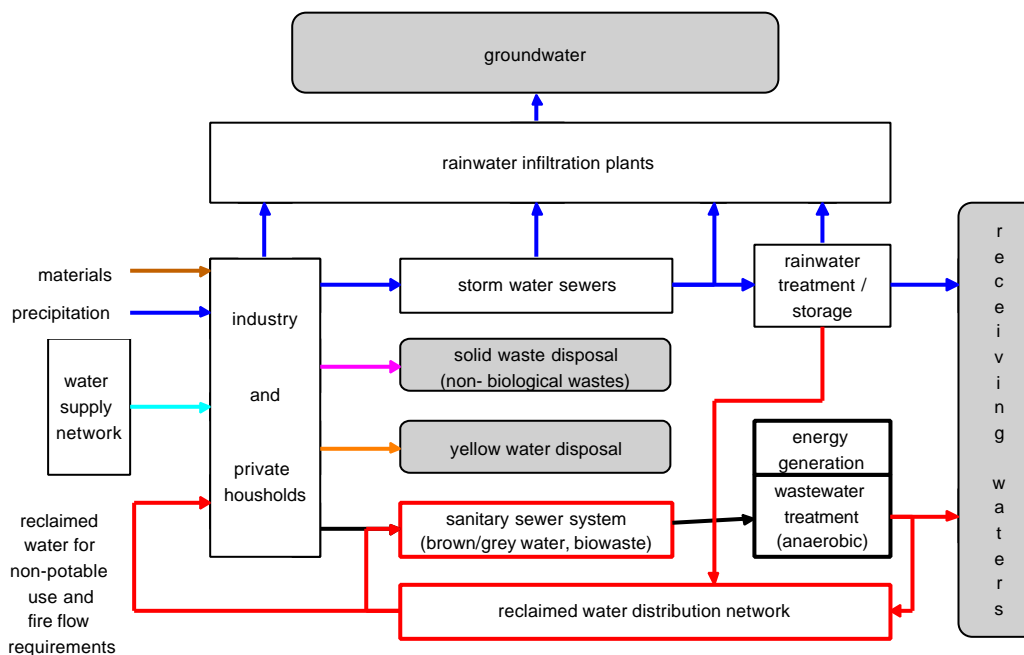

The sanitary water is treated and disinfected to very high standards in the central wastewater treatment plant using membrane and anaerobic processes. But instead of discharging the treated wastewater to receiving water bodies, the water is primarily reclaimed for non-potable uses. It is distributed through a dual distribution system. The most important non-potable uses are requirements to provide continuous flushing of the sanitary sewer, fire requirements, and non-potable uses in industry. Continuous flushing of the sanitary sewer made it possible that solid bio-wastes from households can be discharged together with the sewage (brown and gray water) into the sewer system without the risk of sedimentation and clogging. This not only made

the bio-garbage bin superfluous and improved the handling of bio-wastes in private households but the high-in-Carbon wastewater is ideally suited for anaerobic treatment in the central treatment plant. The biogas is used for energy generation (and in an increasing amount it is converted to methanol by the use of special catalysts). Since – as in the “Continuation”-scenario - the sewer systems only receives minor amounts of industrial wastewater, the sludge are ready for agricultural reuse (and thus for recycling of C, P, and N).

The “yellow water” fraction (only the urine) from private households is separately collected on-site and periodically collected through a truck-based collection service. The yellow water is used as raw material for industrial fertilizer nitrogen production.

Where possible, the storm water is used on-site for non-potable purposes or is directly infiltrated into the ground water. If this is not possible due to unfavorable hydro-geologic conditions the storm water is collected in storm sewers and, if necessary, treated in special semi-decentralized treatment systems. The storm runoff is reclaimed as complementary supply source for the non-potable water system. The excess is discharged into receiving waters or infiltrated into ground-water in semi-decentralized infiltration systems.

The use of water efficient fixtures and appliances has reduced the water consumption to 90 l/p/d with 60 l/p/d of potable and 30 l/p/d of non-potable water. Due to the continuous flushing of the sewer system the water consumption of the household appliances and fixtures is no longer key to the functioning of the gravity sewer systems. This spurs innovations in improving the water efficiencies of these appliances and fixtures. Potable water is still centrally supplied.

The third scenario is called “**Local Recycling**”. It differs most radically from today’s systems. There is neither a central water supply nor a central wastewater infrastructure system. Individual houses or groups of houses provide their own water supply and wastewater systems based on on-site treatment technology which heavily relies on membrane technology.

Rainfall provides the source for potable water supply. The systematic separation of the various water and wastewater streams enables highly efficient treatment processes and opens the way for reclamation and multiple cascading reuse of water of various qualities. Using water efficient fixtures and appliances the fresh-water input is reduced to 40 l/p/d and the total water consumption of the all the various qualities is 70 l/p/d.

As in the “Municipal Water Reuse”-scenario yellow water is collected as raw material collected by vacuum technology and treated in bio-digesters available for groups of houses.

Presently, the generic scenarios are specified and adapted to the local characteristics of the two pilot-municipalities and are assessed with respect to their sustainability. For the assessment of the scenarios a criteria system was developed in which the overall goal of sustainability is broken down in sub-goals of (micro- and macro-) economic, social, and ecological aspects. The sub-goals are again split further into a number of objectives and indicators that can be measured and used to compare the scenarios. This multi-criteria problem is tackled using the Analytic Hierarchy Process (Saaty, 1990) both, for the design of the criteria system and to actually develop the ranking of the scenarios with respect to their sustainability.

In the next step, the site-specific scenarios together with their sustainability assessment will then be presented to representatives of the two cities’ decision making bodies who will select one scenario for further elaboration in the second phase of the project. The elaboration will not only cover a more detailed technical specification of the scenario for the specific conditions in the pilot communities but also cover the development of a transition strategy from today’s sanitation system to the one described in the elaborated scenario. The elaborated scenarios will then be re-assessment with respect to their sustainability. They will provide a long-term vision of the urban water infrastructure system for the municipality and support the long-term planning in the cities.

The project will be finished in October 2001. Further information can be found on the project's web-site at <http://www.akwa-2100.fhg.de>.

#### 4. Summary and conclusions

Since AKWA-2100 is an on-going project no final conclusions can be provided, yet. However, some preliminary conclusions regarding usefulness of the scenario-approach can be given here.

In AKWA-2100, the scenario approach was very useful to structure the group thinking processes within the project team. Since it stimulated the imagination and provided a common language the approach contributed much to a shared understanding of the members of the project team, who are very diverse in terms of background and experiences. The scenario approach was instrumental in identifying the large number of technical as well as non-technical elements and driving forces shaping our future and the future of sanitation. The scenarios helped to integrate these into coherent alternative visions and to illustrate the vast spectrum of options available to fundamentally innovate our urban water systems facing the imperative of sustainable development.

#### 5. References

- Saaty, T. L. (1990): Multicriteria Decision Making: The Analytic Hierarchy Process. RWS Publications, Pittsburgh, PA, 1990.
- Schwartz, P. (1991): The Art of the Long View. Currency Doubleday, New York, 1991.

#### Acknowledgement

The AKWA-2100 project team gratefully acknowledges the funding of the project through the WestLB Foundation "Future North Rhine Westfalia" in Düsseldorf, Germany.



## Minutes of the plenary discussion <sup>1</sup>

### Discussion following the contribution by Steven Esrey: Towards a recycling society ecological sanitation - closing the loop to food security

- L.M. Austin: I'm worried about the recycling of Ecosan products in urban agriculture. Our own analyses of toilet and septic tank contents show that it is very difficult to destroy pathogens. Dehydration does not lead to stable hygiene; after 10 months, the residue still contains live pathogenetic organisms. Is there any new insight available in this area?
- Steven Esrey: Well, studies conducted in Sweden, China, Vietnam and Mexico indicate that it actually can work. If the pH is above 9 or 10, the pathogens die off within six months. It all depends on which kind of ash is used to raise the pH. Wood ash is better than coal ash, and soil is rather unsuitable. There is still a lot to learn about such aspects.
- Miguel Lopez: What part is Ecosan playing in the USA?
- Steven Esrey: Ecosan is not very widely disseminated in the USA, but some work is being done on the subject – particularly out West, where water is scarce and it is easy to get people interested. But there is still a long way to go.
- Wolfgang Dorau: Right after the war, there were some very tightly closed loops. Ecosan is a question of remembering, not of researching. The real problem in the implementation of closed-loop concepts is how to adequately account for the human factor, i.e., for people's lack of knowledge about pathogens.
- Steven Esrey: We now have more and better know-how, but if that know-how is not properly applied, good intentions actually could result in the spread of parasites. Different industrial designs are needed.

### Discussion following the contribution by Himanshu Parikh: Slum networking – using slums to save cities

- Bernd Schönwald: What kind of technical solutions are there? Do they involve piping? How is sewage being disposed of?
- Himanshu Parikh: The customary type of sewers are in use. In the first few projects, however, most of the associated sewage treatment plants did not work. This approach is less expensive than standard systems, though, because it exploits natural gradients. New sewage treatment plants include a root zone, and the clarified water is being put to agricultural purposes. Alternatively, root systems serving roughly 100 households each are being installed along the banks of rivers.
- Stefan Behnke: You say they exploit natural gradients, but what happens in level areas?

<sup>1</sup> Minutes taken by Frauke Kebekus



- Himanshu Parikh: Very few cities are really flat and level, because they never could have developed in such places. No one would ever found a city in a place where it would drown in its own sewage. Cities are just "naturally" built on slopes.
- Madeleen Wegelin-Schuringa: How do you ensure that the communities cooperate?
- Himanshu Parikh: International agencies often cooperate with their partners indirectly by way of various communication levels. The longer the path of communication, the more the project suffers from bureaucracy and corruption, so that less and less aid ever arrives at its actual target destination. You have to show the communities that change is possible. Women are an important target group. You have to approach the communities directly, with no go-betweens, and work together with NGOs.
- N.N. a) The results look good now, but what will things be like a few years down the line?  
b) How about hygiene and health problems along the rivers?
- Himanshu Parikh: *re a)* Before we can appraise the extent of a project's success, we will have to gather some pertinent experience. A project can be considered sustainable, if the local responsables are still running it successfully and on their own after five or ten years. Distributed control also makes management more successful.  
*re b)* A total lack of sewage disposal is still commonplace, but ongoing projects have dramatically improved the health situation.

**Discussion following the contribution by Roland Schertenleib:  
The Bellagio Principles and a household centered approach in environmental sanitation**

- Manfred Matz: I disagree with the contention that the approach can be applied to each and every political system, because it is very participative by nature. In many countries, no bottom-up approach is possible.
- R. Schertenleib: I share that opinion. In some formerly socialist countries, for example, there is a widely held view that the state solves all problems.
- N.N. : "Economic security" is just as important as "ecological sanitation". It is important to understand the respective system of values.
- Lukman Salifu: Water is life. Sanitation is frequently a secondary consideration, because poor people are often exposed to enormous pressure. In Ghana, for example, poor people have to pay four times as much for water as do those with a mains-water connection. HCES requires lots of communication.
- R. Schertenleib: The underprivileged often have to pay more than the overprivileged. It is important to get the people involved and find out what they want. The consequences have to be made clear to them, and alternative financing models have to be devised to cover the costs. The people keep their homes clean, but the "nobody's areas" keep getting dirtier. One has to talk to the people and ask them how much they are willing to contribute.
- Paul Calvert: Consider this encouraging statement: In India, there is a "people planning process" that gives the communities lots of influence. The five-year plan

makes mention of 150 well-functioning compost toilets as an alternative for rural areas. That is a heartening fact.

R. Schertenleib: The next important step is urban sanitation.

**Discussion following the contribution by Uno Winblad:  
Development of eco-san systems**

Lukman Salifu: What kind of ashes are being added? The availability of ashes is a very important factor for the applicability of Ecosan.

Uno Winblad: Coal ashes are used in China, and lime, soda, etc., serve as substitutes. Soil can only be used as a cover material, because it does not raise the pH.

Wolfgang Berger: Once, when I was building compost toilets for 250 people in an urban area, the question of permits for gray-water treatment proved problematic. In Germany, unfamiliar approaches engender lots of misgivings.

Uno Winblad: Legislation is an important point.

Lester Forde: I cannot imagine how Ecosan could be expected to work in large units. I see numerous practical difficulties looming in urban areas. Until now, only few isolated cases have been attempted.

Uno Winblad: Many questions simply cannot yet be answered. It's a matter of trial and error.

**Discussion following the contribution by Ralf Otterpohl:  
New developments of ecosan in Germany and Europe**

Miguel Angel

Lopez Zavala: How can gray-water treatment be carried out in limited areas?

Ralf Otterpohl: Wetlands require little energy and offer high quality, and membrane technology can serve as an alternative approach.

N.N : The question of cost comparison between conventional and alternative systems.

Ralf Otterpohl: Alternative systems are still more expensive, because they are limited to pilot projects, and there is accordingly little economy of scale in the production of components. The main cost factors, however, are the construction and maintenance of the sewage network. The plant in Lübeck was just as expensive as a conventional type.

Sven

Ingvar-Nilsson: (... reported, in supplementation of Mr. Otterpohl's contribution, on a successful project in Sweden, where 32 toilets were installed in a two-story house.) Different ways of separately collecting yellow water and of dehydrating faeces were used, so no brown water is generated.

**Discussion following the contribution by Wolfgang Dorau:  
Hygienic safety and water-reuse-potential increased by means of bio-membrane technology**

- Ralf Otterpohl: Membrane technology improves the quality of treatment. The problem is, soluble pollutants can pass through the membrane filter, even in the case of nanofiltration.
- Wolfgang Dorau: Microfiltration holds back bacteria, so that a very dense accumulation of biomass collects in the reactor, and the adsorption potential increases as a result. This gives rise to an internal barrier that traps viruses. In an ultrafiltration setup, the membranes themselves hold back viruses.
- Helmut Lehn: Bio-membrane filtration is one way of treating wastewater. However, the combined sewer overflow from the storm-water outlets in the water-carriage system is one of the main sources of bacteria.
- Wolfgang Dorau: Nor is it a very good idea to pass so much water to the sewage treatment plant that the combined water overflows. In one town of 11,000 near Leipzig, where stormwater and sewage are both conducted into the sewage treatment plant, there is only one distributing tank for equalizing the load. That lowers the cost of the membrane.

## **3 Parallel Sessions**



## Parallel Session 1

# Options and limitations for the application of recyclables; agricultural needs, hygienic and economic aspects

**Key Question:** “How can we focus new sanitation strategies on the agricultural context?”

**Moderators:** **Dr. Steven Esrey** (Unicef, USA)  
**Christine Werner** (GTZ, Germany)

## Lectures

### **Production of fertilizer water from wastewater**

Armin Rettenberger, Prof. Dr. Peter Kunz (University of applied Sciences of Mannheim, Germany)

### **Participatory hygiene and sanitation promotion in ecological sanitation in Zimbabwe**

Cleophas Musara (Mvuramanzi Trust, Zimbabwe)

### **Urban farming and ecosanitation: Nigerian experience**

Prof. M.K.C. Sridhar (University of Ibadan, Nigeria)

### **Possibilities and limits of wastewater-fed aquacultures**

Dr. Ranka Junge Berberovic (University of Wädenswil, Switzerland)



## Production of fertilizer water from wastewater

**Prof. Dr. Peter M. Kunz /** University for Applied Sciences Mannheim  
**Armin Rettenberger** Institute for Biological Process Engineering  
Windeckstr. 110, 68163 Mannheim, Germany

### 1. Background

The Institute for Biological Process Engineering is mainly working on sustainable production procedures as well as developing waste- and waste water-treatment-strategies.

So today an idea is shown to produce fertilizer water from waste water.

In many dry regions in the world waste water is used for watering parks, gardens and fields because of the scarcity of water.

This contains advantages but also disadvantages.

The disadvantages are:

1. The danger of the spread of illnesses and epidemics by pathogenic germs.
2. Heavy metals in waste water are available for plants.
3. It can result an unpleasant odour because of the anaerobic disintegration of hydrocarbons.

The advantages are:

There are also fertilizing substances like nitrogen and phosphate in the waste water.

So this project goes a new way:

Instead of „cleaning“ the waste water we only transform the unwanted substances, to avoid the problematic aspects of waste water irrigation and nevertheless to use the fertilizing substances.

### 2. Aim of the project

The aim of the project is to show that it is possible to produce a fertilizer water with the quality of bathing water in watercourses with the regard to pathogenic germs. This depends on a directive of the european union (EU: 76/160/EWG).

Detailed aims:

1. The human pathogenic germs have to be reduced widely.
2. Havy metals have to be transformed in a form which is not available for plants (anaerobic precipitation by sulfide).
3. Fertilizing compounds have to be received.

Limit: Indeed there is a limitation of the process by high salinity of the waste water.



### 3. Technical details

The concept is a double staged procedure:

In an anaerobic stage (1.stage) the number of the human pathogenic germs will be reduced at temperatures over 42°C.

For testing the system here in germany this reactor is heated by a gas-heating-system.

In place, that means in a dry area, where we have sufficient solar energy, it will be heated solarthermic.

The heavy metals will be immobilized through a quantitative precipitation by sulfide, so that they are no longer available for plants.

This is a usual process for treating industrial waste water with high contents of heavy metals.

Therefore we are trying to immobilize desulfuricant microorganisms on a carrier material inside the reactor.

In the following step the waste water is distributed over a compost filter (2.stage→aerobic) in which the germs will be decreased as food of higher evolved microorganisms through the food chain.

They also will be reduced mostly in an aerobic thermophilic environment.

Organic carbon will be converted into humic acids and carbon dioxide.

Organic nitrogen and urine will be partly oxidized into nitrate and phosphate survives.

The compost filter has to be taken out from time to time for composting it completely. So the compost can be utilized agriculturally.

The half-technical plant is built up on a trailer for making it possible to demonstrate the process in any place.

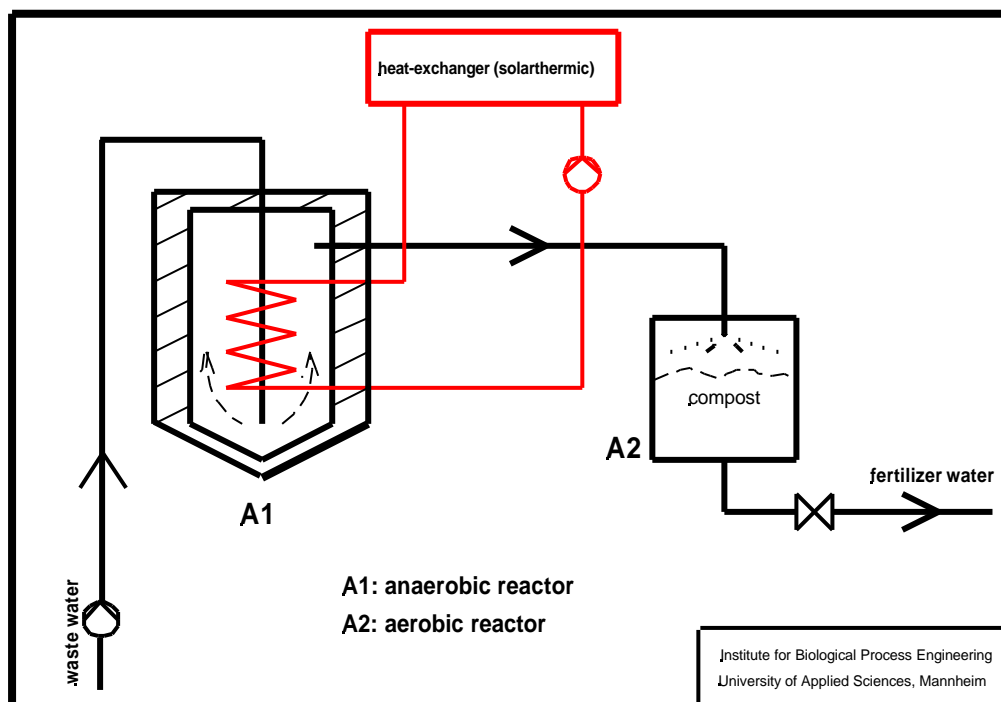

#### 4. Results

There will be shown some results since the start of the project.

Tested materials for the aerobic reactor: hay, straw, hackled rinds of trees, sawdust.

Results for sawdust:

The time of residence depends on the porosity, the height of the material and not at least on the surface load.

We grew up desulfuricant microorganisms to test the capacity of sulfate-reduction, which is the main step for the precipitation of heavy metals.

Depending on the mass of sulphate in the reactor there can be a limitation of the sulphate reduction.

So now we know the range where we can work with the reactor.

By domestic waste water we are working in this range.

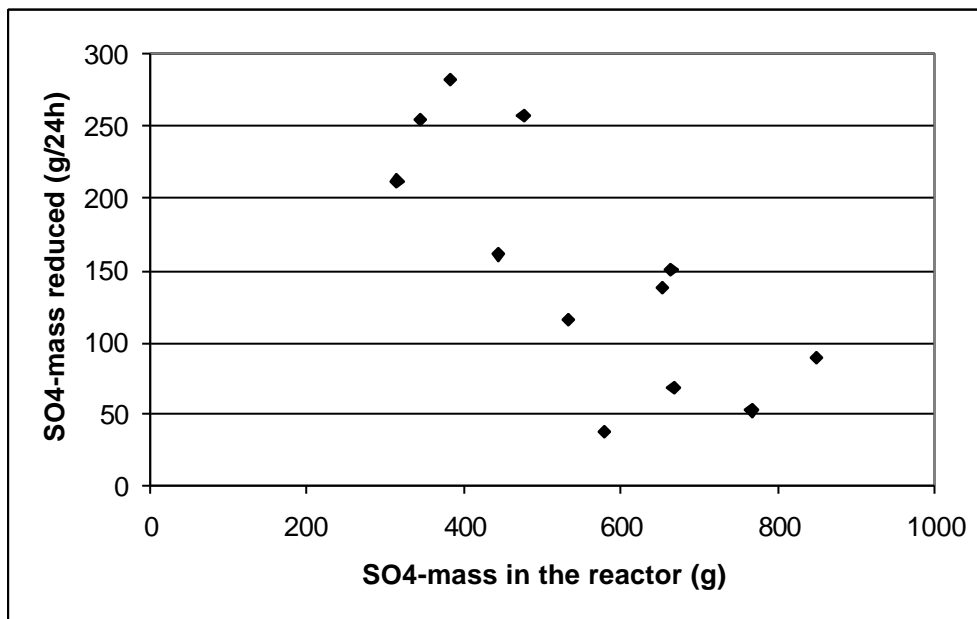

#### 5. Future planning

At the moment the mobile plant is placed on a waste water treatment plant in the south of Germany.

During this winter it will be tested under real conditions, what means that a typical domestic waste water is treated by this system.

There we will be checking out the possibilities and the limits of the procedure.

Depending on the results, modifications will be done.

The next important step will be to find a cooperation partner in an arid area in the world, where we can demonstrate the use of this production procedure.

## Participatory hygiene and sanitation promotion in ecological sanitation in Zimbabwe

**Cleophas M. Musara**

Health and Hygiene Promotion Manager  
Mvuramanzi Trust, P.O.Box. MR 103  
Marlborough, Harare, Zimbabwe

### Abstract

Ecological sanitation in Zimbabwe introduced a cultural change, where communities have always regarded human urine and faeces as a waste fit to be thrown away. For people to change and regard it as a resource and a worthy recyclable product is a process which had to be handled with care.

It was through the use of participatory methods at the beginning of the project, during the implementation phase and demonstrations that carried the day for its acceptability, use and maintenance of technical options in ecological sanitation. Hatcliffe Extension, where the experiment is taking place, had social and political instability as these people come from different areas of the country and are in that area due to different circumstances. The task of the software approach was to create a coherent group, make the group establish a common interest and facilitate them to plan and manage the project for their common good. The process involved, team building exercises, problem identification, analytical, planning and behaviour change tools. The process was to address their fears and change them into hopes and challenges.

This community of about fifteen to twenty thousand people were using five communal VIP latrines that were difficult to maintain and over-used. These latrines were placed on one side of the settlement rendering them impossible to use at night and also by children. The majority of the people then resorted to using plastic bags or buckets at night then either pour the waste in the VIP latrines in the morning or just make slurry by adding water and dump on open ground. Children were just defecating on the open ground. Mvuramanzi Trust was then requested to come up with intervention strategies to improve the above-mentioned scenario. The technologies chosen were the Fossa alterna and the sky-loo, some of the methods chosen to promote the concept of ecological sanitation in Zimbabwe.

### Scope

The intervention in this peri-urban informal settlement (Hatcliffe Extension) had a number of studies that were complimenting each other to solve a particular problem. Other studies include the human and environmental health implications of recycling human waste as a fertilizer and soil conditioner, the nutritive value of faeces and urine and how best to apply them to the soil and on which plants. One of the studies examines attitudes, behaviour and practices towards ecological sanitation and human waste. The purpose of the software approach in this project is to facilitate all the studies to take place and to move communities towards active participation in decision making on technical options, use, maintenance and self-replication of the system.

Hatcliffe Extension was then made a pilot study on this participatory hygiene and sanitation promotion approach. The approach is based on the SARAR concept.

The SARAR concept thrives on the principles of non-directive, non-prescriptive, developmental, learner-centered based on people's ability to analyse their situation, make decisions on problem solving and action planning.

To achieve the above mentioned principles we had to use creative, investigative, analytical, planning, informative and monitoring and evaluation methods in a participatory manner, which included team building, establishing community institutions, investigation and problem analysis and the use and upkeep of the technology.

Once the community accepted the ecological sanitation concept we quickly went into strategies for its proper use and hygienic considerations. To achieve this, two strategies were adopted; one was to identify local educators who could be given intensive training on health and hygiene promotion and two, to give mass education and demonstrations for action in ecological sanitation development. We again let the sections to select their own cadre to be trained as an animator, a person they will respect. The group of five animators and five section secretaries were then given an intensive participatory hygiene and sanitation education. Tools used were, identification and blocking the faeco-oral transmission routes, three-pile sorting of hygienic practices, the sanitation ladder, community mapping of ecological sanitation latrine coverage, social drama, story with a gap, diarrhoea child and task target analysis just to mention but a few. These are pictures that depict different health and hygiene issues relevant and appropriate to that community. The discussion brought about by the pictures increase community awareness and level of articulating issues affecting them. The education was then extended to the community through these trained local people as well periodic section to section sessions. A clean up campaign was then organised by the development committee to clean the open spaces, the water points and the kitchens. This was done to compliment the ecological sanitation promotion taking place as well as to remove those plastic bags and children's faeces lying all over the camp. The issues of putting soil and ash after every visit to the latrine and of putting leaves or grass every week were discussed in these sessions and demonstrations of proper use done at family level.

## Results

- The majority of the community accepted the fossa alterna and the sky-loo latrines and the construction was done with their active participation.
- The latrines are being properly utilised with 100% (39/39) indicating that they pour ashes and soil after every use from a survey carried out 4 to 6 months after installation of the latrines.
- From the same survey, indications are that, the majority understands why they have to pour ash or soil with 84.6% saying it was to reduce fly breeding and the rest saying it was to make the latrine smell better, to help to reduce excess moisture and to help to make compost.
- Their reaction to the composted material and its reuse in agriculture was positive with maize, beans, tomatoes, flowers etc being planted in the soil placed on top of the used fossa alterna pit and in plastic bags from the sky-loo. After removing the contents they also wanted to start tree planting.
- The development committee has been taking different visitors around the settlement explaining what they have been doing, not what the Trust has done, showing that community empowerment through participatory methods will make or break the ecological sanitation promotion.

However the concept of ecological sanitation has only recently taken root in the peri-urban and rural areas in Zimbabwe and a great deal more is to be learned about reuse, composting and safety of the products. Research projects are ongoing including the development of participatory hygiene and sanitation education methods and materials.

## Urban farming and ecosanitation: Nigerian experience

**Prof. M. K. C. Sridhar**

Division of Environmental Health, College of Medicine,  
University of Ibadan, Ibadan, Nigeria

### Introduction

In a developing country like Nigeria, urban low-income communities resort to alternate income generation activities to alleviate their economic hardships. Urban farming is convenient and viable for those who live in high density areas closer to water sources. The same water source is used for domestic and drinking needs, waste disposal, and for the farming activities. This practice is more pronounced in major cities such as Lagos, Ibadan, Kano, Kaduna, and Port Harcourt to name a few among more than 100 designated urban centres in the country. The driving forces for urban farming are the availability of water, plant nutrients and land. The advantages of urban farming are low investment, ease of cultivation usually by the immediate family, and readily available market for the produce. The polluted waters commonly used for irrigation also provide sufficient nutrient inputs for the crops to flourish. Health and hygiene are not considered as vital factors as long as the income is assured.

Data has been collected over a period of time from various urban centres from the States Akwa Ibom, Delta, Kaduna, Kogi, Lagos, Ogun, Ondo, Osun,, Oyo, and Rivers. The information gathered include the nature and magnitude of urban farming, the factors that attract the urban dwellers for farming, the quality of the waters used in urban farming, the inputs on the farms, the quality and hygienic conditions of farm produce, and the communities' attitudes to urban farming. The information was collected through structured questionnaire administered to the farmers seen on the farms, opinion leaders among the communities, and chemical and microbiological analysis of samples of water sources used for farming purposes and representative samples of crops marketed.

### Materials and methods

Samples of various waters were collected from drains, streams, municipal solid waste waste leachates and shallow ponds in clean bottles and brought to the laboratory immediately for analysis. Where microbiological analysis was carried out, sterile bottles were used. The samples were analyzed for physicochemical characteristics, viz. pH value, Total Dissolved solids, Electrical conductivity, Dissolved oxygen, Biochemical Oxygen Demand, Total alkalinity, Total Hardness, Total Phosphorus, Nitrate nitrogen, Sodium, Potassium, Calcium, Magnesium, Chloride, and Total coliforms. Standard methods (APHA, 1998) were followed in the analyses. The data were analyzed using the hand calculator and presented as means and standard deviation.

## Results and discussion

### Quality of waters

The results brought out a wealth of information. The waters used for urban farming are: (a) rivers or streams flowing near the communities, usually polluted from domestic wastes, human and animal excreta, municipal solid wastes, storm drainage and untreated industrial effluents; (b) open drains carrying household sullage or gray water, mixed with human excreta and solid wastes; (c) leachates from illegal refuse dumps from the communities admixed with complex biomedical and other hazardous wastes; (d) effluents from soakaway pits connected to aqua-privy or septic tank systems of excreta disposal, and some times from (e) shallow dug wells or wash bores in the vicinity of drains or polluted streams. The waters are usually turbid, dark and viscous in appearance with high levels of suspended matter (often more than 140 mg/l), total dissolved solids (230 to 1300 mg/l), Biochemical Oxygen Demand (<5 to 50 mg/l), ammonia and nitrate (<1.0 to 43.0 mg/l), phosphorus (0.07 to 1.17 mg/l), certain heavy metals (lead, cadmium, chromium, zinc, nickel, and iron) above the WHO limits, oils and grease (0 to > 10 mg/l) and faecal coliforms (10 to > 2400 / 100 ml). Some of the streambeds and drainage sediments also contained helminthic ova and larvae. In Kano, Kaduna, Lagos, Ibadan and Port Harcourt, at least one river in each location is sacrificed for industrial waste discharges. Wastes from tanneries, textile mills, pharmaceuticals, metal industries, fertilizer and other process industries contribute to various pollutants. The presence of plant nutrients such as nitrogen, phosphorus, potassium and other trace elements in these waters outweigh the other toxic elements or infectious agents. The cost of provision of irrigation water and the associated carriage system is also eliminated. In Ibadan and Lagos, raw faeces from an improvised toilet (a toilet seat with a long drain pipe) is led into a water course and the resultant nutrient rich water is used for irrigation and also for fish farming.

### Land holdings and farming practices

The land holding of the urban farmers ranged from 0.1 to 1 Hectare per family and the farms are located on the slopes of the water sources. Very rarely the land ownership exceeded 2 to 3 Ha. In Kogi State, a retired principal of a school started a large farm (up to 10 Ha) in the suburb of Lokoja town by making use of stream and drainage water supply available in the vicinity. However, such large holdings are rare. In urban farming activities, manual labour is engaged and the family members join in the efforts. Men are involved in hard labour such as digging and making heaps and women contribute to soft labour such as irrigating, weeding and harvesting. They irrigate the farm at least once every day in wet season (April to September) and both during morning and evening in dry season (October to March) with pots, shower cans or with a bowl or a bucket. Some farmers supplement the land with manure or fertilizer, though this practice is not common due to high cost and non-availability to small farmers. Waste dumpsite soil, animal dung, topsoil or mulch is commonly used as soil amendments. Pest control is through the use of indigenous or traditional methods, such as soap solution and kerosene.

### Commonly grown crops

At least 19 varieties of crops were identified as popular in the urban farms. The type of crop depends on the location, need, growth conditions and the market value. In Lagos and Ibadan, many farmers resorted to lettuce, cabbage, and carrots, which yield higher income as they are

consumed more by the urban non-indigenes. Otherwise, plantain, banana, okra, hibiscus, maize, sorghum, cassava, sweet pepper, tomato and garden egg are grown. Sugarcane (for chewing only) is grown in swampy areas where the water table is high.

### Women in urban farming

Some women groups, women cooperatives, and water and sanitation committees at community level in certain Local Governments developed backyard organized farming and they manage the entire set up. UNICEF has also encouraged such “Family Support Programme” initiatives in the willing target communities to use the spill over water from the boreholes to develop backyard farming (Enabor et al, 1998, Sridhar, 1995). This has become popular in some urban locations as it is a community based and community managed activity. In recent years, ornamental flower growers, mostly managed by middle aged men have increased in urban centres along the urban watercourses. They proliferated in Lagos, Ibadan, Abeokuta, Abuja and other State Capitals. They have ready market for special occasions and ceremonies.

### Quality of farm produce

The quality of farm produce varied depending on the type of water used. Leafy vegetables such as lettuce, cabbage and cauliflower carry coliforms and helminthic eggs on their wrinkled surfaces, which is a health risk. These pathogens adhere firmly and washing 3 or 4 times with scanty water of doubtful quality available in the homes may not remove completely as evident from the laboratory tests. Even if washed 6 to 8 times did not completely eliminate these pathogen indicator organisms. A farmer who was using leachates from a landfill site complained of damage to his cassava tubers. They became soft on storage and the keeping quality has deteriorated (Sridhar, 1996). Another farmer in Asaba in eastern part has diverted alkaline textile mill effluent to his cassava farm and the yield and the quality were satisfactory. Leachate from a poultry waste on the backyard of a livestock farmer developed white patches on maize leaves, and red spots on spinach and immature citrus fruits dropped prematurely. These are indicative of nutrient imbalances for the crops. Depending on the crop, the levels of heavy metals varied and the lead levels are usually high on the vegetable washings. Lead is a serious problem in Nigerian urban centres, which gets into the environment through dust and exhausts from automobiles. There is a biological barrier between the root zone and the shoot and the grains for the heavy metals to pass through. Bioaccumulation of heavy metals in the farm produce is not a serious problem. Urban farmers, however, complained of more mosquito biting around the areas. Their children also suffer from schistosomiasis and worm infestations as they work on farms without any protective wear. However, the satisfaction is that once they get monetary returns, they can afford to buy drugs.

### Conclusions

In conclusion, the scenario given above indicates that urban farming using any available water source is very popular in Nigerian cities and towns. Drainage waters and dump site leachates pose serious environmental and health hazards which is a curse. The farmers, however, derive economic benefit (in spite of health risks) and that is a boon. They believe that once money is available, they could improve health through medical care. From the scientific and public health point of view, there should be some check on the quality of waters being used for such farming activities. National and State environmental guidelines are ineffective when they come to implementation level. There is a need for effective urban planning coupled with environmental



and health education for the urban farmers on the hygienic way of treating such waters before using for economic gains.

## References

- APHA (1998) Standard methods for the examination of water and wastewater, 19<sup>th</sup> edition, American Public Health association, Washington, DC
- Enabor, B., Sridhar, M. K. C., and Olaseha, I. O. (1998), Integrated water management by urban poor women: A Nigerian slum experience, *Water Resources Development*, 14, No. 4, 505-512
- Sridhar, M. K. C. (1995) Sullage / Waste Water in Nigeria: Problems and Scope for Utilization for Gardening A Report published by UNICEF, Lagos, Nigeria, pp.1-63
- Sridhar, M. K. C. (1996) Environmental Impact Assessment Study of Ogunpa Channelization and Solid Waste Management in Ibadan, A Report on Oyo State Urban Development Project submitted to Lead Consultants, Ibadan, pp. 1-79

## Possibilities and limits of wastewater-fed aquaculture

**Dr. Ranka Junge - Berberovic** University of Applied Sciences Waedenswil HSW  
Dept. Horticulture / Ecological Engineering  
P.O. Box 335, CH-8820 Waedenswil, Switzerland

### Abstract

Wastewater-fed aquaculture offers means to treat wastewater with integrated material-flow recycling. Several goals are achieved simultaneously: production of valuable goods (food stuff, animal feeds, raw materials, ornamental plants and animals) on one side, and production of utilizable gray water (wastewater purification and hygienisation) on the other side.

The main potential of wastewater-fed aquaculture and its major advantage over conventional wastewater treatment is the large diversity of marketable products and therefore broad possibilities of income generation. The combination of the two income generating options (wastewater treatment and biomass production) is a very interesting feature and in addition complies to several global political programs (like *Agenda 21*).

Aquaculture is facing challenges. Optimal stocking depends on biogeographical conditions (which species grow where, under what circumstances), cultural acceptance (which products are suitable and marketable) and economical conditions.

Among factors limiting the potential and performance of aquaculture are: limited growth rates of organisms, insufficient knowledge of the factors that regulate the aquatic community, the presence of toxic contaminants (heavy metals, hormones) and other undesired effects (colorations) in the wastewater. Appropriate technological tools (aeration, mixing, pumping, special basin forms) can be integrated in order to intensify certain ecological processes and increase the output of the aquaculture plant.

At the University of Applied Sciences Waedenswil, Switzerland, wastewater-fed aquaculture is a research focus since 1993. This paper summarises some of the results and insights gained during the past seven years and gives a short overview of literature.

### Nature of water contamination

Nature produces no waste. Inorganic nutrients are incorporated into organic matter synthesised by plants and animals. This organic matter is metabolised or degraded upon the death of organisms by decomposers (bacteria, fungi) into carbon dioxide, water and nutrients (ammonia, nitrate, phosphate). So the circle can restart again.

Table 1 shows some categories of substances, which are normally present in water. When these substances are introduced into the ecosystem by human activities in quantities that are far above natural concentrations, they become pollutants.

**Table 1: Some categories of substances found in water and their possible effects**

Substance group	Examples	Possible effect on the environment
Organic compounds	<ul style="list-style-type: none"> <li>• natural products of metabolism (carbon-compounds)</li> <li>• man made organic compounds (tensides, pesticides)</li> </ul>	<ul style="list-style-type: none"> <li>• oxygen depletion</li> <li>• chronic toxicity</li> <li>• acute toxicity, bioaccumulation</li> </ul>
Inorganic compounds	<ul style="list-style-type: none"> <li>• nutrients (nitrate, phosphate, other ...)</li> <li>• trace elements and heavy metals (Cu, Zn, Pb, Ca ...)</li> </ul>	<ul style="list-style-type: none"> <li>• fertilisation effects</li> <li>• toxicity, bioaccumulation</li> </ul>
Particles (> 0.45 µm)	<ul style="list-style-type: none"> <li>• wood, metall, plastic, sand, clay</li> </ul>	<ul style="list-style-type: none"> <li>• physical interference</li> </ul>
Microorganisms	<ul style="list-style-type: none"> <li>• pathogens</li> <li>• indicator of faecal contamination (E. coli)</li> </ul>	<ul style="list-style-type: none"> <li>• vectors of disease</li> </ul>
Dissolved gases	<ul style="list-style-type: none"> <li>• O<sub>2</sub>, CO<sub>2</sub>, NH<sub>3</sub>, CH<sub>4</sub></li> </ul>	<ul style="list-style-type: none"> <li>• fertilisation effects, toxicity</li> </ul>

### Categories of wastewater treatment

Practically any type of water pollution can be treated by end-of-pipe solutions. But these may require high amounts of resources (energy, material, workforce) and do not represent a final solution to the contamination problem. The contamination is only transferred to another compartment where it is either less disturbing or easier to manage (for example from wastewater to sludge). Therefore, first priority in environmental protection should be given to pollution prevention and recycling of resources.

Wastewater treatment methods can be classified in different ways. Table 2 shows a classification according to their size (which depends on the degree of centralisation of sewage system) and intensity of process with some examples. In urban areas and in industrial countries, very often the sewage system is highly centralised, and sewage is conducted to large conventional wastewater treatment plants. It is important to note that extensive wastewater treatment methods, like reed beds, can be large and part of a centralised system too.

Biological wastewater treatment includes all methods that involve organisms, and emulate at least some of the processes which take place in natural environments. These methods differ in the extent by which they emulate natural ecosystems and in the biological processes that predominate. Some biological treatment methods emulate decomposer communities and degradation processes predominate (treatment with activated sludge), whereas others emulate productive ecosystems and assimilation is important (wastewater-fed aquaculture). Beside metabolisation of contaminants, organisms can also contribute to water purification by mediating physical or chemical processes in the system, like retention, filtration or flocculation.

**Table 2: Classification of wastewater treatment methods according to their size and intensity**

<b>Intensity</b>	<b>Decentralised with small wwt-plants</b>	<b>Centralised with large wwt-plants</b>
<b>Extensive</b>	Wastewater garden for 10 PE	Reed bed for 100'000 PE
<b>Intensive</b>	Septic tank and submersed bed treatment for 10 PE	Conventional wwt for 100'000 PE

**PE: Person Equivalent, wwt: wastewater treatment**

Only non-toxic pollutants which are biodegradable (carbon compounds) or can be assimilated (dissolved nutrients) can be successfully treated biologically.

Conventional wastewater treatment plants normally consist of mechanical pretreatment, followed by activated sludge treatment and post-treatment units. These systems solve some problems, but are also source of some new ones:

- They are usually centralised. This implies construction of long distance sewage channels. Up to 85% of total costs for wastewater treatment can be caused by sewage channels.
- They produce large amounts of surplus sludge, which in turn causes deposition and hygiene problems, especially if heavy metals were accumulated.

### **What is a wastewater-fed aquaculture?**

Wastewater-fed aquaculture (WFA) is a *productive* wastewater treatment, contrary to other methods of biological wastewater treatment, which are primarily based on degradation processes. Wastewater is *reused* instead of disposed of.

A wastewater-fed aquaculture is an ancient but nevertheless innovative and successful way to treat and recycle wastewater. A constructed aquatic ecosystem, consisting of one or several water bodies with an integrated food web, is charged with nutrient rich wastewater. The central aim of the system is the assimilation of dissolved nutrients into biomass. Simultaneously organic compounds are either consumed or mineralised, and in consequence the wastewater gets purified. The constructed ecosystem reflects processes of the natural environment and is thus aesthetically pleasing.

In contrast to conventional wastewater treatment plant, WFA puts strong emphasis on the quality of the synthesised biomass and produces a wide array of valuable goods and relatively small amounts of sludge (Table 3).

Wastewater-fed aquaculture therefore complies to several points of the „Bellagio Statement“ (Schertenleib et al., in this proceedings) concerning the environmental sanitation: In WFA "waste" nutrients are respected as a resource and the economic opportunities of waste recovery and use are harnessed. It allows waste to be managed close to its source and wastewater to be recycled and added to the water budget. It offers vast potential of adaptation to any local situation. It can be optimized along several dimensions, allowing different degrees of intensity.

- community-design: polyculture, modular organisation, monoculture
- human interference with community design: low (self-design), medium (biomanipulation), high ("farming")

- system design: natural systems (ponds), artificial systems with incorporation of technological elements
- alternative emphasis on most important output: recycled water, biomass

According to Table 2 wastewater-fed aquaculture can be applied in either decentralised or centralised systems of water purification. It can be extensive, like Calcutta Wetlands (Jana 1998), but also intensified by a higher input of energy and technical elements into the system, like Stensund (Guterstam 1996) and Otelfingen aquaculture plants (Staudenmann and Junge-Berberovic 1999).

**Table 3: Wastewater-fed aquaculture can supply a wide array of marketable products**

Category	Some examples
Food for humans - Edible plants	High-protein algae ( <i>Spirulina</i> ) Water spinach ( <i>Ipomoea</i> ) Water chestnuts ( <i>Eleocharis dulcis</i> , <i>Cyperus esculentes</i> ) Water nuts ( <i>Trapa</i> , <i>Alternanthera</i> ) Hydroponic vegetables and herbs ( <i>Capsicum</i> , basil, lettuce)
Food for humans - Edible animals	Mussels Prawns ( <i>Macrobrachium</i> ) Crayfish ( <i>Procambarus clarkii</i> , <i>Astacus</i> , <i>Cherax</i> ) Fish (Carp-species, Tilapia, <i>Clarias</i> , <i>Channa striata</i> , <i>Micropterus salmoides</i> )
Animal feeds	Phytoplankton ( <i>Microcystis</i> , <i>Scenedesmus</i> , <i>Selenastrum</i> , <i>Anacystis</i> , <i>Phacus</i> , <i>Closterium</i> ) High-protein floating plants ( <i>Lemna</i> , <i>Azolla</i> , <i>Wolffia</i> ) Zooplankton ( <i>Asplanchna</i> , <i>Filina</i> , <i>Keratella</i> , <i>Brachionus</i> , <i>Moina</i> , <i>Daphnia</i> , <i>Cyclops</i> ) Fish-Feeds ( <i>Earthworms</i> )
Raw materials	Fibers for furniture, baskets ( <i>Eichhornia</i> ) Cellulose for paper ( <i>Typha</i> ) Isolation material ( <i>Typha</i> ) Fertilizer (algae suspension, plant biomass) Renewable energy sources
Luxury products	Pearls ( <i>Hyriopsis</i> , <i>Cristaria</i> ) Ornamental plants ( <i>Eichhornia</i> , <i>Nuphar</i> ) Ornamental fish (Koi - <i>Cyprinus carpio</i> )

### Factors to consider for planning a wastewater-fed aquaculture

When deciding the appropriate wastewater treatment for a particular situation, there are no universal solutions. Every kind of wastewater (according to its composition) and every specific local situation (for example: urban/rural, socio-cultural) requires custom made solutions. Often, there are several good solutions to the same situation. Wastewater-fed aquaculture often proves to be a sustainable biological wastewater treatment method, because it is nature-like, low-tech and income-generating. But the local factors must always be taken into consideration, beginning with the first steps of the planning process.

Table 4 illustrates some of the factors, which have to be taken into consideration when planning a wastewater aquaculture using the partly contrasting examples in Europe and Asian countries.

In planning and operating a WFA, many challenges are involved:

- Optimisation and regulation of natural ecosystems
- Integration of technological tools
- Quality standards of produced goods
- Toxines and bioaccumulation
- Acceptance of produced goods

For many of the above aspects, the research is by no means concluded. Very often experimental results are lacking, and pragmatic and intuitive decisions are necessary.

**Table 4: Comparison of factors influencing the application of wastewater-fed aquaculture in Europe and Asia**

	Europe	Asia
climate conditions	temperate	tropical to continental
land resources	limited expensive	available in rural areas low-moderate cost
labor cost	high	low
fertilizer (nutrients)	abundant	limited
main motivation for recycling	environmental concern	limited resources
demand for food (protein)	stable	growing
demand for ornamental products	high	variable, often low
conventional wastewater treatment (degradation/elimination)	well developed, widely applied	moderate know-how, limited use
productive wastewater treatment (aquacultures)	limited experiences	traditional practical knowledge exists

### Sanitary effects: wastewater hygienisation

Several studies agree that wastewater-fed aquacultures, especially the ones consisting of several ponds, have fairly good wastewater hygienisation properties. A series of 2 –3 ponds should probably be sufficient to reduce the numbers of faecal bacteria to acceptable levels. Das (2000) reported reductions from 92% to 100% of total coliforms, faecal coliforms, *Salmonella sp.* and faecal streptococci.

Again, this applies especially to systems containing plants. Seidel (1976) reported that root excretions of certain plants (*Scirpus*, *Phragmites*) can kill faecal indicators (*E. coli*) and pathogenic bacteria (*Salmonella*). Total coliform levels in municipal wastewaters applied to artificial wetlands were significantly lower in vegetated beds than in unvegetated beds (Gersberg et al. 1987).

According to Jana (1998), epidemiological studies on fishermen reveal high prevalence of diarrhoea, cough, cold and fever. However, the values were not significantly different from workers on a freshwater fish farm. Edwards (2000) concluded that it is not possible to generalize health risks of wastewater-fed aquacultures and that some systems may present a greater risk to public health than others. But: "...it is safer to consume fish cultured in a well managed wastewater-fed system than to rely on wild fish from increasingly polluted surface water" (Edwards 2000).

### Some concepts and properties of wastewater-fed aquaculture

#### ***The central feature of wastewater-fed aquaculture is the recycling of nutrients.***

The main improvement of WFA compared to other methods is that nutrients are recycled into utilizable biomass. Other methods of wastewater purification can perform in many aspects better and cheaper. For example: constructed wetlands are more efficient in denitrification, conventional wastewater treatment based on activated sludge is more efficient in bacterial degradation of BOD, anaerobic tanks are more efficient in metal precipitation. Nevertheless, wastewater-fed aquaculture has the greatest recycling potential. Therefore, a central issue in improving wastewater-fed aquaculture should be to increase the share of recycled nutrients.

Nutrient recycling capacity of aquaculture is determined by growth/harvest rates and by the biomass composition of organisms. (**Table 5**)

Although the main purpose of the traditional wastewater-fed aquaculture often is to generate animal protein (fish), the **central role of plants** has to be emphasised:

- they capture solar energy
- some of them perform nitrogen fixation
- they produce and transport oxygen into the water
- they excrete various substances, some with bacteriostatic properties, which influence hygienisation
- they provide attachment surface and create micro-regions with favourable conditions for diverse microorganisms
- they act as temperature buffers by insulation and shading

- they prevent undesirable algae growth by shading
- they can accumulate potentially problematic substances (heavy metals)
- many species can be harvested and used as food, animal feeds, roofing, insulating, construction or heating materials.

Generally, in the aquatic environment high growth rates of stocked organisms can be achieved. The plant biomass production, and therefore also nutrient elimination, is approximately one order of magnitude higher than that of consumers. Plants can generate up to 200 tons of fresh weight per hectare per year, fish 10 tons, and *Daphnia* more than 20 tons. Therefore, maximum nutrient recycling capacity per area will be approximately:

- for plants: 1 g N m<sup>-2</sup> d<sup>-1</sup> and 0.1 g P m<sup>-2</sup> d<sup>-1</sup>
- for animals: 0.1 g N m<sup>-2</sup> d<sup>-1</sup> and 0.03 g P m<sup>-2</sup> d<sup>-1</sup>

More detailed numbers are given in Table 5.

In a well managed WFA up to 40% of nutrients can be recovered as plant biomass. The rest of elimination is due to denitrification, accumulation and sludge deposition.

***Achieving all the year round high growth rates in temperate climate, where many industrialized countries are, implies higher sophistication of aquaculture plants and "high-tech ecological engineering" is required.***

To offset the high treatment price, products of aquaculture have to be profitable. This implies that aquaculture should produce marketable goods with high economic return. It would be waste of land and work to produce green crops for the sole purpose of composting afterwards, unless one can generate income from compost!

***Nutrient recycling efficiency and economic aspects should be explicitly stated when reporting the efficiency of aquaculture system. Reporting overall purification results (effluent/influent) is not enough. Sound nutrient budgeting is an important step towards improving the functioning of aquaculture plants.***

**Table 5: Average biomass composition and growth rates of some organism groups in aquaculture**

Organism	Maximum growth / harvest rates kg FW / ha / year	Growth rate g DW m <sup>-2</sup> d <sup>-1</sup>	Biomass composition		Elimination by harvesting	
			%N	%P	g N m <sup>-2</sup> d <sup>-1</sup>	g P m <sup>-2</sup> d <sup>-1</sup>
Microalgae *	(240 000)	13.0	6.0	0.6	0.780	0.078
Macrophyta						
Macrophyta Floating *	(150 000)	8.0	3.9	0.8	0.312	0.064
Macrophyta emerging *	(160 000)	9.0	1.7	0.3	0.153	0.027
<i>Eichhornia sp.</i> Otelfingen 1998		41.9			0.770	0.190
<b>Crayfish</b>		(DW @ 20% FW)				
Semi-intensive (Australia)	2000	P 0.110	10	1	0.011	0.001
Extensive (unfed) (Australia)	200	P 0.011	10	1	0.001	0.000



Organism	Maximum growth / harvest rates	Growth rate	Biomass composition		Elimination by harvesting	
	kg FW / ha / year	g DW m <sup>-2</sup> d <sup>-1</sup>	%N	%P	g N m <sup>-2</sup> d <sup>-1</sup>	g P m <sup>-2</sup> d <sup>-1</sup>
Calcutta Wetlands (Jana 1998)	750	<i>P</i> 0.041	10	1	0.004	0.000
<b>Zooplankton</b>						
<i>Daphnia</i> (**)		0.6-80.0 **	9.5	1.2	<9.0	< 0.9
DePauw and Pruder (1986)	up to 48 000	<i>P</i> 2.64	10	1	0.264	0.026
Otelfingen 1998		0.9	10	1	0.090	0.009
<b>Fish</b>						
Calcutta wetlands (Jana 1998)	up to 9350	<i>P</i> 0.512	10	1	0.052	0.005
Fish (Hungary)		0.4	10	1	0.040	0.004

FW fresh weight

DW dry weight

*italics* values assumed or calculated using assumptions

\* mean of several values cited in literature

\*\* range of values calculated from Berberovic (1990) and different sources

## Literature

- Adler, P.R., Summerfelt, S.T., Glenn D.M., Takeda, F. (1996) Evaluation of the effect of a conveyor production strategy on lettuce and basil productivity and phosphorus removal from aquaculture wastewater. In: J. Staudenmann, A. Schoenborn, and C. Etner (Eds.), Recycling the Resource. Proceedings of the 2nd Int. Conf. on Ecological Engineering for Wastewater Treatment. Transtech Publications, CH-Uetikon. pp. 131-136.
- Culley DD, Epps EA (1973) Use of duckweed for waste treatment and animal feed. J. Water Pollution Control Fed. 54(2):337-347.
- Datta, A.K. (2000) Comparative evaluation of sewage-fed and feed-based aquaculture. In Jana, B.B., Banerjee R.D., Guterstam, B., and Heeb, J. (eds) Waste recycling and resource management in the developing world. University of Kalyani, India and International Ecological Engineering Society, Switzerland.pp.97-104
- Das, F.B. (2000) Ecological engineering for wastewater treatment. In Jana, B.B., Banerjee R.D., Guterstam, B., and Heeb, J. (eds) Waste recycling and resource management in the developing world. University of Kalyani, India and International Ecological Engineering Society, Switzerland.pp 125-133.
- DeBusk TA & Reddy KR (1987) Wastewater treatment using floating aquatic macrophytes: Contaminant removal processes and management strategies. In: Aquatic Plants for Water Treatment and Resource Recovery. Reddy KR and Smith WH (Eds) Magnolia Publishing Inc. pp. 643-656.
- DeBusk, T.A. & Ryther, J.H. (1987) Biomass production and yields of aquatic plants. In: Aquatic Plants for Water Treatment and Resource Recovery. Reddy, K.R. and Smith, W.H. (Eds.) Magnolia Publishing Inc. pp. 579-598.

- DePauw, N, Pruder G (1986) Use and production of microalgae as food in aquaculture: practices, problems and research needs. In: Bilio M, Rosenthal H, Sindermann CJ (Eds) *Realism in Aquaculture: Achievements, Constraints, Perspectives*. European Aquaculture Society, Bredene, Belgium.
- Edwards, P. (2000) Wastewater-fed aquaculture: state of art. In Jana, B.B., Banerjee R.D., Guterstam, B., and Heeb, J. (eds) *Waste recycling and resource management in the developing world*. University of Kalyani, India and International Ecological Engineering Society, Switzerland. pp. 37-49
- Edwards, P. and Pullin, R.S.V. (1990) Wastewater-fed aquaculture (eds) *Proceedings of the international seminar on wastewater reclamation and reuse for aquaculture*, Calcutta, India 6-9 December 1988. 296p. Environmental Sanitation Information Center, Asian Institute of Technology, Bangkok, Thailand. ICLARM Contribution No. 684.
- Govindan VS (1987) Studies on the treatment of waste water for pisciculture and agriculture. *Arch. Hydrobiol. Beih. Ergebn. Limnol.* 28:95-104.
- Guterstam, B. (1996) Demonstrating ecological engineering for wastewater treatment in a Nordic climate using aquaculture principles in a greenhouse mesocosm. *Ecol. Engin.* 6:73-97.
- Gumbrecht, T. (1993) Nutrient removal capacity in submersed macrophyte pond systems in a temperate climate. *Ecol. Engin.* 2:49-61.
- Iqbal, S. (1999) Duckweed Aquaculture. Potential, Possibilities and Limitations for Combined Wastewater Treatment and Animal Feed Production in Developing Countries. SANDEC report 6/99. To order at: [hauser@eawag.ch](mailto:hauser@eawag.ch).
- Jana, B.B. (1998) Sewage-fed aquaculture: The Calcutta model. *Ecological Engineering* 11:73-85.
- Jana, B.B., Banerjee R.D., Guterstam, B., and Heeb, J. (2000) (eds) *Waste recycling and resource management in the developing world*. University of Kalyani, India and International Ecological Engineering Society, Switzerland.
- Landolt, E., 1996. Duckweeds (Lemnaceae), Morphological and Ecological Characteristics and their Potential for Recycling of Nutrients. In: J. Staudenmann, A. Schoenborn, and C. Etnier (Eds.), *Recycling the Resource. Proceedings of the 2nd Int. Conf. on Ecological Engineering for Wastewater Treatment*. Transtech Publications, CH-Uetikon. pp. 289-296.
- Morin, H. (1996) Nutrient considerations for commercial greenhouse plants in hydroponic cultivation with sewage water. In: J. Staudenmann, A. Schoenborn, and C. Etnier (Eds.), *Recycling the Resource. Proceedings of the 2nd Int. Conf. on Ecological Engineering for Wastewater Treatment*. Transtech Publications, CH-Uetikon. pp. 401 - 404
- Reddy, K.R. and W.H. Smith, 1987. *Aquatic Plants for Water Treatment and Resource Recovery*. Magnolia Publishing, US-Orlando. 1032pp.
- Reddy, K.R. & DeBusk, W.F. (1987) Nutrient storage capabilities of aquatic and wetland plants. In: *Aquatic Plants for Water Treatment and Resource Recovery*. Reddy, K.R. and Smith, W.H. (Eds.) Magnolia Publishing Inc. pp. 337-357.
- Scheurer K. & Staudenmann, J. (1996) Macrophytes as Food for European Freshwater Fish (Rudd, *Scardinius erythrophthalmus* and Tench, *Tinca tinca*). In: J. Staudenmann, A. Schoenborn, and C. Etnier (Eds.), *Recycling the Resource. Proceedings of the 2nd Int. Conf. on Ecological Engineering for Wastewater Treatment*. Transtech Publications, CH-Uetikon. pp. 421-425.

- Soeder, C.J. (1981) Chemical composition of microalgal biomass as compared to some other types of single cell protein (SCP). In: *Wastewater for Aquaculture. Proceedings of a Workshop on Biological Production Systems and Waste Treatment.* Grobelaar, J.U., Soeder, C.J., Danie, F.T. (eds.). University of the O.F.S. Bloemfontein, South Africa. pp. 73-85.
- Staudenmann, J., A. Schoenborn, and C. Etnier (Eds.), 1996. *Recycling the Resource. Proceedings of the 2nd Int. Conf. on Ecological Engineering for Wastewater Treatment.* Transtec Publications, CH-Uetikon. 479pp.
- Staudenmann J, and Junge-Berberovic, R. (2000) Treating Biogas Plant Effluent through Aquaculture: First Results and Experiences from the Pilot Plant Otelfingen (Switzerland) *In* Jana, B.B., Banerjee R.D., Guterstam, B., and Heeb, J. (eds) *Waste recycling and resource management in the developing world.* University of Kalyani, India and International Ecological Engineering Society, Switzerland.pp. 52-57.
- Staudenmann, J. and Junge-Berberovic, R. (2000) The Otelfingen Aquaculture Project – Recycling of Nutrients from Wastewater in Temperate Climate. Submitted to *Journal of Applied Aquaculture.*
- Todd J, Josephson B (1996) The design of living technologies for waste treatment. *Ecological Engineering* 6:109-136.
- Todt, D., 1998. *Produktion von tropischen Pflanzen zur Nährstoffelimination von Prozesswasser.* Diploma thesis at the University of Applied Sciences Waedenswil, CH-Waedenswil. (in German)
- VSA, 1995. *Die Klaerschlammsituation in der Schweiz.* Verbandsbericht Nr. 495. Verband Schweizer Abwasser- und Gewaesserschutzfachleute, CH-Zuerich. (in German). 30pp.
- Wissing, F., 1995. *Wasserreinigung mit Pflanzen.* Ulmer, D-Stuttgart. (in German). 207pp.
- Wyss, Ph and Züst, B. (2000) *Sustainable wastewater treatment with soil filters. Distribution and sales: Intermediate Technology Publications 103-105 Southampton Row, London WC1B 4HH, UK, [orders@itpubs.org.uk](mailto:orders@itpubs.org.uk).*
- Yan J., Wang R., Wang M. (1998) The fundamental principles and ecotechniques of wastewater aquaculture. *Ecological Engineering* 10: 191-208.
- Yan, J. and Honglu, Y. (1989) *Integrated fish culture management in China.* In: Mitsch, J., and Jorgensen, S.E. (Eds) *Ecological Engineering.* John Wiley and Sons.

## Results of Parallel Session 1 presented at the plenary

"How can we focus new sanitation strategies on the agricultural context?"

1. Hygiene
  - whose glasses are we looking through
  - bridge technical and human aspects
  - move upstream
  
2. Reuse
  - put back from land what we take
  - decentralize, small loops
  - considers loops within loops
  
3. Economic
  - restore nature to benefit from ecosystems
  - close the market loop
  - consider energy issues
  
4. Action
  - demonstration projects
  - Research
  
5. Collaboration
  - WHO, FAO, ILO, Farmers



## Minutes of Parallel Session 1<sup>1</sup>

The papers presented at this session provided a good introduction to the topics which were discussed afterwards. To guarantee an efficient discussion, the chairman focussed on the following topics:

- 1 Hygiene aspects
- 2 Fertilizing and reuse aspects
- 3 Economics

### 1 Hygiene aspects

- The present practice of conventional wastewater treatment (end-of-the-pipe technology) is unhygienic, because small amounts of faeces are diluted with gray water.
- The separation of urine, faeces and gray water leads to only small amounts of contaminated matter.
- Hygiene problems due to pathogens derive from only a small portion of human excrements, namely faeces. Nevertheless the possibility of diseases being transmitted via urine also needs to be investigated in detail.
- Nowadays, a lack of knowledge in the general population about the proper use of wastewater leads to hygiene problems, so there is urgent need of public education. Even small amounts of educational input can improve sanitation (cf. the project: "Participatory Hygiene and Sanitation Promotion in Zimbabwe").
- Each applied technology must be specifically adapted to the people's socio-cultural background. Otherwise, it will not be accepted.
- Wastewater is a resource and can even become a product. Also, problem recognition has to be promoted, e.g., farmers have no special interest in issues concerning hygiene; they simply need wastewater for irrigation.

### 2 Fertilizing and reuse aspects

- There is great need for fertilizer in agriculture. The use of ecological sanitation systems shortens the loop of the nutrient cycle. Expensive mineral fertilizers like phosphorus, nitrogen and potassium can be replaced with natural fertilizer, whereby overall energy consumption – including that expended for the production of fertilizer – decreases.
- Most natural nutrients in wastewater originate in urban areas, so any attempt to reuse those nutrients presents the problem of how to transport them to the rural areas in question. More research is required about how to reduce the volume of the products and generate a storable fertilizer of defined quality in order to keep the transportation of human fertilizer economical.

---

<sup>1</sup> Minutes taken by Inka Hobus

- To the greatest possible extent, decentralized solutions with short loops should be developed and given preference. On that point, big-city approaches are unsustainable.
- Complete energy and material balances need to be set up in order to gain detailed insight about which concept is more readily applicable and sustainable in a given situation.
- The quality of the fertilizer depends on the quality of the wastewater. The reuse aspect demands that the wastewater contain nothing that could constitute a risk to the food cycle.
- Industrial wastewater requires pretreatment, and reusable materials have to be separated out in advance. The practice of combining industrial and municipal wastewater should be avoided due to potential problems with toxic chemicals or heavy metals.
- In general, the political framework has to change. In Israel, for example, the reuse of wastewater is mandatory.

### 3 Economics

- Fertilizer deriving from wastewater can be turned into a product, and it is important that the product's benefits be recognized. Such benefits can be of the monetary kind (economic benefits) or of the nonmonetary, or at least not directly monetary, kind (health benefits). An ecological sanitation system can provide business opportunities for small enterprises in developing countries. The framework conditions need to be altered such that the reuse of wastewater becomes beneficial.
- If the majority of the population concludes that there are health benefits to be gained from ecological sanitation, the people will be willing to pay a fair price for it, and – what is even more important – they will implement and adhere to the concepts.
- As an incentive for companies to produce only wastewater containing harmless substances, some form of certification could be introduced for products that produce harmless wastewater.
- The present end-of-the-pipe technology is diseconomical due to the high cost of sewage systems, the expense of separating the nutrients from the water in conventional wastewater treatment plants, and the high cost of producing mineral nutrients (NPK).

### 4 Necessary steps for intensifying the dissemination of ecosan

The following action needs to be taken:

- education about safe, hygienic application of wastewater, and the promotion of wastewater reuse in cooperation with WHO and FAO
- guidelines for the reuse of wastewater (WHO)
- research into potential hygiene risks in connection with Ecosan
- small-scale demonstration projects
- policy: official support from the health department
- market development for fertilizers made from wastewater and excreta

## List of participants

Austin	L.M.	South Africa	CSIR Building and Construction Technology
Bürgow	Grit	Germany	IEES, OICOS e.V.
Dockhorn	Thomas	Germany	Technische Universität Braunschweig
Elles	Anselm	Germany	AFC Consultants International GmbH
Esrey	Steven	USA	UNICEF
Geller	Gunther	Germany	IÖV
Gomer	Dieter	Algeria	GTZ
Guterstam	Björn	Sweden	Global Water Partnership
Hagen	Christian	Germany	GTZ
Hobus	Inka	Germany	Technische Universität Berlin
Holder	Gabriele	Germany	RODECO Consulting GmbH
Junge-Berberovic	Ranka	Switzerland	University of Applied Sciences Wädenswil
Kebekus	Frauke	Germany	Hamburger Stadtentwässerung
Kunz	Peter	Germany	University of Applied Sciences Mannheim
Munyati	Alex	Zambia	Southern Water & Sewerage Company
Musara	Cleophas	Zimbabwe	Mvuramanzi Trust
Owsianowski	Rolf-Peter	Senegal	GTZ
Rettenberger	Armin	Germany	University of Applied Sciences Mannheim
Schmoll	Oliver	Germany	Umweltbundesamt, WHO
Schönfeld	Axel	Germany	
Schroth	Susanne	Germany	TBW GmbH
Sridhar	M. K. C.	Nigeria	University of Ibadan
Vest	Heino	Germany	Internationale Technologieberatung Dr. Vest
Werner	Christine	Germany	GTZ





## Parallel Session 2

# Rethinking Sanitation – Bellagio Principles and Household Centred Environmental Sanitation Approach

**Key Question:** „What are the needs for international action in implementing the Bellagio-Principles and the HCES-approach?“

**Moderators:** **John Kalbermatten** (Consultant, USA)  
**Roland Schertenleib** (EAWAG, Switzerland)

## Lectures

**Appropriate sanitation technologies for Botswana**  
Tony Richards (GTZ, Botswana)

**The practice and potential of ecological sanitation in India and the sub-continent based on current research and demonstration of compost toilets in India**  
Paul Calvert (Consultant, India)

**Implementing the Bellagio Principles and the HCES Approach: A framework for action**  
John Kalbermatten (Consultant, USA)



## Appropriate sanitation technologies for Botswana

**Tony Richards**

Senior Advisor (Sanitation)  
Gesellschaft für Technische Zusammenarbeit Botswana  
Private Bag X 12, Garbone, Botswana

### Background

Botswana is a landlocked country in the centre of the Southern African Plateau sharing borders with Namibia, South Africa, Zambia and Zimbabwe, and having an area of 582 000 sq. km. with a mean altitude of approximately 1,000 m above sea level. It is a semi-arid country with scarce water resources and rainfall ranging from about 650 mm in the north-east to less than 250 mm in the south-west. There is an almost complete absence of surface water and in many areas water supplies are reliant on groundwater sources.

After 80 years as a British Protectorate, Botswana received independence in 1966. At that time, there was no industry, no agricultural activities, except for subsistence farming, and only about 6 km. of tarred roads throughout the country. The population was around 350,000 and Botswana was considered to be one of the poorest nations in the world. The only source of foreign exchange was through citizens working in the gold mines of South Africa.

As a result of the discovery of diamonds shortly after independence, coupled with improved farming techniques, a strong tourism industry and political stability, Botswana has enjoyed one of the fastest growing economies world-wide and achieved a GDP growth of 9 per cent last year. Due to the nation building process after independence and priorities given to pressing social matters such as health care, water supply, housing and education, environmental issues have been somewhat lagging behind.

Waterborne sewerage systems exist in the six urban centres and are being developed in most of the major villages, covering around 60 per cent of the current population of 1.5 million. The remaining 40 per cent, living mainly in small villages and rural areas, and some peri-urban dwellers, use on-site sanitation or nothing. In some parts of the country the extensive use of on-site sanitation creates a major risk of pollution of the groundwater resources on which the country relies, and is believed to have already resulted in the loss of some highly productive aquifers.

### History of on-site sanitation

From the 1960's through to the 1980's, Botswana was a centre for the study of appropriate low cost methods of on-site sanitation and this led to a number of alternatives technologies being constructed as pilot schemes. Although there are still remnants of some of the original pilot schemes, the most common types of on-site sanitation technology are the simple pit latrine, the ventilated improved pit latrine (VIP), and septic tanks. The use of the first two techniques has formed the basis of the Government's policy of providing heavily subsidised on-site sanitation.

The major Government initiative in the provision of on-site sanitation has been through the National Rural Sanitation Programme (NRSP). The origins of this programme can be traced back to 1976 when the Government instituted the Urban Sanitation Research Project to provide subsidised latrines to households in urban areas.

In 1980, this concept was extended and work started to provide on-site sanitation in rural areas through the Environmental Sanitation and Protection Pilot Project. The second phase of this project, renamed the Self Help Environmental Sanitation Project, commenced in 1984 in four rural administrative districts, with the support of UNICEF. In the following four years approximately 3,500 latrines had been built and were in use. By the end of 1990 the project area covered 80 rural settlements and the process of extending the project to the remaining rural districts in the country was underway.

In 1991 a study was commissioned by the Government to design a NRSP Strategy for the immediate planning period of National Development Plan 7 (1991/7) and beyond. The Strategy recommended clearly that health education and social mobilisation were key factors in establishing a genuine demand driven motivation for latrines, which did not depend on the Government's provision or subsidy. It was recognised that these factors would facilitate the adoption of improved attitudes and practices to sanitation, which are vital to bringing about improvements in health and living conditions. The strategy also recommended a change of technology from the "Botswana VIP" to simpler and less costly technologies.

Although the NRSP has been implemented since 1991, in practice the strategy has not been followed in terms of health education and social mobilisation, but has concentrated on promoting the construction of latrines using subsidies as the major selling point with very little emphasis on health education. Furthermore, householders have not been involved in the planning and decision making process regarding the choice of technology. As a result, the Programme is not demand driven and beneficiaries show minimal interest and commitment. Under the Programme householders contribute P 30 (US\$ 5.00) towards the cost of the latrine substructure, which is constructed by contractors engaged by the local authority at a cost of around P 2,000 (US\$ 370). The householder is then expected to provide the superstructure. The householder contribution was set in 1991 and has not been altered since.

Over the past ten years, an estimated 17,000 latrines have been constructed on this basis. However, evidence indicates that many of these latrines were either not completed; are not used; or give problems with emptying. They are also thought to have contributed to the loss of groundwater resources through pollution.

Recently the Government has indicated that pit latrines should no longer be constructed under the NRSP because of the risks to groundwater resources from latrine seepage, but replaced by a form of prefabricated dehydration latrine imported from South Africa. The cost of these proprietary latrines is twice that of the pit latrine, but will continue to be provided on the same subsidised basis.

Research into the acceptability of this type of technology under Botswana conditions is far from complete, in particular, the handling and re-use of the dried product by householders. Although research into on-site sanitation has been carried out in the past, there has not been any coherent attempt to carry out research across a wide range of available technologies and their environmental and social suitability, as well as their economic sustainability under Botswana conditions.

## Current problems

Recently stakeholders in the provision of on-site sanitation were asked to set out their perceptions of the strengths and weaknesses of the four main forms of on-site sanitation currently in use in Botswana. Their views are summarised in Annex 1.

There is concern amongst some sector professionals that, given these problems with the NRSP, the current approach of the Government is failing to create a demand driven approach to

sanitation. Also, the approach does not make the best use of government funds in addressing the question of on-site sanitation.

### Future wastewater / sanitation policy

In April 1999 the Government established the Department of Sanitation and Waste Management to co-ordinate wastewater, sanitation and solid waste management activities throughout the country, and is now finalising a new National Wastewater / Sanitation Management Policy, the overall purpose of which is:

*“To promote the health and well being of the people of Botswana through the provision of appropriate and sustainable wastewater/sanitation management and to introduce mechanisms for the protection and conservation of water resources.”*

The objectives of the policy are *inter alia* to:

- create an enabling environment through institutional and organisational reforms supported by an appropriate legislative and regulatory framework;
- introduce effective development planning and management involving central government, local authorities, communities and users;
- promote appropriate, affordable and sustainable systems in rural and urban situations, including effective and sustainable operations and maintenance;
- establish principles and guidelines for pricing and cost recovery mechanisms;
- encourage and facilitate private sector participation in the sector; and
- promote health and sanitation education / awareness programmes.

The proposed Policy includes statements on the most appropriate wastewater / sanitation technologies to be used. These will depend on the service standard of the water supply, i.e. premises with an individual water connection or those without and, in Botswana with its water scarcity and significant reliance on groundwater, will also depend on groundwater vulnerability, cost-effectiveness, and affordability.

In areas of high groundwater vulnerability, in order to protect aquifers, the technologies being recommended for premises with individual water connections are waterborne sewers or septic tanks connected to small bore sewer systems.

For premises that do not have an individual water connection and are in areas of high groundwater vulnerability, the recommended on-site technologies will be sealed VIDP latrines or sealed dehydrating latrines. In areas of low groundwater vulnerability the single VIP latrines can also be used.

The VIDP and dehydrating latrine technologies have the advantage of not only protecting groundwater, but also reducing the requirement for tanker emptying because the latrines can be emptied by the user. However, the social acceptance by householders of handling the dried waste material is, as yet, unproven.

In many ways this Policy supports the principles of the Bellagio statement. However, the Policy focuses more on technology issues than those of community and householder involvement in sanitation decisions, health and hygiene awareness raising, and the re-use of wastes.

## Proposed research project

In the light of the past problems, and the provisions of the new Policy, the Government is considering carrying out a comprehensive research project to draw on experience to date and investigate more effective ways of stimulating a demand driven approach to on-site sanitation, including the possible adoption of the environmental sanitation approach.

The Water, Engineering and Development Centre (WEDC) of Loughborough University, UK have recently completed the design of such a project, the purpose of which is:

*“To develop a strategy and implementation guidelines for promoting best practice for environmentally sound, financially viable, and socially acceptable methods of sustainable on-site excreta disposal in Botswana”.*

## Research topics

Based on the problems identified by the stakeholders, and from studies of past reports and personal interviews, ten research topics have been identified for inclusion in the project. (It is not the purpose of this paper to discuss the reasons for inclusion of these topics, but further details can be obtained from the author.)

- 1) Clarifying the actual health risks from nitrate-rich groundwater.
- 2) Quantifying the health risks in Botswana resulting from poor hygiene and poor sanitation practices, and ways of changing poor practices.
- 3) Clarifying the likely nitrate contribution to groundwater pollution from latrines.
- 4) Clarifying the risk of groundwater pollution by faecal pathogens from latrines or surface pollution by pathogens in sludge removed from latrines.
- 5) Investigating lessons that can be learned from latrines and any associated hand-washing facilities that have already been used in Botswana.
- 6) Investigating lessons that can be learned from other African countries about the types of latrine in use in Botswana, and other types which have potential for use.
- 7) Investigating experience to date with emptying of latrines.
- 8) Investigating lessons that can be learned from other African countries about methods of emptying latrines.
- 9) Investigating the attitudes of users and small-scale farmers to re-use of greywater and/or urine and/or decomposed faeces for soil enrichment.
- 10) Investigating the most effective way of bringing about changes in attitudes and practices relating to the adoption, hygienic use, operation and maintenance of latrines.

## Research methodology

Each research topic has been broken down in to a number of specific research activities and the method of research to be used has also been defined. These methods are:

- a) desk studies of available literature, reports and records, supporting by structured questionnaires where necessary;
- b) field based research in selected pilot areas covering technical, social and economic aspects, including that from other SADC countries where appropriate; and
- c) laboratory based work or controlled field experiments.

It is proposed that the research project should be implemented in three phases over a period of five years, with some overlap of activities between each phase. Also it is envisaged that the project will comprise a number of sub-projects and be carried out by local research organisations, supported by regional and international researchers, and focus more on environmental, social, economic and health issues at the user level, rather than on technology issues as in the past.

One of these sub-projects is being developed to investigate the potential application of the Bellagio principles in Botswana, where householder participation and consideration of waste as a resource has, to date, not been successful.

### Community and householder participation

In designing the research project it became apparent that Botswana does not have an effective mechanism for involving communities and households as stakeholders in a “bottom-up” approach, nor is there an acceptance by householders of sanitation being the problem of anyone other than the Government.

The reasons for the low level of community and householder participation will require further research in order to come up with a strategy for addressing the problem. However, it can be postulated that the lack of participation arises from the strong economy and rapid development of Botswana since independence in 1966.

Prior to independence and the discovery of diamond resources shortly afterwards, Botswana was one of the poorest countries in Africa. Over the past 34 years, Government revenues from the diamond trade have been heavily invested in infrastructure and services to improve the quality of life. This has been implemented through an apparently ‘paternalistic’ approach of being resource driven by the Government, rather than demand driven by the people. Today, Botswana is seen as a economic and social model to which other African countries can aspire. However, is it sustainable through community and householder “ownership”?

A consequence of the substantial Government investments in social infrastructure may have been a change in the attitude of Botswana from one of self-interest and survival when the country had nothing, to one of “the Government should provide” when the financial resources became available. If this is the case, then it would account for the lack of any mechanisms for community participation and the lack of interest and “ownership”.

This attitude is also seen as contributing to the difficulties with the maintenance and emptying of on-site sanitation facilities, and to the potential use of the waste product as a resource. It is perhaps surprising that, in a country where there are more than twice as many cattle as people; which sees cattle ownership as the measure of wealth and position; and urban dwellers return to their “cattle posts” at weekends and during public holidays; very little use is made of cattle wastes for agricultural purposes, even on a smallholding scale. Whether this limited use of animal wastes arises from a cultural resistance to the handling of waste materials, or results from the lack of a perceived need to grow vegetables and crops as these are readily available through markets and shops, is unclear.



However, many Batswana have expressed the view that a similar, or possibly stronger, resistance exists to the handling and re-use of human waste products. The introduction of dehydrating latrines over the past two years was based on an assumption that householders would be prepared to empty the latrines themselves, and re-use the product for soil conditioning either at the household level, or on smallholdings.

As a result of the Government's subsidy policy, and without the necessary health education and social mobilisation support, it is doubted that communities and households will be prepared to fulfil their expected role in this regard. Since none of this type of latrine have yet reached the stage where they require emptying, there is no experience to prove the theories in either direction.

### Community based natural resources management

One approach which has a proven track record in mobilising community participation in development is that of Community Based Natural Resources Management.

The origins of this approach lie in the early attempts of the century to conserve endangered wildlife species and their habitats. Progressively the early conservation activities were extended to encompass wider biodiversity and biological issues beyond protection areas, and into rural areas in general.

In the late 1970's there was a shift from the former "top down" approach to conservation to a "grass roots" approach. This community based approach recognised that rural communities depend for their livelihoods on the sustainable use of natural resources such as soil, water, land and wildlife. In Southern Africa this new approach to conservation is called Community Based Natural Resources Management, or CBNRM.

Through CBNRM, rural communities are being encouraged to match their own needs with those of conserving their local environment. The CBNRM concept was introduced into Botswana more than ten years ago to pursue wildlife management and utilisation at the community level, and has been successful in addressing short term income generation and poverty alleviation in the poorest communities. CBNRM has been implemented through non-governmental organisations (NGOs) and community based organisations (CBOs). However, CBNRM has not yet established a link between these short term benefits and longer term holistic environmental management.

With the support of the International Union for the Conservation of Nature (IUCN) in Botswana, and by working through local NGOs, a new CBNRM project is about to be undertaken to try and establish this link and develop holistic environmental management at the community level.

### Linking environmental sanitation to CBNRM

The new CBNRM project provides an ideal opportunity and entry point for promoting community and householder participation in sanitation issues, and to integrate environmental sanitation and the potential for re-use of waste products, as part of an holistic approach to environmental management. As implementation at grass roots level will be through a NGO which is already working in the communities selected for the project, it is hoped that the attitudes of the community towards Government led initiatives, as described above, can be avoided.

This project will constitute one of the sub-projects of the proposed overall research initiative and will *inter alia* test out the environmental sanitation approach and the application of the Bellagio principles, particularly in the following areas:

- protecting the household and community environment;
- involving households and the community in decision making;
- managing waste as close as possible to its source; and
- harnessing the economic opportunities for waste recovery and re-use.

## Permaculture

A major element of the CBNRM approach in Botswana has been the application of the concept of “Permaculture” at the community and household level. Permaculture is based on observation of natural systems, combined with the experience of traditional farming methods and modern science and technology, to create a cultivated ecology that produces more food than is normally found naturally. The aim of Permaculture is:

*“To create systems of household agriculture and land use that are ecologically sound and economically viable, which provide for the needs of communities and households, do not exploit or pollute, and are sustainable in the long term.”*

It can be seen that this aim is strongly complementary to both the purpose of the proposed National Wastewater / Sanitation Policy, and the purpose of the overall research initiative, as stated earlier in this paper. The Permaculture concept also provides a strong link with the environmental sanitation objectives of water and wastewater conservation, and nutrient recovery.

## The project

The project will be funded through the GTZ support to the Department of Sanitation and Waste Management in the Ministry of Local Government of the Government of Botswana. Co-ordination and supervision will be provided by the Botswana Office of the IUCN, with the support of a Programme Officer to be recruited through DED. Day to day implementation will be carried out at the local level by the Permaculture Trust of Botswana. This NGO was established in 1989 and has focussed, with success, on working at grass root level with disadvantaged communities to create sustainable human environments focusing on household agriculture and land use.

Currently it is envisaged that the overall project will take place over a period of five years in selected communities which have already participated in the CBNRM programme. However, most of the environmental sanitation pilot studies will be carried out in the first three years.

The Inception Phase has already commenced with the aim of preparing a Project Planning Matrix, Plan of Operations and detailed budget.

## Acknowledgements

The author is grateful for permission to publish this paper and emphasises that the views expressed are those of the author and not necessarily those of the GTZ, the Department of Sanitation and Waste Management, or other organisations participating in this project.

**Annex 1: Stakeholders Views of the Problems of Current On-site Sanitation Technologies in Botswana**

<b>Simple Pit Latrines</b>	
<b>Strengths</b>	<b>Weaknesses</b>
<ul style="list-style-type: none"> <li>• Simple to construct with local expertise</li> <li>• Cheap to construct</li> <li>• Uses locally available materials for superstructure</li> <li>• No need to empty (no lining so dig new pit)</li> <li>• Takes all types of waste</li> <li>• Allows squatting and sitting</li> </ul>	<ul style="list-style-type: none"> <li>• Smell, flies and cockroaches, expensive to treat chemically</li> <li>• Can collapse</li> <li>• Increased risk of groundwater pollution</li> <li>• Cannot be re-used</li> <li>• Usually no hand washing facilities available</li> <li>• Not suitable for all areas</li> <li>• Not attractive to users</li> <li>• Users fear falling in</li> </ul>
<b>Single and Twin Pit VIP Latrines</b>	
<b>Strengths</b>	<b>Weaknesses</b>
<ul style="list-style-type: none"> <li>• Simple and cheap to construct</li> <li>• No water needed</li> <li>• Reduces risk to groundwater pollution if pit is sealed</li> <li>• No flies or smell if properly used</li> <li>• Can be used as part of bathroom</li> <li>• Long life (twin pit)</li> <li>• Takes any type of waste</li> </ul>	<ul style="list-style-type: none"> <li>• Emptiers frequently break down</li> <li>• Possibility of groundwater pollution if water table high</li> <li>• Access required for emptying</li> <li>• Problem of disposal of sludge</li> <li>• Users fear falling in</li> <li>• Sealed pits fill quickly</li> <li>• Not affordable to low income groups</li> <li>• Bad smell if not constructed properly</li> <li>• Emptying problems if incorrect anal cleaning materials used</li> </ul>
<b>Septic Tanks</b>	
<b>Strengths</b>	<b>Weaknesses</b>
<ul style="list-style-type: none"> <li>• Easy to construct</li> <li>• Relatively odourless for users</li> <li>• Good aesthetics</li> <li>• Long life</li> <li>• Easy and low maintenance</li> <li>• Easy to upgrade to sewerage system</li> <li>• Emptying technologies available</li> </ul>	<ul style="list-style-type: none"> <li>• Expensive to construct</li> <li>• Often poorly designed and constructed</li> <li>• Risk of groundwater pollution</li> <li>• Problems with cockroaches and mosquitoes</li> <li>• Requires regular water supply</li> <li>• Insufficient emptying services available</li> <li>• Access required for emptying</li> </ul>
<b>Dehydrating Latrine (based on two years operating experience)</b>	
<b>Strengths</b>	<b>Weaknesses</b>
<ul style="list-style-type: none"> <li>• No smell</li> <li>• Portable</li> <li>• No water needed</li> <li>• Cheap to operate</li> <li>• No groundwater pollution</li> <li>• Accommodates many users</li> <li>• Independent of soil conditions</li> <li>• Manual desludging possible</li> </ul>	<ul style="list-style-type: none"> <li>• Needs proper siting</li> <li>• Needs good construction</li> <li>• Accepts excreta and toilet paper only</li> <li>• Requires intensive user education</li> <li>• Expensive</li> <li>• Prefabricate units difficult to obtain in small numbers</li> <li>• Single supplier</li> </ul>

## The practise and potential of ecological sanitation in India and the sub-continent based on current research and demonstration of compost toilets in India.

**Paul Calvert**

EcoSolutions / Sustainable Technologies in the Community  
Pulari, Asan Nagar, Vallakadavu, Trivandrum 695008, Kerala,  
India  
Shortley Close, Robin Hoods, Bay, N.Yorkshire, YO22 4PB,  
England

**Family by family, neighbourhood by neighbourhood, we can :**  
**Stop wasting Water, Stop making Sewage, Start making Fertiliser,**  
**Improve Public Health and Nutrition**

If only 30% of India's projected 2021 urban population of 600 million used ecological sanitation it would save at least 3.6 million cubic metres of water per day and stop the production of at least 3.9 million cubic meters of sewage per day. It could also produce annually over 1 million tonnes of NPK fertiliser for use in urban agriculture - a crucial component in feeding the cities.

### 1. A Sizeable Challenge

#### 1.1 Population

India, Pakistan, Bangladesh face a huge pressure of population. India's population is over 1 billion and continues to grow. The effect of this is to dilute development efforts. Improvements in food production, health care, water supply and sanitation are hard-pressed to keep up with growth. India's Ninth Five Year Plan projects the urban population at 38% of the total population in 2006-07, it was 31% in 1996-97. During the last four and half decades, some 5-6 million people have been added to urban India every year. The country has one of the largest urban systems with 217.6 million people in 1991, which is projected to increase to 289 million in 2001 and around 605-618 million during 2021-2025. There will be about 40 metro cities in the country in 2001 as against 23 in 1991.

#### 1.2 Sanitation related diseases

In India, diarrhoea accounts directly for more than 733,000 deaths each year among children under five, and is clearly associated with the annual 105.2 million cases of malnutrition occurring in the same population.<sup>1</sup>

Thirty million Indians suffer from sanitation related diseases annually. The economic loss to the country due to workdays lost from these causes is estimated at around 270 million US dollars per year.<sup>2</sup>

<sup>1</sup> State Of The Environment of Andhra Pradesh, AP State Pollution Control Board Web Site Oct. 2000

<sup>2</sup> Central Bureau of Health Intelligence, Government of India, 1996

### 1.3 Sanitation and water

Urban sanitation coverage in India is probably around 50% and urban access to safe drinking water around 85%. (The situation in the rural areas is less than half of these figures). The aim of the Eighth Plan was to increase the coverage of access to safe drinking water from 84% to about 94% of the urban population and of urban sanitation services from 48% to 69%. The reality was that the increasing urban population and under-performance on the plan resulted in no improvement in percentage terms.

Of India's 400 major towns only 200 are sewered and these only partially. Where this sewage ends up is apparent when one notes that all India's rivers are heavily polluted. 70% of that pollution is sewage.<sup>3</sup>

### 1.4 Fertiliser

India needs to increase fertiliser use to boost food production to chase population growth. India used 14.3 million tonnes of fertiliser in 1997 and currently uses around 20 million tonnes annually. The Ninth Five Year Plan seeks to encourage increases as current application rates are far lower than China and even lag behind Bangladesh and Pakistan. (India currently 90 kg per hectare, against 160 kg per hectare in China). Production of fertiliser uses valuable hydrocarbons (India uses mostly domestic fuel for fertiliser production) and necessitates significant imports of ammonia and phosphates. Whilst the country has reached self-sufficiency with respect to urea availability at current demand there is a steady increase in the subsidy bill which is entirely because of the steep increases in the feedstock and fuel prices, and also due to the fact that most fresh capacity addition in the recent past is based on naphtha, the price of which has almost doubled.<sup>4</sup> However the government plans to phase out subsidies on urea fertiliser over the next 5 to 7 years. Current application is skewed (due to subsidy on urea and not on phosphatic and potassic fertiliser) from the optimum NPK ratio of 4 : 2 : 1, to an actual average application ratio in India of 10 : 2.9 : 1 (1997)

As humans we produce 4.56kg N, 0.55kg P and 1.28kg K per person per year in our faeces and urine combined. This is an NPK ratio of 3.56 : 0.43 : 1.

Today in India there are over a billion people. Although it is a simplistic way to look at it their faecal matter and urine amount to potentially 6 million tonnes of NPK fertiliser per year. Looked at another way this is equivalent to almost one third of the nation's current annual fertiliser use.

### 1.5 Limitations of conventional sanitation

Conventional approaches to sanitation which are based on either transport of human excreta by water or use water to soak the excreta into the ground leave much to be desired:

- they waste precious water resources
- they pollute ground water, lakes, seas and rivers
- they waste the nutrients available in the excreta
- they are expensive
- and because they invariably transport untreated human excreta into the rivers they are a major cause of disease.

<sup>3</sup> Centre for Science and Environment, Web Site and Down to Earth Magazine

<sup>4</sup> May 21 2000 Hindu Business Line Investment World, Urea segment hampered by dithering on policy Mr P K Madhav, Director Finance, Nargajuna Fertilisers and Chemicals Ltd.

With increasing urban population the investment in sewerage sanitation and on-plot sanitation in towns and cities will be immense. India does not have the resources for that. It is also most improbable that should comprehensive sewerage be installed that it should carry all the sewage to effective treatment plants. In all probability the vast majority of it will end up in the rivers and coastal waters with all the consequent effects on public health and the environment (eutrophication of rivers, pollution of coastlines, destruction of coral reefs, etc.). Northern governments and water companies, with far greater public health budgets than the Indian sub-continent, face significant problems with sewage treatment and sludge disposal. Developing nations do not need to follow down this mistaken path. The water demand in order to operate flush toilets on such a scale should alone be enough to convince municipalities and the state governments that such a course of development is unrealistic. One answer, that too much hope is pinned on, is on-plot sanitation using pour flush and cistern flush toilets where the effluent is “disposed of” through soak pits or septic tanks. This too is not an altogether sustainable approach to a problem of such scale. It does not overcome the problem of high water demand and it will surely pollute underground aquifers and water bodies in many locations. Whilst the sludge from the pits and septic tanks can be used on fields it is unpleasant and often hazardous to remove, most of the nutrients have been lost and it should receive additional treatment before use.

## 2. A contribution to the solution

### 2.1 Ecological sanitation

Ecological sanitation offers massive savings in water usage, complete protection of all water sources, rivers, ground water, coastal water and coral reefs and the production of significant quantities of fertiliser. Rather than being a service that only absorbs funds and energy it can generate income and nutrition. It also offers greater protection from malaria. Waterborne sanitation systems, septic tanks and soak pits are frequently significant mosquito breeding sites. Ecological sanitation does not provide these sites and can therefore potentially have a positive impact on malaria reduction.

Ecological sanitation comprises mostly non-flush non-waterborne sanitation technologies. The most significant of these are composting and desiccating toilets with and without urine diversion. However urine diversion is particularly attractive because it has by far the greater volume, is in most cases sterile, contains the majority of the nutrients and can be used directly, with dilution, as a plant fertiliser. Urine diversion keeps the faecal matter separate where its much smaller volume is simple to contain in a small space and process, by composting or desiccation, to a useful, safe, non odorous soil improver and fertiliser.

If only 30% of India’s projected 2021 urban population of 600 million used ecological sanitation it would save at least 3.6 million cubic metres of water per day and stop the production of at least 3.9 million cubic meters of sewage per day. It would produce annually 820,000 tonnes of N nutrient (or at least 400,000 tonnes even allowing for 50% loss through volatility), 99,000 tonnes of P nutrient and 230,000 tonnes of K nutrient.

The cities of the future are going to be increasingly difficult to feed. A city of 10 million requires the import 6000 tonnes of food per day.<sup>5,6</sup> A significant quantity of this food will have to be produced in the cities and peri-urban areas themselves. Ecological sanitation could provide

<sup>5</sup> FAO-SOFA, The State of Food and Agriculture, FAO, Rome, 1998

<sup>6</sup> Esrey SA. Towards a Recycling Society, Ecological sanitation, closing the loop to food security 10th Stockholm Water Symposium, August 2000

significant quantities of fertiliser close to where it is required to support this if political will and confidence are generated.

With over 80% of the rural population currently without sanitation the potential of widespread promotion of ecological sanitation on agriculture, environment and public health in India's villages and small towns must also become increasingly attractive and desirable to the government.

None of this should be seen as a threat to fertiliser manufacturers as application rates are still far below those desired by most agriculturists. Fertilisers produced through ecological sanitation should be viewed as a valuable supplement to chemically produced ones and, being deficient in potassium will always require additional inputs of this nutrient.

Ecologically transformed human excreta is not contaminated with heavy metals and toxic chemicals like sewage sludge. Sewage sludge accumulates these undesirables because domestic sewage is mixed with industrial effluent, pesticide run-off and anything else people care to throw down the drains.

Better industrial pollution control and the use of ecological sanitation can render used water flows far more amenable for use in agriculture and horticulture. Water quality can be improved by employing lagooning systems, constructed wetlands and organic filters. Raising the quality of grey water, maximising its beneficial reuse and promoting rain water harvesting are complimentary to ecological sanitation and should be encouraged whenever and where ever possible.

## 2.2 Awareness

Ecological sanitation needs to be rapidly brought to the attention of policy makers and planners. This includes incorporating the products of ecological sanitation into urban agriculture which has a significant role to play in feeding the cities of the future. Over 600 million urban dwellers in India by 2021 are going to need water, food and sanitation. Ecological sanitation has positive attributes in each of these areas. The longer the delay in generating this awareness the more money that is being spent on unsustainable sanitation which will generate increasing water shortages, energy demands and pollution in the future. Large scale development plans are a long time in the conceiving, the writing and the implementation. Once cast they are hard to change. One of our tasks should be to ensure that ecological approaches to sanitation are on the development agenda of the government and precious development funds are not squandered on sanitation projects that will run short of water before they are finished. To quote from the Ninth Five Year Plan: "A large part of civic amenities, particularly water supply, sanitation and sewerage, are managed with assets that have outlived their operational efficiency. The required massive upgradation and renovation of these assets, is constrained by high population density and concentrated commercial activities at the locations where these service assets are installed. The lack of comprehensive urban planning in the past to promote regular upgradation and renewal has resulted in a large backlog of development activities". The government needs solutions and alternatives, ecological sanitation certainly holds some of the answers.

Resistance to the concept of ecological sanitation comes from people having been trained repeatedly through their professional lives that water seal toilets are one of the keys to better health and the most desirable sanitation option to achieve it. Indeed one of the goals of the Government of India is to convert all urban dry toilets to water seal toilets by 2002. With a much greater awareness of eco-san this goal could have been to convert then to ecological toilets.

Resistance also comes from the psychological and imaginary fears about a toilet you can "see" into. People also fear the toilets will smell. The only real cure for this scepticism is for there to be good practical demonstrations and for visits to be arranged for officials to learn first hand that

eco-sanitation does not smell, is attractive, users are happy with it and the products are inoffensive and valuable.

### 2.3 Practical demonstration of ecological sanitation in India.

The author learnt the problems of conventional sanitation through practical experience of solving village sanitation problems in densely populated, high water table villages in Kerala. The desire to protect people's health and protect the ground water and environment from pollution led to the development of a urine diverting compost toilet <sup>7</sup>. This comprises a pair of brick-built chambers, above ground, that store and process the faecal matter. Urine is diverted at the squatting pan (or seat if preferred) and, combined with anal cleansing water, is directed, sub surface, to an evaporative plant bed or productive garden outside the toilet or house. Where the urine is to be applied manually to plants the anal cleansing water alone is directed sub-surface to the plant bed or productive garden. The urine is collected, diluted and applied fresh to flowers, vegetables or fruits. The faecal chambers are primed with straw before use. They take 6 to 12 months to fill and then the contents remain inside for storage for a further 6 -12 months before emptying. The cycle time depends on the number of users.

Now local people understand the technology, they want it because it saves water and because it works in their high water table environment. Their initial fears about what would come out of the toilet have evaporated and they are happy to empty and use the compost which bears no resemblance to its origins - it is pleasant and odourless, like forest soil. Families are beginning to learn the value of urine as a fertiliser and to use it productively.

Over 150 of these toilets are operating in crowded villages and peri urban areas. Some have been built inside or as part of the house. They are in use by Hindus, Muslims and Christians and by a range of income groups. A number of them use the urine and compost to grow bananas, chillies, brinjal, bitter gourd, anthuriums and potted ornamental plants.

Research on the compost produced by these toilets shows it to be free of coliforms and *Ascaris ova*, the latter being a key indicator of the effectiveness of a sanitary device in killing pathogens.<sup>8,9</sup>

This demonstration work, started in 1995, solving the real needs of people in high water table areas has expanded naturally refining the designs and developing new ones to suit high income families, modern and traditional homes and apartments.

Whilst it is understood that on the basis of a few small pilot projects government can not commit major funds to a sanitation technology that is alien to them the pace at which effective demonstrations (in a wide variety of economic groups, cultural, religious contexts and in urban, peri-urban and rural settings) needs to be stepped up. Such work must seek urgently to build awareness and confidence at all levels of the decision making apparatus so that ecological sanitation and its potential are better understood. If the interest evoked by the work by in Kerala is anything to go by successful demonstrations are a valuable awareness raising tool. Recognition of the work amongst those drafting contributions to the Ninth Five Year Plan led to the compost toilet being mentioned at least as an alternative sanitation technology to be considered in rural areas. It is a small step in the right direction, but the truth is that very few

<sup>7</sup> Seeing (and not smelling) is believing, Kerala's compost toilet. Jan 1997, Waterlines, Intermediate Technology Publications, 103 Southampton Row, London

<sup>8</sup> Calvert P. and Thankamani V. August 2000, Comparative Study of Villages Soils and Compost from Compost Toilets in Kerala draft, study ongoing)

<sup>9</sup> Feachem Bradley Garelick and Mara 1983, Sanitation and Disease: Health Aspects of Excreta and Wastewater Management, John Wiley and Sons, p501)



people understand what a compost toilet or desiccating toilet is, at best they consider such things might be suitable for the rural poor. We need to raise greater awareness.

## 2.4 Establishing ecological sanitation in India and the sub-continent

National and State Governments in India should commit funds to develop, demonstrate and research this approach. Funds from multi-lateral and bi-lateral agencies also need to be directed into education about, demonstration of and research into ecological sanitation. There are a number of professionals around the world who know how to develop, design and adapt ecological solutions to suit diverse environments, cultures and socio-economic settings. Their skills should be tapped. Large construction firms seeking big contracts for sewerage projects need to be turned into allies rather than obstacles to the development of ecological sanitation. The scale on which acceptance and support for this sustainable approach to sanitation needs to take place means that big players as well as small have a role, private sector and public, government institutions, civil societies and community based organisations. There are roles for masons, community volunteers, sanitaryware makers large and small, entrepreneurs, health and hygiene workers, teachers, social workers, women's groups, Public Health and Sanitation engineers, architects, scientists and doctors. Particular account should be taken of raising awareness of ecological sanitation amongst women. They invariably have more to gain from the privacy that safe sanitation offers (safety from harassment, ability to manage menstruation in a more dignified and hygienic manner, and where water has to be carried, be it in villages or multi-storey tenement buildings they will benefit from not having to carry water for flushing) They are often quicker to see the benefits of ecological sanitation and firm in their decisions that it is the technology of choice for their homes.

## 2.5 Standards

Standards will have to be set to ensure that only safe systems are installed. However legal frameworks should not be arbitrarily set or necessarily based on conventional sanitation practices but established on sound practical work on ecological sanitation in the regional context. As a starting point a storage time of six months for faecal matter should be considered the minimum. Urine, if not contaminated with faecal matter is generally safe and can be diluted and applied directly to the soil in domestic applications. In Sweden it is stored in tanks for six months before application to the fields but this does present problems of large storage volumes and nitrogen losses. Subsurface irrigation should also be considered in order to use the urine soon after production overcoming storage problems and limiting losses. This would comply with the Engelburg Criteria for safe reuse.<sup>10</sup>

## 2.6 Employment creation

Ecological sanitation offers the opportunity in many locations to reduce the burden on government of managing, maintaining and extending or replacing ailing sewerage systems. Manufacture, installation and maintenance of ecological sanitation systems can generate a comprehensive private service industry. Collection and use of ecological sanitation products can become a viable business for many urban entrepreneurs. Ecological sanitation offers great potential for greening the cities and boosting urban agriculture in India and her neighbours. Application of the products can range from the industrial scale to the household. Although the key demand is likely to be for urban agriculture in peri-urban farms there will be many urban

<sup>10</sup> Guidelines for the Safe Use of Wastewater and Excreta in Agriculture and Aquaculture, Mara D and Cairncross S published by the WHO in collaboration with UNEP 1989, Geneva.

colonies and neighbourhoods which could undertake their own recycling of nutrients in roof gardens, street borders and central reservations, municipal parks and communal areas, growing flowering shrubs and fruit trees, household flowers, and vegetables, shade trees and fodder.

### 3. Conclusion

Eco sanitation will have a significant role to play in India and the region. It has to happen because waterborne and water -flush sanitation are quite simply unsustainable for these rapidly growing urban populations. It is better to foresee the awful reality of water-starved towns and cities with sewage polluted aquifers and rivers, epidemics and food shortages, and choose to develop and promote ecological sanitation now rather than amidst the crisis - the beginning of which is already here.

# Implementing the Bellagio Principles and the HCES approach: a framework for action

**John Kalbermatten**

Kalbermatten Associates, Inc.  
3630 Garfield Street N.W., Washington D.C. 20007-1443, USA

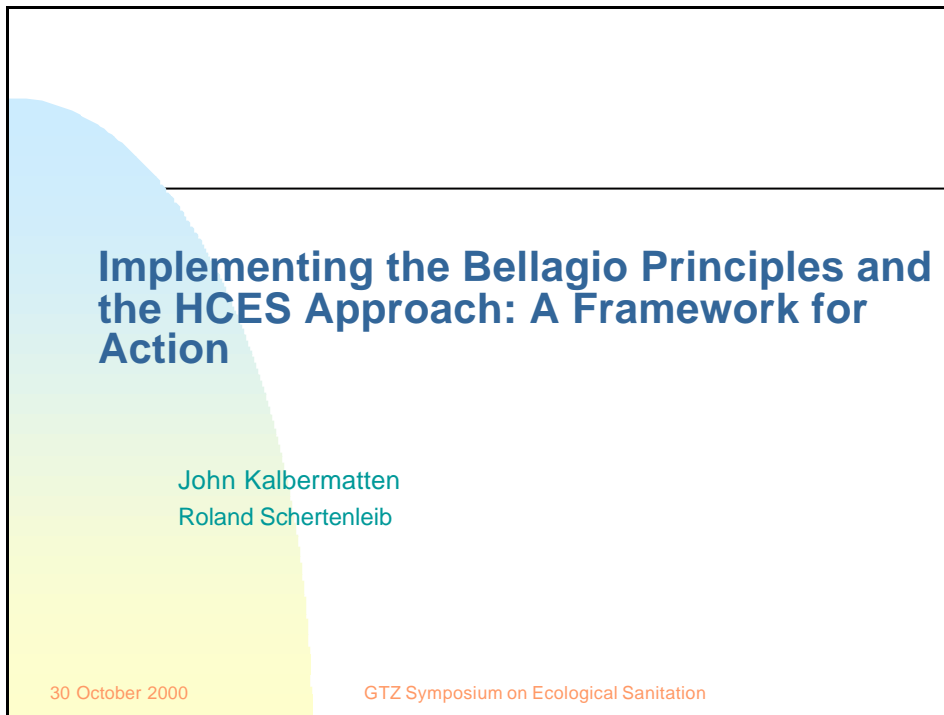

## Steps in the implementation of the HCES Approach

- Preparation of Provisional Guidelines (PG) for the implementation of the HCES Approach
- Review of existing technologies and “software” to evaluate their effectiveness as part of the HCES Approach
- Preparation of HCES Case Studies based on information from existing ES projects

30 October 2000

GTZ Symposium on Ecological Sanitation

## Steps in the implementation of the HCES Approach (cont.)

- Design and Implementation of HCES Demonstration Projects
- Applied Research to generate new Technologies and Approaches suitable for the HCES Approach
- Risk Assessment and Limitations to safeguard public health

30 October 2000

GTZ Symposium on Ecological Sanitation

## Provisional Guidelines

- For municipal decision makers
- State clearly what role other levels of government, the affected stakeholders (household and community) and the private sector have to play
- Recommendations on how the private sector can participate in the provision of ES services (e.g. service contracts to manage decentralised systems)

30 October 2000

GTZ Symposium on Ecological Sanitation

## Review of existing technologies and software

- Review the potential and limitations of existing technical alternatives
  - ◆ User friendliness
  - ◆ Environmental friendliness (closing cycles)
  - ◆ Treatment efficiency
  - ◆ Application within a system that emphasizes the benefits of synergism
- Determine necessary improvements

30 October 2000

GTZ Symposium on Ecological Sanitation

## Preparation of HCES Case Studies

- Gain a realistic understanding of the expected impact of the HCES Approach and provide recommendations on how the approach should be implemented
- Learn from existing cases where communities have recently improved one or more ES sub-sectors and study how the whole complement of ES sub-sectors could have been implemented
- Emphasis on holistic planning, environmental, operational and financial sustainability as well as impact on natural resources

30 October 2000

GTZ Symposium on Ecological Sanitation

## Design and Implementation of HCES Demonstration Projects

- Demonstrate the feasibility and effectiveness of the HCES Approach under different socio-economic and cultural conditions
- Based on lessons learned from case studies and results from applied research activities
- Emphasis on holistic planning, environmental, operational and financial sustainability as well as impact on natural resources

30 October 2000

GTZ Symposium on Ecological Sanitation

## Supporting Research and Investigations

- Planning aspects
- Regulatory aspects
- Institutional aspects
- Private Sector Participation
- Financing aspects
- Socio-cultural aspects
- Technological aspects
- Anticipated Benefits and Risks

30 October 2000

GTZ Symposium on Ecological Sanitation

## Planning aspects

- Development of criteria governing planning set by municipality within national or regional framework
- Evaluation and refinement of demand-responsive approaches, Willingness to Pay, Contingent Valuation, and other tools for establishing demand for particular level of service
- Review of appropriateness of conventional design criteria and assumptions in light
- Development of tools for evaluation of the benefits of improved ES as basis for justifying investments, allocating costs and providing subsidies

30 October 2000

GTZ Symposium on Ecological Sanitation

## Regulatory aspects

- How to develop a regulatory framework that
  - ◆ encourages the full participation of all stakeholders
  - ◆ lead to transparent and effective application of realistic standards
  - ◆ facilitates inter-zonal negotiations and agreements
- Review the appropriateness of existing standards and regulations and evaluate their impact on the implementation of the HCES approach

30 October 2000

GTZ Symposium on Ecological Sanitation

## Institutional aspects

- „State of the art review“ on the role of households, community-level organisations and small entrepreneurs in urban upgrading
- Institutional arrangements for inter-zonal elements
- Review the potential and limitations of private sector participation in different forms (e.g. service contracts, management contracts, concessions).

30 October 2000

GTZ Symposium on Ecological Sanitation



## Financing aspects

- Compilation of experience on methods and effectiveness of resource mobilisation and cost recovery, focussing on household-level expenditures
- Mechanisms for setting tariffs by zone or sub-zone reflecting the selected service standards and the import/export implications between zones
- Clear policy and justification for targetted and transparent subsidies and incentives
- Identification of different forms of access to credit by householders and communities

30 October 2000

GTZ Symposium on Ecological Sanitation

## Socio-cultural aspects

- Compilation of socio-cultural factors critical to successful application of Bellagio principles and the HCES approach such as
  - ◆ Decision taking processes at community level
  - ◆ Sharing taboos
  - ◆ Attitudes toward recycling of waste products
  - ◆ Mechanism for behaviour change
  - ◆ etc.

30 October 2000

GTZ Symposium on Ecological Sanitation

## Technological aspects

- Review the potential and limitations of existing technical alternatives with special emphasis on decentralised systems at household and community level:
  - ◆ User friendliness
  - ◆ Environmental friendliness (fate of pathogens and micro-pollutants such as EDCs)
  - ◆ Saving of natural resources (e.g. closing nutrient and water cycles)
  - ◆ Removal efficiencies for different kind of pollutants
  - ◆ Financial requirements (capital and O&M costs)
  - ◆ Institutional requirements
  - ◆ Requirements for skilled labor (education and training)

30 October 2000

GTZ Symposium on Ecological Sanitation

## Anticipated Benefits and Risks

- Implementing the Bellagio Principles should not add risks to either human health or the environment.
- Research has to carefully evaluate possible trade-offs in benefits and risks resulting from the proposed new holistic approaches to ensure that the anticipated benefits from greater sustainability of simpler methods and systems are not diminished by greater risks to health and environment

30 October 2000

GTZ Symposium on Ecological Sanitation



## Results of Parallel Session 2 presented at the plenary

"What are the needs for international action implementing the Bellagio-Principles and the HCES-approach?"

1. Technical solutions exist, although further improvements will still occur, adaptations are needed
2. Problem is lack of motivation / participatory process in planning and management
3. Users are interested in comfort and convenience; planners should respond to that demand
4. - Long-term objective is universal use of ecosan, i.e.  
prevent pollution  
destroy pathogens  
recycle nutrients  
- and make money of it according to economic dictum:  
waste is a displaced resource
5. Plan and implement ecosan for medium/small cities - choose suitable communities, ex. Where
  - committed mayor,
  - available CBO
  - already included in agenda 21,
  - potential financial support available
  - readiness to start (tangible action)
  - financial participation of stakeholders!don't exclude risk projects!

**Framework for action**

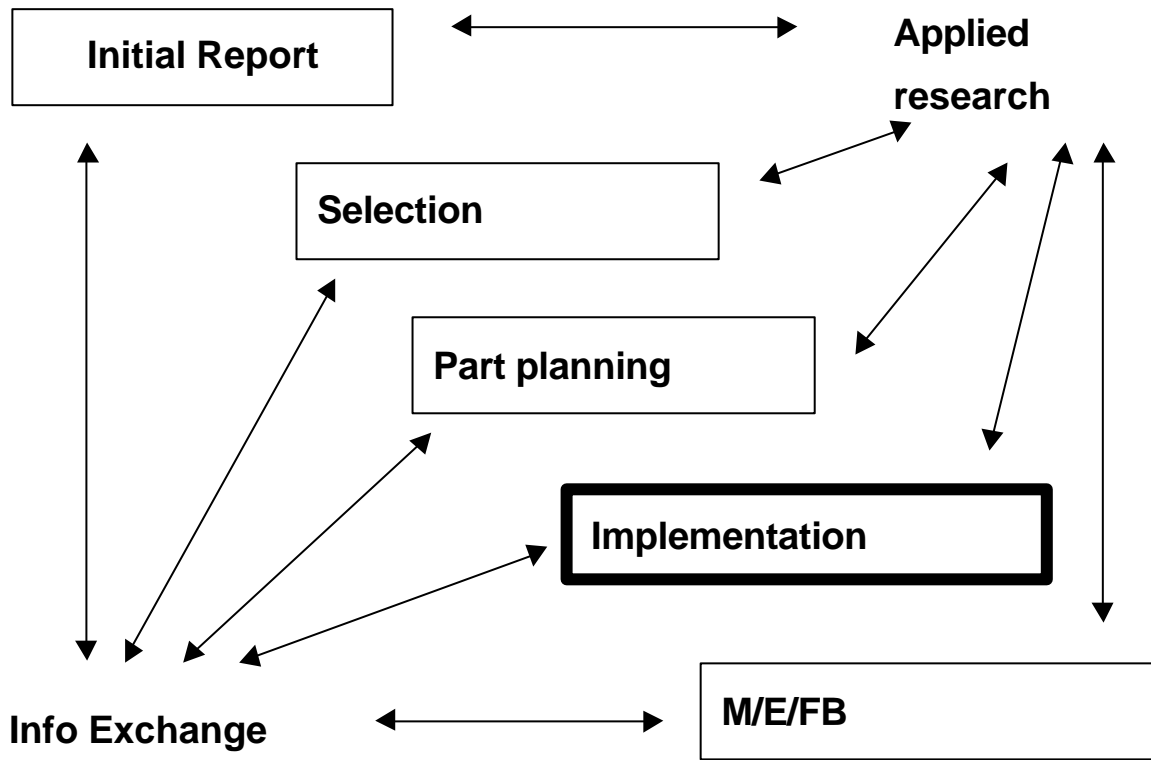

## Minutes of Parallel Session 2 <sup>1</sup>

Following a brief introductory discussion, there was general agreement on the following points:

- Technologies are available, but implementation on a large scale is still lacking.
- The limiting factors for application of Ecosan techniques are:
  - lack of practical experience
  - lack of information
  - lack of acceptance within the population.
- The workshop should focus on how to implement technologies that are already known.

After that, the participants discussed the steps to follow towards an enhancement of sanitation strategies according to the Bellagio principles and which kind of activities GTZ should engage in within this framework.

The implementation of numerous pilot projects was identified as the most vital step. A successful pilot project can be useful in helping to more easily convince decision makers of the feasibility and advantages of sanitation concepts based on the Ecosan approach. The following scheme, according to which GTZ could proceed within the scope of the project, was proposed:

- 1 Development of a baseline paper
- 2 Selection of small urban and peri-urban areas
- 3 Communication, i.e., informing and involving stakeholders
- 4 Planning / implementation
- 5 Documentation of outcomes / networking

These points are described in more detail below (items 1 through 5):

### 1 Development of a baseline paper

- The paper should give an overview of:
  - existing Ecosan technologies
  - implemented-project documentation
  - ongoing-project monitoring activities
- The audience should express their willingness to help elaborate such a document, e.g., by forming a working group. That working group could also participate in step 2.
- The document should be made available, via several media, to anyone working on Ecosan.

<sup>1</sup> Minutes taken by Anke Hildebrandt

## 2 Selection of small urban and peri-urban areas

- Aim # 1: It should be ensured that the project will not be carried out by GTZ but by local stakeholders.
- Aim # 2: Different technologies tailored to the individual characteristics of the selected communities should be implemented.
- Proposals on the implementation of pilot projects to be fully financed should be solicited.
- Candidates should be selected on the basis of criteria designed to ensure fulfillment of the above aims. Such criteria could include:
  - selection of cities already engaged in Agenda 21, which can be expected to exhibit a willingness to get organized and pursue sustainable, holistic approaches
  - giving preference to cities with developed municipal structures
  - being sure to include cities with various sociocultural backgrounds
- Not only low-risk projects, but risky projects as well, should be financed, because:
  - projects assumed to be of low risk can fail to the same degree as high-risk projects. Indeed, high-risk projects can have even better chances of success, because the partners are likely to be more highly motivated
  - low-risk projects are easier to finance through different sources and are more likely to attract facilitators
  - high-risk projects are more likely to have innovative content

## 3 Communication, i.e., informing and involving stakeholders

- Decision makers and governments need to be sensitized with regard to ecological sanitation, because:
  - this promotes the implementation of such basic laws as those which facilitate involvement of the population
  - a common awareness of the need for sanitation has to be instilled in the general populace – at first through information and later on by way of legislation - and public control over the disposal of human excreta must be established
  - since Ecosan begins with urban planning, the planning division staff must be informed about the advantages of Ecosan
  - similarly, decision makers and stakeholders must be provided with adequate technical and promotional information about Ecosan and its advantages, the aim being to keep them from striving toward conventional, western-style sanitation technology
- Other development organizations must be made aware of Ecosan, as they frequently tend to lean toward conventional, environmentally detrimental technology
- The general populace needs to be informed about the advantages of Ecosan and sanitation in general, particularly with regard to:
  - public-health improvement
  - infrastructural improvement

- improved well-being and convenience
- potentials for new economic activities
- Potential contact persons:
  - women in particular need to be convinced, since they are traditionally responsible for matters related to water and sanitation
  - local groups for community-scale implementation make good contacts, since they are pursuing their own interests and hence, are easy to motivate
  - governments, as the bodies responsible for legal reforms and other political decisions, cannot be left out, but governments often display a remoteness from the people, and there is danger of corruption anywhere above the local scale

#### **4 Planning, implementation**

- Investments should be kept small and, hence, affordable for other communities without outside funding. In this connection, GTZ's most important role is to convince governments and decision makers
- An investment program is needed to enable distribution of the financial load across the local, governmental and institutional levels, the latter including such institutions as the World Bank

#### **5 Documentation of outcomes/networking**

- There is need of an umbrella with a span to encompass all interested parties and the capability to promote and facilitate the exchange and transfer of know-how
- Preparation of the baseline paper (mentioned in # 1 above) could emerge as one of the first common tasks of such a community
- Another important step would be to organize another conference and to provide continuous information about ongoing projects





## List of participants

Bark	Kerstin	Netherlands	Consultant
Behnke	Stefan	Germany	Roediger Vakuum- und Haustechnik GmbH
Calvert	Paul	India / UK	Eco-Solutions
Dörner	Stefan	Germany	GKW Consult GmbH
Euler	Hartlieb	Germany	TBW GmbH
Franken	Gudrun	Germany	Federal Institute for Geoscience and Natural Resources
Fuhrmann	Tim	Germany	Universität Witten/Herdecke
Guhr	Ingo	Lao P.D.R.	UNDP / NORAD
Hailer	Josef	Germany	Gesellschaft für Wassertechnik und Apparatebau GmbH
Heeb	Johannes	Switzerland	seecon GmbH International Ecological Engineering Society
Helming	Stefan	Germany	GTZ
Hildebrandt	Anke	Germany	GTZ
Kalbermatten	John	USA	Kalbermatten Associates, Inc.
Karunalingam	V.	Sri Lanka	National Water Supply & Drainage Board
Kishor Mishra	Nawal	Nepal	Department of Water Supply and Sewerage
Kresse	Klaus	Costa Rica	CAPRE / GTZ
Le Jallé	Christophe	France	Programme Solidarité Eau
Makinson	Sandra	Germany	International Council for Local Environmental Initiatives
Neis	Uwe	Germany	Technische Universität Hamburg-Harburg
Reuter	Stefan	Germany	BORDA e.V.
Richards	Tony	Botswana	GTZ
Rijnsburger	Jaap	Netherlands	WASTE
Schattauer	Hans	Austria	Institute for Water Provision - BOKU
Schertenleib	Roland	Switzerland	SANDEC / EAWAG
Stenström	Thor Axel	Sweden	Swedish Institute for Infectious Disease Control
Vasudevan	N.	India	Anna University
Vida	Jochen	Germany	DECON Deutsche Energie-Consult Ingenieurgesellschaft mbH
Wehrle	Karl	Switzerland	SKAT
Wyss	Philippe	Switzerland	University of Applied Sciences Wädenswil



## Parallel Session 3

# Implementation of holistic sanitation strategies within socio-cultural, political and urban planning frameworks

**Key Question:** „What are the strategies to achieve the acceptance and participation of target groups and politicians?“

**Moderators:** **Uno Winblad** (Consultant, Sweden)  
**Madeleen Wegelin-Schuringa** (IRC, Netherlands)

## Lectures

**Ecological sanitation – case study Oromiya/Ethiopia**  
Prof. Dr. Gerd Förch (GTZ / Rodeco, Ethiopia)

**Public awareness and mobilisation for ecosanitation**  
Madeleen Wegelin-Schuringa (IRC, Netherlands)

**Potentials of alternative water systems from the economical point of view**  
Prof. Dr. Dr. Karl-Ulrich Rudolph (Consultant, Germany)



## Ecological sanitation - case study Adulala-Oromiya/Ethiopia

**Prof. Dr. Gerd Förch**

Siegen University, RODECO Consulting GmbH  
POBox 3066, Addis Ababa, Ethiopia

**Ayana Kalbessa**

Oromiya Water Mineral and Energy Resources Development  
Bureau  
POBox 3066, Addis Ababa, Ethiopia

### The general background

The crucial question in rural Ethiopia is not, what kind of sanitation is the best, but how to introduce sanitation at all.<sup>1 2</sup>

Water is still one of the best and culturally accepted means to keep personal hygiene, which is essential in a country with high rates of water borne and food related diseases.

From rural water supply schemes we know that community management concepts are an option for reaching sustainable services, if a clear financial responsibility is included.<sup>3</sup>

For sanitation concepts it has been agreed that the individual users need to finance the facilities.<sup>4</sup>

Consequently, only such technical options are sustainable (or appropriate) if they can be financed and operated by the users or their agents.<sup>5</sup>

The direct benefits of any measure must be made visible or known to the users.

Therefore, establishing means for income generation, before any infrastructure can be built or operated, may be a good start of improving water supply and sanitation at community level.<sup>6</sup>

Since direct defecation in open spaces is common in (rural) Ethiopia we don't need to introduce water borne sewage, on site sanitation is easily understood.

However, in far the most cases handling of human excreta is a cultural problem: what is falling behind you is already forgotten.

Resource management (including excreta) is in most cases neither applied nor felt necessary, only Konso and Dorze people utilise also human excreta as manure.<sup>7</sup>

<sup>1</sup> Only less than 5% of the overall population in Ethiopia have got access to some kind of sanitation facilities (Alemayo/Förch (2000): Water Sector Development in Oromiya, VII GTZ Water + Waste Sector Network Meeting, October 16-19, 2000, Adaama, Ethiopia)

<sup>2</sup> Förch,G. (2000) Sanitation Needs in Oromiya, VI International Workshop on Integrated Water Resources Management, AWTI, Arba Minch, Ethiopia, July 2000

<sup>3</sup> Förch,G (1999) Sustainable Water Services and Finances, WSP-AF Workshop on Financing Community Water Supply and Sanitation, Mpumalanga, White River, SA, December 1999

<sup>4</sup> WSP-AF (1999) Mpumalanga Statement on Financing Community Water Supply and Sanitation, Mpumalanga, White River, SA, December 1999

<sup>5</sup> Förch,G. (2000) Water Costs Money - The User Has to Pay His Part, VIII Nile 2002 Conference Comprehensive Water Resources Management for the Nile Basin - Priorities for the New Century, Addis Ababa, June 2000

<sup>6</sup> Women Aid Ethiopia, Report by Sahle-Moges, GTZ Water + Waste Sector Network Meeting, 16 – 19 October, 2000, Adaama, Ethiopia

<sup>7</sup> Konso and Dorze are small people in Southern Ethiopia, who are used to live in fortified villages and who developed a remarkable system of integrated agriculture and resource management

The major energy source in rural Ethiopia is still firewood. Almost everywhere, the resources are depleting at an increasing pace. However, for any kind of machinery diesel generators produce the necessary electricity.

### The project input

The project has been asked to support the development of a sanitation strategy for the regional state of Oromiya.

We decided to select a pilot sanitation plot, after a common meeting between different institutions on regional level failed to produce any good result.<sup>8</sup>

As a pilot village Adulala has been selected, which is 30 km off the main road in the Rift Valley and about 80 km from the capital Addis Ababa.

There are 5000 residents, they don't have access to the national grid, they have schools and a health centre, no further industry, depending on agriculture: cash income is normally derived from selling cattle to the local and regional market. Therefore, at market days several thousand people are coming to town.

The village has got a functioning water committee, which is producing and selling drinking water on full cost coverage basis.

The villagers are complaining about the accumulation of waste in their streets (including condoms as a result of the HIV campaigns and dog cadavers as a result from poisoning regularly done by the health bureau).<sup>9</sup>

They formulated a strong demand for basic sanitation facilities, like pit latrines, washing places and showers. There is no water source but a deep well. During the rainy season heavy surface runoff is causing flooding and gully erosion.<sup>10</sup>

The village received a first training on environmental sanitation in September 2000; they started regular garbage collection in May this year.<sup>11</sup>

The project assessed the situation: a first proposal for a sanitation concept has been developed and shall be soon discussed with the villagers.

The Water Committee is interested in investing into biogas digesters for substituting fuel for their generator.

The concept reads as follows:

- The garbage collection shall be organised on a regular basis; degradable organic matter shall be separated for composting or direct use in biogas digesters; a suitable disposal site shall be identified and operated; at least garbage collection may generate some income for local workers.
- Public showers and washing places need to be constructed at least near to the market places and operated against payment, the runoff should be directed to biogas digesters.
- Public toilettes or toilettes accessible for the public need to be constructed at the market places; the refuse shall directly feed Biogas digesters. Operation costs are to be covered from the benefits resulting from energy production.

<sup>8</sup> OWMERDB, Report on Common Sanitation Workshop, Finfinne, December 1999

<sup>9</sup> public gathering in Adulala, July 2000

<sup>10</sup> Public gathering in Adulala, July 2000

<sup>11</sup> Training report, September 2000

- Human and animal excreta shall be disposed of by using biogas digesters, which offer the owners a directly available source of energy as well as a kind of manure for household gardening.<sup>12</sup>
- The first step is to construct a 16 m<sup>3</sup> digester for an individual/private investor to show that the concept is working.<sup>13</sup>
- The next steps are to attract further local investors (grinding mills run by diesel generators, restaurants, etc) for directly using human and animal excreta as well as „green“ garbage for loading the digesters.<sup>14</sup>
- The Water Committee is as well encouraged to construct small digesters directly supplied with excreta from public latrines and showers.
- The surplus gas shall be transported to the generators by means of pipelines. The transport is possible since the concept is working with a fixed dome, because of easier construction and maintenance.<sup>15</sup>
- The concept provides for training on operation and maintenance as well as construction, which shall be financed by the project.
- The users or owners are obliged to finance the investment and operation cost, they shall also directly benefit from the results (energy + manure).

The implementation shall start in November 2000. The project will closely monitor the progress (video documentation, regular surveys). It shall also finance the technical advice (offered by a biogas expert seconded by DED<sup>16</sup>).

---

<sup>12</sup> Selam Technical and Vocational Centre, Technical Offer, September 2000

<sup>13</sup> Experiences show that this step is crucial for the success of the technology

<sup>14</sup> Kellner, C. (2000) Biogas Technology, VII GTZ Water + Waste Sector Meeting, Addis Ababa, Ethiopia, October 2000

<sup>15</sup> The largest biogas digester built in Ethiopia with 100 m<sup>3</sup> is producing gas which is transported by a pipeline of 700 m length to the end-user

<sup>16</sup> Kellner, C. initiated and supervised the construction of more than 20 biogas digesters in Ethiopia during the last year, all of them have been financed and are operated by private individuals. The Energy Department of the Regional State of Oromiya is now propagating this environmentally sound technology.



## Public awareness and mobilisation for ecosanitation

**Madeleen Wegelin-Schuringa** IRC International Water and Sanitation Centre  
POBox 2869, CW Delft, Netherlands

### 1. Introduction

Sanitation programmes depend critically for their success on effective public awareness and mobilization through information, education and communication. Experiences over the past decades demonstrate that even the technically best-designed programmes fail or produce meagre results, because decision makers and intended beneficiaries are not adequately consulted, informed, educated or mobilized.

One of the problems with sanitation is that it is rarely a strongly felt need, especially in rural areas. Few people realise that many diseases are caused by poor hygiene behaviour and sanitation, neither do they understand the way these diseases are transmitted. Although health considerations are rarely a motivating factor for a community to construct sanitation facilities, it is for health reasons that good hygiene behaviour and sanitation are promoted. For the community, various other factors such as privacy, convenience and status are more important. The key to getting people motivated to improve sanitation, is to understand these factors and to use them as a basis for the development of an intervention and communication strategy (Wegelin, 1991).

Another of the big challenges in mobilization for sanitation, is that human waste disposal is on the one hand an extremely individual issue as the use of toilets and hygiene behaviour is a private subject in most cultures. On the other hand, the lack of sanitation management is a public issue with repercussions far beyond the level of an individual user. Finding the right carrot (and stick) for the right audience is the key to success.

There is a distinct difference between communication and mobilization for sanitation in rural areas and in low-income areas in cities. Rural areas tend to be characterised by relative social cohesion and homogeneity, where it is relatively easy to reach audiences through traditional and participatory means of communication. The environmental conditions, moreover, are generally supportive to on-site sanitation solutions that can be managed at individual household level. Except for cement, construction materials are likely to be available in the surroundings and at specific periods (such as after harvesting or sowing), people have time to spend for construction.

The reverse is often true in low-income urban areas. These tend to be characterised by high population densities, where it is difficult to find room for individual toilets or sewerage systems; social cohesion can be quite low and it may be very difficult to get people to organise themselves for a communal activity. In addition, the proportion of the population that only rents their dwelling may be high and hence willingness to get involved in sanitation improvements may be low, as this is considered the task of the landlords. On the other hand, motivation for sanitation may well be high, especially for women, because lack of latrines are a severe problem with respect to convenience, privacy and safety.

## 2. Understanding attitudes and behaviour change

Communication and mobilization for behavioural change is a complicated process of human actions, reaction and interaction. It involves looking at situations from the view point of other people, and understanding what they are looking for. It means understanding obstacles to change. It means presenting relevant and practical options, and it means telling people what the effect is of the choices they make.

What messages are influencing people's knowledge and attitudes and how does that contribute to changes in behaviour? Research in social sciences has shown that knowledge on a topic may increase, people may even change attitudes, but that the step to improved behaviour and practices is depending on a complex set of social and psychological factors. Hubley introduced the BASNEF model for understanding behaviour in health communication: Beliefs, Attitudes, Subjective Norms and Enabling Factors (Hubley, 1993).

Individual beliefs about the consequences of certain behaviour and the value placed on each consequence lead to personal attitude or judgement. Attitudes combined with subjective norms contribute to behavioural intention. Subjective norms are beliefs about what behaviour other influential people would wish the person to perform. Enabling factors such as income, water supply, access and sanitation technologies have to be available so that the intention leads to a change in behaviour. The model is adapted below because for sanitation the existing environmental conditions are a major influence in sanitation behaviour and hence this aspect is added.

**Table 1: Behaviour change model (adapted from Hubley, 1993)**

Aspects	Influences	Actions needed	Questions to ask
Existing environmental conditions	Surface water used for drinking, access to bushes for privacy	Participatory assessment on environmental aspects supporting sanitation behaviour	What environmental conditions influence the options for sanitation?
<b>Beliefs, Attitudes</b> (individual)	Culture, values, traditions, education, experiences	Building on positive and neutral aspects in communication to modify beliefs and values	Why does a person want a latrine and what does it mean to have one?
<b>Subjective Norms</b> (community)	Family, community, social network, power structure, peer pressure	Communication directed at persons of influence in family and community	What interest do other people have in latrines or sanitation behaviour?
<b>Enabling Factors</b> (inter sectoral)	Level of income, appropriateness of sanitation technologies, status of women, environmental conditions	Awareness raising on appropriate technologies, capacity building activities in community, skill training	What do you need to have a latrine?

### 3. Communication and mobilization strategy

A systematic approach to plan and implement a strategy for public awareness, communication and mobilization is needed to mobilize different segments of society to support the development of sustainable sanitation management. This different components in this process are discussed below.

#### 3.1 Assessment of main risk factors and problems in environmental sanitation

Before it is possible to develop a strategy for an intervention in environmental sanitation, it is necessary to get an overview of the present conditions with regard to environmental sanitation. An assessment will focus on the environmental conditions of influence on sanitation behaviour and on options for improvement, it will also make an inventory of the main risk factors and problems associated with the sanitation practices and technologies in use. Because hygiene behaviour is a major determinant for health risks connected to sanitation and latrine use, availability of water for hand washing, fly control and animals with access in the compound (chicken, pigs, goats, that may transfer faeces into the compound) have to be included as well.

The information gathered during the assessment is likely to indicate differences within the community, not only in facilities and practices used, but also in the attitudes of the people. On the basis of this, a rough classification of risks and problems and possibilities for technical intervention in environmental sanitation can be made for the purpose of follow-up planning with regard to communication and mobilization, but also with regard to technology choice and implementation.

#### 3.2 Assessment of current knowledge, attitudes, practices and policies

Sanitation is to a large extent a social phenomenon, rather than a technical one, and therefore it is essential that background information on cultural, social, economic and environmental factors influencing sanitation behaviour is acquired before actual planning can start. This is especially true when a new technology is to be introduced, but it is also needed to develop a communication and mobilization strategy and a strategy for hygiene education.

Sanitation behaviour is based on ideas and taboos associated with defecation and on traditional habits originated in local cultural, social and environmental conditions. There is a large extent of cultural variation in defecation practices, which will eventually determine what technology options will be acceptable to the people. For instance in a culture where handling of feces is acceptable (as is common in Vietnam or China), composting technologies are much more likely to be accepted than in cultures where handling of faeces is regarded to be impure (as for instance in India and Guinea). Similarly, religion can be very influential in sanitation practices, for instance, in Islamic communities, a latrine can never be facing Mecca and communal facilities may be less acceptable because it would entail women to go out of the house or compound for defecation. Sanitation practices are not only based on cultural and environmental conditions, but also on access to sanitation technology in terms of knowledge, materials and funds.

Awareness of health aspects of sanitation behaviour is important because it determines the degree of sustainability of an intervention in sanitation. When new latrines are constructed in a programme and sanitation behaviour is not addressed at the same time, people are unlikely to support the improvements with sustained behaviour change needed for improved health. The reverse however is also true: conventional health messages may be widely known and largely

understood, but these messages by themselves may not enable people to implement desired changes because of other constraints, such as inappropriate technology in case of high water table or unstable soils.

At a national level, the policies that guide sanitation development need to be assessed, as well as implementation of such policies at the lower government levels. This responsibility often lies with the Ministry of Health, but can also be located with the Department of Water or combined in a Water and Sewerage department. Where this is the case, attention for hygiene education is likely to be low, as such departments usually concentrate on engineering aspects. It is therefore essential to assess at district or municipal level who is responsible for what aspects of sanitation development, guided by what policies and what targets.

### 3.3 Audience segmentation

Segmentation of audiences and their communication needs is essential for effective communication and mobilisation. Without understanding the differences among various segments, or sub-segments, it is difficult to design effective messages that call for change. The process of audience segmentation has to be based on the outcome of the assessments of main risk factors and problems, the current knowledge, attitudes and practices as well as on the incentives that have already been identified. Target audiences for sanitation improvements range from community level to national level. In the process of audience segmentation, research has to be carried out to find the most efficient and effective way to reach each target group with respect to place, time and channel of communication. It is for instance, not very effective to conduct a public awareness campaign on television if the target group does not watch this medium regularly.

At *community level*, different target groups that can be identified are men, women, youth, children, the rich, the poor, ethnic minorities etc. All groups have different roles and responsibilities in society and may attach different values to services and the benefits to be derived from them. Consequently, their demand for and access to services and their economic behaviour differ and hence messages for their mobilization. In addition to these different segments of the community, community level organisations, traditional chiefs/community elders, churches, schools and health centres are target groups at community level.

At *district or municipal level*, the target group for advocacy and awareness raising are district/municipal planners, staff of different departments involved in sanitation management (such as public works, water, sewerage, health), the private sector (formal and informal), the political representation (councillors, local chiefs), professional associations and NGOs. They must be informed on current environmental conditions, on health statistics at local level, on developments in the sanitation sector and on the integrated nature of water and environmental sanitation. The main aim of the messages is to motivate the target group to take initiative or support efforts at local level, with respect to planning, construction, operation and maintenance as well as with financial and human resources. Other aims may be to show the importance of hygiene behaviour in combating sanitation related diseases; to give examples of how without community involvement programmes fail; the need to put economic value on latrine use (what it costs to be ill) and sustainability elements at community level.

At *national, regional and provincial level*, people make policy decisions and/or influence development. This is an important target group as one reason why sanitation is receiving little attention is because it has not been given any priority at this level. Included in this target group are politicians (ministers, members of parliament, councillors), professional associations, educational institutions, donors, NGOs, churches and the media. To mobilise them, it is important to have data and information that they need to discharge to their respective

audiences, such as for instance telling what it costs the nation if people get sick with dysentery, cholera or another water and sanitation related disease due to lack of sanitation.

### 3.4 Finding the right incentives

Because health considerations are rarely a reason to be interested in sanitation, it is necessary to find the reasons that do motivate people for it. At user level, these may be convenience, safety, privacy, status or economic incentives. It is more *convenient* to go to a latrine near or in the house than to have to walk to the bush, especially during the rainy season. The *safety* aspect is especially important in urban slum areas where social control is low. For women, going to a latrine at night may become almost an invitation for rape. Similarly, at night evil spirits abound and snakes or wild animals are not seen.

The most common need with respect to defecation is probably the desire for *privacy*, although the level of privacy needed may vary according to sex, age or social status. Generally, women have more need for privacy than men and often it is this aspect of a latrine that they like most, especially if the latrine can also be used for bathing. Another important factor influencing interest in latrines, especially with men, is connected with *status* and *prestige*. Usually the people who already have a latrine constitute the upper layer of the community, they are likely to be more 'modern', have an education and have seen the outside world: all attractive aspects in the eyes of the rest of the community. In densely populated areas, the aspect of a *clean environment* is often cited as a positive aspect of sanitation, not only by men and women, but also by the youth for the purpose of sports activities. Finally, reuse of excreta may be an *economic* incentive either for people for their own use or for sale to farmers.

It should be noted however, that if status or prestige are the motivating factors, this does not imply that people also use the latrine. There are many examples of latrines being used as storage rooms, or reserved only for visitors or certain members of the family. This implies that for effective and sustained use, hygiene education is a crucial aspect of sanitation improvements (Wegelin and Ikumi, 1997)

Just as with the communities themselves, it is unrealistic to expect other stakeholders such as government staff at different levels or the private sector to become interested in the improvement of sanitation conditions if they do not get anything out of it that they see as a profit. Obviously, such incentives are different for stakeholders at different levels. But it is necessary to find the right incentive for the right target group. At national level, these may be exposure as a good example at international for a; being quoted in the international media and literature or being at a good 'level' in international statistics on health or environment. At municipal or district level, these may be elections for the 'sanitation' town of the year; access to (regional) training for the municipal/district engineers that win the election or matching funds for cost recovery.

### 3.5 Setting verifiable goals

In order to direct the communication strategy and mobilization efforts, it is necessary to have an agreement on the specific operational goals of the intervention. These goals have to be set together with the main stakeholders involved and will be different for the different target groups. In the communication strategy, these will concern the effectiveness of the messages that are being communicated as well as the effectiveness of the channel that is being used. Thus, for each segment that is targeted, a goal has to be set, with a time span and an indicator that is to be measured and that is verifiable. The same applies to the mobilization effort. Indicators need to be set with government staff and programme staff, to assess if the mobilization efforts that have been designed at the start of the programme indeed have the desired effect. In traditional monitoring systems, these efforts would be monitored by counting the number of activities

having taken place at community level, according to the plan. This however, does in no way assess the impact of the activities, although these are at this stage most important because they determine the interest that the community will eventually have in getting involved in sanitation improvements. Therefore, the indicators have to be set in such a way that they monitor the effectiveness of the mobilization (Shordt, 2000). The actual collection of monitoring data, in addition, should not be done by those who carry out the mobilization activities – most likely district/municipal government staff – but by those people or organisations on the ground that have an interest in sanitation improvements being carried out in a sustainable manner.

## 4. Enabling factors

### 4.1 Financing, cost recovery and willingness to pay

Financing and cost recovery for sustainable sanitation schemes on the one hand and ensuring equity on the other are key issues which any sanitation programme needs to address. This concerns local community-based sanitation initiatives as well as large-scale programmes funded by international donor organisations.

The cost of on-site sanitation programmes can be divided into three categories. These are institutional and project delivery costs, material and labour costs and operation and maintenance costs. The first category includes the cost of community mobilization and development, communication, information and training, as well as technology delivery costs such as engineering supervision and logistic support. These costs are usually paid by the government or external support agencies.

Material and labour costs have to be paid by the community, at least to a large extent. This may be paid partly in cash and partly in kind, depending on the provision of appropriate financing and credit facilities and the total cost of the proposed sanitation intervention. Already at the mobilization stage, the community needs to be aware of the various components that make up the total costs and the parts that are covered by grants or subsidies. Generally, most government supported programmes do not include substantial grants or subsidies, hence targeted subsidies may be necessary from the rich to the poor, who cannot afford the costs of a latrine. Often the provision of credit schemes poses problems.

The last component is the cost of operation and maintenance, which has to be borne fully by the users. As the choice of technology will to a large extent determine the level of the costs of operation and maintenance, this has to be clearly communicated with the community at an early stage.

Willingness to pay for sanitation improvements, if people can opt for the sanitation system that they want and are willing to pay for, is found to be much higher than expected. This is proven in many well-known case studies such as Prosanear in Brazil, Baldia Pilot Project and Orangi Pilot Project in Pakistan and the Kumasi Sanitation Project in Ghana (Wright, 1997). The key features to success in this willingness to pay again are to a large extent dependent on an effective communication strategy:

1. Community members make informed choices on:
  - Whether to participate in the project
  - Technology and service level options based on willingness to pay – based on the principle that more expensive systems cost more
  - When and how their services are delivered

- How funds are managed and accounted for
  - How their services are operated and maintained
2. An adequate flow of information is provided to the community and procedures are adopted to facilitate collective action decisions within the community and between the community and other actors.
  3. Governments play a facilitative role, set clear national policies and strategies, encourage broad stakeholder consultation and facilitate capacity building and learning.
  4. An enabling environment is created for the participation of a wide range of providers of goods, services and technical assistance to communities, including the private sector and NGOs (Sara, Garn and Katz, 1998)

## 4.2 Technology

A first distinction between types of sanitation systems is based on disposal of the feces and liquids. This can be on-site (also called drop and store) or off-site (flush and discharge). An interim option is to collect and store the excreta temporarily on-site and to remove them later for reuse as fertilizer or for disposal at a treatment plant. Eco-sanitation promotes the on-site option and is based on three fundamental aspects: rendering human excreta safe, preventing pollution rather than attempting to control it afterwards and using safe products of sanitized human excreta for agricultural purposes (Winblad, 1998).

A second distinction between systems is 'wet' and 'dry'. In dry systems the excreta drop through a hole in to a pit, vault or receptacle, while in wet systems, water is used to flush and transport the excreta away. Availability of water is one of the key deciding factors in opting for a system which requires water to function or one that does not need water. Conventional waterborne sewerage systems have proven to be inappropriate to solve sanitation problems in developing countries as these systems are too costly both in construction and in operation and maintenance. Moreover, approximately 90% of the sewage in cities in developing countries is discharged untreated, polluting rivers, lakes and coastal areas seriously affecting environmental conditions.

Environmental factors such as soil condition, groundwater depth, risk of groundwater pollution and population densities directly influence the selection of appropriate technology. Also possibilities for reuse (farmers) are important because this can make waste income generating and hence attractive. A description of the different technologies is beyond the scope of this small paper, but in general, the appropriateness of a technology is dependent on the cost, the availability of materials necessary for its construction, the requirements for operation and maintenance and the cultural acceptability. Very important, in addition, is the flexibility to adapt the design (and especially the superstructure) to consumer preferences.

## 5. Methods and tools for communication and mobilization

### 5.1 Mass media

Media and other channels of communication have to be selected on the basis of what is appropriate, considering the preferences and characteristics of whoever is going to use the information. This means that television exposure is only effective in places where watching is regular. Radio is in many developing countries a much more effective medium as it is much more common. Awareness raising films may also be shown with success in the 'open air'

cinema, as a 'pre-programme' for the main film. Also theatre is being used very effectively for communication and mobilization. It can easily be adapted to the target audience, for instance to children.

The effectiveness of the use of written media depends not only on the literacy rate, but also on the circulation figures of local newspapers, although this may not mean much. In Kenya, for instance, newspapers are read widely at street corners where the papers are sold, but where also reading of unsold papers is permitted. Similarly, newspapers are likely to be shared among the literate people within a community. What has to be kept in mind in using mass media, is that generally this method of communication informs people, but is unlikely to effect behaviour change. For this to happen, participatory methods are more effective.

## 5.2 Participatory methods

In participatory approaches, people are assisted to analyse their own situation and to come up with solutions that are most appropriate for their circumstances. Many such approaches are used in water and sanitation programmes and by involving users/communities/customers/beneficiaries from the start of a programme, the ownership is vested with them, which enhances sustainability. These participatory approaches can be applied at all phases in the project cycle and for different purposes. In the context of this chapter, they are used as a tool for public awareness raising for mobilization and for the development of a communication strategy. But they can also be used for implementation and construction, for operation and maintenance and for monitoring and evaluation.

Below some participatory methods are described in a short way. For the analysis of risk factors and problems in the sanitation environment, the most appropriate methods are community mapping and transect walks. The assessment of knowledge, attitudes and practices in sanitation is best done through focus group discussions, three pile sorting cards and the sanitation ladder.

**Community mapping:** groups of men and women draw a map of the local settlement including roads, houses, health facilities, all water sources and all latrines (public and houses with private latrines). The map usually includes other information needed for the project as well such as water sources. Through the mapping information can be obtained on access to water and sanitation, settlement patterns and division between different groups that make up the community. Also information can be obtained on radios or televisions present and on the division of different segments within the community.

**Transect walks:** these are systematic walks with key informants through the area of interest while observing, asking, listening and seeking out problems and solutions. Walking through the community leads to an understanding of the power divisions, environmental sanitation, risk practices and problems, sanitation technologies in use, construction quality and environmental conditions of importance to technology selection.

**Focus group discussions:** these are discussions with a small group of people in the community, either mixed or separate with the different segments of the community, on a specified topic. The aim of the focus group discussions is to get a deeper understanding of the issues that are being confronted with regard to the topic.

**Three pile sorting cards:** cards that contain pictures, words or sentences, depicting negative, positive and neutral aspects of a certain topic (sanitation) are given to the group for sorting in three piles (positive, negative and neutral). The discussions during the sorting will give insight in knowledge, attitudes and practices of hygiene behaviour.



**Sanitation ladder:** on cards different sanitation technologies are depicted. The groups are asked to sort the cards according to level of technology (from outside defecation to a VIP latrine or small bore sewerage system) and to indicate where people are at present in the ladder and where they want to go. This is a good tool for discussing upgrading of sanitation technologies and to assess what people like about which technologies.

## 6. Conclusion

Public awareness raising and mobilization is more than a one-off campaign in the mass media and one visit to a community. A systematic approach to plan and implement a strategy for awareness raising and communication is needed to mobilise different segments of society for sanitation improvements. This approach consists of a number of components and issues in a process:

1. Assessment of main risk factors and problems in environmental sanitation
2. Assessment of current knowledge, attitudes and practices
3. Audience segmentation
4. Finding the right incentives
5. Setting verifiable goals
6. Establishment of enabling factors: financing and technology options

The most effective methods carry out awareness raising and mobilization at community level, are participatory approaches that are based on interaction of people providing information and that let people examine their own experiences and learn from it. These approaches stimulate people to think about their own priorities versus sanitation and help them decide on a selection of technologies based on what they need and can afford.

## References

- Huble, J. (1993) *Communicating health: an action guide to health education and health promotion*. London, UK, Macmillan Press.
- Sara, Jennifer, M. Garn and T. Katz (1998) *Some key messages about the Demand Responsive Approach*. Washington, USA, The World Bank.
- Shordt, Kathleen (2000) *Action monitoring for effectiveness: improving water, hygiene & environmental sanitation programmes (Technical paper; no. 35E)*. Delft, The Netherlands, IRC International Water and Sanitation Centre.
- Srinivasan, L. (1990) *Tools for Community Participation. PROWESS/UNDP Technical Series Involving Women in Water and Sanitation*, USA.
- Wegelin-Schuringa, M. (1991) *On-site sanitation: building on local practice (Occasional Paper; no. 16)*. The Hague, The Netherlands, IRC International Water and Sanitation Centre.
- Wegelin-Schuringa, M. and Ikumi, P. (1997) *Sanitation and Communication analysis for peri-urban and rural areas in Zambia (final report)*. The Hague, The Netherlands, IRC International Water and Sanitation Centre.
- WHO (1996) *The PHAST Initiative. Participatory Hygiene and Sanitation Transformation. A new approach to working with communities*. Geneva, Switzerland, WHO.

Winblad, Uno (ed), S. Esrey, J.Gough, D. Rapaport, R.Sawyer, M. Simpson-Hébert, J.Vargas (1998). Ecological Sanitation. Stockholm, Sweden, Swedish International Development Cooperation Agency.

Wright, Albert M. (1997) Toward a Strategic Sanitation Approach: Improving the sustainability of urban sanitation in developing countries. Washington, USA, The World Bank, UNDP-World Bank Water and Sanitation Program.

## Potentials of alternative water systems from the economical point of view

**Prof. Dr. Dr. Karl-Ulrich Rudolph** Prof. Dr. Dr. K.-U. Rudolph GmbH  
Alfred-Herrhausen-Straße 44, D-58455 Witten,  
Germany

### 1. Definition

In this context, an *Alternative Water System* is any system different from the "Conventional Water System" (= centralised supply with drinking water through pressurised pipes and centralised wastewater disposal through gravity sewers serving a sewage treatment plant. Anyhow: Variations like pressurised wastewater pipes, semi-centralised treatment plants and other facilities, which are technically well established, are not yet regarded as Alternative Water System).

### 2. Need

In many parts of the world, alternative water systems are realised without further economical evaluations, simply because the conventional systems are not possible (**table 1**). The main reasons are:

- Lack of natural water resources
  - quantity  
(⇒ water recycling systems in arid countries),
  - quality  
(⇒ drinking water supplied in bottles).
- Lack of political stability  
leading to poor management of conventional water systems  
and/or prohibiting long-term investments, which would be necessary for conventional water systems  
(⇒ installation of private "small" water business and systems, such as private water vendors or private house supply systems).
- Special requirements  
*mobile units* for supply and disposal systems in trains, buses, planes, emergency containers or *provisional solutions* for intermediate purpose.

Very often, the situation is not that clear, and an economic evaluation of conventional versus alternative water system has to be carried out.

### Driving Motivations towards Alternative Water Systems (*examples*)

- Mobile systems (*planes, ships, trains*)
- Intermediate demand (*constructions sites, festivities*)
- Difficult network connections (*Islands*)
- Seasonal demand (*touristic areas, farm lands*)
- Lack of natural water resources (*Near East*)
- Sensitive water body (*national parks*)
- Political instability (*Africa / East Europe*)
- Poor service of conventional utilities (*severe droughts, unreliable supply, unreasonable high prices*)
- New settlements (*industrial estates*)
- Low population density (*5 mio. p.e. in D*)
- Prohibitive extension costs (*Tokyo, Industry*)
- Required individuality (*in-house stormwater consumption*)
- Multi-purpose (*irrigation, fertilisation, bio gas*)
- Very low income (*slum areas*)

### 3. Technological progress

During the recent years there has been a tremendous technological process in the water sector. Machines/plants/systems can be reasonably applied today, which (in the past) used to be much too complicated, very expensive or non-reliable.

Funded by the Federal Minister of Education and Research (BMBF), an international quick survey is being carried out, giving an overview of the current state of art and application (intermediate results see **table 2**, final results to be delivered until 03/2001).

## Investigated projects concerning “Alternative Water Systems”

Country	System	Number	Annotation
<b>Europe</b>			
Germany	GR	3 plants	Plants in Berlin, Offenbach, Hannover.
	GR / VT	1 plant	Eco-Village Flintenbreite near Lübeck.
	GR / VT	1 house	Project in Freiburg. Fertilizer is produced from faeces, urine and organic waste.
UK	GR	1 plant	Millenium Dome
	GR	10 houses	10 Environment Agency employees tested greywater systems in a two-year study.
	GR	8 houses	Three Valleys Water Company and Crest Homes installed greywater systems in 8 houses in Shenley
	GR	1 house	Millenium House of Wilcon Homes
	CT	4 sites / 2 farms	Waterless urinals at four National Trust sites. Ultra low flush and waterless composting toilets in Gloucester and Purbeck.
	GR	student accomodation	Greywater system installed in a student accomodation at the University of Oxford.
	GR / CT	3 houses	Gledhow Valley Eco-Houses. Autonomous water systems without link to mains water supply or sewage outlet.
	GRj	1 plant	Greywater system at Linacre College, Oxford, installed by Anglian Water. Sandfilter and hollow fibre membran.
	GR	1 plant	Greywater from a number of flats on the campus of Cranfield University is treated by a range of processes.
Belgium	WR-PW		Aquafin and IWVA plan to reuse WWTP effluent for potable purposes. Different technologies will be researched (microfiltration, RO, infiltration zones).
Sweden	GR and dry sanitation	1 plant	Ecovillage Toarp, 37 houses
	sep.-toilets	about 3000	
	VT		Wastewater from vacuum toilets is mixed with limestone. At pH 12 all bacterias and viruses are killed and the mixture can be used as a fertilizer.

Country	System	Number	Annotation
<b>America</b>			
USA	WR-PW	1 plant	Pilot plant in San Diego. Suspended in 1999.
	WR-PW	1 plant	Pilot plant in Tampa Bay. Suspended in 1999.
	WR-PW	1 plant	Pilot plant in Denver, 3,785 m <sup>3</sup> /d
	WR		New development projects will be built in Mission Bay, Hunters Point and Treasure Island (“Article 22 of the San Francisco Public Works Code – Reclaimed Water Use”)
<b>Asia</b>			
Singapore	WR	1 plant	The final plant in Bedok will provide 10,000 m <sup>3</sup> /d.
Japan	WR	1 plant	Wastewater reuse at Fukuoka City. 6,300 m <sup>3</sup> /d, 173 buildings
	WR	1 plant	Wastewater reuse in Tokyo (Shinjuku tall-building complexes).
	WR	1 plant	Wastewater reuse in Yokohama
Australia	GR	1 plant	Pilot plant for greywater reuse at Charles Sturt University Campus
	GR	4 houses	Study on 4 houses in Melbourne with greywater treatment (1993-95).
	WR	100.000 houses	Project in Rouse Hill starts 2000. After 5 years 100,000 houses (8 ML/d) will be supplied with recycled water for toilet flushing and irrigation.
	WR	1 plant	Wastewater treated to a high standard using microfiltration and RO used for toilet flushing and irrigation at the Sydney Olympics site Homebush Bay (2,000 m <sup>3</sup> /d)
	WR-PW	2 plants	2 demonstration plants at Quakers Hill WWTP

GR: Greywater reuse for toilet flushing; WR: Wastewater reuse for toilet flushing;  
 WR-PW: Wastewater reuse as potable water; VT: Vacuum toilets; CT: Composting toilets

#### 4. Economical aspects

This BMBF-study detected a significant change in economical values and priorities. Essential economic phenomena have to be taken into account for business plans (micro-economic view) or cost benefit analysis (macro-economic view).

Some of these are described as follows.

4.1 CAPEX

Whenever evaluating water saving units (greywater recycling, stormwater harvesting, wastewater irrigation, vacuum toilets etc.), it does make a big difference, whether the capacities of the existing supply and disposal systems ("Assets") are partly unused, or already over-stretched.

It has to be decided case wise, whether the calculation of surplus capital costs for additional water (respectively water saved) is based on the current capital costs average, or on the costs for a necessary enlargement, or totally neglected.

The following **table 3** shows the significant difference which is linked to this view.

(Presently, many water utilities especially in East Germany run significant over-capacities and are in the same situation like a private party club, who had hired as bus for 60 participants. 20 participants left, and the remaining 40 had to pay for the whole bus. **Figure 1** shows an example from the water sector.)

<b>CAPEX related Views</b>			
Given:	Total Costs of recycled water		4 €/m <sup>3</sup>
	Present water tariff		2 €/m <sup>3</sup>
	Present wastewater fee		1 €/m <sup>3</sup>
	Fixed costs		70 %
	Subsidies		50 %
	Enlargement Costs		5 €/m <sup>3</sup>
<hr/>			
Customers view		4 >	3 €/m <sup>3</sup>
Utilities view			
a) excess capacity		4 >>	0,9 €/m <sup>3</sup>
b) poor capacity		4 <	5 €/m <sup>3</sup>
National view	4 <		4,5 €/m <sup>3</sup>

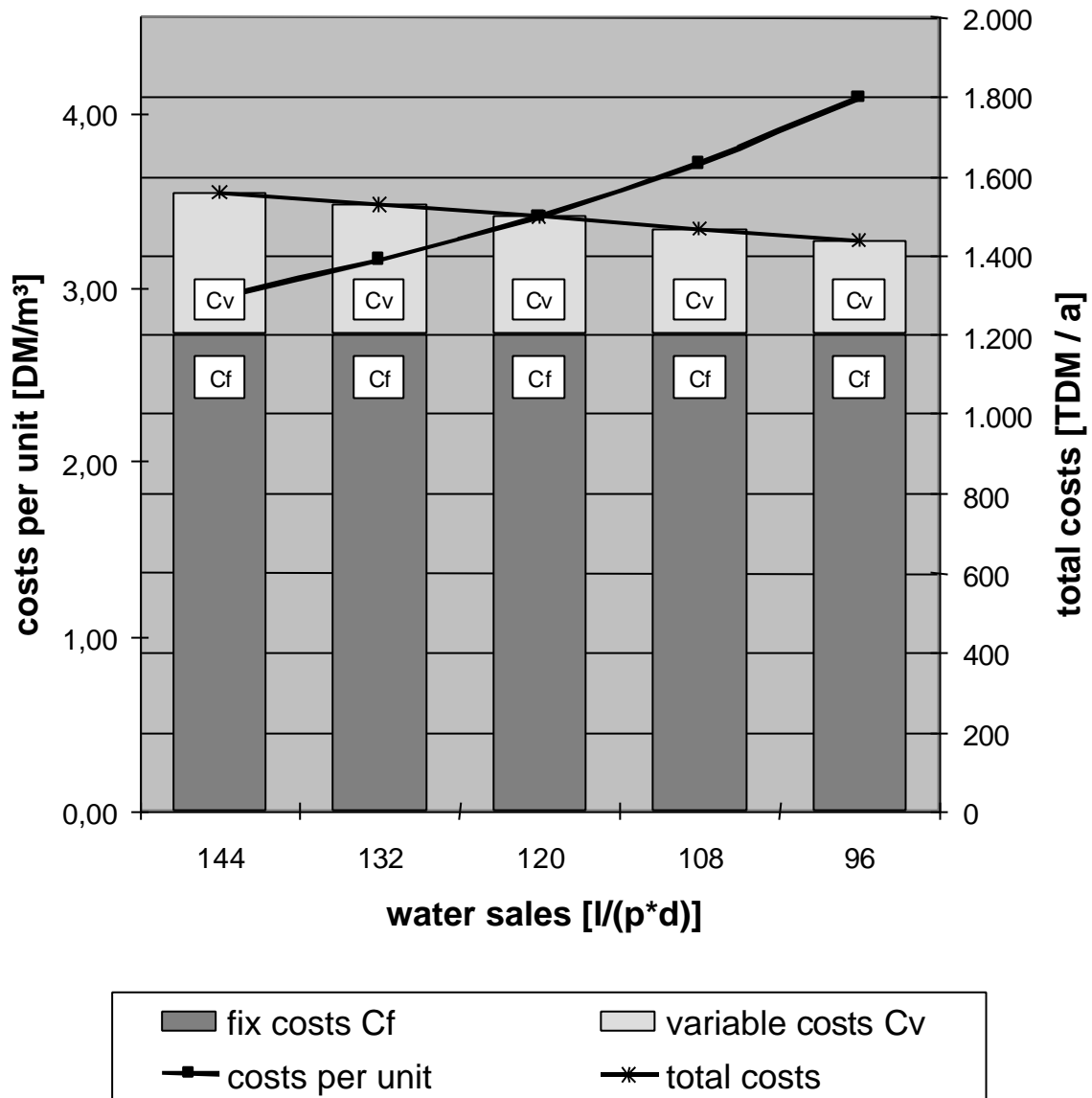

Figure 1: Wastewater costs per unit with changing water quantity



Figure 2 gives an indication of "threshold costs" and describes the situation further.

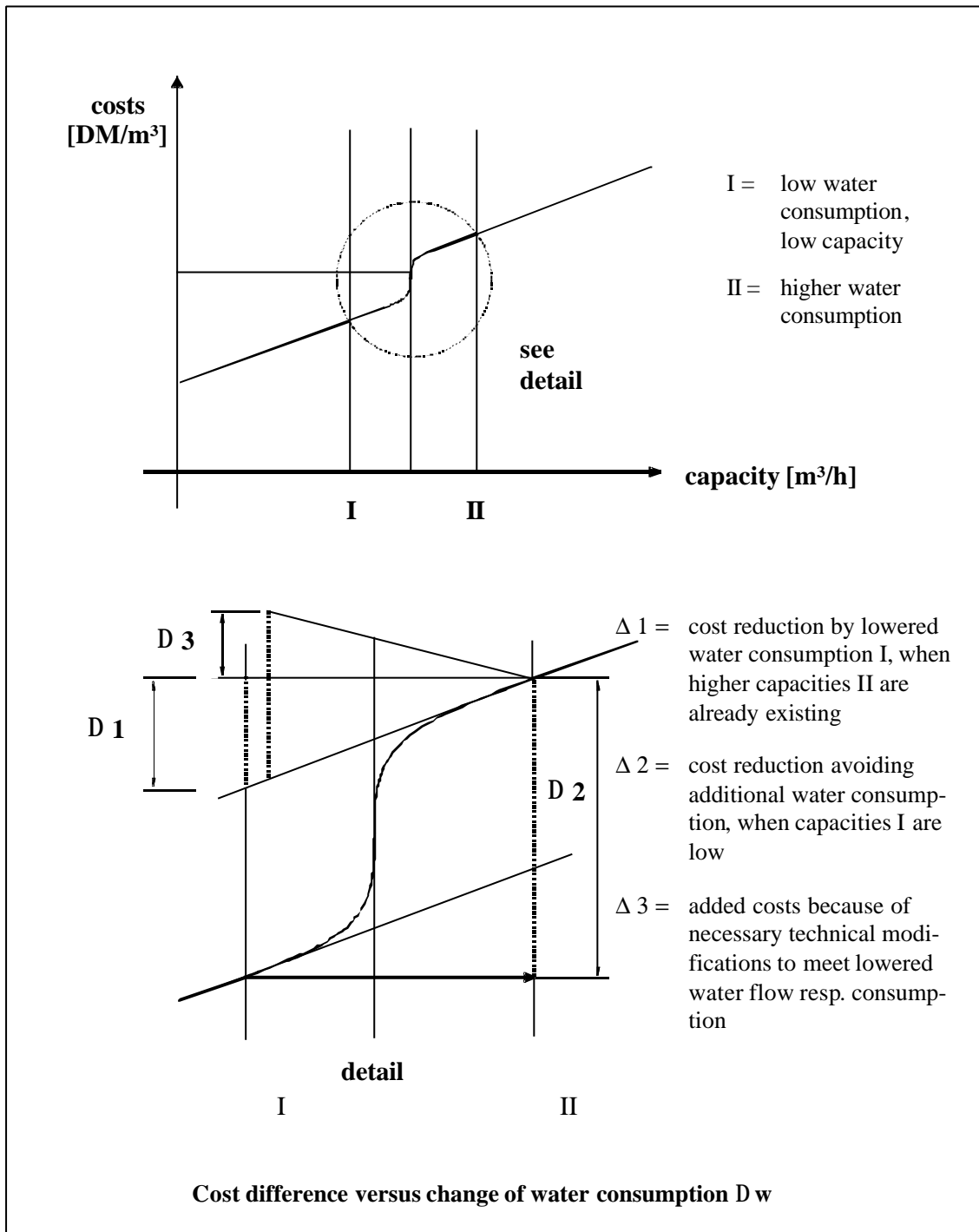

Figure 2: Cost thresholds

4.2 Labour

It makes a big difference, which kind labour is employed.

- Professional labour  
to be calculated as cost per working unit,  
including holidays and social insurances etc.
- Unemployed man power  
Under macro-economic view, the cost for labour in fields with high unemployments might be near to zero or even negative (→ social benefit of lower crime ratio and improved social stability created by a big investment programme).
- Work for fun  
Like private gardening, the house owners install facilities for stormwater harvesting, greywater drainage and irrigation with great pleasure - and pleasure is definitely not to be calculated like professional labour.

**Table 4** demonstrates the different results of different methodological approaches in an economic evaluation.

4.3 Natural resources

Very seldom the price of raw water reflects the real costs (in England, OFWAT discusses to auction water abstraction rights, which might create prices near the "real market value").

The same is true for the price of energy (including high taxes, e.g. on petrol, in most of the countries world-wide, justified with the social costs created by energy consumption).

Also, the costs for chemical agents or solid waste disposal have to be considered case wise and different for a micro- or macro-economic evaluation.

The results of water recycling systems may differ a lot, as shown with the following **table 5**.

<b>Labour related Views</b>		
Given:	Total Costs of recycled water	4 €/m <sup>3</sup>
	Labour included for construction and operation	2 €/m <sup>3</sup>
Customers view:	4	work for fun = 3 €/m
National view	3	unemployed labour = 2,5 €/r

**Table 4**

Resources related Views			
Given:	Total Costs of public water services		4,0 €/ $m^3$
Corrections:	./.	water abstraction tax	0,15 €/ $m^3$
	+	various subsidies	1,0 €/ $m^3$
	./.	wastewater effluent charge	0,20 €/ $m^3$
	+	external costs	
	+	...	
	./.	...	
			? €/ $m^3$

Table 5

## 5. Conclusion

The situation in a world with growing water shortage and pollution, and the political instability of economies - additionally enforced by new and competitive water technologies - create strong needs and emerging markets for Alternative Water Systems.

Presently, it is well understood that the data for the economic evaluation of water systems (conventional versus alternative) have to be collected and evaluated case wise. In future, it should also be acknowledged that the methods and presumptions applied should reflect the specific situation and view, under which this economic evaluation has to be carried out.

For developing and transformation countries, the definition of major cost components, like labour, CAPEX, and natural resources should reflect the specific situation on-site. The field is much too complex for quick opinions, which might definitely lead to unfair decisions excluding reasonable alternatives to conventional water systems.

## Results of Parallel Session 3 presented at the plenary

"What are the strategies to achieve the acceptance and participation of target groups and politicians?"

1. Idea marketing  
Selling the idea of sanitation as an ecological system and as part of Vision 21
2. Finding the right incentive  
Following social marketing principles, segmenting audiences at all levels and finding the right channels for each audience with the right messages.
3. Pilot/demonstration projects  
Introduce the concept in communities where people are already practicing reuse/recycling and/or there is a potential interest in eco-sanitation. Information on successful practices including examples from industrial countries and study visits at international, national and local level.
4. Adoption of community management principles  
Introduction of eco-sanitation needs to be based on existing environmental and socio-economic conditions, KAP studies with involvement of the community in all phases and informed choice on technology alternatives.
5. Regulatory framework  
Promote adoption/adaption of regulatory framework (norms and standards) based on performance criteria rather than design criteria.
6. In principle households have to pay for ecosan systems, if necessary on the basis of existing saving and loan schemes.
7. Follow-up on marketing





## Persuading politicians

- Votes and money are the main incentives for politicians.
- The question is how to arrive at vote-getting marketing strategies and establish priorities (e.g., cholera epidemics are not prevented by water supply measures, but by sanitation. That constitutes a potential election campaign plank).
- Politicians like packages that they can tout as marketable, appropriate, flexible (and, above all, upgradable) all-in solutions.
- Politicians need advisory inputs. Writing a policy is the first step toward its dissemination. Written policies are more than mere stacks of paper.
- There was general agreement that politicians have to be convinced that Ecosan is a future-oriented "latest technology"!

## Financing

- With regard to successful outcomes, financing is even more important than technology. Private initiative must be promoted and financial incentives offered (e.g., potential income or savings).
- Sustainable financing structures are needed. (Emerging countries have no budgetary resources for sanitation. The money can only come from the customers.)

## Implementation

- Little pilot projects have accordingly little power of persuasion with regard to large-scale applications (in China, for example).
- One cannot offer emerging and threshold countries technologies that industrialized countries do not use themselves. Consequently, demonstration projects domiciled primarily in industrialized countries should be used for comparison.
- Rules, regulations and standards need to be examined and revised to leave more room for technical options.

## What can be done in the way of general PR?

- Identify, train and motivate key figures to achieve "bottom up" diffusion of sanitation. Train local politicians and other decision makers, empowering them as theme partners of equal standing and instilling in them a desire to spread the word on sanitation and work toward its implementation.

- Bring policy makers from different fields together in order to accentuate the subject's relevance and interdependence (agriculture, sanitation, health, construction, etc.) and to coordinate relevant activities.
- Adequate education is of central importance for acceptance and dissemination. There was general agreement that sanitation can only be assertively sustainable if the people have been made aware of the relevance of sanitation and are able to perceive a desire for change.
- Vision 21 offers opportunities for establishing continental, regional and national frameworks for action, defining wastewater management as a concrete political goal, within the framework of which alternative approaches need to be investigated and tried out, with Ecosan playing a major role throughout (full accord!).





## List of participants

Eiling	Martin	Germany	GOPA Consultants GmbH
Förch	Gerd	Ethiopia	RODECO Consulting GmbH
Heider	Carola	Belgium	European Commission
Holländer	Robert	Germany	BMU
Ishizaki	Katsuyoshi	Japan	Nagasaki University
Kalbessa	Ayana	Ethiopia	Water, Mines & Energy Bureau
Knapp	Andreas	Austria	Institute for Water Provision - BOKU
Koch	Rolf	Germany	Lahmeyer International GmbH
Ludwig	Jutta	Germany	Wuppertal Institute for Climate, Environment and Energy
O'Leary	Michael	Zambia	Southern Water & Sewerage Company
Pankert	Jean-Gérard	Germany	MISEREOR
Parikh	Himanshu	India	Himanshu Parikh Consulting Engineers
Pitot	Hanns-André	Netherlands	EPAT
Rudolph	Karl-Ulrich	Germany	Prof. Dr. Dr. K.-U. Rudolph GmbH
Salifu	Lukman	Kenya	Worldbank
Schäfer	Hans-Joachim	Germany	Woltmann + Knoop GmbH
Schlick	Jana	Germany	Consultant / GTZ
Schmitz	Peter	Germany	Malteser Auslandsdienst
Schönewald	Bernd	Germany	KfW
Skinner	Brian	UK	Water, Engineering and Development Centre
Steinfeld	Carol	USA	Center for Ecological Pollution Prevention
Wegelin-Schuringa	Madeleen	Netherlands	International Water and Sanitation Centre
Weistroffer	Klaus	Germany	GTZ
Werchota	Roland	Zambia	GTZ
Winblad	Uno	Sweden	WKAB
Zang		Germany	Roediger Vakuum- und Haustechnik GmbH



## Parallel Session 4

# Practical experiences with alternative sanitation strategies, best practises/typical problems and questions

**Key Question:** „How can we identify and evaluate best practises?  
What are the priority research demands?“

**Moderators:** **Prof. Dr. Ralf Otterpohl** (TUHH, Germany)  
**David del Porto** (Consultant, USA)

## Lectures

### **Dry sanitation in Palestine, a pilot project in the Hebron District 2000-2001**

Gert de Bruijne (Palestinian Hydrology Group, Palestine)

### **Ecological sanitation and wastewater management systems in North America and the Pacific Islands**

David del Porto (Consultant, USA)

### **Experiences with ecosan projects in Germany and Austria**

Dr. Martin Oldenburg (Consultant, Germany)

### **Reducing wastewater problems in low-income semi-urban communities in Kathmandu valley**

Eveline Bolt (IRC, Netherlands)



## Dry sanitation in Palestine <sup>1</sup> a pilot project in the Hebron District 2000-2001

**Gert de Bruijne /**

Sanitation Task Force <sup>2</sup> - Palestinian Hydrology Group

**Yusuf Subuh**

POBox 219, Beit Jala, Palestine

### Summary

The problems of both water scarcity and water pollution severely lower the standard of living in the West Bank and Gaza Strip. Natural water supply is dependent upon yearly precipitation, which replenishes the aquifers in the Palestinian territories; and upon political relation with Israel, that still controls all water reserves in the region. Meanwhile, the water that is available to the Palestinians is under threat of pollution from cesspools and septic tanks, the main wastewater disposal method in Palestine, and uncontrolled discharge of Jewish settlements and Palestinian cities. The groundwater quality is steadily deteriorating, due to a lack of proper sewerage systems and inefficient solid waste management.

An applicable technology, which simultaneously addresses the two environmental and health threats of water scarcity and water pollution, is the urine diversion sanitation system. This ecological sanitation technology has proven to be an especially effective and efficient sanitation alternative in regions of little water and high temperatures. Therefore, it was expected that urine diversion sanitation would be an appropriate, ecological alternative to water-borne sanitation systems for Palestine.

The project will serve to test the performance of *dry sanitation* (urine diversion) systems in this particular climatic and cultural environment. If successful, the project results can be used to encourage politicians to consider wide-scale implementation of ecological sanitation technology, and will convince other communities and individual households to adopt this technology as well. If the test project results illustrate the suitability and applicability of such technology in this region, it will further advance the argument against water-borne sanitation systems, which still is seen as the only alternative to traditional sewage disposal methods.

### Rural and peri-urban sanitation in Palestine

Only thirty percent of the population (60% of households in municipal communities) in the West Bank is connected to a sewerage network.

For the other seventy percent of the population, household wastewater is disposed of through cesspits, gardens, streets, and in some cases septic tanks. Cesspits are the most common for wastewater disposal in the absence of a wastewater collection network. They typically serve one household or are shared by families, or neighbors of the same multiple apartment building.

<sup>1</sup> The project is financed by Sida

<sup>2</sup> This project is part of a sanitation program that based on informed demand sanitation planning and household centered environment sanitation. The program includes projects such as: Integrated Catchment Sanitation Management, Waste(water) reuse, Environmental Sanitation (urine diversion), Micro Credit Facilities, Sludge Treatment, Small Scale Wastewater Treatment, Small Diameter Sewer Network

The size of the tank depends on the availability of land and on the construction costs. Their capacity might range from 5 to 50 m<sup>3</sup>.

The average period between each complete evacuation of the contents of cesspits is around two years.<sup>3</sup> The average annual cost of emptying cesspits in the southern West

Bank is reported to be about \$100/household. However, one must distinguish between cesspits that are built with the purpose to allow infiltration of the wastewater into the ground, and septic tanks that are closed systems that may or may not discharge the effluent in a sub-drainage tank (SDT) system. In theory, the SDT systems are different, but in practice the cesspits become clogged and so the SDT systems of the septic tanks become disabled. In both cases the liquid septage has to be removed periodically.

The economic costs for a household that does have its cesspit or SDT emptied are high, explaining the purposeful construction for infiltration of the wastewater into the soil. A vacuum truck with a volume of 10 m<sup>3</sup> costs between 12 and 15 dollar per load. Comparing this cost with the average daily income of a typical unskilled Palestinian labourer (15\$ - 25\$), one economic class found in rural communities, and it is evident that the cost for emptying a septic tank or cesspool would become quite expensive. For this reason, house owners and contractors purposely do not line the cesspits with impermeable material (plastic, concrete) so that the sewage will infiltrate into the underground, and therefore not have to be pumped out. Sewage that does infiltrate into the soil can rapidly reach the underground water aquifer through the many cracks in the rock structure of the West Bank, this is why cesspits are considered to be the main source of groundwater pollution in the Palestinian Territories.

## Goal & objectives

When one witnesses the inadequate sanitation systems in rural households, a scarce national water supply, and the increasing pollution of precious groundwater resources it is clear that an emphasis on the improvement of sanitation technologies is imperative in order to solve this public and environmental health crisis. In this light, the Palestinian Hydrology Group, want to put effort into research of alternative, ecological, and economical sanitation technology for rural and peri-urban sanitation problems. The Sanitation Task Force of the PHG, as part of its newly developing program of activities, is disseminating and implement dry sanitation technology through applied research and pilot projects at three locations in Palestine. The projects aims to illustrate the feasible dry sanitation system that can be adopted by local communities and/or the private sector.

The goal of introducing dry sanitation technology in Palestine is to provide an **ecologically, economically, technically intelligent way of alleviating drinking water scarcity and community health problems**. Specific objectives of introducing dry sanitation technology through applied research and pilot projects are:

1. *Conduct research on the applicability or modifications that need to be made on the operation of dry sanitation systems in this region.*
2. *Test the operation of dry sanitation models; community involvement and participation aspects, technical performance, financial benefits, management criteria*
3. *Build the capacity of Palestinian sanitation professionals in operating and maintaining dry sanitation systems.*

<sup>3</sup> 27.25 months according to the Southern Area Water and Sanitation Project - Social Assessment Survey; Sept/Oct 1998; DFID

## Test site selection

This project aims to test the application of various urine diversion sanitation technologies on a scale large enough to obtain a reliable assessment of its climatic and cultural suitability. In various villages in the southern area of the West Bank (Hebron district) we are about to test 100 toilet units. The individual testing locations (households, schools, communal buildings) will be selected on the following criteria:

- i) A balanced mix of households in different economic classes, so as to avoid the cultural problem of having dry sanitation technology being labeled as a cheaper system suitable only for the lower economic classes.
- ii) Buildings which presently have no sanitation facilities, since it is recognized that selecting either currently constructed buildings, or places where no sanitation facilities exist, is an easier option than retrofitting existing facilities.

## Benefits

The *regional and national benefits* of implementing this type of sanitation technology in Palestine are as follows:

- Promoting water conservation: reducing household water demand by eliminating the use of water-intensive conventional sanitation systems.
- Public health protection: currently being caused by overloaded and leaking cesspools.
- Preventing groundwater contamination: vast areas of the West Bank are very rocky with only a thin covering of topsoil, the carstic nature of the geological formation, leaving it extremely susceptible to the percolation of toxic wastewater from cesspools.
- Employment creation: local small manufacturers help to develop and produce the pedestals or squat plates, while the actual construction of the toilet units will not require a high level of skilled manpower; and
- Decrease of wastewater collection and treatment cost and infrastructure problems

The *benefits to the individual households* who install the urine diversion sanitation technology are the following:

- Water conservation: toilet water drastically reduced in each household, reducing the percentage of income that is spent on water consumption.
- Waste minimization: amount of wastewater per household reduced, smaller load for cesspools and septic tanks, reducing probability of leakage and groundwater pollution
- Recycling of nutrients: nitrogen from urine used as fertilizers, dried feces as soil conditioner
- Cleaner household wastewater: black water is no longer put into wastewater collection system and so the gray water is safer, and more easily treated, for garden and crop irrigation.
- Reduction of sanitation costs as the construction of a cesspit can be avoided



## Technical considerations

### General

The use of local materials is considered important, while the training of Palestinian builders in the technology will be crucial to ensuring long term sustainability and replicability. While appropriate designs and building methods were utilized as far as possible in order to minimize the need for imported expertise, we ensured a high quality of workmanship in order to produce *well built and attractive units* which will serve the promotion of the technology.

### Collection of urine and dried faeces

There are various options for the collection of urine and desiccated feces. The scale of the project is small and the units will be scattered amongst one community. Therefore, collection and reuse on an individual basis will be encouraged, while giving families the option to collect it communally should they so desire. The collection of dried faeces should also be handled on an option basis - should families not wish to reuse the product then entrepreneurs or municipalities should be encouraged to collect and bag it for resale to farmers.

## Social considerations addressed in home visits and workshops

Whenever introducing a sanitation program, the factors for success are a mixture of technical suitability, social acceptability, and cultural compatibility. Social and cultural considerations are almost more important factors than the technical details of the actual operation. Therefore, the first phase in the test-project is to sit with the target community to decide which ecological sanitation technology will best match their needs and preferences. This task, deciding upon a specific sanitation model, will be the start of the education program. An outline of the complete education/awareness program is as follows:

1. Pre-selection household visits: discussion of concept and benefits of ecological sanitation technologies in terms of community health, water conservation, hygiene, environmental protection. Presentation of all ecological sanitation options, discussion of the benefits, operational requirements of all the models.
2. Post-selection workshop: further discussion of the relation between hygiene, community health, environmental protection and sanitation (led by community health worker). Question and answer period about the specific technology that the household has chosen to install, operational instruction manual explained and distributed to each household.
3. Post-installation workshop: approximately one month after the sanitation system has been installed, receive feedback on the systems, recommendations for improvements, discuss beginning other collection options (communal, volunteer, individual, private sector).

## Health and hygiene education

In any sanitation program, there should be an extensive community education campaign on community health, hygiene, and sanitation, that precludes and accompanies all technical implementation. In light of the fact that this test project is an experiment as to the performance of the dry sanitation toilets in this particular climate and cultural conditions, an education/awareness program is extremely appropriate. The reactions and attitudes of the households

towards the dry sanitation systems will be used in determining what aspects (cultural, economic, health) should be most emphasized in any future sanitation program.

### Revising assumptions

Though initiated by environmental concerns its soon became apparent that we could only introduce technique when we listened to what do people expect from sanitation. Reactions from households after having been introduced to the new technology expressed that sanitation should meet first of all minimal expectation with respect to convenience, privacy & safety, hygiene and status.

That these standards may take different forms and and rankings may be obvious, though often ignored. Each person has her/his customs and concept of improvement. Meaning we all have our own idea what is good (for us). What is good sanitation depends on our culture and religion, generation and age. But very much on gender aspects as well.

Environmental concerns hardly play a role in the decision, unless they are directly related by the individual or community to their own situation.

Therefore, we soon realized that in order to get the interest people in ecological sanitation, it must be convenient, save, clean, beautiful and affordable.

During the project preparation we also started to appreciate the importance of resources for the determination of the final choice of the sanitation option, namely:

Financial Resources,

Water availability

Land availability

Communal Management Level

Goals can me met on a household level, for the application of dry sanitation on a entire village or neighborhood scale institutional support is required to enhance the dissemination..

### Initial findings

Findings	Action
Unexpected high interest because of 1) Water scarcity and 2) high cost of sanitation	Systematic integration of dry sanitation in household and communal centred program
Farmers expressed interest in reuse aspect	Introduce good reuse of urine and greywater practices on individual or communal level
Dry sanitation utilities from other parts of the world are not appropriate in Palestine, because they: 1) look cheap; 2) are too expensive ; 3) have no anal cleansing facility	Locally production of attractive ceramic toilet with plastic lit
Most families were willing to pay for the DS unit construction, or want a small loan	Establishment micro credit facility
Simple construction guidelines for squat plate are not available	Drafting of first guidelines

Findings	Action
Stakeholders have different interest in ecological sanitation	Seek strategic alliance
New housing and construction set trend and defines status	Introduce dry sanitation where no sanitation exists
Lack of promotion material	Exchange and cooperation in developmnet of promotion material

**Project result as of October 2000**

	Results	Recorded Experience / Documents
1	Public Willingness for Co-operation	Awareness and Promotion Hand-out in Arabic Statement of participation of fifty households
2	Good understanding of the needs and preference of the partners	Preference assessment based on field survey (available)
3	Common understanding of project among stakeholders	Report of First Training Workshop in Palestine on 20-21 <sup>st</sup> May, 2000 (available)
4	Scope of technical options for local production	Technical report (available)
5	Squat plate and pedestal design that can be produce locally	Design and construction drawings (forthcoming)
6	Squat plate and pedestal produced locally	Local produced high quality smart looking ceramic urine diversion squatting & pedestal toilet (completed)
7	Enhance sustainability of project and increase participation	Agreement with local micro credit organization to support the project
8	Provide simple guideline for promotion of DS	Technical Guidances (in English and Arabic): <ul style="list-style-type: none"> <li>- General procedures for practical implemenation of project</li> <li>- Design &amp; construction guidelines for urine diversion sanitation system</li> <li>- <i>User operation &amp; maintenance guidelines for urine diversion system</i></li> <li>- Checklist for monitoring of urien diversion sanitation system</li> </ul>
9	Improve recording of project experience as basis for monitoring and research	Files for all individual participants and communities, containing: <ul style="list-style-type: none"> <li>- completed questionnaire</li> <li>- statement of cooperation</li> <li>- construction drawings (original situation, suggested changes, as-built drawing)</li> <li>- loan form</li> <li>- visit report (based on standard forms)</li> <li>- pictures</li> </ul>

**Expected results as off the end of 2001**

<b>Expected Results</b>	<b>recorded experience /documents</b>
Approach to introduce and later promote DS	Workshop report
75 DS units installed in three communities	Installation report
Immediate outstanding problems are solved	Inspection report
Good quality DS units	Construction report
Initial sanitation management system, based on the principle of eventual sustainability	O&M guidelines and program for reuse
Cost of DS are affordable	Cost-Benefit Analysis
Reduced sanitation cost for households and communities	Comparative Cost Analysis
Environment protection and public health safety are save guarded	Project monitoring report
Exchange of experience	Evaluation Report
Use of urine on household / farm level	Guidelines & Practice Report

**Remarks made and discussed in the context of the seminar with respect to dissemination and application of ecological sanitation**

Promotion and development of EcoSan often ignores the main principles for success of conventional sanitation.

Though reuse of nutrients (closing the loop) is the main focus for environmentalists in promoting EcoSan, relatively little work and research as been conducted in this field.

Resource allocation for the development of EcoSan should be *significantly* increased to make it competitive with conventional sanitation.

Large scale, municipal size EcoSan projects will confront us with new problems, and will help us to find answers to important questions that are currently hindering dissemination of EcoSan.

## Ecological sanitation and wastewater management systems in North America and the Pacific Islands

**David del Porto**

Principal System Designer, Sustainable Strategies  
P.O. Box 1330, Concord, Massachusetts, USA 01742

This paper focuses on composting toilets (also known as dry, waterless and biological toilets and non-liquid saturated systems) because, among wastewater treatment technologies, they are one of the most direct ways to avoid water pollution and conserve water and resources. Of course, most people in North America and the Pacific Islands who install composting toilets do so simply because they need to have a toilet system where a septic system cannot be installed.

### Overview: North America

Beginning in 1973, Swedish composting toilets were exported to the United States and later to Canada. The market was primarily driven by the economics of installing composting toilets to provide inexpensive indoor sanitation for holiday cottages and some remote full-time residences. However in 1980, the composting toilet industry was set back when a study by the United States Environmental Protection Agency found several of these systems, as well as those built by homeowners, to be functioning poorly. Within a few years, many systems were improved, and more Swedish, American and Canadian manufacturers entered the market.

Today, mostly due to the passing of restrictive environmental regulations, separated black- and gray-water systems are found in up-market homes, businesses, public parks, and schools. Increasingly, new laws regulating nutrient pollution are now broadening the market for these systems in North America. Their prices stay somewhat high due to the relatively limited market and the high cost of performance testing for manufactured systems. As a result, site-built systems are gaining more popularity, and at least one state may establish regulatory performance standards for these designs.

### Overview: the Pacific Islands

In Australia and New Zealand, introduction of these systems followed much the same pattern as that of North America, starting in the 1970s. About four types of site-built systems have been adopted in rural areas in subtropical parts of Australia, some with municipal approval.

A few formal ecological sanitation introduction programs have been conducted in the Pacific islands, with varying success. In 1992, Greenpeace International sponsored a clean development initiative for the Federated States of Micronesia, a nation of small islands in the Western Pacific. For this, Sustainable Strategies, an ecological engineering firm, designed a new zero-discharge system (to manage excreta and washwater) to replace failing pour-flush toilets, latrines and flush toilets with on-site nonpolluting wastewater systems, three types of composting toilet and graywater systems. Since then, these systems have been replicated in Palau, Kosrae, Yap, Chuuk, Pohnpei, Independent Samoa, and Fiji for use in homes (extended family compounds), parks, and public-use areas. In 1997, the South Pacific Commission funded an ecological sanitation education workshop in conjunction with the Fiji School of Medicine; this program is now conducted by the Center for Ecological Pollution Prevention. Other Pacific

Island initiatives include an AusAID project in Kiribati and Tonga and a small FSP project in Kiribati. Now, tourism resorts in the Pacific are adopting these systems, as they find that ecological sanitation is less expensive than conventional wastewater treatment systems and, due to the specification of flowering plants in some systems, they provide an attractive way to prevent pollution of the shoreline areas that draw visitors.

### Reasons for acceptance

Long used by developing countries, North American parks, off-the-grid homeowners, and cottage owners around the world, composting toilet systems are now making their way into mainstream year-round homes, for many reasons:

- Flush toilets are increasingly used with composting systems, making these systems more socially acceptable.
- More graywater (washwater) systems are emerging and getting approved.
- Increasingly, service contracts are available for maintaining composting toilet systems.
- Water shortages threaten at least one-third of the world. Some estimates place it at one-half.
- Many states are tightening on-site wastewater system standards, so that many of the United States, millions of septic systems are now considered inadequate, and therefore in noncompliance. As a result, many property owners are seeking ways to supplement their septic systems so they can avoid installing new ones. Diverting excrement and flush water from the flow removes more than 90 percent of the pollution, leaving only graywater to manage.
- Population densities are increasing in cities and coastal areas, intensifying the challenge of managing human waste.
- More people are converting vacation homes into year-round residences. These homes are often in remote and environmentally sensitive natural areas, such as seacoasts, lakes and mountains, with limited capacity for wastewater disposal.
- Individuals and institutions are increasingly interested in sustainable technologies, as the public's awareness of sustainability issues grows.
- A sewer-less society? According to the United States Environmental Protection Agency and the United States Census Bureau, on-site systems are increasingly chosen over central sewer systems by property owners and municipalities because they cost less than a central sewer system. (USEPA, "Response to Congress on Use of Decentralized Wastewater Treatment Systems")
- Public health specialists at development agencies worldwide are promoting effective and ecological on-site waste treatment systems that save water and help prevent the spread of disease.

At the same time, the acceptance of composting toilet systems as a technology has grown tremendously. They are far more efficient, refined and proven. Every year, more states change laws and regulations to permit them. Even researchers at Harvard University have decided that this is the technology of the future, and have developed a high-tech prototype "smart" composting toilet with solid-state sensors and microchips that control the process.

## Need for education

Composting toilet systems are in place, have improved and are increasingly used worldwide. However, until recently, there has been a dearth of information about how to choose a system and how to maintain it. Meanwhile, regulations that pertain to these systems change monthly, as regulators learn more about separated blackwater and graywater systems. Also, decision-makers have simply been unaware of the breadth of the wastewater problem, as much of the information about the relationship of nutrients and pathogens in excrement to disease and dying waters is buried in scholarly papers in scientific journals.

Now, composting toilet technology and its regulatory and market climates are changing. The challenge of designing composting toilets is providing adequate control of the composting process: temperature, moisture, exhaust, perhaps mixing, etc. at affordable prices. These costs are coming down. At the same time, the availability of service contracts makes this more of a user-friendly technology.

## Municipal and state financing

In the future, it is likely that owner/operators will not maintain their own composting toilet systems unless they elect to do so. The United States Environmental Protection Agency and regulators worldwide are recommending the formation of on-site management districts in response to poorly maintained or inadequate conventional on-site systems. These would involve a central organization that manages a district's on-site systems, so no matter what system one has, an agency would be accountable for its performance. This also would allow on-site systems to receive the federal funds and financing that were once provided only for central wastewater treatment plants.

## The shift to ecosan progresses!

Thanks to these developments, composting toilets, long considered appropriate only for remote applications may soon be widely viewed as a conventional wastewater treatment technology with obvious advantages for the present and the future.

## Why haven't we changed sooner?

Progress in innovation and the use of alternative technologies for wastewater treatment has been slow. Factors include:

### Out of sight...

Our wastewater has been out of sight and often out of mind. As long as the public health bureaucracy said that what we were doing was good enough, there was little impetus for change. Now, high costs and health concerns are bringing wastewater back to the public's consciousness.

### Prescriptive versus performance standards

Septic systems have been the only on-site wastewater systems regulators would permit—the easiest approach from a regulatory standpoint. (Recycling wastewater, in fact, has been

illegal in most states.) Now, regulations are increasingly establishing treatment performance standards. Technologies that can meet those standards will be permitted.

### **“Toilet zoning”**

In many states, if a property’s soils are not right for a septic system, you cannot legally build on it, unless there is sewer access. Although the intent of this is to protect the environment, some town planners use such regulations as surrogate zoning bylaws to control growth. Now, with the advent of zero-discharge wastewater technologies, community planners see this control removed, and they fear that development will run unchecked. One answer is national land-use planning—not forbidding nonpolluting wastewater treatment methods.

### **Cheap drinking water**

Until now, drinking water was inexpensive. Since our water sources were perceived to be relatively free of contaminants, the only costs for supplying water were for transmitting it and filtering it. But now, the new Federal Safe Drinking Water Act’s more rigorous standards for water cleanliness require most communities to disinfect water. Chlorine has been the disinfectant of choice, because it is cheap. However, chlorine causes its own problems: Its byproducts, such as dioxin, and trihalomethanes, such as chloroform, are known carcinogens. Also, some organisms, such as cryptosporidium, are resistant to it, which has resulted in massive outbreaks of illness, including fatal instances in Cleveland and Detroit. These concerns are prompting some water treatment plants to switch to ozone and ultraviolet disinfection, and that is raising the price of water.

### **A powerful wastewater industry**

Since the 1972 passage of the U.S Federal Clean Water Act, a very powerful construction, engineering, manufacturing and government bureaucracy complex perpetuates the centralized collection and treatment model.

## **The future for ecological sanitation in North America**

As costs continue to rise for cleaning up water, wastewater and water pollution and as this pollution affects more of us more directly, the sound eco-nomics of ecological wastewater solutions will make them viable and mainstream choices.

In many parts of the world, acute water shortages call for the most strategic and efficient use of water, making waterless and low-water toilet systems a viable, if not overdue, solution.

Increasingly, composting toilet systems will evolve into microbial reactors that control all of the composting process variables automatically. They will be a more transparent technology requiring relatively little responsibility from their owner-operators. Periodically, the systems will deposit packets of high-powered designer composting microbes into the composter. In the future, we may refer to composting toilets as unsaturated aerobic systems, a broader term that better describes this approach to waste management.

## **Cost reduction**

Mass production and increased demand will bring down the cost of manufactured systems. At the same time, composters may be built right into building foundations in new construction. Self-contained composting toilets will become more aesthetically acceptable to more people. As in a



garbage compactor, the compost/end-product will be removed fully packaged in biodegradable bags that one either throws away or uses on a yard as soil conditioner. A municipal service person will come around every few months to check systems and perhaps take full composters to a central composting facility.

### Washwater reuse

Washwater will no longer be considered wastewater, because it is too valuable a commodity. It will be recycled for irrigation, often on rooftops of high-rise buildings and hanging gardens of vertical walls, as well as in landscapes.

Micro-flush toilets will advance, and will likely be used with all types of systems.

### Ecological water design in architecture

Ecologically integrated homes, with passive solar features, composting rooms and removal doors, and graywater-irrigated landscapes, will be the norm—and will look completely conventional.

### Change is happening now

Some key changes are occurring now. In rural and suburban communities, management districts are being formed for financing the construction, installation and management of on-site wastewater treatment systems. The goal is to extend the management and financing mechanisms for central systems to on-site systems, which are far more feasible and economical for many communities.

Today, many on-site wastewater systems are shared by small clusters of homes. Construction, operation and maintenance are managed through modified condominium agreements, an arrangement well suited to managing ecological wastewater systems. It is quite possible that, in the future, our central wastewater collection system will be used for commercial and industrial use only.

Some suggest this is harkening back to the past, when wastewater was recycled (but without processing). A more accurate view is that it is a timely converging of common sense, economics, resource management know-how, and improved technology.

### References

Del Porto, David and Steinfeld, Carol, *The Composting Toilet System Book* (Massachusetts, USA: The Center for Ecological Pollution Prevention, May 2000)

United State Environment Protection Agency, Response to Congress on Use of Decentralized Wastewater Treatment Systems 832-R-97-001b (Washington, D.C.: USEPA Office of Wastewater Management, April 1997)

Peter Rogers, personal discussion. Department of Environmental Sciences, Harvard University, Cambridge, Mass.

## Experiences with ecosan projects in Germany and Austria

**Dr. Martin Oldenburg**

OtterWasser GmbH  
Engelsgrube 81, 23552 Lübeck, Germany

The paper shows two examples of ecological sanitation systems in Europe and the first experience with these systems. Both are focussing the idea of source separation and utilization of nutrients of human wastewater as fertilizer in agriculture.

The first example shows the experience of the construction of a system with the separation of

- blackwater (toilet wastewater)
- greywater (wastewater from the bathroom, kitchen, washing....)
- stormwater

This system is installed in a residential area for 350 inhabitants in Lübeck-Flintenbreite. This is an example for a densely populated rural area. This semicentral system is capable to realize resources and energy recovery in more densely populated housing-areas up to 5.000 people. The area of the residential-area is not connected to the central sewerage system. All components of the sanitation concept are in use in different fields of application since many years and therefore well developed.

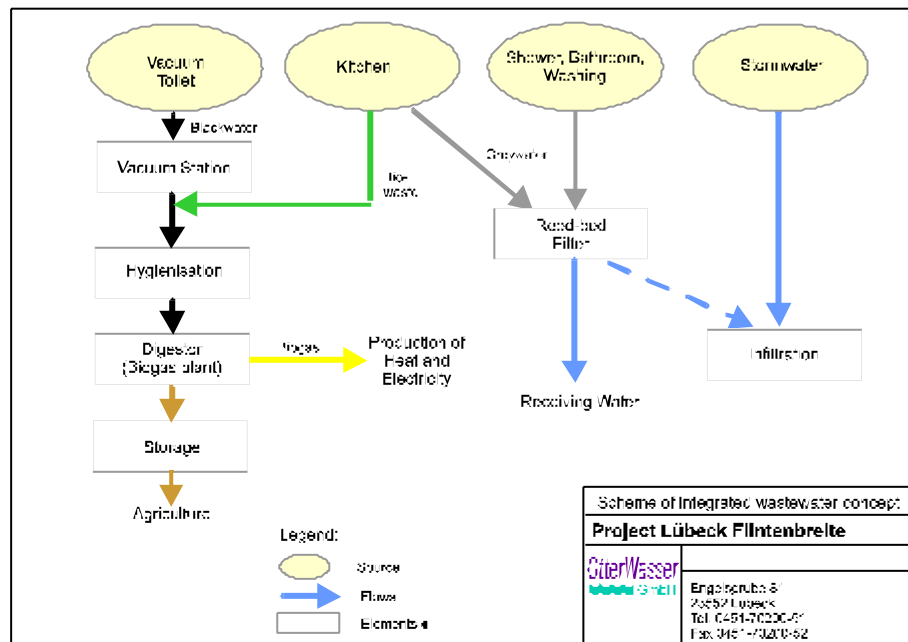

**Fig. 1: Scheme of sanitation system in Lübeck-Flintenbreite**

The system that is built in Lübeck consists mainly of the following components (Fig. 1):

- vacuum toilets with vacuum-sewer system and anaerobic digestion with co-treatment of organic household waste in a semi-centralized biogas-plant, recycling of digested anaerobic sludge to agriculture with further storage for growth periods. Utilization of biogas in combined

power and heat generator (heatage for houses and digester and production of electricity) in addition to natural gas

- decentralized treatment of greywater in vertical flow constructed wetlands (reed-bed filters) with interval feeding
- stormwater retention and infiltration in a swale system.

On the 3.5 ha area of the residential area terraced houses (Fig. 2), twin-houses and flats are situated. The houses were realized as low-energy-standard-houses to reduce the consumption of heatage and energy. In addition to the combined heat and power unit, which is able to use either natural gas and biogas, there is a passive solar system (conservatories) to support heating and an active solar system for warm water production.



**Fig. 2 Terraced houses of the Lübeck-Flintenbreite**

The central technical equipment is installed in a central community building (Fig. 4), which contains the units for the production of energy (heatage and electricity), the vacuum-station, the biogas-plant and all facilities for their distribution. Furthermore the residents can use the convention room for meetings or other events. Beside this four flats are located in this building, which can be seen as the heart of the settlement.

By the usage of vacuum-toilets (Fig. 3) with a water consumption of approximately 0,7 - 1,0 l per flush the dilution of the blackwater is very low. Because of the low dilution rate the common treatment with organic wastes from households by digestion in a biogas plant becomes possible. The vacuum pipes are dimensioned with 50 mm to allow good transport of the material. The pipes have to lie deep enough in the ground to be protected against freezing and must be installed with an up- and down gradient to create plugs of the transported matter. The vacuum system with the central vacuum is operating with 0,5 bar, the vacuum pumps have an extra unit for the case of failure. Noise is a concern with vacuum toilets but modern units are not louder than flushing toilets and give only a short noise.



**Fig. 3: Vacuum-toilet flushing with approx. 1 l per flush**

The low-diluted blackwater will be mixed with the shredded biowaste and hygienised by heating the feed to 55° C to 10 hours. The energy is further used by the digester that is operated mesophilic at around 37° C with a capacity of 70 m<sup>3</sup>. Another concern is the amount of sulphur in the biogas. This can be minimised by controlled input of oxygen into the digester or into the gas phase. The biogas plant meant to be a production unit for liquid fertiliser as well. It is important to consider pathways of pollutants from the beginning. One important source for heavy metals in wastewater is the installation material of the drinking water pipes. Today the mainly used material is copper, the connection material contains zinc. Instead of these materials for the installation of the drinking water pipes polyethylene materials are used. So the concentration of heavy metals in the sludge will be reduced significantly. This sludge will not be de-watered for having a good composition of the fertiliser and for avoiding a sludge-water treatment. The relatively small amount of water added to the blackwater keeps the volumes small enough for transportation. When the residential area will be completely under operation with all 350 inhabitants the daily volume of blackwater is estimated to 2.0 - 2.5 m<sup>3</sup> each day. The volume of greywater (approx. 25 m<sup>3</sup>/d) is ten times higher than the volume of blackwater. The effluent of the biogas plant will be stored for two weeks in a storage tank. Biogas will be stored in the same tank within a balloon that gives more flexibility in operation. The fertiliser will be pumped off by a lorry and transported to a farm nearby, that has a seasonal storage tank for eight months. These tanks are often available anyway or can be built with small investment. The storage of the liquid fertiliser on the farm increases the flexibility of nutrient utilization, because the farmer can manage the liquid fertilizer by his own and is independent from transport facilities.

Fig. 4 shows the community building. The biogas plant is located in front of the building - they grey concrete building beside the orange container. The storage is located under the sealed entrance area.



**Fig. 4: Community building of the residential area Lübeck-Flintenbreite**

The decentralised treatment of grey water is done by biofilm processes. The greywater can be treated easily, because it has very low contents of nutrients. Several projects on technical scale have demonstrated the feasibility and good to excellent performance of decentralised greywater treatment. Generally this treatment allows the reuse of the treated greywater, but in the Lübeck project this won't be economically feasible because of the low water consumption of the vacuum toilets. In this project vertically fed constructed wetlands with specific sizes of 2 m<sup>2</sup> per inhabitant are constructed. These constructed wetlands are very cheap in construction and especially in operation. The pre-treatment is made by a primary clarifier as a grit-chamber for solids and grease control. First measurements in the effluent have shown a very low concentration of nitrogen with 0,3 mg/l for ammonia and 0,4 mg/l for nitrate.

The stormwater from the roofs and the sealed areas will be collected in small gutters on the surface of the ground and will flow to the decentralised swales for irrigation. So the local water loop will be closed immediately. For avoiding the emission of heavy metals the roof material was chosen as aluminum plates. This material will oxidise its surface very rapidly and therefore the emission rates will be very low.



**Fig. 5: Gutter for the transportation of stormwater**

The infrastructure of Flintenbreite including the integrated sanitation concept is pre-financed by a bank and operated by the private company infranova GmbH & Co. KG, where participating companies, planners and the house- and flat-owners are financially integrated and will have the right to vote on decisions. Parts of the investments are covered by a connection fee, just like in the traditional system. Money saved by avoiding a flushing sewerage system, by smaller fresh-water consumption and by co-ordinated construction of all infrastructure elements (vacuum sewers, local heat and power distribution, water supply and communication lines) are essential for the economical feasibility of this concept. The internal fees for wastewater and biowaste charged cover operation, interest rates on additional investment and rehabilitation of the system. A part of the operation costs has to be paid for a part-time operator: this also offers local employment. The company cares for operation of the whole technical structures including heat and power generation and distribution, active solar systems and an advanced communication system, which is available for the residents.

A material and energy intensity study of the structure was using the MIPS-method in comparison to a traditional system at the Wuppertal-Institute in Germany (Reckerzügl und Bringezu, 1998). Material and energy intensity is less than half for the decentralised system as for a conventional central system serving a medium densely populated area. For the central system most of the material intensity results from the construction of the sewerage system. The predicted effluent values are based on averages of measurements of greywater. Effluent qualities are presented in comparison to average values of a modern treatment plant with an advanced nutrient removal and good performance.

The first experiences of the project are made on different levels. Such an integrated project needs a longer time for preparation. Especially here longer and more detailed negotiations with the permission authorities are necessary, because these authorities have to be integrated in the development of the project very early. The communication with other participants (architect, technical engineers) must start as early as possible. In comparison to traditional projects more knowledge in details are necessary during planning and design. The utilization of new materials, which have an ecological approach, can become very difficult, because these materials are often not available or are much more expensive than standard materials (e.g. pipes without

PVC, cables without PVC). The installation made by the tradesmen is more sophisticated and the existing knowledge with the new materials is sometimes very poor. So more supervision during installation becomes necessary.

At last the users have to learn and to change their behaviour. This is no problem, so long the people are able to understand the system.

The interest in the integrated concept described above has dramatically increased since the first publications (Otterpohl und Naumann, 1993) and the start of the project's construction in Lübeck. There are other projects where this type of concept shall be built. The system in general can be less expensive all in all than traditional systems. This depends on the possibility to infiltrate stormwater locally what is just becoming the standard approach. It also depends on the size of the area with around 500 to 2.000 inhabitants. Smaller units are feasible if black-water and biowaste mixture is only collected and transported to a larger biogas plant that would preferably be situated on a farm. The treatment of greywater can be done in an existing wastewater treatment plant if the sewerage system is nearby. In some cases this is the most economically way. Nutrient removal can be improved if a certain percentage of the population is served by a separate blackwater treatment.

Another project of source separation, which is developed for rural areas, is operating with the separation of urine and the utilization of the separated urine as fertilizer in agriculture. A scheme of such a sanitation system is shown in the Fig. 6.

Using separation toilets with can separate urine with a very low water-flush volume makes an utilization as nutrient rich fertilizer in the agriculture possible. The urine will be stored in a tank near the house and than on the farm. Very important will be the low consumption of water for flushing. New developed separation or No-Mix toilets are made for this purpose. In addition to these toilets waterless urinals can be use.

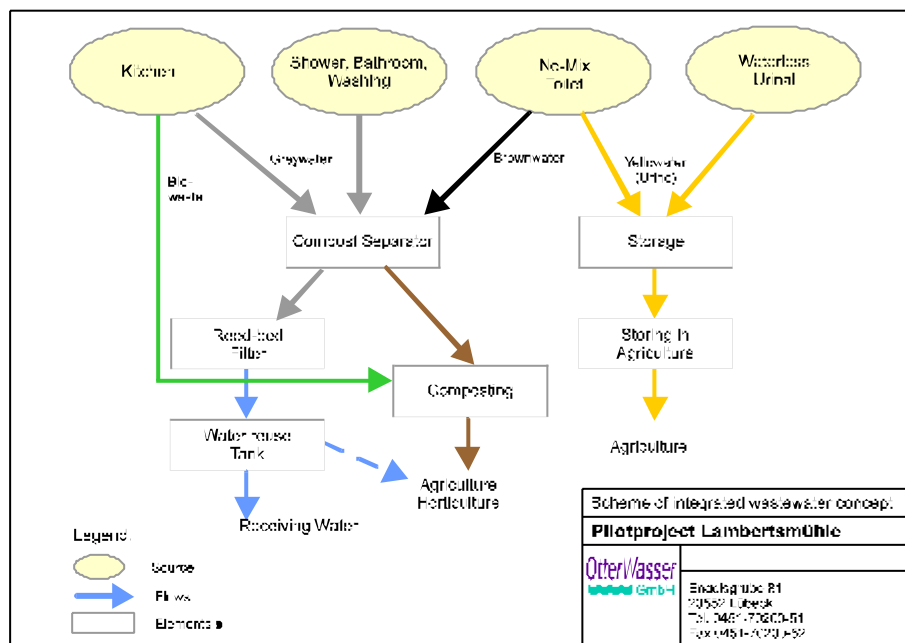

Fig. 6: Scheme of sanitation system for rural areas

The faeces of the toilet with a normal flush are transported in a conventional gravity sewer system. A compost separator will hold back undissolved materials. These material can be treated by composting together with the biowaste from the households. The compst will be used

as an addition to soils in horticulture and agriculture. The liquid effluent of the compost separator can be treated together with the greywater in the constructed wetland.

The separation and treatment of the greywater is described above. After the treatment a water reuse seems to be possible.

Both systems are an example for the realisation of new sanitation concepts which are regarding to the utilization of nutrients and the substitution of artificial fertilizers. Both systems are demonstration projects for sustainable ecological sanitation systems and are showing advantages concerning the reduction of emissions in receiving waters, energy consumption and the substitution of fertilizer.

## Literature

- Beck, M. B., Chen, J., Saul, A. J. und Butler, D.: Urban Drainage in the 21st Century: Assessment of new technology on the basis of global material flows, *Water Science & Technology*, Vol. 30, No. 2, 1994, pp. 1-12
- Harremoes, P.: Integrated Water and Wastewater Management, *Water Science & Technology*, Vol. 35, No. 9, 1997, pp. 11-20
- Henze, M.: Waste Design for Households with Respect to Water, Organics and Nutrients, *Water Science & Technology*, Vol. 35, No. 9, 1997, pp. 113-120
- Henze, M., Somolyódy, L., Schilling, W. und Tyson, J.: Sustainable Sanitation. Selected Papers on the Concept of Sustainability in Sanitation and Wastewater Management, *Water Science & Technology*, Vol. 35, No. 9, 1997
- Lange, J. und Otterpohl, R. *Abwasser. Handbuch zu einer zukunftsfähigen Wasserwirtschaft*, Pfohren, Mallbeton Verlag, 1997
- Larsen, T. A. und Gujer, W.: Separate management of anthropogenic nutrient solutions (human urine), *Water Science and Technology*, Vol. 34, No. 3-4, 1996, pp. 87-94.
- Londong, J., Strategien für die Siedlungsentwässerung. in *Korrespondenz Abwasser* 10/2000, S. 1434-1443
- Otterpohl, R., Oldenburg, M., Büttner, S.: Alternative Entwässerungskonzepte zum Stoffstrommanagement, *Korrespondenz Abwasser*(46), Nr. 2
- Otterpohl, R., Grottker, M. und Lange, J.: Sustainable Water and Waste Management in Urban Areas, *Water Science and Technology*, Vol. 35, No. 9, 1997, pp. 121-133 (Part 1)
- Otterpohl, R., Oldenburg, M., Zimmermann, J.: Integrierte Konzepte für die Abwasserentsorgung ländlicher Siedlungen, *Wasser & Boden*, 51/11, (1999) pp 10
- Otterpohl, Ralf; Albold, Andrea and Oldenburg, Martin: Source Control in Urban Sanitation and Waste Management: 10 Options with Ressource Management for different social and geographical conditions, *Water, Science & Technology*, No.3/4, 1999 pp 10
- Otterpohl, R. und Naumann, J.: Kritische Betrachtung der Wassersituation in Deutschland, in: Gutke, K. (Hrsg.): *Umweltschutz, Wie? Druckschrift zum Symposium "Wieviel Umweltschutz braucht das Trinkwasser?"* am 22.-24. September 1993, Köln, Kirsten Gutke Verlag, 1993, S. 217-233
- Reckerzügl, M; Bringezu, St.: Vergleichende Materialintensitäts-Analyse verschiedener Abwasserbehandlungssysteme, *gwf-Wasser/Abwasser*, Heft 11/1998



## Reducing wastewater problems in low-income semi-urban communities in Kathmandu Valley

**Eveline Bolt**

IRC International Water and Sanitation Centre  
POBox 2869, CW Delft, the Netherlands

### Reflections on the outcomes of a workshop

#### Introduction

For a large number of communities modern sewerage systems are neither feasible nor desirable. In particular in communities where large quantities of water for flushing are not available, or where laying sewer pipes is not possible due to congested housing, and the large treatment plants required may be too expensive to build and maintain, alternative solutions need to be found. If they do not want to be left with hazardous and unpleasant situations, communities and local authorities will have to look for alternative ways to treat and dispose of wastewater in a safe and ecologically sound way.

In Kathmandu valley in Nepal many of such communities exist. A workshop was held with representatives from four of these communities (Kusunti, Siddhipur, Panga and Madhyapur) to map out their particular problems concerning waste water, to discuss a variety of possible solutions to solve these problems taking into account ecological sanitation principles and to assess people's willingness to test these alternative solutions.

#### What is the problem?

Kathmandu valley is full of high-risk communities: small urban semi-agricultural communities. Major water supply and sanitation problems exist and with a population growth of 2,2 percent per annum, these problems aggravate rapidly. Many households do not have access to the sewerage system and many even lack a well-designed septic tank. Defecation fields and alleys are found at short distances from living areas. Drains are blocked and solid waste is found everywhere. The resulting picture is grim; groundwater gets polluted through leaking tanks and once the monsoon starts, overflow from septic tanks as well as faeces lying around on defecation fields cause surface water in ponds and streams to become seriously polluted. Since groundwater as well as water from ponds and streams are used for domestic purposes like drinking, washing, bathing (human beings and cattle) and washing clothes and utensils, people face serious health risks and nuisance. In addition, this uncontrolled disposal of wastewater implies an enormous loss of nutrients that could otherwise be used for agricultural production.

These communities do not get the attention they deserve. The congested nature of these communities and increasing water scarcity make them "not easy to deal with" from the conventional engineering perspective. In addition communities with a Hindu majority may not be easily convinced to go for ecological sanitation options, since these ultimately require handling of faeces, which is considered to be extremely "jhuto".

At the same time local authorities and government departments, often unable to deliver public health services by themselves, are to find ways how they can best support initiatives towards

improving environmental sanitation of Community Based Organisations, NGOs and the private sector. Sustainability of facilities and services can only be achieved by involving all stakeholders, including these local authorities and governmental departments. Effective involvement of these stakeholders requires mutual commitment and partnership. Being able to work in sustainable partnership requires the ability to i) diagnose the needs and preferences of end users and plan small scale improvements accordingly, ii) agree on sharing management and maintenance responsibilities among the stakeholders and iii) effectively share (monitoring) information.

### About the workshop

The workshop brought together a mix of people from Kusunti, Maddhipur, Siddhipur and Panga: school teachers, local leaders, social workers and students from the communities, resource persons from Nepal as well as from the Netherlands and representatives of the Nepal Water Supply Corporation.

The Overall Objective of the workshop was:

to create the conditions for sustainable improvement of the environmental sanitation and water supply situation, in particular of the surface and groundwater quality, in selected communities in Kathmandu valley.

The more Specific Objectives were:

- to carry out a participatory analysis in four communities on needs and demands for small-scale waste water treatment and disposal facilities as a means to reduce health risks and to improve the quality of ground- and surface water;
- to provide information on small scale treatment and disposal techniques that are sound (i.e. technically appropriate and manageable by neighbourhoods or the community) for semi-urban, hilly areas in Nepal;
- to develop elements of a proposal for applied research with community representatives involved and potential support organisations.

A first step in the workshop was to work on a participatory field analysis of needs and demands for small-scale environmental measures such as wastewater treatment and disposal systems. Field visits to collect information were prepared, carried out and evaluated by the workshop participants. The field analysis was followed by knowledge exchange on small scale, community manageable disposal facilities and on possible measures for improvement of water quality, which include simple methods for water quality assessment and monitoring. These two steps led to the development of a proposal for applied research through experimentation with small, community-managed waste water treatment options and disposal facilities and other possible measures. Once funding is obtained, implementation of the action research can start. This will be followed by evaluation of the results, adaptation of processes and technologies and scaling up.

### Some data resulting from the field analysis

In the context of the workshop the field analysis took some six hours. It can therefore only be considered to be rough and very preliminary. Still, a picture of major environmental sanitation problems emerged:

**Kusunti:** Through the assistance of a local NGO a start was made with laying sewers, but many of the badly constructed septic tanks are not (yet) connected. However, the last part of the pipes could not be connected to a main line, because the neighbouring community doesn't want the sewage coming through this line to be discharged into the river. There are no municipal arrangements for drainage and road construction. The drainage programme started in an unplanned way, has technical weaknesses and open drainage is a big environmental problem. Wastewater, including water coming from the local tannery, badly affects agricultural land. Community members, including the women, feel the wastewater problem and seem helpful and interested to work with organisations wanting to support them to improve the situation.

**Siddhipur:** This is a more agricultural community, with a high population density. Open defecation, blocked drainage channels and bad drinking water quality from taps and wells, causing a high risk of getting water born diseases, are major problems. Sewers are not in place and some community members purchased a double vault, poor flush latrine through a programme that installed demonstration latrines some eleven years ago. Garbage is poorly managed. Villagers are conscious about the drainage problem and consider it a major problem. The Village Development Committee has a proper plan, but no finances. However, people are ready to contribute finances and labour.

**Panga:** A sewerage master plan has been developed, but no funds are available as yet. Part of Panga is not included in the master plan, since it finds itself on the other side of the local watershed. In this part of Panga a network of sewers is in place and discharge is the main problem. Much of it is discharged into agricultural land and in two big, leaking collection tanks. Open defecation is also practised. People lost faith in the government and prefer working with NGO's. There are a number of community-based organisations and people seem to be ready to contribute labour.

**Madhyapur:** A densely populated area on a ridge and wastewater flows away easily. Within the village it is somehow controlled with a sewer running through the main street, but discharge is in small rivers. An INGO built a treatment plant, but part of the construction works was washed away during the last monsoon and no maintenance is carried out. The plant is not functional and causes a major health hazard. A large part of the community is not connected to a sewer and many households discharge toilet and kitchen waste on open drains. Open defecation is yet another major problem, causing the outskirts of the community to be very dirty. Water supply is intermittent, leading to long waiting times. People are ready to contribute to improvement of the situation, but they had a bad experience with the INGO leaving the work unfinished.

### What to do/possible solutions?

When looking at possible solutions issues such as existing practices and people's demand for improved facilities, their attitude towards the possible use of human excreta, existing and required management structures, feasibility of certain technical options. Men, women, rich and poor need to be consulted. The technical solutions proposed during the workshop to solve the environmental and nuisance problems are based on the principle that mixing of black waste, grey-, and white water should be prevented as much as possible. These three flows should be handled separately. If done properly health hazards will reduce and a good ecological system will emerge and money can be saved or even earned, because:

- less expensive fertiliser is needed;
- less water is needed, because faeces do no longer have to be flushed away;

- expensive treatment can be avoided;
- manure can be sold.

### The nutrient cycle of a Nepali community

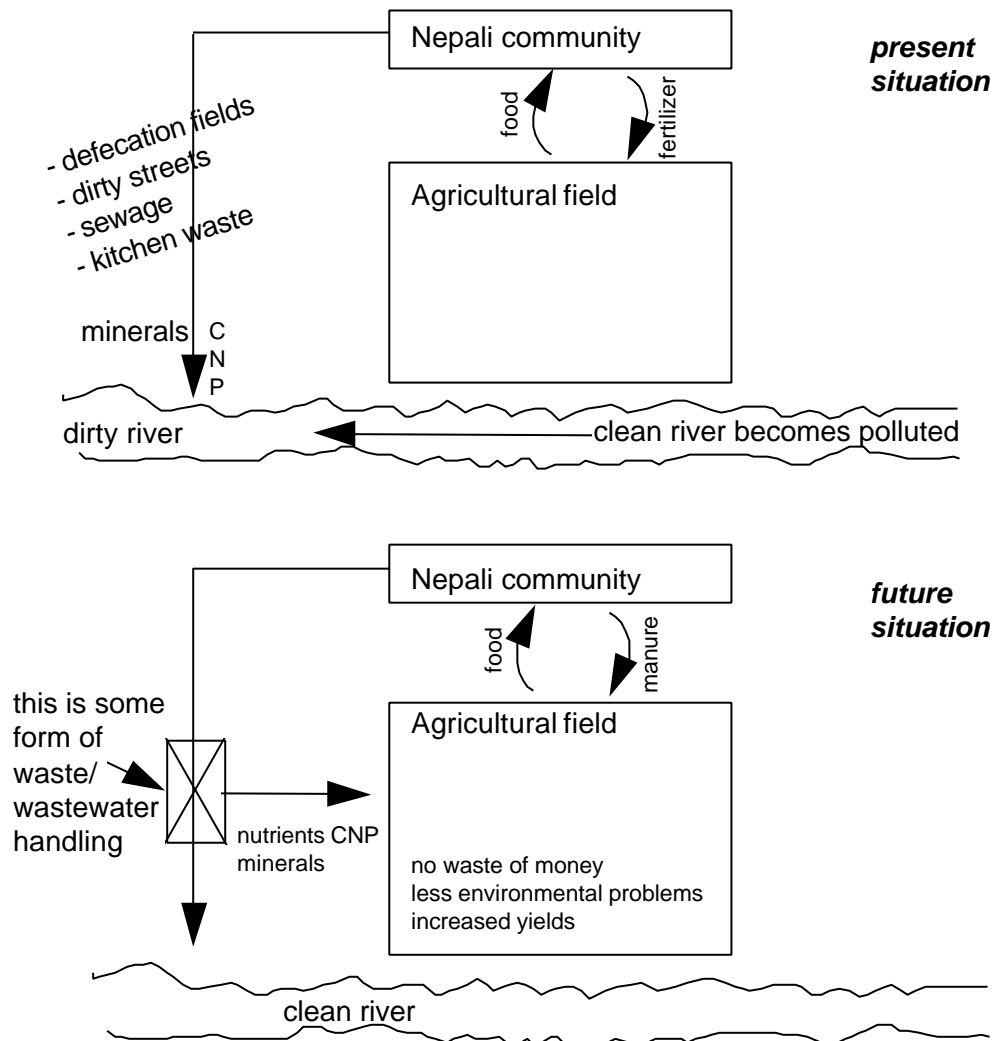

While looking at various options to improve environmental conditions the following general points were raised:

1. As much as possible separate collection and composting of dry, black waste;
2. Collect and treat grey water;
3. Collect urine for mixing with ash as manure or simple treatment of urine with grey water;
4. Use white water for recharge of groundwater;
5. Take into account maintenance and management funds and capacity of whatever is opted for;

6. Take into account people's attitude towards the use of urine and human excreta;
7. Work on public awareness and education.

Possible technical solutions included the use of toilets allowing composting of black waste, improvement of existing gutter systems for stormwater in order to recharge groundwater and the construction of wetlands for treating grey water.

Looking at the situation in the four communities involved, the following points about the different flows of water seemed important to discuss:

### **White water**

It is important to prevent that (white) rainwater mixes with waste. Rainfall is very unevenly distributed over the year, with high rainfall during the monsoon and no or hardly any rainfall in winter. Many of the semi-urban communities have old discharge systems meant to carry monsoon water, but these are often poorly maintained and therefore less functional. These old systems of gutters and existing pipes can be upgraded for discharge of rainwater, which can be used for recharge of groundwater through ponds or for irrigating agricultural fields. However, proper management of solid waste is imperative for gutters to function.

### **Black waste**

Flush toilets are comfortable, but expensive in terms of capital costs and costs for water used for flushing. They induce an enormous amount of waste water (15,000 l of water/capita/year is needed to flush away 50 l of faeces and 500 l of urine) that is to be treated if we want to prevent a health hazard through uncontrolled discharge. Adopting a safe system of black waste collection seems more appropriate, because water is getting scarce and/or expensive. Black waste should be kept as dry as possible (night soil), by using double vault private or public toilets. Mixed with cowdung, ash, straw and agricultural waste it can be composted for use as manure at a later stage. Urine is best collected separately for reuse of nutrients in agriculture. In some communities mixing of urine with ash for use as manure is already practised.

### **Grey water**

Separate grey water lines can be constructed for washing, bathing and kitchen water. The nutrient in this waste can be used for growing products in constructed wetland systems or (fish) ponds. Management of such treatment plants can be done by organisations or private persons deriving benefits from the products. Should waste water flows become too big or when insufficient space is available, oxidation ditches can be considered. Treated water can be discharged into a river or be used to recharge groundwater or irrigate land.

## **Working towards change**

The workshop provided quite some ammunition for the development of a proposal for applied research. Acknowledging that effective management structures are as important as appropriate technical options, elements for the proposal include starting broad consultation processes, detailed investigation, participatory selection of the most appropriate technical and managerial solutions and experimenting with these solutions.

The proposal does not only focus on finding the locally most appropriate technical options, but also on finding options for sustainable maintenance and management. In particular with respect to the latter it will look into the interface between local authorities, the private sector and the community. The objectives of the research proposal have been defined as follows:

- to establish mechanisms for and carry out broad based participation processes for further investigation: area consultations, community fora, etc.
- to plan and implement micro-projects to i) eliminate hazardous situations brought about by uncontrolled disposal of wastewater, ii) help restore the ecological balance and iii) make profitable use of wastewater.
- to find effective management models and partnerships between local authorities and community based organisations for sustained service levels (also in case of growing populations) and for ensuring that people continue to make effective use of the facilities.
- to develop monitoring capacity for sustained improvements.
- to disseminate experiences within the country.

The communities involved in the workshop are prepared to act as pilot sites for testing the technical and management options.

## **ANNEX (as produced by workshop participants)**

### **About Madhyapur (Thimi) community**

#### **Introduction**

Madhyapur Thimi, which is one of the oldest communities of the Kathmandu Valley, is situated in the middle of the historical city called Bhaktapur and the capital city Kathmandu. Like other old cities this city is also situated on elevated land and therefore one has to climb up to reach this city. Thimi occupies an area of 2 square kilometers and the area has been divided into 8 wards. This report has been prepared with special consideration to ward no. 11,12,13 and 14.

Although the area under consideration occupies an area of 1 sq. km., it has a population of about 1400 and it is a dense community. The community has a lot of problems. These two problems have caused other problems and therefore also these problems are serious. These frightening problems have inflicted negative impact on public health and environment and one can easily guess the kind of state the people of this community are living in. An effort of one single workshop can not analyse, identify and also solve all problems. Therefore, this report has been prepared with reference to wastewater management.

#### **Major problems of wastewater management**

In the community, in about 90% of the area sewer have been laid for the collection of wastewater. It can be hoped that remaining 10% area will also have sewers. Therefore, there seems to be no major problem in conveyance and collection. Since there is no separate line for sanitary sewer and stormwater, there is very low flow in the dry season and very high flow in the rainy season in these sewer lines. Sometimes the flow in the sewer lines exceeds the capacity of the pipes and causes serious damage. The wastewater from the sewer lines is released in the open field. From the open field the wastewater joins gutters and small canals which finally merge into the Hanumante river. Because of lack of proper management of wastewater, following problems have been created.

1. The sewer constructed in Hatimahankal, which collects wastewater from three directions, flows towards Siddhikali. This sewer has made the area polluted and due to low capacity of the pipeline there occurs a lot of overflow. The wastewater is released untreated.
2. Problem caused by open toilet drain.
3. Wastewater from Chodetol, Dui pokhari, Simatole and Dathutole is collected near Taha dugwell. The wastewater then flows to Lhabaha where also acidic waste mixes and the combined waste has severe adverse impact in the surrounding agricultural field.
4. Open drains from Bamune area flowing towards Bappa and wastewater from Chode mix in Bappa which has made the whole area polluted.
5. Wastewater collected from Inalachi passes through Balkumari China Road and merges into Hanumante River which has very much polluted Hanumante.

## 6. Wastewater collected from Sunkha and Dadhutole passes through Bishnukundal and mixes into Khucha

A field observation was done in order to know the gravity of the situation. Various types of information were collected by filling up questionnaires in order to find out the potential solutions. Some of the aforesaid things are also based on the information thus collected. After interaction with various groups of the community overall state of the community and possible solutions were identified. The various groups were composed of elder people, women, local authorities, and men. The points identified to be considered after the interaction with these people are the following.

### Technical need

There seems to be no significant problem relate to aspects. Due to Thimi's geophysical feature wastewater can be transported via gravity flow. A lot of public land is available. Besides, local authorities have realised the local situation and therefore are committed to solve the problems by providing technical human resources. As has been said before, the main need of the community is to manage the wastewater collected by the drainage pipes already laid in 90% of the area of the community. On top of that most of the drainage pipes were laid within past few years only. They are still in good condition, but need to be maintained.

Before managing wastewater it is essential to know the nature of the wastewater. Local authorities do not seem to be much aware of the nature of wastewater. After field observation it is believed that the wastewater is mostly organic. However, the non-biodegradable component is gradually increasing. Hanumante river receives a lot of industrial wastes. At Lhabaha area the wastewater is acidic due to the acidic effluent from the production of alcohol in households. An appropriate method of treatment should be sought for such wastewater. Besides, analysis of the cause of the failure of the treatment plant constructed by Plan International can provide some insight into the technicalities of wastewater treatment. Although there is a big problem of wastewater management, there is not any significant plan and programme to overcome it and the problem is growing. The problem has been compounded by the lack of sufficient water supply.

### Cost of construction

A huge amount of funds may be needed to manage the wastewater. However, this cost is far outweighed by the benefit that can be reaped from it. Local community is of the opinion that it is possible to contribute partial fund which will be little as compared to the total amount needed. However, the local authorities are willing to contribute some from their side and local people may also contribute some labour. These in total may mount up to a significant portion of the total cost. Therefore, it is almost certain that a donor agency is needed to meet the large part of the financial need. Since the sewer drain has been laid only a little cost is needed for maintenance of the lines. Availability of the public lands will also lessen the financial burden of construction.



### Management and operational cost

Since the wastewater problem has caused a lot of discomfort local people are committed to solve it. People are also aware of the need for proper operation and maintenance of any project after implementation. There are several NGOs and clubs which have shown interest and they can also help in operation and maintenance. Similarly, user groups can be formed in order to make the project sustainable. Donation can be collected from the households and also minimum fees can be collected to meet certain operation and maintenance cost. In a nutshell, the cost of maintenance and operation of a project can be met by the local community.

### Technical capability to operate and maintain

The community should be technically capable to operate and maintain the projects related to wastewater management. If the community is not capable then all the effort could be wasted. Since the people of Thimi are educated they can understand simple technicalities about wastewater management. Technical human resource is also locally available in order to run a project in a sustainable manner. With some training local people can also operate different equipment if needed. Therefore, this community is technically capable.

### Social acceptance

The community has suffered due to lack of wastewater management. Although the community is aware of adverse impact of unmanaged wastewater on health and environment it has not been able to solve the problem due to its complex nature. However, any step taken towards solving the problem will be highly appreciated by the community. The community knows that it is their problem and they are the ones who should take initiative towards managing the wastewater. Somehow this is not happening. In case any external institution can take the initiative the local community is ready to help as much as possible. They are also committed to appropriately manage any project. They strongly believe the projects can be run smoothly without disturbance. However, due to some previous incomplete projects local people sometimes raise doubts about upcoming projects. For example, since the treatment plant constructed by the Plan International was left incomplete, local people have become not only unsatisfied, but also angry.

### Environmental impact

It is undisputed that unmanaged wastewater has caused adverse environmental impact. The wastewater has made the canals and Hanumante river highly polluted. Since the wastewater also flows in open canals it has also caused a lot of nuisance. This pollution has imposed harmful effects on public health. All the people suffer from diarrhoeal diseases. All of this has resulted into decreased living standard because a major portion of their income is used for medical treatment. Besides, the wastewater has also been used for irrigation which has imposed negative impact on the health of farmers and the crops as well and this has affected the overall economy of the community. The acidic wastewater has further heightened the problem. Since the water in the canals and creeks are polluted due to wastewater, farmers use stone taps, wells and piped supply for washing their vegetables and therefore drinking water

shortage has increased. Besides, the signs of soil erosion and landslides due to rain have emerged and the overall physical feature may be damaged ultimately.





## Results of Parallel Session 4 presented at the plenary

"How can we identify and evaluate best practices?  
What are the priority research demands?"

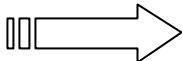
1. Prefer affordable simple technology  
with sexy appearance, visible incentives  
explained in positive language  
pictures, models
2. Modules can form good practice
  - Low/No flush toilets / Sorting/Not
  - On Site, Semi-Central (central?) Treatment:  
Composting, Desiccation, Biogas Plant
  - Greywater Reuse
3. Operation of Systems, Products, Transport and usage in  
Gardens/Agriculture  
 KEY ISSUE!
4. NETWORK ECOSAN  
help facilitation, informed decisions, training locals
5. Research Blackwater, Urine and Greywater Recycling including  
Hygiene, New Toilets, Usage of Products Operation



## Minutes of Parallel Session 4 <sup>1</sup>

The subjects listed below in groups of like thematic areas were discussed at the workshop.

### Technology

- In principle, solutions should be as low-tech as possible (easy to handle) and require little to no flushing water
- Technologies should only be separated by short distances (to facilitate loop closure). Technologies should include utilization of all potential products (including yellowwater / urine, brownwater / faeces, greywater, rainwater)
- A range of candidate technologies must be offered to give decision makers a choice of options
- Appropriate models / modules should be developed to enable tailoring of solutions to fit local situations
- Several projects have been successfully implemented in rural areas; in the future, urban areas should be in the focus of development and research (including urban agriculture)
- Technologies of special interest: no-flush toilets, low-flush toilets, separating toilets, membrane technology (where reasonable)
- Faeces treatment options of special interest: digesting, composting, desiccating
- Application opportunities for Ecosan should be investigated in refugee areas / camps
- Solutions must distinguish between humid and arid regions (appropriate to local environment)
- Technical specifications should be generated as a basis for construction
- Training for construction workers should be developed and provided
- Wastewater production should be reduced via best available water conservation measures and reuse before treatment

### Health aspects & utilisation

- The exact biological composition of the products has to be investigated
- The necessary duration of hygienization of the products has to be investigated under different conditions
- Concepts should be developed to avoid health risks in connection with the handling of products
- Opportunities for agricultural application should be given further investigation

<sup>1</sup> Minutes taken by Gunnar Specht and Gernot Witte

## Social factors

- Marketing and selling strategies have to be developed
- Technical handbooks on educational advertising should be developed
- Social and economic benefits should be explained to potential users along with (or in place of) ecological advantages (personal benefits)
- New ideas demand new language (positive terms)  
waste -> products  
contaminants -> nutrients
- The wishes of, and requests by, potential users must be taken into account
  - explanation of / information about various technological options (including conventional and Ecosan systems)
  - extensive parallel activities for information and training of the users

## Economic issues

- The investment and maintenance costs of various technical solutions have to be assessed
- A model should be developed for comparing the economics of conventional and Ecosan systems with respect to cashflow and lifetime
- Operation models should be developed for the household and community levels

## Sustainability / project partners

- Partners for pilot projects must be selected with care, i.e., institutions that were working sustainably before / without the pilot project
- After identifying potential partners, the pilot projects should be advertised for bids, and suggestions on implementation should be solicited from the partners (commitment check)
- Prior to launching any pilot project, GTZ should define the criteria for the choice of location / partners

## Legal issues

Public authorities must be involved as early as possible in order to avoid legal problems

## List of participants

Agarwal	Anil	India	Centre for Science and Environment
Backlund	Arne	Denmark	A&B Backlund ApS
Behnke	Stefan	Germany	Roediger Vakuum- und Haustechnik GmbH
Berger	Wolfgang	Germany	Berger Biotechnik GmbH
Biesinger	Brigitte	Germany	Consultant
Bittner	Michael	Germany	AQUAMAR GmbH
Bolt	Eveline	Netherlands	International Water and Sanitation Centre
Braun	Ulrich	Germany	AK Wasser vom BBU
Brown	Julia	Jamaica	Scientific Research Council
Dadie-Amoah	Kwasi	Germany	WAREM, Universität Stuttgart
de Bruijne	Gert	Palestine	Palestinian Hydrology Group
Del Porto	David	USA	Sustainable Strategies and Affiliaties
Detmer	Andrea	Germany	BMBF
Forde	Lester	Trinidad West Indies	- Water For The People
Franke	Asdrig	Germany	
Franke	Christian	Germany	Consultant
Gottschalk	Uta	Germany	GTZ
Grangler	Andreas	Germany	Technische Universität Berlin
Hulshoff Pol	Look	Netherlands	Wageningen University
Ingvar-Nilsson	Sven	Sweden	WM-Ekologen AB
Jendrischewski	Wolfgang	Germany	Gitec Consult GmbH
Jesuthasan	G.	Sri Lanka	National Water Supply & Drainage Board
Karl	Volker	Germany	KfW
Kazner	Christian	Germany	Dr. Dahlem Consulting Engineers
Keil	Ulrich	Germany	STEAG Energie- und Kerntechnik GmbH
Keipp	Waltraud	Mali	GTZ
Lehn	Helmut	Germany	Center for Technology Assessment
Lopez Zavala	Miguel Angel	Japan	Hokkaido University
Niemann	Ernst- Jürgen	Germany	DECON Deutsche Energie-Consul Ingenieurgesellschaft mbH



Oldenburg	Martin	Germany	Otterwasser GmbH
Otterpohl	Ralf	Germany	Technische Universität Hamburg-Harburg
Pabsch	J.	Germany	IPP Consult
Rakelmann	Ulf	Germany	Hamburger Stadtentwässerung
Ratka	Richard	Germany	German Foundation for International Development
Renner-Häberle	Ylva	Germany	KfW
Schäfer	Dirk	Germany	Universität Witten/Herdecke
Schlegel	Michael	Germany	Lahmeyer International GmbH
Schönborn	Andreas	Switzerland	
Sender	S.	Madagaskar	GTZ
Siebel	Michael	Germany	Dorsch Consult Ingenieurgesellschaft mbH
Specht	Gunnar	Germany	Planco Consulting GmbH
Spies	Sandra	Germany	UTG Control
Stoll	Uwe	Germany	KfW
Thomas	Peter	Germany	HATI
Tränkler	Josef	Thailand	Asian Institute of Technology
Vasudevan	N.	India	Anna University
Wesenberg	Rainer	Germany	MISEREOR, AGEH
Windberg	Constanze	Germany	Technische Universität Hamburg-Harburg
Witte	Gernot	Germany	GTZ

## Parallel Session 5

# Potential and limitations of the “scenario technique” as a contribution to sustainable urban planning

**Key Question:** “ What are the means for realistic and sustainable planning methods?”

**Moderators:** **Dr. Harald Hiessl** (Fraunhofer Institut, Germany)  
**Frank Sperling** (Emschergenossenschaft, Germany)  
**Dr. Jan-Olof Drangert** (Linköping University, Sweden)

## Lectures

**Wastewater irrigation in the state of Victoria, Australia**

Dr. Percival Thomas (La Trobe University, Australia)

**A national PhD programme for developing future sanitation systems in Sweden**

Dr. Jan-Olof Drangert (Linköping University, Sweden)

**Urban and rural sanitation concept with nutrient recycling and energy gain**

Dr. Katharina Backes (Consultant, Germany)

**Auroville 2001 – a town dependent on its rain- and wastewater**

Harald Kraft (Consultant, Germany)



## A national PhD programme for developing future sanitation systems in Sweden

**Dr. Jan-Olof Drangert**

Dept. of Water and Environmental Studies  
Linköping University, Sweden  
Tema V, 581 83 Linköping, Sweden

The Swedish Parliament recently passed a new law on the environment, which includes principles for the protection of the water cycle. The regulations put pressure on the city councils by introducing a fee per ton of sludge deposited on landfills. By the year 2005 the WWTP are not allowed to deposit sludge in this way, and they have to come up with new solutions to the sludge problem. The avenue to put the sludge on farmland was closed a year ago when the Swedish Union of farmers recommended its members not to apply sludge on their farms. The challenge does not only rest with the city councils, but also universities are involved in research geared towards alternative treatment of wastewater and sludge.

A motivation for universities to review and to study a restructuring of the present unified piped systems is the new requirement of sustainability, that has not been considered or addressed specifically earlier. Eight Swedish universities embarked on a joint PhD-programme called Sustainable Urban Water Management 1999. The 5-year programme involves 15 PhD students with varying basic training such as social sciences, natural sciences, agriculture and technical training. The basic challenge for the research school was to develop a programme which would encourage creative and independent thinking among the students, since they are to explore options for the next generation of water and sanitation systems in Sweden.

The Urban Water Research School aims at training doctoral students in a holistic approach to urban water management. At the same time, they will specialise in various disciplines ranging from microbiology and technology to socio-economic studies. The dual goal to become a specialist and a generalist is ambitious and requires a conscious training/learning strategy.

The challenges confronting the joint courses are met by using a problem-based learning method. The content of the joint courses requires great care to bring out the curiosity and involvement of the PhD students. The students are put in situations where they themselves can assess what they know and what they need to learn in order to accomplish the training goals. The pedagogical method used by the research school mimics research work; formulation of questions and finding out what is already known, plan and carry out a study to address the research question. It is a cumulative process in the sense that each step builds on earlier results or challenges them. In both cases the reasoning is documented so that others can pursue the arguments in detail.

The initial joint studies deal with acquainting oneself with the full range of urban water issues and the various methods and theories used by the involved disciplines. The students are also encouraged to reflect on their own learning and group processes.

The first course dealt with fundamental questions about alternative choices to bring water to the dwellings, to dispose of it, and take care of the nutrients. It was aimed at de-learning the common view that the present system can only be refined – not be radically changed. The task given to the PhD students was to develop a “pipe-less city”. The following course addressed the historic evolution of the piped systems in towns. The students wrote individual papers on broad issues covering a considerable period of time between 1850s to 1970s. For instance, the evolution of a town’s system including some of the driving forces behind it, or of the evolution of

a concept. The understanding emerged that sewerage was not an obvious choice at the time of introduction, but heavily contested also by technicians. The third course focussed on creative use of technical advances in membrane techniques, biological methods in treatment and IT that could be applied in the future urban water and sanitation sector. Here, emerged the view that alternatives may be both high-tech and low-tech, centralised or decentralised. In the last course of the first year the students “negotiated” a draft outline of their individual thesis work with their peers in order to take advantage of the colleagues’ intended studies and to improve the fit to the system analysis.

All studies included a component of the socio-cultural and economic aspects of the sanitation issues, and the distribution of responsibilities between individual households and professional groups. The PhD students valued the impact of socio-cultural aspects and that any system – centralised or decentralised – depends on the acceptance of the users and of the professionals. A way to respond to this, it was argued, would be that future systems are more individualised to cater for varying demands.

Another objective of the research school is team-building. This has been achieved through the learning method, which creates favourable conditions for active students and productive co-operation over disciplinary and professional borders. The students work in groups of 6-8 persons on given cases (like the pipe-less city above). The learning method may be characterised in the following way:

- 6-8 PhD students form a working group, called a base group
- they meet for 1,5 hrs twice a week to report back to the base group and discuss what next
- each meeting ends with a quick evaluation of the progress of the group work
- a base-group facilitator is present at each meeting to assist the group in its self-reflection, in identifying circumstances affecting the group process, and in working towards the study goals
- a case provides the direction of the group work
- a detailed list of learning goals (formulated by the teachers) guides what to learn
- a “7-learning-steps” help the PhD students to be efficient in their group work
- the base groups demand specialised lectures on issues that they cannot solve on their own
- there are only few pre-organised lectures (international and national resource persons)
- a few references are recommended and the base group decides on what literature to study
- the student keeps a diary and is encouraged to reflect over the learning and group processes
- student work is evaluated from written papers, oral presentations, individually or in a group

As seen from this list the responsibility for the learning is largely with the PhD students. They formulate the problem accruing from the case and this means that different base groups formulate different research questions. The teachers exercise their influence mainly through the formulation of the case and, more important, through the learning objectives. The gain is that each student can contribute his/her (individual) competence in the group’s work. He or she will benefit from the competencies of their fellow students in their strive for integration of knowledge and perspectives which, in turn, are necessary in order to describe and analyse the case. In this way each student acquires knowledge which is lacking and contributes earlier learned issues to the group.

The experiences of using the problem-based method is that it manages quite well to foster an understanding and respect among the PhD students toward one another's disciplinary orientation. They work very hard and focussed on their tasks and the students will become the guardians of integration and co-operation within the programme. Acknowledging the difficulty to assess personal development, the general impression is that the doctoral students mature rapidly and take own initiatives and are more willing to take on new tasks. They are socialised into the context of the broad Urban Water Management programme.

## Urban and rural sanitation concept with nutrient recycling and energy gain

**Dr. Katharina Backes /** RESOB Ingenieurgesellschaft mbH  
**J. Reichmann** Beckhauser Str. 16 C, 40699 Erkrath, Germany

### Abstract

The RESOB engineering company has developed a holistic concept for settlements that comprises energy saving, nutrient recycling and energy gain. Energy saving is done by optimized building physics, heat recovery and integrated measurement and control techniques. Energy is provided by a combined heat and power system with a dual fuel engine.

The regenerative fuels are biogas and wood gas. Wood gas is produced by gasifying wood and other biomass. Wood gas consists of 15 to 30% carbon monoxide, 10 to 20% hydrogen, 45 to 60% nitrogen and others.

Biogas is produced by decomposing organic material in absence of oxygen. It consists of about 60% methane and 40% carbon dioxide. In the biogas plant liquid manure, regenerated biomass and organic waste from households and human feces are co-fermented. The remaining substrate is a high-quality fertilizer distinguished by a high plant availability, and is, compared to liquid manure, nearly odorless.

The organic material of private households is collected by a vacuum system. Waste-water is separated into black-water collected from the vacuum toilet and grey-water merged from shower, bathtub, washing machine and others. The grey-water is purified in a reed bed plant.

Several advantages arise from this sanitation concept:

- 1) nutrients (N, P, K) remain in the nutrient cycle and do not pollute water resources.
- 2) Mineral fertilizer is saved and thus energy consumption is reduced.
- 3) Due to decentralization, expenses for drain systems is saved.
- 4) In a biogas plant, pathogenic germs are predominantly killed during the fermentation process. This reduces the risk of contamination with antibiotic resistant germs. Due to a high germ concentration in sewage plants, exchange of genetic information is likely to occur and thus other strains of bacteria may attain antibiotic resistance.
- 5) Biogas plants reduce the risk of hormone contamination of waters because these compounds are partly disrupted during fermentation.
- 6) A net production of energy is derived from the biogas plant. A household with low energy standard can cover 10 to 15% of its energy demand by its own organic waste.

This concept is of high economic profitability. Compared to conventional settlements money is saved by reduced energy consumption, enhanced energy efficiency and reduced fees for disposal of waste and waste-water.

## Introduction

The RESOB engineering company presents a holistic concept which combines sanitation and nutrient recycling with energy gain. This concept provides practical solutions for both environmental care and economy.

Up today, the flow of material in settlements such as communes, housing estates and business areas is linear. Waste-water is treated in sewage plants with a lot of energy involved to reduce the contamination of rivers and oceans. Organic waste is treated in composting plant also with energy consumption (Fig. 1). Such waste of material and energy does not have to happen and is economically extremely inefficient.

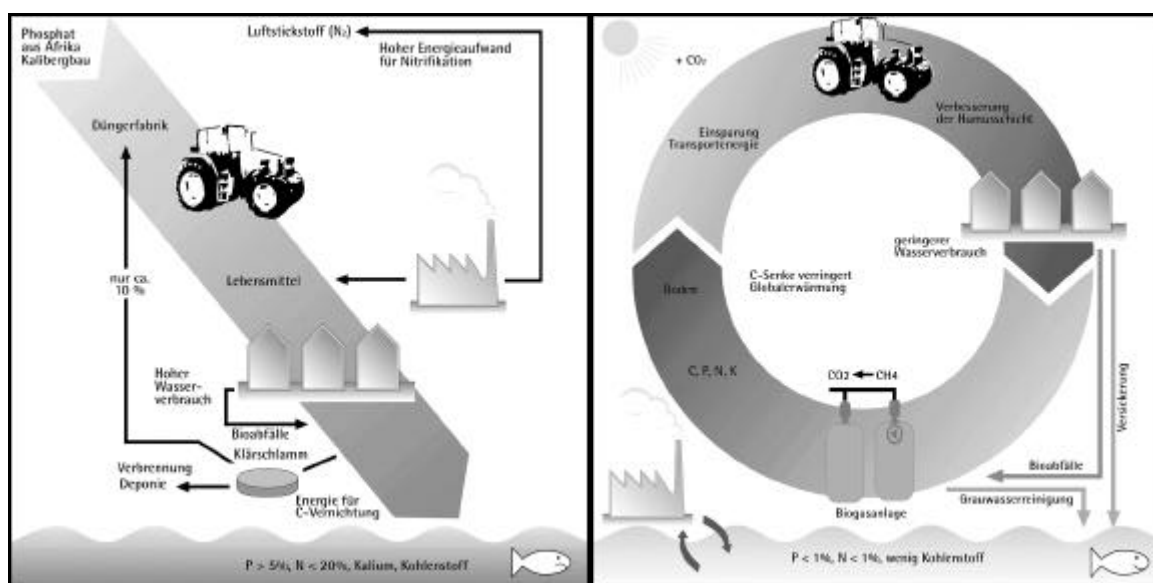

Fig. 1: End-of-pipe treatment

Fig. 2: Partial stream treatment

We want to demonstrate especially for the flow of organic material and for water, that a restoration of the natural cycle is possible (Fig. 2). There just won't be only a relief for the environment, but a saving of operation costs. Another important fact is that there is no loss of living comfort. Therefore the RESOB-concept considers nutrient recycling from waste-water and from organic waste by use of these biogenic materials as sources for energy gain. This is realized by fermentation in biogas plants. Moreover, woody debris is used for wood-gas production in a gasification plant. Both gases provide the fuel for decentralized combined heat and power plants.

## Saving of energy

Strategies for saving of energy deserve first priority to reduce energy consumption worldwide. Energy required for heating and cooling of buildings can be reduced to one third when the houses are built or redeveloped with low energy standard (Maier 1994). To save **thermal energy** the building physics is optimized by insulated walls and windows. Heat is recovered from waste-air and waste-water. Cold is provided by subterranean collectors or cold absorption.



To reduce **power consumption** energy saving household appliances are used and controlled by measurement and regulation techniques. By this means about 30% of the present power consumption can be saved.

### Efficient generation of energy

The remaining energy demand is provided by use of combined heat and power systems. The electrical and thermal efficiency is 35 to 40% and 50 to 55% respectively. The major advantage of decentralized combined heat and power systems is that heat is not a waste product like in conventional power plants.

This concept reduces both primary energy consumption and carbon dioxide emission by 70 to 75%. Fueled with regenerative energies the net emission of CO<sub>2</sub> will approximately decrease to zero. We use biogas and wood gas as regenerative fuels. Wood gas is derived from gasification of waste-wood and weak-wood. Biogas is produced in a biogas plant via disposal of biogenic waste.

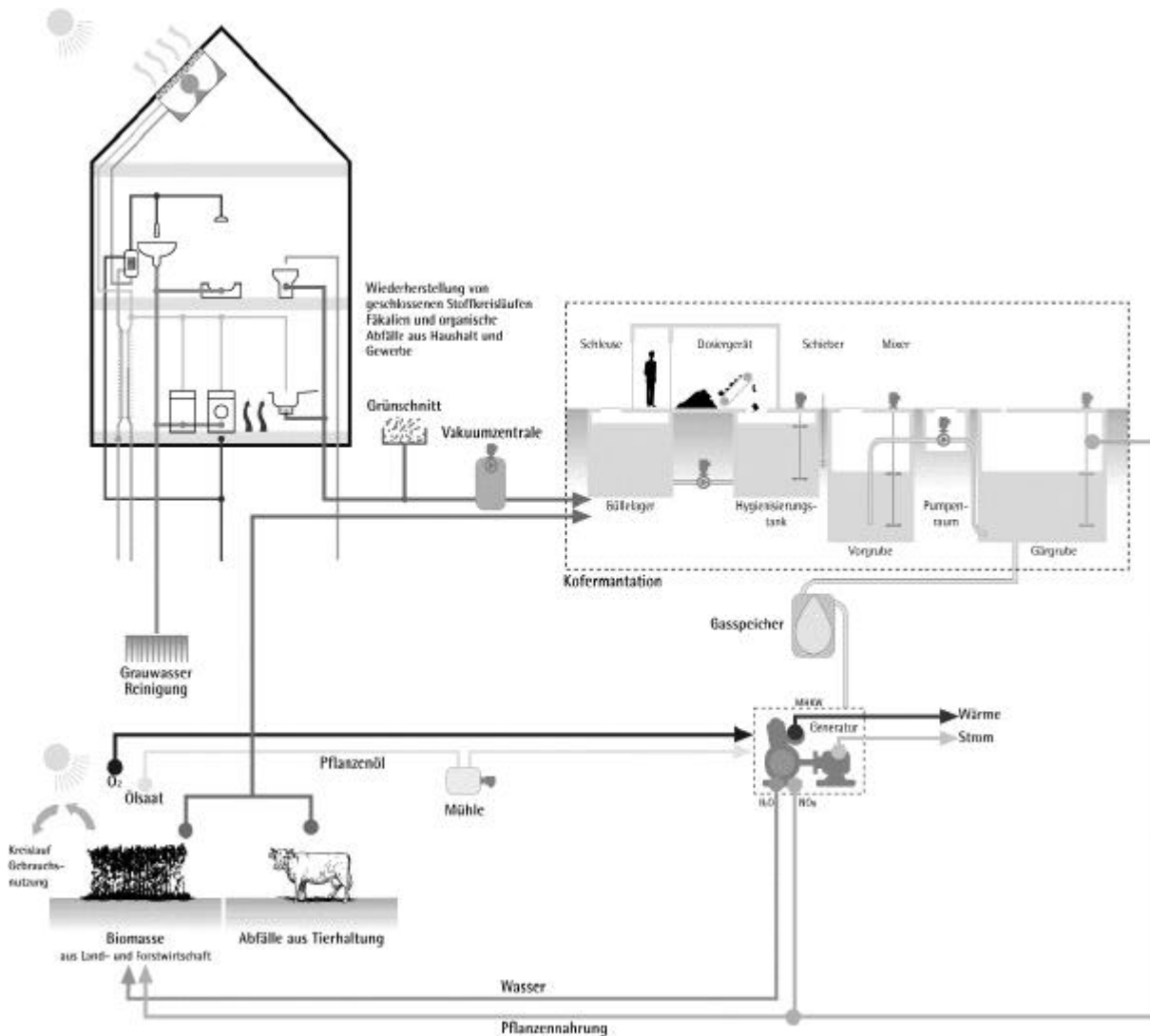

Fig. 3: RESOB cycling concept

### Cycles of nutrients, water and carbon dioxide

Waste-water is separated into black-water that contains feces and urine and grey-water merged from washstands, bathtubs, showers or washing machines. Black-water is collected from vacuum toilets or separating toilets. By use of vacuum toilets merely one liter of water per flush is necessary and thus drastically reduces consumption of drinking water.

In the biogas fermenter black-water is co-fermented with leftovers from the kitchen, grass and green cut, liquid manure and regenerated biomass. The resulting product of the fermentation process is a gas mixture which consists of 50 to 70% methane, 27 to 43% carbon dioxide and traces of sulfur dioxide, nitrogen, hydrogen and carbon monoxide. The substrate will remain in the fermenter for about 20 days at a temperature of 55 °C.

The remainder of the fermentation process is a valuable fertilizer which is ready for use in agriculture. This fluid substrate is homogeneous and is easy to distribute on the fields. The nutrient availability for plants is high and it is nearly odorless. Thus, nutrient cycling from soil to plants to food to waste to biogenic fertilizer is completed.

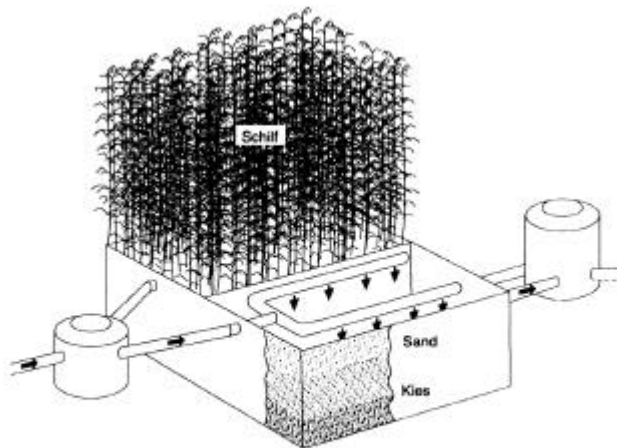

**Fig. 4: Reed bed plant**

The grey-water which contains only small amounts of pollutants is treated in a reed bed plant. It consists of layers of sand and gravel and is planted with reed (*Phragmites australis* (Cav.)), Fig. 4). The grey-water is vertically run through the basin by surge irrigation. The reed bed plant is a low-tech device and therefore doesn't need much service and has a low energy demand for maintenance.

**Table 1: Comparison of the outlet of a conventional sewage plant and a reed bed plant charged with grey-water per capita and year.**

		Conventional sewage plant	Grey-water purification in a reed bed plant
amount	[m <sup>3</sup> ]	73,0	25,6
CSB	[kg]	3,6	0,8
BSB <sub>5</sub>	[kg]	0,4	0,1
N <sub>ges</sub>	[kg]	0,73	0,2
P <sub>ges</sub>	[kg]	0,07	0,01
K	[kg]	1,7	< 0,4

**CSB = chemical oxygen demand,**

**BSB = biological oxygen demand**

Data from Otterwasser (pers. com.)

The outlet of the reed bed plant contains less pollutants than the conventional system (Tab. 1). Especially nitrogen is reduced to more than 25%. The purified water can seep away or can be used again as process water.

### **Economical and ecological advantages of a decentralized sanitation concept compared to sewage plants:**

- Fermentation of black-water in combination with decentralized grey-water purification makes expensive sewerage connections needless.
- Nutrients like nitrogen (N), phosphorous (P) and potassium (K) remain in the nutrient cycle and mineral fertilizer is substituted.
- Eutrophication of waters is avoided.
- Organic waste is used as energy source. Thus, fossil energy resources are saved and CO<sub>2</sub>-emission is reduced.
- Consumption of drinking water is drastically reduced by vacuum toilet systems.
- Pathogenic germs are predominantly eliminated during the fermentation process (Philipp and Kuhn 1998). Therefore the risk of contamination with pathogenic or antibiotic resistant germs is reduced. Due to a high germ concentration in sewage plants, exchange of genetic information is likely to occur and thus other strains of bacteria may attain antibiotic resistance. 1.5 Million antibiotic resistant germs leave the sewage plant per liter of purified water (Bundesumweltamt, Jahresbericht 1997).
- Contamination of waters with hormones from medicine or contraceptives is reduced. These compounds will be partly disrupted in the biogas plant because of the high temperature and the high microbial concentration. However, further studies are necessary to evaluate the efficacy of the microbial degradation.

- Emission of greenhouse gases like methane and laughing gas released from conventional sewage and composting plants is avoided.

**Energy balance and financing concept**

The energy balance of this sustainable sanitation concept is positive due to biogas utilization and the substitution of mineral fertilizer.

**Table 2: Energy gain from biogenic waste of households per capita and year.**

	Yearly fresh weight	organic dry weight	biogas produced <sup>b)</sup>	Primary energy
Feces and urine	510 kg <sup>a)</sup>	32 kg	18.3 m <sup>3</sup>	110 kWh
Organic waste kitchen	100 kg <sup>c)</sup>	29 kg	19.3 m <sup>3</sup>	116 kWh
Organic waste garden	50 kg	19 kg	12.7 m <sup>3</sup>	76 kWh
Sum				302 kWh

<sup>a)</sup>Schmidt and Thews 1998, <sup>b)</sup>Oechsner and Gosch 1998, <sup>c)</sup>Fricke et al. 1991

A low energy standard house has an annual overall energy demand of about 2500 kWh per capita. A considerable portion of 10 to 15% of this primary energy demand can be covered by biogenic waste. The difference can be produced in the biogas plant using 15 m<sup>3</sup> of liquid

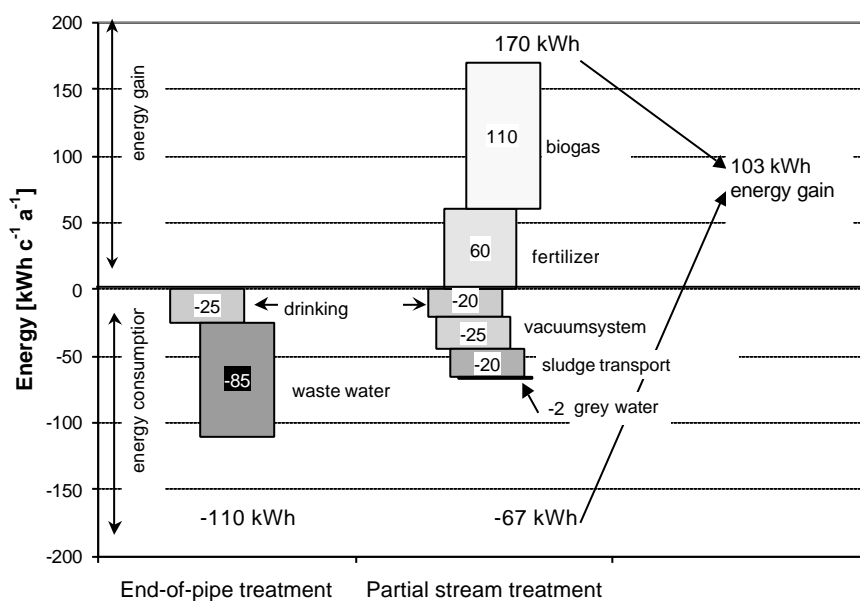

manure or 1.3 tons of regenerated biomass respectively.

**Fig. 5: Comparison of the energy demands of the conventional end-of-pipe treatment with the cycling concept.**

In the conventional system, energy is needed for both drinking water supply and waste-water treatment. In total there is an annual energy demand of 110 kWh per capita. On the contrary, the cycling concept provides an annual gross energy gain of 170 kWh per capita. The energy needed for the vacuum system, water pumps, drinking water supply and transportation of sludge adds up to 67 kWh per capita and year. Thus, the net energy gain of the cycling concept is 103 kWh per capita and year.

The RESOB financing concept is based on performance contracting. The contractor redevelops the house and supports the household with energy. The household pays a contracting rate to the contractor, which equals the costs of energy of the former conventional system. This means that the energy costs for the user are kept constant but the value of the building is raised due to the modern building physics standard.

### Transferability to developing countries

Developing countries have to cope with two major problems: shortage of drinking water and health hazards arising from a bad sanitation. Due to the enormous water consumption and contaminated output conventional sewage plant systems are economically and ecologically inappropriate to improve the sanitation infrastructure. Therefore sustainable solutions are necessary to cover the needs for sanitation of an increasing population of the near future.

Our sustainable concept is transferable to most countries, because the modular components can be selected and adopted to the specific socio-economical conditions with regard to climate, agriculture and environment.

### Literature

Bundesumweltamt, Jahresbericht 1997

Fricke K, Nießen H, Vogtmann H, Hangen H O, 1991, Die Bioabfallsammlung und –kompostierung in der Bundesrepublik Deutschland

Maier H, 1994, Der Energie-Berater: Handbuch für wirtschaftliche und umweltgerechte Energienutzung.- Köln: Dt. Wirtschaftsdienst. Fachdruck Deutscher Wirtschaftsdienst GmbH, Köln.

Oechsner H and Gosch A, 1998: Vergärbare Stoffe, KTBL Arbeitspapier 249. Pp17 – 28.

Philipp W, Kuhn E, 1998: Hygiene und Umweltaspekte, KTBL Arbeitspapier 249. Pp29 – 40.

Schmidt R F, Thews G, Lang F, 2000: Physiologie des Menschen, Springer Verlag Berlin Heidelberg, 891 p..

## Wastewater irrigation in the state of Victoria, Australia

**Dr. Percival Thomas**

Department of Environmental Management and Ecology  
La Trobe University  
Wodonga, Victoria 3690, Australia

### Introduction

Australia is considered as one of the driest continents on earth. Its scarce surface water resources such as rivers, reservoirs and lakes are valued for water supply, recreation and aquatic life in one hand and on the other hand many of the rivers are being loaded with treated wastewater discharges. However, since recently treated wastewater is increasingly being viewed as a valuable resource available for reuse especially in the irrigation sector rather than a waste requiring disposal to water bodies. In Australia both Federal and State Authorities have recognised the importance of minimising nutrient inputs to the surface water bodies and wastewater irrigation is identified as one of the alternatives to water based disposal systems. The practice of wastewater irrigation is not a new phenomenon and there is evidence to support this from a United States based research (Sopper, 1971). An Australian study was conducted in the early part of 1980's over a 4-year period to evaluate issues such as tree growth, biomass production, nutrient accumulation by the trees and changes in soil chemical properties (Stewart et al, 1988). There are a reasonable number of wastewater irrigation schemes already in place across Australia. The numbers are on the increase every year because many Water Authorities and City Councils have been urged to move from water-based disposal methods to land-based disposal methods to protect the water resources from the effects of sewage effluent discharges. In 1999, the estimated quantity of effluent produced in the State of Victoria was around 367 000 ML/year and 4.6% of this was reused. The balance was discharged to either rivers or oceans.

### Legal aspects and guidelines

In Victoria, current Acts, policies and regulations relevant to wastewater irrigation are administered by the Environment Protection Authority and associated Government agencies. Some of the Acts that are particularly important to wastewater irrigation are Environment Protection Act 1970, Health Act 1958 and Livestock Disease Control Act 1994. Pollution of groundwater and/or surface water, changes in soil characteristics, or risks to public and/or stock health may occur from poorly designed managed wastewater irrigation schemes. To minimise these threats from wastewater irrigation there are number of guidelines available, and in the State of Victoria, the Water Authorities and other agencies generally follow the local guidelines for wastewater reuse (EPA Victoria, 1996) and wastewater irrigation (EPA Victoria, 1991) established by the Environment Protection Authority of Victoria. These guidelines together with the guidelines from other States, and the draft Australian National Guidelines are more rigorous than what are followed in developing countries. Failure to comply with the guidelines may result in severe penalties that exist under the Environment Protection Act 1970 for the misuse of wastewater. The process to establish and manage a wastewater irrigation scheme initially involves a public consultation followed by preparing a legal contract between the wastewater provider and the purchaser. There have been extended delays to establish wastewater irrigation schemes in many areas due to legal issues, public objection or additional costs associated with

the requirements of the guidelines. The regular monitoring costs can be high depending on the nature of the irrigation scheme and the potential risks attached to it.

### Community opinion and consultation

One of the main deciding criteria for treated wastewater irrigation is the community acceptance which may depend on the difference between the cost of raw water and treated wastewater, level of public contact with the reclaimed water, and the quality of treatment given to the wastewater. In Victoria the cost of treated raw water varies between 0.35 –0.90 cents per kilolitre whereas treated wastewater is offered almost free. In this State the major objections for wastewater irrigation have come mainly from the rural towns whenever a new scheme is proposed.

### Roles and responsibilities of suppliers and users

The Draft National Guidelines for Sewerage Systems - Use of Reclaimed Water (Australian and New Zealand Environment and Conservation Council (ANZECC), 1996) and the Draft Environmental Management Guidelines for the Use of Reclaimed Water (EPA Victoria, 1999) specify the roles and responsibilities of the suppliers and users of reclaimed water. These roles and responsibilities are generally subject to a collective agreement between parties if there is more than one party involved in the reuse scheme. Some of the important issues that are considered in the agreement between the supplier and the user include: -

- definition of roles and responsibilities
- contract duration – term, conditions for termination
- financial arrangement
- ownership of facilities
- reclaimed water characteristics
- commencement of use
- responsibility for operation and maintenance
- nature of the reclaimed water use
- reliability of supply
- environmental management plan, and
- liabilities.

### Risks associated with wastewater irrigation

It is essential that the suppliers and users of wastewater irrigation schemes should be aware of the potential risks associated with the activity and should take every step to minimise or eliminate them. These risks could be generally identified as (EPA Victoria, 1999):

- environmental
- human and stock health

- produce safety, and
- legal.

The degree of risks stated above will depend on the nature of the irrigation scheme, whether it is urban or rural, size of the scheme, quality of treatment offered to the wastewater and the set up of an appropriate environmental management plan. Wastewater irrigation schemes that are appropriately designed and managed should prevent the issues relating to the risks such as: -

1. contamination of surface and groundwater, soil and air
2. health risk to public and agricultural animal health
3. unacceptable levels of microbial or chemical contamination of food produce, and
4. legal risks associated with the use of sewage effluent.

### Treated wastewater quality for irrigation

In Victoria, untreated and primary treated wastewaters are not generally recommended for irrigation. The minimum treatment required is the secondary treatment. Additional treatment processes beyond secondary treatment level are normally required where the risk to human or livestock exposure is high. The three classes of treated wastewater that are specified in the guidelines for wastewater reuse (EPA Victoria, 1996) are presented in Table 1.

**Table 1: Classes of wastewater showing quality and monitoring requirements**

Treatment	Water quality	Monitoring requirements
Class A (No restrictions on public access)	pH 6.5 – 8.0 BOD < 10 mg/L SS < 10 mg/L Turbidity ≤ 2 NTU E.coli < 1 org/100 mL Viruses < 2 in 50 L Parasites < 1 in 50 L Cl <sub>2</sub> residual > 1mg/L Nutrient, salinity and toxicant controls	pH - weekly BOD - weekly SS - weekly Turbidity - continuously E.coli - daily Viruses - twice yearly Parasites - twice yearly Cl <sub>2</sub> residual - continuously Nutrient, salinity and toxicant – regularly (weekly)
Class B (Limited restrictions apply)	pH 6.5- 8.0 BOD < 10 mg/L SS < 15 mg/L Turbidity < 2NTU E.coli < 10 org/100 mL Cl <sub>2</sub> residual > 1 mg/L Nutrient, salinity and toxicant controls	pH - weekly BOD - weekly SS - weekly Turbidity - continuous E. coli - weekly Cl <sub>2</sub> residual – daily Nutrient, salinity and toxicant – regularly (weekly)
Class C (Restricted access applies)	pH 6.5 - 8.0 BOD < 20 mg/L SS < 30 mg/L E.coli < 1000 org/100 mL Nutrient, salinity and toxicant controls	pH - monthly BOD - monthly SS – monthly E.coli – weekly Nutrient, salinity and toxicant – regularly.



The monitoring program listed in Table 1 is for a scheme using more than 1 ML/d of reclaimed water. Class A quality reclaimed water is normally recommended for urban usage such as irrigation of open spaces, parks and gardens, sports grounds, golf courses and for agricultural use where the water could come in contact with the food crops. Class B quality water is advised for reuse in pasture irrigation or some municipal uses whereas Class C quality is for horticultural purposes and some municipal uses with restricted public access and pasture irrigation schemes with no direct contact with milking animals or pigs. The degree of treatment given to wastewater depends on the locality of the irrigated site. A protected site with restricted access and controls may be managed with lower levels of treatment whereas a site, which is exposed to the public or livestock and with no safeguards, needs higher levels of treatment. It is vital to examine the proposed irrigation scheme thoroughly so that an appropriate environmental management plan could be developed to minimise or eliminate any potential risks associated with the scheme.

### Environmental Management Plan

The establishment of an Environmental Management Plan (EMP) is necessary for long-term sustainable wastewater irrigation. The plan should cover all aspects of the scheme, which pose a risk to the environment, human and livestock health, and provide a framework to assess the long-term sustainability of the scheme. The EMP should address a number of issues such as reclaimed water quality and quantity, winter storage, site controls, buffer distances, warning signs, application rates and timing, irrigation methods, ground water quality monitoring, salinity controls and soil testing. Although the monitoring requirements for quality of reclaimed water, groundwater and soil are usually based on the Guidelines for Wastewater Reuse (EPA Victoria, 1996) there are instances where slight modifications have been made to suit local site specific conditions. Many urban users of reclaimed water consider the regular monitoring costs as a financial burden in addition to the initial cost of infrastructure. The user is normally responsible for monitoring the quality of reclaimed water at the point of delivery and this could be around A\$15 000 per annum in addition to cost of groundwater quality monitoring and soil testing. For an average irrigation site with about six groundwater bores the cost will be of the order of A\$3000 in the first year for monitoring every 4 months and A\$2400 per annum afterwards for monitoring every 6 months. The cost of testing soil for degradation or contamination would be about A\$2000 every 2-3 years.

### Proposed wastewater irrigation at La Trobe University

La Trobe University in Wodonga uses a minimum of 15 ML/year of public water supply at a cost of 0.36 cents/kilolitre to irrigate around 5.5 ha of playing fields and landscaping and this translates to an annual cost of around A\$5400. In an effort to reduce this cost the University initiated a proposal to use treated wastewater for irrigation. At the same-time with the policy to change from river discharge of treated effluent to completely land-based disposal methods, the local water authority, 'North East Region Water Authority' persuaded the University to utilise their reclaimed water almost free of charge (A\$1/year) for irrigation instead of using treated raw water. The quality of treated wastewater offered to the University by the Water Authority is classified as being 'Class A'. To establish the wastewater irrigation scheme the University spent in the order of A\$100 000 on infrastructure including pumps, new irrigation systems, storage tank and pipelines. The terms of agreement between the two parties has gone through a process of severe scrutiny for almost two years by the solicitors of both parties. Since the volume of reclaimed water used will be less than 1 ML/d, and to irrigate only at nights with a reasonable control of public access during periods of irrigation, it would be acceptable to adopt

a slightly less frequent monitoring program than what is recommended by the EPA Victoria (1996). The proposed frequency of testing at the irrigation area of reclaimed water is summarised in Table 2 and this would result in a cost of around A\$8200 per year based on a maximum of 36 weeks of irrigation. The estimated cost of groundwater quality testing from 5 bores would be of the order of A\$3000 in the first year. In addition the soil testing will incur a cost of A\$2000 every 3 years. Thus it is clearly seen that operation and management of a wastewater irrigation scheme in an urban and sensitive area can be costly mainly because of regular monitoring requirements. However, La Trobe University will go ahead with the proposed wastewater irrigation scheme soon once the roles, responsibilities and liabilities of the provider and the user are adequately clarified in the terms of agreement.

**Table 2: Reclaimed water quality testing at La Trobe University**

Parameter	Frequency
pH	Monthly
BOD	Monthly
SS	Monthly
Turbidity	Daily
Chlorine residual	Daily
E.coli	Weekly
nutrients	Monthly

## Conclusions

1. Treated wastewater is an alternative source of water for irrigation where there is shortage of water from other sources.
2. Wastewater irrigation can be an effective environmentally sound activity to replace water-based effluent discharges.
3. At present cost per kilolitre of treated wastewater is cheaper than water from public water supply.
4. Capital costs and regular monitoring costs could make a wastewater irrigation scheme as an expensive operation.
5. Legal risk is considered as a major issue by many organisations to embark on a program of wastewater irrigation.
6. The practice of wastewater irrigation has some difficulties, which need to be cleared.

## References

- ANZECC (1996) Draft Guidelines for Sewerage Systems – Use of reclaimed water. Australian and New Zealand Environment and Conservation Council, Australia.
- EPA Victoria (1991) Guidelines for Wastewater Irrigation. EPA Publication No. 168, Melbourne, Australia.

- EPA Victoria (1996) Guidelines for Wastewater Reuse, Best Practice Environmental Management series. EPA Publication No. 464, Melbourne, Australia
- EPA Victoria (1999) Draft Environmental Guidelines for the Use of Reclaimed Water, Best Practice Management series, Melbourne, Australia.
- Sopper W.E. (1971) Disposal of municipal wastewater through forest irrigation. Journal of Environmental Pollution, 1, pp263-284.
- Stewart H.T.L., Hopkins p., Flinn D.W., Hillman T.J., and Collopy J. (1988) Evaluation of irrigated tree crops for land disposal of municipal effluent at Wodonga, Technical Report No. 7, Albury-Wodonga Development Corporation, Australia.

## Auroville 2001 – a town dependent on its rain and wastewater

**Harald Kraft**

Ingenieurbüro Kraft  
Schmiljanstraße 7, 12161 Berlin, Germany

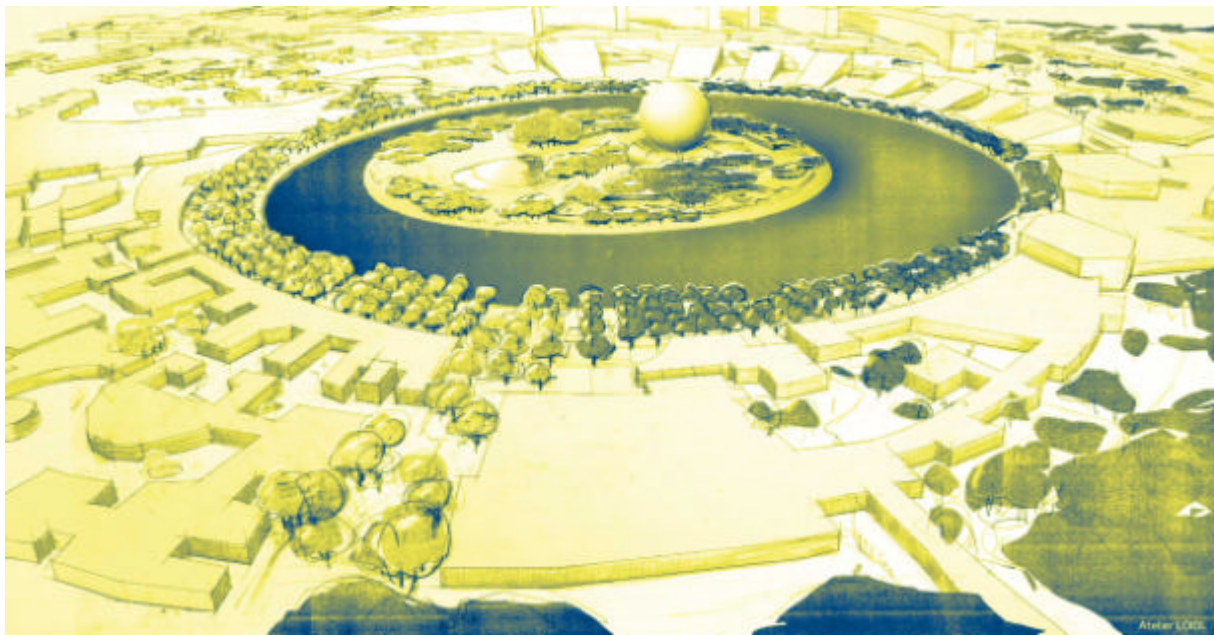

### 1. Introduction

#### The City of Auroville

Auroville was founded as an international township of 50.000 inhabitants. The official inauguration took place on February 28<sup>th</sup>, 1968, with a formal ceremony around the urn into which earth from 124 countries was placed as a symbol of human unity.

The project received unanimous endorsement at the General Conference of UNESCO in 1966, 1968, 1970 and 1983.

The city of Auroville is planned to cover a circular area with a diameter of 2,5 km, and to be surrounded by a 1,25 km-wide greenbelt of forest and farmland. The city is to be comprised of four zones: Cultural, International, Industrial, and Residential. Parks and green corridors are to be included within all of the zones.

The township was established on a plateau with a maximum elevation of 52 m above sea level. It lies both in the eastern coastal part of the South Arcot district of Tamil Nadu and in the North Union Territory of Pondicherry.

The geographical centre of the township is located 5 km from the coast of the Andaman Sea. The location is surrounded by 20 villages with an approximate total population of 35.000 inhabitants.

The closest city is Pondicherry, located a distance of 12 km from Auroville. The capital of Tamil Nadu, Chennai (Madras), is located approximately 200 km to the north.

In 1968, the land was a vast dry open expanse of red earth, scarred by a network of gullies and ravines carved out over the years by territorial monsoon rains, as a result of 200 years deforestation and bad land management practices.

The main focus of the settlers in Auroville has been to stop the process of erosion, the loss of top soil, and the storm water runoff. Soil and water conservation programs, as well as extensive reforestation efforts, have enabled the completion of the first phase of land regeneration.

## 2. The water management concept

### 2.1 The vision

A solitary banyan tree stands on a low barren hill of red laterite, about 60 m above the sea which lies 5 km to the east. This tree is to become the centre of the city. Buildings will spiral outwards from it in the form of a galaxy, surrounded by a belt of dense tropical forest. Vegetation will extend inwards again to the centre between the arms of the spiral, acting as the 'green lungs' for the city.

On the crown of the hill will be gardens, surrounded by a large lake. Within the gardens, an amphitheatre, a large spherical building, and the ancient banyan tree will mark the centre of the city, which is meant one day to accommodate 50,000 inhabitants.

### 2.2 The problem

At the inauguration the hill was barren. Only a few palmyras had survived the centuries of deforestation. During the monsoon season, the sea was dyed blood red with eroded earth. The rains have carved two canyons, 20 m deep and 100 m wide in places, from the crown of the hill down to the sea. Only a very small portion of the rainwater that falls on the plateau remains in the ground, which allows for only two meagre harvests per year.

The water table lies 30 m below the compacted surface, where it can only be tapped in small quantities, and even that is difficult. A layer of red laterite covers the entire hill and slopes gradually towards the sea. Under it lies strata of limestone, through which the groundwater flows out from within the soil. Adequate aquifers are found only at 100 m and 200-300 m depths.

### 2.3 The groundwork

City life will become possible on this site only if the area can once more be made fit for human habitation.

The first step in this process is to protect the ground. The annual loss of soil and water can only be halted by creating "bunds", banks and dykes which slow down and divert runoff, and by terracing and strengthening of canyon walls. These measures must be undertaken throughout the entire city.

The second step is to cover the surface with a layer of vegetation that will hold the soil together, as well as open it up so it can absorb the rainwater that falls on it.

The third step is to reforest the entire area. Pioneer plants which survive in extreme conditions will be planted first, followed by plants which recover the subtropical rainforest.

Over the last thirty years, this process of regenerating topsoil, retaining rainwater to restore the groundwater table, and modifying the micro-climate by providing shade, moisture and protection from wind and rain, has gradually brought the land back to life. The diversity of insect, bird, and animal species, has consistently increased, further supporting the process of renewal.

#### 2.4 Water supply: the conventional solution

Drinking water for the city could be conventionally supplied by one or two central pumping stations, drawing groundwater from the aquifers at depths of 100 to 300 m. In this scenario, however, a large lake at the highest point of the city may not serve as a practical solution since it would have to be filled with groundwater drawn from great depths, which would require a lot of energy and be very expensive.

To cover the other water needs of the city and its surrounding agricultural areas, a separate irrigation system supplied by deep bore wells would have to be established.

The city receives an average annual rainfall of 1200 mm, occurring within two rainy seasons, during which extreme downpours of up to 300 mm in 24 hours are not uncommon. Runoff could be channelled into the canyons, and sewage could be collected in a conventional drainage system, purified in a conventional sewage plant, and carried away through the canyons to the sea.

#### 2.5 The water demand

The city is situated near the coastline, where the ground water flows into the sea. All of the other users with access to the aquifers at 100 - 300 m depth have already been taking what they need. With powerful pumps, at subsidised electricity rates, agricultural users in the surrounding area, even the narrow strip directly along the coast, are removing groundwater to cultivate crops at a very high rate. In addition, a rapidly expanding industrial sector is making extravagant demands on the precious water supply.

The first signs of salt water intrusion into the aquifers in Pondicherry, in and near Auroville, are already evident. South of the city, many square kilometres of coastal land have become infertile due to salination.

Providing for the water needs of the city and its surrounding agricultural areas by desalinating sea-water is technically possible, but too costly to be affordable by the residents.

Salination of the groundwater will mean the end of the city.

#### 2.6 The alternative solution

Even in drought years, precipitation over the city area corresponds to more than ten times the amount of drinking water needed. But the rainy season lasts only a few months. Collecting and storing all this rainwater would require huge tanks that would not only be expensive to construct, but would require a lot of space.

However, one needs to reflect on the vision and try to view the apparent disadvantages of the site as potentially useful to the city. The upper layer of relatively impermeable laterite, together

with the uppermost aquifer, form the entire plateau on which the city stands, and both slope gently towards the sea. Therefore, all of the water that percolates within the city area moves gradually above sea level towards the coast.

Now, instead of the terrain and soil being seen as a disadvantage for the city, they become blessings. The groundwater is prevented from flowing downwards or towards the sea too quickly. Although the rate of infiltration through the surface is slow, the best place for surface water to infiltrate in order to increase the groundwater supply is at the highest point, the centre of the city. From this point of view, a large lake can be seen as the ideal technical solution to this problem.

Rainwater falling on roofs can be collected in cisterns and used for drinking water and various household and gardening purposes.

The surface runoff from roads, tiled surfaces, and open areas, can be collected and stored in reservoirs within the greenbelt up to the boundaries of the city. After filtration, the stored rainwater can be slowly pumped up into the central lake, a distance of no more than 20-30 m, by means of solar energy. From here, percolation into the groundwater table will take place. In this manner, the water level of the lake will be kept constant, providing optimal conditions for high quality landscaping and park areas, along with desirable climatic effects.

Sewage from the densely developed areas can be centrally purified in the greenbelt, and then be re-used for irrigation purposes. Sewage, as well as secondary runoff if necessary, from the less densely developed areas can be purified in root-zone treatment plants and reused on site for irrigation.

In this way, the geological and geographical "disadvantages" of the city's site, make a regime of rainwater conservation possible which would provide a plentiful water supply for both drinking and irrigation, even if the underlying groundwater becomes completely salinated. The average rainfall is not only sufficient enough to support a vigorous tropical vegetation, but would provide enough surplus to supply the surrounding areas. However, this will be successful only if the residents of the city protect the first aquifer from contamination.

The upper strata of earth beneath the city functions as a reservoir, and must therefore be protected. Drinking water can be obtained from wells in the greenbelt which tap the groundwater before it flows beyond the city limits towards the sea.

The extreme degradation of life's basic elements through over exploitation of this area's natural resources, has threatened the existence of human settlements. This water management concept enables the residents of the city to live unaffected in the midst of a degraded environment, so long as they, themselves, avoid polluting the ground and the water which together form the basis for their survival.

### **3. The feasibility of the water management concept**

#### **3.1 Safe water yield from precipitation**

The precipitation over the urban area is, on the average, enough to cover the drinking water demand for the city (145 %). Only in a dry year is it possible that the water demand may not be completely satisfied (- 22%). It is therefore necessary that all precipitation, which exceeds the long term average, be completely used for recharging the groundwater.

### 3.2 Safe water yield from sewage

To cover the water demand for drinking and irrigation, urban sewage is to be completely fed back into the water cycle. The sewage is treated to the extent that it can be reused for irrigation (3,28 M m<sup>3</sup>/yr.).

### 3.3 Water balance

On the long-range average, the surplus available for groundwater recharge amounts to 0,64 M m<sup>3</sup>/yr. In a year with above average precipitation, the surplus water amounts to 1,85 M m<sup>3</sup>/yr. In a dry year, however, the water supply for the city falls short up to 0,58 M m<sup>3</sup>/yr.

### 3.4 Drinking water supply

The drinking water demand for 50.000 inhabitants amounts to 3,65 M m<sup>3</sup>/yr.

The runoff from rooftops, with 1,23 km<sup>2</sup> surface area, amounts to between 0,77 – 2,10 M m<sup>3</sup>/yr., or 1,44 M m<sup>3</sup>/yr. on average. All of the runoff is to be stored in cisterns, from where it is either directly used to subsidise drinking water or conveyed to the central infiltration facility. The specific cistern volumes would need to be at least 800 l/m<sup>2</sup> roof area, or better yet, 1.200 l/m<sup>2</sup> roof area.

The total volume of all the cisterns in the city then amounts to 0,984 M m<sup>3</sup> - 1,476 M m<sup>3</sup>.

Approximately 40 % of the drinking water demand could be satisfied from water stored in the cisterns. The remaining 60 % can be satisfied with the surface runoff from the streets, open areas and green areas. This runoff amounts to 2,70 – 5,60 M m<sup>3</sup>/yr., or 3,84 M m<sup>3</sup>/a on the average.

The surface runoff is intercepted by water courses within the greenbelt and then delivered to the city centre for groundwater recharge. From the central groundwater recharge facility, the groundwater needs a flow time of about 1 to 5 years to reach the city limits.

From the recharged 1<sup>st</sup> aquifer, 60 % of the drinking water demand can be drawn from 30 – 50 m deep wells which are distributed throughout the entire greenbelt.

### 3.5 Sewage disposal

In decentralised facilities located in the upper rim of the greenbelt, urban sewage (2,74 M m<sup>3</sup>/yr.) is to be biologically treated, purified, and be made available for irrigation in the agricultural areas.

### 3.6 Central infiltration facility

The surface runoff within the city limits is to be completely used for groundwater recharge.

The most appropriate location for the infiltration facility is the city centre, since from here, the flow path to the edge of city is maximised. The garden around the Matrimandir is, from a hygienic standpoint, by far the preferred location for the groundwater recharge facilities.

Infiltration trenches along the most important routes would total in length to about 2.150 m. The maximum daily infiltration capacity amounts to approximately 74.000 m<sup>3</sup>/d. The required infiltration capacity depends on the allocated storage volume for the surface runoff in the greenbelt.



In an average year, the maximum infiltration capacity during the NE monsoon amounts to approximately 20.000 m<sup>3</sup>/d, and during an above average NE monsoon, approximately 38.800 m<sup>3</sup>/d.

### 3.7 Storage volume in the greenbelt

The surface runoff from the city and the greenbelt is intercepted at the fringes of the city in water courses and continually transported to the city centre for infiltration.

The size of the water courses determines the size of the required daily infiltration capacity, as well as the size of the treatment plant and the retention time in the central lake. The larger the water courses, the smaller the remaining facilities can be dimensioned.

The retention of the runoff towards the east is not a problem since only a few downstream water rights exist. More problematic is the retention of the flows towards the west and north since there exist old water rights for which compensation needs to be made.

With a storage volume of 1,033 M m<sup>3</sup>, a precipitation of up to 350 mm can be stored.

The minimum required infiltration capacity would then be 33.600 m<sup>3</sup>/d, and the retention time in the central lake would be 41 days.

When the storage volume is 3,983 Mm<sup>3</sup>, the discharge to the central lake can be reduced to only 13.300 m<sup>3</sup>/d due to the equalisation of the flows. The inlet filters would need only to be 3.000 m<sup>2</sup>, and the average retention time would be 104 days.

### 3.8 Central lake at the Matrimandir

With a central lake of 181.000 m<sup>2</sup> surface area, and a maximum depth of 10 m, the average depth would be 7,60 m, and the storage volume would be 1.376.000 m<sup>3</sup>.

The minimum retention time, with a maximum capacity of 34.400 m<sup>3</sup>/d, would be approximately 40 days.

The surface area of the lake sealant is 185.800 m<sup>2</sup>. The loss due to infiltration through the clay seal (vacuum sealed natural clay) amounts to approximately 15.450 m<sup>3</sup>/yr.

The loss due to evaporation amounts to approximately 54.300 m<sup>3</sup>/yr. on the average.

The retention time in the central lake should be several months since the lake will be used for natural treatment of the surface water.

### 3.9 Filters

The polluted surface water stored in the greenbelt is to undergo extensive treatment before conveyance to the central lake. For this purpose, large capacity slow sand filters are planned.

From all of the storage facilities within the greenbelt, the retained surface runoff is to be continually passed through the inlet filter before entering the central lake.

The inlet to the lake is to be designed so that an optimal distribution of inflow results and no disruption to the flow can develop.

The outlet occurs as overflow through inlet structures of various depths located on the other side of the lake from the intake point to maximise flow times.

The outflow is to be cleaned from algae and other filterable materials before it reaches the infiltration trench by means of an outlet filter, which is planned as a rapid filter.

### 3.10 Power requirement for the conveyance of surface runoff

From the water courses in the greenbelt, the surface water is to be conveyed by means of pressure conduits to the filter at the central lake.

With an average vertical rise of 25 m, and an annual output of 2,07 – 5,6 M m<sup>3</sup>/yr., the power requirement amounts to 277.423 kWh/yr. – 750.517 kWh/yr.

## 4. The background of the water management concept

### 4.1 Introduction

All elements of the water management concept for the city of Auroville have already been implemented in various pilot projects and/or conventional development projects in or near Berlin, Germany. The success of these Berlin projects has been noted by the residents in Auroville, and the technologies of storm water harvesting and waste water treatment and reuse seen here have been adopted for a number of projects in the town.

### 4.2 Wastewater treatment and reuse

#### 4.2.1 Project Broendbystraße 40, Berlin-Lichterfelde

In 1985, the Berlin project “Ökohaus Broendbystraße 40” implemented, among other ecological technologies, a system of storm water harvesting and waste water treatment by means of a clivus multrum compost toilet (for toilet and organic household waste) and a root zone treatment plant for the grey water (10 PE). The treated effluent is reused for irrigation and the balance is discharged into an open water course. This system continues to be successfully operated today with very satisfactory results.

#### 4.2.2 Project Hamburg-Allermöhe

The same system has been implemented in an ecological housing project in “Hamburg-Allermöhe,” where the root zone treatment plant was designed for a 125 population equivalent.

#### 4.2.3 Project IBA Block 6, Berlin-Kreuzberg

Within the framework of the Internationale Bauausstellung (International Housing Exhibition), Berlin 1987, a pilot project in the area of experimental housing and town planning, with a strong ecological emphasis, was to be implemented in Block 6 under the auspices of the Federal Ministry of Regional Policy, Building and Urban Construction (Bundesministerium für Raumordnung, Bauwesen und Städtebau).

The objective of this demonstration project is maximum conservation of water resources through measures of reducing the drinking water consumption and environmental pollution caused by waste water.

The project is located between Bernauer Straße and Dessauer Straße, next to the Potsdamer Platz and Brandenburg Gate, in the centre of the city.

The following programmes were set up for the new construction of Block 6, comprised of 106 apartments including a connecting inner courtyard with an area of approximately 12.000 m<sup>2</sup>:

- a) Reduction of water consumption through water-saving sanitary technology, as well as,

- b) through the re-usage of treated sewage water for toilet flushing (drinking water substitution).
- c) Reduction in energy consumption through heat recovery from the sewage.
- d) Reduction in storm water run-off from roof tops through the construction of grass roof covers and re-usage of this water after filtration in a plant filter.
- e) Purification of domestic sewage either completely or excluding toilet discharge in a decentralised root zone sewage treatment plant (for 200 PE).
- f) Loading of treated sewage with storm water discharge into ground water recharge plant.
- g) Integration of root zone treatment plant with rain water pond into the local recreation grounds by means of an aspiring programme of landscaping.
- h) Reduction in garbage accumulation by establishing separate rubbish collection systems in individual households and the creation of decomposition and recycling facilities.

For the treatment of sewage, the following facilities were designed:

- an Imhoff (septic) tank for preliminary treatment
- a root zone treatment plant for biological treatment, and
- a polishing pond for the final treatment.

The domestic sewage of 73 apartments in this pilot project is transported from a collector pit outside the building into the Imhoff tank by a communicator. The remaining apartments are directly connected to the public sewerage.

The treatment plant is also a place of interest for many visitors from the neighbourhood, being within easy reach by a favourable footpath system. The bridges, the pond and the paths within the treatment plant are an attraction for the children who come to play. The hill formed by the Imhoff tank is used as a lawn or as a playground. The benches next to the rain water pond are used very frequently.

Research on the performance of the treatment plant has shown a reduction in the pollution load to below the standards of bathing water quality (of the EC), as well as successful reuse of the effluent for irrigation and toilet flushing.

This project has received an award from the President of the Federal Republic of Germany in a national competition.

#### 4.2.4 Project IBA Block 103, Berlin-Kreuzberg

In this project various conventional treatment technologies like trickling filter and rotating biological contactors have been implemented to treat parts of the grey water stream for its reuse in toilet flushing. The treatment system has been operated successfully, however the facilities in the basement of the buildings have various problems that need to be corrected, so that the further application is not advisable at this time.

### 4.3 Storm water harvesting and reuse

#### 4.3.1 Project Berliner Straße 88, Berlin-Zehlendorf

In 1992 the construction of project Berliner Straße 88 was begun. The storm water from 160 housing units is collected in three cisterns making up a total storage capacity of 650 m<sup>3</sup>. The water is then reused for irrigation. The runoff is discharge into an artificial water course and a storm water pond of 1000 m<sup>2</sup>. The pond water is recycled through the water course by solar and

wind energy and continuously cleaned in a root zone treatment plant. The excess water is infiltrated through ground water recharge units. No storm water leaves the premises.

#### 4.3.2 Project “Schweriner Hof” Berlin-Hellersdorf

This project was recognised as an exemplary model of an ecological project in the Habitat II Conference in Istanbul in 1996. The storm water runoff from the roofs is stored in a 600 m<sup>3</sup> cistern and reused for irrigation and for the regulation of a rain water pond.

The external water, as well as the surface runoff, is infiltrated through an infiltration trench system into the ground, which was actually declared to be unfit for infiltration.

#### 4.3.3 Project “Landsberger Tor” Berlin-Marzahn

In this large project (30 ha, 1.800 units), the storm water runoff from the roofs is infiltrated into an infiltration trench system. The storm water runoff from the roads is collected in a conventional storm water drain and discharged into a storm water treatment and infiltration facility, located in a public park. The facility consists of a separate unit for mechanical treatment, a rain water lake, and a root zone treatment plant for the biological treatment. The outflow is infiltrated through ditches. The total surface area of the facility is 5.000 m<sup>2</sup>.

The project concept and design is the outcome of an international competition.

#### 4.3.4 Project Teltow-Mühlendorf

This project area is 29 ha, comprising 1.800 housing units.

##### 4.3.4.1 Terrain modelling

This newly developed concept assumes that all of the storm water and the necessary excavation is to stay on the project site. Using the displaced earth (250 000 m<sup>3</sup>), the terrain has been modelled so that the surface water can be diverted to a centrally located pond, resulting in a rise of about 1 m in the ground level in the centre of the project. A considerable environmental stress has been prevented by not hauling away the excavated earth, which would have require approx. 25 000 truck loads.

##### 4.3.4.2 Storm water disposal for traffic ways

The major goal of this design is to minimise the interference of the natural water regime within the project area. In spite of the high percentage of paved and otherwise sealed areas, the precipitation remains within the boundaries of the project. The storm water runoff from sidewalks, bicycle paths, parking lanes, pedestrian walkways, green areas and playgrounds is conveyed to the subsoil through local infiltration. The runoff from the streets is intercepted in lateral gutters and conveyed to three storm water purification facilities and, after being extensively biologically treated, fed to a central storm water pond. Surplus storm water is infiltrated when complete filling of the pond forces water over the edge into infiltration trenches located in the banks. The overflow is also biologically treated prior to the infiltration in vegetated filters.

##### 4.3.4.3 Storm water disposal on residential lots

The precipitation from all rooftops is stored in cisterns and from there made available to the residents to be used as non-potable (raw) water and for potable water substitution. The surplus water is to be led to infiltration trenches. The pond water will be circulated through four natural-looking channels (flowing brooks), which run through the residential areas. The resulting cooling effect on the immediate surroundings, as well as the enhancement of the living conditions through simultaneous aeration of the pond, are the primary goals of the design concept.

## 4.3.4.4 Summary of technical data

Catchment Area	A [in ha]	Precipitation* [in m <sup>3</sup> /yr.]	Project Data	Quantity Unit
Size of Project Area (approx.):	27,9	163.634	Inhabitants:	3.000
Area covered by streets	5,8	33.841	Living units	1.850
including:			Infiltration trench length (not including bank of pond)	9.000 m
bicycle paths and sidewalks	1,9	10.909	public	6.000 m
street greenery	0,7	3.812	private	3.000 m
public streets	3,8	22.404	Cistern volume	4.500 m <sup>3</sup>
private streets	2,0	11.437	Non-potable water capacity	290 m <sup>3</sup> /h
Roof area	4,5	26.393	Volume of lake	23.000 m <sup>3</sup>
Open areas (public parks)	1,6	9.091	Surface area of lake	8.600 m <sup>2</sup>
Open areas (private)	16,1	94.309	Capacity of infiltration facilities	10.000 m <sup>3</sup> /h

\*...average year

## 4.3.5 Project “Environmental Technology Park in Brandenburg”

In this 76 ha project (34 ha built-up), the entire storm water runoff is proposed to be collected, treated and reused as a substitute for drinking water used in recreation, irrigation, toilet flushing, washing machines and still further uses where drinking water quality is not required. The excess water is infiltrated to recharge the ground water.

It is proposed that the waste water be treated in a treatment plant on site applying the most modern technology (membrane technology) and that root zone treatment technology be used for polishing and sludge stabilisation. The effluent will be reused for irrigation and the establishment of valuable wet lands within the project area. The excess waste water is infiltrated to recharge the ground water.

The basic aim here is that all of the storm water and waste water be infiltrated within the project area.

## 5. Conclusion

Present day municipal sanitary supply and disposal in Germany has been controlled for years by powerful interest groups that up to now have allowed the application of alternative systems only in storm water disposal. The model projects of the 1980's demonstrated many alternatives, but none have ever been further developed.

An alternative ecological supply and disposal system offers possibilities particularly in new residential areas, contributing to a considerable improvement in the quality of life and to a reduction in costs. Such a new and unusual venture would, however, require expressed public interest and strong support especially throughout the permit acquisition process.

Germany needs free and open competition for new ideas, as well as close co-operation between urban planning, sanitary planning, transportation and energy planning, landscape planning and architecture prior to the drawing up of development plans. Furthermore, we once again need model projects geared towards experimental housing and town planning. We must resume the quest for ideal residential housing, for the ideal city.



## Results of Parallel Session 5 presented at the plenary

"What are the means for realistic and sustainable planning methods?"

1. Dissemination of knowledge/information
  - good examples/model projects/exhibition
  - economic information
  
2. Planning process
  - decentralized and including all stakeholders from the start
  - build-in flexibility (technical development)
  - allow mix of technologies
  
3. Linkages and terminology: positive: pointing to possibilities not threats
  - resources      ↔      waste
  - nutrients      ↔      shit
  
4. Regulatory framework
  - legal: to be more flexible
  - pricing; lifecycle cost as a complement to investment
  - performance based vs prescription based





## Minutes of Parallel Session 5 <sup>1</sup>

### 1. Dr. Percival Thomas, La Trobe University, Australia: “Wastewater irrigation in the state of Victoria, Australia”

The major reasons for using purified wastewater instead of fresh water for irrigation in Australia are to minimize wastewater discharges to riverbeds, to minimize the extraction of water from limited water resources, and to make use of the nutrients in the wastewater.

The legislature of the Australian State of Victoria has classified treated wastewater for irrigation into 3 classes according to use. (Class A without any restrictions, Class B with certain restrictions and Class C for restricted use only). For each class, the conditions are strictly limited to reduce risks for health, for food contamination, for soil contamination, and for the environment. An additional important issue in Australia is to avoid legal liabilities.

Dr. Thomas explained that in many cases the use of wastewater for irrigation is very costly. The purified wastewater is generally free of charge, but monitoring is expensive. According to legal requirements and in the intention of avoiding legal liabilities, regular tests of the used water, soil tests and groundwater tests have to be carried out. The cost of monitoring is quite often higher than the cost of using fresh water for irrigation.

The discussion centered mainly on how to overcome mental inertia with regard to the use of wastewater for irrigation. It was proposed that more pilot projects and pilot studies be carried out. If purified wastewater is regarded as a resource instead of as a threat, the requirements for bureaucratic monitoring can be reduced.

### 2. Dr. Jan-Olof Drangert, Linköping University, Sweden: “A national PhD program for developing future sanitation systems in Sweden”

In Sweden, nearly all homes have mains connections for the supply of water and the disposal of wastewater. However, there is a sense that these are not sustainable. The degree of sustainability of various scenarios for future water systems has to be studied and discussed. To initiate that process, a national 5-year program on Sustainable Urban Water Management was launched in 1999 involving 15 PhD students. The goal of this multi-disciplinary program is to identify scenarios for sustainable urban water management. The following areas are investigated for sustainability criteria:

- health, hygiene, comfort
- social and cultural aspects
- environment and natural resources
- economy
- technical functions

Scenarios to be discussed include improved conventional systems as well as more visionary systems. These may be high-tech or low-tech and trying to include forefront advances in

<sup>1</sup> Minutes taken by Reinhard Meierjohann and Jan-Olof Drangert

technology, natural and social sciences. In the initial phase of the program, the main task was to dismantle current mind sets and commence with a "delearning process". The students were given the demanding assignment to develop a pipeless city. The goal of overcoming mental inertia was achieved within the 15-student team, and they found out that sustainable alternative systems may have more but shorter pipes.

### **3. Dr. Katharina Backes, Consultant, Germany "Urban and rural sanitation concept with nutrient recycling and energy gain"**

A holistic concept for urban and rural sanitation with nutrient recycling and energy gain was presented. The concept is designed for neighborhood-scale introduction – not for single homes.

The concept is based on the following principles:

- the buildings are well-insulated
- biogas and wood gas serve as fuel for the supply of power and heat
- vacuum toilets with urine diversion are used
- excreta are treated in a biogas fermenter
- the residue is put to use as agricultural fertilizer
- greywater is purified in reed beds and recycled

The main advantages of the system include a 30 % reduction in energy demand, very low water consumption, recycling of all nutrients, and preventing antibiotic viruses from escaping the system.

Dr. Backes recommended that such systems be built and operated by private contractors.

### **4. Harald Kraft, Consultant, Germany: "Auroville 2001 – a town dependent on it's rain and wastewater"**

A project was presented for a new city of 50,000 near Madras, India. Since all fresh water used for irrigation in the past was derived from groundwater, the new city will only be viable if the aquifer can be recharged by infiltration of storm water. Hence, that problem was a crucial planning issue for the new city. It was demonstrated that facilities for stormwater recharge can be integrated into the town planning process without threat to the city's general harmony.

Mr. Kraft also presented some implemented examples of stormwater use in Germany. The projects in question were recently carried out in the Greater Berlin Area. Photos of the projects illustrated the intelligent integration of ponds into the urban landscape such as to enhance the areas' character.

The planners had to overcome mental inertia on the part of city officials. Though Germany no longer presents any legal obstacles for the use of rainwater, city officials still often try to avoid it. Mr. Kraft also established the fact that the use of rainwater is usually uneconomical. He also found that some customers harbor negative views, so a range of choices must be offered to potential users.

## 5. Post-presentation discussion

The discussion focused mainly on the question of how to overcome mental inertia. The first necessity is to implement a large number of pilot projects for the purpose of informing and convincing the stakeholders. It is also crucial to involve future users in the planning process as quickly as possible.

The key issue “How to overcome mental inertia in the w&s sector” was discussed in depth by the session's participants.

That key issue was broken down into four sub-issues:

- how to deal with the long time frames involved
- how to open up choices for decision
- how to stimulate and support the involvement of all stakeholders
- how to improve the planning process

The following conclusions were drawn:

1. Dissemination of information/knowledge is necessary with regard to:
  - good examples/models/projects (exhibition recommended)
  - economic information
  - education
2. The planning process must be updated, i.e.:
  - decentralized and designed to include all stakeholders from the very beginning
  - have built-in flexibility
  - allow a mix of technologies
3. It is also necessary to consider linkages and terminologies:
  - potentials (nutrients and resources) – as opposed to threats (waste) – should be emphasized
4. The regulatory framework must be updated, i.e.:
  - legal systems made more flexible
  - pricing and life-cycle costs regarded as complementary to investment
  - performance-based principles replaced by prescription-based principles.



## List of participants

Backes	Katharina	Germany	RESOB-Ingenieurgesellschaft
Brüll	Anja	Germany	IEES, OICOS e.V.
Correa	Nestor	Germany	Consultant
Doetinchem	Jürgen	Germany	KfW
Dorgeloh	Elmar	Germany	PIA-RWTH Aachen
Drangert	Jan-Olof	Sweden	Linköping University
Enders	Reiner	Germany	Technische Universität Berlin
Herbst	Heinrich	Germany	ISA-RWTH Aachen
Hiessl	Harald	Germany	Fraunhofer-Institut
Kerpen	Jutta	Germany	Consultant
Kraft	Harald	Germany	Ingenieurbüro Kraft
Martin	Nicola	Germany	Federal Institute for Geoscience and Natural Resources
Meierjohann	Reinhard	Germany	Consultant
Sperling	Frank	Germany	Emschergenossenschaft / Lippeverband
Steinfeld	Carol	USA	Center for Ecological Pollution Prevention
Stracke	Rainer	Germany	Prof. Dr. Dr. K.-U. Rudolph GmbH
Swetzer	Alexandra	Switzerland	Consultant
Thomas	Percival	Australia	La Trobe University
Vasudevan	N.	India	Anna University
Welschhof	Jürgen	Germany	KfW
Wendland	Arnd	Germany	Hamburger Stadtentwässerung
Züst	Brigitta	Schweiz	Center for Applied Ecology Schattweid



## 4 Annex





## Additional papers

For organisational reasons the following presentations could not be given during the conference and are published in this place instead.

**Health implications of reusing dehydrated faecal matter**

Aussie Austin (CSIR, South Africa)

**ECOSAN – the recycling sanitation system**

Gunder Edström and Almaz Terrefe (Sudea, Ethiopia)

**Valuable use of urine, faeces, household waste and some greywater**

Gunder Edström and Almaz Terrefe (Sudea, Ethiopia)

**Ecosan as one element of advance towards an ecological urban planning**

Hans-Joachim Hermann (GTZ, Germany)

**Faecal contamination of a fish culture farm where hospital wastewater grown duckweeds are used as fish feed**

Dr. Md. Sirajul Islam (ICDDR, Bangladesh)

**Potential of Reed Beds (Constructed Wetlands) for Sustainable Wastewater Treatment in Residences and Industry**

Dr.-Ing. Margarita Winter (Base Tech, Germany)

**Sustainable wastewater treatment with soil filters**

Brigitta Züst (Center for Applied Ecology, Switzerland)



## Health implications of reusing dehydrated faecal matter: discussion of microbiological tests carried out on samples from some urine diversion toilets in South Africa

**Aussie Austin**

CSIR Building and Construction Technology  
P O Box 395, Pretoria0001, South Africa

### Introduction and background

Ecological sanitation, making use of urine diversion technology, implies reuse of the sanitation products (excreta), for example in agriculture, food gardens, etc. It is therefore essential to ensure that the products are safe to handle and work with, particularly in poor communities where most of the work is carried out by hand. Urine is generally considered safe for use as fertiliser if it is not contaminated with faecal matter. If it is contaminated, six months storage in sealed containers is likely to render it safe.

However, it is not always so easy to ensure that faecal material is made safe for handling or use in food gardens. Composting is a well-established practice that usually results in stabilisation of the material. Conversely, it is known that dehydration does not necessarily have the same effect, and upon rehydration the faecal material may once again show pathogenic activity. It was thus considered important to carry out some tests in an attempt to establish whether a problem does indeed exist, and if so, to quantify the magnitude of the problem.

CSIR Building and Construction Technology (Boutek) implemented a urine diversion sanitation project in the Eastern Cape Province about two years ago. The project has been running successfully and the technology is well accepted by the communities involved. For cultural reasons, the communities have so far not expressed a willingness to reuse the sanitation products – the urine is led into soakpits and the dehydrated faeces are disposed of in the maize fields, where they are simply thrown onto the ground and not intentionally worked into the soil. As it is hoped to gradually introduce the idea of reusing the sanitation products in the communities' vegetable gardens, it was decided to use these particular toilet units for the proposed testing programme.

The communities use ash from cooking fires to sprinkle on their faeces after defecation. As wood ash had a pH value of about 10.5, it was considered to be an excellent material for this purpose (a pH of above 9 is usually highly unfavourable for most pathogens). The ash is also very successful in eliminating odours and controlling flies.

### Tests conducted

The microbiological testing programme included tests for the following parameters:

- Total coliforms: indicate decay of rotten organic matter.
- Faecal coliforms: also indicative of decaying faecal matter, these include pathogenic bacteria.
- Faecal streptococci: also indicative of decaying faecal matter, but more resistant to unfavourable environmental conditions.

- Salmonella: a bacterium present in faecal matter and the causative agent of salmonellosis, a severe type of gastro-enteritis.
- Clostridia: a spore-forming organism which is very resistant to unfavourable environmental conditions, and the causative agent of severe food poisoning.

The above tests were initially carried out on various samples of faecal material at intervals up to 10 months after initial defecation and covering with ash. Care was taken that the mixture was not contaminated with fresh faecal matter. Thereafter further tests were conducted as described below.

### Summary of results

There was a noticeable variance between the results from different toilet units. It was thought that the quantity of ash added in each case contributed to this. Although a definite downward trend in the bacteriological counts was exhibited, some values were still substantial after the ten-month period had expired. Examples were as follows (values are per gram of material):

- Total coliforms:  $10^2 - 10^6$
- Faecal coliforms:  $10^2 - 10^6$
- Faecal streptococci:  $10^2 - 10^5$
- Salmonella: Too high to count
- Clostridia: Too high to count

After this period a single sample of the desiccated faeces was sun-dried for a further period of six weeks. The moisture content was then determined to be 1.4%. This sample was again subjected to the same tests, with the following results (per gram of material):

- Total coliforms:  $10^4$
- Faecal coliforms:  $10^2$
- Faecal streptococci:  $10^5$
- Salmonella: Too high to count
- Clostridia: Too high to count

The sun-dried sample was then stored at room temperature for a further twelve months, after which it was once more subjected to the same tests. The results were as follows (per gram of material):

- Total coliforms: 0
- Faecal coliforms: 0
- Faecal streptococci:  $10^3 - 10^4$
- Salmonella: Negative
- Clostridia:  $10^2$

The sample was thereafter rehydrated with sterile water and re-tested after 6 days, with the following results (per gram of material):

- Total coliforms:  $10^3 - 10^5$

- Faecal coliforms:  $10^3$
- Faecal streptococci:  $10^4 - 10^5$
- Salmonella: Negative
- Clostridia: Positive (< 100)

## Discussion

The vast resistance of faecal streptococci towards unfavourable environmental conditions is evident. It is also seen that if the dehydrated faeces are rehydrated, dominant bacteria become viable again and multiply under the more favourable conditions.

It is recognized that these tests were performed under optimum laboratory conditions, and that different results might have been obtained in the field. Proper drainage of the water, UV radiation by the sun, colder night conditions, other micro-flora interaction, etc, might have created environmental conditions less favourable for proliferation of the microbes.

It is nevertheless clear that a measure of uncertainty still exists regarding the possible health risk of reusing dehydrated faecal matter in food gardens, particularly root crops such as carrots, radishes, etc, that are consumed raw. This danger may be overcome by proper education of people regarding the importance of washing hands after working/planting/harvesting in soil enriched with dehydrated faeces, not to eat, drink or smoke while performing these tasks, and to wash vegetables thoroughly. However, these habits are extremely difficult to instil in poor, rural people who have to walk long distances to fetch water just for drinking and cooking.

Further research is required in order to find easy ways of making the dehydrated faecal matter safer for reuse in food gardens. Boutek is currently preparing to conduct such research during the course of this year. Guidelines will be prepared based on the results of the research project.

## ECOSAN – the recycling sanitation system

**Almaz Terrefe /  
Gunder Edström**

SUDEA  
P. O. Box 31673, Addis Abeba, Ethiopia  
Tel. +251-1 611344  
Fax +251-1 557106  
sudea@telecom.net.et

### Introduction

The Society for Urban Development in East Africa (SUDEA) is a volunteer organisation based in Sweden. A branch of SUDEA is registered in Ethiopia and among other things has introduced ECOSAN, the Economical, Ecological Sanitation System. The project was started in 1996 and is the first of its kind in Africa. ECOSAN emphasises the recycling of human excreta and all bio-degradable household refuse as a pre-requisite for sustainability. The project aims to test the sustainability of ECOSAN in the context of present-day urban as well as rural Ethiopia.

Most simply, the basis of ECOSAN is the integration of the non-mixing of excreta and urine in a dry toilet. It includes urban or household agriculture, the recycling of human excreta, as well as house hold refuse management. It includes solar energy usage in the house hold, training in nutritional values and diversification of foods. The integration of the above five moments is referred to as an eco-cycle.

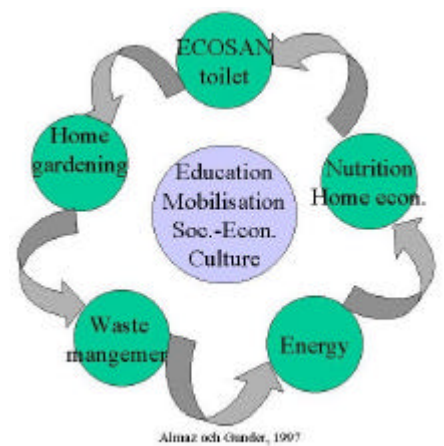

Almaz och Chander, 1997

### ECOSAN - the concept of integrated sanitation

By ECOSAN we in SUDEA mean a non-mixing sanitation system which enables the recycling of human waste. In the process, some wastewater and all organic household wastes are composted and turned into fertiliser and soil conditioner. The process of recycling human and household waste does not pollute the environment or misuse any other natural resource. While introducing the ECOSAN system, community participation, cultural sensitivity, cost-benefit effectiveness and behavioural change are essential.

SUDEA has developed these systems for both rural and urban areas in Ethiopia by combining different parts of successful sanitation and agricultural systems from different parts of the world and adapting them to the context of present-day Ethiopia. Professionals from Ethiopia and Sweden have combined existing systems with locally developed models to produce a system which is economically cost effective, hygienically safe, ecologically sound and technically simple. The name, Economical, Ecological Sanitation – ECOSAN – springs from a very specific concept in which the recycling of human excreta in particular and household refuse in general are pre-requisites.

One of the basic elements is the toilet that enables the separate handling of urine and faeces in a safe and clean way. The urine is collected in a urinal and led through a pipe into a special container. The faeces are also collected in a separate container and are thereafter mixed with ashes, soil, leaves, grass, sawdust or any other suitable material available before composting. By not mixing the urine - "the natural fertiliser" - with faeces, which contains most of the pathogens, the bad smell generally associated with latrines is very much reduced. This also means that the treatment of the two ingredients can be done in a proper way - urine to the fields as fertiliser and faeces to compost under control to minimise the effects of pathogens and intestinal parasites.

### Cultural aspects

The introduction of human excreta as fertiliser and soil conditioner is complex. Attaining positive results depend upon an integrated multidisciplinary approach. Most farmers in Ethiopia know that faeces of both animals and human beings are a good input to agriculture. But the technique of composting human faeces to make it safe for agricultural use is less known. When it comes to urine there is a hesitation. The knowledge of the high fertilising value of urine is low. There is however a risk that the issue of using human excreta for edible vegetation will be trivialised into something everybody discusses, where some people try to ridicule the effort without sufficient knowledge to enrich the subject. When we reach the primary beneficiaries the acceptance is easy if the introduction is done in a respectful manner. The dialogue with the latter enriches and stimulates our knowledge in the technical and cultural modification.

One important factor for a success is a clear and simple introduction of the technology and the mobilisation of the community in order to encourage behavioural change.

### Hygiene and sanitation aspects

What we see and learn about today is the great variety of existing sanitation techniques and the traditional view of waste. Most common is disposal, actual getting rid of human excreta, dirty water and other household refuse. Instead, our Ethiopian pilot project has laid great emphasis on human excreta, not as matter to be disposed of but as a resource to be *managed* and *recycled over time*. In the ECOSAN system, recycling of biodegradable substances is an important process which can increase household food security with no future risk. If there is no disposal, the contamination of shallow or ground water is controlled at source and the spread of diseases is minimised. All safety aspects related to processing or using the products as fertiliser and soil conditioner are integrated before introducing the system. But an important part of introducing the process is that the people who are responsible are trained for the purpose.

Although urine-diverting toilets were invented more than 100 years ago and have been in use for such a long time, and also human excreta recycled in many countries, nowhere have we found an integrated, ecologically sound economically cost benefit effective and hygienically safe approach that has been researched, evaluated and documented. In some projects which use urine diverting toilets, the emphasis is particularly on the usage of the toilet and not on recycling the excreta. In countries where human excreta as a fertiliser is well known and used, safety aspects of the technology are not sufficient in our opinion. Learning from others and including our findings, we recommend that the recycling of human excreta and household refuse should be encouraged only if the cleanness and safety of the final product are tested and proven through a properly conducted and well-documented pilot project before dissemination of the technology at large.



The pilot project in Ethiopia has been collaborating with universities and relevant authorities both in Ethiopia and in Sweden. We have been doing this since 1993 with regard to the integration of the different parts of the system. There is an ongoing consultation through personal communication and e-mail exchanges with the relevant researchers. Reading and discussing the results of other research, the support of the advisory group, and follow up of the ongoing pilot project in Ethiopia have also been very useful.

### **Community participation and gender balance**

The ECOSAN system in Ethiopia emphasises capacity building and training of partners. These are national NGOs, Kebeles (local administrative authorities) and individual families where women are actively participating.

The training takes place stepwise; first, introduction of the system, followed by reflection and modification, building and upkeep of the toilet, involvement in urban or household agriculture, and learning the re-cycling process, where a time interval is required for each process.

### **Results and conclusions**

The ECOSAN system activates the whole family to be creative and to help each other. So far, we have found that it is the women in the families who most enjoy following the process of both recycling and composting. In most cases men are out doing other types of work. For the follow up, SUDEA has trained personnel to handle the different parts of the system. These personnel are there to give advice and support the exchange of knowledge according to the needs of the family. Support for capacity building and follow up are essential during the introduction period. Thus far, however, the composting of human excreta, which requires more thorough knowledge, has been carried out by trained people from SUDEA while family members are actively involved. The composting process of faeces comes one year after starting using the toilet and only once a year. This has shown that the learning process of composting human excreta takes 2-3 years. The usage of urine is learned within 1-2 months. Test results have shown a 3- to 4-fold increase on home gardening vegetables.

The ECOSAN system recycling process is done in stages, in a system of shared responsibility. It is a clean and cost-effective approach. One of the activities that does demand time is what we call urban agriculture in cities and home gardening in rural areas. But since the ECOSAN system produces food, fodder or flowers for the family, it helps to stimulate their economy. And the time of the of the women which would otherwise be consumed in going to the market can be more profitably used in agricultural activities. This is a blessing in the rural household where the market is far from home.

In Gilgel Gibe, one of the rural areas where we have introduced the use of urine as fertiliser and encouraged the planting of leafy vegetables, we found that the urine was used to produce maize rather than in the kitchen garden. The farmers in that area expressed the need for more urine to use as fertiliser.

## Valuable use of urine, faeces, household waste and some grey water or ECOSAN – ecology, economy, sanitation

**Almaz Terrefe /**

SUDEA

**Gunder Edström**

P. O. Box 31673, Addis Abeba, Ethiopia

Tel. +251-1 611344

Fax +251-1 557106

sudea@telecom.net.et

### Introduction

Every household produces a wide variety of waste or refuse as we prefer to call it. People normally think of it as matter to be thrown away. But all of the organic waste from kitchen or garden as well as human waste – faeces and urine – are biodegradable and useful. They are easily turned into fertilisers. These substances are and should be seen as a resource! But for the whole process we need to include some or most of the waste water. Just be sure there is no water closet involved!

Organic fertilisers like urine and faecal compost can be utilised in place of inorganic fertilisers. Organic fertilisers are required in large quantities to supply the same amount of fertiliser nutrients found in small quantities of chemical fertilisers. But the availability of urine and faecal compost, the lack of need for foreign exchange and reduced toxicity to the soil are indeed ample merits.

Pest and disease control is carried out by utilising such natural pesticides as pyrethrum, onion, garlic, tobacco, Neem trees, etc. The use of biological control will assist in the creation of a garden capable of producing “organic” food, free from chemical pesticides and fertilisers reported to pollute the environment and to have negative health effects.

### Scope

SUDEA in January 1996 started introducing the ECOSAN (Economy, Ecology and Sanitation) system as a pilot project in Ethiopia. By ECOSAN we in SUDEA mean a non-mixing toilet system which enables the recycling of human refuse. In the process, some wastewater and all organic household waste are also composted and turned into something useful and valuable. The process of recycling human and household waste does not pollute the environment or misuse any other natural resource. While introducing the ECOSAN system, community participation, cultural sensitivity, cost-benefit effectiveness and behavioural change are essential. The aim of the project was to test the sustainability of ECOSAN as adjusted to the Ethiopian reality. So far, we have constructed and now manage some 180 units in different parts of Ethiopia, mostly urban and peri-urban areas but also one project area in a rural resettlement area.

**ECOSAN is:**

- **Simple** to construct, use and repair, which makes it
- **Replicable** in most communities
- **Affordable** even by resource-deprived communities since
- **Saves water** such as the toilet and gardening system
- **Locally available materials** are used for production and the system is
- **Cost-benefit effective** which will benefit the people using it.

**Methodology****Refuse collection**

We start in the kitchen where we have at least two buckets for sorting the kitchen refuse. One is used for all organic household waste such as peelings, shells, left-over food and some waste water like old coffee or tea. This is composted together with such garden refuse as cut grass, old flowers, leaves, ashes, hedge clippings, etc. To the compost we also add dried faeces from our non-mixing ECOSAN toilet from where the urine is collected separately in jerricans. Water for both watering the compost and the vegetables is if possible harvested rainwater, not for drinking.

**Eco-Lily**

An advice we offer, also to those who already have water closets, is to use a device we have named Eco-Lily. The idea of Eco-Lily comes from the "Desert-Lily" used by soldiers during World War II to dispose urine. If you want to save water all you need to do is equip your toilet with a twenty-litre jerry can with a large funnel. In this you can collect urine and save water.

**Composting**

This is the very important process whereby faeces, organic refuse, some urine and water are converted into fertiliser/soil conditioner that is safe to handle. We have experimented with many different types of composts. In our last composting effort, we managed to reach a temperature of 50° C and then keep the temperature at over 45° C for at least one week.

Composting should be done close to the ECOSAN toilet and during the dry and warm season. After about one month, the compost is safe to handle. Some say that the compost should be turned after 3-4 weeks, but we have not found it necessary for this compost with faeces. We recommend that the compost is left unturned for 3-4 months before it is used for agricultural purposes.

**Home gardening**

For every household where we are asked to introduce ECOSAN, we also look for and discuss the possibilities and willingness to have a garden in the compound or close to the home. We are introducing different techniques but we found the two following as most efficient and easy to adopt. Both have been redeveloped to fit into the ECOSAN concept. The two systems are the

challenging trials we are conducting in our pilot project. They are adjusted to use human excreta and household refuse as the main source for fertiliser and soil conditioner.

### ECO-baskets

ECO-baskets is a version of Basket Gardening or FAITH (Food Always In The Home) gardening. This is a technique that allows the refuse to be utilised easily. It is a compost gardening technique requiring very little work. While it composts the waste it produces food and creates good compost for other parts of the garden.

#### Advantages of ECO-baskets

- Requires a minimal space – only 15 m<sup>2</sup>, which should be found in most compounds
- Yield is higher than conventional gardening methods
- Water saving since it conserves moisture like the ECO-sandwich (see below) – water is injected through pipes for less evaporation – but also since it utilises the waste water from the kitchen and urine
- Family labour can be used because the technique is simple and easy to learn.

### ECO-sandwich

ECO-sandwich is a method that is known under several different names – bio-intensive gardening, double digging, raised bed method, bio-dynamic French intensive gardening among them. We refer to it as ECO-sandwich.

#### Advantages of ECO-sandwich

- Requires relatively little space. It is believed that an area of size 40m<sup>2</sup> can supply a family of five with its vegetable requirements for a year
- Yield on ECO-sandwich plots is 3-4 times higher per square meter than with conventional gardening methods. This is as a result of healthy plant root growth on well aerated and watered soil
- Conserves moisture through the micro-climate created between plants. It requires only one-half to one-third of the water required by the conventional garden, as a result of precision planting on a triangular basis whereby different plant leaves touch each other prohibiting moisture evaporation. The depth of the BIG plot is double as deep as the conventional plot which improves the water retaining capacity and makes the roots of the plants spread downwards instead of horizontally
- Suppresses weeds: The leaf canopy described above also prevents sunlight from penetrating, thus inhibiting weed growth and saving water
- Requires only family labour: One ideal BIG plot 9m<sup>2</sup> (6 x 1.5m) on its 1<sup>st</sup> double dig will require 10 man hours. Second and subsequent yearly digs will need only 4-6 hours. The routine management, seeding, weeding, watering, harvesting, etc. demands a mere 15 minutes a day of a single person. Four such plots of land will demand no more labour than can be supplied by a single family.

## Test area

SUDEA has an area specially prepared for testing the growth of vegetables and fruits fertilised with human refuse. Some tests have been conducted with drip irrigation to control the amount of urine and water given to the plants. Other tests have been conducted to see the result of SUDEAs “urine-in-soil-deposition” technique.

## Results and conclusions

Today a farmer or household head find it very expensive to buy fertilisers. Most families in Ethiopia have no or very little access to fertilisers. Tests on the ECOSAN system have shown a 4-to 10-fold increase of bio-mass of leafy plants in ECO-sandwiches compared to non fertilised conventional beds.

The same results are shown in ECO-baskets with the ECOSAN approach. Here tests are more complex to perform since there are varied plants growing in a small area at the same time.

But our experience and tests have shown the value of the ECOSAN concept:

The collection and use of urine and composted faeces and organic household refuse as fertilisers and soil conditioner in a home garden, including some waste water and collected rain water, increases food security at the household level.

The value of these natural fertilisers and soil conditioners collected and prepared at home in the course one year is about 500 Birr (60 US\$). The cost for preparing a complete ECOSAN system is about the same. This means that the pay-back time for an ECOSAN is only one year.

## **Ecosan as one element of advance towards an ecological urban planning**

**Hans-Joachim Hermann** Deutsche Gesellschaft für  
Technische Zusammenarbeit (GTZ) GmbH  
Postfach 5180, 65726 Eschborn, Germany

### **Bringing cities closer to natural cycles means not less than reversing a millenary trend**

Have a look on what archaeologists discovered of cities in Mesopotamia, Egypt and Mexico and feel how mankind already fivethousand years ago had no other desire than to keep as distant as possible from virgin landscape and from raw materials extraction, processing and recycling. And, socioeconomic stratification was clearly linked to this criterion: the deeper one's hands stuck in what nature offers, the lower status and income were in general. Little has changed since then. Anti-urban discourses always were of those who were in the condition to pay an urban way of life in the country-side, and the gardener, too. Viewed from this point, „ecosan“, and a lot of similar innovation, will not have any chance of becoming a standard urban technology. It's no use by declaring that it would be very helpful in reducing the ecological footprint. But, what at all would be of use to build and run cities in an ecologically sound way?

To make a breach in the phalanx of human vainness, concrete (building) industry and disposal business (this, too, in recent times increasingly viewed as a shareholder issue) a broad coalition of interests has to be brought together. This is totally normal whenever complex technological structures are to be changed as a whole. And there is no way out of a comprehensive technological break-through unless we would content ourselves with dry-toilets in some remote hamlets or weekend-houses.

### **What could there be elements of a broad coalition in favor of an ecological urban planning and management?**

Rich people are normally not too much interested in ecological and social issues because of their tendency toward amenity sites far from pysicaly and socially critical points (spatial or socioeconomic segregation). A significantly lowc crime-rate, on the other hand, is what can work against the exacerbation of social segregation and corresponding urban flight of better-offs and enterprises. And this is of very much interest to the municipal authorities who do not wish to see their home base stigmatized as „unlivable“. Middle class people, for their part, are more than rich ones interested in an ecologically sound environment since they cannot escape that easily from pollution (and crime naturally) and they are interested in lowering the urban infrastructure costs which during the last decades have been one of the strongest inflation factors in the cost of living indexes all around the urbanized world. As to the poor, they do not just cherish a special sympathy for ecological issues. But, when desemployed for a longer time, they take a lively interest in recycling works if there is some secure income to earn without that phenomena of over-exploitation one can observe where there is no regulatory public sector intervention in informal recycling activities. And this lively interest will be still stronger if employment or micro-entrepreneurship in supply, disposal and recycling activities is linked to a better access to land and other natural resources as water, wood and vegetables.

To a large extent, these constellation of interests is already well-known as well as are a lot of technological innovations or socioeconomically appropriated low-cost solutions. But what seldom is attempted is putting these innovations in connection with the urban design and management discussion. Concerning relationship between the latter,

„...it is quite clear how to save the money at the design stage, and quite difficult to save it in the operating budget if inefficient systems are already in place. Put another way, bad decisions made at the planning stage will continually make budget decisions more difficult and constrain spending, owing to the „penalty“ in waste exacted by those bad decisions.“ (Robert C. Einsweiler, Deborah Miness; Lincoln Institute of Land Policy, 1994).

Livability for all (nearly without segregation), and its consequences for an ecological urban planning and management

If a considerable part of the urban poor are to be engaged in managing material flow cycles, running appropriated infrastructure and supplying cities by their own resources, then it is necessary to give them enough space/land and to organize settlements in a way to maximize the urban fringe as a membrane for materials exchange and filtering between built and open space environment. Obviously, this concept is contrary to the medieval and nearly metaphysically sharp borderline between town and wilderness, still glorified in some neo-romantic urbanist discourses, but just as little this filtering and recycling fringe is an apologia in favor of urban sprawl.

The two-dimensional projection of these ideas delivers a network of urban settlements or something similar to the central localities hierarchy completed by a network of ecological systems. In three dimensions we can analyze the materials flow: import of products, energy, water, services and so on is done following the watershed lines where roads, avenues and supply trunk lines are situated and take advantage of the hill-top location. Materials flow through processing and consumption follows slope and, earlier or later, runs into the aquatic ecosystem. Fortunately, the traditional division of labor between white, blue, and now, green collars (recycling workers) can be projected onto this two- or three-dimensional urban ecospace without demanding any type of social or cultural revolution. Let's have a look on the design outcome first (schematic diagram) and then discuss the related urban management issues.

Fig. 1: Urban fringe as an ecomembrane between urban and ecosystem networks (regional level)

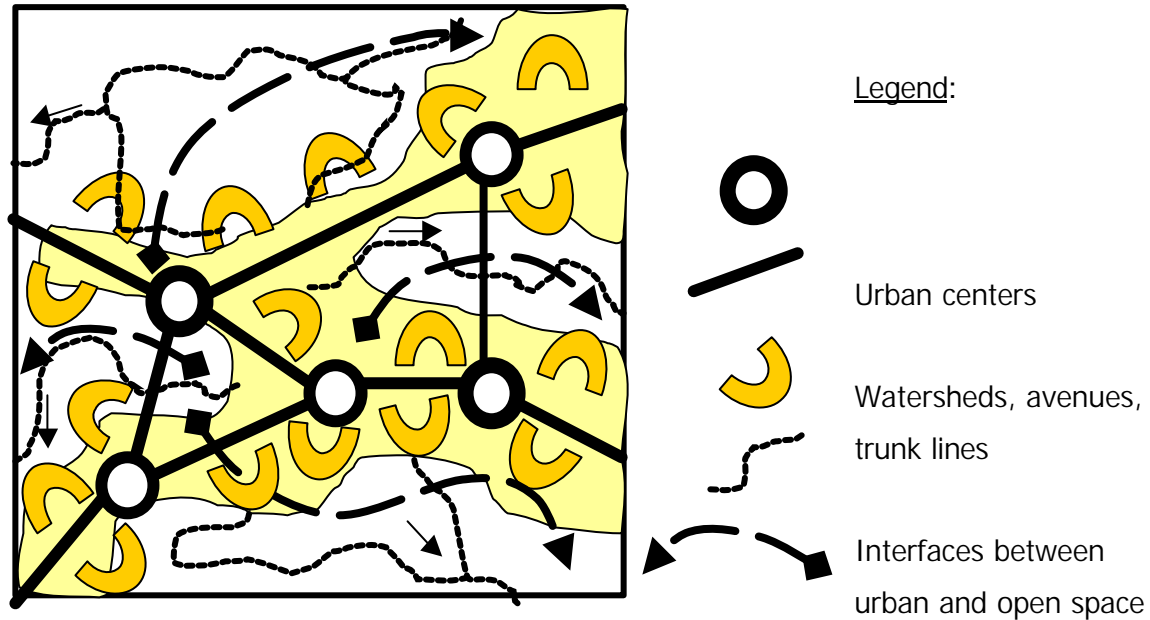

Fig. 2: Slope of terrain and types of settlements

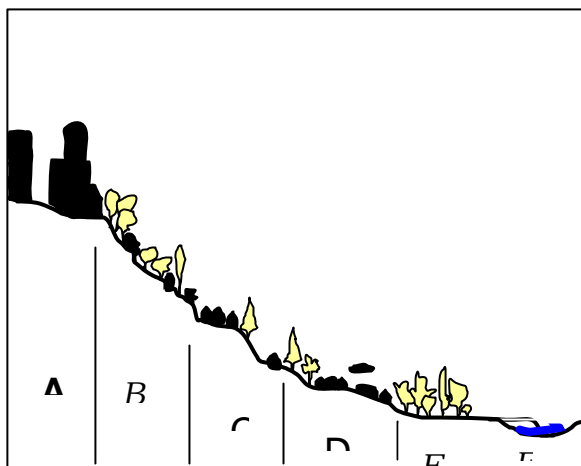
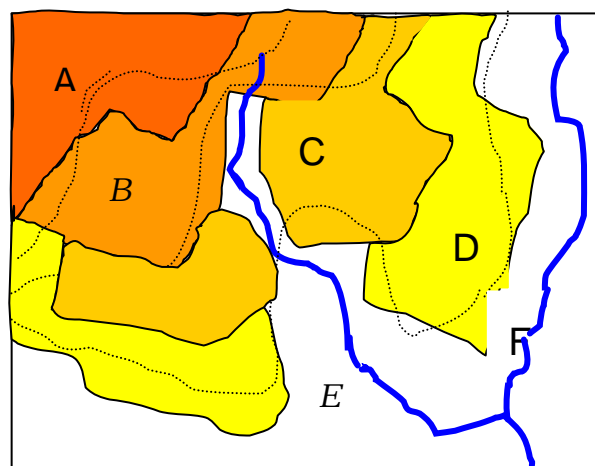

Fig. 3: Materials flow management through neighborhoods organized along catchment areas



TYPES OF SETTLEMENTS/OPEN SPACES:

**A** business and apartment blocks; **B** large-lot detached houses/villas, terraced and tree-covered plots; **C** residential (middle-class, detached or row-houses); **D** residential (self-built dwellings of the poor); **E** recycling, urban agriculture and forestry, pasture, flood basins; **F** primary drains, flood-plains



The following urban characteristics are, or at least, can be positively correlated to this design structure (although the portions vary depending on local conditions): terrain level, land prices, building structures, supply density of infrastructure, social stratification, proximity to materials flow handling, area used for recycling activities, informal sector activities, ...

The jumping point here is that this design renders possible an urban management symbiosis between the poor and the better-off neighbors because of the minimum distances between settlement types A, B and C, on the one hand, and D, on the other hand (including open spaces (E) for recycling, urban agriculture and forestry as well as decentralized rain retention and vegetational-biological based sewage treatment ponds). Survival costs for the urban poor can drastically be reduced by giving them access to surface water, cleared waste water, recycled solid waste of all fractions, nutrition (urban agriculture), construction materials (wood, clay), energy (wood, biogas), subsidized plots (through slightly overpricing of plots type A and B), subsidized and low-cost infrastructure standards. These facilities are not to design a „recycling ghetto“ but to place „buffers“ at the poor’s disposal for those periods when formal or informal sector employment is running short. Some people may receive contracts of long standing concluded by the municipality, as individuals or, still better, as CBO, and thus arrive at a high level accountability and performance secured by a supervisory authority.

The effectivity of solid waste or waste water collection on-site, by individual trash dumpsters or septic tanks, depends in much on the quality of process-oriented supervision which is labor-intensive and cannot be secured by good ordinances only. One of the big disadvantages of centralized collection systems and sewer networks is exactly the poor quality control access and, consequently, the disastrous end-of-pipe outcome (e.g. unusable sewage sludge).

**Ecological sanitation** requires short distance relations between dry toilets, composting and urban agriculture. And so do solid recycling, waste water cleaning and storm water retention – apart from all those employment relations between rich and poor which can provide some income to those who do not find a better job in industries or services. Nobody is in doubt about that poor prefer a job in less personalized and higher paid types of employment. This, once more, speaks in favor of a social segregation not exceeding small-scale levels in order to keep distances short to bus or metro-stops and any other type of public transit.

Drawing **final conclusions** from the exposed ideas we arrive to that cities should continue as cities, but that on a neighborhood-level they should develop a fringe which tends to be a mid-term between urban and rural life, or rather, recycling life tolerating some switching to and fro according to what is on the labor market. Still better than switching would be a legally or contractually defined role of those poor in recycling labor who are willing to cope with this little pleasant type of work and to consent to the necessary training on or off the job and the indispensable surveillance through local authorities. However, none of the relevant sustainability aspects in this context can be modified without implications for all the others. Philosophically, this is obvious. In terms of „urban sustainability“ this has still not been elaborated in a sufficiently detailed manner.

## Faecal contamination of a fish culture farm where hospital wastewater grown duckweeds are used as fish feed

**Dr. Sirajul Islam**

International Centre for Diarrhoeal Disease Research,  
(ICDDR,B), GPO Box 128, Dhaka-1000, Bangladesh  
Phone: 880-2-8811751-60 Ext. 2405/2407  
Fax: 880-2-8823116, 880-2-8812529  
mail: sislam@icddr.org

Co-authors: M.J. Alam<sup>1</sup>, M.A. Sadique<sup>1</sup>, G.B. Nair<sup>1</sup>, D.A. Sack<sup>1</sup>, M.A. Rahman<sup>1</sup>, M.S. Kabir<sup>2</sup>, S.I. Khan<sup>2</sup>, M. Ekramullah<sup>3</sup>, R.B. Sack<sup>4</sup>, A. Huq<sup>5</sup> and R.R. Colwell<sup>6</sup>

### Introduction

Duckweeds are tiny, fragile, free-floating, aquatic plants. Reproduction of duckweed is by vegetative means. An individual frond may produce as many as 10 generations of progeny over a period of 10 days to several weeks before dying. Duckweed fronds can double their mass in two days. Under experimental conditions their production rate can approach an extrapolated yield of 4 metric tons/ha/day of fresh plant biomass (Anonymous, 1976).

Duckweeds have long been recognized for their potential as a source of high protein feed for animals. Studies conducted in various countries of the world e.g. USSR, USA, Canada and others have demonstrated the nutritional benefits of duckweed for both livestock and fish. Animals grew better on duckweed-supplemented diets than they did on traditional diets using either soyameal or fish meal (Culley and Epps, 1973).

A project of duckweed based wastewater treatment has been undertaken at Mirzapur, Tangail, Bangladesh. "Duckweeds farming" is being done on agricultural land using either organic fertilizer or wastewater collected from Kumudini Hospital Complex (a 500 bed general hospital). In the Mirzapur duckweed project, there are two sets of ponds where the duckweed is grown. In one set of ponds inside the hospital complex, the duckweed is grown using artificial fertilizer. These are control ponds in non-wastewater area. The other set of ponds are in the wastewater area, situated 0.5 km away from the hospital complex. These are study ponds in wastewater area.

The hospital wastewater is "treated" with duckweed by having it grown in a series of wastewater lagoons (waste stabilization ponds). Duckweed, when grown in these ponds, convert substantial amount of organic material into plant biomass; they convert nutrients and dissolved minerals into plant biomass. When plants are harvested, nutrients and trace minerals are removed from the system and a dynamic nutrient and mineral sink is established. This forms the basis for a highly effective wastewater treatment technology. Waste stabilization ponds (lagoons) are

<sup>1</sup> International Centre for Diarrhoeal Disease Research, (ICDDR,B), GPO Box 128, Dhaka-1000, Bangladesh

<sup>2</sup> Department of Microbiology, University of Dhaka, Dhaka-1000, Bangladesh

<sup>3</sup> PRISM Bangladesh, Projects in Agriculture, Rural Industry, Science and Medicine, House#49, Road#4A, Dhanmondi R/A, Dhaka, Bangladesh

<sup>4</sup> Department of International Health, School of Hygiene and Public Health, Johns Hopkins University, 550 North Broadway, Suite 1001, Baltimore, MD 21205, USA

<sup>5</sup> Center of Marine Biotechnology, University of Maryland Biotechnology Institute, 701 East Pratt Street, Baltimore, Maryland 21202, USA

<sup>6</sup> Department of Cell Biology and Molecular Biology (CBMB), University of Maryland, College Park, Maryland 20742, USA

generally the method of domestic wastewater treatment of first choice in developing countries (Mara, 1976), The duckweed which grow in wastewater lagoons are harvested and used as the only source of fish feed. Therefore, duckweed is utilised for two purposes; one is for treating wastewater and the other is as fish-feed.

Two sets of workers were involved in harvesting the duckweed from control ponds and wastewater ponds. The duckweed which were grown in beds using artificial fertilizer were used as fish-feed in fish ponds of non-wastewater areas. The duckweed grown in wastewater lagoons were used as fish feed in fish ponds of wastewater areas. Therefore, this project provided an unique opportunity of a comparative microbiological investigation of a wastewater grown duckweed based fish culture project.

The role of duckweed in treating wastewater bacteriologically by reducing bacteria is not known. The level of contamination of fish due to use of wastewater grown duckweed as feed is also not known. Faecal coliform has long been used as an indicator organism in the aquatic environment. The coliform group of organism consists of *E. coli*, *Klebsiella* spp., *Citrobacter* spp., and *Enterobacter* spp. Among these bacteria, *E. coli* is the dominant genera which produces various toxins (Sack *et al.*, 1975; Sack, 1980) and can cause diarrhoea (Sack *et al.*, 1975a; 1975b; 1978). If the faecal coliform load can be reduced, that can also help to reduce the diarrhoeal disease. Therefore, the present study was designed to find out the efficacy of removal of faecal coliform by duckweed and fish grown in wastewater and non-wastewater ponds.

## Materials and methods

**Sampling spots and schedule:** The sampling spot was located within the Kumudini Hospital Campus of Mirzapur thana, under Tangail district of Bangladesh. The spot is approximately 60 km to the north of Dhaka, the capital city of Bangladesh. In the first week of every month, duckweed (DW), water and fish samples were collected for a period of 12 months (from May 1994 through April 1995) from the wastewater and non-wastewater areas for analysis of faecal coliforms. From the wastewater area, DW and water samples were collected from three of six wastewater ponds and three fish growing ponds. Only water sample was collected from the raw sewage. Tilapia (*Oreochromis nilotica*) was collected from fish pond no.1 and silver carp (*Hypophthalmichthys molitri*) was caught from fish pond no. 3 of the wastewater area. From the non-wastewater area, DW, and water samples were collected from two DW growing beds and two of four fish growing ponds. Tilapia and grass-carp (*Ctenopharyngodon idella*) were caught from pond no.1 and 2 respectively of the non-wastewater area. The sampling sites are shown in fig. 1. The abbreviation B1 and B2 stand for duckweed growing beds in which artificial fertilizer are used as nutrients. The control pond numbers 3 and 4 are designated as CP3 and CP4. All these sampling sites are situated in the non-wastewater area within the Hospital complex. In wastewater area, L5 stand for wastewater lagoon 5 where the raw sewage is collected and no duckweed is grown. From L5 the raw sewage is pumped to a zig zag pattern wastewater lagoons in which the duckweeds are grown. The sampling sites in wastewater lagoons are designated as L6 and L7. The study fish ponds in wastewater area are designated as P8, P9 and P10. All the above mentioned sampling sites are shown in fig. 1.

## Processing of samples

**Water:** When the count in water was high, either 0.1 ml was taken directly from the collected sample or 10 fold dilutions were prepared and then 0.1 ml wastewater was inoculated on MFC agar plate following drop plate technique (Hoben and Somasegaran, 1982). When the counts were low, membrane filtration technique was followed to concentrate faecal coliform. One ml

water sample was passed through a membrane filter (0.22 µm pore size, 47 mm diameter, Millipore) and the filter with retained bacteria was placed on mFC agar plate which was incubated at 44°C overnight. Following incubation characteristic blue coloured colonies were counted and expressed as faecal coliform/ml of water samples following standard procedures (APHA, 1992).

**Duckweed:** Ten grams of DW was washed 3 times with normal physiological saline for removing loosely attached bacteria. Then the washed duckweed was homogenized into a sterile electrical blender for one minute in 90 ml normal saline. Ten fold dilutions of the homogenate in normal saline were made. From each dilution, 25 µl sample was plated directly on mFC agar following drop plate technique (Hoben and Somasegoran, 1982) incubated at 44°C overnight. Typical FC were counted and expressed as CFU/g.

**Fish:** Fish gills were taken out and the exposed gills were washed in normal saline to eliminate unattached bacteria. Then ventral part of the fish was cut open with flamed sterile scissors and washed with sterile normal saline. Ten g each of washed gills and intestinal contents were separately homogenized in 90 ml normal saline in electrical blender for one min. Homogenized gills and intestinal contents of fish were processed for fecal coliforms following the same procedure as described for duckweed.

**Stool samples:** Stool samples were collected from the duckweed handlers every month during environmental sampling. Attempts were made to isolate common diarrhoeal bacterial pathogens e.g., pathogenic vibrios, *Aeromonas* spp., *Plesiomonas shigelloides*, *Shigella* spp., *Salmonella* spp., and *Campylobacter* sp. using conventional culture technique following the procedures described by Stoll *et al.*, 1982.

## Results

Fig. 2 shows the faecal coliform concentrations in water samples collected from the wastewater and non-wastewater ponds. Raw wastewater (L-5) showed the highest counts of faecal coliform. Other spots showed similar counts irrespective of wastewater and non-wastewater ponds.

Fig. 3 shows the faecal coliform counts in duckweeds in non-wastewater and wastewater ponds. The duckweeds collected from ponds situated both in non-wastewater and wastewater areas showed almost similar counts of faecal coliforms. In case of fish ponds, a slightly higher counts of faecal coliform in wastewater pond were observed than non-wastewater pond.

Fig. 4 shows the concentration of faecal coliform in fish samples collected from wastewater and non-wastewater ponds. The faecal coliform concentration were found almost similar in gills of fish which were caught from the ponds located both in wastewater and non-wastewater areas. In case of fish intestines, the faecal coliform count was slightly higher in fish caught from non-wastewater pond than wastewater pond. Fish intestine contained more bacteria than the gills. In fish samples, faecal coliforms concentrations were highest in comparison with water and duckweed (except raw wastewater).

The stool samples from the handlers worked in non-wastewater and wastewater areas yielded no enteric bacterial pathogens.

## Discussion

There is no significant difference in faecal coliform concentrations between wastewater and non-wastewater grown duckweed and fish. The faecal coliform concentrations were similar in

water collected from both wastewater and non-wastewater ponds (except in raw wastewater). These results indicated that the pollution level and the potential for transmission of diarrhoeal diseases are similar both in wastewater and non-wastewater ponds.

The fish farm workers had no complain regarding any infection from these sources. Fish were normal, no symptoms of disease was noticed. Fish growing pond waters were of desired quality for fish culture (faecal coliforms concentrations were  $<10^2$ /ml). Strauss (1985) reviewed the literature on the survival of pathogens in and on fish and concluded that invasion of fish tissues by pathogens increased with the duration of exposure to the contaminant. In Bangladesh, various studies showed that faecal coliforms concentration in natural water are quite higher (counts  $10^2$ - $10^3$ /ml of water) compared to fish growing pond waters of this study (Islam *et al.*, 1994a, Morshed *et al.*, 1985). Previous studies demonstrated that pathogenic bacteria are also very common in pond waters in Bangladesh (Islam *et al.*, 1991, 1992, 1994b, 1995, 1996) and elsewhere (Nair *et al.*, 1985; 1988). Pathogenic bacteria like *V. cholerae*, *Shigella* spp., *Campylobacter* spp. and others can also go to viable but non-culturable (VBNC) state (Colwell *et al.*, 1985; Colwell & Huq, 1994; Colwell *et al.*, 1996). Non-culturable pathogenic bacteria may also exist in these study ponds (Colwell *et al.*, 1985; Huq *et al.*, 1990; 1992). Further study should therefore be designed with the aim of detecting viable but non-culturable (VBNC) enteric pathogens from duckweeds, wastewater and fish from both non-wastewater and wastewater areas.

This study demonstrated that duckweeds can efficiently reduced the faecal coliform counts. The results also showed that following treatment with duckweeds, there was no significant difference between wastewater and nonwastewater interms of FC counts. The faecal coliform counts in duckweed and fish were semilar in both wastewater and nonwastewater areas. There was no isolation of enteric bacterial pathogens from the stool of handlers of duckweeds and fish.

Therefore, this study clearly demonstrated that duckweed can be grown in wastewater lagoons and can safely used as fish feed without having any potential risk for transmission of diarrhoeal diseases from fish. The workers who handle both the contaminated duckweed grown in wastewater and the fish fed by wastewater grown duckweed were also free from diarrhoeal pathogens. Therefore, the wastewater grown duckweek and fish fed by these duckweed do not pose any health hazard to the handlers.

The present study also showed that duckweed can be grown in wastewater lagoons which will help to treat the wastewater at the same time the wastewater grown duckweed could be used safely as fish feed for pisciculture. This study provided some vital information about microbiological safety of using wastewater for growing duckweed which can be used for pisciculture.

We can conclude from this study that in developing countries, duckweeds can be used as a good means for wastewater treatment. The duckweeds can also be used as fish feed. This study therefore important from microbiological safety point of view of wastewater grown duckweed which is used as fish feed as well as the handlers who are involved in duckweed based fish culture project.

## Acknowledgements

This research was supported by Swiss Development Cooperation (SDC) and the International Centre for Diarrhoeal Disease Research, Bangladesh (ICDDR,B). The ICDDR,B is supported by countries and agencies which share its concern for the health problems of developing countries. Current donors include: the aid agencies of the Governments of Australia, Bangladesh, Belgium, Canada, China, Denmark, Germany, Japan, The Netherlands, Norway, Republic of Korea, Saudi Arabia, Sweden, Switzerland, the United Kingdom and the United Stated;

international organizations including the Arab Gulf Fund, Asian Development Bank, European Union, International Atomic Energy Centre, the United Nations Children's Fund (UNICEF), the United Nations Development Program (UNDP), the United Nations Population Fund (UNFPA) and the World Health Organization (WHO); private foundations including Child Health Foundation, Ford Foundation, Population Council, Rockefeller Foundation and the Sasakawa Foundation; and private organizations including American Express Bank, Bayer A.G., CARE, Family Health International, Helen Keller International, the Johns Hopkins University, Procter Gamble, RAND Corporation, SANDOZ, Swiss Red Cross and the University of California Davis and others. We thank Mr. Md. Anisur Rahman for typing the manuscript.

## References

- American Public Health Association (APHA,1992). Standard methods for the examination of water and wastewater, 18th ed. Washington DC: American Public Health Association, Water Pollution Control Federation, Washington DC, USA.
- Anonymous (1976). Making aquatic weeds useful: some perspectives for developing countries. National Academy of Science, Washington, DC.
- Colwell, R.R., Brayton, P.R., Grimes, D.J., Roszak, D.B., Huq, S.A. and Palmer, L.M. (1985). Viable but non-culturable *Vibrio cholerae* and related pathogens in environment: implications for release of genetically engineered microorganisms. *Biotechnology* 3:817-820.
- Colwell, R.R. and Huq, A. (1994). Vibrios in the environment: viable but non-culturable *Vibrio cholerae*. In: Wachsmuth IK, Blake PA, Olsvik O (eds.) *Vibrio cholerae* and cholera: molecular to global perspectives. American Society for Microbiology, Washington, D.C., pp. 117-133
- Colwell, R.R., Brayton, P., Herrington, D., Tall, B., Huq, A. and Levine, M.M. (1996). Viable but non-culturable *Vibrio cholerae* O1 revert to a cultivable state in the human intestine.
- Culley, DD. JR., and EA. Epps. (1973). Use of duckweed for waste treatment and animal feed. *J. Water Pollut. Control. Fed.* 45: 337-347.
- Edwards, P. (1985). Aquaculture: A component of low cost sanitation technology. Technical Paper No. 36. The World Bank, Washington, DC.
- Hoben, H.J., and Somasgoran, P. (1982). Comparison of the pour, spread, and drop plate methods for enumeration of *Rhizobium* spp. in inoculants made from presterilized peat. *Applied and Environmental Microbiology*. 44:1246-1247.
- Huq, A., Colwell, R.R., Rahman, R., Ali, A., Chowdhury, M.A.R., Parveen, S., Sack, D.A. and Russek-Cohen, E. (1990). Detection of *Vibrio cholerae* O1 in the aquatic environment by fluorescent-monoclonal antibody and culture methods. *Applied and Environmental Microbiology*. 56:2370-2373.
- Huq, A., Alam, M., Parveen, S. and Colwell, R.R. (1992). Occurrence of resistance of vibriostatic compound O/129 in *Vibrio cholerae* O1 isolated from clinical and environmental samples in Bangladesh. *Journal of Clinical Microbiology*. 30:219-221.
- Islam, M.S. and Aziz, K.M.S. (1981). Association of vibrios with some hydrophytic plants. *Bangladesh Journal of Microbiology* 1:70-72.
- Islam, M.S., Alam, M.J. and Khan S.I. (1991). Distribution of *Plesiomonas shigelloides* in pond ecosystems of Dhaka Bangladesh. *Microbiology and Immunology*. 35:927-932.

- Islam, M.S., Alam, M.J. and Neogi, P.K.B. (1992). Seasonality and toxigenicity of *Vibrio cholerae* non O1 isolated from different components of pond ecosystems of Dhaka city, Bangladesh. *World Journal of Microbiology and Biotechnology*. 8:160-163.
- Islam, M.S., Alam, M.J., Khan, S.I. and Huq, A. (1994a). Faecal pollution of freshwater environments in Bangladesh. *International Journal of Environmental Studies*. 46:161-165.
- Islam, M.S., Hasan, M.K., Miah, M.A., Yunus, M., Zaman, K. and Albert, M.J.(1994b). Isolation of *Vibrio cholerae* O139 synonym Bengal from the aquatic environment of Bangladesh: Implications for disease transmission. *Applied and Environmental Microbiology*. 60 : 1684-1686.
- Islam, M.S., Alam, M.J. and Khan, S.I. (1995). Occurrence and distribution of Culturable *Vibrio cholerae* O1 in aquatic environments of Bangladesh. *International Journal of Environmental Studies*. 46 : 217-223
- Islam, M.S., Alam, M.J., Begum, A., Rahim, Z., Felsenstein, A. and Albert, M.J. (1996). Occurrence of culturable *Vibrio cholerae* O139 Bengal with ctx gene in various components of aquatic environment in Bangladesh. *Transactions of the Royal Society of Tropical Medicine and Hygiene*. 90: 128.
- Mara, D.D. (1976). *Sewage treatment in hot climates*. John Willy, Chichester.
- Morshed, M.G., Aziz, K.M.S., Islam, M.S. and Khan M.R. (1985). Presence of coliform bacteria and their distribution in the Buriganga river. *Bangladesh Journal of Microbiology*. 2(1&2), 6-10.
- Nair, G.B., Sarkar, B.L., Abraham, M. and Pal, S.C. (1985). Serotypes of *Vibrio parahaemolyticus* isolates from hydrobiologically dissimilar aquatic environs. *Appl. Environ. Microbiol.* 50: 724-726.
- Nair, G.B., Sarkar, B.L., De, S.P., Chakraborti, M.K., Bhadra, R.K. and Pal, S.C. (1988). Ecology of *Vibrio cholerae* in the freshwater environs of Calcutta, India. *Microb. Ecol.* 15: 203-216.
- Sack, D.A. and Sack, R.B. (1975). Test for enterotoxigenic *Escherichia coli* using Y1 adrenal cells in miniculture. *Infect. Immun.* 11: 334-336.
- Sack, D.A. (1980). Enterotoxigenic *Escherichia coli*: Identification and characterization. *J. Infect. Dis.* 142: 279-286.
- Sack, R.B. (1975a). Human diarrheal disease by enterotoxigenic *Escherichia coli*. *Ann. Rev. Microbiol.* 29: 333-353.
- Sack, R.B., Hirschhorn, N., Brownless, I., Cash, R.A., Woodward, W.E. and Sack, D.A. (1975b). Enterotoxigenic *Escherichia coli* associated diarrhoeal disease in apache children. *N. Engl. J. Med.* 292: 1041-1045.
- Sack, R.B. (1978). The epidemiology of diarrhea due to enterotoxigenic *E. coli*. *J. Infect. Dis.* 137: 639-640.
- Stoll, B.J., Glass, R.I., Huq, M.I., Khan, M.U., Holt, J.E. and Banu, H. (1982). Surveillance of patients attending a diarrhoeal disease hospital in Bangladesh. *Br. Med. J.* 285: 1185-1188.
- Strauss M. (1985). Survival of excreted pathogens in excreta and faecal studdes. *IRCWD News*. 23: 4-9.

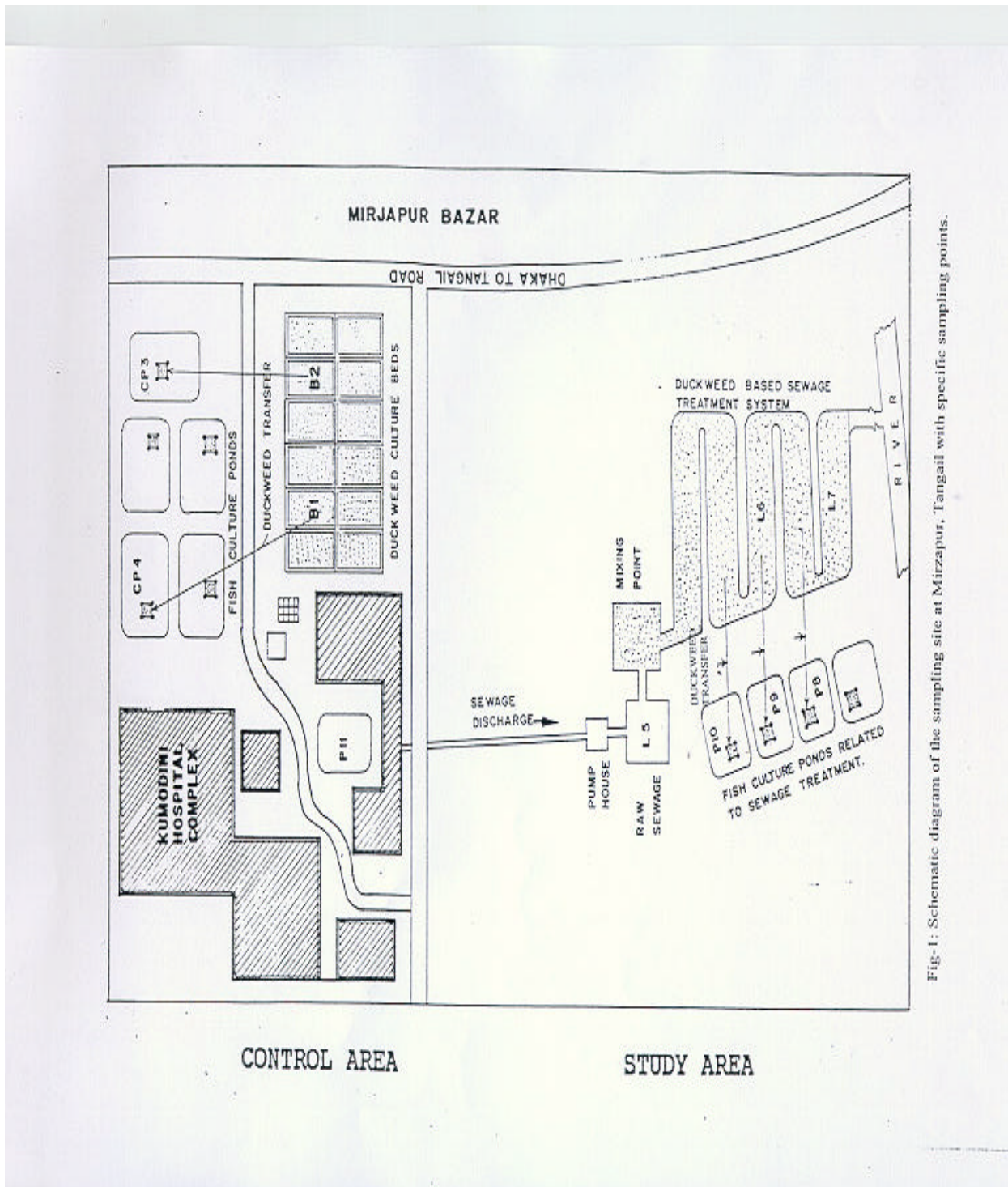

Fig-1: Schematic diagram of the sampling site at Mirzapur, Tangail with specific sampling points.



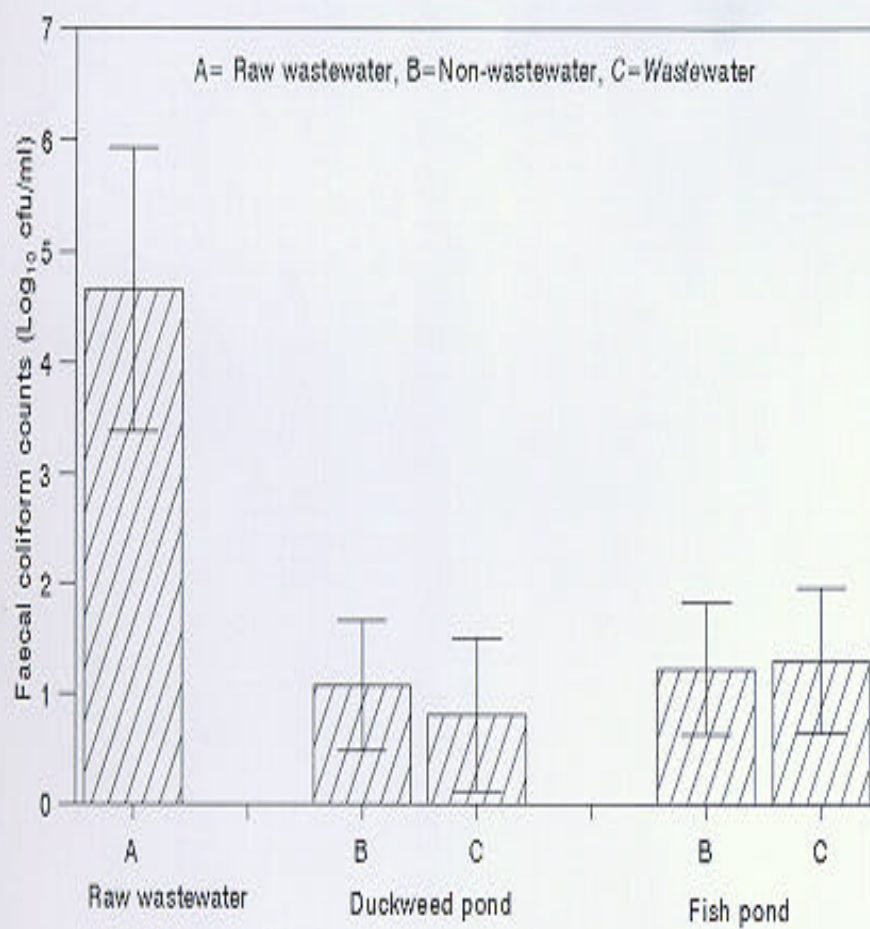

Fig-2: Faecal coliform counts of water collected from raw wastewater, non-wastewater and wastewater ponds.

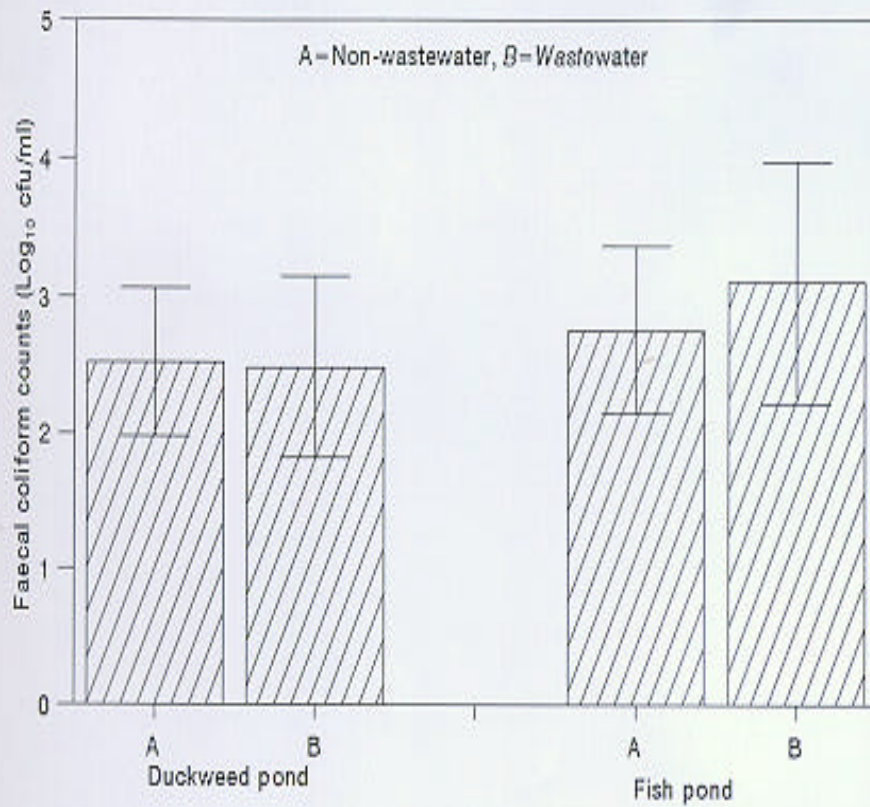

Fig-3: Faecal coliform counts in duckweed collected from non-wastewater and wastewater ponds.

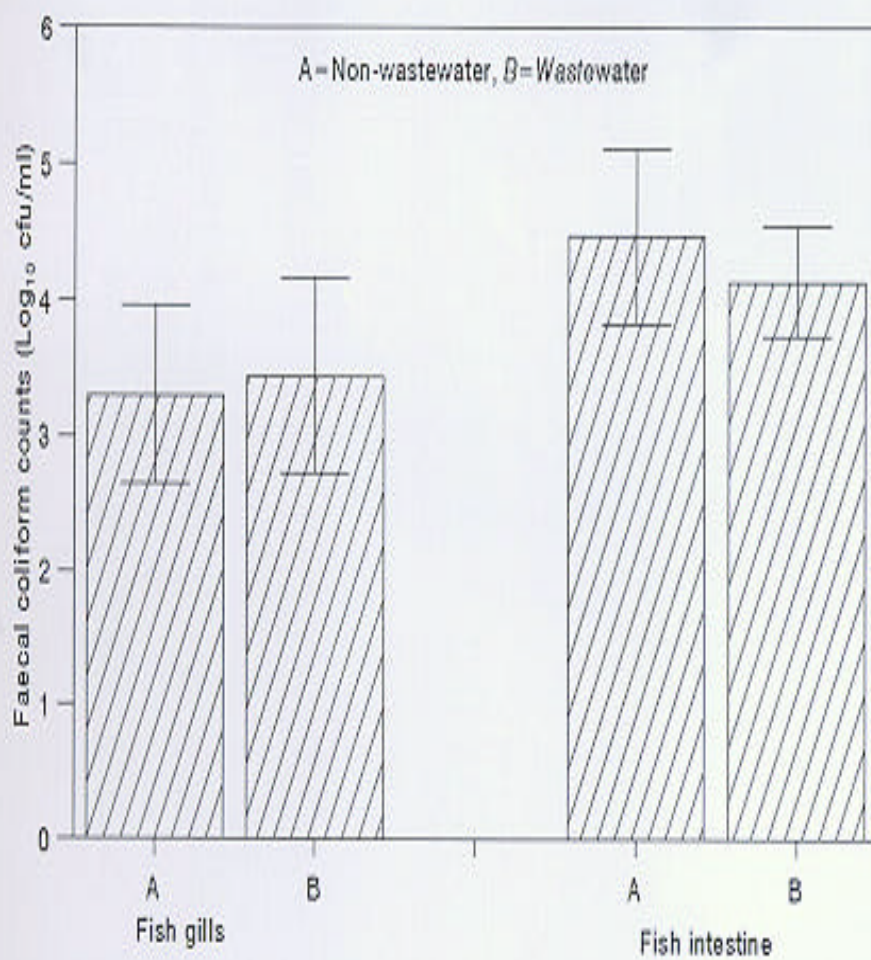

Fig-4: Faecal coliform counts in fish-gills & intestine of non-wastewater and wastewater ponds.

## Potential of reed beds (constructed wetlands) for sustainable wastewater treatment in residences and industry

**Dr.-Ing. Margarita Winter** BASE TECH, Lilienthalstr. 21 c, D-34123 Kassel, Deutschland  
Tel: ++49-561-54410  
Fax: ++49-561-573829  
winter@base-tech.de  
www.base-tech.de

### Abstract

Ecological sanitation requires treatment of wastewater as a liquid resource appropriate to the effluent quality and the process target of any special application. The most consistent solutions are zero-discharge-houses and complete recycling of water and ingredients from manufacturing effluents. For versatile application fields, tailor-made Constructed Wetlands can be implemented.

Reed-Bed-Purification-System is an efficient treatment process with a wide range of modifications depending on the chosen strategy of ecological sanitation for domestic, municipal, or for industrial effluents, applicable in various sizes and for different climates and conditions, proved by long-term experience. It combines high performance with low costs and ecological advantages.

This is a highly sustainable treatment process, meeting numerous criteria according to U.N. Conventions and Agenda 21 (Rio de Janeiro, 1992), such as low maintenance costs due to high operation security, long operating time, energy autarchy, water and material recycling, protection of mineral resources, protection of landscape, protection of climate etc.

Thus this method needs demanding construction, but easy handling in operation.

### Key-words

ecosan, sanitation, sewage, industrial effluent, wastewater, greywater, seepage, process water, operation water, irrigation, recycling, hygienisation, wetlands, reed bed, soil filter, root zone, sustainable, energy autarch, decentral

### Application and performance

During recycling of resources, ecological sanitation systems require a treatment process, which divides wastewater into its reusable parts (clean water, nutrients etc.) or at least separates the reusable substances from the wastewater, while caring for a hygienic estate of all stock flows.

A treatment process is desirably chosen, meeting supplementary demands of sustainable strategy in addition, such as reliable performance, long standing, affordable costs and avoidance of wearing out any natural resources. Guidelines were given in the U.N. Conventions on Climate Change and Biodiversity and the Agenda 21 for sustainable development as result of the earth summit in Rio de Janeiro, 1992.



**Figure 1 : Reed Beds use the biocybernetic autocontrol system of an ecosystem and blend with its environment.**



**Figure 2: Reed Beds include mechanical filtration, chemical precipitation and biological degradation in one purification step.  
This combined clarification is effective and reduces costs.**

All these demands are fulfilled by Reed-Bed-Systems, which are applied in ecosan cycles (ecological sanitation) both for domestic sewage and industrial effluents. Besides they are implemented for purification of the remaining wastewater producing clean water for discharging into the natural water resources.

Constructed Wetlands are efficient for domestic or municipal sewage (greywater or mixed wastewater) of secluded buildings, villages, towns, or districts of cities as long as the necessary area is available (1 to 5 m<sup>2</sup> / inhabitant). Decentral application in small units has the advantage of spending the investment for purification instead of transport, and of retaining the resources inside small local cycles. For the individual case it should be considered, whether a more decentral or a more central solution has economical and ecological advantages and is best suitable.

Supplementary to ecosan systems for domestic resources, sustainable treatment systems for liquid resources from producing enterprises are necessary. Examples are existing as well for reuse of domestic liquid resources in places of residence after hygienisation and/or removal of the organic peak load (zero-discharge-houses), as for complete recycling of manufacturing wastewater and/or recycling of water ingredients.

In trade and industry various methods for ecological sanitation can be applied within the company such as reducing the amounts of demanded input water and effluent, optimising the chemical application concerning production safety and disposal, recovery of raw materials by modern recycling processes, re-utilisation of conditioned wastewater for operation water etc..

Here are two examples representative for various branches. Firstly a vegetable manufacturing company is cited, using its water for washing potatoes and vegetables several times in decreasing steps of purification grade (counter-current rinsing), and recycling again after an effective treatment. Finally the more and more concentrated liquid resources are reused for fertilising of grassland. Secondly in a textile finishing mill the dying recipe was changed by substituting problematic chemicals to biodegradable ones. Textile size and dyestuff (indigo) are completely recovered by ultrafiltration for reprocessing in the very company. The remaining wastewater is then purified in an energy autarch biological treatment plant. This purified process water is reprocessed in the production process as operation water by recycling of rinse water.

In consideration of water use within a mill the aim should be, not to use water of higher quality than necessary for a particular purpose unless its use is absolutely or particularly convenient. For water conditioning in such recirculations a combination of different treatment processes are applied. One of the most sustainable treatment processes is the Constructed Wetland.

Effluents from trade and industry are effectively treated by Reed-Bed-Systems, according to the specially demanded purification level during water conditioning for operation water, for irrigation water, or for discharging into surface water or even groundwater.

Experiences exist with treatment of various types and concentrations of wastewater by Constructed Wetlands, such as

domestic greywater	industrial wastewater from different branches
domestic sewage (mixed)	- foodstuff
seepage of waste disposals (dump)	- mineral oil
airport wastewater	- chemistry
primary treated waste water (e.g. biogas)	- textile
storm water	- leather
polluted river water, groundwater	- paper
	- metal

Reed-Bed-System is capable of working with high performance and best process stability. This multi-purpose treatment process proved suitable for effluent flows from 0,01 m<sup>3</sup>/d up to several 10 000 m<sup>3</sup>/d and for concentrations from a few mg/l up to 35 000 mg COD/l and 5 000 mg nitrogen/l.

In humid-tropical or arid climate, it proved a success by effective and hygienic sewage treatment, by using locally available materials, by easy handling, and by a wear-resistant operation.

During dimensioning and construction depending on the climate, as well as during choosing of filler material and plant strain for Reed-Beds, the specific wastewater characteristics and purification demands have to be taken into consideration, in order to attain reliable performance.

This system is demanding during planning and building, but easy during operation, because of the use of self-regulation mechanisms, provided by an expert construction.

## The process

This wastewater treatment or purification system includes several simultaneous processes such as mechanical filtration, chemical precipitation, and biological metabolism linked together in one purification step, supporting each other.

Reed-Bed-System is a process, based on the co-operation of living organisms and ecological mechanism, grouped together resulting in natural self-regulation and self-regeneration. For this the complex structures and biocybernetic autocontrol systems of nature are utilised – by establishing an artificial ecosystem with high diversity of micro-organisms interacting with each other.

The method is characterised by the biochemical efficiency of an active top soil. This one retains pollutants, concentrates and activates them. Thus organic compounds become accessible to degradation by bacteria and fungi. Morbific agents are defeated by antibiotic agents from fungi or root excretion products. Nutrients are converted to stable forms, being stored inside the reactor. The plants (helophytes) with their root system supply micro-organisms with oxygen and assure the flow of water through the filler material. Hundred fold amount of specialised microbe species, compared to conventional effluent treatment, adapt themselves here to various types of wastewater.

For these reasons, Reed-Bed-System creates suitable conditions for the elimination of numerous substances from the effluents (see table), whether by concentration for material recycling or by decomposition of harmful substances such as:

- Phosphorus - concentrated
- Sulphur compounds (sulphate, sulphide, elementary sulphur etc.) - concentrated
- Heavy metals - concentrated
- Inorganic nitrogen compounds (ammonium and nitrate) - partly concentrated partly decomposed
- Morbific agents (causing illnesses) - decomposed
- Persistent organic compounds (e.g. chlorinated hydrocarbons, polycyclic aromatics, nitrogen-, and sulphur-containing aromatics) - decomposed

Various methods for recovering this stored resources are available, and are chosen depending on the given concentration, mixture and purpose of reprocessing.

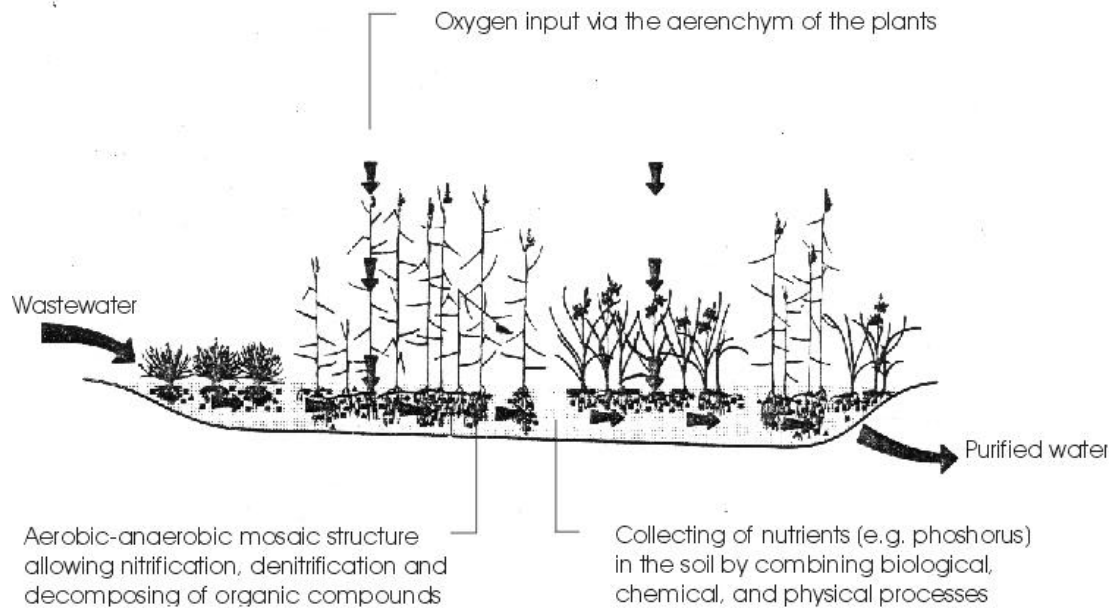

**Figure 3: Operational scheme of Constructed Wetlands.**



**Figure 4: Tests with mobile pilot plants support the choice of filler material and reed strain for application in special cases.**



**Table: Examples of application fields for Constructed Wetlands**

Origin of wastewater	Before treatment		After treatment	
	Type of wastewater	Main ingredients	Resulting quality	Process target: using for
domestic private houses	greywater from bath and kitchen	BOD <sub>5</sub> 170 mg/l	clear, odourless, hygienic	washing machine; house cleaning
domestic private and public houses e.g. hospitals			hygienic	garden irrigation
domestic and municipal	sewage (mixed)	nitrogen 100 mg/l phosphorus 20 mg/l BOD <sub>5</sub> 400 mg/l	hygienic	agricultural irrigation and fertilising
	seepage of waste disposals	nitrogen 800 mg/l COD 750 mg/l AOX 1 mg/l	nitrogen 10 mg/l phosphorus 1 mg/l BOD <sub>5</sub> 15 mg/l	discharge into sensitive recipients or into groundwater after passing through soil, while storing nutrients inside the reactor
municipal and industrial	storm water	nitrate-N 60 mg/l COD 100 mg/l PAH 0,03mg/l	nitrate-N 1 mg/l BOD <sub>5</sub> 3 mg/l PAH not detectable	operation water; washing machine; house cleaning; agricultural irrigation; fish pond; bathing pond; eventually drinking water
	polluted river water polluted groundwater		hygienic	
from trade and industry	agriculture foodstuff processing	nitrogen 250 mg/l phosphorus 50 mg/l COD 5 000 mg/l	nitrogen 170 mg/l phosphorus 45 mg/l COD 500 mg/l hygienic	agricultural irrigation and fertilising
			nitrogen 50 mg/l COD 150 mg/l hygienic	cleaning of processing buildings, machines, utensils; operation water for minor demands; cooling water; while storing nutrients inside the reactor
	textile dyeing	nitrogen in aromatics 700 mg/l COD 33 000 mg/l AOX 320 mg/l heavy metals in chelate 65 mg/l	nitrogen 50 mg/l COD 270 mg/l AOX 5 mg/l heavy metals 29 mg/l	textile washing – first washing step; cleaning of processing plants, containers and utensils
	textile finishing, leather manufacturing and finishing, paper recycling	nitrogen 30 mg/l sulphur 450 mg/l COD 3 000 mg/l AOX 4 mg/l heavy metals 20 mg/l	nitrogen 10 mg/l sulphur 110 mg/l COD 90 mg/l AOX 0,5 mg/l heavy metals 4 mg/l	textile washing besides last washing step; cleaning of processing buildings, machines, and utensils; operation water for paper stock; reprocessing of elementary sulphur
	metal processing e.g. electroplating	sulphur 600 mg/l COD 800 mg/l AOX 10 mg/l heavy metals 40 mg/l	sulphur 170 mg/l COD 150 mg/l AOX 0,1 mg/l heavy metals 4 mg/l	operation water for cleaning; operation water for production; reprocessing of heavy metals; reprocessing of elementary sulphur
	chemistry, mineral oil	COD 1 300 mg/l phenol 100 mg/l hydrocarbon 10 mg/l	COD 65 ..mg/l phenol 0,1 mg/l hydrocarbon 0,1 mg/l	operation water for cleaning and production; discharge into recipient

Legend: BOD<sub>5</sub> biological oxygen demand  
 COD chemical oxygen demand  
 AOX adsorbable organic halogens  
 PAH polynuclear aromatic hydrocarbons

## Why is reed-bed-system a sustainable treatment process?

The choice of ecological sanitation strategy depends on the special application case and the type of area (rural, semi-urban, urban, industrialised).

Whether domestic sewage is separated (greywater) or mixed (including manufacturing effluents, storm water etc.), it is still necessary to be treated depending on the wished target by hygienisation, by degrading of the peak load, or even up to nitrification, denitrification, phosphorus elimination etc.. For ecological sanitation in trade and industry there are even more quality variations of the outputs of production processes and inputs of operation water.

In all cases wastewater treatment has to be constructed appropriate to the effluent quality and the aimed treatment result depending on the type of reprocessing or disposal (see table).

Whenever there is to be chosen a type of treatment process in ecological sanitation, one should check ecological criteria besides economical and operational aspects. From the standpoint of sustainability, processes are to be implemented, which besides recycling of material and/or water meet further demands (see below).

For numerous application fields a tailor-made Constructed Wetland can be implemented as a highly sustainable clarification process, because of...

- **effective purification:**
  - Degradation of various pollutants, even persistent ones, and simultaneous removal of moribific agents (hygienisation), thus providing operation water for numerous purposes and protecting natural water resources.
- **secure operation:**
  - High process stability, guaranteed by biological self-regulation, self-regeneration, and big buffer capacity.
- **water recycling:**
  - Supplying operation water of high standard, whether completely purified or with nutrients left inside for use as fertiliser.
- **material recycling:**
  - Collecting and storing minerals (phosphorus, sulphur, nitrogen, potassium etc.) as solid matter in a clearly defined, separated compartment inside the Reed-Bed reactor, from where they can be recovered and reprocessed easily.
- **low building costs:**
  - Using locally available materials and contribution of do-it-yourself work, if guided by an expert engineer.
- **low running costs:**
  - Little or no energy is needed for this treatment process.
  - No need of chemical additives, which means no expenses what so ever and no pollution of environment besides.
  - No production of sewage sludge or any waste, which means no disposal costs.
  - Low servicing costs through easy handling and wear-resistant operation.
- **stable in costs:**
  - Independent of operational and technical spiral of costs (IT-innovations, costs of energy, disposal of sewage sludge etc.).

- From beginning of the project until long-term operation, the costs are transparent and are certain to calculate.
- **long standing:**
  - Operating time of 100 years will be reached, which means no exploitation of energy and material resources for rebuilding and no expenditure for disposal as renewed seldom.
- **protecting landscape:**
  - Landscaped to blend with their environment.
  - Supplying a wetland biotope, thus supporting rare birds.
  - Usable as nearby recreational area.
- **protecting resources:**
  - Oxygen supply by green plants using sun energy.
  - Wastewater flowing along the slope by gravity.
  - No demand of artificial energy.
  - No chemical additives needed.
- **protecting climate:**
  - Compensation of waste warmth by cooling during evapotranspiration of the reed stand (1 ha reed compensates residence units for about 328 inhabitants of European life style).
  - Avoidance of anthropogenic emission of CO<sub>x</sub>, SO<sub>2</sub> and NO<sub>x</sub> from the burning of fossil resources by not depending on artificial energy (zero-emission).
  - Compensation of acid causing and greenhouse gas emissions as a sink for carbon, sulphur, nitrogen, etc. by sedimentation and humus formation (minus-emission: loading with low concentrated sewage achieves already storing performance of 16,2 t C, 3,5 t S and 1,7 t N per ha and year).
- **flexible applicable:**
  - Dimensioning according to the specific input conditions and output targets.
  - Tailor-made for the specific climate, social-cultural demands etc.
  - Various systems, vertical or horizontal, are available, depending on the specific demands and possibilities.

Reed-Bed-System is a sustainable treatment process, concerning aspects of ecosan, as applicable in ecosan cycles by turning liquid resources harmless, and as separating materials from effluents itself.

It is sustainable concerning criteria of climate protection (according to U.N. Convention on Climate Change and Agenda 21, chapter 9) as avoiding anthropogenic emissions by independence of artificial energy and as compensating them by fixing climate relevant elements inside the Reed-Bed reactor. It is sustainable concerning criteria of waste avoidance (according to Agenda 21, chapter 16 and 21) as no waste is produced. And moreover it is sustainable concerning further criteria, such as protection of mineral resources, protection of landscape with protection of rare species of animals, etc. (according to Agenda 21, chapter 10 and 15 and U.N. Biodiversity Convention). Furthermore it is affordable and reliable working during long operating times (according to Agenda 21, chapter 7 and 18).

Thus Constructed Wetlands indeed fulfil versatile measures of sustainability in one treatment process.

For scientific papers, project examples, and references, contact the author.

## Sustainable wastewater treatment with soil filters

**Brigitta Züst**

Centre for Applied Ecology Schattweid,  
CH 6114 Steinhuserberg

**Philippe Wyss**

University Wädenswil,  
Grüntal, Postfach 335, CH 8820 Wädenswil

### Contents

- A. Basic strategies for wastewater treatment: extensive vs. intensive
- B. An example in Kyrgyzstan: A cheese factory - What is the solution for its wastewater?
- C. A brochure assisting decision-makers

### Introduction

An important way of preserving drinking water consists in not polluting it. Another approach is to pollute as little as absolutely necessary. On-site management of wastes is desirable and necessary but in many situations there is no substitute for a wastewater treatment plant. However, this is an "end of pipe" measure. The interest in cheap and reliable wastewater treatment is considerable, and will remain so. A wide range of techniques is available and it is important to select the most appropriate alternative for each given geographic, economic, socio-cultural and environmental situation.

### A. Basic strategies for wastewater treatment: extensive vs. intensive

Different wastewater treatment techniques have very different requirements for energy and land. The greater the land area that is used for the treatment process, the smaller the energy requirement, and vice versa.

Wastewater treatment functioning with little or no energy may be called "extensive" by analogy to extensive agriculture or extensive aquaculture. In all these cases "extensive" implies the use of relatively large areas of land or water. On the other hand, little land or water is necessary for "intensive" alternatives, but there is an intensive use of technology and energy (directly or indirectly).

*The influence of the choice of wastewater treatment method on four basic parameters*

### Extensive wastewater treatment

In extensive wastewater treatment, natural processes are accelerated. The necessary area is less than what would be needed for self-purification but it is still considerable. Extensive treatment methods include soil filters (synonyms: constructed wetlands, planted soil filters, planted sand filters, sand plant filters, root zone systems, reed beds, green wastewater

treatment plants; soil filters without vegetation), aquaculture systems and irrigation and infiltration.

## B. An example in Kyrgyzstan: A cheese factory - What is the solution for its wastewater?

The Centre for Applied Ecology Schattweid planned a wastewater treatment plant for a cheese factory which the Swiss Government organisation Intercooperation (IC) financed through Kyrgyz-Swiss-Dairy-Program (KSDP). The factory in Jelu Bulak in Tyup Rayon, Kyrgyzstan, has been operating since November 1996.

### Local conditions

Height above sea level	1800m
Precipitation	400 mm/a
Climate	Continental
Receiving water	River runs for 60 km before flowing into Lake Issyk Kul Lake Issyk Kul is protected by national law
Earthquakes	Up to 9 on the Richter scale

### The wastewater treatment plant

Three Kyrgyz ministries are responsible for water supply and wastewater treatment. They required a Soviet type treatment plant QU 200 which is an activated sludge plant pumping oxygen into the basins which contain suspended bacteria. They specified that the treated wastewater must then be spread on 4 hectares of land.

The following problems had to be considered:

The supply of energy is not reliable

The risk of damage by earthquakes is high

Irrigating the treated wastewater is possible only during the warm part of the year

Different legal requirements depending on the ministry concerned

Very high costs for the known and familiar Soviet wastewater treatment systems

The local authorities had no knowledge about nor experience with extensive wastewater treatment and were therefore sceptical about such propositions.

### Procedure

The following steps were undertaken to construct and operate a plant to treat the wastewater of the cheese factory in an optimal way.

Encourage operators to use the whey (feeding it to cattle) instead of adding it to the wastewater.

Planning (at the Centre of Applied Ecology Schattweid, Switzerland) and building (by a well recommended local engineer) four horizontal soil filters (constructed in 1996; planted in 1997)

A first Schattweid mission to Jelu Bulak to visit the cheese factory was undertaken in November 1996. The objectives were to inspect the effluent treatment plant, meet staff, have contact with

relevant institutions and controlling bodies, present the wastewater treatment system operating at Jelu Bulak, and discuss pending issues.

A study tour to Switzerland (April 1997) of three Kyrgyz wastewater treatment specialists: They visited Swiss and German treatment plants (intensive and extensive), discussed with plant operators and managers, compared the Kyrgyz and Swiss legal requirements for treated wastewater, prepared the way for obtaining a permanent operating permission for the cheese factory (with respect to the treatment efficiency), and built up a climate of confidence.

The second Schattweid mission to Jelu Bulak (July/August 1997) was to assess the actual operation and efficiency of the treatment plant; install a laboratory for wastewater analysis in the basement of the cheese factory; train a local specialist, and encourage plant operators to use sludges from the settling tanks as fertilisers.

#### The wastewater treatment plant in summer 2000

The farmers bring the milk and are eager to take back the whey; so now only spilled whey gets into the wastewater

Two of the initial filters seemed to have low permeabilities, as frequently water was standing at the surface. They were opened, broken pipes were replaced and the filters were refilled according to the initial plans. Now they work well and the permeability is satisfactory.

The amount of milk delivered to the factory increased so much that two additional filters had to be built.

The fat in the wastewater caused - and still causes - problems. Initially the grease trap was not serviced regularly. Then even with regular servicing too much fat was reaching the settling tank. A second fat absorber alleviated the problem but could not completely solve it. In summer, when large volumes of milk are processed, the flowing distance between the cleaning area in the cheese factory and the grease trap is not sufficient to allow the fat to coagulate; thus it will do so only in the settling tank from where it has to be removed at regular intervals. During the cold season, when less milk is processed, these problems do not arise.

At the start of operation of the cheese factory, all attention was directed towards production. Only gradually did the insight come that wastewater treatment should not be neglected. The responsibilities for maintaining and supervising the wastewater treatment plant were defined and responsible persons were entrusted with these duties.

The efficiency of the treatment process is controlled by a local specialist. She does regular analyses of wastewater samples (using the Dr. B. Lange system). Several minor errors in the analysis procedure were discovered and eliminated - in particular sampling errors. The results generally meet Swiss and European standards.

Now, after three years of operation, the wastewater treatment plant runs well and gives satisfactory to good results.

In the country there is growing interest in this extensive wastewater treatment.

The plant has proved to be cheap in operation and maintenance.

#### Advantages of the soil filter system

Independent of electricity

Uses local materials almost exclusively

It is modular and therefore flexible in its operation. It can easily be enlarged.

Locally generated fertiliser (sludges) can serve the local community

The treated wastewater is suitable for many different purposes.

User's interest and responsibility are high if involvement is encouraged and ownership is possible.

### C. "Sustainable wastewater treatment with soil filters" - a brochure assisting decision-makers

In densely populated areas it is more common to treat wastewater using intensive methods. Consequently planning engineers are more familiar with these techniques but lack information regarding alternatives that consume little energy, such as stabilisation ponds, soil filters, irrigation, infiltration and aquaculture. The brochure aims to fill this gap, particularly with regard to soil filters.

Soil filters are considered to be a reliable, energy-efficient (or even energy independent), cheap and sustainable wastewater treatment method. Generally, soil filters are applicable in rural or periurban areas, serving populations of up to 1000 (although much larger ones exist).

Soil filters compared to other extensive treatment methods.

*All systems are considered to be of similar size, e.g. for the same number of users and at comparable treatment efficiency. The comparisons are qualitative and refer exclusively to the four systems compared. Shaded frames indicate treatment methods which clearly differ from others regarding a particular parameter*

Parameter	Soil filters	Ponds	Aquaculture	Irrigation
Sensitivity to variations in quality and quantity of incoming wastewater	low to medium	negligible to low	low to high	low to medium
Energy demand for operation	zero to low	zero to low	zero to medium	zero to high
Land requirement	little	medium	medium to high	high
Health risks	negligible to low	medium to high (1)	medium to high (1,2)	low to high (2)
Impact of site conditions on operation	high	medium	high	medium
Importance of preventing leakage from storage	medium	medium to high	medium to high	Not required
Suitability in different climatic conditions	high	low to medium	low to medium	low to medium
Probability of malfunction	low	very low	medium	very low
Maintenance effort required	medium	low	high	very variable
Technical sophistication	high	medium	medium to high	low to medium

Parameter	Soil filters	Ponds	Aquaculture	Irrigation
Construction costs	high	medium to high	medium to high	low
Maintenance costs	medium	low	medium to high	low to medium

Notes – Health risks (1) Drowning and mosquitoes (2) Contaminated crops

The brochure aims to assist decision-makers to decide whether soil filters are an appropriate solution for their wastewater problems; it is not a design manual for engineers. It lists pros and cons of soil filters and compares them with other extensive treatment methods. Like all engineering systems, wastewater treatment plants are most sustainable when they are adapted to the individual situation. This publication addresses the technical, economic, institutional and socio-cultural aspects which should be considered when deciding on the most appropriate way of treating wastewater in a particular context.

Reference: Wyss, P., Zuest, B., Guenat, D., Ducommun, G. 2000. Sustainable wastewater treatment with soil filters. SKAT, CH-St. Gallen. Financial support from Swiss Agency for Development and Cooperation (SDC), CH-3003 Bern and Swiss Centre for Development Cooperation in Technology and Management SKAT, CH-9000 St. Gallen. Distributed by: Intermediate Technology Publications, 103-105 Southampton Row, London WC1B 4HH, UK. ISBN 3-908001-88-9.

Acknowledgement: We sincerely thank Adrian Coad, SKAT, CH-St.Gallen for reviewing the text.

Information on the Kyrgyz-Swiss Dairy Programm: Intercooperation, Maulbeerstrasse 10, CH-3001 Bern





## List of Participants

Surname, Titel	First Name	Country	Organisation	E-Mail	Street	Postcode / City	Telephone	Fax
Agarwal	Anil	India	Centre for Science and Environment	anil@cseindia.org	41, Tughlakabad Institutional Area	New Delhi, 110062	+91-11 6095778	+91-11 6080870
Austin	L.M.	South Africa	CSIR Building and Construction Technology	laustin@csir.co.za	PO Box 395	Pretoria 0001	+27-12 8413871	+27-12 8413400
Backes	Katharina	Germany	RESOB-Ingenieurgesellschaft	katharina_backes@gmx.de	Beckhauser Str. 16 C	40699 Erkrath	+49-2104 9456 14	+49-2104 945629
Backlund	Arne	Denmark	A&B Backlund ApS	backlund@backlund.dk	Ordstrupvej 101	2920 Charlottenlund	+45-39633364	+45-39636455
Bahlo	Klaus	Germany	Ingenieurbüro AWA	ingenieurbuero-awa@t-online.de	Gertenstr. 36	29526 Uelzen	+49-581 30733	+49-581 30735
Bark	Kerstin	Netherlands	Consultant	KerstinBark@csi.com	Keizersgracht 495 H	1017 DM Amsterdam	+31-20 6220857	+31-20 6220857
Behnke	Stefan	Germany	Roediger Vakuum- und Haustechnik GmbH	vhtbeh@roediger-hu.de	Kinzigheimer Weg 104-106	63450 Hanau	+49-6181 309293	+49-6181 309277
Beier	Christoph	Germany	GTZ	christoph.beier@gtz.de		POBox 5180, 65726 Eschborn	+49-6196 791403	
Berger	Wolfgang	Germany	Berger Biotechnik GmbH	info@berger-biotechnik.de	Juliusstraße 27	22769 Hamburg	+49-40 4397875	+49-40 437848
Bichel	Ulrike	Germany	BMZ		Postfach 120322	53045 Bonn		
Biesinger	Brigitte	Germany	Consultant	berlin@denkmodell.de				
Bittner	Michael	Germany	AQUAMAR GmbH	mbittner@aquamar.de	Zöllner Str. 7	51491 Overath	+49-2204 972416	+49-2204 72966
Bolt	Eveline	Netherlands	International Water and Sanitation Centre	bolt@irc.nl	POBox 2869	CW Delft	+31-15 2192939	+31-15 2190955
Böning	Thomas	Germany	INFA	boening@infa.de	Beckumer Str. 36	59228 Ahlen	+49-2382 964500	+49-2382 964600
Braun	Ulrich	Germany	AK Wasser	u-braun@t-online.de	Guntramstr. 34	79106 Freiburg	+49-761 277896	+49-761 277869
Brown	Julia	Jamaica	Scientific Research Council	iwppm@cwjamaica.com	POBox 350, Hope Gardens	Kingston 6	+876-7024177	+876-9772194
Brühl	Hartmut	Germany	KfW	hartmut.bruehl@kfw.de	Palmengartenstraße 5-9	60325 Frankfurt	+49-69 7431 2402	+49-69 7431 2004
Brüll	Anja	Germany	IEES, OICOS e.V.	a.bruell@oicos.de	Knaackstr. 99	10435 Berlin	+49-30 44057979	
Bürgow	Grit	Germany	IEES, OICOS e.V.	g.burgow@oicos.de	Choriner Str. 8	10119 Berlin	+49-30 4492980	
Calvert	Paul	India / UK	Eco-Solutions	paulc@vsnl.com	UK: Shortley Close, Robin Hoods Bay, N. Yorkshire, YO22 4PB; India: Pulari, Asan Nagar, Vallakadavu, Trivandrum, 695008, Kerala		UK: +44-1947 880317 India: +91-471 502622	UK: +44-1947 880317 India: +91-471 502622
Cissoko	Bandia	Mali	Direction Nationale de l'Hydraulique			Bamako, BP 66	+223 - 21 2588 +223 - 21 4877	+223 21 8635
Correa	Nestor	Germany	Consultant	ncorrea@t-online.de	Grosse Barlinge 63	30171 Hannover	+49-511-800 7598	+49-511-800 7598
Dadie-Amoah	Kwasi	Germany	WAREM, Universität Stuttgart	kwasi@studserv.uni-stuttgart.de	Allmandring 10D 6	70569 Stuttgart	+49-711 6771162	+49-711 6856600
de Bruijne	Gert	Palestine	Palestinian Hydrology Group	zeidan@mail.palnet.com	POBox 219	Beit Jala	+972-2 2217030	+972-2 221731
Del Porto	David	USA	Sustainable Strategies and Affiliates	sustainable@aics.net, daviddelporto@ecological-engineering.com	50 Beharrell Street	Concord, Massachusetts USA 01742-2973	+1-978 3699440	+1-978 3692484
Detmer	Andrea	Germany	BMBF	andrea.detmer@bmbf.bund.de			+49-228 573837	+49-228 573601
Dockhorn	Thomas	Germany	Technische Universität Braunschweig	t.dockhorn@tu-bs.de	Pockelstr. 2a	38106 Braunschweig	+49-531 3917937	+49-531 3917947
Doetinchem	Jürgen	Germany	KfW	juergen.doetinchem@kfw.de	de Ridderstr. 8	61476 Kronberg	+49-69 74312192	+49-6173 68821
Dorau	Wolfgang	Germany	Umweltbundesamt	wolfgang.dorau@uba.de	Postfach 330022	1491 Berlin	+49-30 89034123	+49-30 89034152
Dorgeloh	Elmar	Germany	PIA-RWTH Aachen	dorgeloh@isa.rwth-aachen.de	Mies-van-der-Rohe-Str.1	52074 Aachen	+49-241 7508030	+49-241 7019802

Surname, Titel	First Name	Country	Organisation	E-Mail	Street	Postcode / City	Telephone	Fax
Dörner	Stefan	Germany	GKW Consult GmbH	doer@gkw.com	Besselstr. 26	68219 Mannheim	+49-621 8790350	+49-621 8790302
Drangert	Jan-Olof	Sweden	Linköping University	jandr@tema.liu.se	Tema V	581 83 Linköping	+46-0709 370179	+46-13 133630
Ehlers	Kay	Germany	IGIP Ingenieurgesellschaft mbH	lgip@igip.com	Dolivostr. 11	64293 Darmstadt	+49-6151 300528	+49-6151 300521
Eid	Uschi	Germany	BMZ	eid@bmz.bund.de	Postfach 120322	53045 Bonn		
Eiling	Martin	Germany	GOPA Consultants GmbH	martin.eiling@gopa.de	Hindenburggring 18	61348 Bad Homburg	+49-172 930214	+49-172 930200
Elles	Anselm	Germany	AFC Consultants International GmbH	elles-a@consultants-bonn.de	Ubierstrasse 78	53173 Bonn	+49-228 985790	+49-228 691446
Enders	Reiner	Germany	Technische Universität Berlin	enders@itu201.ut.tu-berlin.de	Straße des 17. Juni 135	10623 Berlin	+49-30 31421299	+49-30 31423313
Esrey	Steven	USA	UNICEF	sesrey@unicef.org	3 UN Plaza	New York, N.Y. 10017	+1-212 8246349	+1-212 8246465
Etnier	Carl	Norway	Agricultural University of Norway	carl.etnier@itf.nlh.no		Box 5065, 1432 Aas	+47-64948666	+47-64948810
Euler	Hartlieb	Germany	TBW GmbH	tbw@pop-frankfurt.com	Baumweg 10	60316 Frankfurt	+49-69 9435070	+49-69 94350711
Föllner	Steffen	Germany		steffen.foellner@snaflu.de				
Förch	Gerd	Ethiopia	RODECO Consulting GmbH	gerd.forch@telecom.net.et	POBox 3066	Addis Ababa	+251-1 154035	+251-1 513830
Forde	Lester	Trinidad - West Indies	Water For The People	lhforde@tstt.net.tt	19 Bates Trace	Santa Margarita, St. Augustine	+868-6632697 +868-6833743	+868-6276697
Franke	Asdrig	Germany		franke.aquasolar@snaflu.de	Wernshauser Str. 0	12248 Berlin	+49-30 7112110	
Franke	Christian	Germany	Consultant	franke.aquasolar@snaflu.de	Wernshauser Str. 1	12249 Berlin	+49-30 7112111	
Franken	Gudrun	Germany	Federal Institute for Geoscience and Natural Resources	gudrun.franken@bgr.de	Stilleweg 2	30655 Hannover	+49-511 6432370	+49-511 6433661
Fuhrmann	Tim	Germany	Universität Witten/Herdecke	prof.rudolph@t-online.de	Alfred-Herhausen-Str. 44	58455 Witten	+49-2302 914010	+49-2302 9140111
Geller	Gunther	Germany	IÖV	info@ioev.de	Alpenstraße 13	86159 Augsburg	+49-821 575165	+49-821 582472
Gold	Margret	Germany	GTZ	margret.gold@gtz.de	Postfach 5180	65726 Eschborn	+49-6196 791261	+49-6196 796105
Gomer	Dieter	Algeria	GTZ	eau_dz@algeriainfo.com	37, Route Nat. Nr. 11	Programme Eau Algerie, Ain-Benian	+213-2303091	+213-2302977
Gottschalk	Uta	Germany	GTZ	uta.gottschalk@gtz.de	POBox 5180	65726 Eschborn	+49-6196 793084	+49-6196 797352
Grangler	Andreas	Germany	Technische Universität Berlin	grangler@itu106.ut-berlin.de	Straße des 17. Juni 135	10623 Berlin	+49-30 31 479623	+49-30 31 423850
Guhr	Ingo	Lao P.D.R.	UNDP / NORAD	ingo@loxinfo.co.th	POBox 3180	Vientiane, Lao P.D.R.	+858-21313030	+858-21313030
Guterstam	Björn	Sweden	Global Water Partnership	bjorn.guterstam@sida.se		10525 Stockholm	+46-8 6985581	+46-1 6985627
Hagen	Christian	Germany	GTZ	christian.hagen@gtz.de	POBox 5180	65726 Eschborn	+49-6196 791441	
Hailer	Josef	Germany	Gesellschaft für Wassertechnik und Apparatebau GmbH	hailer@kg-ulm.de	Geishaldenweg 11	73262 Reichenbach	+49-731 1534227	+49-731 1534263
Hartung	Hans	Germany	FAKT	hfhartung@cs.com	Kanalstrasse 23	97990 Weikersheim	+49-7934 990030	+49-7934 990031
Heeb	Johannes	Switzerland	seecon GmbH International Ecological Engineering Society	heebjohannes@pingnet.ch	Bahnhofstr.2	6110 Wolhusen	+41-41 4904081	+41-41 4904074
Heider	Carola	Belgium	European Commission	andre.liebaert@cec.eu.int	c/o Liebaert, EC-DG Development DEV/A/3, 200 rue de la Loi	1049 Brussels	+32-2 2950488	+32-2 2990603
Helming	Stefan	Germany	GTZ	stefan.helming@gtz.de	POBox 5180	65726 Eschborn	+49-6196 791274	+49-6196 796105
Herbst	Brendan	Germany	Bundesverband der Deutschen Kalkindustrie e. V.	uws@kalk.de	Annstr. 67 - 71	50968 Köln	+49-221 93467445	+49-221 93467414
Herbst	Heinrich	Germany	ISA-RWTH Aachen	herbst@isa.rwth-aachen.de	Mies-van-der-Rohe-Str.1	52074 Aachen	+49-241 805212	+49-241 870924
Hiessl	Harald	Germany	Fraunhofer-Institut	hh@isi.fhg.de	Breslauer Str. 48	76139 Karlsruhe	+49-721 6809115	+49-721 689152

Surname, Titel	First Name	Country	Organisation	E-Mail	Street	Postcode / City	Telephone	Fax
Hildebrandt	Anke	Germany	GTZ	hildebrandt@ihw.baug.ethz.ch	Postfach 5180	65726 Eschborn	+49-6196 791261	+49-6196 796105
Hobus	Inka	Germany	Technische Universität Berlin	inka.hobus@iee.tu-berlin.de	Straße des 17. Juni	10623 Berlin	+49-30 31424543	+49-30 31425298
Holder	Gabriele	Germany	RODECO Consulting GmbH	rodeco@CompuServe.com	Ferdinandstr. 17A	61348 Bad-Homburg	+49-6172 20503	+49-6172 25748
Holländer	Robert	Germany	BMU	hollaender.robert@bmu.de	Postfach 12 06 29	53048 Bonn	+49-228 3052533	+49-228 3052396
Hulshoff Pol	Look	Netherlands	Wageningen University	look.hulshoff-pol@algemeen.mt.wau.nl	POBox 8129	6700 Wageningen	+31-317 484278	+31-317 482108
Ingvar-Nilsson	Sven	Sweden	WM-Ekologen AB	info@wost-man-ecology.se	Kobonäs	52293 Tidaholm	+46-502 10333	+46-502 10333
Ishizaki	Katsuyoshi	Japan	Nagasaki University	isizaki2@net.nagasaki-u.ac.jp	1-14 Bunkyo-Machi	Nagasaki, 852-8521	+81-95 8431808	+81-95 8431808
Jaiteh	Lamin	Gambia	Berger Biotechnik GmbH	info@berger-biotechnik.de	Juliusstraße 27	22769 Hamburg	+49-40 4397875	+49-40 437848
Jaspert	Jens	Germany						
Jendrischewski	Wolfgang	Germany	Gitec Consult GmbH	water@gitec-consult.de	Bongardstr. 13	40479 Düsseldorf	+49-211 4408137	+49-211 4408204
Jesuthasan	G.	Sri Lanka	National Water Supply & Drainage Board	tr.wb@scienceland.lk	823 Hospital Rd.	Jaffna	+21-2397	
Jung	Dirk	Germany	Denkmodell	berlin@denkmodell.de	Mariannenplatz 23	10997 Berlin	+49-30 6904880	+49-30 6904889
Junge-Berberovic	Ranka	Switzerland	University of Applied Sciences Wädenswil	r.junge@hswzfh.ch	Grüntal 40	8820 Wädenswil	+41-1 7899922	+41-1 7899950
Kalbermatten	John	USA	Kalbermatten Associates, Inc.	jmkkainc@aol.com	3630 Garfield Street N.W.	Washington D.C. 20007-1443	+1-202 3378043	+1-202 3378043
Kalbessa	Ayana	Ethiopia	Water, Mines & Energy Bureau	gerd.forch@telecom.net.et	POBox 3066	Addis Ababa	+251-1 150435	+251-1 513830
Karl	Volker	Germany	KfW	volker.karl@kfw.de	Palmengartenstr. 5-9	60325 Frankfurt	+49-69 74312911	+49-69 74312004
Karunalingam	V.	Sri Lanka	National Water Supply & Drainage Board	tr.wb@scienceland.lk	88 Wadya Rd.			+21-2269
Kazner	Christian	Germany	Dr. Dahlem Consulting Engineers	c.kazner@drdahlem.de	Bonsiepen 7	45136 Essen	+49-201 8967180	+49-201 8967123
Kebekus	Frauke	Germany	Hamburger Stadt-entwässerung	frauke.kebekus@hhse.de	Banksstr. 6	20097 Hamburg	+49-40 34985022	+49-40 34985009
Keil	Ulrich	Germany	STEAG Energie- und Kerntechnik GmbH	ulrich.keil@STEAG.de	Rüttscheiderstr. 1-3	45128 Essen	+49-201 8016223	+49-201 8011415
Keipp	Waltraud	Mali	GTZ	gtzkoulikoro@afribone.net.ml	B.P. 100	Bamako	+223-262233	+223-233805
Kerpen	Jutta	Germany	Consultant	kerpenatrott@t-online.de	Obere Hainstr. 19	61440 Oberursel	+49-6171 3934	+49-6171 3934
Kionka	Tom	Germany	Umweltmagazin	umweltmagazin@vogel-medien.de	Max-Planck-Str. 7/9	97082 Würzburg	+49-931 4182631	+49-931 4182750
Kishor Mishra	Nawal	Nepal	Department of Water Supply and Sewerage	nkm@mos.com.np	Panipokhari, Maharajgnj	Kathmandu		
Knapp	Andreas	Austria	Institute for Water Provision - BOKU	knapp@iwga-sig.boku.ac.at	Muthgasse 18	1190 Vienna	+43-1 360065806	+43-1 3689949
Koch	Petra	Germany	GTZ	petra.koch@gtz.de	Postfach 5180	65726 Eschborn	+49-6196 791261	+49-6196 796105
Koch	Rolf	Germany	Lahmeyer International GmbH	gwrko@lif.de	Friedberger Str. 173	61118 Bad Vilbel	06101-55 1274	06101-55 2319
Konukiewitz	Manfred	Germany	BMZ	konukiew@bmz.bund.de	Postfach 120322	53045 Bonn	+49-1888 5353783	+49-1888 5354783
Kraft	Harald	Germany	Ingenieurbüro Kraft	kraft@ib-kraft.de	Schmiljanstr. 7	12161 Berlin	+49-30 8516616	+49-30 8522395
Krämer	Pedro	Germany	TBW GmbH	tbw@pop-frankfurt.com	Baumweg 10	60316 Frankfurt	+49-69 9435070	+49-69 94350711
Kresse	Klaus	Costa Rica						+506-268 41 86
Kroh	Wolfgang	Germany	KfW	wolfgang.kroh@kfw.de	Postfach 111141	60046 Frankfurt	+49-69 7431 2370	+49-69 74314206
Kunz	Peter	Germany	University of Applied Sciences Mannheim	pmkunz@gmx.de	Windeckstr. 110	68163 Mannheim	+49-621 2926304	+49-621 2926470
Le Jallé	Christophe	France	Programme Solidarité Eau	le-jalle@pseau.org	32, rue Le Peletier	75009 Paris	+33-1 533491 24	+33-1 533491 21

Surname, Titel	First Name	Country	Organisation	E-Mail	Street	Postcode / City	Telephone	Fax
Lehn	Helmut	Germany	Center for Technology Assessment	helmut.lehn@ta-akademie.de	Industriestr. 5	70565 Stuttgart	+49-711 9063132	+49-711 9063299
Lopez Zavala	Miguel Angel	Japan	Hokkaido University	lozm@eng.hokudai.ac.jp	Kita-8, Nishi-13, Kita-ku	Sapporo 060-8628	+81-11 7066273	+81-11 7067890
Ludwig	Jutta	Germany	Wuppertal Institute for Climate, Environment and Energy	ludwig.tiddens@t-online.de	Elbinger Str. 16	50997 Köln	+49-2233 280986	+49-2233 21073
Mahal	Siegbert	Germany	Interessengemeinschaft Dezentrale Abwasserentsorgung	IDA-BV@t-online.de	Wiershausen 1	37589 Wiershausen	+49-5553 91266	+49-5553 91277
Makinson	Sandra	Germany	International Council for Local Environmental Initiatives	smakinson@iclei.org	Eschholzstr. 86	79115 Freiburg	+49-175 6533435	+49-761 3922992
Martin	Nicola	Germany	Federal Institute for Geoscience and Natural Resources	n.martin@bgr.de	Stilleweg 2	30655 Hannover	+49-511 6432402	+49-511 6433662
Matz	Manfred	Mali	GTZ	manfred.matz@afribone.net.ml	POBox 100	Bamako	+223-214877	+223-229269
Meierjohann	Reinhard	Germany	Consultant	Reinhard.Meierjohann@t-online.de	Eupener Straße 343	52076 Aachen	+49-241 61311	+49-241 61311
Meyer-Robben	Raimund	Germany	Bremen Entsorgungsbetriebe	meyer-robben@t-online.de; meyer_r@bremereb.de	Schiffbauweg 22	28237 Bremen	+49-173 9394306 +49-421 36114098	+49-421 6209637
Müller	Armin	Germany	Fa. Armin Müller	fa.a.mueller@t-online.de	Rödeweg 10	97783 Karsbach	+49-9358 1217	+49-9358 1537
Munyati	Alex	Zambia	Southern Water & Sewerage Company	munyati@zamnet.zm	POBox 630617	Choma	+260-32 20239	+260-32 20245
Musara	Cleophas	Zimbabwe	Mvuramanzi Trust	237613@ecoweb.co.zw	No. 2 Mansfield Rd; POBox MR 103	Marlborough, Harare	+263-4 309246/300511	+263-4 309246/300511
Neis	Uwe	Germany	Technische Universität Hamburg-Harburg	neis@tu-harburg.de	Eißendorfer Str. 42	21073 Hamburg	+49-40 428783207	+49-40 428782684
Niemann	Ernst-Jürgen	Germany	DECON Deutsche Energie-Consul Ingenieurgesellschaft mbH	ernst.niemann@decon.de	Norsk-Data-Str. 1	61352 Bad Homburg	+49-6172-9460 122	+49-6172-9460 20
Oldenburg	Martin	Germany	Otterwasser GmbH	oldenburg@otterwasser.de	Engelsgrube 81	23552 Lübeck	+49-451 7020055	+49-451 7020052
O'Leary	Michael	Zambia	Southern Water & Sewerage Company	rodeco-mike@zamnet.zm	POBox 630617	Choma	+260-32 20579	+260-32 20569
Orth	Hermann	Germany	Ruhr-Universität Bochum	siwawi@ruhr-uni-bochum.de	Universitätsstr. 150	44801 Bochum	+49-234 3225891	+49-234 3214503
Otterpohl	Ralf	Germany	Technische Universität Hamburg-Harburg	otterpohl@tuhh.de	Eißendorfer Straße 42	21073 Hamburg	+49-40 428783207	+49-40 428782684
Owsianowski	Rolf-Peter	Senegal	GTZ	gtzcd@telecomplus.sn	BP 3869	Dakar	+221-8 220282	
Pabsch	J.	Germany	IPP Consult	ipp_hi@t-online.de		31139 Hildesheim	+49-5121 209411	+49-5121 209444
Pankert	Jean-Gérard	Germany	MISEREOR	pank@misereor.de	POBox 1450	52015 Aachen	+49-241 4420	+49-241 442188
Parikh	Himanshu	India	Himanshu Parikh Consulting Engineers	hhp@vsnl.com	2 Sukhshanti, near Ambawadi Circle	Ahmedabad 380 006	+91-79 6563590	+91-79 6440263
Peter-Fröhlich	Anton	Germany	Berliner Wasserbetriebe	anton_peter-froehlich@bwb.de				
Pitot	Hanns-André	Netherlands	EPAT	hapitot@yahoo.com	Vrijheidslaan 129	2806 KH Gouda	+31-182 518505	+31-182 518505
Plöthner	Dieter	Germany	BMZ	ploethne@bmz.bund.de	Postfach 120322	53045 Bonn	+49-228 5353764	+49-228 5354764
Rakelmann	Ulf	Germany	Hamburger Stadtentwässerung	ulf.rakelmann@hhse.de	Banksstr. 4-6	20097 Hamburg	+49-40-3498 5203	+49-40-3498 5299
Ratka	Richard	Germany	German Foundation for International Development	r_ratka@dse.de	Tulpenfeld 5	53113 Bonn	+49-228 2434610	+49-228 2434677
Renner-Häberle	Ylva	Germany	KfW	ylva.renner-haerberle@kfw.de	Palmengartenstraße 5-9	60325 Frankfurt	+49-69 74313614	

Surname, Titel	First Name	Country	Organisation	E-Mail	Street	Postcode / City	Telephone	Fax
Rettenberger	Armin	Germany	University of Applied Sciences Mannheim	a.rettenger@fh-mannheim.de	Windeckstr. 110	68163 Mannheim	+49-621 2926304	+49-621 2926470
Reuter	Stefan	Germany	BORDA e.V.	borda.bre@t-online.de reuter.borda.bre@t-online.de	Industriestr. 20	28199 Bremen	+49-421 13718	+49-421 1655323
Richards	Tony	Botswana	GTZ	tosh@info.bw		Private Bag X 12, Garbone	+267-311802	+267-300180
Rijnsburger	Jaap	Netherlands	WASTE	rijnsburger@waste.nl	Nieuwehaven 201	2801 CW Gouda	+31-182 522625	+31-182 550313
Rudolph	Karl-Ulrich	Germany	Prof. Dr. Dr. K.-U. Rudolph GmbH	prof.rudolph@t-online.de	Alfred-Herhausen-Str. 44	58455 Witten	+49-2302 914010	+49-2302 9140111
Salifu	Lukman	Kenya	Worldbank	lsalifu@worldbank.org	Hill Park Building, Upper Hill Rd.	POBox 30577, Nairobi	+254-2 260306	+254-2 260386
Schaeffer	Roland	Germany	Stadt Frankfurt am Main	thadden.schaeffer@t-online.de	Bismarckstr. 34	20259 Hamburg	+49-40 432726121	+49-40 43272622
Schäfer	Dirk	Germany	Universität Witten/Herdecke	prof.rudolph@t-online.de	Alfred-Herhausen-Str. 44	58455 Witten	+49-2302 914010	+49-2302 9140111
Schäfer	Hans-Joachim	Germany	Woltmann + Knoop GmbH	hajoschaefer@gmx.de	Gewerbestr. 11	29358 Ahnsbeck	+49-5145 988914	+49-5145 988924
Schattauer	Hans	Austria	Institute for Water Provision - BOKU	schattauer@iwga-sig.boku.ac.at	Muthgasse 18	1190 Vienna	+43-1 360065805	+43-1 3689949
Schertenleib	Roland	Switzerland	SANDEC / EAWAG	Schertenleib@eawag.ch	Überlandstr. 133	8600 Dübendorf	+41-1 8235018	+41-1 8235399
Schlegel	Michael	Germany	Lahmeyer International GmbH	gwmis@lif.de	Friedberger Str. 173	61118 Bad Vilbel	+49-6101 551332	+49-6101 552319
Schlick	Jana	Germany	Consultant / GTZ	jana.schlick@gmx.de				
Schmitz	Peter	Germany	Malteser Auslandsdienst	peter.schmitz@maltanet.de	Kalker Hauptstr. 22-24	51103 Köln	+49-221 9822157	+49-221 9822179
Schmoll	Oliver	Germany	Umweltbundesamt, WHO	oliver.schmoll@uba.de	Abt. II 4.3, Postfach 330022	14191 Berlin	+49-30 89031807	+49-30 89031830
Schneider	Anette	Germany	BMZ		Postfach 120322	53045 Bonn		
Schönborn	Andreas	Switzerland		aschoenborn@access.ch	Ruflibergstr. 21	6006 Luzern	+41-41 4221408	
Schönewald	Bernd	Germany	KfW	bernd.schoenewald@kfw.de	Palmengartenstraße 5-9	60325 Frankfurt	+49-69 74313851	+49-69 74313279
Schönfeld	Axel	Germany		Schoenfeld.Axel@gmx.de	Tambacher Str.14 B	12249 Berlin	+49-30 7751465	+49-30 7751465
Schroth	Susanne	Germany	TBW GmbH	tbw@pop-frankfurt.com	Baumweg 10	60316 Frankfurt	+49-69 9435070	+49-69 94350711
Sender	S.	Madagascar	GTZ	assmagtz@dts.mg	B.P. 713	Mahajanga 401	+261-206223897	+261-206223897
Sidibé	Souleymane	Mali	Direction Nationale de l'Hydraulique	ss.dnh@afribone.net.ml		Bamako, BP 66	+223-212055	+223-212055
Siebel	Michael	Germany	Dorsch Consult Ingenieurgesellschaft mbH	water@dorsch.de	Hansastraße 20	80686 München	+49-89 5797654	+49-89 5797802
Skinner	Brian	UK	Water, Engineering and Development Centre	b.h.skinner@lboro.ac.uk		Loughborough, Leicestershire, LE11 3TU	+44-1509222619	+44-1509211079
Specht	Gunnar	Germany	Planco Consulting GmbH	planco-hamburg@t-online.de	Hufnerstr. 28	22083 Hamburg	+49-40 2020080	+49-40 20200899
Sperling	Frank	Germany	Emschergerossenschaft / Lippeverband	fsperlin@eglv.de	Kronprinzenstr. 24	45128 Essen	+49-201 1042257	+49-201 1042800
Spies	Sandra	Germany	UTG Control	sandra.spies@utg-control.de	Lüpertzender Str. 6	41061 Mönchengladbach	+49-2161 9274535	+49-2161 9274404
Spitzer	Hanno	Germany	BMZ	spitzer@bmz.bund.de	Postfach 120322	53045 Bonn	+49-228 5353759 +49-177 6422695	+49-228 5353755
Sridhar	M. K. C.	Nigeria	University of Ibadan	mkcsridhar@skanet.com		Ibadan	+234-2 8106816	+234-2 8103043
Steinfeld	Carol	USA	Center for Ecological Pollution Prevention	ecop2@hotmail.com	POBox 1330	Concord, MA 01742 - 1330	+01-978 3187033	+01-978 3692484
Stenström	Thor Axel	Sweden	Swedish Institute for Infectious Disease Control	thor-axel.stenstrom@smi.ki.se; thor_axel@hotmail.com		17182 Solna	+46-8 4572469 +46-8 6124218 (priv.) +46-706476047 (mob.)	+46-8 301797
Stoll	Uwe	Germany	KfW	uwe.stoll@kfw.de	Palmengartenstraße 5-9	60325 Frankfurt	+49-69 74313852	+49-69 74312004

Surname, Titel	First Name	Country	Organisation	E-Mail	Street	Postcode / City	Telephone	Fax
Stracke	Rainer	Germany	Prof. Dr. Dr. K.-U. Rudolph GmbH	prof.rudolph@t-online.de	Alfred-Herhausen-Str. 44	58455 Witten	+49-2302 914010	+49-2302 9140111
Swetzer	Alexandra	Switzerland	Consultant	aswetzer@unog.ch	Palais des Nations, Bureau E4117, Avenue de la Paix	1211 Geneve 10	+41-765422505	
Tentscher	Wolfgang	Germany	Fachverband Biogas e. V.	wtentscher@aol.com	Karl-Stieler-Str. 3	12167 Berlin	+49-30 79780447	+49-30 79780448
Thomas	Percival	Australia	La Trobe University	pthomas@aw.latrobe.edu.au	Parkers Rd; P.O.Box 821	Wodonga, Victoria 3689	+61 2 60583871	+61 2 60583888
Thomas	Peter	Germany	HATI	thomas@hati.de	Oranienstr. 18	10999 Berlin	+49-30-6149090	+49-30-61609981
Toussaint	Dominik	Germany	Fraunhofer-Institut	dt@isi.fhg.de	Breslauer Straße 48	75139 Karlsruhe	+49-721 6809110	+49-721689152
Tränkle	Josef	Thailand	Asian Institute of Technology	trankler@ait.ac.th	POBox 4	Koh Luang, Pathumthani 12120	+66-2 5245632	+66-2 5245552
Trösch	Walter	Germany	Fraunhofer Institut	troe@igb.fhg.de	Nobelstr. 12	70569 Stuttgart	+49-711 9704220	+49-711 9704200
Vasudevan	N.	India	Anna University	nvasu30@yahoo.com		Centre for Environmental Studies, Anna University	+91-44 2354717	+91-44 2354717
Vest	Heino	Germany	Internationale Technologieberatung Dr. Vest	h.vest@t-online.de	In den Eichen 8	51597 Morsbach	+49-2294 90713	+49-229 991500
Vida	Jochen	Germany	DECON Deutsche Energie-Consult Ingenieurgesellschaft mbH	j.vida@decon.de	Norsk-Data-Str. 1	61352 Bad Homburg	+49-6172 9460107	+49-6172 946020
Wegelin-Schuringa	Madeleen	Netherlands	International Water and Sanitation Centre	wegelin@irc.nl	POBox 2869	CW Delft	+31-15 2192939	+31-15 2190955
Wehrle	Karl	Switzerland	SKAT	karl.wehrle@skat.ch	Vadianstr. 42	9000 St. Gallen	+41-71 2285455	+41-71 2285455
Weistroffer	Klaus	Germany	GTZ	Klaus.Weistroffer@gtz.de	POBox 5180	65726 Eschborn	+49-6196 791262	+49-6196 796105
Welschhof	Jürgen	Germany	KfW	juergen.welschhof@kfw.de	Palmengartenstraße 5-9	60325 Frankfurt	+49-69 74312640	+49-69 74313279
Wendland	Arnd	Germany	Hamburger Stadtentwässerung	arnd.wendland@hhse.de	Banksstr. 4-6	20097 Hamburg	+49-40 34985476	+49-40 34985402
Werchota	Roland	Zambia	GTZ	gtzwater@zamnet.zm	Private Bag RW 37X ZA 15102 Ridgeway	Lusaka	+260-1 229281	+260-1 226942 +260-1 291946
Werner	Christine	Germany	GTZ	christine.werner@gtz.de	Postfach 5180	65726 Eschborn	+49-6196 791261	+49-6196 796105
Wesenberg	Rainer	Germany	MISEREOOR, AGEH	rawero.besigheim@t-online.de	Eberhard-Frohn-mayer-Str. 18	74354 Besigheim	+49-7143 9817800	+49-7143 9817800
Winblad	Uno	Sweden	WKAB	uno.win@wkab.se	Heleneborgsgatan 52	11732 Stockholm	+46-8 6696942	+46-8 6696942
Windberg	Constanze	Germany	Technische Universität Hamburg-Harburg	windberg@tu-harburg.de	Gefionstr. 24	22769 Hamburg	+49-172 6957996	+49-40 859507
Witte	Gernot	Germany	GTZ	gernotwitte@gmx.de	Osterstr. 89 B	20259 Hamburg	+49-40 4905113	
Wyss	Philippe	Switzerland	University of Applied Sciences Wädenswil	p.wyss@hswzfh.ch	Postfach 335	8820 Zürich	+41-1 7899929	+41-1 7899950
Zang		Germany	Roediger Vakuum- und Haustechnik GmbH	vhtbeh@roediger-hu.de	Kinzigheimer Weg 104-106	63450 Hanau	+49-6181 309293	+49-6181 309277
Züst	Brigitta	Switzerland	Centre for Applied Ecology Schattweid	zuest@schattweid.ch		6114 Steinhusen-berg	+41-41 4901793	+41-41 4904075