

DOCUMENT RESUME

ED 310 083

SP 031 376

AUTHOR Ryan, Jean Rogers
TITLE Tools for Teaching. A Visual Aids Workshop and Instruction Manual for Health Educators. Appropriate Technologies for Development. Reprint Series No. R-67.
INSTITUTION Peace Corps, Washington, DC. Information Collection and Exchange Div.
PUB DATE Feb 87
NOTE 238p.
PUB TYPE Guides - Classroom Use - Guides (For Teachers) (052)
EDRS PRICE MF01/PC10 Plus Postage.
DESCRIPTORS Developing Nations; Foreign Countries; *Health Education; Learning Strategies; *Material Development; *Primary Health Care; *Teacher Developed Materials; *Visual Aids

ABSTRACT

This manual was developed to train primary health care facilitators and health educators in the construction and use of low-cost supplementary learning materials that are both socially relevant and participatory in nature. The curriculum is organized to provide the facilitator with a course outline and syllabus, suggested list of supplies, comprehensive lesson plans, supporting visual material and instructional handouts, project evaluation sheets, and a take-home examination. Each lesson plan includes the following components: (1) purpose; (2) objectives; (3) materials needed; (4) preparation instructions; (5) activity sequence, including estimated time for each activity; and (6) step-by-step outline for each activity. Supplementary materials are located immediately following the introductory page of the session in which they are to be used. The manual is designed to be used in staff development workshops for health facilitators working primarily in developing countries.

(JD)

* Reproductions supplied by EDRS are the best that can be made *
* from the original document. *

ED310083

Tools For Teaching

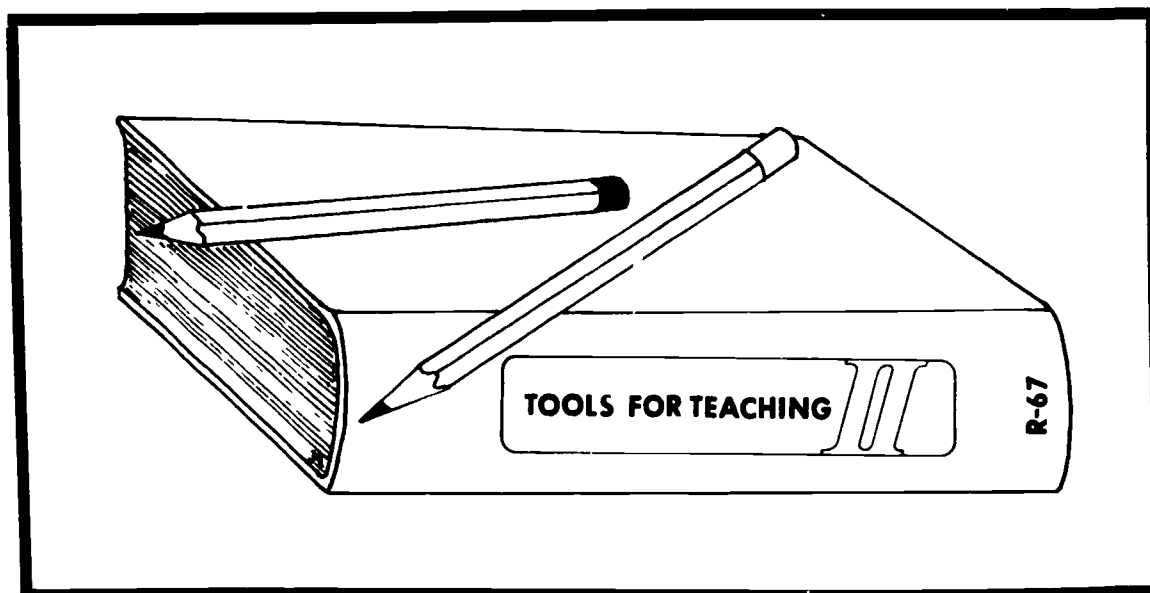

U S DEPARTMENT OF EDUCATION
Office of Educational Research and Improvement
EDUCATIONAL RESOURCES INFORMATION
CENTER (ERIC)

- This document has been reproduced as received from the person or organization originating it.
- Minor changes have been made to improve reproduction quality.
- Points of view or opinions stated in this document do not necessarily represent official OERI position or policy.

Peace Corps

INFORMATION COLLECTION & EXCHANGE

REPRINT SERIES NO. R-67

BEST COPY AVAILABLE

SFO 1576

INFORMATION COLLECTION & EXCHANGE

Peace Corps' Information Collection & Exchange (ICE) was established so that the strategies and technologies developed by Peace Corps Volunteers, their co-workers, and their counterparts could be made available to the wide range of development organizations and individual workers who might find them useful. Training guides, curricula, lesson plans, project reports, manuals and other Peace Corps-generated materials developed in the field are collected and reviewed. Some are reprinted "as is"; others provide a source of field based information for the production of manuals or for research in particular program areas. Materials that you submit to the Information Collection & Exchange thus become part of the Peace Corps' larger contribution to development.

Information about ICE publications and services is available through:

Peace Corps
Information Collection & Exchange
Office of Training and Program Support
806 Connecticut Avenue, N.W.
Washington, D.C. 20526



Add your experience to the ICE Resource Center. Send materials that you've prepared so that we can share them with others working in the development field. Your technical insights serve as the basis for the generation of ICE manuals, reprints and resource packets, and also ensure that ICE is providing the most updated, innovative problem-solving techniques and information available to you and your fellow development workers.

Peace Corps

TOOLS FOR TEACHING

**A VISUAL AIDS WORKSHOP,
AND INSTRUCTION MANUAL
FOR HEALTH EDUCATORS**

**JEAN ROGERS RYAN
U.S. PEACE CORPS
PHILIPPINES**



Reprinted By:

PEACE CORPS
Information Collection and
Exchange
September 1987

Published in Manila
with funds donated by
the Royal Netherlands Embassy
February 1987

5

Para sa mga taga-Zambales.

This manual was developed in recognition of the importance of educational tools and materials to make communication and transfer of knowledge most effective. Educational experts are of the consensus that there is no single best method to influence favorably people's health knowledge, habits, and attitudes. This requires the use of various approaches and techniques with properly selected educational tools such as visual aids to make the educational efforts participatory rather than the traditional passive transaction.

The realization of the manual was derived from a series of workshops as part of the growing demand for appropriate teaching and learning materials for different levels of frontline workers to accelerate Primary Health Care as a key to attain health for all. It is hoped that this curriculum will serve as a valuable source of reference, a useful tool in different frameworks and combinations to help the users develop appropriate teaching materials adaptable to local needs.

Alicia G. Clemente
Health Education Advisor
Ministry of Health
Region III

From the very beginning, the Visual Aids Workshop has been a cooperative venture. Its success has been due in large part to the unfailing faith, encouragement, and support given me by Dra. Arcelie de Guia-Llamado, Zambales' Assistant Provincial Health Officer in charge of Public Health, and Miss Alicia G. Clemente, Health Education Advisor for the Ministry of Health in Region III. The project was launched under the direction of Dr. Conrado C. Mariano, OIC of the Zambales Integrated Provincial Health Office until September 10, 1986, and continues under the direction of Dr. Bonifacio C. Punzalan, current OIC. I am deeply appreciative of the support offered me by both these gentlemen. Mrs. Aurora Alejandre Escusa, Provincial Health Educator and my counterpart in the Zambales Integrated Provincial Health Office, provided indispensable service in terms of negotiating schedules, purchasing supplies, and managing all the endless details that accompany setting up an extended workshop for the first time. Having actively participated as a learner in the first seminar, she also served as co-facilitator for the second ten-week session along with teacher par excellence Mrs. Gilda Danoco of President Ramon Magsaysay Memorial Hospital, another first session graduate. I would also like to acknowledge the always cheerful and dependable assistance with the silkscreening projects offered by Mr. Rey S. Ferrer, currently serving as Municipal Sanitary Inspector in San Marcelino.

A number of people have contributed to the reality of the completed curriculum and instruction manual. In particular I would like to thank Maja Cubarrubia, U.S. Peace Corps/Philippines, for authorizing support of the first draft. Thanks are also due to Waite Maclin, training director for U.S. Peace Corps/Philippines, for reading and commenting on the manuscript, and to Dave Wilder, editor of Salaysayan during 1986, for his thoughtful suggestions as well as for editing and proofreading the final draft. Portions of the material presented in the three instruction manuals that accompany the lesson plans have been adapted from Helping Health Workers Learn by David Werner and Bill Bower (Palo Alto: Hesperian Foundation 1982) and from Bridging the Gap: A Participatory Approach to Health and Nutrition Education (Westport, Connecticut: Save the Children 1982) and is so noted in the text. I am deeply indebted to both of these fine publications. Finally, I would like to express my most sincere appreciation to the Royal Netherlands Embassy in Manila for contributing the publication funds.

Jean Rogers Ryan
Iba, Zambales

TABLE OF CONTENTS

Preface	iv
Acknowledgements	v
Introduction	1
Course Outline	5
Syllabus	8
Suggested List of Supplies	11
Workshop Record Sheet	12
Session 1. Introduction to the Visual Aids Workshop	13
1.1 Orientation to Class Structure & Methods	149
1.2 Types of Visual Aids: A Survey	151
1.3 Media & Techniques: An Overview	152
1.4 Design Considerations	153
1.5 The Design Process	153
1.6 Project Assignments	156
1.7 Master Plan	157
1.8 Homework Assignment: Idea Generation	158
Session 2. Project #1: Planning Session	159
2.1 Design Principles: Review	160
2.2 The Design Process: Review	160
2.3 Design Development: Brainstorming & Evaluation	161
2.4 Design Development: Sketches/Storyboards/Scripts	161
2.5 Homework Assignment: Initial Design Completion	162
Session 3. Project #1: Design & Production	163
3.1 Project #1: Preliminary Critique & Discussion	167
3.2 Project #1: Design Modification	167
3.3 Project #1: Finished Artwork	168
3.4 Homework Assignment: Pretest Project #1	168
Session 4. Project #2: Design Development	170
4.1 Project #1: Pretest Reports	171
4.2 Project #2: Brainstorming & Evaluation	171
4.3 Project #2: Sketches/Storyboards/Scripts	172
4.4 Homework Assignment: Design Completion	172
Session 5. Project #2: Design & Production	173
5.1 Project #1: Final Evaluation	174
5.2 Project #2: Preliminary Critique & Discussion	174
5.3 Project #2: Design Modification	174
5.4 Project #2: Finished Artwork	175
5.5 Homework Assignment: Pretest Project #2	175
Session 6. Project #3: Design Development	176
6.1 Project #2: Pretest Reports	177
6.2 Project #3: Brainstorming & Evaluation	177
6.3 Project #3: Sletches/Storyboards/Scripts	178
6.4 Homework Assignment: Design Completion	178

Session 7.	Project #3: Design/Project #4: Planning	179
7.1	Project #2: Final Evaluation	203
7.2	Project #3: Preliminary Critique & Discussion	203
7.3	Project #3: Design Modification	203
7.4	Review: Poster Design Considerations	204
7.5	Project #4: Brainstorming & Evaluation	205
7.6	Project #4: Idea Selection	205
7.7	Homework Assignment	206
Session 8.	Project #4: Preparation	207
8.1	Project #3: Pretest Reports	208
8.2	Silkscreen Preparation	208
8.3	Keyline Pattern & Color Separations	209
8.4	Homework Assignment: Stencil Cutting	209
Session 9.	Project #4: Production & Printing	210
9.1	Project #3: Final Evaluation	215
9.2	Project #4: Adhering the Stencil	215
9.3	Printing the Poster	215
9.4	Clean-up	216
9.5	Homework Assignment: Workshop Evaluation	216
Session 10.	Workshop Completion	218
10.1	Project #4: Completion	221
10.2	Clean-up	221
10.3	Take-Home Examination: Review & Correction	221
10.4	Wind-Up Activities	226
Workshop Follow-Up	227

Supplementary Learning Materials

1.1.1	Learning Chart (illustration)	15
1.1.2	The Blind Men & the Elephant (story)	16
1.1.3	The Blind Men & the Elephant (illustration)	17
1.1.4	Double Arrows (illustration)	18
1.1.5	Faces/Vase Ambiguity (illustration)	19
1.4.1	Principles of Communication Design (handout)	21
1.8.1	Making & Using Visual Aids (handout)	51
3.4.1	Evaluation Form (handout)	165
7.7.1	A Silkscreen Manual (handout)	181
9.5.1	Take-Home Examination (handout)	211
9.5.2	Action Plan (handout)	213
10.4.1	Certificate of Completion (handout)	219

In January 1986, the Integrated Provincial Health Office in Iba, Zambales asked me to teach a continuing staff development seminar on visual aids. In response to this request, a workshop was designed to train primary health care facilitators and health educators from throughout the province in the construction and use of low-cost supplementary learning materials that would be both socially relevant and participatory in nature. Presentation strategies were included as an integral part of the curriculum in order to support the goal of responsible primary health care education which seeks to promote individual and social awareness leading to active grassroots involvement. Indeed, visual aids can never be an end in themselves. By definition, they are a means to an end, tools to stimulate people's powers of observation and reason, unequivocal prerequisites for responsible decision-making and self-reliance.

In addition to providing technical skills, an opportunity to explore the creative process, and practice in participatory presentation strategies, we also wanted to conduct the workshop in such a way that the initial participants would be capable of transferring their newly acquired knowledge to other members of the primary health care team through repetition of the original workshop at periodic intervals. With the knowledge, then, that we tend to teach as we have been taught, lectures were eschewed in favor of an experiential, participatory approach. Thus, both the form and the content of the workshop are rooted in the truism that we generally forget what we hear, remember what we see, know what we do, and use what we discover for ourselves. The most profitable learning takes place when all of our senses are engaged in the process.

Three major benefits were realized at the conclusion of the seminar and a fourth emerged soon thereafter. First, a number of health professionals from throughout the province of Zambales acquired sufficient technical skills to enable them to create a wide variety of low-cost visual aids in support of health education at the local level. Second, several of these same individuals were able to transcend an educational tradition characterized by the closed triadic system of authoritative lecture/passive audience/rote memorization to become proficient in open-ended, participatory teaching strategies and evaluation techniques. The third benefit was realized in terms of tangible assets: projects created during the workshop have become the core of an expandable supply of visual aids available for use by all primary health care personnel in the province. In addition, each district has a minimal set of tools and supplies (T-square, triangle, exacto knife, marking pens, silkscreen, squeegee, etc.) to enable them to construct future projects as required. Finally, our hope that the first group of participants would be able to replicate the workshop successfully was proven in practice. Five

months after the first seminar was completed, it was repeated on the district level with two first session "graduates" serving as co-facilitators.

The curriculum presented here has evolved out of these two continuing staff development workshops. All the lesson plans have been tested and revised as necessary. The original eight-week training schedule was lengthened in the second workshop to ten weeks in order to provide a more realistic time frame for the completion, testing, and subsequent modification of each project. The primary emphasis throughout the workshop is on the design of supplementary learning materials that will both support and enhance the educational message. Equal attention, however, is directed toward the development of accompanying presentation strategies that will motivate the audience to think things through and discover solutions for themselves.

There is, additionally, a strong evaluative component built in to the lesson plans. It is operative not only in terms of the classroom critiques and community field tests for individual projects, but with respect to the workshop curriculum itself. Education at all levels is a dynamic process, an evolving dialogue between student and teacher. By working closely with participants during regularly scheduled sessions and by observing the community pretests, the facilitator should be able to get a fairly good idea of how well the concepts are getting across and how successfully they are being put into practice. S/he should feel free to adapt, revise, or add to the lesson plans as needed to make sure that the seminar remains responsive to the specific needs and learning styles of the participants while still realizing the course objectives.

The take-home examination which workshop members are asked to complete during the final week of the seminar also serves as a means of evaluation. It should be made clear to participants, however, that the purpose of the exam is not so much to test them (there are no grades given for the visual aids workshop) as it is to test how effectively the educational message was transmitted. The exam will also provide participants with a final opportunity to review the concepts and techniques they have learned. A lot of "performance pressure" will be eliminated if participants are told that there is no need to sign the examination. For the purposes of evaluating the workshop, it is not necessary to know who knows what, but whether or not the majority of the class understands the material.

Finally, participants are asked to submit, anonymously, a subjective review of the seminar: its strengths and weaknesses, whether they consider it to have been a fruitful educational experience, how it might be improved, etc. The wise and sensitive facilitator will then use these sources to plan subsequent workshops and modify the curriculum accordingly.

As presented here, TOOLS FOR TEACHING is both a workshop curriculum and an instruction manual. The curriculum includes ten 3-hour lesson plans designed to be presented once a week for ten consecutive weeks. The time lapse between sessions is necessary to ensure that workshop participants have sufficient opportunity to complete each homework-assignment before the next meeting. Three major instructional manuals (Principles of Communication Design, Making & Using Visual Aids, and A Silkscreen Manual) are incorporated into the appropriate lesson plans as handouts to be reproduced and distributed to each workshop participant.

The curriculum has been organized to provide the facilitator with a course outline and syllabus, suggested list of supplies, comprehensive lesson plans, supporting visual material and instructional handouts, project evaluation sheets, and a take-home examination. An action plan form to be filled out by participants at the end of the workshop and a record sheet for optional use by the facilitator are also included along with a sample certificate of completion.

Each lesson plan includes the following components:

1. purpose
2. objectives
3. materials needed
4. preparation instructions
5. activity sequence, including estimated time for each activity
6. step-by-step outline for each activity

Each page is clearly marked with the session number and the activity number in the upper right corner. All supplementary learning material is similarly numbered to correspond to the activity for which each item is intended. These supplementary materials are located immediately following the introductory page of the session in which they are to be used.

Before beginning the workshop, it will be necessary to do the following things:

1. Read the complete curriculum carefully to familiarize yourself with the content and method of presentation.
2. Photocopy the course outline and syllabus. Authorization to conduct the workshop is standard operating procedure in the Philippines (so that you can purchase supplies, be eligible for travel reimbursement, etc.). Both the course outline and syllabus are presented in a form acceptable to the Ministry of Health. Make sufficient copies of each to submit to the appropriate MOH officials through channel. Be sure to fill in the required course-specific data on the course outline (Item VII, Operating Details: date/time, venue, instructor's name; and Item IX, Materials and Supplies: how will these be funded?)
3. Arrange for a place to conduct the workshop. The room should be large and well-lighted. You will need three or

four good-size work tables, a chair for each participant, storage facilities for supplies, and a convenient source of running water.

4. Prepare canvass sheets following the suggested list of supplies.
5. Purchase all necessary supplies before the workshop begins so that you won't be caught short once the sessions are in progress.
6. Prepare supplementary learning materials and reproduce handouts for Session 1.

NOTE: You may prefer to reproduce and collate all the workshop handouts at one time, filing them in separate folders labeled with the appropriate session number. Store these folders along with the art supplies for use as needed.

The success of this visual aids workshop rests clearly in the hands of the facilitator. The extent of its effectiveness will be a direct result of the facilitator's ability to avoid authoritative lectures in favor of role-modeling the participatory teaching strategies that are advocated in the curriculum. This does not mean that the facilitator relinquishes control. It means, rather, that s/he perceives the participants to be adults capable of assuming responsibility for their own learning because it is to their ultimate advantage to do so. The challenge lies in setting up the kind of positive, supportive atmosphere in which this kind of learning can take place. It also lies in the facilitator's willingness to guide, rather than to direct, the learning process, to keep the participants motivated and focused on the subject at hand, and to maintain the pace of the activities so that the objectives for each session will be realized according to schedule. The fulfillment comes from tangible results that reflect the increasing technical expertise, creative ingenuity, and audience awareness that develops in participants as the workshop progresses. It also derives from the interest and enthusiasm expressed by most community audiences in response to educational strategies that don't simply tell them what they should do but allow them to explore alternatives, voice opinions, and make decisions - in other words, to participate fully in their own education.

A visual aids workshop demands a great deal of time and effort from facilitator and participants alike. It is hard work. Hands will get dirty. It is, however, a thoroughly satisfying and eminently rewarding experience for everyone involved.

I. Introduction

Without exception, virtually all contemporary literature outlining primary health care training techniques in developing countries worldwide stresses the need to adopt the following four strategies for an effective health education program at the village level:

- A. participatory (as opposed to didactic) methods of health education
- B. supplemental visual aids/curricula materials to encourage audience participation and promote learning
- C. adaptation of existing methods and materials to address the specific needs and perceptions of local populations
- D. effective methods of evaluation

II. Rationale

This visual aids workshop is designed to acquaint personnel responsible for primary health care education with more effective teaching strategies by instructing them in the use and construction of simple supplementary curricula materials from inexpensive, indigenous sources. It will enable PHC facilitators to train incoming health personnel in participatory educational techniques. It will also provide district personnel with the skills to adapt and personalize the lessons presented in the Primary Health Care Household Teaching Manual (MOH:1985) for local audiences. Finally, because visual aids are a proven method for stimulating audience response, facilitators will be able to readily evaluate the educational effectiveness of their presentations.

III. Objectives

A. General

- 1. Public health personnel will be trained in the construction and use of visual educational aids. This supplementary curricula material shall be consistent with MOH goals and guidelines, but specific to current public health issues in the province and targeted toward local populations.
- 2. Workshop participants will be able to share their technical and design skills with other members of the primary health care team, thereby ensuring that visual aids and innovative problem-solving strategies become an ongoing supplement to the primary health care education program.
- 3. Self-reliance at the village level will be fostered through participatory educational experience.

B. Specific

- 1. Workshop participants will become familiar with the basic principles of communication design.

2. Participants will learn to work with a variety of techniques and media.
3. Workshop participants will be able to analyze a public health problem, assess their target audience, and select/create supplementary curriculum material appropriate to the occasion.
4. Workshop participants will know how to test the effectiveness of supplementary curricula materials and to evaluate the educational effectiveness of their presentation.
5. Projects created during the workshop will be useable models and will form the nucleus for an expandable supply of visual aids available for use-as-needed by all primary health care personnel.

IV. Course Content

- A. Principles of Communication Design
- B. Problem Analysis
- C. Identification of Target Audience
- D. Selection of Presentation Method
- E. Design Process
- F. Media and Techniques
- G. Testing and Evaluation

V. Methodology

The visual aids workshop will be conducted as a participatory hands-on experience. Specific problems will be selected by the group from the current local public health situation. A variety of solutions will be explored in such a way that all participants can become actively involved in the design/construction of posters, flip charts, diagrams, flannelboard activities, puppets, games, and simple silkscreen reproduction for multiple copies. Participants will be encouraged to work cooperatively, contributing their individual talents and expertise to the group effort.

VI. Evaluation

- A. Projects will be evaluated in terms of:
 1. design concept
 2. technique
 3. educational effectiveness
- B. Project evaluation will be accomplished by:
 1. personal feedback from instructor
 2. two or more group critiques of each project-in-progress
 3. final effectiveness test of each project in the community with a sample audience

VII. Operating Details

A. Duration

1. 3 hours once a week for 10 consecutive weeks
2. total in-class training time: 30 hours

B. Dates/time

- 1.
- 2.

C. Venue:

D. Instructor:

E. Selection of participants

1. criteria

- a) commitment to primary health care education
- b) willingness to solve problems creatively and to experiment with innovation
- c) willingness to work cooperatively in a team situation
- d) commitment to attend and participate fully in all ten classes

2. class size

- a) 12-16 participants (4 teams of 3-4 members each)
- b) selection priority should go to those persons whose professional roles would be most enhanced by the acquisition of these skills

VIII. Requirements

- A. Compulsory attendance at all ten sessions
- B. Full participation in all workshop activities
- C. Completion of all homework assignments

IX. Materials and Supplies:

X. Certification

A certificate of completion will be awarded to every participant who attends all ten sessions of the workshop and completes all the assigned projects as required.

SYLLABUS: VISUAL AIDS WORKSHOP

	KEY TOPIC	ACTIVITY FOCUS	SUPPORTING MATERIALS	METHOD
SESSION 1	Introduction	1.1 Orientation to class structure and methods	course outline/syllabus selected illustrations	explanation/ discussion
	Principles of communication design	1.2 Types of visual aids: a survey	resource handout examples	demonstration/ discussion
		1.3 Media & techniques: an overview	materials & supplies	demonstration/ discussion
General planning session		1.4 Design considerations	resource handout	discussion
		1.5 Design process · analyzing the problem · identifying the target audience · developing the concept · evaluation strategies	prepared list	explanation/ discussion
		1.6 Project assignments · PHC issues to be covered in seminar · matching issues to a target audience · method of presentation · selection of visual aid	lists prepared in activity 1.2 newsprint/felt pens	team activity
		1.7 Master plan	newsprint/felt pens	group activity
		Homework assignment	1.8 Project #1: idea generation	newsprint/felt pens
SESSION 2	Planning session: Project #1	2.1 Review design principles	resource handouts	discussion/ quiz
		2.2 Review design process	prepared list from Session 1, Activity 1.5	discussion/ quiz
	Homework assignment	2.3 Develop design/presentation strategy · brainstorm ideas · discuss/evaluate · select best solution	newsprint/felt pens resource handouts	team activity
2.4 Sketches/script		newsprint/felt pens	team activity	
SESSION 3	Project #1 continued	3.1 Present initial design/script	sketches/storyboards presentation script	group activity critique/ discussion
	Production phase	3.2 Modify design 3.3 Finished artwork	newsprint/felt pens art supplies	team activity team activity
	Homework assignment	3.4 Project #1 pretest	completed visual aid presentation script evaluation form	supervised team activity
SESSION 4	Evaluation: Project #1	4.1 Pretest reports	completed visual aid presentation notes evaluation form	group activity critique/ discussion
	Project #2 design phase	4.2 Develop design/presentation strategy · brainstorm ideas · discuss/evaluate · select best solution	newsprint/felt pens resource handouts	team activity
		4.3 Sketches/script	newsprint/felt pens	team activity
	Homework assignment	4.4 Modify Project #1 Project #2: complete design/script Arrange pretest venue	art supplies newsprint/felt pens	self-directed team activity

SESSION 5	Evaluation: Project #1	5.1 Present Project #1 final correction	Project #1	group activity
	Project #2 design phase	5.2 Present initial design/script	sketches/storyboards	group activity critique/ discussion
	Production phase	5.3 Modify design 5.4 Finished artwork	newsprint/felt pens art supplies	team activity team activity
	Homework assignment	5.5 Project #2 pretest	completed visual aid presentation script evaluation form	supervised team activity
SESSION 6	Evaluation: Project #2	6.1 Project #2: pretest reports	completed visual aid presentation notes evaluation form	group activity critique/ discussion
	Project #3 design phase	6.2 Develop design/ presentation strategy · brainstorm ideas · discuss/evaluate · select best solution	newsprint/felt pens resource handouts	team activity
		6.3 Sketches/storyboards	newsprint/felt pens	team activity
	Homework assignment	6.4 Modify Project #2 Project #3: complete design/script Arrange pretest venue	art supplies newsprint/felt pens	self-directed team activity
SESSION 7	Evaluation: Project #2	7.1 Present Project #2 final correction	Project #2	group activity
	Project #3 design phase	7.2 Present initial design/script	sketches/storyboards	group activity critique/ discussion
		7.3 Modify design	newsprint/felt pens	team activity
		7.4 Review poster design	chalkboard	group activity
		7.5 Develop concepts · brainstorm ideas · discuss/evaluate · select best solution	newsprint/felt pens resource handouts	team activity
		7.6 Group consensus · present team ideas · discuss/evaluate · select best solution	team sketches	group activity
	Homework assignment	7.7 Project #3 pretest Project #4 tight comp	completed visual aid presentation script evaluation form art supplies	supervised team activity self-directed team activity
SESSION 8	Evaluation: Project #3	8.1 Pretest reports	completed visual aid presentation notes evaluation form	group activity critique/ discussion
	Project #4 production phase	8.2 Silkscreen preparation 8.3 Art preparation · keyline pattern · color separations	frames, silk, staples, tape as required tracing paper black fine tip pen masking tape tight comp	demonstration/ team activity team activity
	Homework assignment	8.4 Stencil cutting	blue film, exacto knife color separations	self-directed team activity
SESSION 9	Evaluation: Project #3	9.1 Present Project #3 final correction	Project #3	group activity
	Project #4 production phase	9.2 Adhere stencils	cut stencils, rags, lacquer thinner, gloss varnish, newspaper	demonstration/ group activity
		9.3 Print poster	ink, squeegee, paper	demonstration/ group activity
		9.4 Clean-up	appropriate solvents	group activity
	Homework assignment	9.5 Workshop evaluation · fill out action plan · take-home examination · written evaluation	action plan form take home examination pencil/paper	team activity individual activities

SESSION 10	Project #4 production phase	10.1 Complete printing	screen, ink, squeegee partially printed posters	group activity
		10.2 Clean-up	appropriate solvents	group activity
		10.3 Take-home exam: review & correction	take-home exams answer key	group activity
		10.4 Wind-up activities · collect action plans · collect evaluations · distribute posters · distribute supplies · award certificates of completion	printed posters excess supplies certificates of completion	group activity

SUGGESTED LIST OF SUPPLIES

1 set for each team

T-square, calibrated
14" 30/60 degree triangle
scissors
exacto knife, #11 blade
colored marking pens - broad tip
colored marking pens - fine tip
black marking pen - ultrafine tip
masking tape

For 12-16 participants

newsprint or brown paper, 50 sheets
box board (or other inexpensive poster board), 50 sheets
tracing paper, 16 sheets
medium grade sandpaper, 12 sheets
white glue, large
gloss varnish
lacquer thinner
silkscreen ink (red, yellow, blue, green, black), 1 each

To make 4 silkscreens, 24" x 36"

½" plywood, 28" x 42" (x4)
1" x 2" lumber: 12 @ 28", 8 @ 40"
22" squeegee (x4)
4 yards silk, nylon, or other fine mesh fabric - minimum 45" wide
nails
8 small pin hinges
stapler/staples
4 yards blue film

WORKSHOP RECORD SHEET

PROJECT #1 (team activity)	TEAM A	TEAM B	TEAM C	TEAM D
Preliminary critique				
Pretest (name of facilitator)				
evaluation form				
pretest report				
Modification/final evaluation				

PROJECT #2 (team activity)				
Preliminary critique				
Pretest (name of facilitator)				
evaluation form				
pretest report				
Modification/final evaluation				

PROJECT #3 (team activity)				
Preliminary critique				
Pretest (name of facilitator)				
evaluation form				
pretest report				
Modification/final evaluation				

PROJECT #4 (supervised large group activity)

	NAMES																			
WORKSHOP WIND-UP																				
Take-home examination																				
Action plan																				
Workshop evaluation																				
Certificate of Completion																				

PURPOSE

Session 1 will describe the structure and requirements for the visual aids workshop. It will present an overview of the many types of visual aids, and nonformal methods for using these aids, available to the health educator. The second part of Session 1 will acquaint the participant with the fundamental principles of visual aids design and construction including media, technique, and conceptual process. Participants will be encouraged to work cooperatively, contributing their individual talents and expertise to the group effort.

OBJECTIVES

Participants will experience first-hand nonformal, participatory teaching strategies supplemented by visual aids. They will be able to list the design requirements of an effective visual aid and describe the principle steps in the design process. They will draw up a master plan of projects to be completed during the course of the workshop.

MATERIALS

course outline (pp. 5-7)
 syllabus (pp. 8-10)
 newsprint (or brown paper)
 felt pens
 masking tape
 learning chart (1.1.1, p. 15)
 story (1.1.2, p. 16)
 illustrations (1.1.3, 1.1.4,
 1.1.5 - pp. 17, 18, & 19)

PRINCIPLES OF COMMUNICATION
 DESIGN (handout 1.4.1, pp.
 21-49)
 MAKING & USING VISUAL AIDS
 (handout 1.8.1, pp. 51-
 147)
 examples of visual aids
 art supplies for workshop
 The Design Process (prepared
 list from pp. 154-156)

PREPARATION

- 1) Reproduce and collate sufficient numbers of the course outline and syllabus for all participants to have their own copy of each.
- 2) Reproduce and collate sufficient numbers of the two instruction manuals (handouts 1.4.1 and 1.8.1) for all participants to have their own copies.

NOTE: If your budget cannot accommodate a copy of both manuals for each participant, duplicate four copies of each and ask teams to share this resource material.

- 3) Reproduce one copy of the story (1.1.2)
- 4) Follow instructions to enlarge learning chart (1.1.1), illustrations 1.1.3, 1.1.4, and 1.1.5 on newsprint or brown paper.

- 5) List on a large piece of paper the 12 steps in the design process (see Activity 1.5, pp. 151-154). List only the main steps. Explanations of the process can be brought out during the discussion.
- 6) Assemble the art supplies you will be using during the workshop.
- 7) Gather as many examples of visual aids as you can find - posters, brochures, comics, games, puppets, etc.













ACTIVITY SEQUENCE

	<u>Estimated Time</u>
1.1 Orientation to Class Structure & Methods	45 minutes
1.2 Types of Visual Aids: A Survey	30
1.3 Media & Techniques: An Overview	15
*** Merienda	10
1.4 Design Considerations	25
1.5 The Design Process	20
1.6 Project Assignments	20
1.7 Master Plan	10
1.8 Homework Assignment: Idea Generation	<u>5</u>
	180 minutes

Reproduce learning chart on a piece of newsprint or brown paper at least 10" x 24". Make sure you draw the chart large enough to be seen easily from a distance.

THE WAY WE LEARN

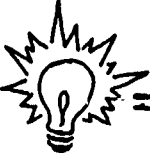
15

	MESSAGE SENT	MESSAGE RECEIVED	RESULT
LECTURE			= 
DEMONSTRATION	 + 		= 
PARTICIPATION	 +  +  +  +  +  + 		= 

Three blind men were walking through the jungle one day when they chanced to meet an elephant. It was their first encounter with such an animal and they were anxious to understand the nature of the beast. The first blind man grabbed the elephant's trunk. "An elephant is just like a big snake," he exclaimed, "long and round and sinuous."

"You are quite mistaken," contradicted the second blind man as he placed his two hands flat against the elephant's side. "An elephant is like the side of a house, broad and flat."

"You are both wrong," said the third blind man who was hanging on to the animal's tail. "An elephant is exactly like a piece of rope. I am sure of this because I am holding it in my hand."

And so they continued through the jungle, each man convinced that he alone understood the true nature of the elephant.

On a large piece of newsprint or brown paper, construct a one-inch grid 18" long and 8" wide. Reproduce the illustration below, square by square.

17



Enlarge the picture below on a piece of newsprint or brown paper.

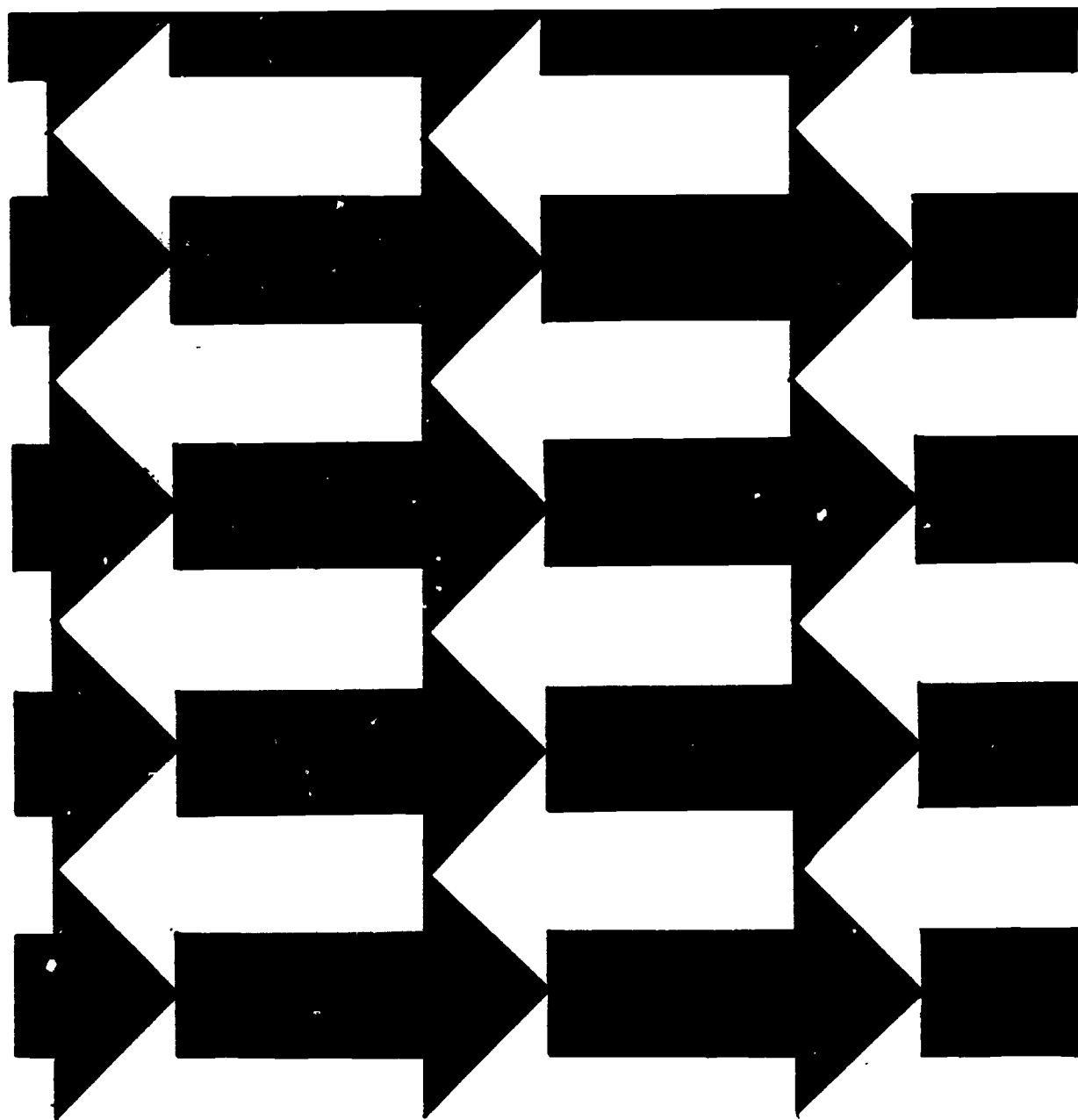

Construct a one inch grid, 14" x 14", on a piece of newsprint or brown paper. Reproduce the drawing below, square by square. Be careful to make the drawing symmetrical.

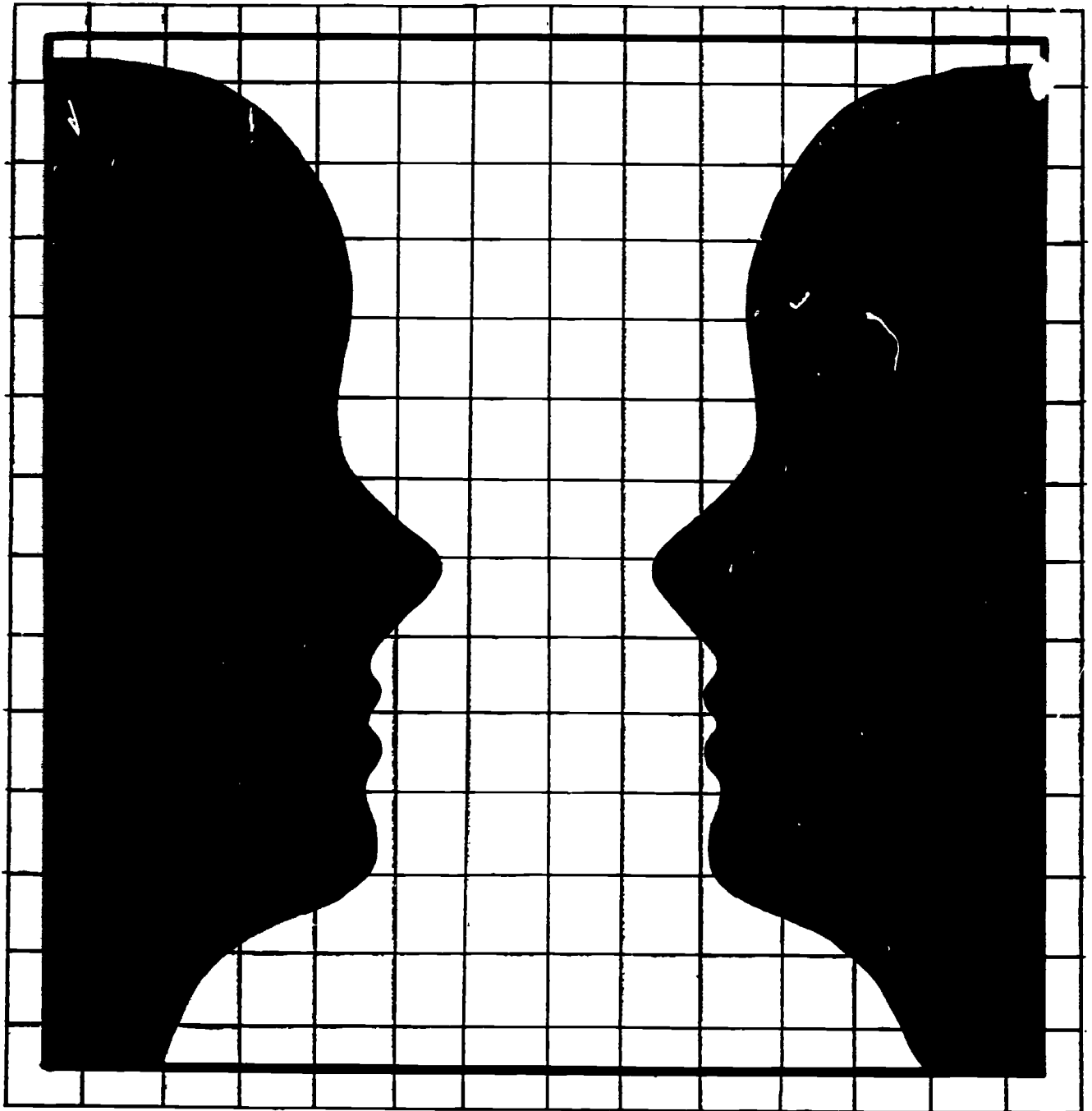

Visual aids are concerned exclusively with communication. A visual aid must transmit a message, or assist in transmitting a message, that can be successfully received by the person or persons for whom the message is intended. In other words, the message must be clear and it must be easily understood. Effective communication is simple, straightforward, and direct.

Table of Contents

Design Considerations	23
Some Notes on Drawing	29
Technical tips	36
Lettering Guide	39

Many factors contribute to effective communication design. As you develop your visual aids, ask yourself the following questions.

- 1) Are the pictures and words easy to see?
 - Pictures should be clearly drawn.

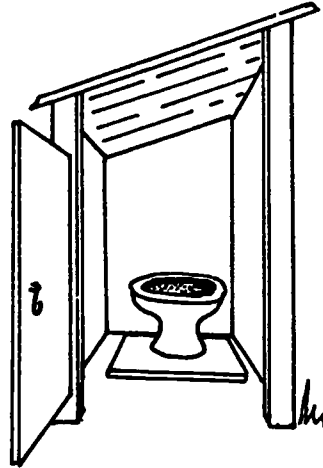

- Headlines should be

LARGE

and

bold

- Copy should be **clearly printed**

- 2) Are the pictures and words easy to understand?
• Are all the figures and objects in the same scale?

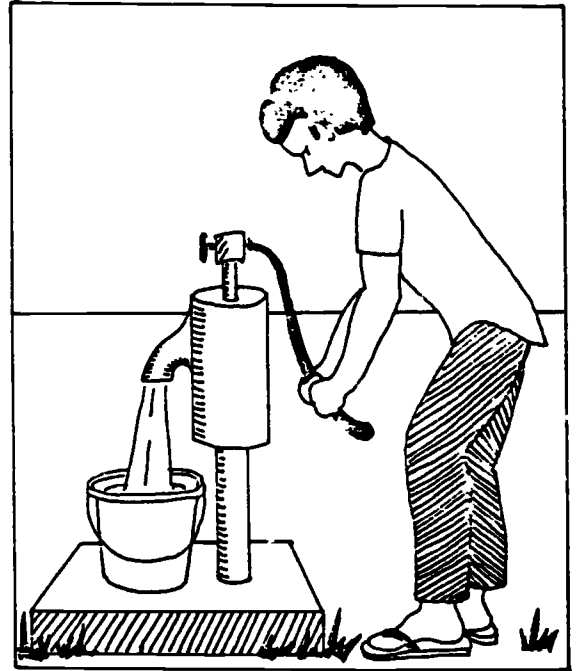
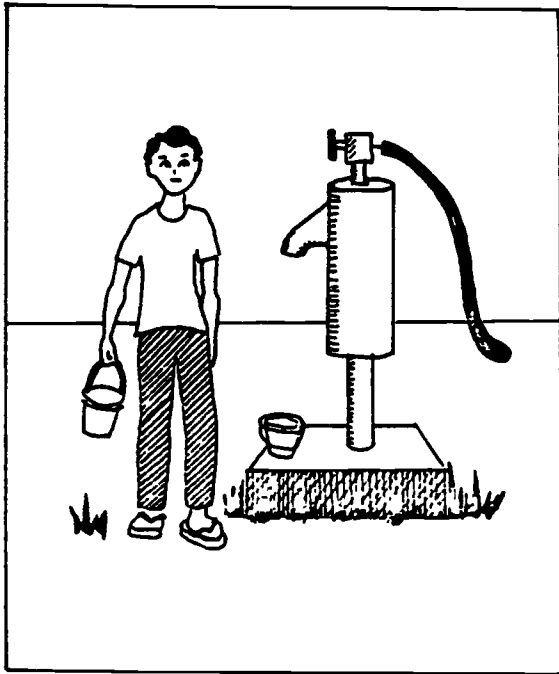

- Are full figures shown before parts of figures?

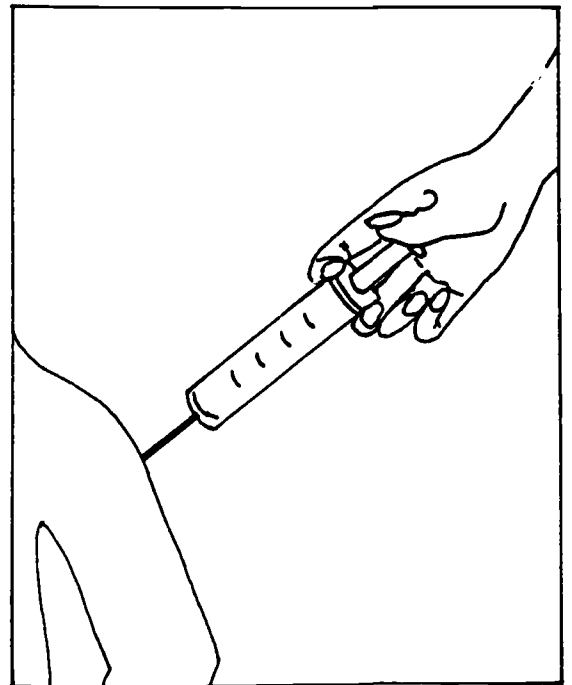
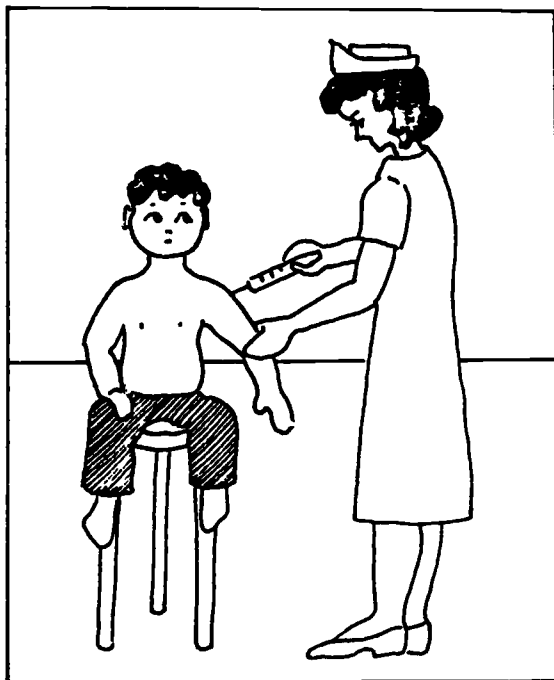

•Are figures and objects realistic?

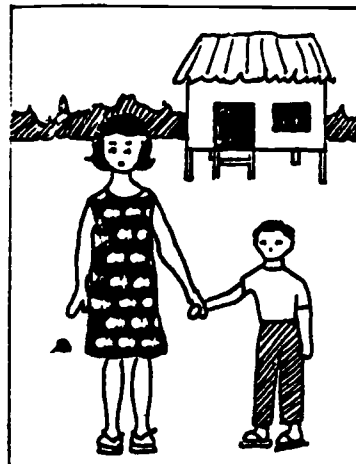

•Are the words and graphic symbols familiar to the audience?

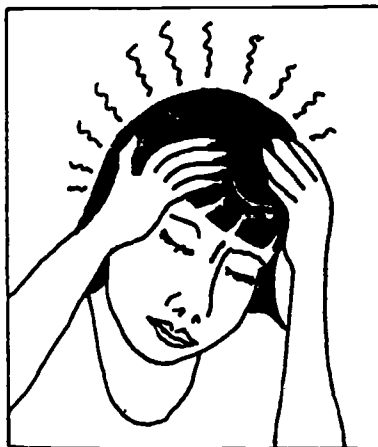

Which phrase is easier to understand?

RESPIRATORY AILMENTS

or

BREATHING PROBLEMS

3) Is the information presented clearly and simply?

•Is there one main idea for each picture?

•Are there any unnecessary details?

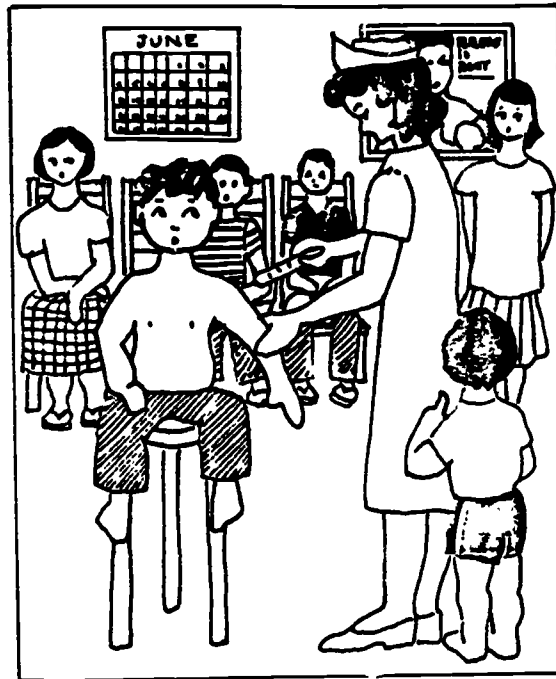

4) Is the picture well-organized?

•Does the picture fill the space?

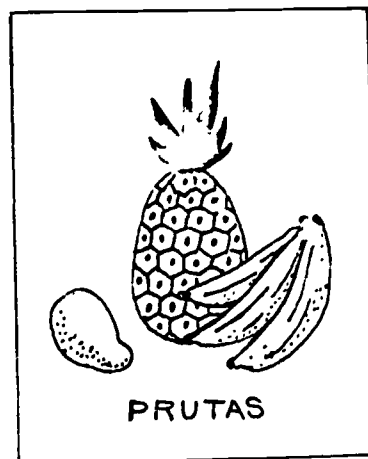
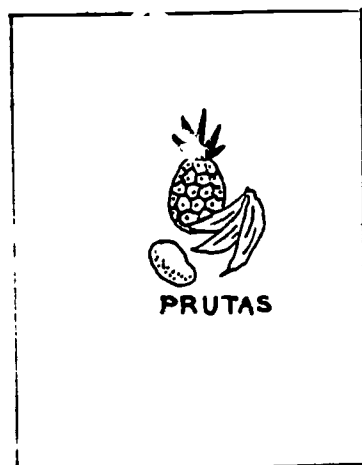

•Are the words and pictures proportional?

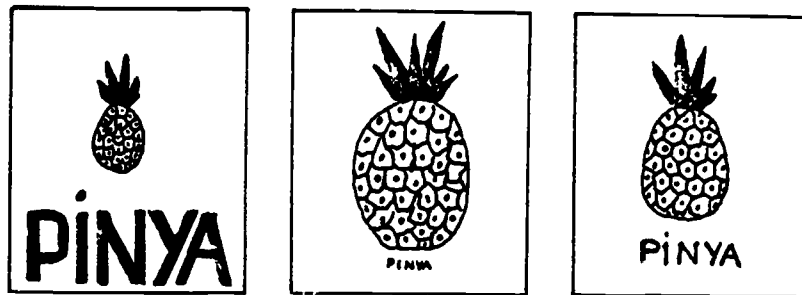

•If words are used, is it clear what words go with what pictures?

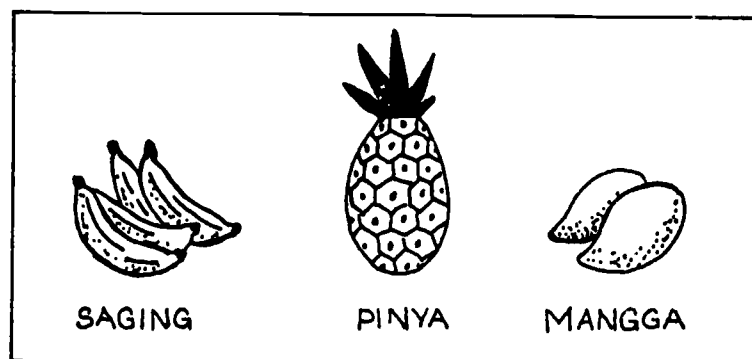
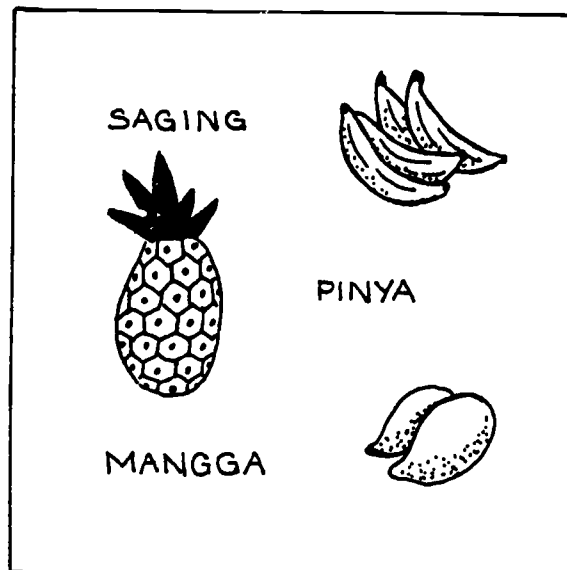

- 5) Does the picture attract and hold attention?
- Is it colorful?
 - Is it pleasing to the eye?
 - Does it focus on the most important element?

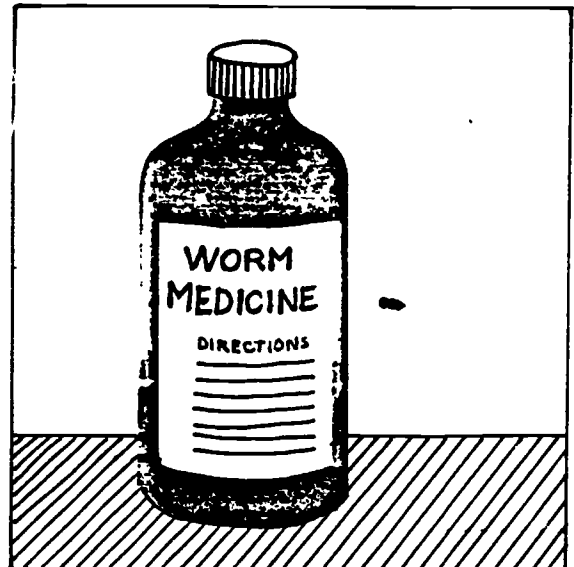

- 6) Are the pictures and words sensitive to local customs and traditions?
- Are figures and objects in the picture based on the experience of the viewers?
 - Are the words presented in the local dialect?
- 7) Is the information accurate?
- 8) Is the visual aid appropriate for the subject, the occasion, and the target audience?
- 9) Is the visual aid easy to use?
- 10) Will it stimulate audience participation?
- 11) Is it cost effective?

No one is born knowing how to draw. It is a learned skill. Like playing a sport or mastering a musical instrument, it's a matter of practice. People who draw well do so because they draw a lot. They also know some "tricks of the trade". You can learn some of these tricks, too.

First of all, don't be afraid to copy or trace. Everybody does it. Keep a file of useful images, things you may have to draw frequently. That way you won't have to launch a major search every time you need to draw a tricycle or a carabao.

Don't pay someone else to do your drawing for you. Not only does that defeat the purpose of keeping these visual aids low-cost, you will probably have to modify your visual aid at least once during the process of developing and testing it. If you have paid to have a drawing made, you'll be reluctant to toss it out and start again. If you have a friend who is willing to help you out for free, that's great. Explain to him or her that the drawing will most likely have to be revised once or twice during the development process.

It would be best if you could learn how to draw yourself. It isn't hard to do. The following guidelines will help you get started.

TO DRAW PEOPLE

- 1) First make a rough sketch of the general shape and position of the body. Think about how the body parts work.
- 2) Place a piece of tracing paper over the rough sketch and trace the body outline, refining the contour. Draw the body naked first. Then add clothes and hair.

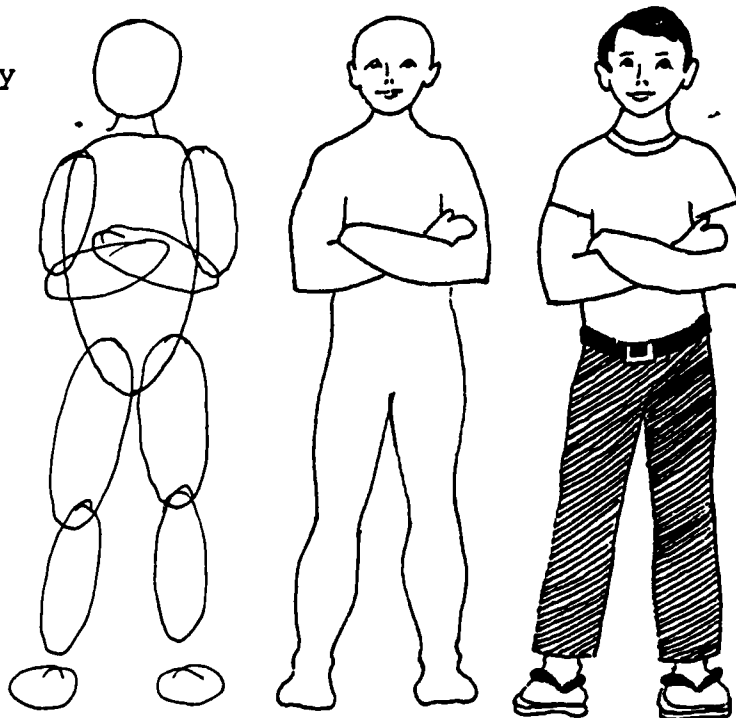

3) Your people will look more real if the proportions are correct. Use the scale below to check your drawings.

NOTE

- A child's head is larger, relative to body size, than an adult's.
- A child's legs are shorter, relative to body size, than an adult's.
- The halfway mark (broken line) is lower down on an adult's body than on the child's.

30

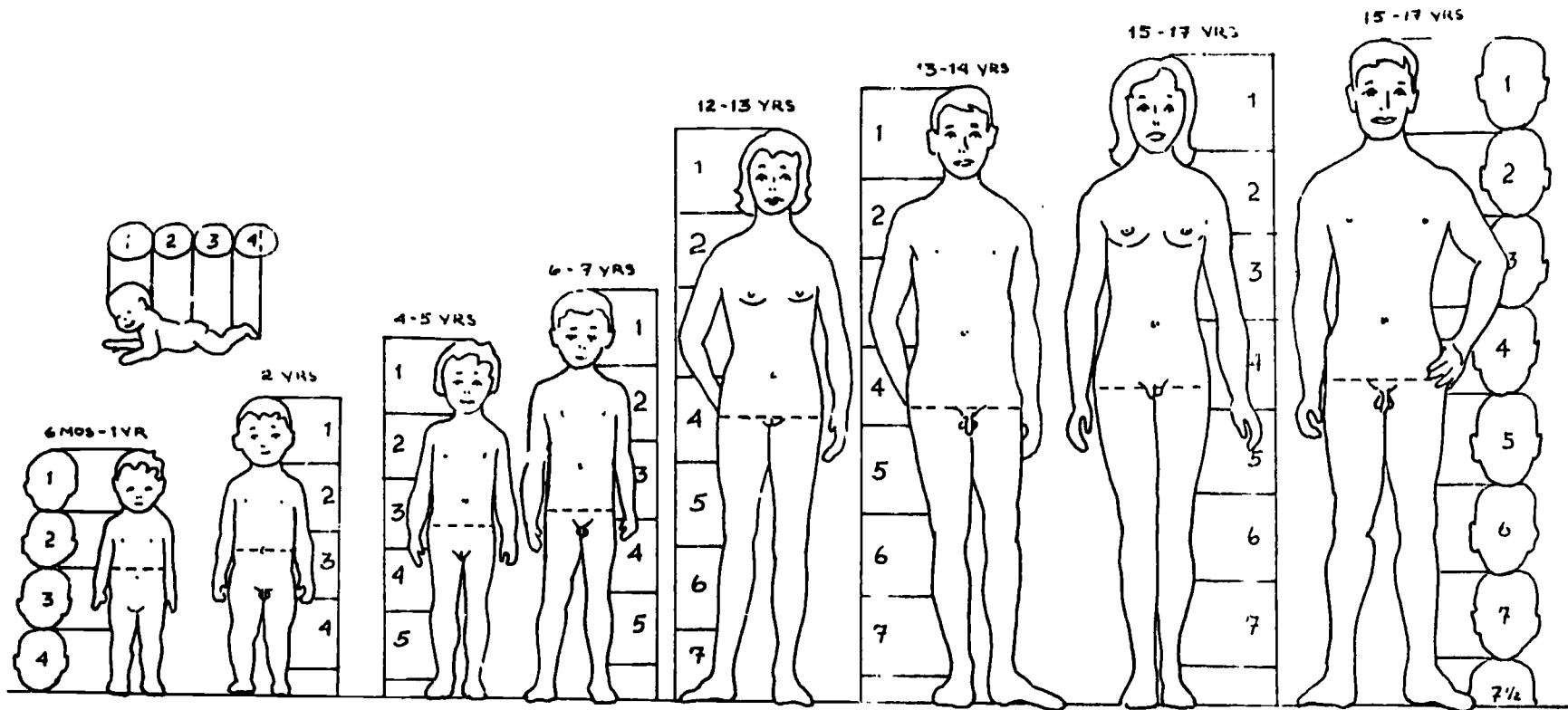

40

41

- 4) To connote movement, place the body axis on a diagonal.

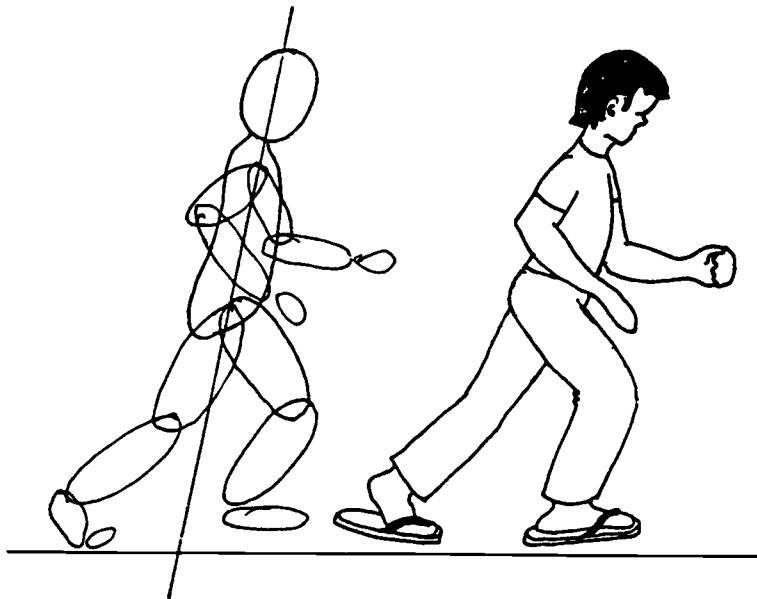

TO DRAW FACES

- 1) Draw a circle for the skull. Then add a jawline.
- 2) Keep the distance from eyes to nose about equal to that from nose to chin. Children's faces are smaller, relative to head size than adults'. The lower you put the line of the eyes, the smaller the jaw should be, and the younger the child you draw will look.

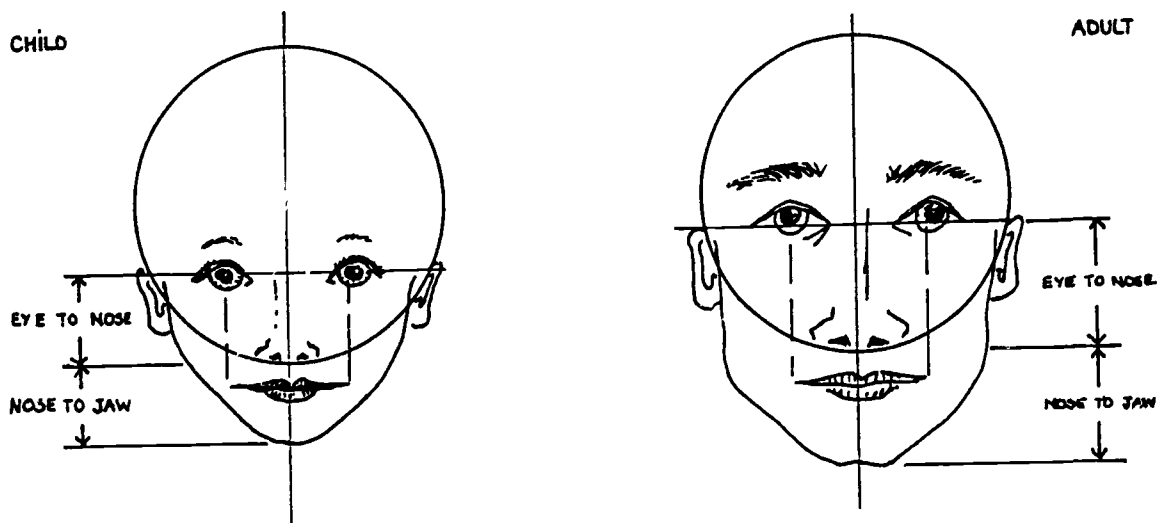

- 3) Change expressions by changing the shape of the eyebrows and the mouth.



TO DRAW IN PERSPECTIVE

Your drawings will appear more realistic if they give the illusion of depth in space. This is accomplished by drawing the people and objects in the foreground larger than the people and objects in the background. The further away something is, the smaller it appears. To keep the scale of all the people and objects in relation to one another, you must draw them in perspective.

- 1) Draw the figure in the foreground (the part of the picture that appears closest to you) first. This will establish the scale of everything else you draw.
- 2) Establish the horizon line. This is a horizontal line at the eye level of the viewer beyond which one can see no further.
- 3) Place a vanishing point on the horizon line. The vanishing point is that spot on the horizon where all lines appear to converge and then vanish. Think about looking as far as you can down a straight road. The edges of the road seem to get closer and closer together until they come to a point and disappear on the horizon. The vanishing point may be placed anywhere on the horizon line. All lines going back in space will converge at this point.

- 4) Use a straight edge to draw a line from the top of the figure's head to the vanishing point. Draw another line from the bottom of the figure's feet to the vanishing point. Figures the same height as the foreground figure will always be bounded by these two lines regardless of where in the picture they are placed.

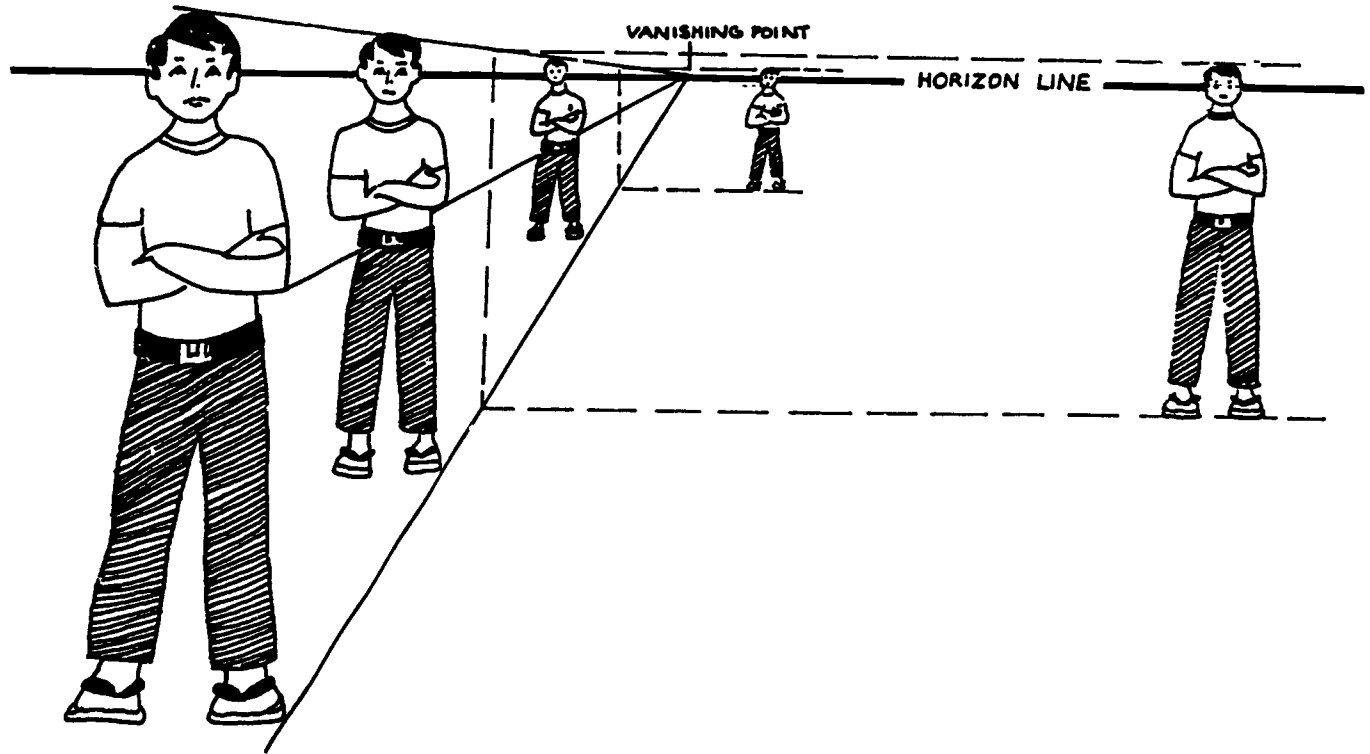

- 5) Buildings, furniture, vehicles, etc. can be thought of as boxes and constructed accordingly. The placement of the horizon line and vanishing point are arbitrary. The high horizon line in this first drawing of a chair represents an adult's point of view.

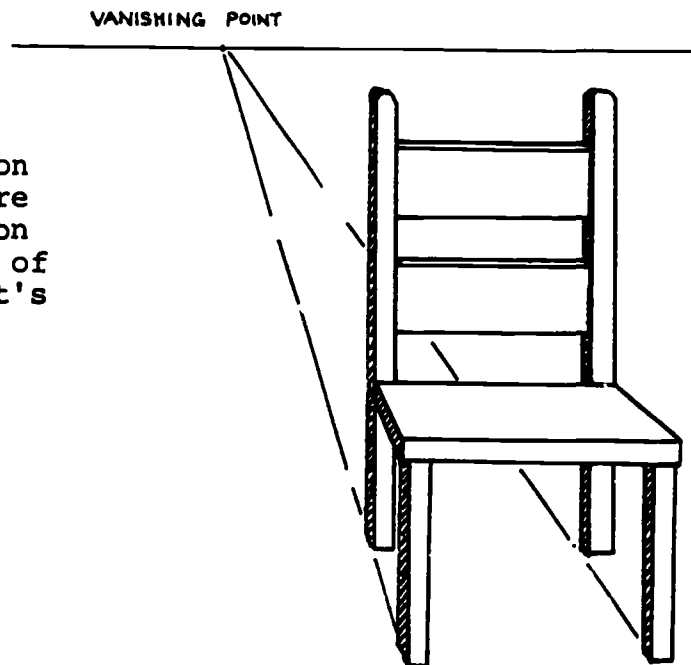

The low horizon line in this second drawing of the same chair represents the way a child standing several feet to the adult's right would see the same scene.

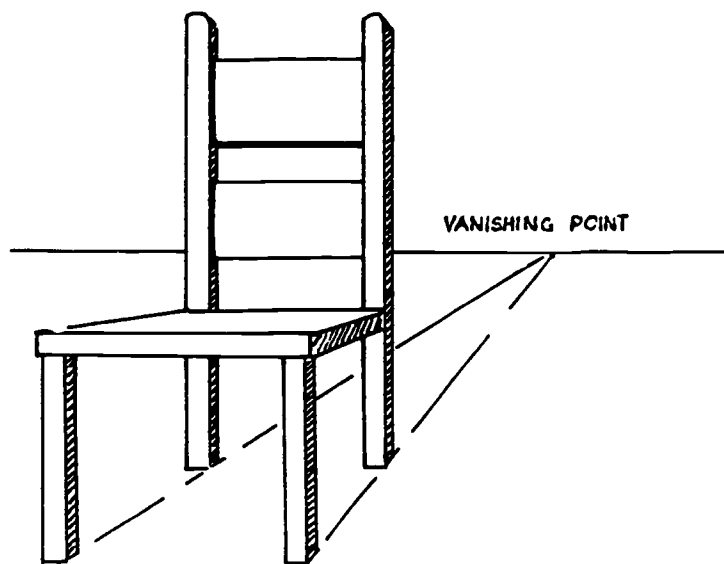

REMEMBER: All lines going back in space converge at the vanishing point. All horizontal lines are parallel to the horizon line. All vertical lines are perpendicular to the horizon line.

Constructing a picture using a single vanishing point is called one-point perspective.

One-point perspective works fine so long as all the objects in the picture are presented straight on. If, however, you wish to show a house or a bench (for example) angled toward the viewer you will have to use two-point perspective. This means you must put two vanishing points on the horizon line.

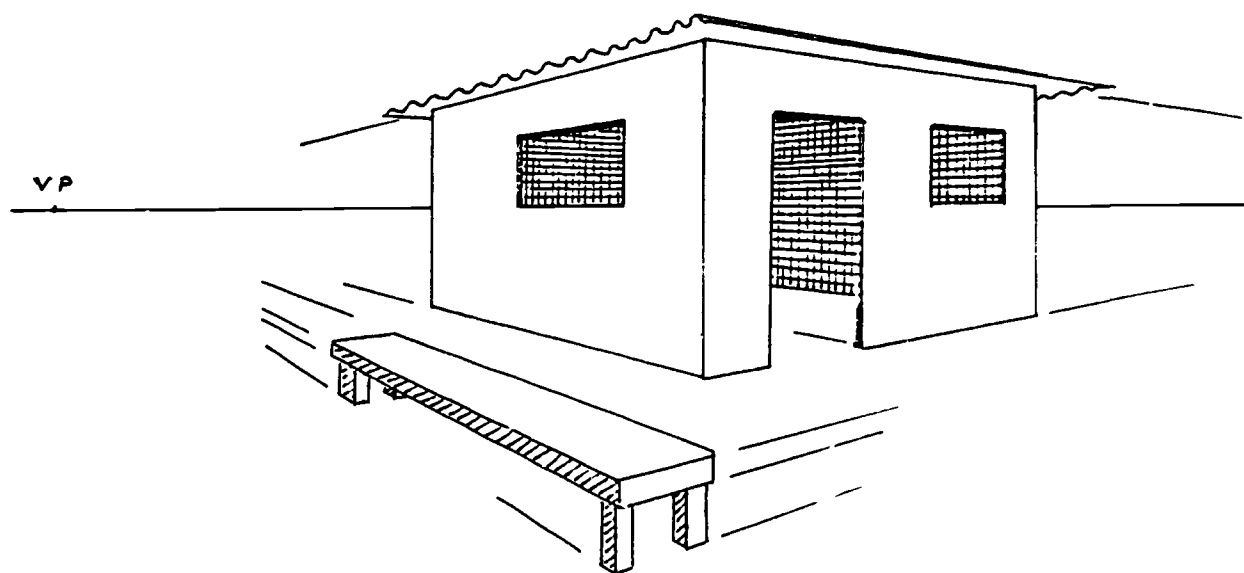

- 1) Draw a horizon line.
- 2) Position the two vanishing points on the horizon line leaving plenty of room between the two points.
 - All the objects in the picture must be drawn between the two vanishing points.
 - A general guideline is to place one vanishing point on the horizon line near the edge of the drawing. The second vanishing point is established on an extension of the horizon line beyond the edge of the paper.

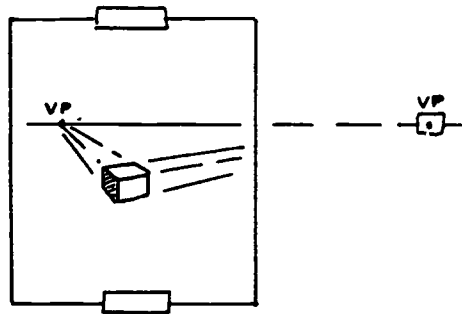

- Tape the drawing to the table. Lay a T-square or other straight edge along the horizon line and mark the second vanishing point on a small piece of tape stuck to the table.
 - The right hand vanishing point in the drawing of the house and bench was positioned 4" to the right of the building.
- 3) With the exception of vertical lines, all the rest of the lines in the drawing converge on one or the other vanishing points.

Always work up your drawings and designs with pencil on tracing or brown paper before attempting to do them in ink on poster board. You won't feel so guilty when you make a mistake and have to start all over again.

TO CORRECT A MISTAKE

The advantage to working up your drawing on a piece of tracing or brown paper before transferring it to poster board is that it is easy to correct a mistake without having to redo the whole drawing.

- 1) Use your exacto knife to cut out the error. Be sure to place a piece of cardboard under the paper so that you won't cut the table.
- 2) Patch the hole from the back with another small piece of paper just slightly larger than the piece you removed.

TO REDUCE OR ENLARGE AN IMAGE

You can easily change the size of a picture and make it either bigger or smaller.

- 1) Trace the image you want to enlarge or reduce.
- 2) Construct a grid of even squares over the traced picture.
- 3) Draw the same number of squares, only larger (or smaller) on another piece of tracing paper.
- 4) Copy the drawing carefully, square by square.

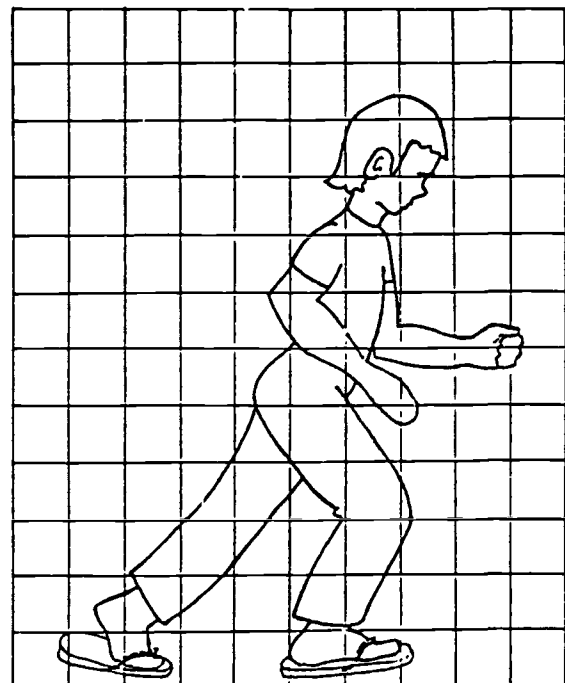
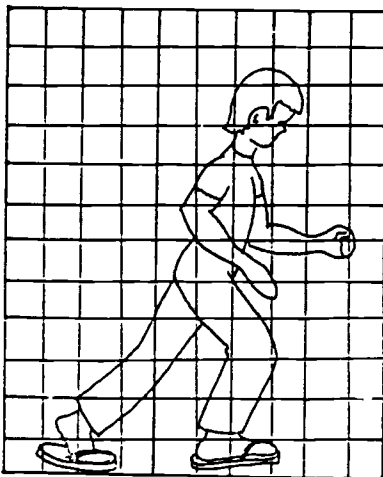

TO TRANSFER AN IMAGE

Once you have worked up your design/drawing on a piece of tracing or brown paper, it is a simple matter to transfer the image to a piece of poster board.

- 1) Turn the drawing over.
- 2) Using the side of the pencil point, rub lead all over the back of the picture.
- 3) Tape the picture, right side up, in position on the poster board.
- 4) With a sharp pointed pencil, carefully go over all the lines in the drawing. The graphite on the back of the picture works like carbon paper to reproduce the image on the poster board beneath.
- 5) Remove the picture pattern and ink the graphite lines that appear on the poster board.

TO DRAW A CIRCLE

Circles are almost impossible to draw freehand. If you don't have a compass, you can make one from a piece of stiff cardboard. Not only is it more reliable than the pencil-on-a-string method, but the "poor man's compass" is also reusable.

- 1) Cut a strip of cardboard about 1" (3 cm.) wide and several inches long.
- 2) Make a pinhole in one end of the cardboard strip.
- 3) Use an exacto knife to cut small notches along one side of the cardboard strip. The distance from the pinhole to each notch is the radius of the circle which may be drawn using that notch.
- 4) Pin the cardboard strip in position to the paper on which you wish to draw a circle. Set the point of the pen or pencil into the appropriate notch and swing the strip around the pin.
- 5) The "poor man's compass" may also be used to cut a circle. Place the point of an exacto knife into the appropriate notch and swing the cardboard strip around the pin. Be sure to put another piece of cardboard under the paper or board that you are cutting. Do not cut the table underneath.

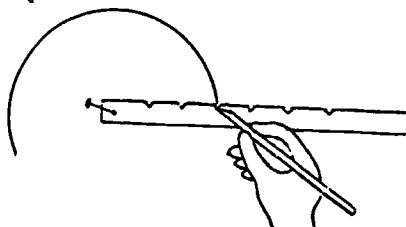

TO CONSTRUCT COLUMNS OF EQUAL WIDTH

Ruling 10 equal columns in a space 10" wide is easy. Each column is exactly 1" wide. But how can you rule 10 equal columns when the available space is only 9" wide without getting involved in higher mathematics? There is an easy way.

- 1) Place the ruler at an angle over the available space.
 - Position 0" on the left side of the available space.
 - Tip the ruler until the 10" mark lines up with the right side.
- 2) Make a small pencil dot at each 1" mark.
- 3) Use a T-square and triangle to rule the vertical lines for the columns at each pencil mark.
- 4) To make horizontal columns, use the top and bottom of the available space as points of reference for positioning the ruler.

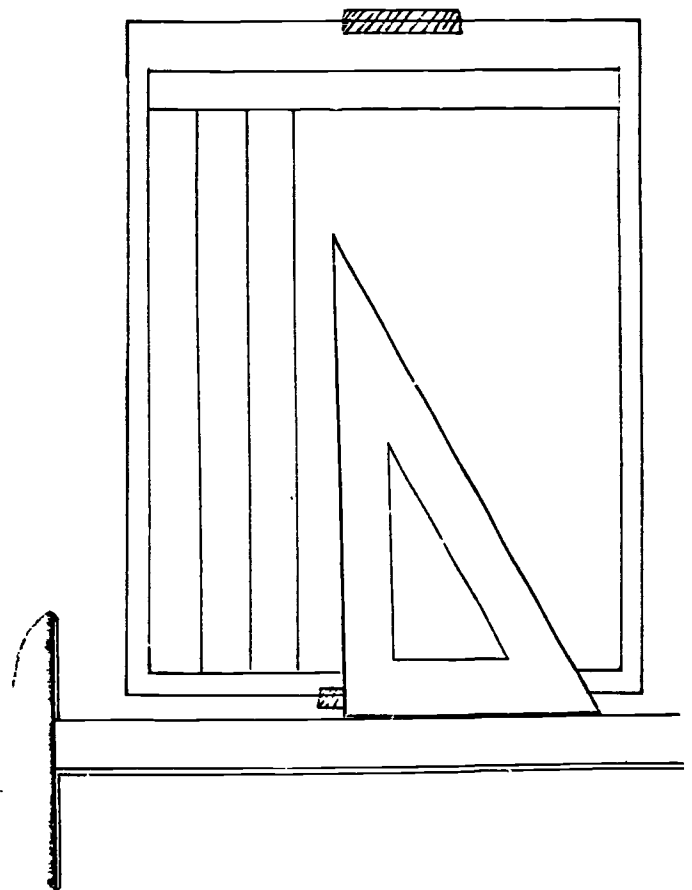
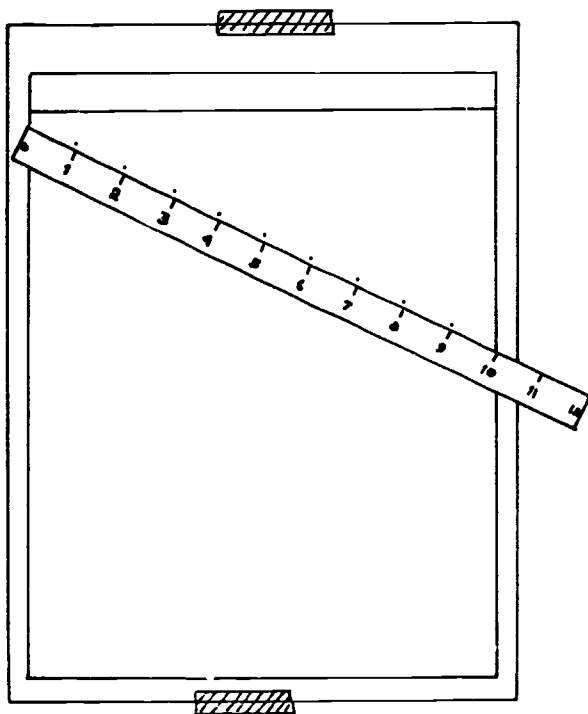

Work up any lettering you need on graph paper to keep the copy uniform. Or, if you prefer, trace the letters from one of the alphabets on the following pages.



1 2 3 4 5 6 7

8 9 0 a b c

d e f g h i j k l m

n o p q r s t u v

w x y z ! ?

A B C D E F

G H I J K L

M N O P Q R

S T U V W

X Y Z 1 2 3

4 5 6 7 8 9

a b c d e f g h i j
k l m n o p q r s
t u v w x y z

Large, cut-out letters for use on a bulletin or flannel board can be made easily by the fold-and-cut method.

Procedure:

- 1) Determine the size letter you wish to make and cut as many rectangles of paper as you need letters to spell out your message. Be sure that all the rectangles are exactly the same size.

- 2) Make a width gauge by folding one rectangle in half lengthwise two times. The resulting width of this gauge represents the thickness of each letter "stroke". Use this gauge to guide your folds as you create each letter.



- 3) Construct a 4-unit by 5-unit grid on each rectangle by folding the paper in half lengthwise two times and creasing the folds firmly as you did to make the width gauge.

Now, open the paper flat and fold it in half crosswise.

Next, fold the cut edges up one width (use the width gauge as a guide), leaving a half width exposed as shown.

Fold this half width down over the cut edges and crease firmly.

Open the paper flat to reveal the 4-unit by 5-unit grid defined by the fold lines. All the letters (except M and W) and all the numbers can be constructed on this grid.

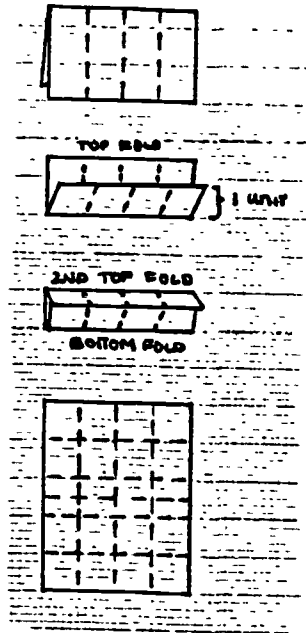

- 4) Fold and cut letters according to the following directions:

- A Fold paper rectangle in half lengthwise. Make two parallel diagonal folds, one unit width apart, from bottom cut corner to top folded corner as shown. Follow folded guide lines to remove shaded portion as indicated. Open letter flat.

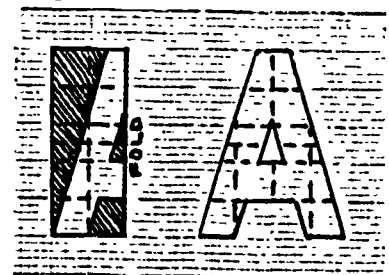

B Fold paper crosswise. With folded edge at top, curve both righthand corners. Fold paper crosswise again, matching up the two horizontal grid lines. The top fold should appear one half width above the bottom cut edge. Follow guide lines to remove inside (shaded) portion. Remember to curve the inner right corner. Open letter flat.

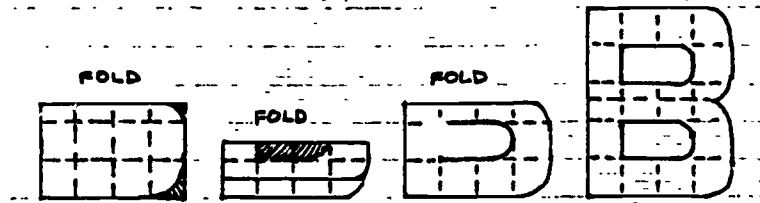

C Fold paper in quarters. Curve outside (open) corner and remove inner portion, remembering to curve inner corner also. Open letter out flat and clip center bar on right hand side.

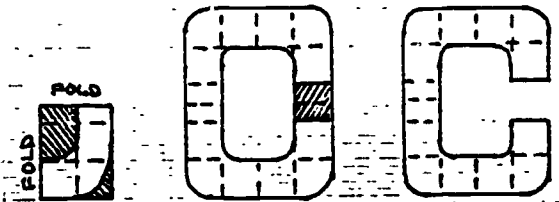

D Fold paper in half crosswise. With fold at top, curve lower right corner and remove center section. Remember to curve inner right corner also. Open letter flat.

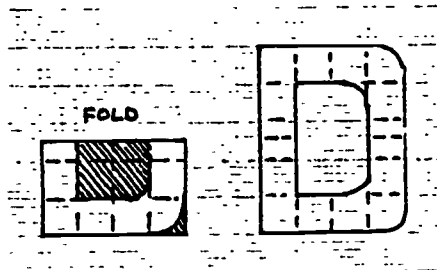

E Fold paper in half crosswise. Follow grid lines to cut horizontal bars. Clip center bar shorter than top and bottom bars. Open letter flat.

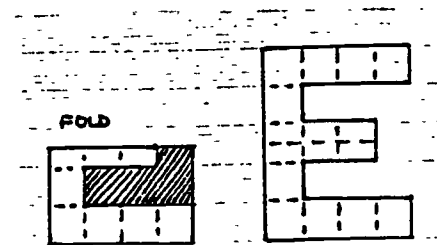

F Same as E. Remove lower horizontal bar.

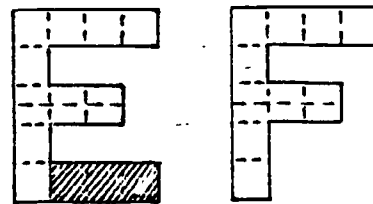

G Fold paper in half crosswise. Curve open corners and follow grid lines to remove center portion as shown. Open letter flat and clip right side above center bar.

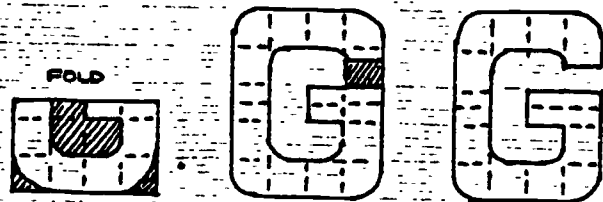

H Fold paper in quarters. Follow grid lines to remove shaded portion as indicated. Open letter flat.

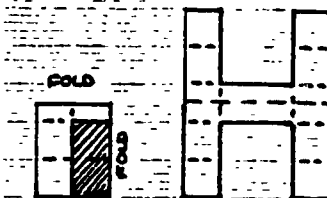

I Single vertical bar, one unit width wide. (See L below.)

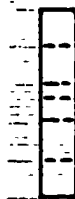

J Fold paper in half lengthwise. Curve lower open corner and remove center section as shown. Open letter flat. Remove top three units of left vertical bar.

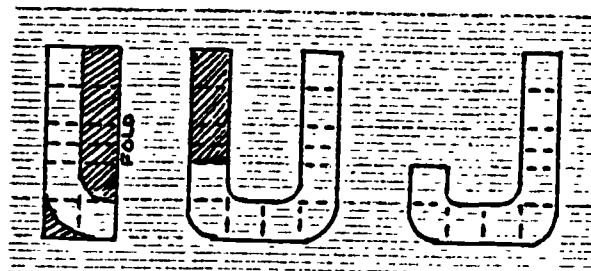

K Leave paper flat. Crease diagonals one unit wide as shown. Then follow folded guide lines to remove shaded portion

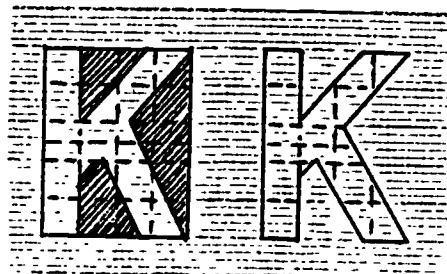

L Fold paper in half lengthwise. Cut away the first four units on the folded side as shown. Open letter out flat. Clip off all five units of the right vertical bar. This will produce both an L and an I.

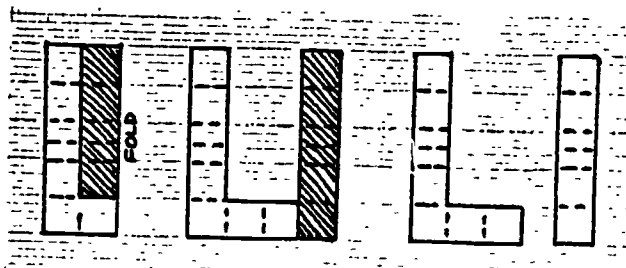

M You will need to cut a piece of paper one half width wider than any of the other letters you have made so far. Be sure that the length of the paper rectangle is the same as all the others.

Fold the paper in half crosswise and crease, then open flat. Now, fold the paper lengthwise. Use the width gauge to fold the cut edges in toward the center fold leaving one quarter width exposed. Crease these folds firmly. Open the last fold, leaving paper folded once lengthwise. Crease two parallel folds, one unit width apart, as shown. Follow creases to cut away shaded portion. Open letter flat.



N With paper flat, crease two parallel diagonal folds, one unit width apart, from upper left to bottom right corner. Cut away shaded portion as shown.

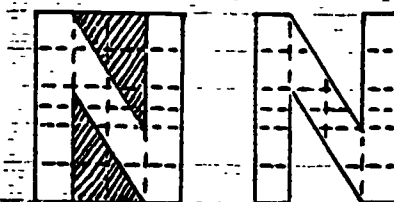

O Fold paper in quarters. Curve open corner and remove inner portion as for the letter C. Open letter flat.

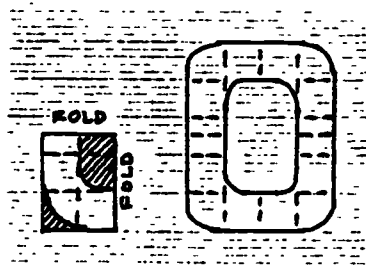

P Fold paper crosswise midway through the second horizontal unit so that the lower 2-unit section remains uncovered. Follow guide lines to cut away shaded portions as indicated.

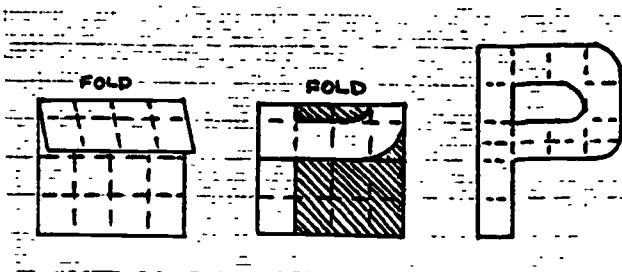

Q Fold and cut an O (see above) Glue a small tab to the back of the lower right corner as shown.



R With paper flat, make two parallel diagonal folds, one unit width apart, from bottom right corner to center of paper as shown. Now, fold the top section down as you did for the letter P. Follow guide lines to cut away shaded portions. Open letter flat.

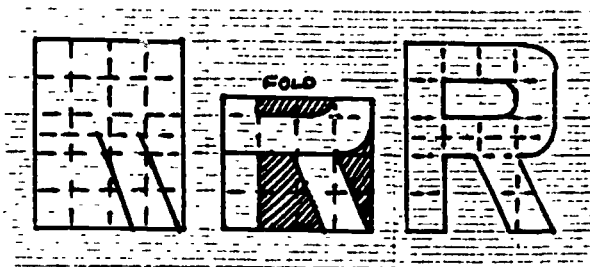

S Fold paper in quarters. Curve open corner and remove center portion as indicated. Open letter flat. Clip and curve each side to form the S.

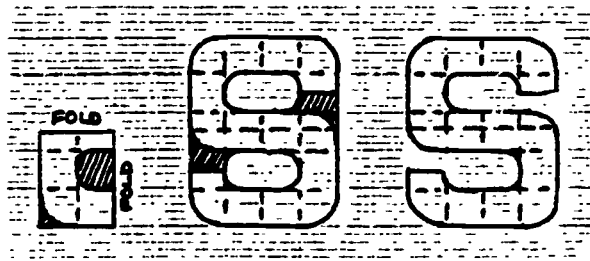

T Fold paper in half lengthwise. Remove shaded portion as shown. Open letter flat.

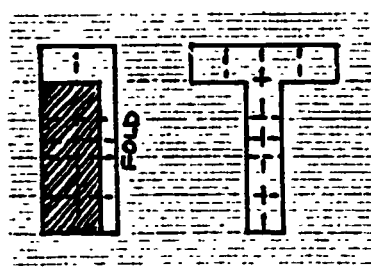

U Fold paper in half lengthwise. Remove shaded portion as shown. Open letter flat.

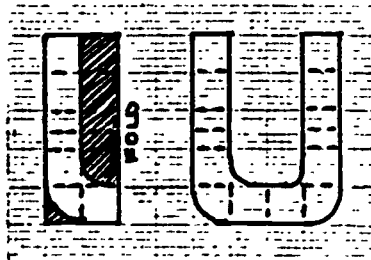

V Fold paper in half lengthwise and crease as for the letter A. Remove shaded portion as indicated. Open letter flat.

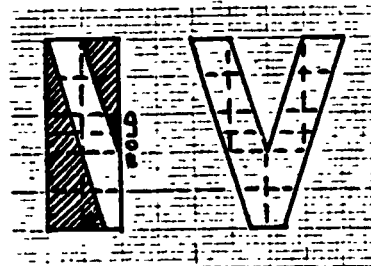

W W is the widest letter in the alphabet. Cut a piece of paper one unit width wider than the other letters. Be sure to keep the height of the letter equal to that of all the others. Fold and crease a 5-unit by 5-unit grid into the paper.

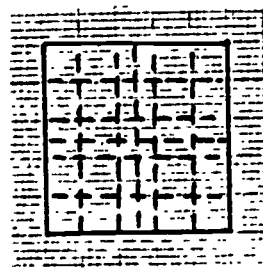

To make the W, fold the paper in half lengthwise. Crease two sets of parallel diagonal lines as shown and cut away shaded sections. Open letter flat.

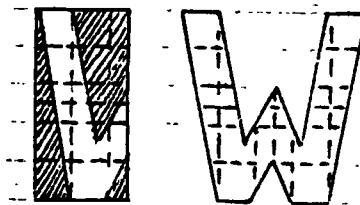

X Fold paper in quarters. Crease two parallel diagonal lines from open corner to folded corner exactly as shown. Be sure that the foot of the diagonal crossbar is flush with the bottom of the paper and that the other end (at the letter center) incorporates both the horizontal and the vertical fold. Follow these guidelines to cut away shaded portions as indicated.

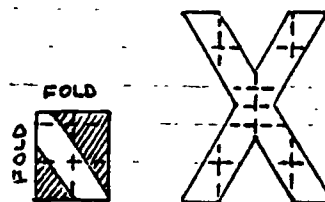

Y Fold paper in half lengthwise. Crease two parallel diagonal folds as shown. Follow these guidelines to remove shaded portion as indicated. Open letter flat.

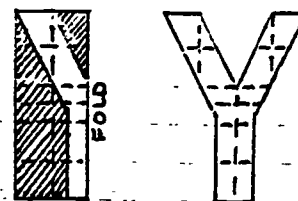

Z With paper flat, crease two parallel diagonal lines from lower left to upper right as shown. Cut away shaded sections.

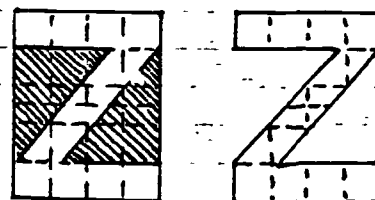

1 Cut a single vertical bar, one unit width wide (see letter I).

2 Leaving paper flat, follow the grid lines to remove shade portion as shown.

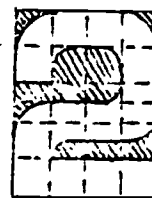

3 Fold paper into quarters. Curve corners and remove center portion as shown in diagram. Open flat. Clip left side and shorten center bar as indicated.

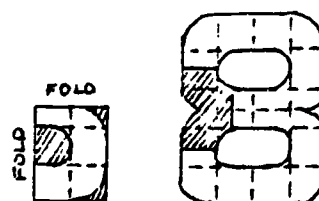

4 With paper flat, cut away shaded portion as shown.



5 With paper flat, cut away shaded portion as shown.

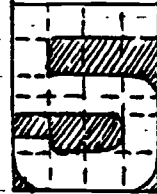

6 Fold paper into quarters. Curve open corner and follow grid lines to remove center portion as indicated. Open flat and curve right side as shown. Square lower left corner of top opening.

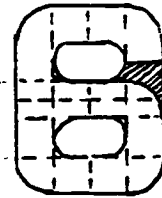

7 Leave paper flat. Crease diagonals. Follow fold lines to remove shaded portions as shown.

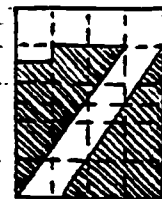

8 Fold and cut as you did for number 3. Do not clip sides or crossbar.

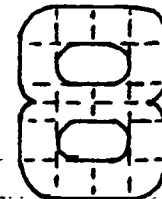

9 Identical to number 6. Invert.

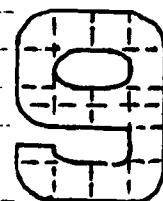

Table of Contents

Introduction	52
1. Chalkboard	53
2. Charts	54
3. Diagrams	61
4. Flip Charts	64
5. Flannelboard	67
6. Posters	69
7. Comic Books	75
8. Pamphlets	78
9. Flyers	83
10. Flexiflans	84
11. Games	88
12. Puppets	111
13. Masks	133
14. Slide Presentations	141

INTRODUCTION

A visual aid is any item which can be seen by the audience and which supports and supplements the verbal presentation by concretizing and clarifying the spoken message. Visual aids can also reinforce the educational message by encouraging and stimulating audience participation. The aid may be as simple and prosaic a tool as a chalkboard or as technologically sophisticated as a videotape. The emphasis in this workshop is on low-cost, low-tech visual aids which can be easily constructed by the average person from locally available materials.

In each category you will find step-by-step instructions for both making and using the visual aid under discussion. Whenever possible, we offer alternative methods for you to choose from. A number of examples for specific application are also provided. Feel free to use any or all of these ideas as given or adapt them to suit your particular need.

As you become more familiar with the number and variety of teaching aids available to you, as well as more adept at using these aids to support your educational message, the easier you will find it to develop your own materials. The secret to your success lies in your ability to maintain an open mind, in your willingness to innovate and try new methods, and most important of all, in your commitment to a health education program that respects the people it seeks to serve.

Health education is the first essential element of primary health care. Health for all by the year 2000 will become a reality only if our educational efforts are focused, not on telling people what they should do, but on motivating people to think things through and discover solutions for themselves. Participatory teaching strategies supported by visual aids stimulate people's powers of observation and reason and encourage them to become self-reliant. As we allow our audiences to take responsibility for their own learning, so will they learn to make thoughtful decisions about their health and the well-being of their families. And this, of course, is both the foundation and ultimate goal of the primary health care approach.

1. CHALKBOARD

A chalkboard is an effective, inexpensive, and easily used visual aid. For field presentations where there may not be a chalkboard available, a portable board can be constructed quite simply.

To make a chalkboard:

- 1) Carefully sand one side of a piece of plywood.
- 2) Paint with blackboard paint or any other flat colored paint.
- 3) Before writing on a new chalkboard, prepare the surface by wiping the board with a cloth or eraser covered with chalk dust. This will make subsequent erasing easier.

Variation:

To make a combination chalkboard/flannelboard, glue a piece of felt or flannel to the back of the board. Or make the chalkboard from a piece of masonite (lawanit). The smooth side can serve as the chalkboard without any additional sanding. The rough side of the board will support felt-backed pictures.

To use a chalkboard:

- 1) Be sure that everyone in the audience can see the board.
- 2) Don't scribble on the board willy-nilly. Write clearly using minimum 1" letters.
- 3) Keep your presentation neat and orderly; write from top to bottom.
- 4) Accent important points by underlining.
- 5) When explaining/discussing chalkboard material, stand to the side of the board and use a pointer.
- 6) Do not mix up your material. Clean the chalkboard with a cloth or eraser after each topic discussion.
- 7) Encourage volunteers from the audience to use the chalkboard to explain their ideas.

 NOTE: If you think you will need to use the material on the chalkboard at a later time or for another group, it would probably be better to use a marking pen and a piece of paper taped to the wall. You can save the paper and avoid having to write the material out each time.

2. CHARTS

A chart is a visual aid that presents relatively complex information, especially statistical data, in an orderly form.

To make a chart:

- 1) Arrange your information according to what it is you want to say.
- 2) Be sure that the paper or poster board on which you draw the chart is large enough to contain all the information you need to present and still be readable from a distance. Consider the size of the audience, the presentation area, and the seating arrangement.
- 3) Use pictures and/or easily understood symbols as well as words and numbers.





Example: Compare the following charts.

VITAMIN A: ALTERNATIVE SOURCES OF RDA

Chart #1

SOURCE	AMOUNT
GUAVA	2
ATIS	1
PAPAYA	1 SLICE
MANGGA	3
KAMATIS	6
KALAMANSI	30

Chart #2

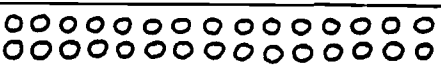
SOURCE	AMOUNT
GUAVA	
ATIS	
PAPAYA	
MANGGA	
KAMATIS	
KALAMANSI	

Which chart is more interesting? Why? Which chart do you think would be more meaningful to a barangay audience?

- 4) Labels and titles should be CLEAR, BRIEF, and ACCURATE.
- 5) Use color to attract and hold attention.

To use a chart:

- 1) Try to avoid explaining the chart to your audience. A well-designed chart should be easily understood.
- 2) Charts can be used by the health educator to involve community members in analyzing and discussing a variety of health and nutrition issues.

• Introduce the topic

• Ask several volunteers to tell the group what the chart means to them. Encourage discussion.

Example:

Facilitator: Maria, what do you think this chart is trying to tell us?

Maria: (answers)

Facilitator: How about you, Emma? What do you think?

Emma: (gives her opinion)

Facilitator: Paz, do you agree with Maria, with Emma? Why do you think we need vitamin A? and so forth...



NOTE: If there is confusion about the meaning of the chart, then it needs to be redesigned to make the message clear.

- 3) Community members can supply their own data for the chart as a prelude to discussion. This approach personalizes the educational message, making it more interesting and meaningful to the audience.

Example:

FOOD HABITS CHART*

To make the FOOD HABITS chart:

- (a) Construct a large FOOD HABITS chart with simple drawings of locally available foods at the top. You may want to group foods with similar nutritional value in the same square (e.g. petersill, malunggay, and kamote tops) so that you will have enough space to present the greatest variety. Provide several blank rows beneath the food pictures. Use an exacto knife (or a razor blade) to cut a small slit in each blank square.
- (b) Cut out a number of paper symbols in three different shapes and colors to represent USUALLY, SELDOM, and NEVER. Leave a small tab attached to each symbol.
- (c) Post the FOOD HABITS chart on the wall where everyone can easily see it. Put the symbols in marked piles in a spot convenient to the chart.

FOOD HABITS CHART

	PINYA	SAGING	MALUNGGAY	ISDA	OKRA	ITLOG	GAMAS	KUHOL	KAROT	KALABASA	PETSAY	TINAPAY	ATIS	ALIMASAG	BABOY	KANIN	TALONG
FATHERS	—	—	—	—	—	—	—	—	—	—	—	—	—	—	—	—	—
MOTHERS	—	—	—	—	—	—	—	—	—	—	—	—	—	—	—	—	—
PREGNANT WOMEN	—	—	—	—	—	—	—	—	—	—	—	—	—	—	—	—	—
CHILDREN 6 MOS-2 YRS	—	—	—	—	—	—	—	—	—	—	—	—	—	—	—	—	—
CHILDREN 2-5 YRS	—	—	—	—	—	—	—	—	—	—	—	—	—	—	—	—	—
	—	—	—	—	—	—	—	—	—	—	—	—	—	—	—	—	—

56

66

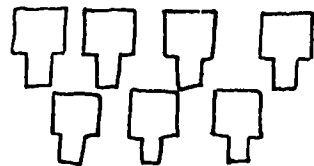

USUALLY

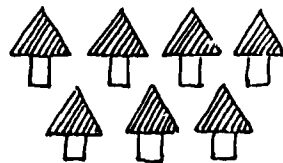

SELDOM

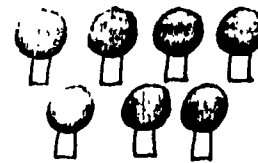

NEVER

67

To use the FOOD HABITS chart:

- (a) Ask the audience to think about how often their family eats each food on the chart - "usually", "seldom", or "never".
- (b) Request 10 or 12 volunteers, one or two at a time, to place the appropriate symbol under each food by inserting the symbol tab into the slit. Each participant should use one row for his/her symbols.
- (c) After all the participants have finished placing their symbols, ask the following questions:
 - What foods do most people eat most often?
 - What foods are only eaten by a few people?
 - What foods are never eaten?
- (d) Lead a discussion about why some foods are eaten more often than others. Try to consider issues of cost, availability, traditional beliefs, and customs.

Alternative procedure:

- (a) Rather than (or in addition to) using individual replies, ask the group to respond on the first line for all fathers; on the second line for all mothers; on the third line for all pregnant women; on the fourth line for all children from 2 to 5 years old; and on the fifth line for all children from 6 months to 2 years old.
- (b) Discuss the different eating habits of each category and why they differ.
- (c) Discuss the food needs for the different groups and how current habits can be improved.

*Adapted from Bridging the Gap: A Participatory Approach to Health and Nutrition Education, (Westport, Connecticut: Save the Children 1982). pp. 45-46.

Example:

SEASONAL PATTERN CHART

Making a seasonal pattern chart enables community members to see how a variety of factors affect their health and the well-being of their families. It helps them identify some of the causes for health problems and promotes discussion of possible solutions. The chart also assists the health worker in planning programs and presentations for the most appropriate times. For example, immunization programs can be scheduled for times when the rivers are low and roads in relatively good condition to encourage the maximum number of families to participate; nutrition programs can be designed with respect to seasonally available foods. Information about, and preventative measures for, certain specific diseases can be offered when it is most timely.

To make the SEASONAL PATTERN CHART:

- a) Reproduce the sample chart on a large piece of brown paper.
- b) Explain to participants that you are going to ask them to consider all the factors that regulate the pattern of their lives and that affect their health and well-being. The factors should be general and common to the whole community. The various conditions will be listed in the appropriate monthly column.
 - Climate: Which months are dry? When is rainy season? When are typhoons most frequent? What are the hot months? Is wind a problem?
 - Geographical Conditions: Do roads wash out during the rainy season? Are rivers always crossable? Is dust a problem in the dry season? Is the water supply affected by seasonal variation? Are insects more of a problem at one time than another?
 - Food Production (agriculture, animal husbandry, fishing): When do the farmers plant? cultivate? fertilize? harvest? Which crops? How do the seasons affect the fishing industry? chicken raising? pig breeding?
 - Food Availability: Which foods are available when? Is there a period of general shortage?
 - Economic Factors: When do people seem to have the most money? the least? When are expenditures the greatest?
 - Social Factors: What holidays does the community celebrate? Does the community participate in any seasonal sporting or recreational activities? When are school vacations? Are weddings more frequent at a certain time of year?
 - Health/Sickness: At what time of the year do people suffer the most from colds and other respiratory ailments? Are diarrheal diseases more common during a certain season?

SEASONAL PATTERN CHART

FACTORS	JAN	FEB	MAR	APR	MAY	JUNE	JULY	AUG	SEPT	OCT	NOV	DEC
CLIMATE												
GEOGRAPHICAL CONDITIONS												
FOOD PRODUCTION												
FOOD AVAILABILITY												
ECONOMIC												
SOCIAL												
HEALTH/ SICKNESS												
OTHER												

What about childhood diseases such as measles, mumps, chicken pox, etc? Do there seem to be more cases of malaria at one time than another?

- c) Try to get a consensus as the different factor categories are discussed so that the chart reflects conditions in the community as accurately as possible. Ask a volunteer to note the factors on the chart as each is discussed and agreed upon.

If the audience is too large to permit everyone an opportunity to express his/her opinion, ask participants to break up into 3 or 4 smaller groups to discuss the various factors amongst themselves. A representative from each small group can then report to the group-at-large and the master chart filled out accordingly.

- d) Next, ask participants to examine the chart closely. Can they observe any relationship between the general health of the community and other factors? Do any of these factors influence the health and well-being of community members? Can any of these factors be controlled or modified to improve health conditions? How?
- e) Encourage the audience to see that they have the power to modify their social, physical, and economic environment in order to promote good health in their community.
- f) Schedule a follow-up meeting to set goals, assess resources, and devise an action plan. This might be accomplished by introducing the bridge-building activity described on pages 71-72.

3. DIAGRAMS

A diagram is a drawing of the parts of something, or how something works. One might diagram the layout of a backyard garden...

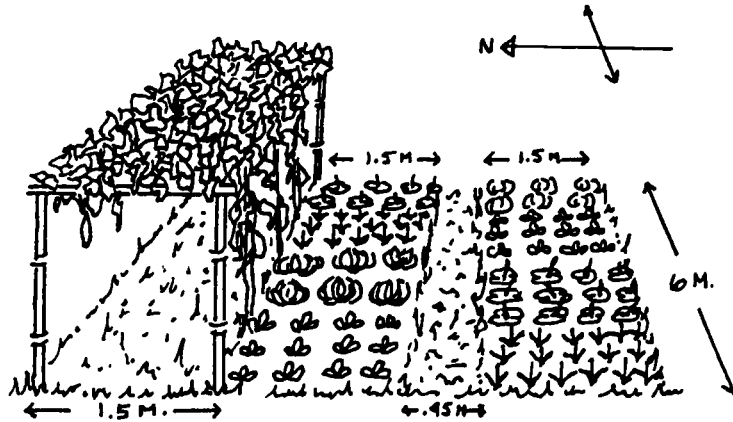

or the parts of a pump...

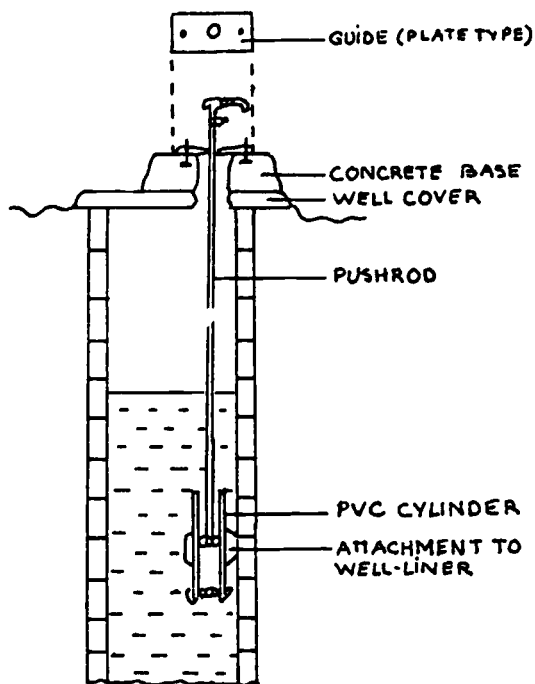

or the progression cycle of excreta-borne diseases.

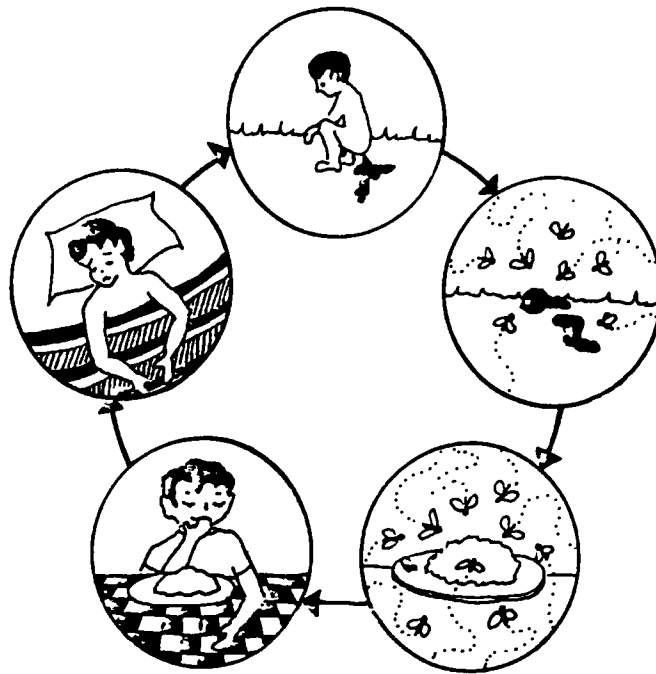

Diagrams do not always have to be drawn on paper or poster board. They could be drawn on clear plastic or acetate for use as overlays...

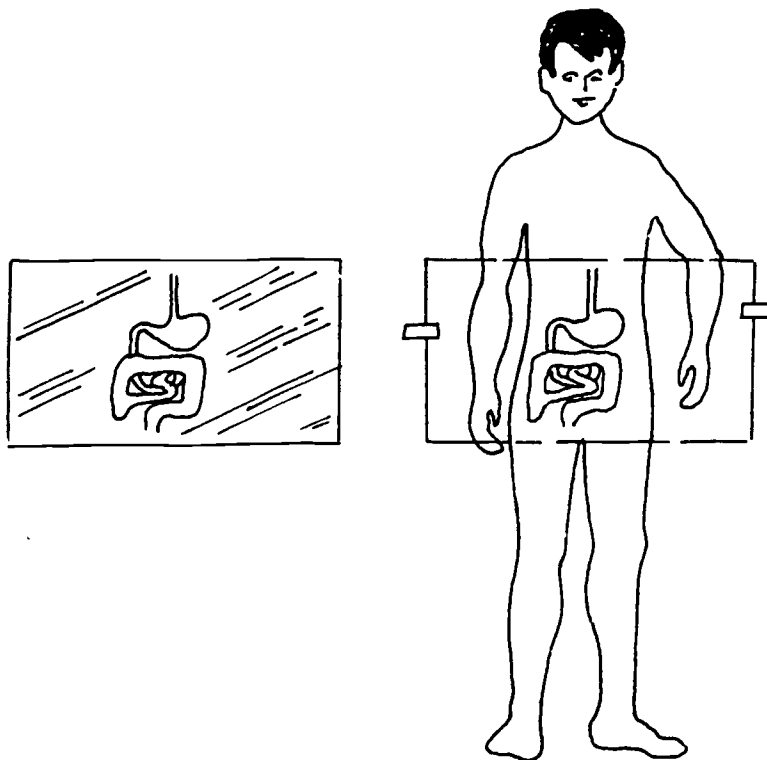

or on a T-shirt for greater realism.

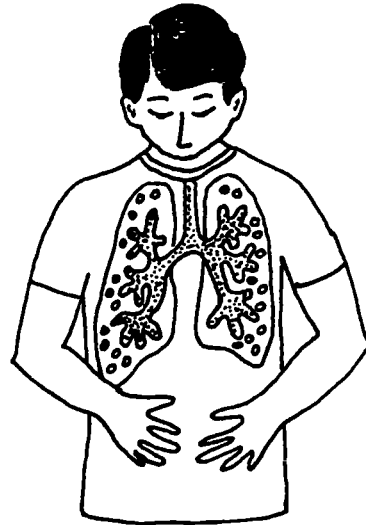

To make a diagram:

- 1) Regardless of subject matter or means of presentation, a diagram should be clear, accurate, and easily understood.
 - include all essential information
 - omit all unnecessary details
- 2) Keep words to a minimum. If you need to label the parts (as in the diagram of the pump), make sure that it is absolutely clear to what they refer.
 - use the language of the target audience
 - print legibly

To use a diagram:

Diagrams are a good visual support for technical information. They generally need to be explained, either verbally (in discussions about component parts, function, relationships of one part to another, etc.) or in print (in a "how-to" pamphlet, for example).

Whenever possible, the health educator should ask a member of the audience who may be familiar with the subject under discussion to explain the diagram to the rest of the group. Participants should be encouraged to ask questions and express opinions.

Community members can also be invited to draw their own diagrams on the chalkboard or a piece of brown paper.

4. FLIP CHARTS

Flip charts are a series of pictures joined together at the top in such a way that each picture may be flipped over to the back in order to expose the next image. Flip charts can be used to show a sequence of events or to illustrate a discussion of alternatives - different types of toilet construction, for example.

To make a flip chart:

1) Plan your presentation.

- Outline your script. Plan on asking your audience to describe what they see. Ask leading questions. Encourage discussion.
- Conceptualize the visual images that will illustrate your presentation.
- Make a storyboard. Draw rough sketches of each visual image you are going to use and write down what you want to say about each one. Note what kinds of questions you will raise.

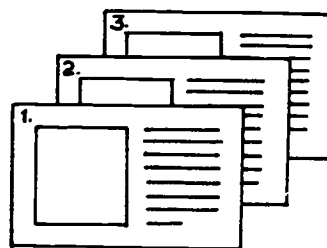
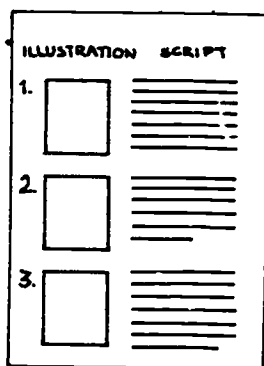

- Indicate the sequence on paper or make the storyboard on 3" x 5" cards. The advantage to putting each image with the accompanying script on individual cards is that the cards can easily be arranged and rearranged to produce the most effective presentation sequence. After the order has been determined, number the cards sequentially.

2) Pretest your presentation.

Before you spend a lot of time and energy doing finished artwork, show your storyboard to your family, your friends, and your professional colleagues. Ask them to give you an honest evaluation. Pay attention to their suggestions and modify the visual ideas and the script accordingly.

3) Complete the finished artwork.

- Draw the visual images on separate pieces of heavy paper. Include a title page. Be sure each picture is large enough to be seen easily by every member of your audience. If you are going to include words, print them clearly in bold type. Keep copy to a minimum.

.To make it easier to remember the verbal presentation, write down the part of the script that goes with each picture on the back of the page before. Along with the writing, include a small copy of the picture that is being shown. This way you'll know what the group is looking at.

4) Make the flip chart self-supporting.

- Cut two pieces of 1/8" plywood (or heavy, stiff cardboard) about 1" wider and 1" longer than the chart.
- Drill two matching holes in the top of each board.
- Punch matching holes at the top of each flip chart page.
- Sandwich the paper between the two boards and fasten together with metal rings. If these are not available, use two loops of heavy twine.
- To keep the stand from spreading apart, drill one hole in the bottom center of the back board. Notch the bottom of the cover board in the center. Thread a piece of heavy twine through the bottom hole and knot each end. Stand the chart up by flipping the cover board to the back and sliding the knotted string into the notch.

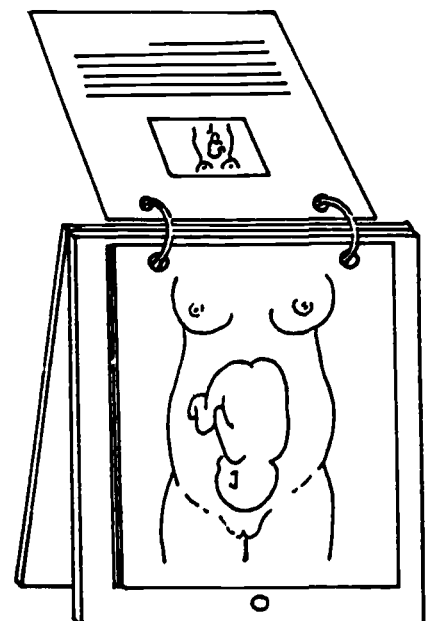
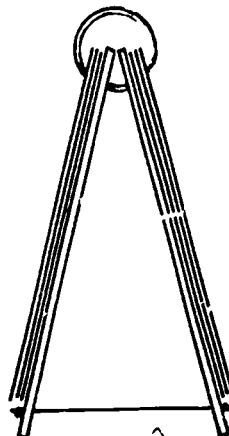
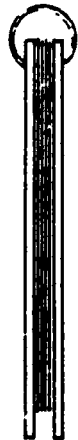
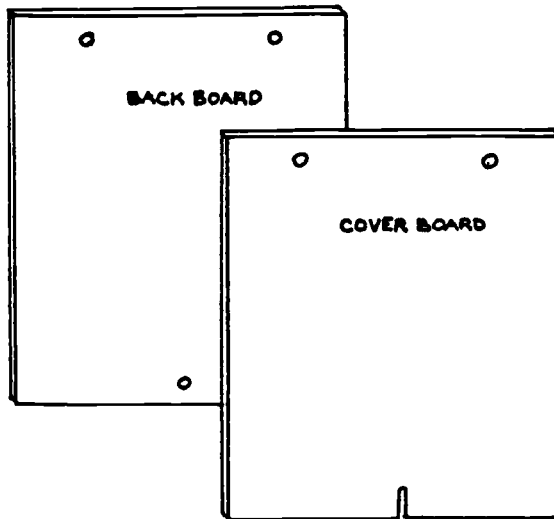

An alternative method:

- 1) Draw the chart on brown paper.
- 2) Bolt the paper between two narrow strips of wood that are a little longer than the width of the paper.
- 3) Loop string around each end of the wooden strips to make a hanger.
- 4) Roll the chart for easy transport and storage.

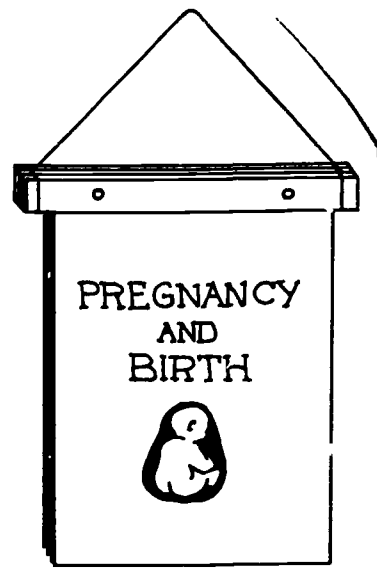

5. FLANNELBOARD

A flannelboard is a display board on which pictures may be easily placed, moved about, and taken off.

To make a flannelboard:

- 1) Cover a piece of plywood or fiberboard with felt, flannel, burlap, or other textured cloth. The fabric may be glued, taped, or stapled to the board. (See Section 1, page 53 for a combination chalkboard/flannelboard.)
- 2) The textured side of a piece of masonite (lawanit) works well as a flannelboard without requiring a fabric covering.
- 3) An improvised flannelboard can be created by folding a blanket over the backs of a couple of chairs.

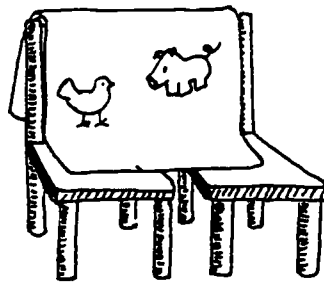

- 4) Pictures for the flannelboard can be cut from magazines or posters. They can also be drawn by the health worker or by the participants themselves.
 - Glue a piece of felt, flannel, or medium grade sandpaper to the backs of pictures so that they will stick to the flannelboard.
 - An alternative to this is to spread white glue or flour-and-water paste on the backs of the pictures. Sprinkle rice hulls or sand over the wet glue and let dry.

To use a flannelboard:

- 1) Prop the flannelboard in a near-vertical position. The board should tip back slightly to prevent pictures from sliding off.
 - Make a portable bamboo stand from three poles and some string.

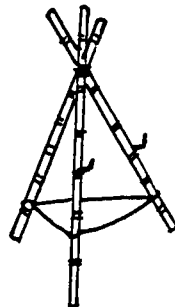

- Set the board on a table and lean it against the wall. Keep board from sliding forward by supporting it with one or two bricks.
 - Prop the flannelboard up on a chair.
- 2) Have all your flannelboard pictures, or materials for making pictures, convenient to the board.
 - 3) Involve your audience in the activity.
 - 4) Don't try to use a flannelboard outdoors on a windy day.

STRING-BOARD (a flannelboard alternative)*

To prevent pictures from falling off or blowing away, you can use a string-board instead of a flannelboard.

To make a string-board:

- 1) Stretch string back and forth across a piece of plywood or fiberboard. Keep the string in place with nails, thumbtacks, or staples.

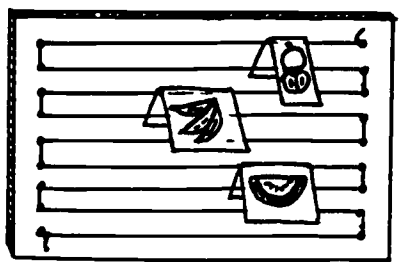

- 2) Prepare the pictures on folded paper or cardboard. Display pictures by hanging them over the strings.

For sample flannelboard activities, please see:

FAMILY PORTRAIT	Section 6, pp. 69-70
FLEXIFLANS	Section 10, pp. 84-87
THE MARKET GAME	Section 11, pp. 88-90

*Source: Werner & Bower, Helping Health Workers Learn, p. 11-19.

6. POSTERS

A poster is a two-dimensional picture sign which can be posted on a wall or other surface. Hence the name "poster". Although posters may sometimes include words, they communicate visually rather than verbally.

Health educators can use posters in a number of different ways to stimulate audience participation and help convey an educational message.

COMPARATIVE POSTERS

Comparative posters may be used to stimulate discussion about how undesirable situations can be improved or to explore the necessary conditions for good health as opposed to the contributing causes of illness.

For example:

FAMILY PORTRAIT

- 1) Make a pair of comparative posters about 30 cm. x 40 cm. (12" x 16"). On one poster draw a sad, unhealthy family. On the other show a happy, healthy family.



- 2) Cut out 20-24 cards 7 cm. x 10 cm. (3" x 4"). On half the cards draw pictures of conditions that cause poor health.

e.g. bottle-fed baby
unsafe water supply
lack of toilets
unpenned animals
insects and rodents

junk food
cigarettes/alcohol
someone spitting
child urinating in a stream
uncovered food with flies

On the rest of the cards, draw pictures of good health practices.

e.g. breast-fed baby	backyard garden
safe water supply	covered food
toilet	balanced diet
penned animals	fruit and vegetables
clean, neat house and yard	immunization

- 3) Glue sandpaper to the backs of both posters and all the cards.
- 4) Display posters side by side on a flannelboard or tape them to the wall. Shuffle the cards and distribute them randomly amongst the group of participants.
- 5) Ask participants to look at their cards and decide whether the picture represents a cause of good health or of sickness. Invite them one at a time to place their cards on the flannelboard next to the appropriate poster. Participants should explain to the rest of the group why their picture card represents a good, or bad, health practice.

Another example:

SANITARY ENVIRONMENT

- 1) Prepare a poster illustrating an unsanitary living environment.
- 2) Display the poster and ask participants to describe what they see.
- 3) Give participants a piece of blank poster board and some marking pens. Ask them to draw a poster showing what could be done to make the environment safer and more healthy. If the group is large, divide them into two or three smaller groups and have each group make a poster.
- 4) When they are finished, participants should display their posters and explain how an unhealthy environment can be improved.
- 5) Ask the group if any of the conditions shown in the first poster exist in their barangay. What can they realistically do to improve their own living conditions?

One more example:

THE BRIDGE TO HEALTH*

The Bridge to Health is built between comparative posters drawn by participants. It is a systematic way to analyze problems, set goals, and plan interventions using local resources.

- 1) You will need to assemble the following materials:
 - 2 blank pieces of poster board
 - a piece of string 60 cm. (24") long
 - a COMMUNITY EFFORT sign, 10 cm. x 30 cm. (4" x 12") folded lengthwise
 - several long strips of colored paper, 2 cm. x 60 cm. (1" x 24")
 - several numbered cutouts resembling bare feet
 - colored marking pens
- 2) Invite community members to identify situations in their baran-gay that might be modified to promote better community health.
- 3) Next to each problem situation on the list, have participants write a community goal for solving the problem. For example, community members may note that very few families have toilets, animals wander freely throughout the barrio, and that some people draw water from unsafe sources.

These, then, are the problems. The goals might be a sufficient number of toilets and pumps to service the needs of the whole community, and fences for the animals.
- 4) Ask one or two volunteers to draw pictures of the problems on one poster and to illustrate the solution goals on another. Tape the two posters to the wall 45 cm.-60 cm. (18"-24") apart.
- 5) Discuss how these problems might be solved through community effort. Tape the string to the wall between the PROBLEMS poster and the GOALS poster. Hang the COMMUNITY EFFORT sign on the string. Explain to participants that this represents the hand-rail and cable for the bridge.
- 6) Discuss available resources with community members. As each resource is identified, ask a volunteer to write the name of that resource on a colored strip of paper and hang it between the two posters a few inches below the COMMUNITY EFFORT cable. The Bridge to Health will be built with these resources.
- 7) Ask the group: "Using these resources, what is the first small step you can take to solve the problem and reach your goal?"

When participants decide on a step, write the proposed action on foot #1 and blind-tape it to the wall at the beginning of the bridge in the direction you are going.
- 8) Continue to discuss a step-by-step plan. Each time a step is

agreed upon, write it on the next foot and tape it to the bridge approaching the community goals.

- 9) Community members can decide to establish a time schedule for the proposed activities and choose the ones they will participate in.

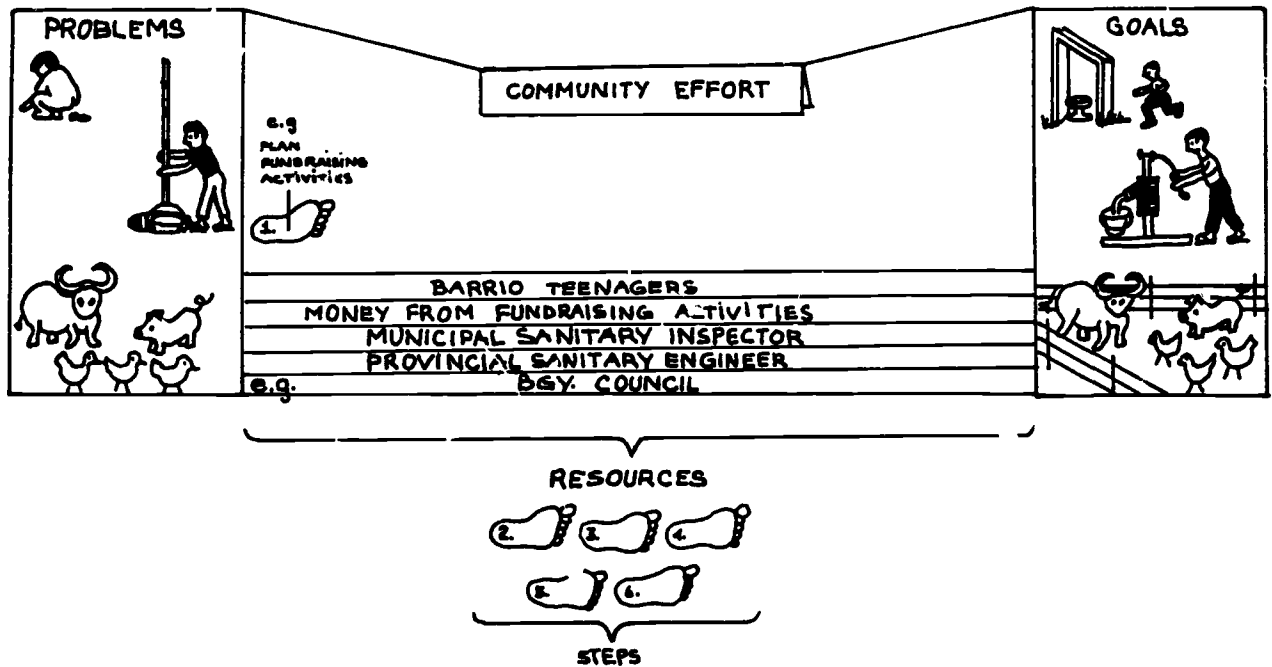

*Adapted from Bridging the Gap: A Participatory Approach to Health and Nutrition Education (Save the Children 1982). pp. 93-94.

SEQUENCE POSTERS

Sequence posters are useful to describe multi-step procedures such as water supply purification, the steps in preparing an herbal medicine, the various stages in a disease progression - in other words, any procedure that takes place according to an established order.

Sequence posters have an advantage over flip charts by enabling the health worker to display the several steps of a procedure at a single time. When participants can see the sequence in its entirety, they are better able to establish the order of, and the connection between, the several steps. The facilitator can also encourage group participation by asking volunteers to place the posters in their proper order, and to explain their reasons for the sequence.

When making sequence posters, be sure to include all the steps in the procedure. Be sure, too, that the visual elements are consistent in scale and style from one poster to the next.

DISPLAY POSTERS

A display poster is one of the most cost-effective ways to send an educational message to the largest possible audience. It can be used to announce an event, provide information, or influence a change in behavior.

Unlike comparative posters and sequence posters which are generally used in conjunction with demonstrations, discussions or other educational activities, a display poster has to stand on its own. There is no opportunity for verbal support.

- A display poster has to be DYNAMIC, COLORFUL, and BOLD to attract attention because it has to compete with many other stimuli in the immediate environment.
- A display poster must have a SHORT, SIMPLE, DIRECT MESSAGE. Display posters do not usually command sustained attention. They have to get the message across in a matter of seconds.
 - In a display poster, visual and verbal elements must reinforce one another to communicate a SINGLE, UNIFIED MESSAGE with CLARITY AND IMPACT.

To make a display poster:

- 1) Write the headline/copy.
 - Compose a brief slogan to convey your educational message. Keep it simple. A catchy phrase or a rhymed couplet is often a good way to make a message memorable.
 - If the purpose of the poster is to announce an event, include all pertinent information: what it is, where it is, when it is.
- 2) Select a visual image that reinforces the verbal message. Keep it simple and bold. Use bright colors.
- 3) Make several thumbnail sketches of your idea illustrating scale, color, placement. Show the sketches to your family,

your friends, and your professional colleagues. Ask them to help you select the most effective design.

- 4) Once the selection has been made, draw the design actual size on a piece of tracing or brown paper. Make any necessary revisions or corrections.
- 5) Transfer the design to a piece of poster board and complete the finished artwork. If you plan to make multiple copies of the poster, prepare the artwork for reproduction.

7. COMIC BOOKS

A comic book presents a story in picture form. The plot is developed by means of conversation between the characters. The words spoken by each character are shown in a "balloon" over the character's head. With the exception of the title and words indicating a time change (e.g. "later...", "the next day...", etc.), no other copy appears in a comic. Action and descriptive detail are communicated by the pictures themselves.

Reading a comic is an individual activity. The story should be entertaining in order to hold the reader's attention. The educational message must be simple and clear. Pictures ought to reflect the lifestyle and experience of the target audience.

Comics provide an effective way to send a health message into the community. They are simple to make and inexpensive to reproduce.

To make a comic book:

- 1) Choose your topic. Write a brief message that conveys clearly the point you want to make.
- 2) Decide how you will develop your story. Write a synopsis of the action.
- 3) Make a storyboard. Draw rough sketches of the pictures you plan to use. These are called frames. Write the dialogue for each frame right next to it.
- 4) Lay out the comic book. Use your storyboard to determine the number of frames and how many pages you will need.
 - Plan to reproduce the comic book on legal size (8½" x 13") paper. Folded in half crosswise, legal size paper will make a 6½" x 8½" booklet.
 - Each sheet of 8½" x 13" paper is equal to 4 comic book pages.
 - You will be able to get 4 to 6 frames on each comic book page.
 - The layout for an 8-page comic book with 4 frames per page looks like this:

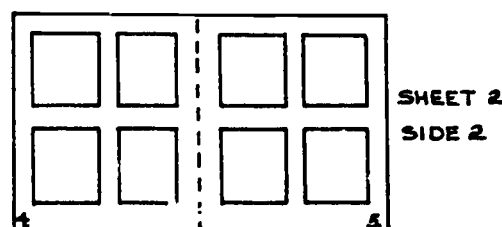
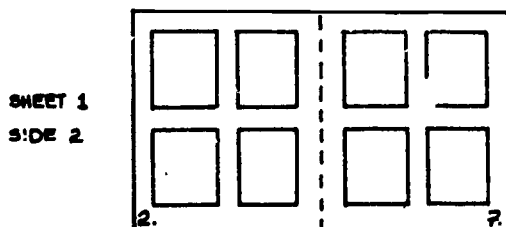
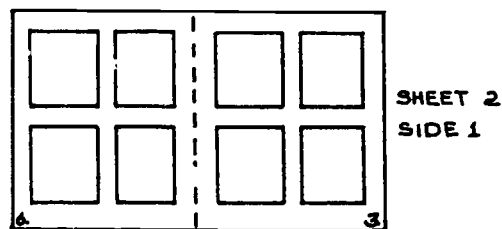
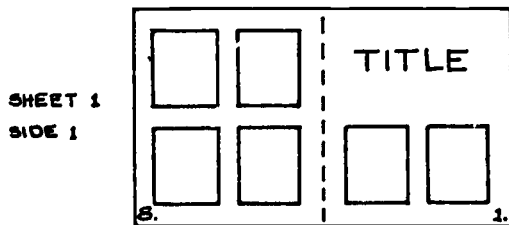

•The layout for a 12-page comic book with 6 frames per page looks like this:

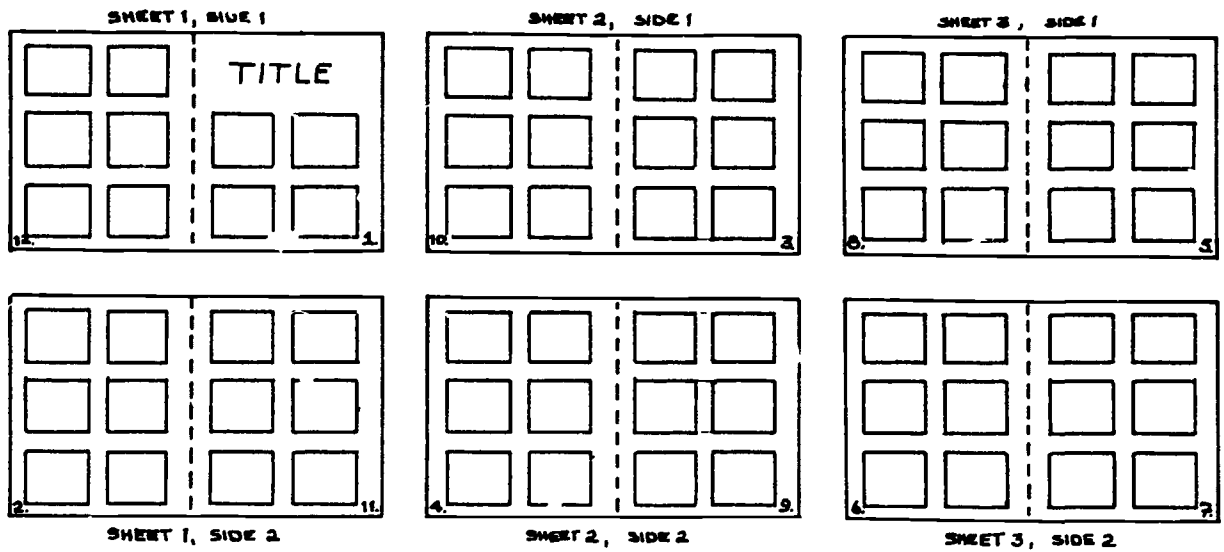

•Notice the numbering of the pages. Make a practice book from scrap paper to see how the pages go together. The practice book is called a dummy.

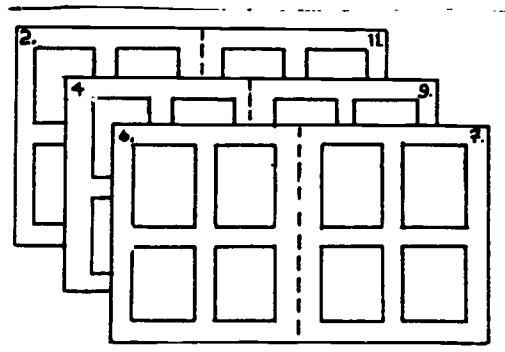

5) Develop the artwork.

- Letter the title in a bold type style.
- Make the drawings for each frame
- Print dialogue clearly and legibly in the balloons.

NOTE: It is customary to draw the balloon for spoken words like this:

SAAN KA PUPUNTA?



To indicate what a character is thinking, draw the balloon with little "bubbles" like this:





- 6) Rule out all the frames on a Gestescript stencil. You will need a separate stencil for each side of each sheet. Carefully copy the artwork and dialogue into each frame.
- 7) Reproduce the comic book on a mimeograph machine. Collate, fold, and staple the sheets together.

8. PAMPHLETS

A pamphlet is a small, unbound booklet made from two or more sheets of paper stapled together into pages. Reading a pamphlet is an individual activity. Because pamphlets are small and inexpensive to reproduce, they are an ideal way to send an educational message into the community. They are particularly useful for teaching people how to do something: how to construct a water sealed toilet, for example, or how to install a pump, or how to cook certain nutritional foods.

To make a pamphlet:

- 1) Identify the target audience and design the pamphlet accordingly. Consider interests, educational level, and local traditions.
- 2) Write the copy. Keep your message simple, direct, and to the point. Use language and vocabulary that the reader will understand.
- 3) Never assume that the reader has any prior knowledge about the subject. Explain every step clearly.
- 4) Conceptualize the visuals that will accompany the written message.
 - A bold or provocative cover design will attract attention.
 - Line drawings add interest and help to hold the reader's attention.
 - Diagrams can clarify technical information.
 - Charts can present complicated data clearly in a limited space.
- 5) Make a rough "thumbnail" sketch for each visual image.
- 6) Once you can see how much copy you have, and how many pictures, you can determine the size of the pamphlet, number of pages, and general layout.
 - Consider the paper size and printing method. Since mimeograph is the simplest and least expensive method of reproduction (and since this is an instruction manual for low-cost visual aids), we will offer sample sizes and layouts for 8½" x 11" and 8½" x 13" only.

# FOLDS	EXAMPLE	# PAGES	SHEET SIZE	PAMPHLET SIZE
1		4	8½" x 11" 8½" x 13"	5½" x 8½" 6½" x 8½"
2		8	8½" x 11" 8½" x 13"	4¼" x 5½" 4¼" x 6½"
3		16	8½" x 13"	3¼" x 4¼"

• Make a dummy. Use a piece of scrap paper the same size that you will use for printing and fold it to create the desired number of pages. If you plan to use two or more sheets of paper for each pamphlet, fold these also. Stack them together prior to making the final fold.



• Once the sheets are folded and stacked, number each page consecutively on the bottom. Then open the sheet out flat. You will see that consecutive pages do not necessarily lie next to each other. The order of the pages on the flat layout is called the page imposition.

• Below are examples of page impositions for 2 and 3-fold pamphlets. For single fold pamphlets, follow the instructions for comic books (section 7, pp. 75-76).

PAGE IMPOSITIONS

• 1 sheet, 2 fold (8 pages)

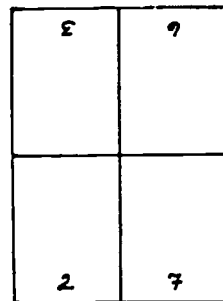
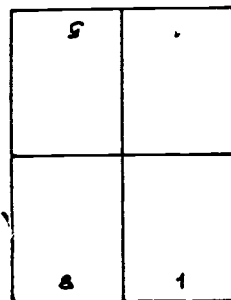

• 2 sheets, 2 fold (16 pages)

13	4
14	1

3	14
2	15

9	8
12	5

7	10
6	11

• 1 sheet, 3 fold (16 pages)

8	1
9	14
12	13
5	4

6	3
11	14
10	15
7	2

• 2 sheets, 3 fold (32 pages)

8	1
25	32
28	29
5	4

6	5
27	30
26	15
7	2

16	6
17	42
20	12
13	12

14	11
19	22
18	23
15	10

7) Make a sample layout.

• Measure the pamphlet size and figure out how many typed characters will fit on one line of copy.

pica typewriters: 10 characters/inch
 elite typewriter: 12 characters/inch

Allow for margins.

•Example:

A 2-fold, 8 page pamphlet printed on $8\frac{1}{2}$ " x 11" paper has a $4\frac{1}{4}$ " x $5\frac{1}{2}$ " page size. Allowing for a $\frac{1}{4}$ " margin on either side of the copy, there remains $3\frac{3}{4}$ ".

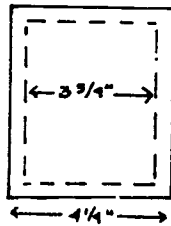

To figure the length of a line of typed copy, multiply the number of inches times the number of characters per inch.

$$3\frac{3}{4} \times 10 = 37 \text{ characters (pica)}$$
$$3\frac{3}{4} \times 12 = 45 \text{ characters (elite)}$$

(If you are hand-lettering the copy, write it all out in columns of the correct width.)

- Type all the copy in columns no wider than the total number of characters your page size will accomodate.
- On a large piece of brown paper, rule each page spread to actual size. A page spread shows the pages consecutively as they will appear to the reader.

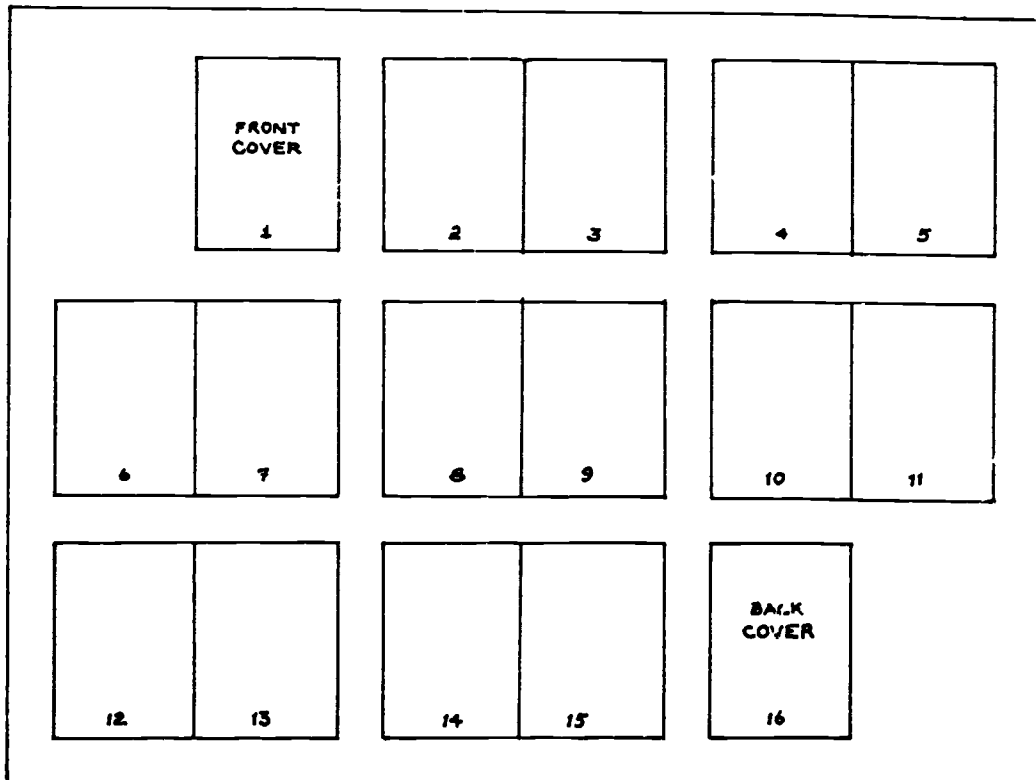

- Cut the columns of copy apart and lay them out on the page spreads so that you can see how the pages will look. Make the drawings to size and place them in position on the appropriate pages. Make adjustments as necessary until you are completely satisfied with the layout of the pamphlet.
- Accurately rule a sample layout on a piece of paper the same size as you will use to print. Number the pages according to the correct imposition (see above, pp. 79-80).
- Beginning with page 1, shift the copy and visuals from the sample page spreads to the correct page on the layout. Be sure that the copy and the visuals are facing in the right direction. Paste them in position.
- Follow the finished layout to cut the stencil.
- Run off the desired number of copies on the mimeograph machine. Cut the pages as necessary. Collate and staple.

9. FLYERS

Flyers often serve the same purpose as pamphlets but on a smaller scale. Because they are printed on a single sheet, they are simpler to produce than the multipage pamphlet. Flyers can be presented flat or folded, depending on your needs. In addition to being a simple way to provide technical information or instructions, flyers can also be used to make announcements.

To make a flyer:

- 1) Decide what you are going to say and how you are going to say it.
- 2) Determine the size and format of the flyer.



flat



single fold



2-fold



double fold

- 3) Make a dummy if you are planning a folded presentation. Make a rough sketch of the layout on the dummy.
- 4) Type or write the copy to fit the page size.
- 5) Develop any visual elements - drawings, diagrams, charts, etc. - that you are going to include.
- 6) Paste the copy and artwork in position on a sample layout.
- 7) Follow the layout to cut the stencil.
- 8) Mimeograph the desired number of copies. Fold if and as required.

10. FLEXIFLANS*

Flexiflans are cutout figures approximately 12 cm. - 16 cm. (5" - 6"). They have movable joints and are able to take on a variety of attitudes and postures. The figures are backed with sandpaper for use with a flannelboard.

To make flexiflans:

- 1) Plan on making a wide variety of figures and objects. You will need many types of people: young and old, boys and girls, healthy and sick. Make cutout figures of animals, tools, vehicles, houses, schools, health units, and other buildings, as well as landscape features like trees, crops, rivers, etc.
- 2) Sketch the individual parts of each figure on lightweight cardboard, then cut them out. Color the parts with marking pens or paint before assembling. Details can be added with a fine tip marking pen after the flexiflans are put together.
- 3) Fasten joints with eyelets (check with a local dressmaker or a home economics teacher). Alternatively, sew them together so that the figures are flexible yet stiff enough to hold a position.
- 4) Glue one or two squares of sandpaper or other coarse material on the back of each figure.



SUGGESTION: Enlist the aid of a high school art teacher. Making the flexiflans could be a fun and useful project for young people.

To use flexiflans:

This activity allows people to share their views instead of focusing on the views of the health worker. A wide variety of flexiflan figures can provide an audience with a visual means to express their ideas and illustrate discussions of their needs, problems, and aspirations.

- 1) Introduce flexiflans as a way to depict community life. Show the audience how the figures can be flexed to take on different positions and to represent action.
- 2) Invite a few volunteers to come forward and depict a situation in their community by placing selected flexiflans on the flannelboard. Suggest that they focus on a problem or a community need.

*Source: Bridging the Gap: A Participatory Approach to Health and Nutrition Education (Save the Children 1982). pp. 30-31.

Sample FLEXIFLAN (actual size)

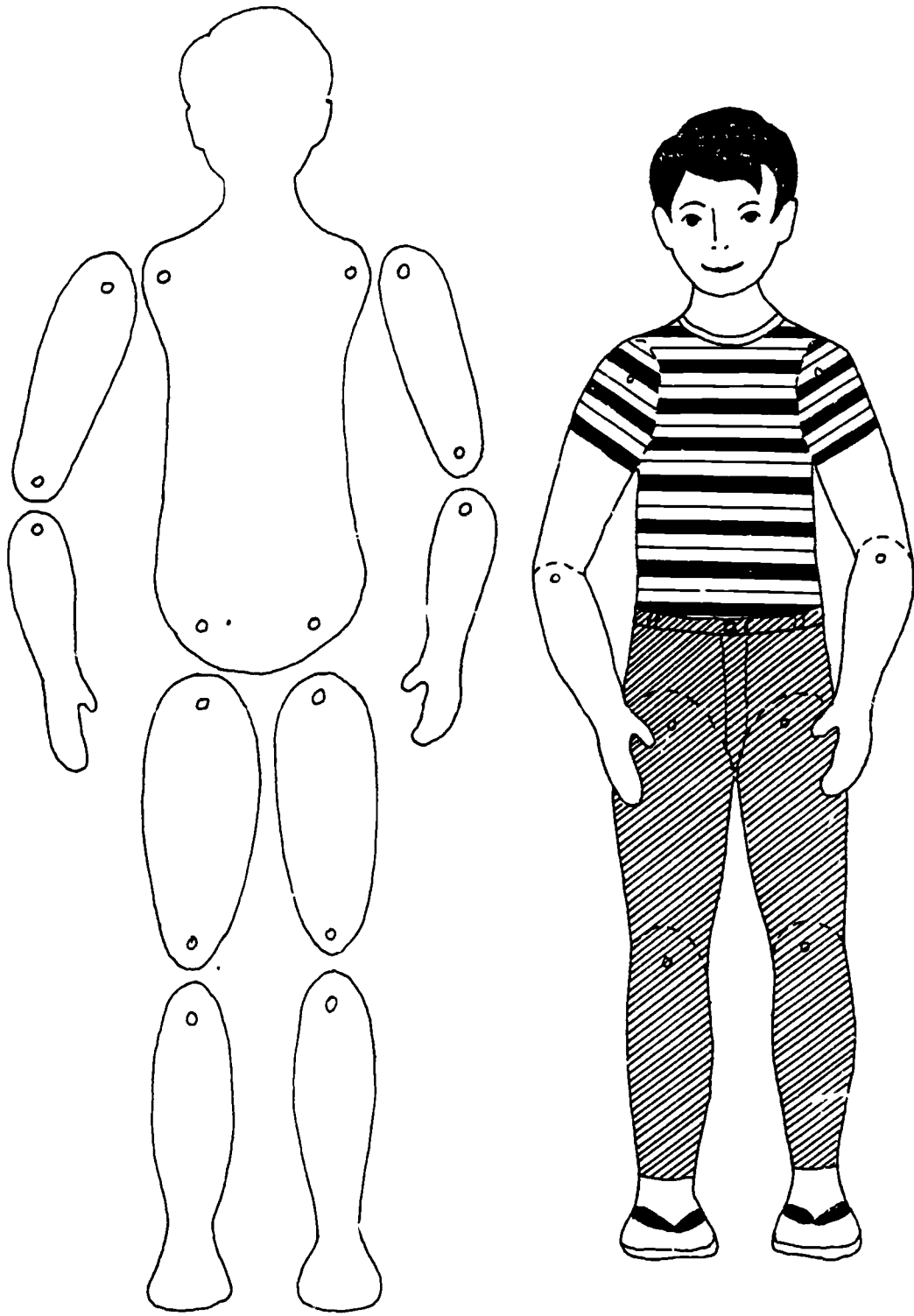

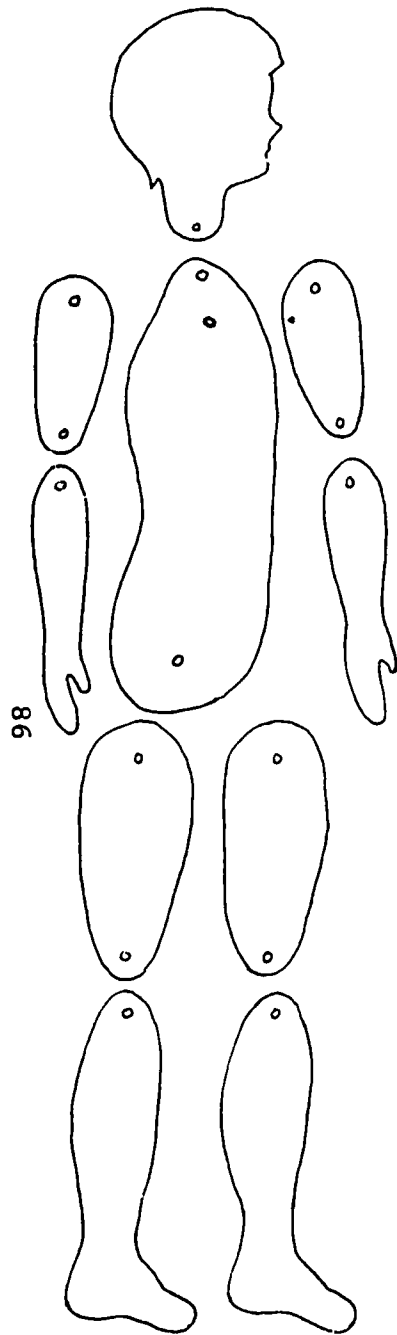

98

98

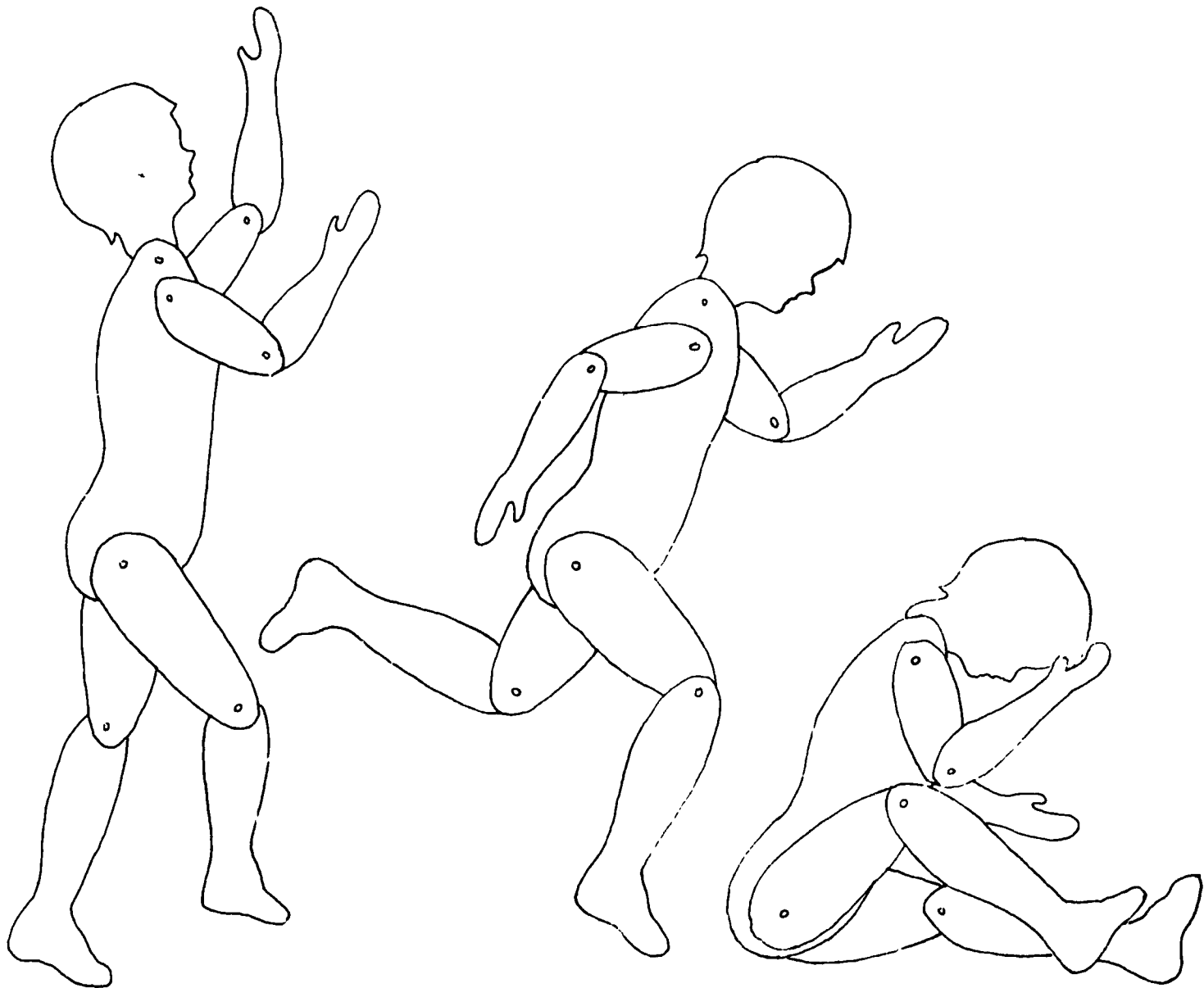

99

- 3) The participants placing the flexiflans can explain the situation they have depicted. Others can be asked for their observations regarding the situation.
- 4) When a community problem has been depicted with the flexiflans, the participants can rearrange the figures to illustrate their aspirations for the community. Alternative methods for realizing these aspirations can then be discussed.

Flexiflans may also be used to illustrate a health story in order to stimulate discussion about good health practices and to explore different alternatives for solving a problem.

- 1) The facilitator presents a common health problem in the form of a dramatic story. The story should be realistic. Problems are rarely simple and clear-cut. They are generally a result of a number of physical, social, political, and economic factors. All the extenuating circumstances need to be considered and woven into the story.
- 2) The story should be illustrated using the flexiflan figures. The characters should be given names and the action set in a barangay similar to the one in which community members live.
- 3) Once the problem situation has been described, invite participants to complete the story. Encourage them to explore alternative solutions.
- 4) Ask participants if they have encountered similar problems in their own community. How was the problem solved? If the situation remains unresolved, what are some possible courses of action?

11. GAMES

Learning games are an excellent way to reinforce an educational message in a relaxed and friendly atmosphere. Games provide a change of pace from more formal presentations and have the advantage of being able to stimulate maximum audience participation. Games require players to think about and use the knowledge they have acquired. Team activities promote cooperation amongst participants.

There are countless games which may be devised or adapted for the purposes of health and nutrition education: card games, board games, guessing games, action games, team games. There are games which may be played with as few as two or three participants, and others that can accommodate 20 or more players.

On the following pages you will find some suggestions for a variety of learning games. Try them out. They are easy and fun to play. Then try to devise some games of your own.

THE MARKET GAME*

This is a good activity for introducing and explaining the three basic food groups to a community meeting.

To prepare the market game:

- 1) Draw and color pictures of a wide variety of local foods on separate pieces of heavy paper or poster board. You may want to make duplicates of the most common foods such as rice, fish, chicken, and pork, etc. Be sure you draw more items from each of the three basic food groups than there will be number of players.
- 2) Glue a piece of sandpaper to the back of each picture.
- 3) Cut three strips of paper 10 cm. wide and 30 cm. long (4" x 12"). Print the name of a basic food group - energy-building foods (tagapag-bigay ng lakas), body-building foods (tagapag-buo ng katawan), and body-regulating foods (tagapag-saayos ng katawan) on each strip. Glue sandpaper to the backs of the three food group labels.
- 4) Make a basic food group chart or get one from the Nutrition Center of the Ministry of Health in Manila.

To play the market game:

- 1) Set up a large flannelboard and randomly display all the food pictures.
- 2) Tell your audience that the flannelboard represents the market. Invite them to come to the "market", two or three

at a time, to select one or two food items that they would like to "buy".

- 3) After all the participants have "bought" their food, clear the flannelboard of any leftover food pictures.
- 4) Display the food group labels across the top of the board and briefly discuss the three basic food groups with your audience. Explain about energy foods, body-building foods, and body-regulating foods. Explain why we need to eat foods from all three of these groups in order to keep healthy.
- 5) Now, ask participants to guess which group their food item belongs to. Ask them to put their food back on the flannelboard under the appropriate label.
- 6) When all the food has been replaced according to food group, display the basic food group chart. Ask the audience to check their classification with the chart. If they see that their food item has been incorrectly classified, participants should replace it in the proper category.
- 7) After participants have replaced their food items under the appropriate label, select two or three volunteers to classify any remaining food pictures that were not "bought" during the first "trip to market".
- 8) Once again, the audience should be invited to go to the "market". Ask them each to "buy" three foods for their lunch or dinner.
- 9) When everyone has "bought" their food, participants should take turns telling the group-at-large what they bought and why.

Alternative method:

- 1) Assign a realistic market value to each of the food items displayed on the flannelboard.
- 2) Give each participant some play money equivalent to the average daily food budget for that community group.
- 3) Ask two or three volunteers to act as vendors.
- 4) Invite participants to go to the "market" and "buy" the food items they will serve to their families for the next three meals.
- 5) After everyone has been to the "market", participants should take turns telling the group-at-large what they bought, how much it cost, and how they will prepare the food.

*Developed by Gilda Danoco, President Ramon Magsaysay Memorial Hospital, Iba, Zambales, Philippines.

HEALTH PROBLEM CARD GAME*

To make the card game:

- 1) Make a list of 25 local health problems along with a possible solution or method of prevention for each.
- 2) Cut heavy poster paper into 50 cards 7 cm. x 10 cm. (3" x 4").
- 3) On 25 cards draw pictures to illustrate the problems. On the other 25 cards, draw pictures to illustrate a solution or preventative measure for the problem. Number each pair of cards from 1 to 25.

Card Game #1 (for 5 players and a facilitator):*

- 1) The facilitator deals 5 solution cards to each player. The problem cards are placed face down on the table.
- 2) One problem card is turned up. The players search their cards for the solution card to that problem. The player with the appropriate solution card places it face up on the table with the problem card and explains why it is a solution or method of prevention for the problem.
- 3) Another problem card is turned up and players again search their hands for the solution card. As before, the matching player explains why his/her card is a solution/method of prevention for the problem.
- 4) Play continues in this manner until one player matches all of his/her solution cards. This player is the winner.

Card Game #2 (for 2 - 6 players):

- 1) Problem and solution cards are shuffled together, the pack is spread, and players each draw a card to determine the dealer. Highest number wins the deal. In case of a tie, the solution card takes precedence over the problem card.
- 2) Dealer reshuffles the cards, cuts the deck with the player to his/her left, and deals the cards one at a time in a clockwise direction.
 - For 2 - 4 players, deal 7 cards each.
 - For 5 - 6 players, deal 5 cards each.

*Source: Bridging the Gap: A Participatory Approach to Health and Nutrition Education (Save the Children 1982). p. 59.

HEALTH PROBLEM CARD GAME - Sample Cards



91

- 3) The remainder of the deck is placed face down in the center of the table with the top card upturned beside it to denote the discard pile.
- 4) The object of the game is to match problem and solution cards for points. The winner is the player to first accumulate 300 points. Points are earned (or lost) as follows:
 - The first player to pair all the cards in his/her hand - 50 points.
 - For each problem/solution pair on the table - 15 points.
 - For each unmatched solution card remaining in a player's hand - subtract 5 points.
 - For each unmatched problem card remaining in a player's hand - subtract 10 points.
- 5) Each turn always begins with the player drawing a card, either from the stock or from the discard pile. A player may only draw from the discard pile if that card can be immediately matched to a problem or solution card already in the player's hand. The pair is then placed face up on the table and the player must explain why the two cards make a problem/solution pair. If necessary, a player may pick up more than one card from the discard pile provided that the last card picked up is the one to be matched, explained and laid out on the table. Any additional cards that cannot be matched are retained in the player's hand. Every play ends with one card being discarded.
- 6) Play begins on the dealer's left and proceeds in a clockwise direction.
- 7) The first player to get rid of all the cards in his/her hand by matching them to the appropriate problem or solution, calls out "Good health!" Points are then tallied for that hand.
 - The player who ended the hand by matching all his/her cards automatically gets 50 points for "good health". In addition, s/he gets 15 points for every pair s/he matched on the table.
 - Players with cards remaining in their hand must subtract the value of those cards (solution cards - 5 points, problem cards - 10 points) from the total number of points earned by their matched pairs on the table (15 points each).

For example:

- Player A goes out with 4 matched pairs. S/he earns 50 points for "good health" and 15 points for each matched pair: a total of 110 points.
- Player B has 3 matched pairs (15 points each) on the table and 3 solution cards (5 points each) remaining in his/her hand: 45 points less 15 points = 30 points.

- Player C has 3 matched pairs (15 points each) on the table and 1 solution card (5 points) plus 2 problem cards (10 points each) remaining in his/her hand: 45 points less 25 points = 20 points.
 - Player D has 2 matched pairs (15 points each) on the table and 3 problem cards (10 points each) plus 1 solution card (5 points) still unmatched in his/her hand. 30 points less 35 points = -5 points.
- 8) The deal passes to the left and the game proceeds as before. As many hands as are necessary are played until one player accumulates 300 points. This player is declared the winner.

SNAKES & LADDERS*

To make Snakes & Ladders:

- 1) Draw the game board on a stiff piece of poster board 50 cm. (20") square.
 - Each of the 100 spaces should be 5 cm. x 5 cm. (2" x 2").
 - Follow the example on the next page to number each square.
 - Randomly scatter several snakes and several ladders over the board.
 - The ends of each ladder should connect a message about good health. Draw a positive message of good health for each ladder.
 - The head and tail of each snake connect a visual message about the causes of sickness. Draw a negative message of an unsafe practice for each snake.

The following list describes the messages shown on the sample board. Copy these or write others that may be more appropriate for your audience. Be sure that your pictures make the message clear.

Snakes

- 32 - 11: A dirty yard attracts flies, and roaches.
- 40 - 2: Too much salt raises blood pressure.
- 61 - 24: Flies on the food can cause diarrhea.
- 73 - 31: Cigarettes are bad for you.
- 74 - 8: Bottle-fed babies may get sick and die.
- 84 - 55: Drinking alcohol is bad for you.
- 91 - 72: Drinking water from streams and rivers can cause diarrhea.
- 99 - 15: Coke and candy rot your teeth.

Ladders

- 6 - 37: Visiting the RHU for prenatal check-ups protects the life of both mother and baby.
- 10 - 56: Breast-fed babies are fat and healthy.
- 21 - 58: An education prepares you for the future.
- 44 - 95: Brushing teeth gives you a beautiful smile.
- 49 - 70: Boiling water makes it safe to drink.
- 63 - 97: A well-balanced diet makes you strong.
- 68 - 94: Immunization keeps your child healthy.
- 71 - 93: A backyard garden provides food for the family.
- 80 - 100: Limit the size of your family to the number of children you can comfortably afford to feed and care for.

*Adapted from Werner & Bower, Helping Health Workers Learn, p. 11-27.

SNAKES & LADDERS (sample board)

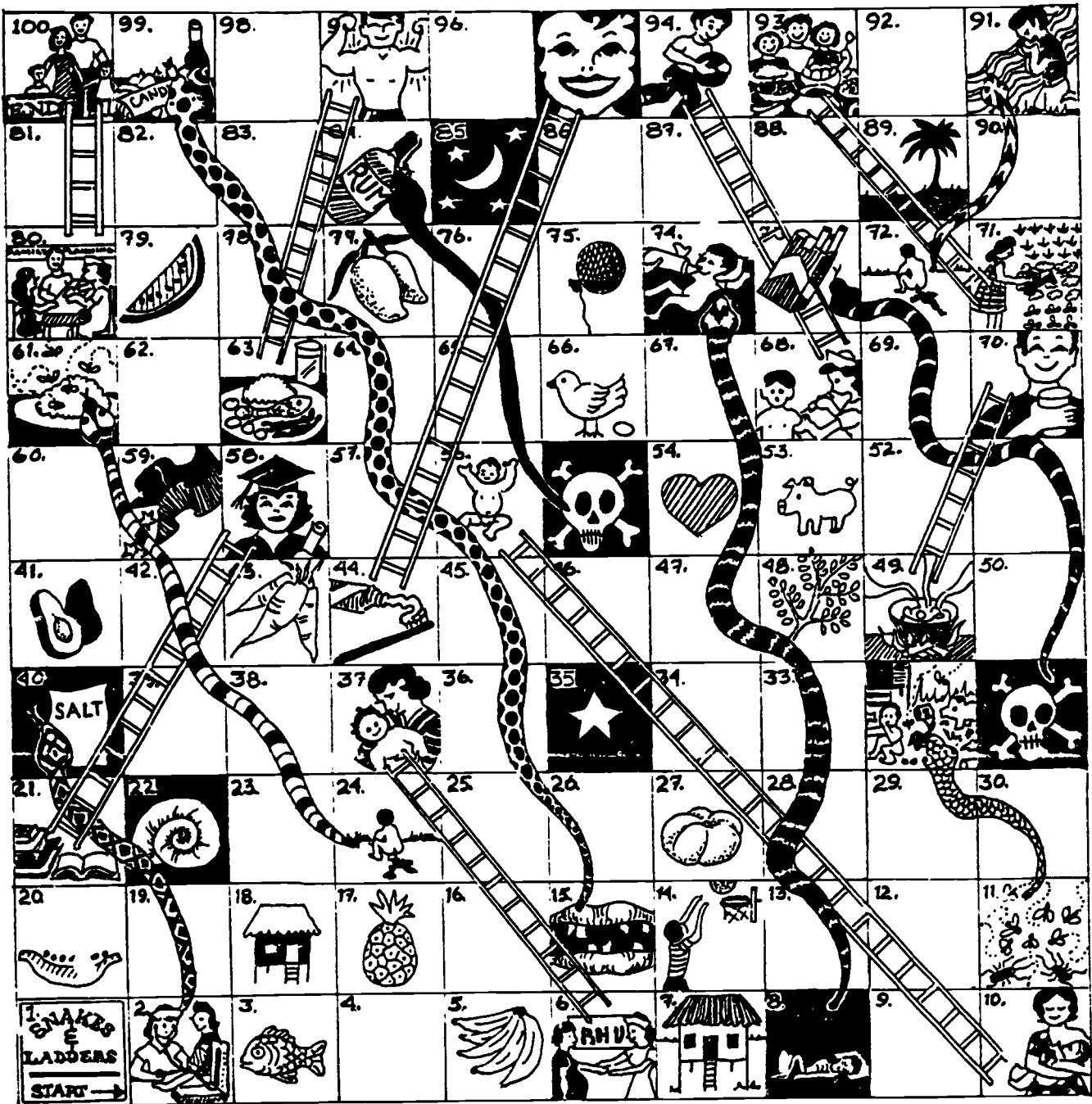

2) Use different color buttons for game markers, or paint pebbles different colors.

You will also need 1 die.



Alternative methods:

- 1) Draw the game board on a large piece of brown paper. The paper can be taped to a table for play and rolled into a cylinder for storage and transport.
- 2) Write, rather than draw, your messages. But do draw some pictures here and there to add interest.

To play Snakes & Ladders:

- 1) Snakes & Ladders may be played by 2 - 6 players. Each player rolls the die. The player with the highest number starts the game. If 2 or more players tie for the highest number, they should roll again to break the tie.
- 2) Play begins at square 1 marked START. The first player rolls the die and moves his/her marker according to the number shown on the die. A roll of 6 entitles player to throw again for another turn.
- 3) If the marker stops on the head of a snake, the player must move his/her marker down to the snake's tail. The player must also describe the snake's message to the rest of the group to explain why s/he had to move back. After the message has been interpreted, the player's turn is over. His/her next turn begins from the square at the tail of the snake.
- 4) Should a player's marker stop at the foot of a ladder, the player may move to the top of the ladder. S/he should also describe the ladder's message to the other players so that everyone knows why s/he was able to move ahead. After the message has been explained, the player's turn is over. His/her next turn begins from the square at the top of the ladder.
- 5) Play moves in a clockwise direction. When a player has completed his/her move, the die should be passed to the left.
- 6) The first player to reach square 100 wins the game. However, the player must roll the exact number needed to land on that square.

Alternative method:

- 1) Snakes & Ladders may be played by 6 - 8 persons, playing on two teams of 3 - 4 players each. In this case, 2 dice should be used.
- 2) One member from each team rolls the dice to determine which team will start the play. The team rolling the highest number starts.

- 3) Play alternates between both teams and players. In other words, if there are two teams, A and B, with 3 players each, play will progress from A1 to B1 to A2 to B2 to A3 to B3 and so on back to A1.
- 4) The first player rolls the dice and moves his/her marker according to the number shown. Rolling doubles gives the player the option of moving the exact number shown or $\frac{1}{2}$ the total. (For example: a player rolling a double 6 may move either 6 or 12 spaces.)
- 5) As in the individual play described above, players landing on the head of a snake must slide back down to its tail and explain the message to the other players. Ending a move at the foot of a ladder entitles the player to climb to the top. The ladder's message must be described before the next player rolls the dice.
- 6) The first team to place all its markers in square 100 wins the game. As above, each player must roll the exact number needed to land in that square. Thus, a player on square 99 can only move to square 100 by rolling a double 1 (see step 4 above).

HOUSE OF HEALTH*

To make House of Health:

- 1) Follow the example on the next page to draw the game board on a piece of stiff poster board 25 cm. x 50 cm. (10" x 20"). If you prefer, the game can be drawn on a large piece of brown paper which may be taped to the table during play.
 - The game board should include 4 vertical rows with 12 blocks in each row.
 - Draw houses in Rows 1 and 4. Color the houses in Row 1 on the right side of the board black. Put bright colored roofs on the houses in Row 4 on the left.
 - Rows 2 and 3 show pictures of various causes of, and ways to prevent, sickness. The pictures of sickness are bordered in black. The drawings of good health practices should have bright colored borders.
- 2) Paint 12 pebbles different colors (or collect 12 different colored buttons). These are the "community member" markers.
- 3) Leave one pebble unpainted (or use a black button) to represent "sickness".
- 4) You will also need a pair of dice.

To play House of Health:

- 1) The game requires 3-13 players, and is more lively with larger numbers. One player elects to play "sickness" while the others play "community members".
- 2) "Sickness" places his/her marker in the first black square in the bottom left corner of the board (showing a mother crying over her sick child).
- 3) "Community members" place their markers in the black houses on the right side of the board, one marker per house, starting from the top.
- 4) The objective of the game is to move all the "community members" from the black houses on the right side of the board to the colored "houses of health" on the left. They must travel along the rows of the board without getting caught by "sickness". When a "community member" marker is in a colored square, it is protected from "sickness", even though the "sickness" marker may land on the same square. However, if a "community member" is caught in a black square at the same time as the "sickness" marker, regardless of who got there first, the "community member" becomes ill and must leave the game board.
- 5) The game starts with one "community member" throwing the dice and moving one of the markers down along the row of black houses and then up the adjacent picture row. "Community members" may move in one direction only, following

HOUSE OF HEALTH
(sample board)

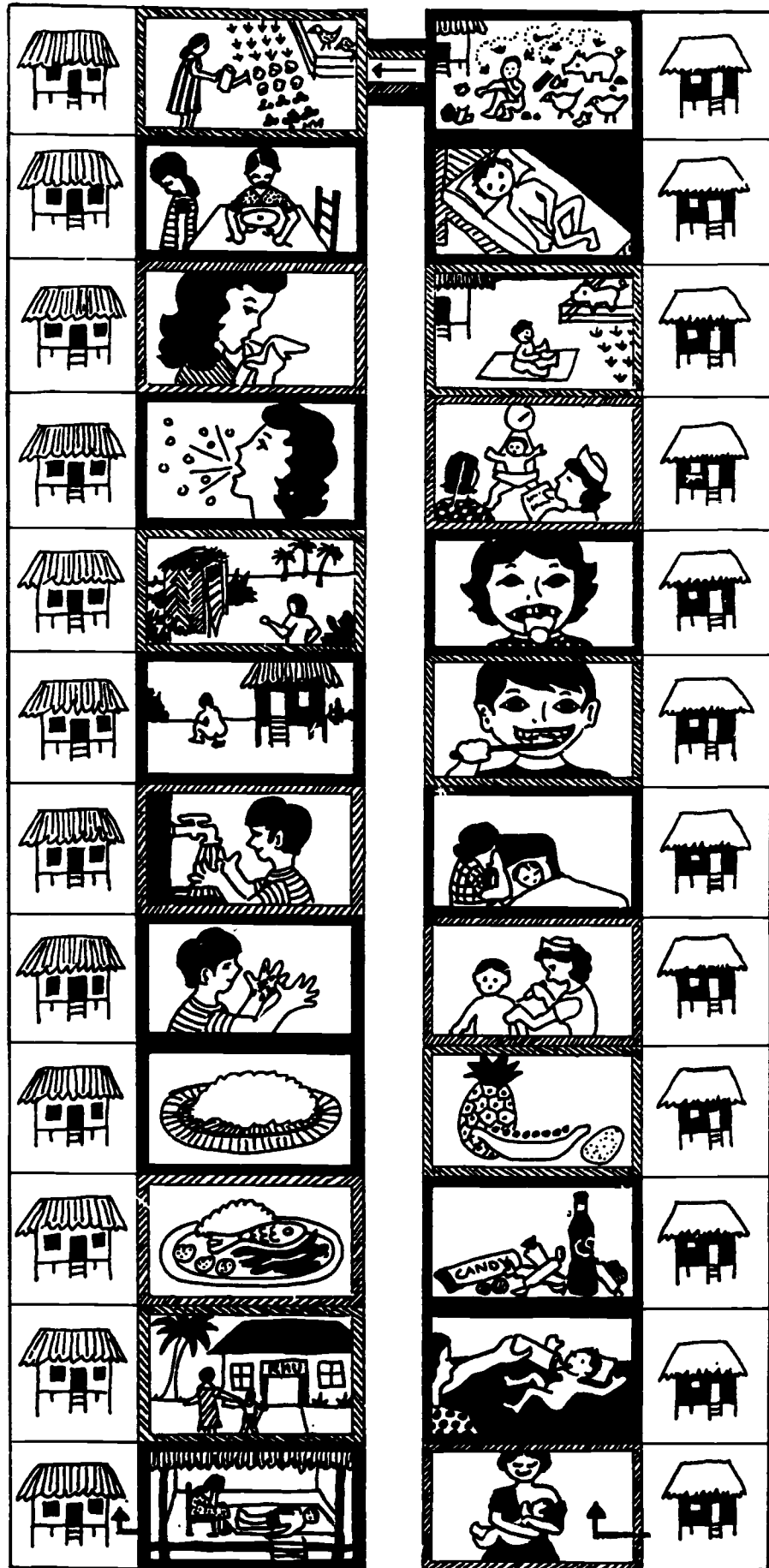

the arrows. They work as a team, however, and can move any "community member" marker they choose. Only one marker may be moved for each roll of the dice.

- 6) The "sickness" player then rolls the dice and may move in either direction, forward or backward along the rows. "Sickness" tries to attack the "community members" by catching them in a black picture square and removing them from the game.
- 7) The game continues with the "community members" taking turns tossing the dice alternately with "sickness".
- 8) As players land on a square representing a cause of sickness or a way to prevent sickness, they should explain what they see in the square and how it influences the family's health.
- 9) The game ends when all the "community members" arrive on the left side of the board or are out of the game. Count the number of pieces that have been attacked by "sickness".

*Adapted from Bridging the Gap: A Participatory Approach to Health and Nutrition Education (Save the Children 1982). pp. 77-79.

NUTRI-DOMINOS*

This game is patterned after the game of dominos with foods from each of the three basic food groups being matched instead of dots. The purpose of Nutri-Dominos is to familiarize players with the foods belonging to each food group.

To make Nutri-Dominos:

- 1) Cut poster board into 40 5 cm. x 10 cm. (2" x 4") pieces.
- 2) On each card, draw pictures of two different foods that are locally available. Try to balance the foods represented amongst the three basic food groups - body-building foods, body-regulating foods, and energy foods.

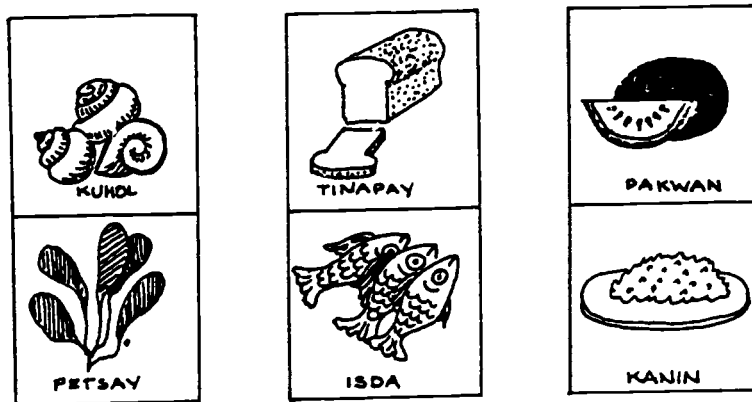

- 3) Prepare a master sheet listing all the foods represented on the dominos in alphabetical order and classify them according to food group. (See sample list on page 105.)

To play Nutri-Dominos.

Method #1 (for 2 - players, 1 monitor)

- 1) The monitor should spread all the domino cards on the table, picture side down.
- 2) Each player randomly selects 5 dominos, being careful not to let the other players see what foods are represented on his/her cards.

3) The monitor selects one domino to start the game and places it face up on the table.

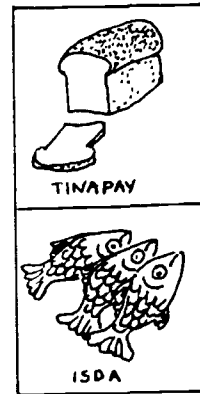

4) The player on the monitor's left must match the food group shown on either end of the first card by placing one of his/her dominos next to the matching picture.

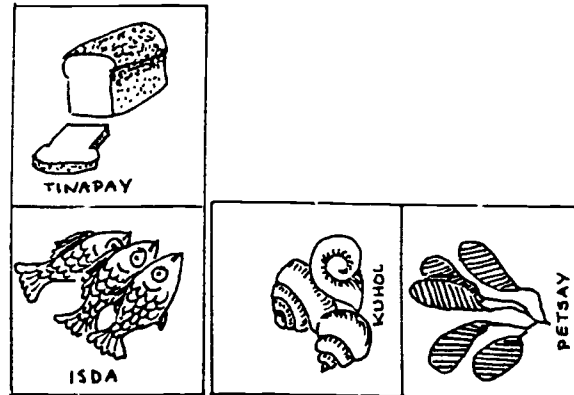

5) With play proceeding to the left, the next player must match one of his/her dominos to either of the unconnected ends of the domino chain.

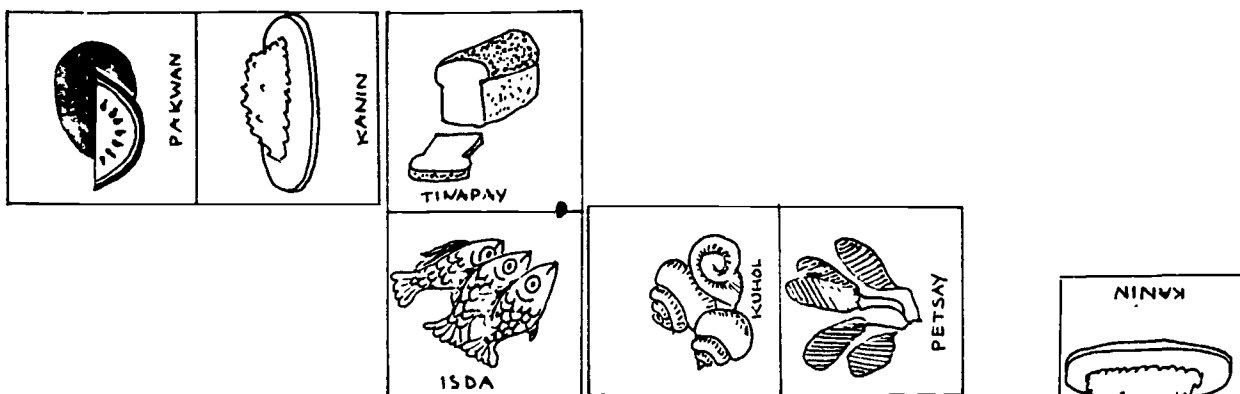

For example, s/he may either match KANIN to TINAPAY, or PAKWAN to PETSAY.

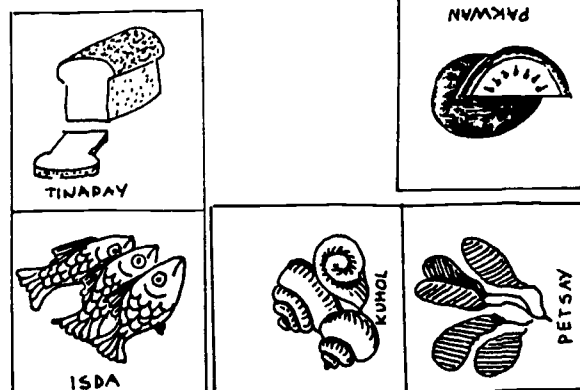

- 6) If a player cannot match food groups from the dominos in his/her hand, s/he must keep drawing from those face-down on the table, one at a time, until s/he is able to do so.
- 7) Any play may be challenged by the other players if they suspect that food groups have been mismatched. However, the challenge can only be made at the time the active player places his/her domino on the board. In the case of a challenge, the monitor will check the master list. If the challenging player is correct and the dominos have been mismatched, the player who made the error must take back his/her domino and forfeit his/her turn. Play then proceeds immediately to the player who made the successful challenge. If, however, the challenging player is mistaken and the dominos have been correctly matched, the active player may take another turn before the game proceeds further. In the case that two or more players challenge the same move, the monitor will determine which player spoke first and assign the responsibility for the challenge to that individual.
- 8) The first player to get rid of all his/her domino cards is the winner.

Method #2 (for 2 teams of 3 - 5 players each)

- 1) Each team will select one member to act as monitor.
- 2) Each monitor should be given 20 dominos, 19 of which should be dealt out to his/her team members, one at a time. (It does not matter that some players will have one more domino than the others.) The monitor then places the last domino face up in the center of the table.
- 3) This method of playing Nutri-Dominos is a race so play will begin for both teams at a signal from the facilitator. The player sitting to the left of the team monitor starts the game by matching the food group represented on either end of the starter domino with one of his/her cards.
- 4) Play proceeds to the left with the second player matching one of his/her cards to either one of the unconnected ends of the domino chain.
- 5) If a team member is unable to match food groups with any of the domino cards in his/her hand, s/he says "PASS" and the action proceeds automatically to the next player.
- 6) Since the object of the game is not only to get through first, but also to finish the game with the fewest possible mistakes, teams need to work together. Both the team monitor and non-active team members should pay attention to the matching player's move. If they think s/he has made a mistake, they should say "ERROR" and give the active player a chance to change his/her domino. When everyone is satisfied that the

match is correct, the game proceeds to the next player.

NOTE: Neither the monitor nor the non-active members of the team may help the active player select a domino. They can only inform the active player that they think s/he has made an error. The active player then has the option of retrieving the misplaced domino and allowing the action to proceed to the next player, or s/he may try to match food groups with another domino. If after three tries the player is still unable to match food groups to the team's satisfaction, the next player automatically becomes responsible for making the match and play continues to proceed to the left in the normal manner.

- 7) When a team has matched all of its dominos, the team monitor should call out "CHECK". The other team must cease play until the facilitator has checked the first team's domino chain against the master list.
- 8) If the facilitator can find no errors in the food group matches, the first team is declared the winner and the game is over. If, however, the facilitator sees one or more mistakes in the chain, s/he should point them out to the team members without identifying the food groups of the mismatched pictures. When all the errors have been pointed out, the facilitator signals for play to resume.
- 9) The first team then tries to correct its mistakes before the second team finishes.

NOTE: Teams should remember that it is not enough to simply change one or two mismatched dominos. A mismatch in the center of the chain may require all subsequent pieces to be readjusted.

- 10) Each team is allowed one CHECK by the facilitator to give them each an opportunity to correct any errors they might have made. Play must cease for both teams while the facilitator does the checking.
- 11) When a team thinks they have corrected all their mistakes following a CHECK, the team monitor should call out "DONE". Again, the other team must cease playing while the facilitator reviews the first team's corrected domino chain. If all the matches are now correct, the first team is declared the winner and the game is finished.
- 12) Should the facilitator identify any remaining errors, the second team may resume play until they have had their first CHECK and an opportunity to correct their mistakes. When they consider themselves DONE, the facilitator should review their matches. If there are no errors, team #2 is declared the winner even though team #1 finished first. If the facilitator identifies any mistakes remaining in the second team's corrected domino chain, the team having the fewest number of errors shall be declared the winner.

Example: Master List

3 GRUPO NG PAGKAIN

TAGAPAG-BIGAY
NG LAKAS

asukal
bibingka
gabi
gata ng niyog
kamote
kamoteng kahoy
kanin
kutsinta
langis paniuto
macarone
mais
mantikilya
margarina
pandesal
pansit
patatas
pinipig
puto
rimas
saging
sitsaron
suman
taba ng baboy
tinapay
ubi
yuro

TAGAPAG-BUO
NG KATAWAN

alamang/tagontong
alimasag
atay
baboy
daing na isda
dilis
gatas
halamang buto
hipon
isda
itlog
kambing
karneng baka
keso
kuhol
laman loob
longaniza
mani
manok
munggo
pusit
taklobo
tokwa
tulya-tahong
tuyo

TAGAPAG-SAAYOS
NG KATAWAN

alugbati
ampalaya
atis
avacado
balimbing
bayabas
chico
dahon ng ampalaya
dahon ng gabi
dahon ng saluyot
dalanghita
kadyos
kalabasa
kalamansi
kamatis
kangkong
karot
langka
lanzones
malunggay
melon
okra
pakwan
papaya
petsay
pinya
puso ng saging
repolyo
sitaw
talbos ng kamote
talong
tiesa

*Nutri-Dominos was designed and developed by Gilda Danoco, PRMM Hospital, Iba, Zambales, Philippines.

TAKE IT OR TOSS IT

This game promotes discussion about, and analysis of, local health traditions and superstitions.

To make Take It or Toss It:

- 1) Draw and color an open suitcase or trunk on a piece of poster board. Draw and color a trashcan on another piece of poster board.
- 2) Cut a slot in the open suitcase and a slot in the top of the trashcan.
- 3) Construct envelopes as shown and glue them to the backs of the posters underneath each slot. Bow the envelope slightly so that it will catch cards fed through the slots.

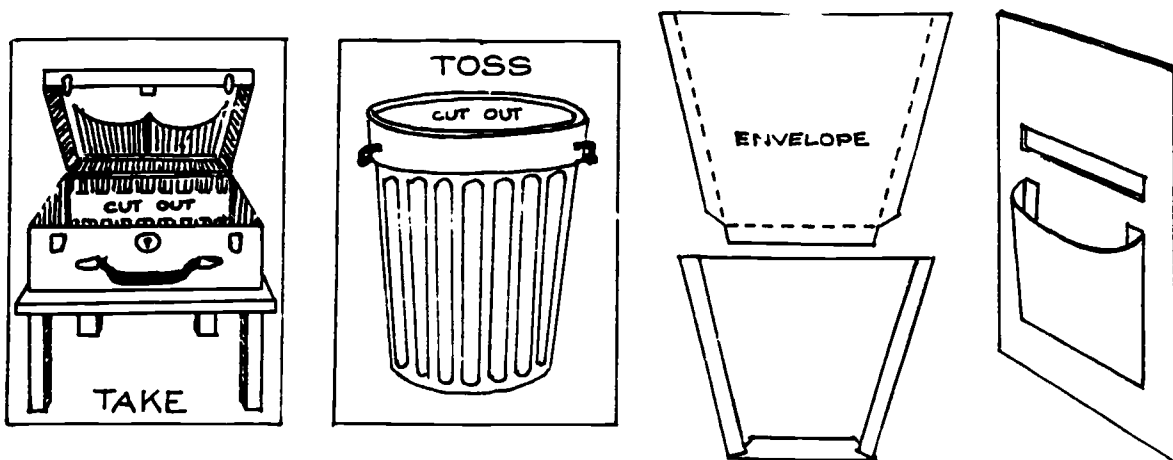

- 4) Make a list of local health traditions and superstitions. Make another list of general good health practices.
- 5) Write each local tradition, superstition, and good health practice on a separate 3" x 5" card. These will be the "baggage" cards.

To play Take It or Toss It:

- 1) Prop the two posters on a table leaning against the wall, or on two chairs. Shuffle the "baggage" cards and place them in a pile face down near the posters.
- 2) Explain to participants that "Maria" (or any other name you choose) is moving to a new house. She has lived in her old house all her life and her parents had lived there for a long

time before she was even born. The family has accumulated a lot of baggage over the years and now Maria must sort through it all. She only wants to take useful items with her. She needs you to help her decide what to take and what to toss out.

- 3) Ask for a volunteer to play "Maria" (or facilitator may assume the role).
- 4) Maria picks up the top "baggage" card and reads it to the group. She then asks the group: "Shall I take this tradition (or practice) with me? Or should I toss it out?"

Participants must decide whether the item is useful or not. When they reach an agreement, they tell Maria to either "TAKE IT" or "TOSS IT" and give their reasons. Maria should feel free to question the group's decision. If this should happen, it is up to the group to convince her that the item is (or is not) useful.

- 5) This procedure is repeated until all the "baggage" cards have been sorted through.

NOTE: Volunteers can take turns role-playing "Maria" by switching places every two or three items.

FOOD SWAP*

Food Swap is an action game which may be played with a large number of people. It is a good way to help a community group get acquainted, have fun, and learn something about nutrition in a relaxed, informal atmosphere.

To prepare the Food Swap game:

- 1) Draw and color pictures of a wide variety of local foods on separate pieces of paper approximately 15 cm. (6") square.
- 2) Arrange chairs in a closed circle. There should be one less chair than the number of players.

To play Food Swap:

- 1) Ask each person to select a drawing and tape or pin it to the front of his/her shirt.
- 2) Select a volunteer to act as leader.
- 3) All the players sit in a circle while the leader stands in the center and calls out the instructions.
- 4) The players with the foods mentioned in the instructions swap places.
- 5) While the players are trading places, the leader tries to find a seat.
- 6) The person left standing in the middle becomes the leader and calls out the next instruction.

Sample Instructions

All body-building foods swap places.

All energy foods swap places.

All body-regulating foods swap places.

Fruits and vegetables swap places.

All proteins swap places.

Green, leafy vegetables swap places.



*Adapted from Bridging the Gap: A Participatory Approach to Health and Nutrition Education (Save the Children 1982). p. 83.

NUTRITION 20 QUESTIONS

Although NUTRITION 20 QUESTIONS does not require any supporting visual aids, it is a good way for people to become familiar with the basic food groups to which local foods belong. NUTRITION 20 QUESTIONS can be played with large or small groups of participants.

How to play NUTRITION 20 QUESTIONS:

- 1) Have participants sit in a closed circle.
- 2) Establish two teams (for scoring purposes) by counting off around the circle, 1-2-1-2, until all participants have been assigned a number. If there are an uneven number of players, facilitator can join the game so that each team has an equal number.
- 3) Regardless of whether the facilitator is in the game or not, s/he should begin the play by stating that s/he is thinking of a particular food item, identifying the food group to which it belongs and describing its color. For example, s/he might say: "I'm thinking of a body-regulating food that is primarily green and red."
- 4) Participants take turns asking questions about the food that can be answered by either YES or NO, e.g. "Do we usually cook this food?" "Is it larger than a basketball?" "Is this a seasonal food?"

Questioning proceeds in an orderly fashion around the circle in a clockwise direction, alternating between members of Team #1 and Team #2. Each participant may ask only one question per turn.

- 5) When enough information has been elicited to convince a participant that s/he knows what the food item is, s/he may specifically ask if it is that item: "Is it a watermelon?"

If the answer is YES, that player's team earns 5 points. The participant who guessed the food item correctly becomes the leader and "thinks" of a food, describing it to the rest of the players by food group and color. Questioning continues where it left off, proceeding in a clockwise direction so that all the players have a chance to ask a question and so that each team has an equal number of question opportunities.

- 6) Players, however, should be cautious about making "wild" guesses as to the identity of the food item. An incorrect guess resulting in a NO answer costs the player's team 2 points. Thus, if Teams #1 and #2 each have earned 5 points for correct identification during the first two rounds of the game, and a player from Team #1 makes a wrong guess on round 3, Team #1 loses 2 points and the score becomes Team #1: 3

points, Team #2: 5 points.

- 7) Only 20 questions may be asked about any one food item. If the food item remains unidentified after all 20 questions have been used, the leader's team is awarded 3 points. The opportunity to be leader and "think" of a food item passes one person to the left.
- 8) The facilitator (or a volunteer) should keep a score tally on the chalkboard. The first team to accumulate 20 points wins the game.

12. PUPPETS

A puppet show is an effective way to deliver a health message in an entertaining, original, and humorous manner. Puppets can "talk" to people and tease them in ways that might seem inappropriate in real life. Conversely, people - and particularly children - who are ashamed to speak out in a group will frequently be willing to express themselves freely to a puppet.

How to write the script:

There are several things to keep in mind when you write the script for a puppet show.

- 1) Puppet shows appeal to people's feelings rather than their intellect. Consequently, they are most useful for awakening sympathy or antagonism toward certain ideas, attitudes, or procedures. Do not use a puppet show to give technical information.
- 2) Keep the message simple.
- 3) Tailor the message to the target audience.
- 4) Develop the message logically.
 - Have a narrator introduce the story and comment on the action from time to time.
 - Let the story evolve out of conversation between characters.
 - a) present a problem or conflict
 - b) build suspense
 - c) resolve the conflict
 - Incorporate action as well as words.
- 5) Present the message with humor.
- 6) Choose the characters carefully.
 - Limit the number of characters to what may be easily managed by the puppeteers.
 - Exaggerate the personalities. The characters should be symbolic rather than specific, i.e. a villain should be very evil, the hero extremely brave, etc.

How to make the puppets:

Puppets can be made easily and inexpensively from a variety of materials. Following are just a few examples.

LOLLIPUPPETS *

Materials:

stiff paper or cardboard
colored marking pens
flat sticks 30 cm.-35 cm. (12"-14") long

Method:

- 1) Draw and color two faces with different expressions for each character on stiff paper and cut out the shapes of the heads and upper bodies.
- 2) Glue one face of the lollipopuppet on the front of the stick and one on the back.

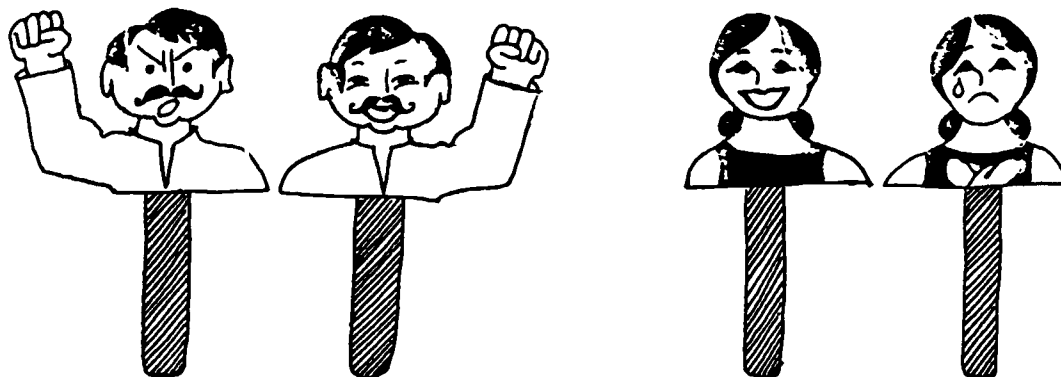

Source: Bridging the Gap: A Participatory Approach to Health and Nutrition Education (Save the Children, 1982). p. 42.

STICK PUPPETS

Materials:

1 stick 30 cm.-35 cm. (12"-14") long
1 stick 18 cm.-20 cm. (7"-8") long
old newspaper
fabric scraps, yarn, etc.
string
marking pens

Method:

- 1) Use string to attach the shorter stick to the longer stick at right angles about 2" from one end. The long stick will form the body of the puppet; the shorter cross stick becomes the arms.
- 2) Make a dress for the puppet from a piece of fabric folded in half. Cut a small hole in the center of the fold and insert the short end of the body stick through the hole. Tie the

dress around the puppet's "waist" so that it will stay on. If you want a "fat" puppet, stuff the body with newspaper or other filler.

- 3) Wad some newspaper into a 2"-3" ball and place it over the short end of the "body" stick.
- 4) Tie a piece of white or light brown fabric over the newspaper "head" and tuck the raw edges into the neckline of the dress.
- 5) Draw the puppet's face with marking pens and add hair and/or a hat as desired.

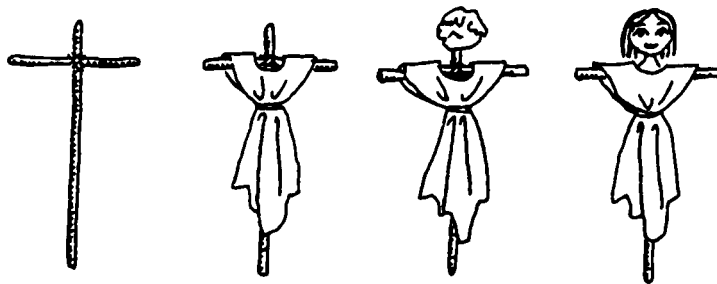

SOCK PUPPET

Materials:

a sock
old newspaper
marking pens
string
fabric scraps, yarn, etc.

Method:

- 1) Stuff the toe of a sock with wadded-up newspaper or other filler to form the puppet's head.
- 2) Tie loosely with string allowing enough room to insert your forefinger up into the puppet's head.
- 3) Draw the face of the puppet with marking pens. Add hair, hat, trimmings, etc. as desired.

NOTE: The sock should be "stretchy" enough to allow this puppet to use its hands (your thumb and middle finger) to gesture, hold things, etc.

PAPIER MACHÉ HAND PUPPET

Materials:

balloon
flour and water paste
strips of news or other paper (brown paper, old phone books, catalogs, etc.)
white glue
poster paint or colored marking pens
stiff paper or cardboard
fabric scraps, yarn, etc.

Method:

- 1) Blow up the balloon to the desired size.
- 2) Soak small strips of paper in flour and water paste and cover the entire surface of the balloon except for a small neck opening at the bottom. Apply several layers of paper strips.
- 3) Shape features out of stiff paper or cardboard and attach to the balloon head. Cover these features with several layers of paper strips.
- 4) Let the puppet head dry.
- 5) Seal with a light coat of white glue diluted with a little water. Dry.
- 6) Pop the balloon and paint the face. Apply another coat of glue and let dry.
- 7) Follow the pattern on the next page to make the body of the puppet.
- 8) Glue the neckline of the body to the neck of the puppet's head.
- 9) Add hair, trim, and details as desired.

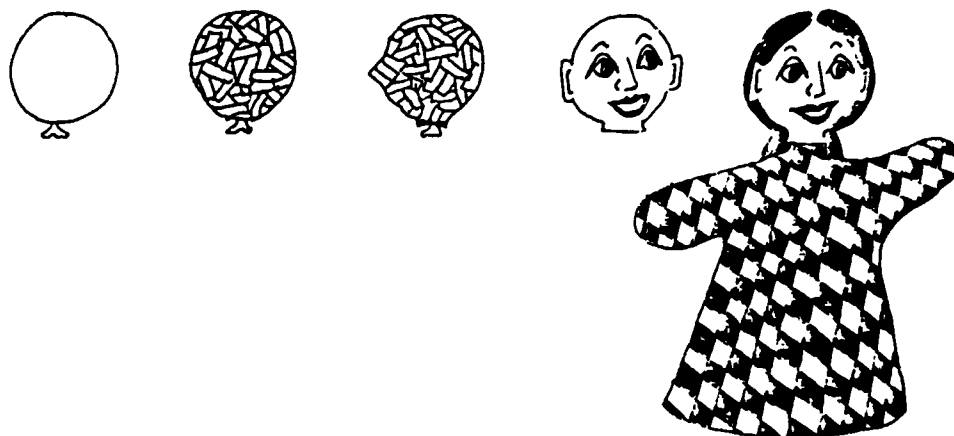

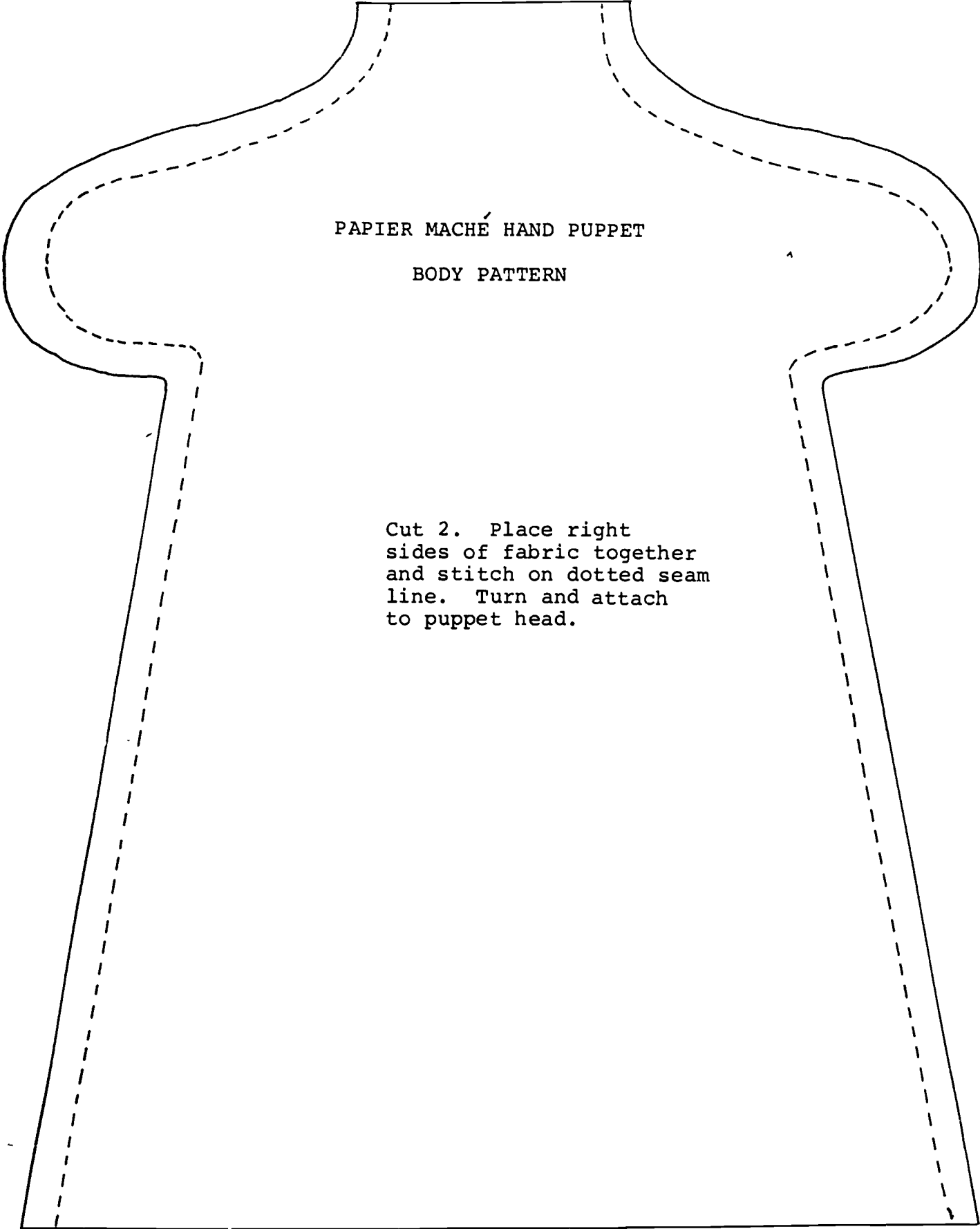

PAPIER MACHÉ HAND PUPPET

BODY PATTERN

Cut 2. Place right sides of fabric together and stitch on dotted seam line. Turn and attach to puppet head.

BAG PUPPET*

Bag puppets work particularly well for health messages about the mouth, throat, or teeth because they can open and close their mouths.

Materials:

square bottom paper bag
colored marking pens

Method:

- 1) Fold over the bottom of the bag.
- 2) Draw a face on the bag with the mouth placed on the fold.
- 3) Unfold the bag and draw the inside of the mouth.
- 4) Open and close your hand to make the puppet speak and eat.

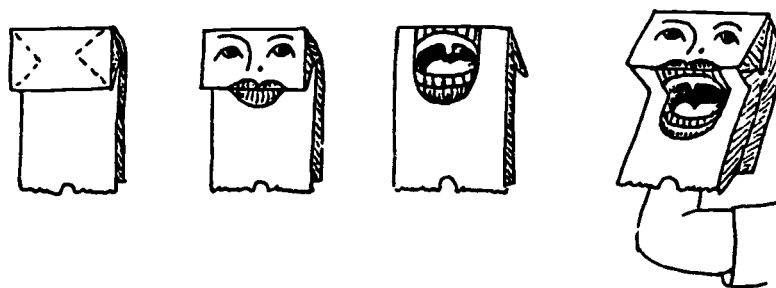

To make a slightly more elaborate puppet from an envelope-style paper bag:

- 1) Fold over the bottom of the bag.
- 2) Draw a face on heavy paper or cardboard.
- 3) Glue the cardboard face onto the folded bag.

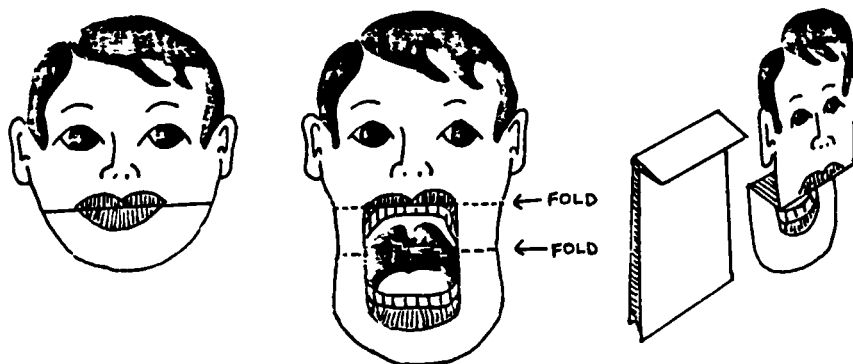

*Source: Werner and Bower, Helping Health Workers Learn. p. 27-35.

MISCELLANEOUS PUPPETS

Puppets can be made from almost anything if you just use your imagination. Does your script call for a very conservative, "square" character? Make your puppet out of a box attached to a stick or made into a hand puppet.

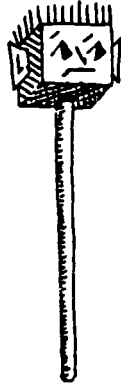

Use a plastic food container like margarine comes in...



...or drape a bandana over your hand and stick your finger into a hole poked in an old tennis ball.



Peace Corps volunteers in Zamboanga made a delightful puppet by securing a coconut shell to a stick. They attached "rotten" teeth to its mouth and made "googledy" eyes from coils taken from an old spiral notebook.

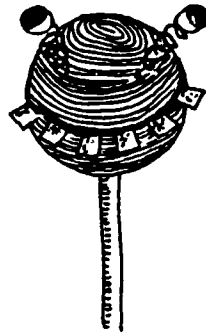

The puppet opens and closes its mouth by means of a small hinge and a string connected to the top of its head.

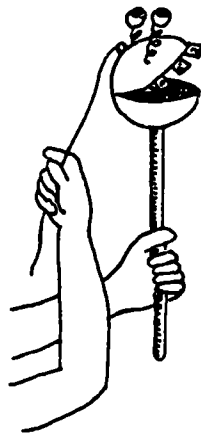

DON'T BE AFRAID TO EXPERIMENT!

How to present a puppet show:

1) Create a stage:

•Set a large table on its side.

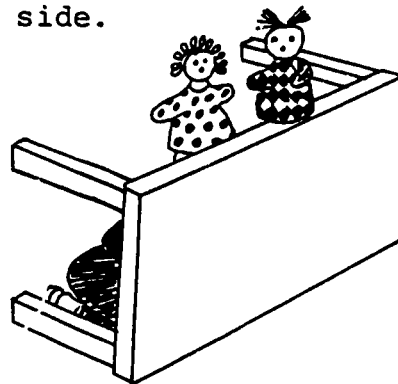

•Hang a blanket over a rope tied between two trees.

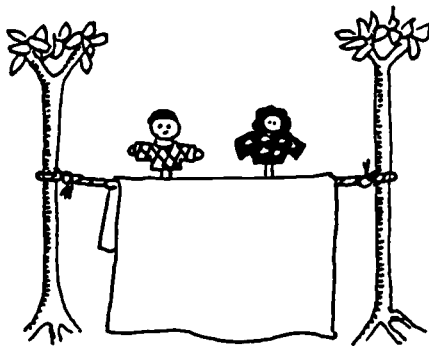

•Lean a large board against two chairs.

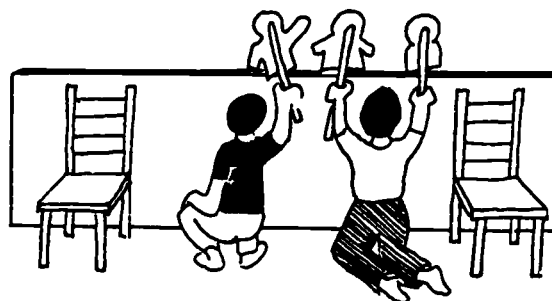

However you decide to make your stage, be sure that the puppeteers are hidden from view.

- 2) Give each puppeteer a copy of the script.
- 3) Keep puppets - especially flat puppets - facing the audience.
- 4) Move and nod the puppet when it speaks. Use as much action in your story as you can.
- 5) Speak loudly so that everyone can hear. Use a microphone if necessary and available.
- 6) Practice the puppet show before presenting it.

On the following pages are two sample scripts for puppet shows. The first has been written for children. The second is targeted toward an adult audience. The scripts are presented in English but should be translated into the local dialect before presentation to a barrio, audience.

Sample script

THE DEATH OF OLD ROT*

Featuring bag puppets: Sweet Tooth Pearl
 Lollipop Sugar Mouth
 Sparkle

And the villainous coconut man, OLD ROT.

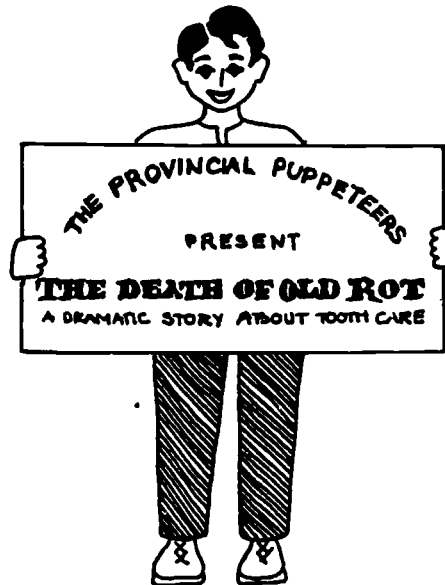

The show opens with SWEET TOOTH and LOLLIPOP eating candy. (The persons working each puppet use their free hands to put candy in the mouths of the puppets. The hand holding the puppet opens and closes to show SWEET TOOTH and LOLLIPOP chewing the candy.)

SOUND EFFECTS: Crunch, crunch, crunch.

SWEET TOOTH: M-m-mm-mm. This candy is really good.

LOLLIPOP: Yum-yum. It sure is. I love sweets! I could eat candy all day.

SWEET TOOTH: So could I. But it really makes me thirsty. C'mon, let's get a coke.

LOLLIPOP: Okay, that's a good idea. I'm thirsty too.

Both puppets go off stage but return very quickly with their cokes. (The puppeteers use their free hand to lift a coke bottle to each puppet's mouth.)

SOUND EFFECTS: Glug, glug, glug.

While SWEET TOOTH and LOLLIPOP are drinking their cokes, OLD ROT appears at stage right, bouncing up and down and singing.

OLD ROT: Hurray! Hurray! I'm happy today!
Two more victims are coming my way!

OLD ROT disappears from view.

LOLLIPOP (looking around):

What was that, Sweet Tooth? I thought I heard someone singing...

SWEET TOOTH (still drinking coke - glug, glug, glug)

Huh? Someone singing? You must be crazy. There isn't anybody around. (Drinks more coke - glug, glug.)

LOLLIPOP: Yeah, I guess you're right. I don't see anybody around. But I could have sworn I heard someone singing...

OLD ROT pops up for a moment at stage left, bounces around, opening and closing his mouth once or twice, and then quickly disappears from view.

LOLLIPOP: Oh well...hey! c'mon, let's get some more candy and go over to watch the basketball game.

OLD ROT pops up again, bouncing.

OLD ROT: Yeah! Yeah! Yeah!

...and quickly disappears from view.

SWEET TOOTH: (finishing his coke):

Okay. I think I'll get some chiclets. Say! Maybe we'll see the gang over there.

SWEET TOOTH and LOLLIPOP move across the stage, leave at stage left, then reappear at stage right. They meet PEARL and SPARKLE coming from stage left. The friends stop to talk to each other.

SPARKLE: Hi, Sweet Tooth! Hi, Lollipop! Where are you going?

SWEET TOOTH (nodding to SPARKLE and PEARL):

Hi, Sparkle. Hi, Pearl. Lollipop and I are going over to the sari-sari store to get some candy. Then we're going to go watch the basketball game. Why don't you come with us?

While SPARKLE and SWEET TOOTH are talking, LOLLIPOP moves over by PEARL because he has a crush on her. PEARL nods at LOLLIPOP.

LOLLIPOP: You have such a pretty smile, Pearl. And your teeth are so white. How do you do it?

PEARL: I brush my teeth after every meal. And I don't munch out on candy all the time like you do. I don't drink sweet, fizzy drinks like coke or pepsi either.

OLD ROT appears at the side of the stage, bouncing up and down as usual.

OLD ROT (looking at PEARL): Shut up! Shut up!
(to the audience):

That girl thinks she's so smart just because she has white teeth and a pretty smile! She just doesn't know how yummy candy is. I bet she even eats a lot of fruits and vegetables! Yuck!

OLD ROT disappears from view.

PEARL: Show me your teeth, Lollipop.

LOLLIPOP is ashamed and tries to hide behind another puppet. SPARKLE starts to tease him.

SPARKLE: Yeah, show us your teeth. C'mon now, open your mouth. You too, Sweet Tooth, open up!

SWEET TOOTH and LOLLIPOP open their mouths wide. Their teeth are all rotten.

OLD ROT pops up again at the side of the stage and addresses the audience:

OLD ROT: Isn't that a beautiful sight, folks? I just love black, rotten teeth, don't you?

He disappears from view.

Now SUGAR MOUTH comes on stage for the first time. He has his hand on his jaw and seems to be in pain.

SPARKLE: Hey Sugar Mouth! Where are you going?

SUGAR MOUTH: Mm-mm-umph...

SPARKLE: What's the matter, Sugar Mouth? Can't you talk?

SUGAR MOUTH (groaning):

I have a toothache (groan, groan). It really hurts.

Once again OLD ROT bounces into view.

OLD ROT: Did you hear that, folks? He's got a toothache! Isn't that wonderful? Heh! heh! heh!

OLD ROT disappears from view.

PEARL: Why don't you ask your mother to take you to the dentist at the Rural Health Unit?

SUGAR MOUTH: No, I don't want to. I'm afraid. Ow-ow! My mouth really hurts. I think I'll get a coke. That will make me feel better.

OLD ROT (popping into view for just a moment): Yeah! Yeah! Yeah!

SPARKLE: Don't do that, Sugar Mouth. Coke is bad for your teeth.

LOLLIPOP: What do you mean, coke is bad for your teeth? Coke tastes good. I saw you drinking one just the other day at Pearl's birthday party.

SPARKLE: That's right. Once in a while, on very special occasions, I drink a coke. But as soon as I finish, I rinse my mouth out well with clean water. And I always brush my teeth right after I eat.

OLD ROT peeks over the edge of the stage at the audience:
Clean water? Tooth brushing? Those are my worst enemies!

LOLLIPOP: Well, that's fine for you. But my family is very poor. We don't have money to buy a tooth brush and tooth paste.

SWEET TOOTH: Neither do we. You have to be rich to have white teeth.

SUGAR MOUTH (moaning and groaning): Oh! My poor mouth!

PEARL: You don't have to be rich to have nice teeth. My family can't afford to buy toothbrushes either. We clean our teeth with a piece of towel wrapped around a stick like this.

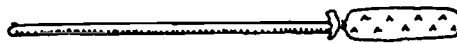

(PEARL's puppeteer shows the tooth cleaning stick and demonstrates how to use it by "brushing" PEARL's teeth.)

OLD ROT: Take it away! That stick is dangerous! It will kill me!

PEARL: And instead of toothpaste, we dip the stick into a mixture of salt and baking soda. It works great!

OLD ROT: Salt and baking soda? That stuff will poison me!

SPARKLE: Our family doesn't have toothbrushes either. We use a stick like this. (Shows stick.)

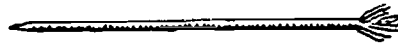

We chew one end like this (chews end of stick) to make a brush, and sharpen the other end, like this (holds up pointed end) to clean between our teeth.

OLD ROT: I don't like what's going on here. That looks like a very dangerous instrument.

PEARL: Sparkle and I also go to the dentist at the RHU for a check-up every six months. You don't have to wait until your teeth hurt before you see a dentist. The dentist at the RHU is really nice.

OLD ROT: The dentist? Oh no! I hate dentists! Whoever heard of a nice dentist?

SPARKLE: C'mon, Sugar Mouth, we'll take you over to the RHU and introduce you to our friend, Dr. Brushem. He'll make your toothache go away.

OLD ROT: No! Sugar Mouth, don't go! (To the audience) If Sugar Mouth goes to see Dr. Brushem, that will be the end of me!

SWEET TOOTH: Can we go with you?

LOLLIPOP: Yeah, can we go too? I want to have nice teeth.

PEARL: Sure you can. But you have to stop eating so much candy and drinking so many cokes if you really want to have nice teeth.

SWEET TOOTH
& LOLLIPOP: Oh, we will! We promise!

ALL THE BAG PUPPETS SHOUT TOGETHER:

We share with each other
And learn a lot
Candy is dandy
Rot is not!
We've found a way
To fight tooth decay.
We all help each other
Stay healthy. Hurray!

The bag puppets leave the stage. Only OLD ROT is left.

OLD ROT (groaning and crying and staggering around the stage alone):

They're killing me! They're killing me! (groan, sob)
I'm dying! Aa-aagh! (He screams and falls backward
out of sight).

The bag puppets all pop up again together and shout:

HURRAY!

The End

*THE DEATH OF OLD ROT was adapted from Werner & Power, Helping Health Workers Learn, pp. 27-37 - 27-39, with inspiration from the Peace Corps Puppeteers in Zamboanga City.

Sample script

THE SPREADING SICKNESS

Featuring hand puppets, ANNA BANDANA
her husband, BEN
her daughter, BABY
and her neighbor, BONNIE

BONNIE introduces the show:

Good morning (good afternoon) to all of you. I'm Bonnie, a barangay health worker, and I'm very glad to see all of you here today. Are you glad to see me? (Waits for audience response.) Don't be shy - who's glad to see me? (Waits until she gets a response.) Okay. We're going to entertain you with a puppet show this morning (afternoon).

One of the puppeteers displays a showcard with the title of the puppet show:

The Provincial Puppeteers present THE SPREADING SICKNESS A Mystery Story About Health
--

BONNIE: The title of our show is THE SPREADING SICKNESS. It's a mystery story and it stars my next door neighbor, Anna Bandana. (The show card is taken down and ANNA comes on stage and bows to the audience.)

...her husband, Ben (BEN joins ANNA on stage and bows to the audience)

...and their daughter, Baby. (BABY comes on stage to stand by ANNA and BEN. She bows to the audience.)

I'm in the show, too. And so are you because I'm going to ask you to solve the mystery, okay? Now, let's get on with the show.

One of the puppeteers displays a second showcard:

SCENE I. Lunchtime in the kitchen of Anna Bandana

The show opens with ANNA BANDANA bustling around her kitchen preparing the noon meal. There is a towel draped over the edge of the stage.

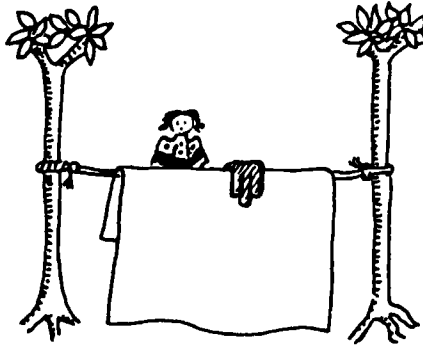

ANNA (talking to herself): My goodness, it's hot there by the fire. I hope the munggo will be cooked pretty soon. Ben is due home any minute for his lunch. (ANNA picks up the towel and wipes her face and hands, then puts the towel back. She moves to stage right and pretends to stir the beans. BEN enters from stage left.)

BEN: Wow! it's really hot in the field today. Not a breath of air anywhere. (He picks up the towel, wipes his face and hands, and puts the towel back.) What's for lunch?

ANNA (still at stage right): Munggo and rice. Sit down and rest. Lunch is just about ready. Did you get the fields fertilized? (ANNA mimes bringing BEN his lunch. BEN is rubbing his eyes with his hands.)

BEN: Not yet. We should be through by the end of the week. (Rubs his eyes again.) Where is Baby?

ANNA: She said she was going to stop by Ida's place on her way home from school. She should be home soon.

(BABY enters from stage left.)

Oh, look! Here she is now.

BABY (sniffing): Hi, Mom. Hi, Dad. What's for lunch? (sniffle, sniffle - BABY wipes her nose, then gets the towel and wipes her hands. She puts the towel back and joins her parents.) Ah...munggo...my favorite! (sniffle, sniffle - BABY wipes her nose again. BEN is rubbing his eyes.)

BEN: What's wrong with you, Baby? Sounds like you have a cold.

BABY (sniffing): Oh, it's just a runny nose. I feel okay. (Goes over to get the towel and wipes her face again.) You don't look so great yourself, Dad. Your eyes are all red.

BEN (rubbing his eyes): We've been fertilizing the fields all morning. I probably got some dust in my eyes (rubs his eyes again). Anna, how are the baby pigs doing?

ANNA: I've been so busy all morning I haven't had a chance to check up on them. I'll go see them right now. (ANNA leaves the stage.)

BEN (rubbing his eyes): You shouldn't have gone swimming in the river yesterday, Baby. You probably got chilled. That's why you have a cold.

BABY (sniffing): Oh, Daddy! It's no big deal. I'll be okay. (Sniffles again and wipes her nose with her hands.)

ANNA returns to the stage, picks up the towel and wipes her hands...

ANNA: The baby pigs won't let the runt suckle. I had to shove them over with my hands to make room for him to get something to eat, poor thing.

BEN: You'd better look at them every hour or so to make sure they're all right (rubs his eyes). Well, I've got to get back to the fields. There's a lot of work to do. (BEN picks up the towel, wipes his face and hands, replaces the towel, and exits stage right.)

BABY (sniffing): And I have to get back to school. (Rubs her nose.) We're having a review for the big test tomorrow. (She picks up the towel, wipes her face and hands, puts the towel back, and then exits.)

ANNA: And I better get this kitchen cleaned up so that I can finish the ironing. (ANNA pretends to clean the table with the towel.) Tomorrow is the meeting of our Women's Club, and I'm in charge of all the arrangements for our fund-raising dance Friday night. (ANNA bustles around the kitchen putting things in order. She wipes her hands and face on the towel, puts it back, and then exits.)

BONNIE appears on stage again.

Don't go away, folks. It's not over yet.

A puppeteer displays the third showcard.

SCENE II. The next morning.

ANNA and BEN come on stage together. BEN is rubbing his eyes. ANNA picks up the towel and wipes her face and hands. Then she sniffles.

ANNA: Now I've got a runny nose, too. And my eyes burn. I must have caught Baby's cold. It must be the weather. (She snuffles again and rubs her eyes.)

BEN (also rubbing his eyes): My eyes hurt, too. (He picks up the towel and wipes his face.) I could hardly get them open this morning. It felt like my eyelids were glued shut. And I seem to be catching a cold, too. (He snuffles.)

BABY staggers onto the stage.

BABY (sniffing and fumbling for the towel): Where's the towel? Oh, here it is, (Picks up the towel and wipes her face.) I feel terrible. My cold is worse and when I woke up this morning, I couldn't open my eyes. There was a lot of sticky stuff on my eyelashes. Oh dear! how can I ever take my exam today? My eyes burn so much that I'll never be able to read the questions.

ANNA: Well, how about me? I have to go to an important meeting at the Women's Club (she pauses to snuffle and rub her eyes) and here I am with a runny nose and burning eyes!

BEN (rubbing his eyes and sniffing): You and Baby are no worse off than I am. My eyes have been all red and burning for two days, and now I've got a cold, too. At least you don't have to go out to the fields and spread fertilizer all around! (BEN rubs his eyes again and snuffles.)

ANNA: Oh dear! (snuffle, snuffle). What are we going to do? (She rubs her eyes.)

BABY (crying and sniffing and rubbing her eyes): Oh dear! Oh dear! Whatever are we going to do?

BEN: I just had an idea. Anna, why don't you call Bonnie next door? She's a barangay health worker. Maybe she has some medicine she can give us to make us feel better.

ANNA: Yes, that is a good idea. I'll go get her right now. (ANNA snuffles, rubs her eyes, wipes her face on the towel, and goes off stage calling "Bonnie! Bonnie!")

BEN and BABY remain on stage, sniffing and rubbing their eyes. ANNA returns to the stage. BONNIE, the BHW, is with her.

BONNIE: Good morning, Ben. Good morning Baby. Anna tells me that none of you are feeling very well today. Let me take a look at you.

BONNIE goes up to each puppet and looks at them carefully. She puts her hand on BABY's cheek. ANNA, BEN, and BABY continue to snuffle and rub their eyes.

ANNA: Can you give us some medicine to make us well?

BONNIE: I don't have any medicine, Anna, but I'll ask my husband to get some eye ointment for you at the Botica sa Baran-gay. It's not very expensive. You all seem to have colds as well as something we call pink eye, or conjunctivitis. They are both very contagious.

ANNA: How could this happen?

BEN: Yes, how could this happen?

ANNA, BEN, and BABY sniffle and rub their eyes. BABY picks up the towel and wipes her tears.

BONNIE: How could this happen? Let's ask our audience. I bet they can solve the mystery for you. (Addresses the audience.) Well, folks, what do you think? Can you tell Anna and Ben and Baby why they all have colds? Can you tell them how they spread pink eye to one another? You there, yes, you in the front row, what have you observed?

BONNIE encourages the audience to share their observations and opinions with the BANDANA family. She summarizes their ideas and helps them explain to the puppets that the germs are spread by everybody using the same towel.

BONNIE asks the audience: What can be done to prevent things like this from happening in your family?

Again, she listens to their suggestions, summarizes their ideas, and encourages them to see that each family member should have his or her own towel, and these towels should be washed and dried in the sunshine frequently. Especially when someone is sick.

ANNA, BEN, and BABY can make comments in response to the audience's suggestions.

e.g. "Oh really?" "Do you do that?" "Hey, that's a good idea." etc.

BONNIE then repeats the audience's suggestions to the BANDANA family.

BONNIE: Now you know how to prevent this from happening again. My husband will bring you some eye ointment. Wash your hands well with soap and water, then put a little ointment inside the lower lid of each eye three times a day. Wash your hands again when you are through. And be sure to drink plenty of water and fruit juices to help get rid of your colds. You'll all be better soon.

ANNA: Thank you, Bonnie. And thank you to everybody in our audience. You've all helped us a lot. The mystery of the spreading sickness has been solved. From now on we're each going to have our own towel...

BABY: ...and our own drinking glass...

ANNA: Yes, and our own drinking glass, too.

BEN: It's nice to share things like food and information with our families and friends, but we shouldn't share our germs.

ANNA: No, we shouldn't. And we're not going to any more. Thanks again, everybody.

BEN &

BABY: Thanks alot. Thank you and goodbye.

BONNIE: That's the end of our show, folks. Thanks for being a part of it. I'm sure the Bandana family has learned a good lesson that they won't forget. We hope that you learned something, too.

A puppeteer displays the final showcard:

...and that's the end of
THE SPREADING SICKNESS

13. MASKS

Masks are very useful for role playing. Not only do they allow the participant to assume the personality and character of the person s/he is portraying, they also help participants shed many of their inhibitions. It is not unusual for people who are ashamed to speak in front of a group, or reluctant to participate in group activities, to express themselves freely from behind the safety and protection of a mask.

Masks, like puppets, can be made from a variety of materials. We offer instructions for just a few of many possibilities.

NOTE: For role-playing purposes, make masks that portray a wide range of emotions - anger, grief, joy, worry, surprise, etc.

A HELPFUL HINT

Most people's eyes are approximately 3" apart. Keep this in mind when designing your masks so that there will always be a clear line of vision.

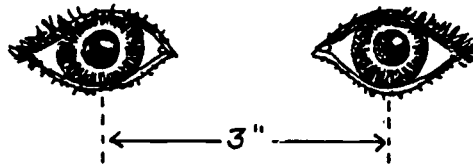

BAG MASK

- 1) Draw a face on one side of a large, square-bottom paper bag.
- 2) Cut holes for eyes and mouth.
- 3) Color with marking pens.



CAUTION!

DO NOT MAKE MASKS FROM PLASTIC BAGS. EVEN WITH HOLES CUT FOR EYES AND MOUTH, A PLASTIC BAG SHOULD NEVER BE PLACED OVER THE FACE OR HEAD.

HAND HELD MASK

Materials:

stiff cardboard
colored marking pens
exacto knife
tape or glue
a flat stick, 25 cm.-30 cm. (10"-12") long

Method:

- 1) Draw a face on a piece of stiff cardboard
- 2) Cut out the head shape, making sure that it is a little larger than life-size.
- 3) Use an exacto knife to cut holes for eyes and mouth.
- 4) Tape or glue a flat stick to the back of the mask. Position the stick slightly off center so that it will not interfere with the mouth opening.

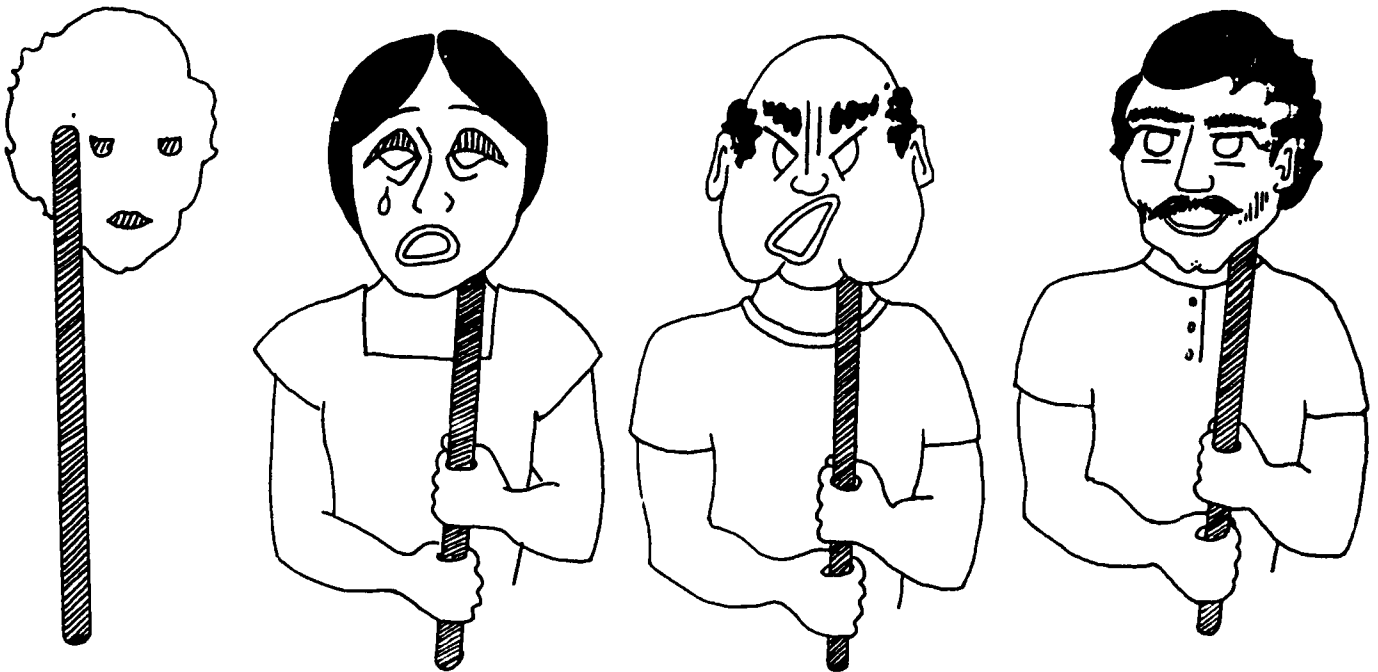

SHAPED PAPER MASK

Materials:

Heavy paper
colored marking pens
scissors/exacto knife
white glue
a piece of string or elastic

Method:

- 1) Draw eyes and mouth on a piece of heavy paper. Outline a truncated triangle where the nose should be. The sides of the triangle should be approximately $3\frac{1}{4}$ " (8 cm.) long.



- 2) Outline the face about 1" (3 cm.) larger than life-size and cut it out.
- 3) Use an exacto knife to cut out eyes, mouth, and triangle nose.
- 4) Use scissors to snip around the edge of the mask. Cuts should be made about 1" (3 cm.) apart and extend into the face approximately 1".

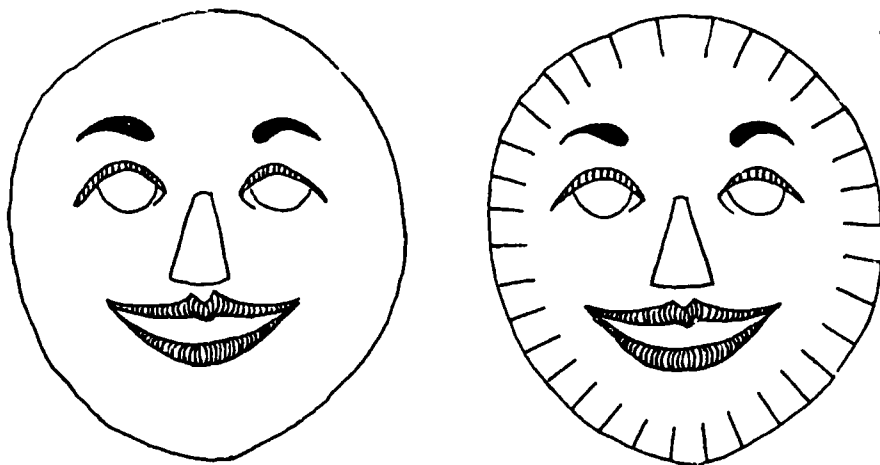

5) To shape the nose:

•Cut a rectangle 5" x 3¼" (13 cm. x 8 cm.) out of heavy paper.

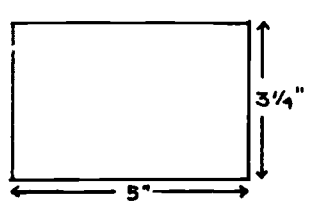

- Fold the top corners of the rectangle toward the center leaving a small gap (no more than ¼" or 5 mm.) down the middle. Each fold should be 3¼" (8 cm.).
- Cut off bottom corners from the center to each side where the fold begins.

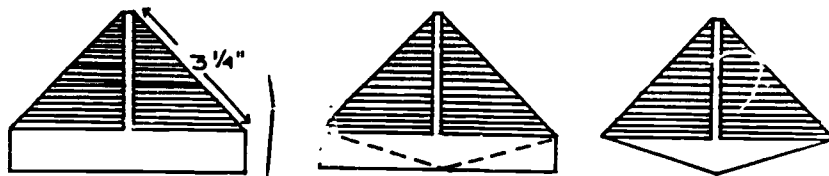

- Unfold the corners of the rectangle. Bend (but do not fold) the paper, and insert corners into the nose opening on the mask. Match the fold lines with the long edges of the triangular hole.
- Glue the two corners of the shaped nose piece flat against the back of the mask.

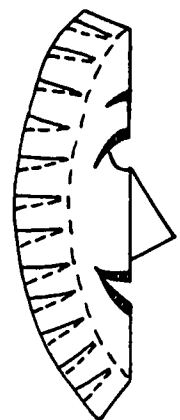
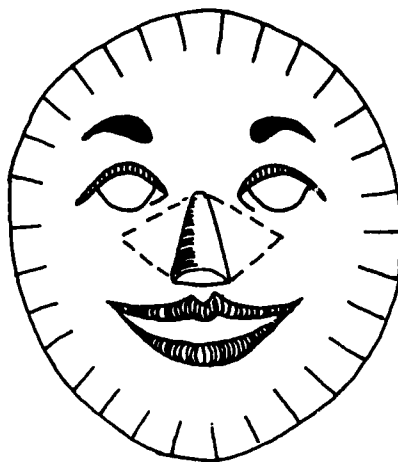

6) To shape the face:

Overlap and glue each tab created by the cuts made around the edge of the mask, one on the other. Continue overlapping and gluing around the whole mask.

- 7) Attach elastic or a piece of string to each side of the mask to hold it in place.

CONTOUR MASK

A contour mask is made to conform to each individual face. Participants should work in pairs to create their own mask. The process of making this kind of mask promotes cooperation between community members.

Materials:

a lightweight fabric scrap 10"-12" (25 cm.-30 cm.) wide and long enough to tie around the head

brown paper craft tape

scissors

glue

colored marking pens or poster paint

a sponge or rag

string or elastic

Method:

- 1) Cut brown paper craft tape into narrow strips about $\frac{1}{2}$ " (1.5 cm.) wide and 2" (5 cm.) long. You will need a lot of these.
- 2) Tie the fabric around the face of your partner.

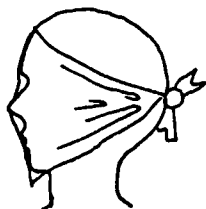

- 3) Moisten strips of tape on a wet sponge or rag and apply to the fabric.

- Outline the mask first.

- Overlap strips as they are applied. Build up two or three thicknesses over the entire surface of the mask.

- Leave openings for the eyes, mouth, and nose.

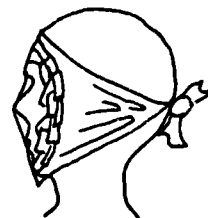

- 4) Very carefully, untie the fabric and remove the mask from the face of your partner. The mask will still be wet and therefore somewhat flexible. Try not to distort the contour.

- 5) Set the mask in the sun to dry.

While your partner's mask is drying, have him/her tie some fabric around your face and apply the tape for your mask.

- 6) When the masks are thoroughly dry, they will be quite stiff. Separate the mask from the fabric by pulling the fabric away from the inner surface of the mask. If the fabric does not pull away easily, simply cut it away from the edges of the mask. Clip the eyeholes, mouth, and nose opening.
- 7) Adjust the size and shape of the eyes and mouth with scissors. Trim any uneven edges of the mask.
- 8) Reinforce the mask by folding strips of moistened tape over all the raw edges. Let dry.



- 9) Paint the mask and/or draw the features with colored marking pens. Add hair and other details as desired.
- 10) Attach elastic or string to each side of the mask to hold it in place.



The surface texture of the contour mask may be modified in a number of different ways. For example:

- 1) Before painting the mask, mix up some spackling compound and spread it as evenly as you can over the outer surface of the mask.
- 2) Let the mask dry thoroughly, then sand it smooth.
- 3) Paint or draw the feature details.
- 4) Seal with a light coat of white glue diluted with a little water.

or:

- 1) Glue heavy brown twine to the surface of the mask in coils and

patterns.

- 2) Coat the mask with white glue mixed with a little water.



Suggested mask activity:

SITUATIONAL ROLE PLAY

- 1) On separate pieces of paper, write out a description of several different problem situations.
- 2) Have a variety of masks available for use by the actors. The masks should represent many different kinds of people and portray a full range of emotions.
- 3) Ask participants to assemble into groups of 4 - 5 persons each.
- 4) Have each group randomly select a problem situation and role play a possible solution for the rest of the members.
 - Allow groups five or ten minutes to identify the problem and develop their strategy.
 - Group members should then select a mask appropriate to the role they are playing.
 - Ask one member of the group to read the problem out loud and introduce the characters before beginning the role play.
 - The group then acts out their method of solving the problem. The role play should not be idealized but acted out in a realistic manner. Personality conflicts, differences of opinion, and bureaucratic red tape should all be considered.
 - Remind groups that there are no "right" or "wrong" solutions. The object of the role play is to explore alternatives.
- 5) Following each skit, players should remove their masks and engage in a brief discussion with the audience.
 - Ask the players how they felt as they interacted with one another.
 - Do they feel their strategy was effective? Why or why not?
 - Encourage the audience to share their observations, feelings, and comments.

Examples of problem situations* for role play:

- 1) An impoverished mountain barrio 17 kilometers from the nearest municipality is completely isolated during the rainy season. The road washes out and the rivers are too high and too swift to cross safely. In the past year, eight people have died needlessly for lack of adequate medical care.
- 2) Sixty-two percent of the children in a certain barangay are malnourished. Although there is some rice farming in the area, the soil is generally poor and irrigation is inadequate. Many of the residents are unemployed.
- 3) The women in Barangay B have been trying for three years to raise funds to build a barangay health station. They are anxious to have a structure where they can hold nutrition and mothercraft classes as well as a permanent center where residents can consult with the local midwife and BHWs about medical problems. The primary health care committee supports their fundraising efforts but, somehow, most of the money taken in seems to end up in the pocket of the barangay captain.
- 4) Diarrheal disease has reached almost epidemic proportions in Barangay C. Only 12% of the population have toilet facilities and most people draw their water from open wells. Only a few families own their own house and land. Most live on property owned by another. Even when they have sufficient funds, renters are reluctant to spend the money to put in a pump and toilet, or to build fences to pen their animals, because they see no point in improving someone else's property.
- 5) The only transportation to and from a remote mountain barrio is provided by a vehicle that makes one round trip daily. The vehicle is owned by the brother of the barangay captain and is driven by his nephew. During the past year, the vehicle has been involved in three serious accidents in which passengers have been killed. The accidents were caused as much by the chronic drunkenness of the driver as by the poor conditions of the road. Following the third accident in which two teenagers were killed and three other persons seriously injured, the license of the driver was suspended. Nevertheless, he has continued to drive. The family of the driver has "connections" in the municipality and in the provincial capital. Neither the number of people nor the demand for transportation could support a second vehicle.

*All these situations have been fictionalized after actual cases.

14. SLIDE PRESENTATIONS

To make a slide presentation:

- 1) Choose your topic. Write a statement of what it is you want to say. Keep your message brief, simple, and to the point.
- 2) Think about how you will develop your story/presentation.
 - List each step in sequence.
 - Follow the sequence steps to write a sample script for the story/presentation.
 - Conceptualize a visual image to demonstrate or describe each step.
 - Make a storyboard. This can be done on paper or on separate 3" x 5" cards.

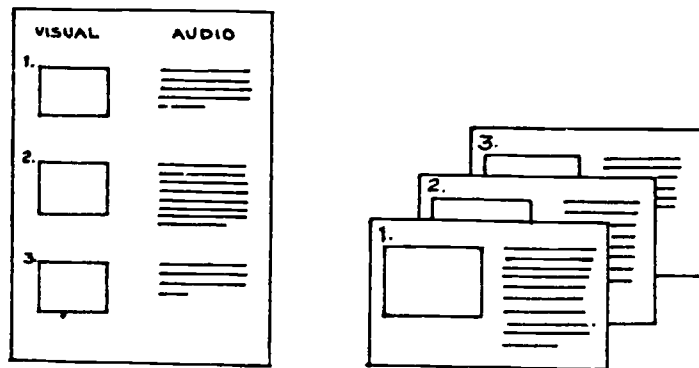

NOTE: The more specific you can be with respect to your visual images, the easier it will be to take the necessary photographs.

- 3) Pretest your idea. Show your storyboard to your family, your friends, your professional colleagues. Pay attention to their suggestions. Refine and modify your idea accordingly.
- 4) Prepare the slides.
 - Use 35 mm. film for colored slides.

FILM SPEED	WHERE/WHEN	EXCEPTIONS	RESULT
Fast film (ASA rating above 200) e.g. Ektachrome 400	Indoors Poor light Subject is moving fast	When using flash close up	Less blurring Coarser quality
Slow film (ASA rating below 200) e.g. Kodachrome 64	In direct sunlight In well-lighted place With close-up flash (7 - 10 feet)		Sharper More detailed Better color

• Know how to use your camera.

Shutter speed: The camera's shutter opens and closes to let light reach the film. By changing the length of time that the shutter is open, you can control how much light reaches the film. Speed choices on better cameras usually range between 1 second and 1/1000 second. Use a tripod or steady the camera against a firm surface for shutter speeds slower than 1/125 second.

THE POOR MAN'S TRIPOD

If you don't have a tripod and can't find a steady surface to rest the camera on, use the "poor man's tripod".

Tie the ends of a long piece of string together. Attach it to a doorknob or window latch, loop it over the camera and under one foot. Stand far enough away from the wall to exert firm tension on the string.

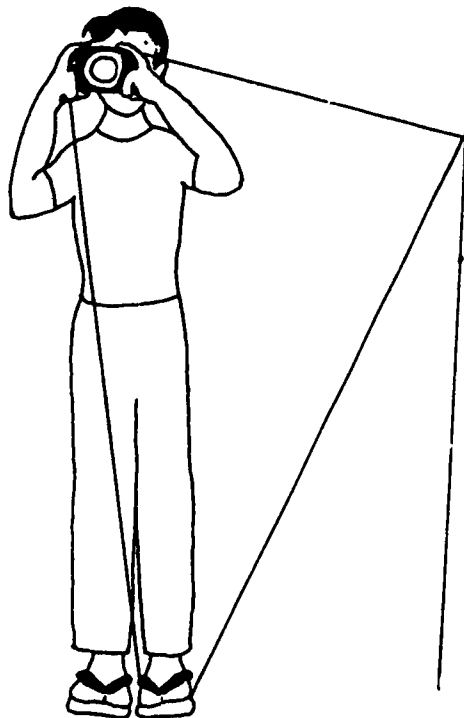

Focus: Be sure that your subject is in focus. Look through the viewfinder. If the object you are trying to photograph is blurred or split,



rotate the focus ring located on the lens until the image appears sharp and clear.



Aperture (F/stops): Adjustable cameras let you control the amount of light that reaches the film by varying the size of the hole through which the light passes.

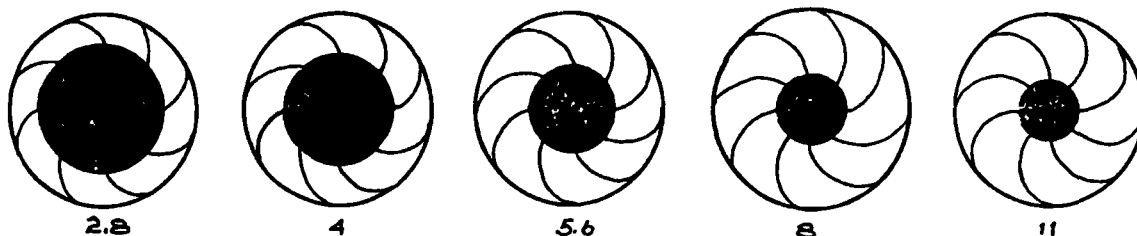

The higher the F/stop number, the smaller the aperture.

A high F/stop (small aperture) provides the greatest depth of field. Everything in your picture, both in front of and behind the subject, will be in focus.

With a low F/stop (large aperture), only the object on which you are focusing will appear sharp. The rest of the image may be slightly blurred.

Exposure: Every scene or subject being photographed is lighted, either naturally or artificially, to produce areas of shadows and highlights with a whole range of tones in between. Most 35 mm. cameras have built-in light meters which, when set to the ASA number of the film, can measure the available light and tell you what combination of aperture (how much light) and shutter speed (how long to let it in) to use for an accurate exposure.

In most situations, select the shutter speed first. Then adjust the aperture ring until the needle in the viewfinder indicates that the exposure is correct.

Where depth of field (clarity of the total image) is the primary concern, select the F/stop first and adjust the shutter speed accordingly.

- Plan your pictures thoughtfully. Consider both lighting and composition.

Lighting: Before pushing the shutter release, check to be sure that the light falls well on the faces of people and on the details of the scene you are trying to photograph.

Whenever possible, avoid taking outdoor pictures when the sun is high. The harsh light of midday creates dark shadows and "flattens" the image through a loss of detail. It is best to take outdoor pictures an hour or so after sunrise or an hour or two before sunset.

When taking indoor pictures with an artificial light source, you should be aware that fluorescent lighting imposes a

greenish tinge to the picture; tungsten light bulbs will result in an orange cast.

To photograph any subject where maximum detail is a priority, (e.g. pictures, charts, skin problems, etc.), use indirect lighting. Outdoors, take pictures on a cloudy or hazy day. Indoors, shine a light against a white wall or sheet so that it reflects onto the subject.

Composition: "Frame" each picture before you shoot. Hold up your hands, thumbs together and forefingers extended...

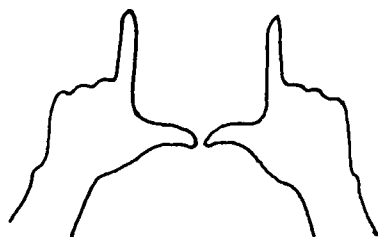

or make a viewfinder by cutting a 2" x 3" rectangular hole out of a slightly larger piece of cardboard.

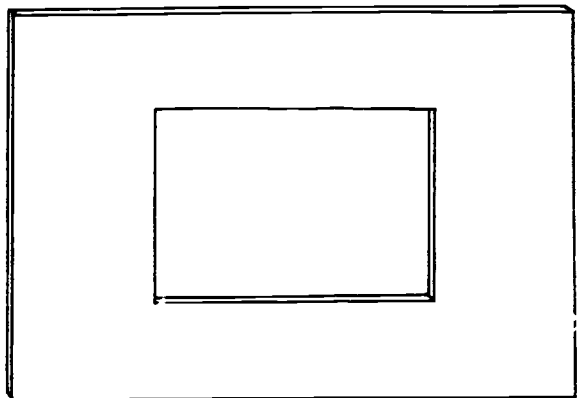

Close one eye and move the frame back and forth and from side to side until you find the most effective composition.

Pay attention to the background. Ask yourself these questions:

Does it add meaning or interest to the main subject of the picture?

Does it add contrast and help the main subject stand out clearly?

Is it free of distraction which might take attention away from the main subject?

Composing a photograph is no different than designing any other visual aid.



State the message clearly and directly.
Include all essential information.
Eliminate all unnecessary elements.

- Take more pictures than you will need.

Don't be caught short when you are putting your presentation together. If you think you might need a particular shot, take it. Nothing says you have to use it in the finished presentation.



IT IS BETTER TO HAVE A PICTURE AND NOT NEED IT
THAN TO NEED A PICTURE AND NOT HAVE IT.

Give yourself choices. Photograph the subject from different angles and at different distances. Bracket your exposures. (Shoot the same picture one F/stop higher and one F/stop lower.)

Buy sufficient film. A general rule of thumb is that you will shoot 4 slides for every 1 slide used in the presentation.

When the slides are returned from the processor, be ruthless. Throw away any of them that are not properly exposed or are technically deficient. Poor slides will turn off your audience. Use only your very best.

- Make a title slide.

Prepare the artwork for the title slide on a piece of poster board at least 18" x 24" (46 cm. x 60 cm.). Remember the proportions and format of a 35 mm. slide. Design the title slide accordingly. Allow for sufficient margin around the artwork to permit you to photograph it easily.

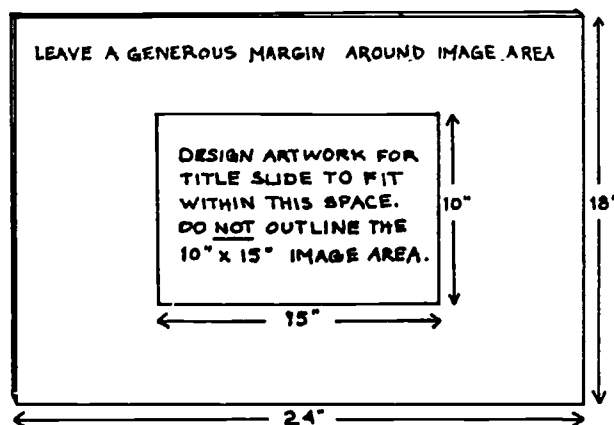

Letter the title and any credits that are being included neatly and clearly. For a more professional look, use transfer letters. The use of color and the inclusion of a visual element in addition to the words will make the title slide more dynamic and interesting.

Photograph the artwork. Take the picture outdoors on a cloudy day (see Lighting, p. 143). Tape or tack the artwork to a vertical surface at eye level. Center the artwork in the viewfinder of the camera making sure that the edges of the poster board are parallel to the frame of the viewfinder. Without shifting the camera's position, step closer to the artwork until the edges of the poster board (as well as the tape or tacks that are holding it to the wall) are no longer visible. Adjust the focus and take the picture. Shoot the artwork more than once by bracketing your exposure. This will help ensure that you get the best possible image. Use a tripod if the shutter speed will be less than 1/125 second.

When you get the title slide back from the processor, check it carefully. If the edges of the board are visible, or if the image is slightly askew, mask off the unwanted areas (or align the image) using thin black plastic tape.

EDGES OF BOARD VISIBLE

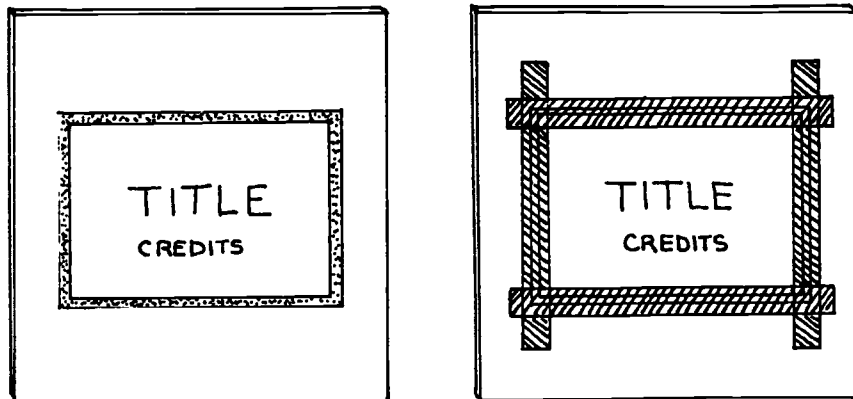
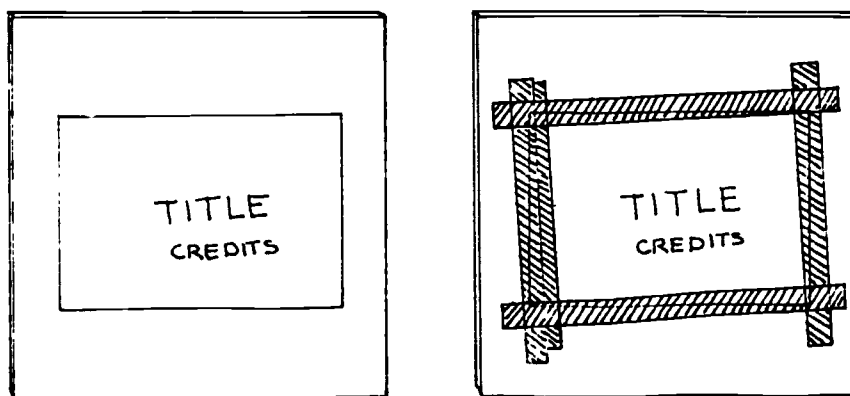

IMAGE ASKEW



5) Put the presentation together.

- Select the slides to be used in the presentation and number each one in sequence. Pay attention to how a slide is placed in the projector, carousel, or cartridge. Always put the sequence number in the upper right corner facing you as you place the slide in position. That way you will avoid projecting upside-down or backward images.
- Prepare the audio portion of your presentation. If you plan on delivering the presentation "live", type the narration that accompanies each slide on a separate 3" x 5" card numbered in sequence.

Alternatively, you can tape your presentation. In this case be sure that you pause 3 to 5 seconds each time the projected image is to change.

To deliver the slide presentation:

- 1) Plan to project the image onto a screen, a blank white wall, or a large piece of poster board stapled to a wooden frame to keep it rigid.
- 2) Arrange the seating so that the whole audience will have a clear view of the screen.
- 3) Set up the projector and slides. Check the equipment to be sure everything is in working order. Adjust the focus. If you have taped the verbal presentation, position the tape player convenient to the projector so that you can easily manage both pieces of equipment.
- 4) When the audience is assembled, introduce the slide show. If possible, darken the room and begin the presentation.
- 5) Allow time for questions and answers following the presentation. Encourage discussion.

PROCEDURE

- 1) Hand out course outline and syllabus.
- 2) Explain that the workshop will be conducted informally and that we will learn by experience and participation. Participants will work in groups - two to four persons on each team. Teams are encouraged to work cooperatively by sharing information, resources, and evaluative feedback.
- 3) Tape learning chart (illustration 1.1.1) to the wall or chalkboard where everyone can see it.
 - Ask one or more volunteers to explain what the chart means to them.
 - Ask participants to generate a single statement to describe the meaning of the chart, e.g. "The more completely we involve our audience in their own learning process, the more fully they will understand" or "We learn most when all of our senses are involved in the process".
 - Summarize the ideas set forth and get a consensus.
 - Print the class statement at the bottom of the chart.
- 4) Briefly review the course outline and syllabus with class members. Remind participants that, although the character of the workshop is informal, there is a lot of material to cover; each workshop session will last three hours. Participants must be punctual, attend every session, and complete all homework assignments as scheduled by the facilitator in order to earn a certificate of completion.
- 5) Send a dated attendance sheet around the room and ask everyone present to sign it. This should be standard operating procedure at each workshop session.
- 6) Tape the picture of the three blind men and the elephant (illustration 1.1.3) to the wall.
 - Ask participants if anyone present is familiar with the story. If anyone is, ask that individual to relate the tale to the rest of the class. If not, give a volunteer a copy of the story to read aloud.
 - After the story has been shared, ask participants if they think any of the blind men really understood the nature of an elephant. Ask them to explain their answers.
 - Now ask if they can relate the story to their role as health educators. Encourage them to see that, as health professionals, we frequently see only one aspect of a barangay health issue. It is imperative that we "walk around" the problem, analyzing it from every angle, in

order to fully understand the situation and be prepared to offer appropriate and relevant alternatives. The fable can also be related to the way in which we present our material to barrio residents. We need to help them examine "the whole beast" rather than simply offering them a tail to hang on to.

- 7) Tape the arrow picture (illustration 1.1.4) to the wall.
•Ask participants which direction the arrows are pointing.

NOTE: Most people will see either one set of arrows or the other - but not both - at least at first.

•Ask the class to examine the picture closely.

- 8) Tape the faces/vase picture (illustration 1.1.5) on the wall next to the arrows.

•Ask participants what they see.

•Can you see both the faces and the vase at the same time?

•Can you see the black arrows and the white arrows at the same time?

NOTE: The answer to both these questions is NO. It is physiologically impossible to focus on more than one item at a time.

•Explain to the class that you are using these two pictures as analogies for the issues and problems we face as health educators. As the pictures demonstrate, there is usually more than one way to look at things. However, so long as we focus on what to us seems obvious, we will fail to see any other alternatives. In this workshop we are going to "walk around the elephant" to try to become familiar with all the aspects of the public health issues with which we shall deal. And, we are going to shift our focus away from the obvious and expected to explore alternate solutions.

PROCEDURE

- 1) Ask participants to define "visual educational aid".
- 2) Ask them to name as many examples of visual educational aids as they can think of. A volunteer should list these on a large piece of newsprint taped to the wall. The list should include:
 - chalk board
 - flip charts
 - posters
 - brochures
 - comics
 - diagrams
 - card games
 - board games
 - cut-outs
 - flash cards
 - flannelboard
 - charts
 - puppets
 - masks
 - models
 - film strips
 - slides
 - videotapes
- 3) Explain that the emphasis in this workshop is on the construction and use of low-cost, low-tech visual aids. Although slide presentations, film strips, and videotapes are valuable tools for the health educator, we are going to concentrate our efforts on less-expensive materials that are simple to produce.
- 4) Pass around (or display) examples of visual aids that can be used by health educators.
- 5) Ask the class to brainstorm/discuss scenarios in which these visual educational aids might be used to advantage in promoting health issues amongst different audiences.

For example:

- a puppet show on dental health/hygiene presented to elementary school children
- recipe cards or pamphlets handed out to mothers following a nutrition class
- flip chart discussion about different methods of toilet construction at a barangay council meeting
- a diagram of a garden layout presented to community members in conjunction with a discussion of alternative sources of nutritional food
- the use of masks/role play to encourage barrio residents to discuss the social and economic causes of their health problems

PROCEDURE

- 1) Set up a display of workshop supplies so that participants can see the materials and tools they will be working with. Explain that, with only a few exceptions, most of the materials they will be using are inexpensive and readily available.
 - Tools such as T-squares, triangles, exacto knives, scissors, etc., are one-time-only purchases. If they are properly taken care of, they will last for years. There should be a complete set of supplies for each team.
 - Felt pens, ink, poster paints, and paper supplies will have to be replaced periodically. These are relatively inexpensive items.
 - Any expendable supplies such as paper, poster board, tape, etc. remaining after the workshop is completed can be divided equally amongst participating teams if you so desire.
 - We will also use "found objects", e.g. fabric scraps, buttons, stones, string, etc. These will be gathered according to need.
- 2) Teams will pool their resources and talents to create their visual aids.
 - Some people are primarily conceptual, i.e. they have an abundance of "great ideas". Others have highly developed mechanical skills.
 - Some people are visually oriented, while others are more verbal.
 - In this workshop we need everybody's skills - conceptual, mechanical, visual, and verbal.
- 3) Tell participants not to worry if they don't know how to draw. It isn't necessary.
 - Once we know what we want, we can always copy or trace an image from another source.
 - Simple designs and drawings are generally the most effective.
 - There may be instances when we will ask our barangay audiences to make their own drawings.
 - If we really get desperate, there is usually someone around who does know how to draw to do it for us.
- 4) Remind participants that we are not in competition with one another. Our work is not destined for a museum or an art gallery. "Good" visual aids are those that are effective in getting a message across to a specific audience.

- 5) We will test the effectiveness of the visual aids which we create by critiquing them in the classroom and pretesting them in the community with a sample audience.

* * * * * TEN MINUTE MERIENDA * * * * *

25 Minutes	DESIGN CONSIDERATIONS	Activity 1.4
------------	-----------------------	--------------

PROCEDURE

- 1) Divide participants into teams. Ideally, team members should live and/or work in the same general location so that they can get together easily to complete homework assignments. The optimum arrangement is to set up four teams of three to four members each.
- 2) Distribute PRINCIPLES OF COMMUNICATION DESIGN (handout 1.4.1).
- 3) After teams have reviewed the manual for a few minutes, ask participants to name the principle characteristics of an effective visual aid. Request a volunteer to write these items on a large piece of paper taped to the wall. The list should contain the following design considerations
 - simple (in terms of both concept and design)
 - direct
 - accurate
 - easily understood
 - easy to use
 - cost effective
 - sensitive to local customs and traditions
 - colorful (to attract and hold attention)
 - appropriate (in terms of subject, occasion, and audience)
 - stimulating (to encourage audience participation)

20 Minutes	THE DESIGN PROCESS	Activity 1.5
------------	--------------------	--------------

PROCEDURE

- 1) Post the prepared list showing the 12 steps of the design process.
- 2) Ask each workshop participant to read (in sequence) and explain one step of the design process. Encourage discussion amongst all participants to be sure that everyone understands each step of the process. Clarify each step and explain how it will be handled in the course of the workshop.

THE DESIGN PROCESS

•ANALYZE AND DEFINE THE PROBLEM

What is the problem? What are its causes? What are its symptoms? How is it related to other factors in the environment/lifestyle of the people affected? How does the target audience perceive the problem?

•IDENTIFY THE TARGET AUDIENCE

Whom does the problem affect? Adults? Children? Infants? A particular vocational group? Who has control over the problem? (e.g. Infants are completely dependent on their parents, particularly the mother; a school child has some measure of control over his/her behavior and environment but is still answerable to the parents; employers frequently control the working environment; independent adults are capable of making their own decisions, etc.)

•COMPOSE A SINGLE-ITEM MESSAGE

Too much information all at once is confusing. Decide what it is you want to say, and say it simply and directly. You can always go back to the barrio another day and discuss another aspect of the problem.

•BRAINSTORM CONCEPTS

The idea here is to generate as many solutions as possible without worrying about feasibility. Be as silly or as outrageous as you want. You can evaluate the idea later. And frequently "far-out" ideas will trigger some very possible solutions. This exercise is best done in a group. Do not spend more than 10 minutes on it.

•EVALUATE AND SELECT

Now, go back and evaluate your ideas in terms of logistical and economic feasibility, appropriateness, etc. Feel free to modify the ideas as you go along. If you have generated 10 or 12 ideas, you should be able to select one or two that are realistically possible.

•DEVELOP IDEA

Make several small "thumbnail" sketches showing scale, color, copy, etc. Make a rough outline of your proposed presentation. How will you use your visual aid to stimulate maximum audience participation? If you contemplate using more than one visual in your presentation, (e.g. sequence posters, flip chart, flannelboard activity, etc.) or you are planning a performance such as a puppet show or role play, make a "story board" indicating sequence and accompanying narration or dialogue.

• SHARE YOUR IDEA - ASK FOR FEEDBACK

Frequently we become so involved with our ideas that we can no longer see or judge them objectively. We need to get other opinions. An integral part of developing an effective visual aid is continuing evaluation. Show your rough sketches and outline to your friends, your family, your professional colleagues. Explain the problem you are trying to solve and ask how your visual aid and/or presentation strategy can be improved. In this workshop we will present our initial ideas and rough sketches to the group-at-large for evaluative feedback.

• MODIFY DESIGN/CONCEPT

It is often said that the only difference between an amateur and a professional is that the professional is willing to use the wastebasket. Amateurs tend to consider their creative efforts as something precious. Having spent several hours developing their ideas and drawing them up, amateurs are usually reluctant to make changes. Professionals expect to revise their ideas a number of times before coming up with the final solution. Please try to be open-minded about your design. Listen and pay attention to the feedback of your peers. Modify/refine your design/presentation strategy accordingly. Remember that when someone makes a suggestion regarding your idea, it is not a personal criticism. We all need this kind of objective evaluation in order to develop visual aids and educational strategies that are truly effective. Chances are good that you will have to rework your design and/or presentation strategy at least once more following your community pretest.

• COMPLETE FINISHED ARTWORK/PRESENTATION SCRIPT

Gather all your tools and supplies necessary to complete the project. Work in a clean, well-lighted room.

• TEST WITH SAMPLE AUDIENCE

We will pretest each of our projects in the community with a sample audience. We will explain to them that we are developing visual aids for health education and ask that they assist us by participating in the presentation, and by sharing their responses to the learning materials and teaching strategies with us.

• OBSERVE AUDIENCE RESPONSE - ASK FOR AUDIENCE RESPONSE

One member of the presentation team should act as an observer, making notes with respect to interest shown, level of audience participation, and the facilitator's role. At the end of the presentation, the audience should be asked what they thought about the presentation and why. Ask how the visual material and/or presentation

technique could be improved. Be careful about the manner in which you solicit your information. People have a tendency to tell us what they think we want to hear, particularly when they perceive us as being in a position of authority. Avoid questions that can be answered YES or NO. Let the people know that you really need their help and ask open-ended questions that can be answered in terms of opinions, feelings, and explanations.

·MODIFY VISUAL AID AS REQUIRED

Revise your visual aid and/or presentation strategy as indicated by the community pretest.

20 Minutes

PROJECT ASSIGNMENTS

Activity 1.6

PROCEDURE

- 1) Ask participants to assemble once again into teams.
- 2) Using the list of visual aids compiled in Activity 1.2, write the name of each visual aid on a separate piece of paper.

NOTE: The workshop does not have the facilities nor the equipment to produce film strips, slide presentations, or video tapes. Please limit your list to low-tech, low-cost visual aids which can be constructed from locally available materials.

- 3) Fold each piece of paper into quarters and place in a box, bag, or other container. Ask each team to randomly select three slips. Drawn slips will indicate the visual aids to be constructed by each team.

If you wish, allow for a five minute trading session following the random drawing to permit teams to exchange assignments as desired.

- 4) Ask teams to discuss amongst themselves the public health issues they will address. Ask them to refer to the list of scenarios (from Activity 1.2) and to consider each issue in terms of a potential target audience and method of presentation appropriate to their assigned visual aid. Each team should list their projects in the order in which they will be executed.

PROCEDURE

- 1) Ask a representative from each team to announce the team's projects and proposed schedule.
- 2) Write all the projects on a large piece of paper so that everyone will be aware of what other teams are doing, and in what order.

Example:

TEAM	PROJECT #1	PROJECT #2	PROJECT #3	PROJECT #4
A	<u>comics</u> personal hygiene	<u>card game</u> nutrition	<u>diagram</u> backyard garden	silk screened display poster
B	<u>brochure</u> toilet construction	<u>puppet show</u> venereal disease	<u>flip chart</u> diarrheal diseases	
C	<u>flannelboard</u> nutrition	<u>comparative</u> <u>posters</u> environmental sanitation	<u>chart</u> food habits	
D	<u>sequence</u> <u>posters</u> water purification	<u>board game</u> health/ sickness factors	<u>flash cards</u> food values	

- 3) The fourth and final project will be a silkscreened display poster.
 - Ask participants to suggest topics for this poster.
 - Discuss the merits of each topic.
 - Request a consensus through mutual agreement or vote.
 - Write this topic on the master plan under Project #4.

PROCEDURE

- 1) Distribute MAKING & USING VISUAL AIDS (handout 1.8.1). Warn participants not to be intimidated by the amount of information presented. Explain that the manual is to be used simply for technical reference and as a source for suggested participatory presentation strategies.
- 2) After reviewing the manual, each individual will work independently to generate four to five different ideas for his/her team's first project. Participants will bring a rough outline of these ideas to Session 2.

PURPOSE

Following a review of design principles, Session 2 will give participants an opportunity to experience the first six steps of the design process through direct participation.

OBJECTIVES

Participants will be able to analyze a public health issue, compose a single-item message, and address it to a specific target audience. Teams will develop their initial designs and presentation strategies for Project #1.

MATERIALS

list of design considerations (from Session 1, Activity 1.4)
 The Design Process (prepared list from Session 1, Activity 1.5)
 Master Plan (from Session 1, Activity 1.7)
 newsprint (or brown paper) and felt pens

PREPARATION

Post the master plan on the wall where everyone can see it clearly.

ACTIVITY SEQUENCEEstimated Time

2.1	Design Principles: Review	10 minutes
2.2	The Design Process: Review	15
2.3	Design Development: Brainstorming & Evaluation	50
***	Merienda	10
2.4	Design Development: Sketches/Storyboards/Scripts	90
2.5	homework Assignment: Initial Design Completion	<u>5</u>
		180 minutes

PROCEDURE

- 1) Ask participants to take out a piece of paper and list the design considerations of an effective visual aid. Each individual should work independently without referring to any notes.
- 2) Request participants to trade papers. While this is being done, post the list of design considerations (from Session 1, Activity 1.4) on the wall where everyone can see it.
- 3) Read each item aloud while participants correct each other's lists. Forgotten items should be added to each list before it is returned to its author.

PROCEDURE

- 1) Now, ask participants to list the twelve steps of the design process on the other side of their paper. Again, they should work independently without referring to their notes.
- 2) Have participants trade papers again. Ask a volunteer to read aloud the items as they appear on the list s/he holds.
- 3) As each item is read, write it - in the sequence given - on the chalkboard.
- 4) Ask participants if the list is correct. Have any items been left out? Are the items in the proper sequence? Do not offer any input yourself. Keep the discussion going until all the participants agree that, to the best of their knowledge, the list is correct.
- 5) Now post the list prepared for Session 1 (from Activity 1.5). Ask participants to compare the two lists. Ask them to correct their colleague's list as required and return it.

PROCEDURE

- 1) Participants should group themselves in teams. Using the ideas and concepts they developed as a result of their homework assignment as a starting place, they should "brainstorm" and try to generate at least eight to ten ideas for Project #1. Call "time" after 10 minutes.
- 2) Ask teams to discuss the ideas they have generated. They should feel free to modify and refine the concepts as they are being discussed. Ask them to evaluate their ideas in terms of:
 - appropriateness to subject matter and occasion
 - manageability of both production and use
 - sensitivity to customs and traditions of target audience
 - cost effectiveness
- 3) Based on their evaluation, teams should select one idea to develop visually and editorially.
- 4) Alternatively, team members may elect to reproduce and/or adapt an appropriate activity described in MAKING & USING VISUAL AIDS.

* * * * * TEN MINUTE MERIENDA * * * * *

PROCEDURE

- 1) At this point, facilitator should work closely with teams to help them make their thumbnail sketches and/or storyboards, and to assist them in outlining their presentation strategy and script.
- 2) Remind team members to refer to the list of characteristics describing a "good" visual aid to be sure that their idea/design is:

• simple	• easily understood	• sensitive to
• direct	• colorful	local customs
• accurate	• stimulating	and traditions

PROCEDURE

- 1) Teams will complete their thumbnail sketches, storyboards, and presentation outlines.
- 2) Teams will make arrangements for a venue and sample audience to pretest Project #1. The pretest should be scheduled to take place following Session 3.

PURPOSE

Team ideas for Project #1 will be critiqued and discussed. Designs will be modified as indicated and final artwork completed in preparation for the community pretest.

OBJECTIVES

Participants will learn to give and take constructive criticism. Teams will complete Project #1 and pretest it in the community with a sample audience.

MATERIALS

sketches, storyboards, and scripts developed during Session 2
list of design considerations (from Session 1, Activity 1.4)
newsprint and felt pens
art supplies as required
evaluation forms (handout 3.4.1, p. 165)

PREPARATION

- 1) Post list of design considerations where all participants can see it clearly.
- 2) Reproduce evaluation forms for each team to use at their pretest.

ACTIVITY SEQUENCEEstimated Time

3.1	Preliminary Critique & Discussion	50 minutes
3.2	Design Modification	20
***	Merienda	10
3.3	Finished Artwork	80
3.4	Homework Assignment: Pretest Project #1	<u>10</u>
		180 minutes

Date/Time _____

Facilitator/Team _____

Community Group _____ Location _____

Number of people in attendance _____

Activity _____ Materials used _____

1. What did facilitator do? (Check appropriate items)

Listened and asked questions _____

Guided the meeting _____

Stimulated and encouraged discussion _____

Had community members use materials _____

Summarized issues and opinions _____

Other: _____

2. What was the participation of group members?

Took an active role in the activity _____

Answered questions _____

Made observations _____

Shared ideas and experiences _____

Discussed a problem or felt need _____

Showed enthusiasm _____

Other: _____

3. Level of group participation

A few _____ About half _____ Most of the group _____

4. What comments/suggestions were made by the group about the materials used and/or the presentation strategy? _____

PROCEDURE

- 1) A representative from each team will present the team's ideas for Project #1 to the group-at-large. Each presentation/discussion should last no longer than 15 minutes.
 - Post visuals on the wall and give everyone a chance to look them over.
 - Give a brief explanation of the problem, the target audience, the rationale, and the proposed method of presentation.
- 2) Encourage group discussion. Participants should feel free to ask questions and make suggestions for improving the design and presentation strategy in terms of clarity, accuracy, ability to stimulate maximum audience participation, and sensitivity to local customs and traditions.
- 3) A second representative from the team should take notes of all comments made for later reference.

NOTE: Remind participants that a critique is not "criticism" or passing judgement on good, bad, right, or wrong. Our commitment in this workshop is to effective, relevant health education techniques. Our comments and suggestions ought to be constructive toward this end.

PROCEDURE

Individual teams will work together to modify their designs and presentation strategies as indicated by the preliminary critique.

* * * * * TEN MINUTE MERIENDA * * * * *

PROCEDURE

The remainder of Session 3 will be devoted to executing the finished artwork and presentation scripts for Project #1. Facilitator will work closely with individual teams by providing technical assistance as required.

10 Minutes HOMEWORK ASSIGNMENT: PRETEST PROJECT #1 Activity 3.4

PROCEDURE

- 1) Teams will report the time and place of their scheduled pretest to the facilitator and their colleagues. Facilitator (and as many other participants as possible) should arrange to observe all pretests.
- 2) Facilitator will describe the pretest technique. A volunteer should write the steps on the chalkboard or a large piece of paper for participants to copy down.
 - Introduce the activity: Introduce yourself to the audience. Explain that you are trying out some new material that you are developing in a workshop. Tell the audience that you would like to have their honest response to the visual aids and presentation strategies that you will be using.
 - Carry out the activity: Team members should take turns facilitating the pretests so that everyone has an opportunity to practice this role. Team members not directly involved with the presentation should observe and take notes on the presentation technique and audience reaction.
 - Evaluate the activity: After completing the presentation, ask the audience the following questions:
 - What did you learn from this presentation?
 - What did you like or dislike about the presentation? Why?
 - Was there anything you didn't understand? What?
 - How can the visuals and/or presentation be improved?
 - Are there any additional comments you would like to make?



REMEMBER: Ask open-ended questions that require an opinion, an explanation, or a description of feelings. Avoid questions that can be answered YES or NO.

- 3) Facilitator will distribute evaluation forms to each team.
- 4) Teams should rehearse/roleplay their presentation before the actual pretest to be sure they are well prepared and that the presentation will run smoothly.
- 5) Carry out the pretest as scheduled.

PURPOSE

Following team reports of the Project #1 pretest, initial designs and presentation strategies for Project #2 will be developed.

OBJECTIVES

Participants will demonstrate their ability to generate and develop ideas through creative brainstorming techniques. They will be able to evaluate these ideas with respect to the problem at hand and represent them clearly and concretely.

MATERIALS

Project #1: completed visual aid	newsprint and felt pens
Project #1: presentation script	resource material as
Project #1: pretest evaluation form	required

PREPARATION

None

ACTIVITY SEQUENCEEstimated Time

4.1 Project #1: Pretest Reports	30 minutes
4.2 Project #2: Brainstorming & Evaluation	50
*** Merienda	10
4.3 Project #2: Sketches/Storyboards/Scripts	85
4.4 Homework Assignment: Design Completion	5
	<u>180 minutes</u>

PROCEDURE

- 1) A representative from each team will report the results of the pretest for Project #1 to the group-at-large. Each report should be limited to 5 minutes.
 - display visual aid for Project #1
 - briefly outline presentation strategy
 - use evaluation form for reference
 - describe facilitator's feelings before, during, and after presentation
 - describe observed audience reaction and response
 - discuss audience suggestions and comments
- 2) Workshop participants will offer comments and suggestions regarding modification of the visual aid and/or presentation technique in light of the pretest report.

PROCEDURE

- 1) Following the procedure established in Session 2, participants should group themselves in teams and engage in a brainstorming session to generate as many ideas as possible for Project #2. They should spend no more than 10 minutes on this activity.
- 2) After they have generated eight to ten possible solutions, the ideas should be discussed and evaluated in terms of:
 - appropriateness to subject, occasion, and audience
 - manageability of both production and use
 - sensitivity to customs and traditions of target audience
 - originality
 - cost effectiveness

Creative concepts should be modified and refined throughout this evaluation process.
- 3) Based on their evaluation, teams should select one idea to develop visually and editorially.
- 4) Alternatively, team members may elect to reproduce and/or adapt an appropriate activity described in the manual,
MAKING & USING VISUAL AIDS.

85 Minutes SKETCHES/STOEYBOARDS/SCRIPTS Activity 4.3

PROCEDURE

- 1) Again, following the procedure established in Session 2 for Project #1, facilitator should work closely with teams to help them make their thumbnail sketches and/or storyboards, and to assist them in outlining their presentation strategy and script.
- 2) Team members should keep in mind the design characteristics of an effective visual aid as they develop their concepts.

A "good" visual aid is:

- | | | |
|-----------|--------------------|----------------|
| ·simple | ·easily understood | ·sensitive to |
| ·direct | ·colorful | local customs |
| ·accurate | ·stimulating | and traditions |

5 Minutes HOMEWORK ASSIGNMENT: DESIGN COMPLETION Activity 4.4

- 1) Teams will modify/revise Project #1 as indicated by pretest.
- 2) Teams will complete their thumbnail sketches, storyboards, and presentation outlines.
- 3) Teams will make arrangements for a venue and sample audience to pretest Project #2. The pretest should be scheduled to take place following Session 5.

PURPOSE

Project #1, corrected as indicated by the pretest, will be submitted for final evaluation. The remainder of Session 5 will be devoted to the completion of Project #2.

OBJECTIVES

Participants will begin to recognize the necessity for, as well as the benefits of, an active, on-going evaluation process to support the development of an effective visual aid and presentation strategy. Teams will complete Project #2 and pretest it in the community with a sample audience.

MATERIALS

Project #1, corrected as required
 sketches, storyboards, and scripts developed during Session 4
 list of design considerations (from Session 1, Activity 1.4)
 newsprint and felt pens
 art supplies as required
 evaluation forms

PREPARATION

- 1) Post list of design considerations where all participants can see it clearly.
- 2) If necessary, reproduce evaluation forms (handout 3.4.1, p. 165) for each team to use at their second pretest.

ACTIVITY SEQUENCEEstimated Time

5.1	Project #1: Final Evaluation	20 minutes
5.2	Project #2: Preliminary Critique & Discussion	60
5.3	Project #2: Design Modification	20
***	Merienda	10
5.4	Project #2: Finished Artwork	65
5.5	Homework Assignment: Pretest Project #2	5
		<u>180 minutes</u>

20 Minutes

PROJECT #1: FINAL EVALUATION

Activity 5.1

PROCEDURE

A representative from each team will submit the visual aid/presentation script from Project #1, corrected as required by community pretest, so that all participants can make a note of the final result.

60 Minutes

PROJECT #2: CRITIQUE & DISCUSSION

Activity 5.2

PROCEDURE

- 1) Following the pattern set in Session 3 for Project #1, a representative from each team will present the team's ideas for Project #2 to the group-at-large. Presentations should be kept to 15 minutes or less.
 - Post visuals on the wall and give everyone a chance to look at them.
 - Give a brief explanation of the problem, the target audience, the rationale, and the proposed presentation strategy.
- 2) Group discussion should be encouraged. Facilitator should prompt participants to ask questions and make suggestions for improving the design and method of presentation in terms of clarity, accuracy, sensitivity to local customs, and ability to stimulate maximum audience participation.
- 3) The other team members should take notes of the suggestions and comments as a reference toward modification of the design.

20 Minutes

PROJECT #2: DESIGN MODIFICATION

Activity 5.3

PROCEDURE

Individual teams will work together to modify their designs and presentation strategies for Project #2.

65 Minutes PROJECT #2: FINISHED ARTWORK Activity 5.4

PROCEDURE

The remainder of Session 5 will be devoted to executing the finished artwork and presentation scripts for Project #2. Facilitator will work closely with individual teams by providing technical assistance as required.

5 Minutes HOMEWORK ASSIGNMENT: PRETEST PROJECT #2 Activity 5.5

PROCEDURE

- 1) Teams will report the time and place of their scheduled pretest for Project #2 to the facilitator and their colleagues. Facilitator should observe all pretests.
- 2) Facilitator will review pretest techniques with participants.
 - Ask a volunteer to name the first step in conducting a pretest.
 - Ask a second volunteer to describe the procedure.
 - Ask yet another workshop participant what is the second step.
 - A fourth person should be asked to describe the responsibilities of non-presenting members of the team.
 - Finally, ask participants how they will evaluate their team's presentation to the community. What kinds of questions will they ask?



REMEMBER: Avoid YES and NO questions. Ask open-ended questions that require opinions, explanations, and descriptions of feelings.

- 3) Distribute evaluation forms to each team.
- 4) Remind teams that they should rehearse/role play their presentations prior to the pretest so that they will feel at ease and well prepared when they face their target audience.
- 5) Teams will carry out the pretest for Project #2 as scheduled.

PURPOSE

Following team reports of the Project #2 pretest, initial designs and presentation strategies for Project #3 will be developed.

OBJECTIVES

Participants will demonstrate their ability to generate, evaluate, and select alternative, nontraditional solutions to health education problems. They will be able to tailor these solutions to the specific needs of their target audience.

MATERIALS

Project #2: completed visual aid	newsprint and felt pens
Project #2: presentation script	resource material
Project #2: pretest evaluation form	as required

PREPARATION

None

ACTIVITY SEQUENCEEstimated Time

6.1 Project #2: Pretest Reports	30 minutes
6.2 Project #3: Brainstorming & Evaluation	50
*** Merienda	10
6.3 Project #3: Sketches/Storyboards/Scripts	85
6.4 Homework Assignment: Design Completion	<u>5</u>
	180 minutes

PROCEDURE

- 1) As was done in Session 4 for Project #1, a representative from each team will report to the group-at-large the results of the pretest for Project #2. Each team report should be limited to 5 minutes.
 - display visual aid for Project #2
 - briefly outline presentation strategy
 - use evaluation form for reference
 - describe facilitator's feelings before, during, and after presentation
 - describe observed audience reaction and response
 - discuss audience suggestions and comments
- 2) Workshop participants will offer comments and suggestions regarding modification of the visual aid and/or presentation strategy in response to the pretest report.

PROCEDURE

- 1) Following the procedure established in Sessions 2 and 4, participants should assemble in teams and engage in a brainstorming session to generate as many ideas as possible for Project #3. This activity should be limited to a maximum of 10 minutes.
- 2) After team members have generated eight to ten possible solutions, the ideas should be discussed, modified, refined, and evaluated in terms of:
 - appropriateness to subject, occasion, and audience
 - manageability of both production and use
 - sensitivity to customs and traditions of target audience
 - ability to stimulate maximum audience participation
 - originality
 - cost effectiveness
- 3) Based on a thorough evaluation, teams should select one idea to develop visually and editorially.
- 4) Alternatively, team members may elect to reproduce and/or adapt an appropriate activity described in the manual, MAKING & USING VISUAL AIDS.

85 Minutes	SKETCHES/STORYBOARDS/SCRIPTS	Activity 6.3
------------	------------------------------	--------------

PROCEDURE

- 1) Again, following the procedure established in Session 2 for Project #1 and in Session 4 for Project #2, facilitator should work closely with teams to help them make their thumbnail sketches and/or storyboards, and to assist them in outlining their presentation strategy and script.
- 2) Team members should keep in mind the design considerations of an effective visual aid as they develop their concepts. Their presentation should be:
 - simple
 - direct
 - accurate
 - easily understood
 - colorful
 - stimulating
 - sensitive to local customs and traditions

5 Minutes	HOMEWORK ASSIGNMENT: DESIGN COMPLETION	Activity 6.4
-----------	--	--------------

- 1) Teams will modify/revise Project #2 as indicated by pretest.
- 2) Teams will complete their thumbnail sketches, storyboards, and presentation outlines for Project #3.
- 3) Teams will make arrangements for a venue and sample audience to pretest Project #3 in the community. The pretest should be scheduled to take place following Session 7.

PURPOSE

Project #2, corrected as indicated by the pretest, will be submitted for final evaluation. Project #3 will be completed. Planning will begin on Project #4.

OBJECTIVES

Participants will be able to present their creative ideas clearly and succinctly. They will be able to accept and use constructive criticism to develop an effective visual aid and presentation strategy. Teams will complete Project #3 and pretest it in the community with a sample audience. Participants will be introduced to the principle design characteristics of a display poster as well as to the fundamentals of silkscreen printing.

MATERIALS

Project #2, corrected as required
 sketches, storyboards, and scripts developed during Session 6
 list of design considerations (from Session 1, Activity 1.4)
 newsprint and felt pens
 art supplies as required
 evaluation forms (handout 3.4.1, p. 165)
A SILKSCREEN MANUAL (handout 7.7.1, pp. 181-202)

PREPARATION

- 1) Post list of design considerations where all participants can see it clearly.
- 2) Reproduce and collate sufficient numbers of the silkscreen manual for all participants to have their own copy.

NOTE: If your budget cannot accommodate so many copies, reproduce one manual for each team and ask participants to share.

- 3) If necessary, reproduce evaluation forms for each team to use at their pretest for Project #3.

ACTIVITY SEQUENCEEstimated Time

7.1	Project #2: Final Evaluation	20 minutes
7.2	Project #3: Preliminary Critique & Discussion	60
7.3	Project #3: Design Modification	20
***	Merienda	10
7.4	Review: Display Poster Design Considerations	15
7.5	Project #4: Brainstorming & Evaluation	30
7.6	Project #4: Idea Selection	20
7.7	Homework Assignment: Pretest Project #3	
	Project #4 - Tight Comp	<u>5</u>
		180 minutes

Silkscreening is a printing process which uses a screen of silk or other fine-meshed fabric as a stencil. A squeegee is used to press ink through the fabric on to the paper or other material below. The image to be printed can be applied to the fabric screen in several different ways. This manual provides instructions for the cut stencil method.

Table of Contents

A.	Silkscreen Frame Construction	182
B.	Squeegee Construction	183
C.	Silkscreen Assembly	184
D.	Silkscreen Art Preparation	186
E.	Cutting the Stencil	189
F.	Adhering the Stencil	191
G.	Silkscreen Inks and Solvents	193
H.	Silkscreen Printing	196
I.	Silkscreen Clean-up	200

A. SILKSCREEN FRAME CONSTRUCTION

- 1) Construct a frame from 1" x 2" lumber slightly larger than the largest poster you plan to make. (Suggested size: 24" x 36")

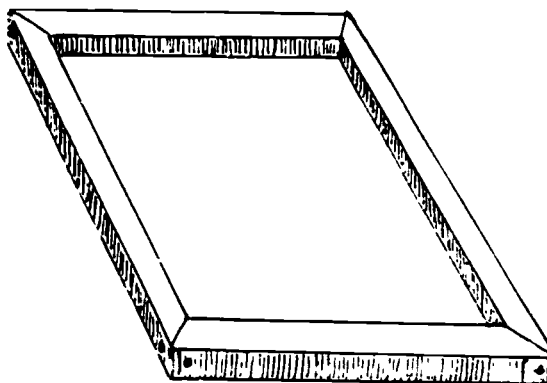

- 2) Make a baseboard from 1/4" plywood the same width but 2" longer than frame. Attach a 1" x 2" headboard securely at one end.

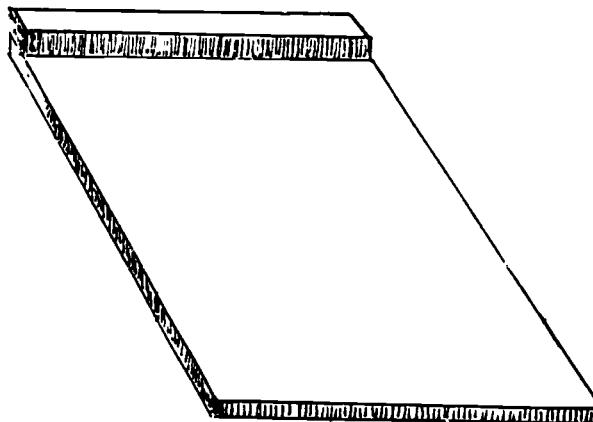

- 3) Attach frame to heading of baseboard with pin hinges so that frame can be easily removed for cleaning.

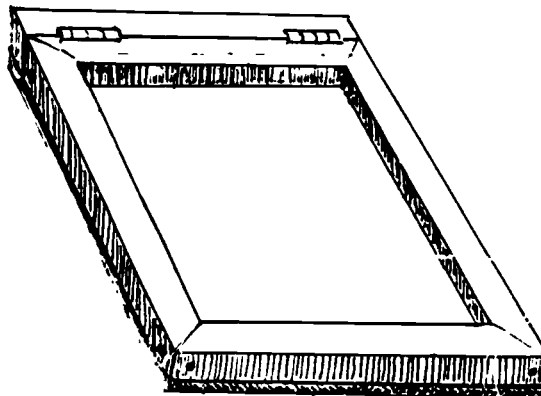

B. SQUEEGEE CONSTRUCTION

A squeegee is used to pull the ink across the silkscreen and force it through the open areas of the stencil onto the paper below. The squeegee should be approximately 2" shorter than the width of the screen. A screen 24" x 36" requires a 22" squeegee.

Squeegees may be purchased at a silkscreen supply store and are generally priced per inch. If you prefer, you can make your own squeegee by one of the two following methods.

Method #1.

Bolt a flat piece of rubber (4" wide x 22" long x $\frac{1}{2}$ " thick) between two pieces of wood (3" wide x 22" long x $\frac{1}{2}$ " thick).

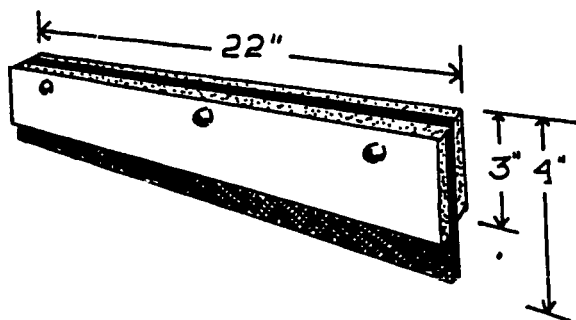

Method #2.*

Wrap a piece of inner tube or thin rubber around a stiff 22" long strip of metal or thin plywood. Mount in a wooden frame which is also 22" long.

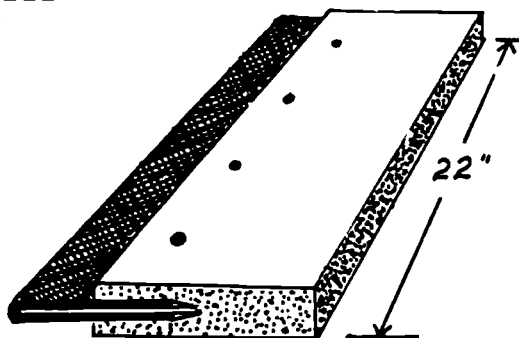

*Source: David Werner and Bill Bower, Helping Health Workers Learn, (Palo Alto, California: The Hesperian Foundation, 1982). p. 16-13.

C. SILKSCREEN ASSEMBLY

- 1) Remove pins from hinges (you'll probably need a screwdriver to do this) and separate frame from baseboard. Replace pins in baseboard hinges so they will not get lost and set baseboard aside. Place frame top (hinge-side) down on the work table.
- 2) Cut fabric about 4" longer and 4" wider than outer dimensions of frame. (For a 24" x 36" frame constructed from 1" x 2" lumber, you will need to cut the silk 32" x 44".)

- 3) Center fabric over frame allowing a 2" extension on all four sides.

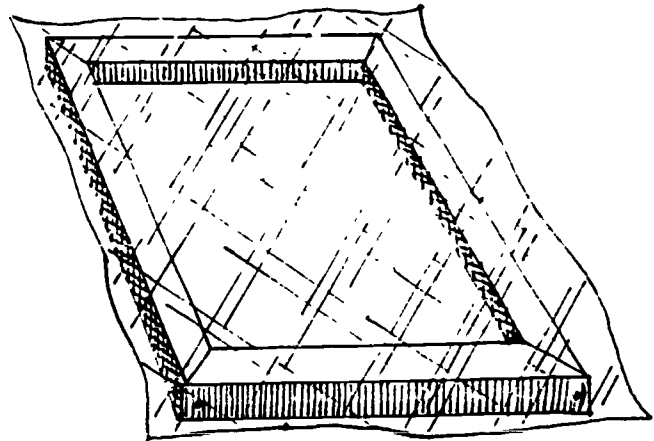

- 4) Stretch fabric tightly over frame and staple securely to the outer edge of all four sides. Begin stapling in the center of each side, working outward to the corners of the frame, alternating from side to side. For best results, this operation should be done by two people: one to pull the fabric tautly across the frame and hold it in position; the second to staple. Staples should be placed no more than 1" apart.

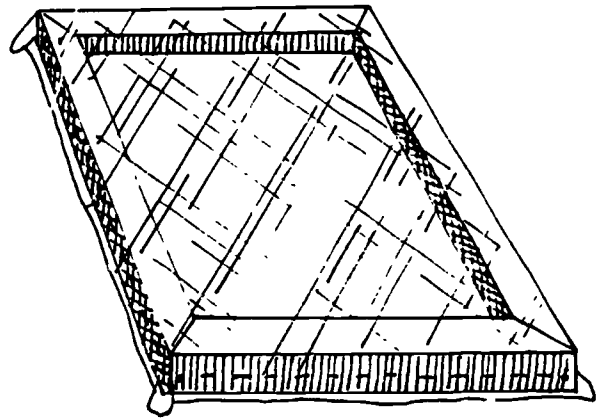

- 5) Now, go back around the frame, turning under the raw edges of the fabric and securing them to the frame with a second row of staples. Fold and staple corners neatly. Add a third row of staples on the uppermost surface of the frame.

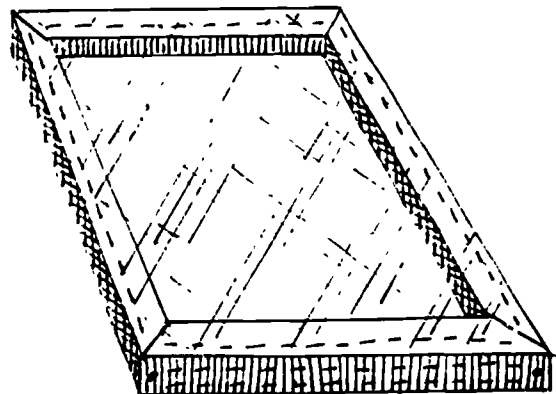

- 6) Seal the inside edges of the frame on both sides with gummed paper tape or masking tape. Be sure that the tape covers all the staples. Cover tape and inside edges of the screen with a light coat of lacquer.

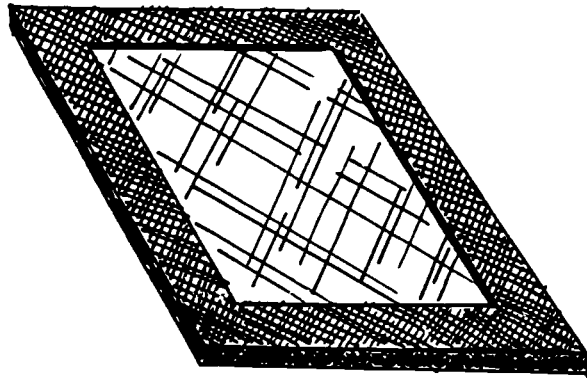

- 7) Attach frame, screen side down, to heading of baseboard by reinserting pins into hinges. The frame is now ready to have stencils attached.

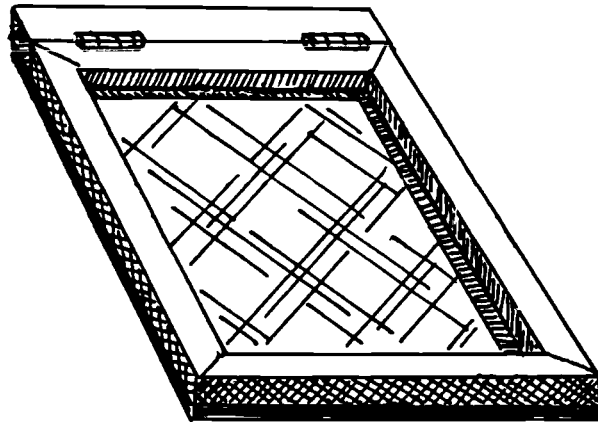

D. SILKSCREEN ART PREPARATION (cut stencil method)

Art for silkscreening with a cut stencil should be designed with large, simple shapes and a minimum of copy lettered in a bold type face. All line work should be bold also for ease in cutting the stencil. Separate, rather than overlapped, components will make the printing process simpler.

- 1) Once the concept has been developed, draw a tight comp of the design to size. A tight comp (an abbreviation for "tight comprehensive layout") is art that looks exactly the way you want the printed piece to appear. The size, placement, and color of all components, including the type, must be accurate. The tight comp may be drawn on brown paper.

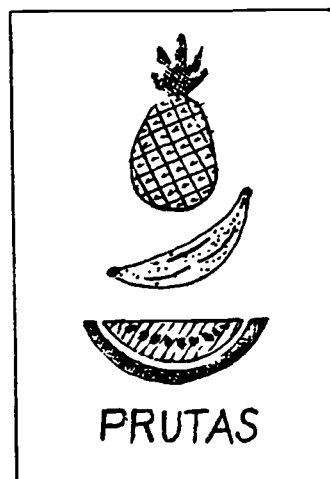

TIGHT COMP

- 2) The next step in preparing artwork for silkscreen reproduction is to keyline the design.

- Tape the tight comp securely to your work table.
- Center a piece of tracing paper over the tight comp and tape the top edge to the table so that it will not shift while you are working.
- Using a fine point black pen, carefully outline each separate component and color area in your design. Use a ruler for straight lines. Lift the bottom edge of the tracing paper from time to time to check your tight comp against your keylined pattern. Be sure you are not missing any details.

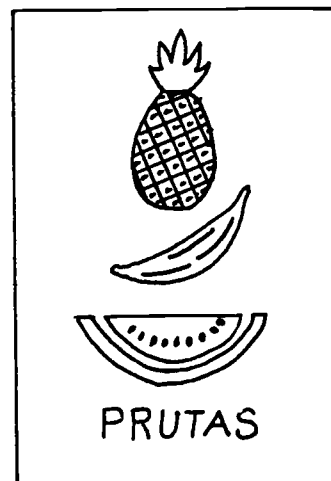

KEYLINED PATTERN

3) Now you are ready to make your color separations following the keylined pattern.

- Remove the tight comp from under the keylined pattern. Set it to the side where you can refer to it as you work.
- Tape the other three sides of the keylined pattern to the work table.
- Place a clean piece of tracing paper over the keylined pattern and tape it down securely so that it will not shift.
- Using the tight comp as reference, carefully outline all the elements that are to be printed in a single color. Label this piece of tracing paper with the color it represents, e.g. red stencil.
- Remove the first color separation and place another clean piece of tracing paper over the keylined pattern. Outline all the elements to be printed in the second color and label the tracing paper accordingly.
- Proceed in this manner until all the colors have been "separated".

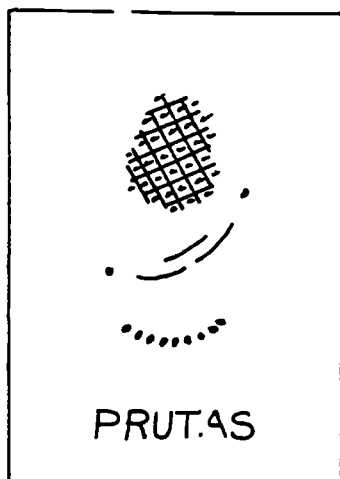

Black Stencil

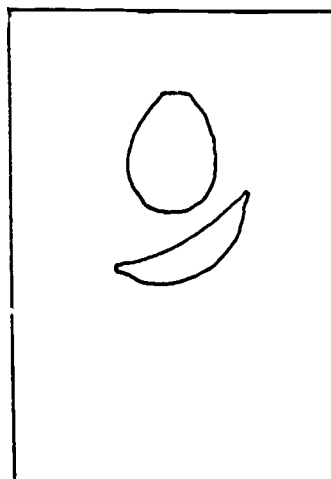

Yellow Stencil

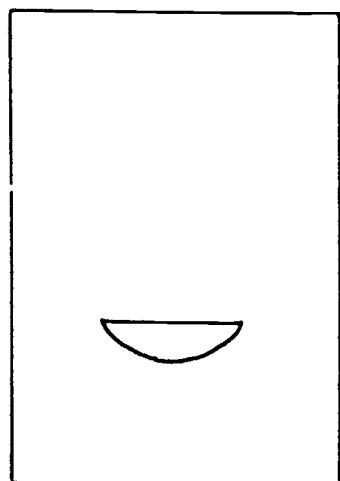

Red Stencil

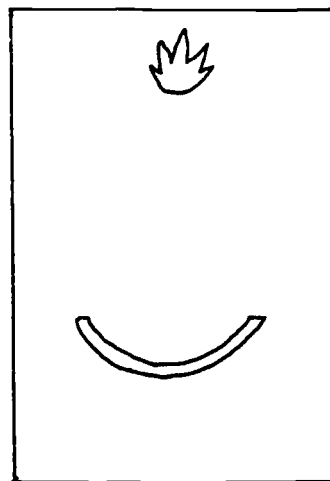

Green Stencil

NOTE: It is possible to print more than one color from a single stencil provided that those color areas are separated from one another by sufficient space to allow you to effectively block out one color area while you print the other. This can be done by taping a piece of plastic or heavy tracing paper to the bottom of the screen over the color area that is not to be printed. In such a case, the color separation should indicate the outlines of the two colors that will be printed from the single stencil.

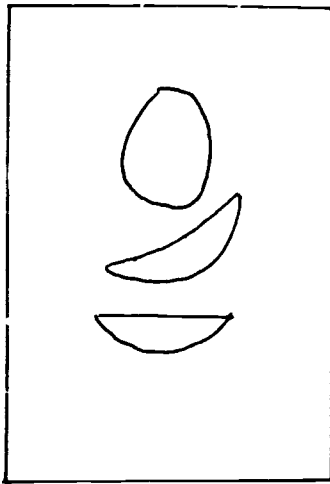

Red/Yellow
Stencil

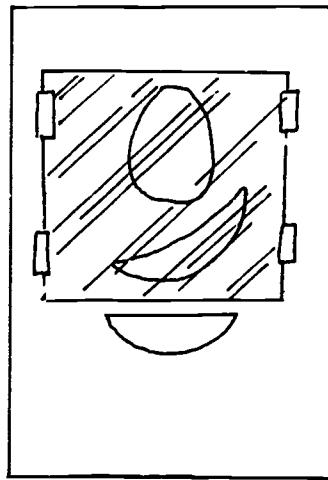

Block yellow/
Print red

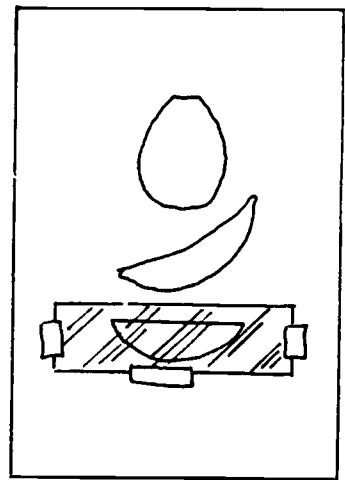

Block red/
Print yellow

E. CUTTING THE STENCIL

Blue film, the material from which silkscreen stencils are usually cut in the Philippines, isn't really blue at all, but grey. This translucent, lacquer-base film is supported by a light weight paper backing. When it is placed over the color separation on a light table or white background, the stencil cutter can easily see the keylines through the film.

The first-time stencil cutter needs to become familiar with the amount of pressure required to cut the film without going through the paper backing. Practice cutting on a small piece of film before tackling the actual stencil.

The steps in cutting a silkscreen stencil from blue film are as follows:

- 1) Tape color separation securely to work table. If the table is dark in color, place an opaque white backing between the table and the separation.
- 2) Cut a piece of blue film the size of the open area on your screen.
- 3) Center it, film side up, paper side down, over the color separation and tape securely to the table.
- 4) Using the point of an exacto knife with a #11 blade, carefully cut out each color area following the keylines on the color separation precisely.



REMEMBER: Don't press too hard. You want to avoid cutting through the paper backing. Be sure the entire outline has been cut cleanly and completely.

- 5) Use the edge of the knife blade to remove the film from those areas you want to print. This can be done by lifting an edge or corner of the film you want to remove just enough so that you can grab hold of the film with your fingers. Slowly peel the film away from the backing and discard.

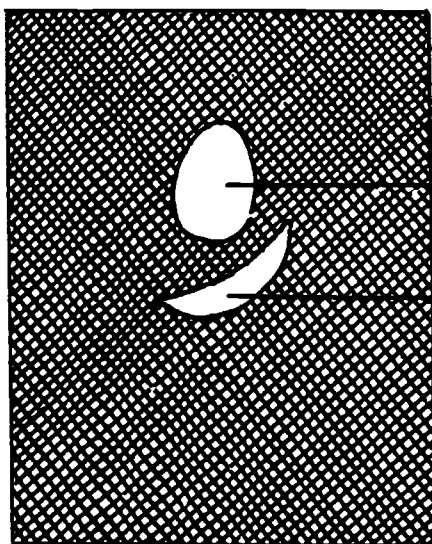

- 6) After the stencil has been completely cut and all unwanted film peeled away, remove the tape and detach the blue film stencil from the table. Cover the stencil with the paper color separation and roll, film side in, to protect the image. Set the cut stencil aside until you are ready to adhere it to the screen.
- 7) Repeat this procedure with a fresh piece of blue film for each color separation.

NOTE: It is not always necessary to cut the stencil on blue film. Simple shapes can be cut from any waterproof material such as heavy plastic or exposed x-ray film and taped to the underside of the screen. You can even use heavy weight tracing paper provided you are not going to make too many copies. A gestescript or any other hand or typewritten stencil may also be used. With the possible exception of the x-ray film, none of these stencils can be reused.

F. ADHERING THE STENCIL

Because blue film is a lacquer-base material, it is soluble in lacquer thinner. The secret to adhering the film to the silkscreen is in using just enough lacquer thinner to soften the film sufficiently so it will stick to the screen, yet not so much that the stencil dissolves altogether, destroying the image.

Blue film stencils, properly adhered to the screen, are reusable for multiple printings. Beginners should practice with a small piece of film in an empty corner of the screen.



NOTE: Lacquer thinner will remove nail polish. Wear rubber gloves to protect your manicure.

- 1) Set the silkscreen attached to its baseboard on the work table.
- 2) The stencil should be adhered to the bottom side of the screen. Lift the frame and position the stencil, film side up, on the baseboard. Some people find it easier to bond the stencil to the screen if there is a "cushion" of newspaper to work against. Try placing several layers of newsprint on the baseboard before positioning the stencil.
- 3) Now, lower the frame and adjust the stencil so that it appears in proper printing position on the screen.
- 4) Moisten a rag with lacquer thinner and, using firm pressure in small, circular motions, dampen the silk as you press it on to the stencil. Alternately press the dampened silk firmly on to the stencil with a dry cloth. Work on only a small area at a time, beginning in the center and slowly working outward until the complete screen has been dampened and pressed into the blue film. The whole stencil should adhere to the screen when the frame is lifted. Two or three persons can work at this task simultaneously.
- 5) Allow the screen to dry for a few minutes. Then, very gently, carefully, and slowly, peel the paper backing away from the bottom of the screen. If you should notice that the film is also pulling away from the screen, lower the frame again and use a little more lacquer thinner on the rag to readhere the stencil.
- 6) Once the stencil is adhered to the screen and the paper backing has been removed and discarded, check for any open areas between the outer edge of the stencil and the frame. Seal these with gloss varnish so that the ink will not be pushed through these spots when you print. You can also touch up the edges of the images, if necessary, with a small brush dipped in the gloss varnish. Clean the brush in lacquer thinner immediately after use.
- 7) Set the silkscreen aside with the frame propped open so

that the silk will dry thoroughly. The silkscreen cannot be used for printing unless the stencil is properly adhered and the screen is completely dry to the touch. Allow at least 30 to 45 minutes drying time.

- 8) Repeat this procedure, adhering each of your stencils to a different screen.

G. SILKSCREEN INKS & SOLVENTS

- 1) The secret to successful silkscreen printing is in knowing the compatibilities/incompatibilities of stencils, inks, and solvents.
 - The ink must not dissolve the stencil because the image will be destroyed.
 - The stencil must have a solvent or the screen will be useless for further printings.

GUIDELINE FOR STENCIL/INK/SOLVENT COMBINATIONS

	INK SOLVENT	PAPER STENCIL	WATER SOLUBLE STENCIL	LACQUER SOLUBLE STENCIL
WATER-BASE INK	water	limited # of copies	no	yes
OIL-BASE INK	turpentine	yes	yes	yes
STENCIL SOLVENT	-----	none needed	warm water	lacquer thinner

- 2) As noted in the above chart, there are two types of silk-screen ink: water-base ink and oil-base ink. Both types may be purchased commercially, however the most commonly used (and thus most widely available) commercial silkscreen ink in the Philippines is a water-base textile ink. This ink may be used on paper as well as textiles provided the paper stock is somewhat porous, i.e. has not been coated with a hard, slick finish. The type of inexpensive paper recommended for the visual aids workshop accepts this water-base textile ink without any problem.
- 3) If you prefer to make your own silkscreen ink, both oil-base and water-base inks may be homemade according to the following directions:

•RECIPE #1 (oil-base ink)

Thicken ordinary oil-base paint with wood-filler, talc, or powdered clay to a consistency halfway between heavy cream and pudding (or champarado without any lumps).

•RECIPE #2 (water-base ink)*

non-instant starch 120 ml. (½ cup)
 boiling water 350 ml. (1½ cups)
 soap flakes 120 ml. (½ cup)
 coloring (tempera paint powder, ink, or food coloring)

Mix starch with enough cold water to make a smooth paste. Add boiling water. Cool until glossy. Stir in soap flakes while mixture is still warm. After the mixture has cooled, add coloring.

RECIPE #3 (water-base ink)*

cornstarch 60 ml. (1/4 cup)
boiling water 460 ml. (2 cups)
soap flakes 30 ml. (1/4 cup)
coloring (tempera paint powder, ink, or food coloring)

Dissolve cornstarch in a small amount of cold water. Mix two or three tablespoons of boiling water, one spoonful at a time, into the cornstarch mixture. Stir well to get rid of all the lumps. Pour the cornstarch mixture very slowly into remaining boiling water, stirring constantly. When mixture boils, reduce heat and continue to stir until thickened. Add soap flakes while still warm. Cool and add coloring.

RECIPE #4 (water-base ink)*

cornstarch 120 ml. (1/2 cup)
gelatin (unflavored) 1 envelope or 15 ml.
soap flakes 120 ml. (1/2 cup)
water 700 ml. (3 cups)
coloring (tempera paint powder, ink, or food coloring)

Dissolve cornstarch in 170 ml. (3/4 cup) cold water. Dissolve gelatin in 60 ml (1/4 cup) cold water. Bring 460 ml. (2 cups) of water to a boil. Stirring constantly, slowly pour in cornstarch mixture followed by dissolved gelatin. When mixture begins to boil again, reduce heat and continue to stir until thickened. Cool mixture, then add soap flakes and coloring.

NOTE: One or two teaspoons of glycerine added to the water-base inks will make them smoother and easier to use. All four of these homemade inks will last for several months if stored in jars with tight-fitting lids.

- 4) Standard black mimeograph ink may also be used to print handwritten or drawn gestescript stencils or typewritten stencils. Standard mimeograph ink is an oil-base ink, soluble in turpentine.

*Adapted from Werner and Bower, Helping Health Workers Learn (1982) p. 16-13, after Village Technology Handbook (Mt. Rainier, Maryland: VITA), p. 373.

4) A word about color -

Bright, bold colors are most effective for visual aids and display posters. Try to avoid pastels and muted shades. Buy or mix RED, YELLOW, BLUE, GREEN, and BLACK. From these five colors you can also make ORANGE (from RED and YELLOW), PURPLE (from RED and BLUE), and BROWN (from RED and GREEN, or PURPLE and YELLOW).

H. PRINTING

Silkscreen printing and clean-up can be very messy procedures. Be sure that you wear old clothes or a large apron, smock, or lab coat that completely covers your garments.

Plan to print the black stencil first. This will make registration of the rest of the colors much easier.

The first color run:

- 1) Cover work table with brown paper or old newspaper.
- 2) Place silkscreen bearing black stencil on table with hinged end facing away from you.
- 3) Assemble your materials - ink, masking tape, squeegee, rags, and one or two small pieces of stiff cardboard (these can be cut from an old carton) or a couple of tongue depressors.
- 4) Stir the ink well with a stick and thin, if necessary, with a small amount of water (water-base ink) or turpentine (oil-base ink). The consistency of the ink should approximate that of a smooth chamorado, i.e. a thickness halfway between heavy cream and pudding.
- 5) Stack the paper on which you are going to print convenient to your work area but not so close to the screen and ink that it will get soiled.

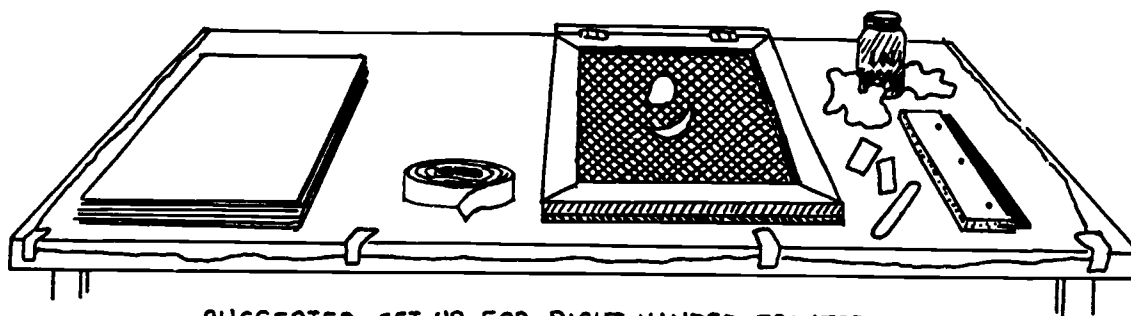

SUGGESTED SET-UP FOR RIGHT-HANDED PRINTER

- 6) Lift the silkscreen frame and position the first piece of paper on the screen baseboard.
- 7) Lower the frame, checking to make sure that the image is centered on the paper and that margins are equal. Adjust paper as necessary.

- 8) When paper is in position, raise screen and, without shifting the paper at all, place a cross of masking tape, 2 layers thick, flush with each of the two bottom corners of the paper.

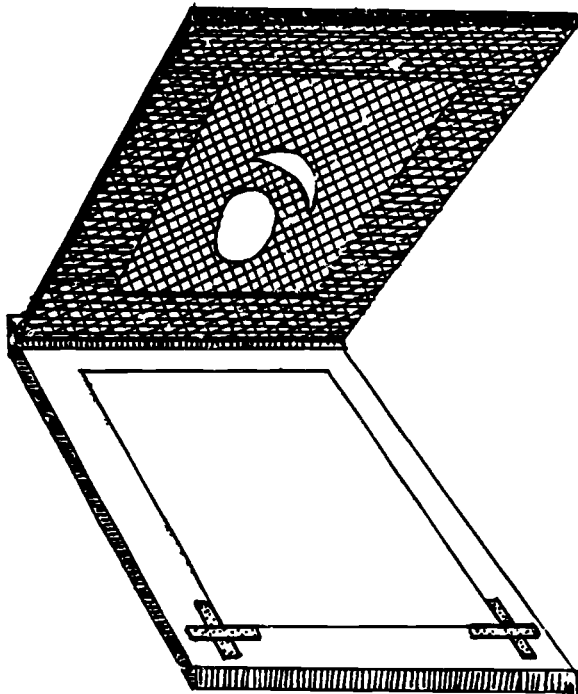

These masking tape guides will help you to position subsequent pieces of paper so that the image will be uniformly printed on all copies of your poster.

- 9) Now lower the frame once again and pool about $\frac{1}{2}$ cup of ink across the end of the screen furthest from you.

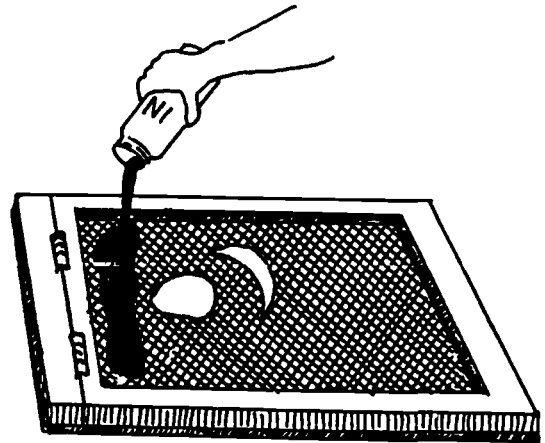

- 10) Hold the squeegee firmly with both hands and set it perpendicular to the screen between the edge of the frame and the pooled ink. In one firm, even motion, pull the squeegee toward you, spreading the ink across the screen and forcing it through the open areas of the stencil onto the paper below.

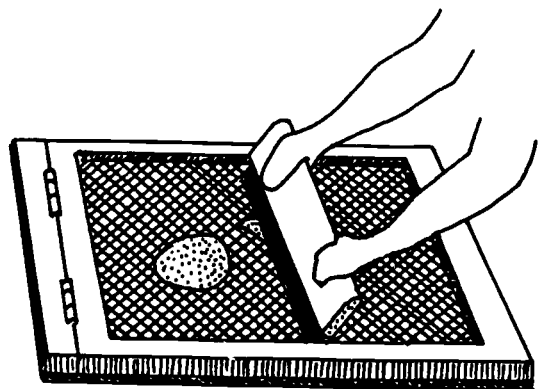

- 11) Carefully set the squeegee aside. Lift the frame and remove the printed paper. Lay the print flat in an out-of-the-way spot where it can dry.
- 12) Place a clean sheet of paper on the screen baseboard, positioning it flush against the masking tape crosses. Lower the screen.
- 13) Walk around to the other side of the table and use the squeegee to pull the ink back across the screen. Set the squeegee aside, lift the frame and remove the second print as you did the first.
- 14) Continue in this manner, adding more ink as needed, until you have printed the desired number of copies.

NOTE: Plan on printing 8 to 10 more copies than you actually need. These extra copies will serve as "proofs" when you are trying to register the second and subsequent color runs. You are also bound to have one or two mishaps - a few extra copies are insurance that there will be sufficient "good" prints to fill your needs.

- 15) When you have finished printing the first color, use a small piece of cardboard or a tongue depressor to scrape the excess ink off the squeegee back into the ink container. Scrape up and save the excess ink left on the screen. Cover the ink container tightly and store for future use.
- 16) Clean screen and squeegee thoroughly (see SILKSCREEN CLEAN-UP, pp. 200-201).

The second and subsequent color runs:

- 1) To print the second and subsequent color runs, set up your work space and materials as you did for the first color.
- 2) Be sure that prints are thoroughly dry before printing subsequent colors. Generally speaking, this should only take about thirty minutes for water-base inks.
- 3) Place the screen bearing the stencil for the next color you are going to print on the work table.
- 4) Lift frame and position one copy of the partially printed poster on the baseboard. Lower screen and adjust paper so that the area to be printed is in the proper relation to the previously printed color. This is called color registration. Use the tight comp (from SILKSCREEN ART PREPARATION, step 1, p. 186) as your reference.

- 5) When the paper is in position, lift frame carefully without moving the print.
- 6) Tape registration crosses to the baseboard flush against both bottom corners of the print as you did for the first color run (see above, step 8, p. 197). As before, this will make it easier to register the remaining copies. Do not, however, rely entirely on these registration guides. Visually check each print and make whatever adjustments are necessary to align the images before pulling the ink across the screen.
- 7) Follow the printing technique described in The First Color Run.

I. SILKSCREEN CLEAN-UP

Proper clean-up is one of the most important steps in the silkscreen process. A screen that is well taken care of may be reused again and again. Stencils may be removed and replaced several times before it becomes necessary to restretch the frame.

Washing the Screen: Water-Base Inks

- 1) As soon as you are through printing, scrape any excess ink off both the squeegee and the screen.
- 2) Remove pins from hinges and separate silkscreen frame from baseboard. Replace pins into baseboard hinges so they will not get lost. Set baseboard aside. It should not need to be cleaned.
- 3) Wash squeegee thoroughly under running water to remove all traces of ink. Shake off excess water and set it aside to dry.
- 4) Rinse screen well under running water.
- 5) Wet two large rough-textured rags and apply laundry soap.
- 6) Stand the frame on edge at a right angle to your body so that you can work on both sides of the screen at once.
- 7) Scrub the screen well between the two soaped rags to loosen and dissolve ink particles.

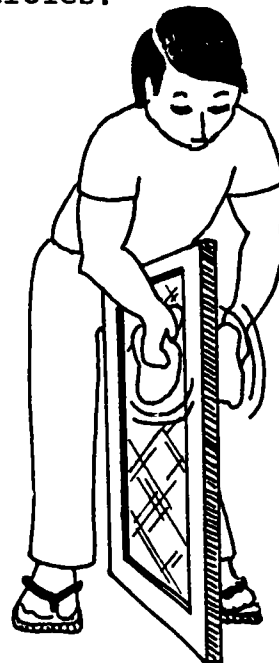

- 8) Rinse frequently under running water to wash away loosened ink particles. Frequent rinsing will also enable you to check your progress periodically.

- 9) Repeat scrubbing and rinsing until all traces of ink have been removed. The stencil should remain intact.
- 10) Allow screen to dry thoroughly before reattaching it to the baseboard.

Washing the Screen: Oil-Base Ink

- 1) As soon as you are through printing, scrape excess ink from both the squeegee and the screen.
- 2) Separate frame from baseboard. Set baseboard aside.
- 3) Thoroughly saturate a large rag with turpentine and clean squeegee. Wipe dry with a clean cloth.
- 4) Set frame, screen side down, on several thicknesses of newspaper.
- 5) Again, thoroughly saturate a large rag with turpentine and scrub screen well using firm pressure. As the newspaper becomes soiled with dissolved ink, discard the top few layers and repeat the scrubbing process. As the scrubbing rag becomes saturated with dissolved ink, discard it in favor of a clean one.
- 6) For stubborn areas, stand the frame on edge and use two rags soaked in turpentine to scrub both sides of the screen at once.
- 7) When all the ink has been removed, rinse screen well under running water. Scrub with soap and rinse again. A well-adhered stencil, being lacquer-base, should remain intact.
- 8) Allow screen to dry thoroughly before reattaching frame to baseboard.

Removing the Stencil

Stencils which have been taped to the screen should be removed and discarded before cleaning the ink from the screen. Blue film stencils are lacquer-base and therefore soluble only in lacquer thinner. A blue film stencil may be removed according to the following procedure.

- 1) Detach frame from baseboard. Set baseboard aside.
- 2) Set frame, screen side down, on several thicknesses of newspaper.
- 3) Thoroughly saturate a large rag with lacquer thinner and scrub screen well using firm pressure. As the newspaper and rag become soiled with the dissolved stencil, discard the top few layers of paper and exchange the soiled rag for a clean one.
- 4) For hard-to-remove spots, stand the frame on edge and use two rags soaked in lacquer thinner to scrub both sides of the screen at once.

- 5) Hold the screen up to the light to make sure that the mesh is clear and clean. You will still be able to see the stencil image because the individual fibers that make up the screen frequently become stained. This is not a problem so long as the mesh itself is not blocked.
- 6) After the stencil has been completely removed, wash the screen with soap and water. Allow screen to dry thoroughly before reattaching it to the baseboard.



REMEMBER: Nail polish is also soluble in lacquer thinner. Wear rubber gloves to protect your manicure.

20 Minutes

PROJECT #2: FINAL EVALUATION

Activity 7.1

PROCEDURE

A representative from each team will submit the visual aid/presentation script from Project #2, corrected as required by community pretest, so that all participants can make a note of the final result.

60 Minutes

PROJECT #3: CRITIQUE & DISCUSSION

Activity 7.2

PROCEDURE

- 1) Following the pattern set in Session 3 for Project #1 and Session 5 for Project #2, a representative from each team will present the team's ideas for Project #3. As before, presentations should not exceed 15 minutes.
 - Post visuals on the wall and give all workshop participants an opportunity to look at them.
 - Give a brief explanation of the problem, the target audience, the design rationale, and the proposed presentation strategy.
- 2) Encourage group discussion. Participants should ask questions and make suggestions for improving the design and method of presentation with respect to clarity, accuracy, sensitivity to local customs and traditions, and ability to stimulate maximum audience participation.
- 3) The other team members should take notes of the suggestions and comments as a reference toward modification of the design and presentation strategy.

20 Minutes

PROJECT #3: DESIGN MODIFICATION

Activity 7.3

PROCEDURE

Individual teams will work together to modify their designs and presentation strategies for Project #3.

15 Minutes REVIEW: POSTER DESIGN CONSIDERATIONS Activity 7.4

PROCEDURE

- 1) Facilitator will review the specific characteristics and design requirements of a display poster and relate them to the silkscreen process.

• Unlike the other visual educational aids that we have constructed during this workshop which are generally used in conjunction with lectures, demonstrations, discussions, etc., a display poster has to stand on its own. There is no opportunity for verbal support.

• A display poster has to be dynamic, colorful, and bold to attract attention because a display poster has to compete with many other stimuli in the immediate environment.

• A display poster must have a short, simple, direct message. Display posters do not usually command sustained attention. They have to get the message across in a matter of seconds. Thus, visual and verbal elements should reinforce one another to communicate a single, unified message with clarity and impact.

- 2) Ask a volunteer to copy the following information on the chalkboard.

DISPLAY POSTER

GRAPHICS

DYNAMIC
COLORFUL
BOLD

MESSAGE

SHORT
SIMPLE
DIRECT

- 3) Explain that the silkscreen process is ideally suited to the design requirements of a display poster. Although it is technically possible to reproduce complex, highly detailed images on the screen, we will use the cut stencil method which is suited for large, simple shapes and a brief message in bold type.
- 4) We will use no more than four, or at the most, five, colors. In the silkscreen process, each color is printed separately and requires a separate stencil. We will also use flat areas of color. The cut stencil method does not allow for shadings or color gradations.

- 5) Components should be separate, rather than overlapped or butted up against one another, to avoid potential registration problems.
- 6) Ask a second volunteer to write the following information on the chalkboard.

DISPLAY POSTER DESIGN

LARGE, SIMPLE SHAPES
BRIEF MESSAGE - BOLD TYPE
3 - 4 COLORS MAXIMUM
SEPARATE COMPONENTS

30 Minutes PROJECT #4: BRAINSTORMING & EVALUATION Activity 7.5

PROCEDURE

- 1) Participants will assemble into teams to brainstorm ideas for the display poster.
 - generate eight to ten concepts
 - refine, modify, and evaluate concepts with respect to the design requirements of a silkscreened display poster
- 2) Each team will select its best possible solution and prepare a rough sketch of their idea. Sketches should show color, scale, placement of components, etc. Headline/slogan should be simple, direct, and brief.

20 Minutes PROJECT #4: IDEA SELECTION Activity 7.6

PROCEDURE

- 1) A representative from each team will tape the team's idea sketch on the wall.
- 2) Participants will examine the sketches and discuss and evaluate the ideas in terms of the design and production requirements of a silkscreened display poster. They will consider the appropriateness of the suggested solutions to the public health message they are trying to communicate.
- 3) The group-at-large will select one of the ideas to be developed and printed on their poster. They may reach a consensus through either mutual agreement or by means of a formal vote.

PROCEDURE

1) Pretest Project #3

- Teams will report the time and place of their scheduled pretest for Project #3. Facilitator will make arrangements to attend.
- Facilitator will distribute evaluation forms to each team.
- Facilitator will remind teams to rehearse/role play their presentations prior to community pretest.
- Teams will carry out the pretest for Project #3 as scheduled.

2) Project #4 tight comp

- Distribute copies of A SILKSCREEN MANUAL to all participants and ask them to read it carefully.
- Following the directions in A SILKSCREEN MANUAL (Section D, p. 186), the tight comp will be drawn for the display poster.

PURPOSE

After reports of the Project #3 pretest have been presented, participants will prepare the silkscreens and artwork for printing the display poster.

OBJECTIVES

Participants will understand the educational value and design requirements of a display poster. They will be able to assemble a silkscreen, make color separations, and cut a stencil.

MATERIALS

Project #3: completed visual aid
 Project #3: presentation script
 Project #3: pretest evaluation form
 silkscreen frames
 silk, nylon, or dacron - fine mesh
 screwdriver (for removing pins from hinges)
 staples and stapler
 tape
 tracing paper
 black fine tip pens
 blue film
 exacto knives
 display poster tight comp (from Activity 7.7)

PREPARATION

- 1) Have silkscreen frames constructed and attached to backboards with pin hinges according to instructions contained in A SILKSCREEN MANUAL.
- 2) Set out all supplies necessary to assemble silkscreens.
- 3) Set out tracing paper and fine tip pens for color separations.
- 4) Set out blue film and exacto knives for stencil cutting demonstration.

ACTIVITY SEQUENCEEstimated Time

8.1	Project #3: Pretest Reports	30 minutes
8.2	Silkscreen Preparation	60
***	Merienda	10
8.3	Keyline Pattern & Color Separations	60
8.4	Homework Assignment: Stencil Cutting	20
		<u>180 minutes</u>

PROCEDURE :

- 1) Following the pattern set in Sessions 4 and 6 for Projects #1 and #2, a representative from each team will report to the group-at-large the results of the pretest for Project #3. Each report should be limited to no more than 5 minutes.
 - display visual aid for Project #3
 - briefly explain presentation strategy
 - use evaluation form for reference
 - describe facilitator's feelings before, during, and after presentation
 - describe observed audience reactions and response
 - discuss audience suggestions and comments
- 2) Workshop participants will offer comments and suggestions regarding modification of the visual aid and/or presentation strategy in response to the pretest report.

PROCEDURE

Participants will stretch the silk onto the silkscreen frames according to directions provided in A SILKSCREEN MANUAL (Section C, pp. 184-185).

- 1) Each team will be responsible for preparing one screen.
- 2) Facilitator will demonstrate and assist teams in this activity.
- 3) Workshop members familiar with the procedure should be encouraged to share their skills with their colleagues.

* * * * * TEN MINUTE MERIENDA * * * * *

60 Minutes KEYLINE PATTERN & COLOR SEPARATIONS Activity 8.3

PROCEDURE

- 1) Facilitator will follow instructions in A SILKSCREEN MANUAL (Section D, p. 186) to demonstrate keylining the poster pattern. Participants should be encouraged to assist.
- 2) Once the keyline pattern has been made, participants should take turns making the color separations according to the directions provided in the manual (Section D, pp. 187-188).

20 Minutes HOMEWORK ASSIGNMENT: STENCIL CUTTING Activity 8.4

PROCEDURE

- 1) Briefly review "Cutting the Stencil" (Section E, pp. 189-190 in A SILKSCREEN MANUAL) with participants.
- 2) Give each participant a small piece of blue film on which to practice cutting.
- 3) Distribute 1 color separation and 1 piece of blue film (approximately 22" x 30" in size) to each team. Each team will be responsible for preparing a stencil according to directions in A SILKSCREEN MANUAL prior to Session 9.
- 4) Don't forget to remind teams that they must also modify/revise Project #3 as indicated by the pretest.

PURPOSE

Project #3, corrected as indicated by the pretest, will be submitted for final evaluation. Stencils will be adhered to silkscreens and one or two color runs of the display poster will be printed.

OBJECTIVES

Participants will demonstrate their technical knowledge and mechanical skills by preparing silkscreens for printing. They will gain first-hand experience of the actual printing process.

Participants will also demonstrate their theoretical knowledge by completing a take-home examination (homework assignment).

MATERIALS

display poster/tight comp (from Activity 7.7)	silkscreens
keylined pattern & color separations (from Activity 8.3)	silkscreen ink
cut stencils (from Activity 8.4)	squeegee
exacto knives	masking tape
gloss varnish & brush	poster paper
lacquer thinner	newsprint or brown paper
rags	take-home examination (handout 9.5.1, pp.211-212)
<u>A SILKSCREEN MANUAL</u> (handout 7.7.1)	action plan (handout 9.5.2, pp. 213-214)

PREPARATION

- 1) Reproduce sufficient numbers of the action plan and the take-home examination for all participants to have a copy of each.
- 2) Cover work tables with newsprint or brown paper.
- 3) Assemble materials for adhering stencils to the screens.
- 4) Assemble materials for printing.

ACTIVITY SEQUENCE

	<u>Estimated Time</u>
9.1 Project #3: Final Evaluation	20 minutes
9.2 Project #4: Adhering the Stencil	60
*** Merienda	10
9.3 Printing the Poster	60
9.4 Clean-up	20
9.5 Homework Assignment: Workshop Evaluation	<u>10</u>
	180 minutes

TRUE/FALSE

- 1) Puppet show presentations are appropriate only for small children.
- 2) A flip chart would be a good way to present alternative methods of water purification.
- 3) Appropriate treatment of diseases and injuries is more important to primary health care than a comprehensive health education program.
- 4) Sequence posters can be used to describe events occurring in a specific order.
- 5) Health education is a serious business. We should not trivialize our message with humor.
- 6) Methods of toilet construction can best be taught by using comparative posters.
- 7) A learning game is one way to stimulate maximum audience participation.
- 8) Visual aids can be constructed from low-cost, locally available materials.
- 9) Health educators should deliver their message in an authoritative manner so that people will do as they are told.
- 10) Comic books can be produced inexpensively with a mimeograph machine.
- 11) Taking an active part in one's own learning activities stimulates self-reliance in other areas of one's life as well.
- 12) A health educator should help people explore alternatives, make choices, and accept responsibility for their decisions.

PLEASE ANSWER THE FOLLOWING QUESTIONS.

- 13) Define "visual educational aid".

- 14) What are the design requirements of an effective visual aid?

- 15) List the twelve steps in the design process.
- 16) Describe how to pretest a visual aid with a sample audience.

FILL IN THE BLANK SPACES IN EACH STATEMENT BY SELECTING A WORD FROM THE FOLLOWING LIST. NO WORD MAY BE USED MORE THAN ONCE. THERE ARE MORE WORDS THAN SPACES.

evaluation	complicated	brainstorming	brief
participating	lecturing	sensitive	direct
dynamic	understandable	demonstration	sering
innovative	colorful	stimulate	bold
appropriate	listening	accurate	easy

- 17) A good way to generate alternative solutions to a problem is by _____.
- 18) We learn the most by _____.
- 19) A truly effective visual aid and presentation strategy can be developed only by frequent _____.
- 20) A display poster should be _____, _____, and _____.
- 21) A good visual aid is _____ for the situation and the target audience.
- 22) Every health education message should be _____, _____, and _____.
- 23) Visual aids should be _____ to the customs and traditions of the target audience.
- 24) The most effective educational strategies attempt to _____ maximum audience participation.

THERE IS NO NEED TO SIGN THIS EXAMINATION.
PLEASE BRING IT WITH YOU TO SESSION 10.

Submitted by _____ Date _____

I. AREA OF CONCERN: Application of knowledge and skills

A. OBJECTIVE

Develop and use a wide variety of visual aids to assess community needs, stimulate interest, and promote self-reliance on the village level by encouraging maximum audience participation in health, nutrition, and sanitation presentations.

B. TOPIC FOCUS

C. TARGET GROUP/S

D. STRATEGIES

E. RESOURCES (please be specific)

F. METHOD OF EVALUATION

II. AREA OF CONCERN: Transfer of technology

A. OBJECTIVE

Train primary health care workers in the construction and use of visual aids and participatory teaching strategies.

B. TARGET GROUP

C. STRATEGIES

D. RESOURCES (please be specific)

E. PROPOSED TIME SCHEDULE

F. METHOD OF EVALUATION

20 Minutes

PROJECT #3: FINAL EVALUATION

Activity 9.1

PROCEDURE

A representative from each team will submit the visual aid/presentation script from Project #3, corrected as required by community pretest, so that all participants can make a note of the final result.

60 Minutes

PROJECT #4: ADHERING THE STENCIL

Activity 9.2

PROCEDURE

Facilitator and participants will work together to adhere cut stencils to the screens with lacquer thinner as described in A SILKSCREEN MANUAL (Section F, pp. 191-192).

* * * * * TEN MINUTE MERIENDA * * * * *

60 Minutes

PRINTING THE POSTER

Activity 9.3

PROCEDURE

- 1) Facilitator will demonstrate the silkscreen printing process according to directions provided in A SILKSCREEN MANUAL (Section H, pp. 196-199).
 - registering the paper
 - pooling the ink
 - pulling the print
- 2) Participants will take turns printing the first color run.
- 3) Facilitator will demonstrate registration of the second color and will pull the first print.
 - Half the participants will take turns printing the remainder of the second color run.

•The rest will observe as facilitator demonstrates screen clean-up techniques with the first screen (A SILKSCREEN MANUAL, Section I, pp. 200-201).

20 Minutes

CLEAN-UP

Activity 9.4

PROCEDURE

- 1) Ask a volunteer who observed the washing of the first screen to demonstrate the clean-up technique to those participants who were printing the second color run.
- 2) The participants who already observed a clean-up demonstration should put the ink away, remove the paper from the work tables, and gather up the partially printed posters for storage until the next session.

10 Minutes HOMEWORK ASSIGNMENT: WORKSHOP EVALUATION Activity 9.5

PROCEDURE

- 1) Distribute a copy of the take-home examination to each participant. Tell them that they may use their notes but that they are to work independently. Explain that the purpose of the exam is to evaluate how well the educational message was transmitted - not to find out who knows what. It is not necessary to sign the examination sheet.
- 2) Distribute an action plan form to each participant. Ask workshop members to indicate how they plan to use their newly acquired skills in the community. Ask them to propose a concrete plan for transferring their technical knowledge to other members of the primary health care team.
- 3) Ask participants to write an honest evaluation of the workshop activities. Evaluations should not be signed to ensure that each person will feel free to express him/herself candidly. The following questions should be addressed:
 - Was the workshop a valid educational experience for me?
 - Will it help me become a more effective health educator?
 - What skills did I acquire during the course of the workshop?
 - How could the subject matter/presentation strategy of the workshop be improved?

- What were the principle strengths and weaknesses of the workshop?
- How effectively did the facilitator fulfill his/her role?
- Any other additional comments.

- 4) It may be necessary to print additional color runs on the poster before the final session. Chances are that you will only have time to print one color during Session 10. Recruit two or three volunteers to help you print all but the last color on the display poster so that you will not be pressed for time during the final session of the workshop.

PURPOSE

Printing of the display poster will be completed. Take-home examinations will be corrected and handed in the facilitator. Completed action plans and individual workshop evaluations will be given to facilitator. Completed posters and excess paper supplies will be distributed to teams. Certificates of completion will be awarded.

OBJECTIVES

Participants will complete the final silkscreen project for distribution to local RHUs. Educational effectiveness of workshop activities will be able to be evaluated by means of the completed projects and community presentations, results of individual take-home examinations, and anonymous written evaluations submitted by participants. Workshop members will commit themselves to using their newly acquired skills in the community and to transferring their technical knowledge to other members of the primary health care team by filling out the action plan and filing it with the Integrated Provincial Health Office.

MATERIALS

newsprint or brown paper	rags
masking tape	completed take-home examinations
silkscreens	(from Activity 9.5)
silkscreen ink	action plans (from Activity 9.5)
squeegee	workshop evaluations
partially printed posters	(from Activity 9.5)
soap/water/solvents	certificates of completion (p. 219)

PREPARATION

- 1) Make out a certificate of completion for each participant
- 2) Cover work tables with newsprint or brown paper
- 3) Assemble materials for printing and clean-up

ACTIVITY SEQUENCE

	<u>Estimated Time</u>
10.1 Project #4 Completion	120 minutes
10.2 Clean-up	20
**** Merienda	10
10.3 Take-Home Examination: Review & Correction	15
10.4 Wind-up Activities	<u>15</u>
	180 minutes

Make a copy of the certificate for each workshop participant. Trim to 8½" x 5½" as indicated. Fill in participant's name, the name of the sponsoring agency, workshop location, and dates. Have certificates signed by the appropriate authorities.

Certificate of Completion

awarded to

for the successful completion of

THE VISUAL AIDS WORKSHOP

held at _____

from _____ to _____

(signed - name & title)

(signed - name & title)

120 Minutes

PROJECT #4 COMPLETION

Activity 10.1

PROCEDURE

Participants will continue as they began in Session 9 to complete printing the display poster. Facilitator will assist as required.

20 Minutes

CLEAN-UP

Activity 10.2

PROCEDURE

Facilitator will ask for volunteers to wash the screens used in Session 10. The rest of the participants will put the ink away, remove the paper from the work tables, and gather up the completed posters as soon as they are dry.

* * * * * TEN MINUTE MERIENDA * * * * *

15 Minutes

TAKE-HOME EXAM: REVIEW & CORRECTION

Activity 10.3

PROCEDURE

- 1) Participants should correct their own examinations.
- 2) Read each question and ask a volunteer to give his/her answer. Ask other participants if they agree and why or why not. Explain each answer to the participants so that there will be no doubt that everyone understands.

TAKE-HOME EXAMINATION KEY

- 1) Puppet show presentations are appropriate only for small children.

FALSE. Puppet shows are an excellent way to present familiar messages in a fresh, frequently humorous fashion to audiences of all ages. Sending an educational message through the mouths of puppets also enables the health educator to discuss sensitive issues or to employ a common vernacular which may be clearly understood by the audience. Puppets can get away with saying things that might otherwise be inappropriate.

- 2) A flip chart would be a good way to present alternative methods of water purification.

TRUE. A flip chart is the ideal visual aid to supplement a lecture/discussion about alternative methods of doing something or separate-but-equal factors influencing a given situation. A flip chart presents visual images one at a time, thereby focusing full audience attention on each alternative or factor being discussed.

- 3) Appropriate treatment of diseases and injuries is more important to primary health care than a comprehensive health education program.

FALSE. According to the World Health Organization, health education is the first of eight essential elements necessary for a successful primary health care program. Appropriate treatment of diseases and injuries is ranked seventh after food and nutrition, safe water, maternal and child health, immunization, and disease prevention and control. Distribution of essential medicines and drugs is ranked eighth.

- 4) Sequence posters can be used to describe events occurring in a specific order.

TRUE. Sequence posters are the most effective way of presenting information about events that take place in a pre-determined order. The use of sequence posters allows the health educator to present the steps one at a time as well as to display all the steps in order so that the audience can see the relationship of one step or event to the next. Sequence posters can also be used to check audience understanding and evaluate the educational effectiveness of a health message by asking volunteers from the audience to place the posters in their proper sequence.

- 5) Health education is a serious business. We should not trivialize our message with humor.

FALSE. Health education is a serious business. As health educators, we need to get our message across in whatever way we can. Humor is frequently a very effective device

because it usually sets people at ease and allows them to learn in a relaxed, friendly, positive environment.

- 6) Methods of toilet construction can best be taught by using comparative posters.

FALSE. Toilet construction is a sequential series of events. A discussion about toilet construction would thus be best supported by sequence posters or a flip chart. Comparative posters are, by definition, most effective when dealing with oppositions, e.g. factors supporting good health contrasted with those that contribute to disease, or a healthy, safe environment contrasted to dirty, unsafe surroundings.

- 7) A learning game is one way to stimulate maximum audience participation.

TRUE. Learning games are an excellent way to actively involve all the members of an audience. The health educator should plan these activities thoughtfully with respect to the number of people taking part. Card games and board games are usually most effective with a limited number of participants. Team activities and action games can often involve larger groups.

- 8) Visual aids can be constructed from low-cost, locally available materials.

TRUE. Effective visual aids do not have to be expensive. Box board and brown paper are perfectly adequate for posters and illustrations. Felt pens, crayons, and poster paint can provide color. Many visual aids can be constructed using "found" objects such as sticks, stones, coconut shells, fabric scraps, tongue depressors, paper and plastic bags, magazine pictures, etc. You just have to use your imagination and be willing to experiment.

- 9) Health educators should deliver their message in an authoritative manner so that people will do as they are told.

FALSE. In the words of Dr. Halfdan Mahler, Director-General of the World Health Organization: "Health educators should see to it that they put an abrupt end to that type of health education which was concerned with telling people how to act ...No longer today should health workers act as minor deities, expecting mortals to behave in certain predetermined ways... the primary role of health education is to promote individual and social awareness, leading to people's involvement and self-reliance." (Mahler, "Health for All - Everyone's Concern", World Health, April/May 1983.)

- 10) Comic books can be produced inexpensively with a mimeograph machine.

TRUE. Although color is nice, it is not necessary. A well-developed storyline with an element of suspense and a strong ending, clearly drawn pictures, and legible script are the

most important elements for a successful comic. Pictures and script can be drawn directly on to a Gestescript stencil and run off in quantity on a mimeograph machine. If there is no mimeograph machine available, the stencil can be taped to a silkscreen and reproduced in that manner.

- 11) Taking an active part in one's own learning activities stimulates self-reliance in other areas of one's life as well.

TRUE. The traditional pattern of authoritative teacher/passive student places the student in an inferior position. Encouraging students to take responsibility for their own learning is a gesture of respect that builds self-confidence and self-esteem as the student learns to make decisions and accomplish tasks through his/her own efforts.

- 12) A health educator should help people explore alternatives, make choices, and accept responsibility for their decisions.

TRUE. To quote again from Dr. Mahler: "Health education needs to provide the individual with knowledge about alternative types of behavior and their outcomes, so that she or he can be in a position to make choices and accept their consequences." (Ibid.)

PLEASE ANSWER THE FOLLOWING QUESTIONS.

- 13) Define "visual educational aid".

A visual educational aid is any item which can be seen by the audience and which supports and supplements the verbal presentation by concretizing and clarifying the educational message. Visual aids can also reinforce the educational message by encouraging and stimulating audience participation.

- 14) What are the design requirements of an effective visual aid?

An effective visual aid is:

- simple (in terms of both concept and design)
- direct
- accurate
- easily understood
- easy to use
- sensitive to local customs and traditions
- colorful (to attract and hold attention)
- appropriate (in terms of subject, occasion, and audience)
- stimulating (to encourage maximum audience participation)
- cost effective

- 15) List the twelve steps in the design process.

- analyze and define the problem
- identify the target audience
- compose a single-item message

- brainstorm concepts
- evaluate and select
- develop idea
- share idea - ask for feedback
- modify design/concept
- complete finished artwork
- test with sample audience
- observe audience response - ask for audience response
- modify as required

16) Describe how to pretest a visual aid with a sample audience.

- Introduce the activity: Introduce yourself to the audience. Explain that you are trying out some new material that you are developing in a workshop. Tell the audience that you would like to have their honest response to the visual aids and presentation strategy that you will be using.
- Carry out the activity: Have someone observe and take notes on the presentation technique and audience reaction.
- Evaluate the activity: Ask the audience for suggestions and comments on the visual material and presentation technique. Ask open-ended questions that require an opinion, an explanation, or a description of feelings. Avoid questions that can be answered YES or NO.

FILL IN THE BLANK SPACES IN EACH STATEMENT BY SELECTING A WORD FROM THE FOLLOWING LIST. NO WORD MAY BE USED MORE THAN ONCE. THERE ARE MORE WORDS THAN SPACES.

evaluation	complicated	brainstorming	brief
participating	lecturing	sensitive	direct
dynamic	understandable	demonstration	seeing
innovative	colorful	stimulate	bold
appropriate	listening	accurate	easy

- 17) A good way to generate alternative solutions to a problem is by brainstorming.
- 18) We learn the most by participating.
- 19) A truly effective visual aid and presentation strategy can be developed only by frequent evaluation.
- 20) A display poster should be dynamic, bold, and colorful.
- 21) A good visual aid is appropriate for the situation and the target audience.
- 22) Every health education message should be direct, accurate, and understandable.
- 23) Visual aids should be sensitive to the customs and traditions of the target audience.
- 24) The most effective educational strategies attempt to stimulate maximum audience participation.

PROCEDURE

- 1) Collect corrected take-home examinations. Explain to participants that this is a way for you to evaluate the educational effectiveness of the workshop. In other words, it is an evaluation of the facilitator's ability to get a message across. The examination need not be signed.
- 2) Collect participants' unsigned written evaluations of the workshop.
- 3) Collect action plans. Be sure that these forms have been signed.
- 4) Distribute any excess paper supplies (if this was in your original workshop plan).
- 5) Distribute completed posters amongst workshop participants to be delivered to local RHUs.
- 6) Award certificates of completion.

The Visual Aids Workshop is over. Participants have been awarded their certificates of completion. Local rural health units have a brand new health poster to display. There are still, however, a couple of things the facilitator needs to do.

PROCEDURE

- 1) Check the answers submitted on the take-home examinations to see if the majority of participants understood the material presented in the workshop. If there are one or more items that most people missed on the examination, you will probably want to give that issue greater emphasis in subsequent seminars. Make a note.
- 2) Read the anonymous workshop evaluations carefully. Make a note of the comments and suggestions offered by participants. Adjust the curriculum accordingly, provided that the suggestions are consistent with the seminar objectives.
- 3) Submit the completed action plans to the appropriate official in the Integrated Provincial Health Office.
- 4) Congratulate yourself on a job well done.

Since 1961 when the Peace Corps was created, more than 80,000 U.S. citizens have served as Volunteers in developing countries, living and working among the people of the Third World as colleagues and co-workers. Today 6000 PCVs are involved in programs designed to help strengthen local capacity to address such fundamental concerns as food production, water supply, energy development, nutrition and health education and reforestation.

Peace Corps overseas offices:

BELIZE
P.O. Box 487
Belize City

BENIN
BP 971
Cotonou

BOTSWANA
P.O. Box 93
Gaborone

BURKINA FASO
BP 537
Ouagadougou

BURUNDI
BP 1720
Bujumbura

CAMEROON
BP 817
Yaounde

CENTRAL AFRICAN
REPUBLIC
BP 1080
Bangui

COSTA RICA
Apartado Postal
1266
San Jose

DOMINICAN REPUBLIC
Apartado Postal
1412
Santo Domingo

EASTERN CARIBBEAN
Including: Antigua,
Barbados, Grenada,
Montserrat, St.
Kitts-Nevis, St.
Lucia, St. Vincent,
and Dominica
Peace Corps
P.O. Box 696-C
Bridgetown, Barbados
West Indies

ECUADOR
Casilla 635-A
Quito

FIJI
P.O. Box 1094
Suva

GABON
BP 2098
Libreville

GAMBIA, The
P.O. Box 582
Banjul

GHANA
P.O. Box 5796
Accra (North)

GUATEMALA
6 ta. Avenida
1-46 Zone 2
Guatemala City

HAITI
c/o American
Embassy
Port-au-Prince

HONDURAS
Apartado Postal
C-51
Tegucigalpa

JAMAICA
9 Musgrave Avenue
Kingston 10

KENYA
P.O. Box 30518
Nairobi

LESOTHO
P.O. Box 554
Maseru

LIBERIA
Box 707
Monrovia

MALAWI
Box 208
Lilongwe

MALI
BP 85
Bamako

MAURITANIA
BP 222
Nouakchott

MICRONESIA
P.O. Box 9
Kolonja Pohnpei
F.S.M. 96941

MOROCCO
1, Zanquat
Benzerte
Rabat

NEPAL
P.O. Box 613
Kathmandu

NIGER
BP 10537
Niamey

PAPUA NEW GUINEA
P.O. Box 1790
Boroko
Port Moresby

PARAGUAY
c/o American
Embassy
Asuncion

PHILIPPINES
P.O. Box 7013
Manila 3120

RWANDA
BP 28
Kigali

SENEGAL
BP 2554
Dakar

SEYCHELLES
Box 564
Victoria MAHE

SIERRA LEONE
Private Mail Bag
Freetown

SOLOMON ISLANDS
P.O. Box 547
Honiara

SRI LANKA
50/5 Siripa Road
Colombo 5

SWAZILAND
P.O. Box 362
Mbabane

TANZANIA
Box 9123
Dar es Salaam

THAILAND
242 Rajvithi Road
Amphur Dusit
Bangkok 10300

TOGO
BP 3194
Lome

TONGA
BP 147
Nuku'Alofa

TUNISIA
BP 96
1002 Tunis
Belvedere
Tunis

WESTERN SAMOA
Private Mail Bag
Apia

YEMEN
P.O. Box 1151
Sana'a

ZAIRE
BP 697
Kinshasa